

**NAVAIR 00-80T-104**



# **NATOPS LANDING SIGNAL OFFICER MANUAL**

**THIS PUBLICATION SUPERSEDES NAVAIR 00-80T-104  
DATED 1 NOVEMBER 1997 AND CHANGED 15 AUGUST 1998.**

DISTRIBUTION STATEMENT C — Distribution authorized to U.S. Government Agencies and their contractors to protect publications required for official use or for administrative or operational purposes only determined on 1 May 1992. Other requests for this document shall be referred to Commanding Officer, Naval Air Technical Data and Engineering Service Command, Naval Air Station, North Island, P.O. Box 357031, Building 90, Distribution, San Diego, CA 92135-7031.

DESTRUCTION NOTICE — For unclassified, limited documents, destroy by any method that will prevent disclosure of contents or reconstruction of the document.

ISSUED BY AUTHORITY OF THE CHIEF OF NAVAL OPERATIONS AND  
UNDER THE DIRECTION OF THE COMMANDER,  
NAVAL AIR SYSTEMS COMMAND.

**THE LANDING  
SIGNAL OFFICER**

**THE LSO  
WORKSTATION**

**NORMAL  
PROCEDURES**

**EMERGENCY  
PROCEDURES**

**EXTREME WEATHER  
CONDITION OPERATIONS**

**COMMUNICATIONS**

**NATOPS EVAL, PILOT  
PERFORMANCE RECS,  
A/C MISHAP STATEMENTS**

**INDEX**





DEPARTMENT OF THE NAVY  
OFFICE OF THE CHIEF OF NAVAL OPERATIONS  
2000 NAVY PENTAGON  
WASHINGTON, D.C. 20350-2000

NAVAIR 00-80T-104

15 December 2001

LETTER OF PROMULGATION

1. The Naval Air Training and Operating Procedures Standardization (NATOPS) Program is a positive approach toward improving combat readiness and achieving a substantial reduction in the aircraft mishap rate. Standardization, based on professional knowledge and experience, provides the basis for development of an efficient and sound operational procedure. The standardization program is not planned to stifle individual initiative, but rather to aid the commanding officer in increasing the unit's combat potential without reducing command prestige or responsibility.
2. This manual standardizes ground and flight procedures but does not include tactical doctrine. Compliance with the stipulated manual requirements and procedures is mandatory except as authorized herein. In order to remain effective, NATOPS must be dynamic and stimulate rather than suppress individual thinking. Since aviation is a continuing, progressive profession, it is both desirable and necessary that new ideas and new techniques be expeditiously evaluated and incorporated if proven to be sound. To this end, commanding officers of aviation units are authorized to modify procedures contained herein, in accordance with the waiver provisions established by OPNAVINST 3710.7, for the purpose of assessing new ideas prior to initiating recommendations for permanent changes. This manual is prepared and kept current by the users in order to achieve maximum readiness and safety in the most efficient and economical manner. Should conflict exist between the training and operating procedures found in this manual and those found in other publications, this manual will govern.
3. Checklists and other pertinent extracts from this publication necessary to normal operations and training should be made and carried for use in naval aircraft.

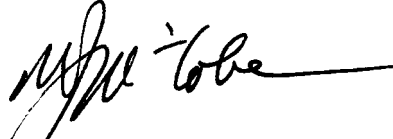

M.J. McCABE  
Rear Admiral, U.S. Navy  
Director, Air Warfare



<table border="1" style="margin-left: auto; margin-right: auto;"> <tr> <td style="text-align: center;"> <table border="1" style="margin-left: auto; margin-right: auto;"> <tr> <td style="text-align: center;"><b>INTERIM CHANGE SUMMARY</b></td> </tr> </table> </td> </tr> </table>	<table border="1" style="margin-left: auto; margin-right: auto;"> <tr> <td style="text-align: center;"><b>INTERIM CHANGE SUMMARY</b></td> </tr> </table>	<b>INTERIM CHANGE SUMMARY</b>
<table border="1" style="margin-left: auto; margin-right: auto;"> <tr> <td style="text-align: center;"><b>INTERIM CHANGE SUMMARY</b></td> </tr> </table>	<b>INTERIM CHANGE SUMMARY</b>	
<b>INTERIM CHANGE SUMMARY</b>		

The following Interim Changes have been cancelled or previously incorporated into this manual.

INTERIM CHANGE NUMBER(S)	REMARKS/PURPOSE
1 thru 10	Previously incorporated.

The following Interim Changes have been incorporated into this Change/Revision.

INTERIM CHANGE NUMBER(S)	REMARKS/PURPOSE

Interim Changes Outstanding — To be maintained by the custodian of this manual.

INTERIM CHANGE NUMBER	ORIGINATOR/DATE (or DATE/TIME GROUP)	PAGES AFFECTED	REMARKS/PURPOSE



# SUMMARY OF APPLICABLE TECHNICAL DIRECTIVES

Information relating to the following recent technical directives has been incorporated into this manual.

CHANGE NUMBER	DESCRIPTION	DATE INC. IN MANUAL	VISUAL IDENTIFICATION

Information relating to the following applicable technical directives will be incorporated in a future change.

CHANGE NUMBER	DESCRIPTION	DATE INC. IN MANUAL	VISUAL IDENTIFICATION









# NATOPS Landing Signal Officer Manual

## CONTENTS

*Page  
No.*

### PART I — THE LANDING SIGNAL OFFICER

#### CHAPTER 1 — INTRODUCTION

1.1	GENERAL .....	1-1
1.2	ROLE OF LANDING SIGNAL OFFICER .....	1-1
1.3	COMMAND RELATIONSHIPS AND RESPONSIBILITIES OF THE LANDING SIGNAL OFFICER .....	1-1
1.3.1	Type Commander .....	1-1
1.3.2	LSO Training Model Manager .....	1-2
1.3.3	Ship/Air Wing Commanding Officer .....	1-2
1.3.4	Air Wing Commander .....	1-2
1.3.5	Squadron Commanding Officer .....	1-2
1.4	LSO DESIGNATIONS .....	1-3
1.4.1	LSO Designation Category .....	1-3
1.4.2	LSO Trainee Nomination Procedures .....	1-3
1.4.3	Upgrading Procedures .....	1-3
1.5	LSO SENIORITY .....	1-3
1.6	ASSIGNMENT .....	1-4
1.7	FLIGHT DECK HAZARDOUS DUTY INCENTIVE PAY (FDHIDP) .....	1-4

#### CHAPTER 2 — INDOCTRINATION

2.1	SELECTION OF LSO TRAINEES .....	2-1
2.2	LSO TRAINING PROGRAM .....	2-1
2.2.1	Formal Ground Training .....	2-1
2.2.2	Field Training .....	2-1
2.2.3	Shipboard Training .....	2-1
2.2.4	Aircraft Crosstype Training .....	2-1
2.3	REQUIREMENTS FOR LSO DESIGNATION .....	2-2
2.4	MINIMUM CURRENCY REQUIREMENTS .....	2-2

2.5	FACTORS AFFECTING LSO READINESS .....	2-2
2.6	TRAINING LSO CARRIER QUALIFICATION (CQ) REQUIREMENTS .....	2-2
2.7	LSO TRAINER (DEVICE 2H111) .....	2-2

**PART II — THE LSO WORKSTATION**

**CHAPTER 3 — SHORE-BASED WORKSTATION**

3.1	GENERAL .....	3-1
3.2	MINIMUM EQUIPMENT FOR FIELD CARRIER LANDING PRACTICE (FCLP) OPERATIONS .....	3-1
3.2.1	Day FCLP .....	3-1
3.2.2	Night FCLP .....	3-1
3.3	VISUAL LANDING AIDS .....	3-1
3.3.1	General .....	3-1
3.3.2	Mk 8 Fresnel Lens .....	3-2
3.3.3	MOVLAS .....	3-2
3.3.4	Operation and Checks of Shore-Based Visual Landing Aids .....	3-2
3.4	LSO GREENHOUSE AND RADIOS .....	3-2
3.5	LSO VEHICLE .....	3-2

**CHAPTER 4 — SHIPBOARD WORKSTATION**

4.1	MINIMUM EQUIPMENT LIST FOR SHIPBOARD OPERATIONS .....	4-1
4.1.1	Day Carrier .....	4-1
4.1.2	Night Carrier .....	4-2
4.1.3	Miscellaneous LSO Equipment Malfunction .....	4-2
4.2	FRESNEL LENS OPTICAL LANDING SYSTEM .....	4-2
4.2.1	Optical Characteristics .....	4-2
4.2.2	General Operating Intensities .....	4-3
4.2.3	System Condition Indicators .....	4-4
4.2.4	Datum, Waveoff, and Cut Lights .....	4-4
4.2.5	Stabilization Modes .....	4-5
4.2.6	Effects of Deck Motion .....	4-7
4.2.7	Effective Glideslope Due to Wind and Deck Motion .....	4-7
4.2.8	Roll Angle and Hook-to-Eye .....	4-8
4.3	MANUALLY OPERATED VISUAL LANDING AID SYSTEM .....	4-10
4.3.1	MOVLAS Construction .....	4-12

4.4	LSO HEADS-UP DISPLAY .....	4-12
4.5	LSO BASE CONSOLE .....	4-12

**PART III — NORMAL PROCEDURES**

**CHAPTER 5 — SHORE-BASED PROCEDURES**

5.1	BRIEFING AND DEBRIEFING .....	5-1
5.1.1	Precarrier Briefing .....	5-1
5.1.2	Simulator Procedures Briefing .....	5-2
5.1.3	Conduct of Field Carrier Landing Practice Briefings .....	5-3
5.1.4	Postsimulator/Postflight Debriefing .....	5-3
5.2	SIMULATOR TRAINING .....	5-4
5.2.1	CV Approach/Departure Procedures .....	5-4
5.2.2	Emergency Procedures .....	5-4
5.3	FCLP .....	5-4
5.3.1	Personnel Requirements .....	5-4
5.3.2	Traffic Pattern Control Responsibilities .....	5-4
5.3.3	Preflight Briefing .....	5-4
5.3.4	Conduct of FCLP .....	5-5
5.4	PILOT PERFORMANCE EVALUATION .....	5-5
5.4.1	Minimum Number of FCLP Periods .....	5-5
5.4.2	FCLP Performance Records .....	5-5
5.4.3	LSO Certification of Pilot Performance .....	5-5

**CHAPTER 6 — SHIPBOARD PROCEDURES**

6.1	BRIEFING AND DEBRIEFING .....	6-1
6.1.1	Carrier Qualification/Currency Landing Procedures Briefing .....	6-1
6.1.2	Postflight Debriefing .....	6-1
6.1.3	Pilot Landing Trend Debriefs .....	6-1
6.1.4	Recurrent CV Procedures Training .....	6-1
6.1.5	Special Operations Procedures Briefing .....	6-1
6.2	CARRIER QUALIFICATIONS .....	6-1
6.2.1	Definitions .....	6-1
6.2.2	Limitations for Initial Carrier Qualifications .....	6-5
6.2.3	LSO Certification of Pilot Performance .....	6-6

6.3	CURRENCY CRITERIA FOR CARRIER QUALIFIED PILOTS .....	6-6
6.3.1	Limitations for Currency/Refresher Landings .....	6-6
6.4	NORMAL RECOVERY OPERATIONS .....	6-7
6.4.1	Personnel Requirements .....	6-7
6.4.2	LSO Responsibilities .....	6-8
6.4.3	Recovery Procedures for Final Approach .....	6-10
6.4.4	Foul Deck Waveoff .....	6-11
6.4.5	Optical Landing System Limits .....	6-11
6.4.6	Wind Over Deck (WOD) Requirements .....	6-11
6.4.7	Safety Precautions .....	6-11
6.4.8	MOVLAS Training .....	6-12
6.4.9	MOVLAS During Carrier Qualifications .....	6-12
6.4.10	MOVLAS Operating Procedures .....	6-12

**PART IV — EMERGENCY PROCEDURES**

**CHAPTER 7 — EMERGENCY PROCEDURES**

7.1	INTRODUCTION .....	7-1
7.2	SHORE-BASED EMERGENCIES .....	7-1
7.2.1	FCLP Pattern Emergencies .....	7-1
7.3	SHIPBOARD EMERGENCIES .....	7-1
7.3.1	Aircraft Emergencies .....	7-1
7.3.2	Landing Aid Malfunctions .....	7-2
7.3.3	Communication Emergencies (General) .....	7-3
7.3.4	Communication Emergencies (Day) .....	7-3
7.3.5	Communication Emergencies (Night) .....	7-3
7.3.6	Miscellaneous LSO Equipment Malfunction .....	7-4
7.3.7	Excessive Deck Motion .....	7-4
7.3.8	Ship Static Mistrim .....	7-5
7.3.9	Barricade Engagements .....	7-5

**PART V — EXTREME WEATHER CONDITION OPERATIONS**

**CHAPTER 8 — EXTREME WEATHER CONDITION OPERATIONS**

8.1	ABSENCE OF HORIZON REFERENCE .....	8-1
8.2	RESTRICTED VISIBILITY/CEILING OPERATIONS .....	8-1

8.3	EXCESSIVE DECK MOTION .....	8-1
8.4	EXCESSIVE WIND-OVER-DECK OPERATIONS .....	8-1

**PART VI — COMMUNICATIONS**

**CHAPTER 9 — COMMUNICATIONS**

9.1	GENERAL .....	9-1
9.2	RADIO COMMUNICATIONS .....	9-1
9.3	STANDARD LSO PHRASEOLOGY .....	9-1
9.4	RADIO COMMUNICATIONS DURING EMERGENCY SITUATIONS .....	9-1

**PART VII — NATOPS EVALUATION, PILOT PERFORMANCE RECORDS AND AIRCRAFT MISHAP STATEMENTS**

**CHAPTER 10 — NATOPS EVALUATION**

10.1	INTRODUCTION .....	10-1
10.1.1	Concepts .....	10-1
10.1.2	Implementation .....	10-1
10.2	FIELD LSO QUALIFICATION .....	10-1
10.2.1	Formal Ground Training .....	10-1
10.2.2	Field Experience .....	10-1
10.2.3	Field Evaluation .....	10-1
10.2.4	Certification .....	10-1
10.3	SQUADRON LSO QUALIFICATION .....	10-1
10.3.1	Formal Ground Training .....	10-1
10.3.2	Shipboard Experience .....	10-2
10.3.3	Written and Practical Evaluation .....	10-2
10.3.4	Certification .....	10-2
10.4	WING LSO QUALIFICATION .....	10-2
10.4.1	Formal Ground Training .....	10-2
10.4.2	Shipboard LSO Experience .....	10-2
10.4.3	Written and Practical Evaluation .....	10-2
10.4.4	Certification .....	10-2
10.5	TRAINING LSO QUALIFICATION .....	10-3

	<i>Page No.</i>
10.5.1	Prerequisites ..... 10-3
10.5.2	Formal Ground Training ..... 10-3
10.5.3	Classroom Training Experience ..... 10-3
10.5.4	Field Experience ..... 10-3
10.5.5	Shipboard Experience ..... 10-3
10.5.6	Certification ..... 10-3
10.6	STAFF LSO QUALIFICATION ..... 10-3
10.6.1	Formal Ground Training ..... 10-3
10.6.2	Shipboard Currency ..... 10-3
10.6.3	Certification ..... 10-3
10.7	CARRIER AIR WING PREDEPLOYMENT LSO EVALUATION ..... 10-3
10.7.1	General ..... 10-3
10.7.2	Formal Ground Training Program Evaluation ..... 10-3
10.7.3	Shipboard LSO Team Performance Evaluation ..... 10-4
10.8	LSO TRAINING STATUS MATRIX ..... 10-4
10.9	REMOVAL OF LSO DESIGNATION ..... 10-4
 <b>CHAPTER 11 — PILOT PERFORMANCE RECORDS</b>	
11.1	INTRODUCTION ..... 11-1
11.2	LOG BOOKS ..... 11-1
11.3	PILOT PERFORMANCE RECORDS ..... 11-1
11.3.1	Automated Performance Assessment and Readiness Training System ..... 11-1
11.4	STANDARD LOG SYMBOLS ..... 11-1
11.4.1	General Symbols ..... 11-4
11.4.2	Descriptive Symbols ..... 11-5
11.4.3	Symbol Suffixes ..... 11-7
 <b>CHAPTER 12 — AIRCRAFT MISHAP STATEMENTS</b>	
12.1	GENERAL ..... 12-1
12.1.1	LSO Mishap Statement ..... 12-1
<b>INDEX</b>	..... <b>Index-1</b>



# LIST OF ILLUSTRATIONS

Page  
No.

## CHAPTER 1 — INTRODUCTION

Figure 1-1. Recommended Minimum LSO Requirements ..... 1-5

## CHAPTER 4 — SHIPBOARD WORKSTATION

Figure 4-1. Vertical Field Angle ..... 4-3  
 Figure 4-2. Vertical Field Angle Table ..... 4-3  
 Figure 4-3. Azimuthal Range and Angle ..... 4-4  
 Figure 4-4. Source Light Bulb Failure ..... 4-4  
 Figure 4-5. Deck-Edge Assembly (FLOLS) ..... 4-5  
 Figure 4-6. Geometry of Line Mode Stabilization ..... 4-6  
 Figure 4-7. Glideslope Glidepath Relation with RHW ..... 4-7  
 Figure 4-8. Determination of Basic Angle ..... 4-8  
 Figure 4-9. Effects of Pitch Angle (Basic Angle) Changes on Light Plane ..... 4-9  
 Figure 4-10. Effects of Hook-to-Eye Changes on Light Plane ..... 4-9  
 Figure 4-11. Optical Glideslope and Hook-to-Eye Distances ..... 4-10  
 Figure 4-12. Manually Operated Visual Landing Aid System (MOVLAS)  
 Mk 1 Mod 2 Shipboard, General Arrangement ..... 4-11  
 Figure 4-13. Mk 1 Mod 0 LSO Heads-Up Display (HUD) Console ..... 4-13  
 Figure 4-14. LSO Base Console ..... 4-14  
 Figure 4-15. Stabilization Remote Panel (A230A) ..... 4-15  
 Figure 4-16. Lighting Remote Control Panel (A730A) ..... 4-16

## CHAPTER 6 — SHIPBOARD PROCEDURES

Figure 6-1. Operating Criteria for Qualified Pilots ..... 6-2

## CHAPTER 9 — COMMUNICATIONS

Figure 9-1. Standard Radio Phraseology ..... 9-2

## CHAPTER 10 — NATOPS EVALUATION

Figure 10-1. LSO Training Status Matrix ..... 10-5

## CHAPTER 11 — PILOT PERFORMANCE RECORDS

Figure 11-1. Carrier Landing Trend Analysis Form ..... 11-2  
 Figure 11-2. APARTS Trend Analysis Form ..... 11-3



# LIST OF ACRONYMS AND ABBREVIATIONS

## A

**ACLS.** Automatic carrier landing system.

**AFGT.** Advanced formal ground training.

**APARTS.** Automated performance assessment and readiness training system.

**APC.** Approach power compensator.

**ARBs.** Aircraft recovery bulletins.

## C

**CAFSUs.** Carrier and field service units.

**CARQUAL.** Carrier qualification.

**CATCC.** Carrier air traffic control center.

**CCA.** Carrier controlled approach.

**CDP.** Cross deck pendant.

**COD.** Carrier on-board delivery.

**CV.** Aircraft carrier.

## E

**EMCON.** Emission control.

## F

**FCLP.** Field carrier landing practice.

**FDHDP.** Flight deck hazardous duty pay.

**FGT.** Formal ground training.

**FLOLS.** Fresnel lens optical landing system.

**FRS/TRACOM.** Fleet replacement squadron/training command.

## G

**GCA.** Ground control approach.

## H

**H/E.** Hook-to-eye.

**HUD.** Heads-up display.

## I

**IFF.** Identification friend or foe.

**IFGT.** Initial formal ground training.

**IFLOLS.** Improved Fresnel Lens Optical Landing System.

**IFR.** Instrument flight rules.

**ILARTS.** Integrated launch and recovery television system.

**ILS.** Instrument landing system.

## L

**LSO.** Landing signal officer.

## M

**MOVLAS.** Manually operated visual landing aid system.

## N

**NATOPS.** Naval air training and operating procedures standardization.

**NFOs.** Naval flight officers.

**NORDO.** No-radio.

## O

**ODCR.** Officer data control report.

**OLS.** Optical landing system.

**OTC.** Officer in tactical command.

**NAVAIR 00-80T-104**

**P**

**PALS.** Precision Automatic Landing System.

**PLAT.** Pilot landing aid television.

**R**

**RHW.** Recovery headwind.

**S**

**SAR.** Search and rescue.

**SATS.** Short airfield tactical support.

**SME.** Subject matter expert.

**SRC.** Scheduled removal component.

**T**

**TRAWING.** Training wing.

**U**

**UHF.** Ultrahigh frequency.

**V**

**V/STOL.** Vertical/short takeoff and landing.

**VFR.** Visual flight rules.

**VHF.** Very high frequency.

# PREFACE

## SCOPE

The NATOPS Flight Manual is issued by the authority of the Chief of Naval Operations and under the direction of Commander, Naval Air Systems Command in conjunction with the Naval Air Training and Operating Procedures Standardization (NATOPS) Program. This manual contains information on all aircraft systems, performance data, and operating procedures required for safe and effective operations. However, it is not a substitute for sound judgment. Compound emergencies, available facilities, adverse weather or terrain, or considerations affecting the lives and property of others may require modification of the procedures contained herein. Read this manual from cover to cover. It is your responsibility to have a complete knowledge of its contents.

## HOW TO GET COPIES

### One-Time Orders

If this publication is needed on a one-time basis (without future updates), order it from stock by sending an electronic DD 1348 requisition in accordance with NAVSUP Publication 2002D.

### Automatic Distribution (with Updates)

This publication and changes to it are automatically sent to activities that are established on the Automatic Distribution Requirements List (ADRL) maintained by Naval Air Technical Data and Engineering Service Command, in San Diego, CA. If there is continuing need for this publication, each activity's Central Technical Publication Librarian must send a revised ADRL report on floppy disk to Naval Air Technical Data and Engineering Service Command. If an activity does not have a library, send a letter to the Commanding Officer, Naval Air Technical Data and Engineering Service Command, Naval Aviation Depot, North Island, Bldg. 90, Code 3.3A, P.O. Box 357031, San Diego, CA 92135-7031, requesting assignments of a distribution account number (if necessary) and automatic mailing of future issues of the publications needed.

## Note

The ADRL floppy disk can be used only to place an activity on the mailing list for automatic distribution of future issues of the publication. It cannot be used to make one-time orders of publications from current stock. To get publications from current stock, see One-Time Orders above.

Once established on automatic distribution for this or any other NAVAIR technical publication, an activity must submit an ADRL report on floppy disk at least once every 12 months to update or confirm their automatic distribution requirements.

## Note

Activities not submitting an ADRL report on floppy disk for more than 12 months may be dropped from distribution of all NAVAIR technical publications.

## UPDATING THE MANUAL

To ensure that the manual contains the latest procedures and information, NATOPS review conferences are held in accordance with OPNAVINST 3710.7 series.

## CHANGE RECOMMENDATIONS

Recommended changes to this manual or other NATOPS publications may be submitted by anyone in accordance with OPNAVINST 3710.7 series.

Routine change recommendations are submitted directly to the Model Manager on OPNAV Form 3710/6 (4-90) shown herein. The address of the Model Manager of this program is:

Officer in Charge  
U.S. Navy LSO School  
1680 Tomcat Blvd. Suite 100  
Virginia Beach, VA 23460-2189  
lsoschool@nasoceana.navy.mil

Change recommendations of an URGENT nature (safety of flight, etc.), should be submitted directly to the NATOPS Advisory Group Member in the chain of command by priority message.

**YOUR RESPONSIBILITY**

NATOPS Flight Manuals are kept current through an active manual change program. Any corrections, additions, or constructive suggestions for improvement of its content should be submitted by routine or urgent change recommendation, as appropriate at once.

**NATOPS FLIGHT MANUAL INTERIM CHANGES**

Flight Manual Interim Changes are changes or corrections to the NATOPS Flight Manuals promulgated by CNO or NAVAIRSYSCOM. Interim Changes are issued either as printed pages, or as a naval message. The Interim Change Summary page is provided as a record of all interim changes. Upon receipt of a change or revision, the custodian of the manual should check the updated Interim Change Summary to ascertain that all outstanding interim changes have been either incorporated or canceled; those not incorporated shall be recorded as outstanding in the section provided.

**CHANGE SYMBOLS**

Revised text is indicated by a black vertical line in either margin of the page, like the one printed next to this paragraph. The change symbol shows where there has been a change. The change might be material added or information restated. A change symbol in the margin by the chapter number and title indicates a new or completely revised chapter.

**WARNINGS, CAUTIONS, AND NOTES**

The following definitions apply to WARNINGS, CAUTIONS, and Notes found throughout the manual.



**WARNING**

An operating procedure, practice, or condition, etc., that may result in injury or death, if not carefully observed or followed.



**CAUTION**

An operating procedure, practice, or condition, etc., that may result in damage to equipment, if not carefully observed or followed.

**Note**

An operating procedure, practice, or condition, etc., that is essential to emphasize.

**WORDING**

The concept of word usage and intended meaning adhered to in preparing this Manual is as follows:

1. Shall has been used only when application of a procedure is mandatory.
2. Should has been used only when application of a procedure is recommended.
3. May and need not have been used only when application of a procedure is optional.
4. Will has been used only to indicate futurity, never to indicate any degree of requirement for application of a procedure.

**NATOPS/TACTICAL CHANGE RECOMMENDATION**  
**OPNAV 3710/6 (4-90) S/N 0107-LF-009-7900**

DATE \_\_\_\_\_

TO BE FILLED IN BY ORIGINATOR AND FORWARDED TO MODEL MANAGER

FROM (Originator)		Unit				
TO (Model Manager)		Unit				
Complete Name of Manual/Checklist	Revision Date	Change Date	Section/Chapter	Page	Paragraph	

Recommendation (Be specific.)

CHECK IF CONTINUED ON BACK

Justification

Signature	Rank	Title
-----------	------	-------

Address of Unit or Command

TO BE FILLED IN BY MODEL MANAGER (Return to Originator)

FROM	DATE
TO	

REFERENCE

(a) Your Change Recommendation Dated \_\_\_\_\_

Your change recommendation dated \_\_\_\_\_ is acknowledged. It will be held for action of the review conference planned for \_\_\_\_\_ to be held at \_\_\_\_\_

Your change recommendation is reclassified URGENT and forwarded for approval to \_\_\_\_\_ by my DTG \_\_\_\_\_

/S/ _____ MODEL MANAGER	_____ AIRCRAFT
-------------------------	----------------





PART I

# The Landing Signal Officer

[Chapter 1](#) — Introduction

[Chapter 2](#) — Indoctrination



## CHAPTER 1

## Introduction

## 1.1 GENERAL

This manual provides all conventional landing non-V/STOL LSOs with standardized operating procedures, technical guidance, and a single source of LSO policy and information to all command levels.

**Note**

Officers involved in V/STOL aircraft control shall be governed by separate directives.

The LSO shall be thoroughly familiar with the contents of the following directives in addition to this manual:

1. CV NATOPS Manual — carrier operations manual which includes landing patterns and procedures in Chapter 5.
2. Appropriate aircraft model NATOPS flight manual sections pertaining to carrier recovery.
3. ARBs
  - a. ARB 10-10 series — general recovery information that is required reading for all personnel concerned with aircraft recovery operations.
  - b. ARB 0-11 series — current status of all ARBs.
  - c. ARB 12-12 series — deck configuration for barricade engagements.
  - d. ARB 20 through 39 series as appropriate — covers various types of arresting gear, engaging speeds/weights, etc.
  - e. ARB 62-12 series — Fresnel lens settings for all aircraft and CVs, required reading for all pilots.
  - f. ARB 63-12 series — Improved Fresnel lens settings for all aircraft and CVs, required reading for all pilots.
4. Respective type commander instructions.

## 1.2 ROLE OF LANDING SIGNAL OFFICER

The landing signal officer's primary responsibility is the safe and expeditious recovery of non-V/STOL fixed-wing aircraft aboard ship. The employment of high-performance aircraft and the necessity for all weather operations have placed ever increasing demands on the LSO's skill and judgment. Through training and experience, he is capable of correlating factors of wind, weather, aircraft capabilities, ship configuration, pilot experience, etc., in order to provide optimum control and assistance in aircraft landings. The LSO is also directly responsible for training pilots in carrier landing techniques. In this regard, he must constantly monitor pilot performance, schedule and conduct necessary ground training, counsel and debrief individual pilots, and certify their carrier readiness and qualification. The pilot and LSO form a professional and disciplined team, both ashore and afloat. The LSO strives to develop the pilot's confidence, judgment, maximum effort, technical proficiency, and personal interest. The pilot must rely on the LSO's experience and ability to prepare him for optimum effectiveness as a carrier pilot.

## 1.3 COMMAND RELATIONSHIPS AND RESPONSIBILITIES OF THE LANDING SIGNAL OFFICER

**1.3.1 Type Commander.** The type commander LSO shall act as a coordinator in all matters concerning the readiness, training, and qualifications of LSOs under his cognizance; shall work with the LSO training model manager in all matters concerning LSO readiness and training; and shall be responsible for the nomination of qualified LSOs to the Chief of Naval Personnel or Commandant of the Marine Corps for future assignment. The senior LSO in each subordinate command is responsible for informing the type commander or Chief

of Naval Air Training of the status of LSO training and qualifications. This report shall be submitted in accordance with **Part VII, Chapter 10** of this manual.

**1.3.2 LSO Training Model Manager.** The officer in charge of the LSO School shall act as the LSO training and NATOPS model manager. As such, he will be responsible for the following major training areas:

1. Developing, implementing, monitoring, and updating educational media materials for all LSO training.
2. Conducting IFGT, FRS/TRACOM FGT, and AFGT.
3. Monitoring training levels of all U.S. Navy and Marine Corps LSO personnel.
4. Acting as the SME representative to all research and development projects relating to LSO training and equipment.
5. Monitoring status of shipboard LSO equipment stations and providing inputs to appropriate fleet type commander LSOs.
6. Acting as a liaison between pertinent commands concerning LSO matters.

**1.3.3 Ship/Air Wing Commanding Officer.**

When embarked, the LSO is responsible to the Captain and Air Wing Commander for the safe and expeditious recovery of aircraft. The LSO shall inform the Captain and Air Wing Commander through the Air Officer of any conditions that might interfere with recovery such as malfunctions of equipment, improper deck configuration, adverse weather and wind, or sea conditions. It is the LSO's responsibility to make appropriate recommendations to the Captain and Air Wing Commander based on his evaluation of the operating environment.

**1.3.3.1 Air Officer.** When embarked, the LSO performs his platform duties under the supervision of the Air Officer. It is incumbent on the LSO to establish a close working relationship with the Air Officer, to include periodic discussions regarding mutual expectations and delegation of responsibilities in the recovery of aircraft.

**1.3.4 Air Wing Commander.** The air wing staff LSO is responsible to the Air Wing Commander for the following:

1. The operational readiness of all assigned squadrons and detachments pertaining to FCLP and carrier landing operations.
2. Coordination and supervision of the training and employment of all LSOs within the air wing. He will ensure that a high level of proficiency is maintained by the administration of an LSO training program. It is incumbent upon the air wing staff LSO to establish training goals and pursue their accomplishment through field and shipboard training.
3. Provision of trend analysis forms and written commentary where applicable to the Commanding Officer of a detachment's parent squadron following each operating period. It is intended that all pilot carrier performance be observed, evaluated, and critiqued by the host air wing regardless of the unit's tenure aboard ship or the frequency of its operations.
4. Ensuring that a separate COD log is maintained in Air Operations, and that all landings to the carrier by COD aircraft are recorded and debriefed. If operational tempo does not facilitate a face-to-face debrief with the pilot, the pass shall be recorded in the COD logbook for retrieval and subsequent debrief by the squadron LSO.

**1.3.5 Squadron Commanding Officer.** The squadron LSO advises and makes recommendations to the squadron commander pertaining to:

1. The state of pilot training
2. Any unsafe tendencies of individual pilots
3. The state of assistant LSO assignment and training
4. The latest technical developments of appropriate type aircraft, ship configurations, and equipment which concern the recovery of aircraft.

For CV detachments, the parent squadron LSO shall ensure that the level of readiness of the detachment to be assigned meets the requirements outlined in this

manual. Recipient LSOs should, as far as practicable, observe all detachment performance of FCLP prior to embarkation.

It is incumbent on the Commanding Officer to fully support the LSO training program.

Commanding officers should ensure that LSOs receive flight time commensurate with other squadron pilots.

## 1.4 LSO DESIGNATIONS

### 1.4.1 LSO Designation Category

1. Field LSO reflects the individual's ability to satisfactorily control one or more specific type aircraft during FCLP. Further, he is considered qualified to maintain and interpret LSO logs and records of FCLP periods conducted for the purpose of making recommendations to the commanding officer regarding extension or revocation of pilot currency for CV landings.
2. Squadron LSO reflects the individual's ability to satisfactorily control one or more type aircraft at the field and aboard ship in day and night conditions and satisfactorily operate the **MOVLAS** (day). Further, he is considered qualified to maintain and interpret LSO logs and records and make recommendations to the commanding officer concerning individual pilot qualifications. It is the responsibility of the air wing staff LSO to recommend the squadron LSO designation.
3. Wing LSO reflects an individual's ability to control a majority of the air wing aircraft at the field and aboard ship in day/night, all weather and deck conditions without assistance, as well as an ability to function as an LSO watch team supervisor and satisfactorily recover aircraft aboard ships utilizing **MOVLAS**. Designation as a wing LSO shall be required prior to assignment to an air wing staff LSO billet. It is the responsibility of the air wing staff LSO to recommend the designation as wing LSO.
4. Training LSO reflects the individual's ability to administer, instruct, and supervise initial in-type carrier qualification for a specific type aircraft.

The recommendation for designation as a training LSO shall be the responsibility of the senior training LSO.

5. Staff LSO reflects the attainment of the highest level of qualification and experience gained as a result of performance in subordinate categories. The responsibility for recommending designation as a staff LSO rests with the Air Wing Commander and represents his judgment of the individual's preparedness to assume the responsibility of an air wing staff LSO.

### 1.4.2 LSO Trainee Nomination Procedures.

The decision to recommend initial LSO nomination rests with the individual's Commanding Officer, based upon the recommendation of the senior cognizant LSO. A letter recommending nomination as an LSO trainee shall be submitted by the Commanding Officer to the type commander via the Air Wing Commander, Training Wing Commander, or Marine Air Wing Commander.

**1.4.3 Upgrading Procedures.** When a letter requesting LSO nomination, qualification, or qualification upgrade is forwarded to the first endorser, the LSO is authorized to control aircraft in that capacity while approval from the type commander is pending. Copies of the type commander's approval letter shall be forwarded to Bureau of Naval Personnel (PERS 433) or Commandant of the Marine Corps (Code MMOA2) for inclusion into the officer's service record.

## 1.5 LSO SENIORITY

LSO seniority will be determined by level of LSO designation, with LSO School OIC, TYCOM LSOs, and CNATRA LSO being the highest level of designation, followed by staff LSO, wing LSO, and squadron LSO in that order. In FRS and training command squadrons only, the training LSO designation shall be used to determine LSO seniority, regardless of squadron or wing designation. In situations involving two or more individuals with the same level of designation, seniority of designation date will determine LSO seniority unless modified by the CNAF, Air Wing Commander, or Commanding Officer.

All LSOs within the air wing are operationally subordinate to the air wing staff LSO.

## 1.6 ASSIGNMENT

The type commander LSO shall act as coordinator in all matters concerning the readiness, training, qualification, and assignment of LSOs under their cognizance. The type commander LSO billet shall be filled by a current staff qualified LSO. Marine air wing staff LSO billets should be filled by experienced and current wing designated LSOs.

The Officer in Charge LSO School billet shall be filled by a staff qualified LSO immediately following his air wing staff LSO tour.

The numbers contained in **Figure 1-1** are the recommended minimum LSO requirements. However, it should be recognized that practical maximums also exist because of variable operating tempos and corre-

sponding training opportunities. Nomination of LSO trainees in excess of those indicated could result in reducing the overall experience level of LSOs in the future. Staff LSOs shall coordinate and limit the total number of LSOs per air wing in order to provide adequate training opportunities at the operational level.

## 1.7 FLIGHT DECK HAZARDOUS DUTY INCENTIVE PAY (FDHDIP)

Per CNAL 220935ZAPR99, LSOs are authorized to exceed the quotas listed in OPNAVINST 7220.4 to compensate individuals who are “under instruction.” All LSOs are considered to be “under instruction” until they become CVW staff qualified LSOs. LSOs that meet the requirements as set forth in OPNAVINST 7220.4 are entitled to **FDHDIP**, at no penalty to the command’s other quotas.

<b>STAFF</b>	<b>QUAL</b>	<b>IN TRAINING</b>	<b>TOTAL</b>
TYCOM	1	—	1
LSO SCHOOL	4	—	4
CVW	3	—	3
TRAWING	1	—	1
MAW	1	—	1
NATC	2	—	2
<b>OPERATIONAL SQUADRONS</b>	<b>QUAL</b>	<b>IN TRAINING</b>	<b>TOTAL</b>
VF/VS/VAW/VFA	2	2	4
VAQ	2	1	3
VMAQ/VMFA/VMFA (AW)	1	1	2
VMFA (CV DEPLOYED)	2	2	4
VR/VRC	1	1	2
VX (AS APPROPRIATE)	1	—	1
VT (INT. STK.)	5	—	5*
VT (ADV. STK.)	4	—	4*+
VT (E-2/C-2)	3	—	3*
<b>DETACHMENTS (CV DEPLOYED)</b>	<b>QUAL</b>	<b>IN TRAINING</b>	<b>TOTAL</b>
VMAQ	1	1	1
<b>REPLACEMENT SQUADRONS</b>	<b>QUAL</b>	<b>IN TRAINING</b>	<b>TOTAL</b>
VFA	6	—	6
VMFAT	6	—	5
VF	6	—	5
VAW	6	—	6
VS	6	—	5
VAQ	5	—	5
*NOT LESS THAN 1 LSO/8 STUDENTS			
+ VT-7 REQUIREMENT IS 5			
<b>Note</b>			
The above numbers represent minimum recommended LSO requirements. Operational squadrons will normally exceed these minimums to maintain a quality LSO training program.			

Figure 1-1. Recommended Minimum LSO Requirements





## CHAPTER 2

# Indoctrination

## 2.1 SELECTION OF LSO TRAINEES

Prospective LSOs are first tour pilots nominated by squadron commanding officers. When selecting candidates for LSO training, consideration should be given to motivation, aviation ability, and potential as an instructor. Candidates should also be identified early enough in their first operational tour to be given the opportunity to progress to wing qualification status before the end of that tour. Nominees should be sent to the U.S. Navy LSO School as soon as nominees have enough initial familiarization with the LSO trade to make the school a worthwhile experience.

Squadron commanding officers shall submit a letter of nomination for LSO training via the chain of command to their cognizant type commander for approval. Letters of nomination should include the following information:

1. Name, rank, SSN, designator, and date of rank
2. Date reporting/reported to squadron and rotation date as shown on latest [ODCR](#)
3. Total flight hours/hours in type
4. Total carrier landings day/night by type aircraft.

## 2.2 LSO TRAINING PROGRAM

The LSO training and qualification program consists of the following:

1. Ground training for LSO trainees and squadron LSOs
2. Initial field training prior to squadron LSO designation
3. [IFGT](#) prior to wing LSO designation
4. Shipboard training prior to squadron and wing LSO designation

5. Initial formal ground training and FRS/TRACOM formal ground training prior to training LSO designation
6. Advanced field and shipboard training prior to training LSO designation
7. AFGT prior to staff LSO designation.

**2.2.1 Formal Ground Training.** Initial, FRS/TRACOM, and advanced formal ground training shall be conducted by the U.S. Navy LSO School. Initial formal ground training should be completed prior to designation as a squadron LSO and shall be completed prior to designation as a wing LSO. FRS/TRACOM formal ground training should be completed prior to reporting to an FRS or training command squadron. Advanced formal ground training shall be completed prior to reporting to the carrier air wing commander's staff.

**2.2.2 Field Training.** Field training prior to designation as a squadron LSO shall be conducted under the supervision of a squadron, wing, or staff LSO. A training LSO shall supervise the advanced field training required for training LSO qualification.

**2.2.3 Shipboard Training.** Shipboard training pursuant to squadron, wing, or training LSO qualification shall be conducted under the supervision of a training or staff LSO. A designated staff LSO shall supervise the progress of a prospective staff LSO until the candidate has attained sufficient proficiency in controlling all assigned air wing aircraft for staff designation. In all cases, it is the responsibility of the senior designated LSO to evaluate the capabilities and progress of the LSO under training and report the same in accordance with [Part VII, Chapter 10](#) of this manual.

**2.2.4 Aircraft Crosstype Training.** Designated squadron LSOs should receive flight indoctrination in at least one additional type of aircraft assigned to his respective air wing. LSO cross-training is designed to improve LSO understanding of aircraft handling and performance characteristics primarily in the approach

and landing phases. LSO exposure to the flight characteristics of aircraft other than his own has a positive effect on overall LSO expertise.

**2.3 REQUIREMENTS FOR LSO DESIGNATION**

The requirements for LSO qualification and designation are discussed in [Part VII, Chapter 10 \(NATOPS Evaluation\)](#) of this manual.

**2.4 MINIMUM CURRENCY REQUIREMENTS**

The following criteria apply to qualified LSOs and are established to ensure minimum LSO proficiency for safe recovery operations:

PERIOD SINCE ACTING AS CONTROLLING LSO FOR CV RECOVERY OPERATIONS	REQUIRED ACTION PRIOR TO ACTING AS CONTROLLING OR BACKUP LSO FOR CV RECOVERY OPERATIONS
Up to 12 months	Discretion of senior LSO
Over 12 months	1. Control 80 field carrier landing practice (FCLP) landings or observe 30 CV landings; and  2. Control 20 CV landings under supervision of senior LSO. Senior LSO must be current to supervise currency training.

**2.5 FACTORS AFFECTING LSO READINESS**

1. The duties of the LSO require the same levels of mental alertness that are required of a naval aviator in actual control of aircraft. The LSO shall be a physically qualified (or waived) designated naval aviator with a current Aeromedical Clearance Notice (up-chit, NAVMED 6410/2). Additionally, LSOs shall remain in full

compliance with OPNAVINST 3710.7 series, Section 822, concerning personnel readiness and qualifications. There will be occasions when the LSO is physically fit for LSO duties but not for actual flight (e.g., sprained wrist). This requires an Aeromedical Clearance Notice for *LSO Duties Only*.

2. LSOs shall maintain flight proficiency in the carrier landing environment. Staff LSOs are the senior air wing subject matter experts in the fixed-wing recovery environment and therefore must fly with the air wing to be credible evaluators as well as to have first-hand knowledge of the conditions air wing pilots face during recovery operations. Consequently, staff LSO billets should be fully afforded adequate flight hours for proficiency.

**2.6 TRAINING LSO CARRIER QUALIFICATION (CQ) REQUIREMENTS**

In order to maintain proficiency in the carrier landing environment, Training LSO's shall receive carrier arrestments whenever possible. CV (N) and FRS/TRACOM commanding officers should ensure, as a minimum, Training LSO's receive six arrested landings every 6 months or 12 arrested landings per year.

**2.7 LSO TRAINER (DEVICE 2H111)**

The Landing Signal Officer Trainer, Device 2H111, is operational at NAS Oceana. It simulates a fully functional LSO platform on a CVN-68 (Nimitz) or CVN 76 (Reagan) class CV, and employs models of virtually all current fleet aircraft. A wide variety of environmental conditions, operating parameters (including MOVLAS), and normal or emergency scenarios may be simulated to provide realistic individual LSO or LSO team procedural and proficiency training. The use of the trainer is highly recommended for LSO turnaround training on both a squadron and air wing level, to enhance the overall preparedness of LSO teams prior to embarked operations.

PART II

# The LSO Workstation

Chapter 3 — Shore-Based Workstation

Chapter 4 — Shipboard Workstation



## CHAPTER 3

# Shore-Based Workstation

## 3.1 GENERAL

Certain specific equipment and personnel shall be provided for both shore and shipboard operations so that an LSO can safely and efficiently perform his mission. Responsibility for the provision, maintenance, and proper functioning of the equipment rests with the air station's or ship's air department, as applicable. It is the LSO's responsibility to ascertain, before commencing operations, that all required equipment is available and operative.

## 3.2 MINIMUM EQUIPMENT FOR FIELD CARRIER LANDING PRACTICE (FCLP) OPERATIONS

**3.2.1 Day FCLP.** The minimum equipment and personnel required for day FCLP are:

1. Visual landing aid and necessary accessories, including waveoff pickle switch and press-on and release-off cut switch
2. MOVLAS (available for at least one full FCLP period per pilot)
3. Communications: a UHF transceiver with extension speaker and microphone and guard transceiver capability
4. Simulated carrier deck markings, adequately maintained
5. Crew: a qualified LSO shall be on station for all FCLP operations.

**3.2.2 Night FCLP.** In addition to the items listed in the preceding paragraph, the following equipment and personnel are required for night FCLP:

1. Permanent, flush-deck lighting. Unless this system is installed, a minimum of 24 portable powered lights with suitable holders will be provided.

2. Aldis lamp for emergency use located at the LSO station
3. Abeam position marker light located at the LSO station, visible abeam to the pilot
4. Emergency arresting gear marker light
5. Crew: With more than two aircraft in an LSO controlled FCLP pattern, an individual to assist the controlling LSO is required.

## 3.3 VISUAL LANDING AIDS

**3.3.1 General.** There are presently four optical landing aids used aboard naval air stations.

1. Mk 8 Fresnel lens
  - a. Mod 0: Equipped with roll angle drive assembly; no cut lights unless change No. 43 is incorporated
  - b. Mod 1: Not equipped with roll angle drive assembly
2. MOVLAS (Mk 2 Mod 2)
3. Mk 14 Mod 0 improved Fresnel lens.

### Note

Visual landing aids which are installed as a part of an air station's normal approach lighting and marking scheme may be configured to activate the runway waveoff light system (wheels up waveoff lights) whenever the lens waveoff lights are activated by the tower, wheels watch, or the LSO's pickle switch. Use of this configuration may not be suitable for conduct of FCLPs. Refer to NAVAIR 00-80T-114 (ATC Facilities Manual).

Ship Installations Equipment Handbook, CD-1025, Naval Air Engineering Center, Lakehurst, NJ, lists numbers, types, and certification dates of visual landing aids located at each air station.

**3.3.2 Mk 8 Fresnel Lens.** The Mk 8 Fresnel lens is nearly identical to the shipboard variant. The datum arms may be pinned inward against the power control unit when not in use. On/off and intensity controls are provided for independent control of source, datum, and combined cut and waveoff lights. Proper temperature and unit ready indications are identical to those described in the [FLOLS](#) section. A jackscrew and hand-crank on the front of the trailer base is used to adjust desired glideslope. A mirrored pole is provided with the unit to check glideslope settings (the Mk 8 is the only unit that comes standard equipped with a pole). The Mk 8 Mod 0 is equipped with a roll angle assembly so that the unit may be used for continuous short-field arrestments with [SATS](#) systems. Aircraft Recovery Bulletin No. 80 series lists operating instructions and roll angle settings.

**3.3.3 MOVLAS.** The Mk 2 Mod 2 land-based MOVLAS is compatible with the Mk 8 FLOLS, or may be used independently. Refer to the shipboard MOVLAS discussion in [Chapter 4](#) for further information concerning the MOVLAS system.

**3.3.4 Operation and Checks of Shore-Based Visual Landing Aids.** The following discussion provides pertinent information regarding the operation and preoperational checks for shore-based visual landing aids.

**3.3.4.1 Pole Check.** All land-based optical systems are checked for basic angle at a point 150 feet in front of the unit using a telescoping mirror. The exact height of the mirror assembly shall be calculated using site survey data as described in the applicable system operational manual.

**3.3.4.2 Intensities.** When setting intensities of the lens, excessive intensity of the lights causes light spillage, interference with pilot's vision, reflection of light into the background, and an afterglow. The reflection of light into the background hampers proper identification of the meatball by the pilot on approach and may cause mistaken identification of light reflection for a nonexistent meatball. The afterglow may impede the pilot's vision in the final stages of approach, prevent him from recognizing a waveoff, and cause the loss of the glidepath. Light brightness settings must always be maintained near the minimum required intensity to compensate for ambient light and weather

conditions. The brightness settings are determined by the position of the lens with respect to the sun and by the decision of the LSO.

**3.3.4.3 Touchdown Points.** The height of the datum lights above the runway surface is different for each of the shore-based optical systems. This height difference results in slightly different approach geometry and aircraft touchdown point when using the various systems. Touchdown points also vary with each aircraft because of their differences in hook-to-eye (or main tires to eye). The Mk 8 Mod 0 with its roll angle drive assembly is the exception and maintains a constant hook touchdown point. Most field optical landing systems use only basic angles; no roll angle adjustments are made, and each aircraft will have a different touchdown point based on its [H/E](#) value.

Relative wind over the deck needs to be considered during FCLP to select a reasonable compromise on glideslope angle used, considering pilot senses, aircraft power response, LSO sight picture, and aircraft aerodynamics. When selecting a basic angle for FCLP with relatively light winds at the field, a 2-3/4° or 3° glideslope may have the pilot and the LSO seeing a low, flat glideslope. Additionally, the ball will be considerably more difficult to control as the aircraft approaches touchdown. This may become apparent in an excessive number of bolters or early touchdowns.

## 3.4 LSO GREENHOUSE AND RADIOS

Located at many master jet bases and their outlying fields are environmentally protected LSO stations.

The greenhouse should house the controls for the FCLP equipment listed in section 3.2 (i.e., standard LSO pickle switch, MOVLAS controller, radio, etc.). Radio equipment configuration may vary, but must include as a minimum a UHF transceiver with guard transceiver capability.

## 3.5 LSO VEHICLE

A variety of vehicles are available for LSO use at facilities not having a permanent LSO workstation (greenhouse). Although several radio configurations are available, a minimum of one UHF transceiver (with guard capability) and VHF or FM transceiver (for LSO to tower communication) is required for FCLP operations.

## CHAPTER 4

# Shipboard Workstation

## 4.1 MINIMUM EQUIPMENT LIST FOR SHIPBOARD OPERATIONS

**4.1.1 Day Carrier.** The minimum equipment required for day carrier operations includes the following:

1. Visual landing aid and necessary accessories, including three portable switch assemblies (wave-off pickles) with a press-on and release-off cut switch.
2. MOVLAS.
3. The following operable communication equipment is required on the LSO platform:
  - a. Minimum of 2 Air-to-Ship radio communication devices, one for Back up LSO and Controlling LSO, with connections for 2 headsets/handsets each. At a minimum, the communication devices shall provide access to CATCC Final A and Final B UHF radio circuit transceivers and 2 dedicated/backup Air-to-Ship UHF transceivers. The dedicated/backup transceivers shall be capable of selecting required frequency channels from the Backup/Controlling LSO operating area.
  - b. The communication devices shall provide the capability for the Back up and Controlling LSO to override/preempt any Air-to-Ship radio transmission on the frequency of the landing aircraft. In addition, the Back up LSO communication device shall provide the added capability to override/preempt the Controlling LSO.
  - c. Access to the Ship's Service Telephone System (STS) for administrative calls.
  - d. Internal Communications (IC) access to Primary Flight Control, CATCC, Arresting Gear operators and PLAT/Lens operators.
  - e. Direct communication access to the Air Officer.
  - f. A sound-powered hot line to the air officer.
4. For ACLS capable ships, during Case III operations, operable LSO HUD SPN-42/46 indicators.
5. Accurately calibrated relative wind indicator.
6. Colored deck status light system with intensity control for day and night use, clearly visible to PriFly and the LSO. Colored flags or paddles for use in the event of a deck status light failure.
7. 7 X 50 binoculars.
8. Distress equipment:
  - a. Battery powered marker
  - b. Life preserver ring
  - c. Search and rescue sonobuoy.
9. Padded safety net, with an access to the catwalk and interior of the ship, continually maintained.
 



The padded safety net is for emergency use only.
10. A windscreen, constructed of suitable material, with adequate window area.
11. An operable hook-to-ramp indicator and an operable hook touchdown point indicator.
12. A weatherproof, external radio speaker with adjustable volume control.
13. An operable PLAT/ILARTS monitor with center-line reference.

**4.1.2 Night Carrier.** All equipment required for day carrier operations is required at night, with the following additions:

1. Aldis lamp or high intensity spotlight which is located at the LSO platform for emergency use
2. Colored wands for use in the event of a deck status light failure.

**4.1.3 Miscellaneous LSO Equipment Malfunction.** The LSO shall notify the Air Officer of the malfunction or loss of any required equipment. The decision to continue recovery operations with any required LSO equipment inoperative shall rest with the commanding officer.

## 4.2 FRESNEL LENS OPTICAL LANDING SYSTEM

The Mk 6 Mod 3 FLOLS is an electro-optical pilot landing aid featuring two identical channels of stabilization complete with gyro/sensor units, electronic computers, monitoring circuits, built-in maintenance facilities, and automatic trim stabilization units. The FLOLS automatically corrects lens settings for static mistrim of the ship to maintain a constant preselected hook touchdown point. The FLOLS currently has line and inertial (heave) modes of stabilization available.

The FLOLS includes a deck edge assembly (the lens), the FLOLS control room, the PriFly area, and LSO platform.

There is a vast amount of printed information available on the FLOLS. A thorough understanding of the following list of publications is a must for an LSO:

1. Technical Manual, Fresnel Lens Optical Landing System Mk 6 Mod 3, Installation, Service, Operation, and Maintenance Instruction (NAVAIR 51-4OABA-10)
2. Aircraft Recovery Bulletin No. 62-12 (Mk 6 Mod 3 FLOLS)
3. Aircraft Recovery Bulletin No. 10-10.

## 4.2.1 Optical Characteristics

**4.2.1.1 Effects of Temperature.** The optical characteristics of the Fresnel lens vary appreciably with changes in internal cell temperature. If the lens temperature is allowed to vary beyond operational limits ( $97 \pm 7$  °F), three effects will be observed:

1. As temperature varies, the size of the bar of light will appear to change as the image moves from the lens center to the transition line between cell assemblies. If the temperature is higher than operational temperatures, the bar of light at the center will appear smaller and bloom to a larger bar of light at the transition line between cells. At lower temperatures, the opposite will occur.
2. At extreme temperatures it is possible to get blank areas or double bars of light at or near the transition point between cells.
3. The light bar will be wider (i.e., less well-defined) at temperatures higher than design temperatures, and smaller at lower temperatures. Extremes in temperatures (below 90 °F or above 135 °F) will cause out of tolerance indications in PriFly and the FLOLS control room. Overtemperature may be caused by a failed thermal switch(es) causing the cell heaters to stay on, outside air temperature, or aircraft spotted with exhausts pointed near the lens. Since the actual Fresnel lens inside the cell assembly is made of plastic (Lucite), a metal frame (eggcrate) is bolted to the plastic Fresnel lens to support it and keep the lens from warping. The plastic Fresnel lens can be damaged resulting in transition problems if the eggcrate bolts are over-tightened or the clamps that hold the Fresnel lens in the cell are overtightened. Bad transition can usually be detected on deck, but you must be at least 80 feet away from the lens when viewing the display. V-2 lens technicians can move the lens in pitch so all transitions can be viewed. All cells are interchangeable, so the best cells should be put in the center and adjacent positions. V-2 lens technicians can determine the best cells with visual examination of the cell output and by performing the MRC for the Flip Test. If it is necessary to use the lens prior to complete warmup, pilots should be informed that there may not be a smooth transition of the ball between cells and that the ball may disappear as it traverses the



junction between adjacent cells. No difficulty should be experienced when the ball is in the center of the cell.

**4.2.1.2 Focal Point and Field of View.** The inherent characteristic of the FLOLS display is a linear projected glideslope (i.e., the total beam height becomes wider as distance from the lens is increased, and that width increase is linear). The further a pilot is from the lens, the more difficult it is for the pilot to perceive changes in glideslope. The total glideslope vertical field composed of all five cells (Figure 4-1) is approximately 1.7° (each cell accounts for 20.45 minutes of arc or .34°).

Figure 4-2 helps illustrate vertical field angle and also shows why pilot glideslope corrections must become smaller as the aircraft approaches the touchdown point.

Couple the conditions of Figure 4-2 with too bright a lens setting (which significantly reduces ball definition the closer the aircraft approaches the lens) or minor the closer the aircraft approaches the lens) or minor visual acuity problems (pilot, weather, salt on lens, etc.), and the result is unperceived glideslope deviations.

The lenticular lens is the vertical fluted lens attached in front of the Fresnel lens. It provides meatball color and azimuth ( $\pm 20^\circ$ ) (Figure 4-3) and

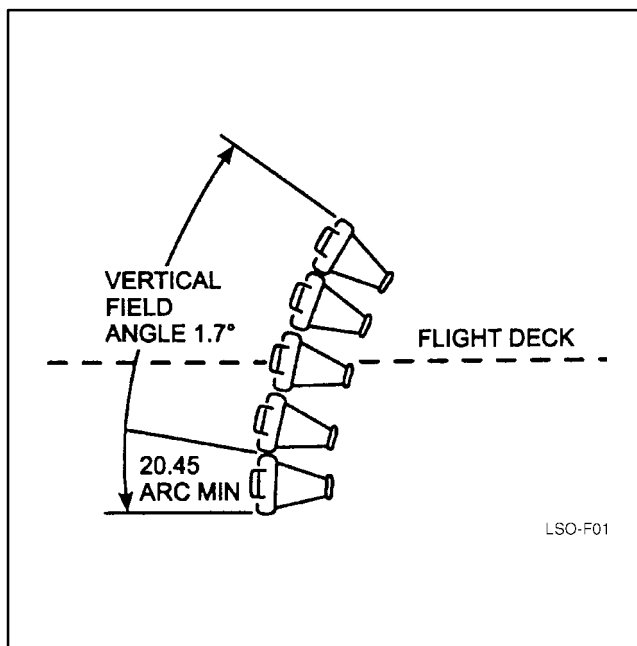

Figure 4-1. Vertical Field Angle

helps to disburse sun reflection from the lens face. The slots should be outside. It can be easily *Murphyed* (i.e., slots on the inside). Since it is exposed to the elements, it needs to be kept clean and dry. Salt, water, dirt, or exhaust smoke may cause spherical aberration (i.e., poor definition). These lenses are plastic and will be damaged and need immediate replacement if they are cleaned improperly.

**4.2.1.3 Circuitry.** Source lights are wired in series-parallel in the four yellow cells. Each cell contains three lamps. If one lamp fails, the corresponding lamp in the other three cells will go out (see Figure 4-4). This provides constant, even illumination from cell to cell. When one lamp burns out, a failure light illuminates in the lens control room. When one lamp in a string fails, extinguishing the entire string, the source lamp intensity must be increased to compensate for the loss of one lamp in each yellow cell. This increased voltage on the remaining lamps will age them faster. The source light series/parallel circuitry provides for all lamps (yellow cells) to age at the same rate, thus (theoretically) producing even illumination among the yellow cells.

**4.2.2 General Operating Intensities.** Set the source, low cell, and datum lights to minimum intensity prior to energizing the lens, then adjust the intensity after the lens is on. This will prevent the LSO or primary from blowing out all the source lights. Maximum recommended intensity settings during daylight are near 9.0, and are usually required at low sun angles. Night settings normally range from 2.0 to 3.0.

DISTANCE FROM TOUCHDOWN (230 FT HTDP)	VERTICAL BEAM HEIGHT OF ALL 5 CELLS	VERTICAL BEAM HEIGHT OF CENTER (OR ANY OTHER) CELL
0 (Touchdown ramp)	11.8 ft	2.4 ft
230 ft	18.6 ft	3.7 ft
1/4 nm	56.3 ft	11.3 ft
1/2 nm	100.8 ft	20.2 ft
3/4 nm	145.3 ft	30.5 ft
1 nm	189.8 ft	38 ft
2 nm	367.9 ft	73.6 ft

Figure 4-2. Vertical Field Angle Table

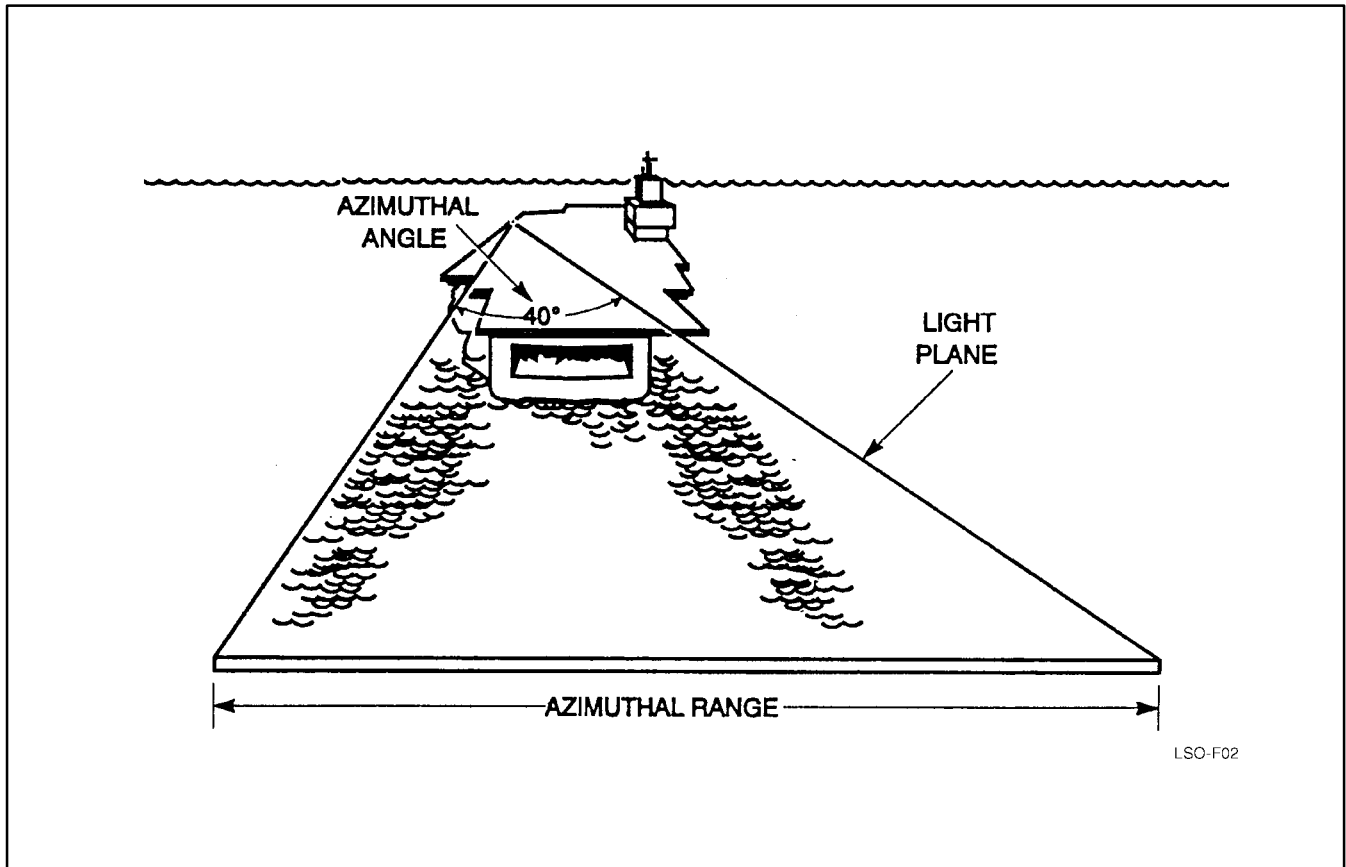

Figure 4-3. Azimuthal Range and Angle

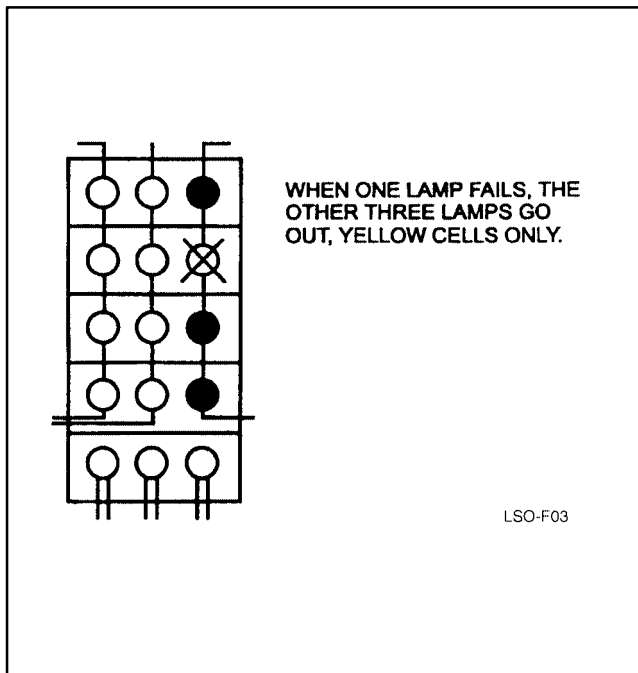

Figure 4-4. Source Light Bulb Failure

Intensity in the low (red) cell is adjusted independently. It may also be flashed at a 45 times-per-minute rate. The flasher/steady switch is located in the FLOLS control room on lighting remote control panel A720A.

**4.2.3 System Condition Indicators.** System condition indicators are located on remote control panels A710A and A720A (in PriFly and the FLOLS control room). The LSO platform lighting remote control panel A730A contains a GO/NO-GO indicator.

**4.2.4 Datum, Waveoff, and Cut Lights.** (See Figure 4-5.) Three fixed datum lights (green) and four conditional datum lights (green) are mounted horizontally on each side of the lens source lights. The fixed datums are continuously illuminated, while the conditional datums go out when the waveoff lights are actuated.

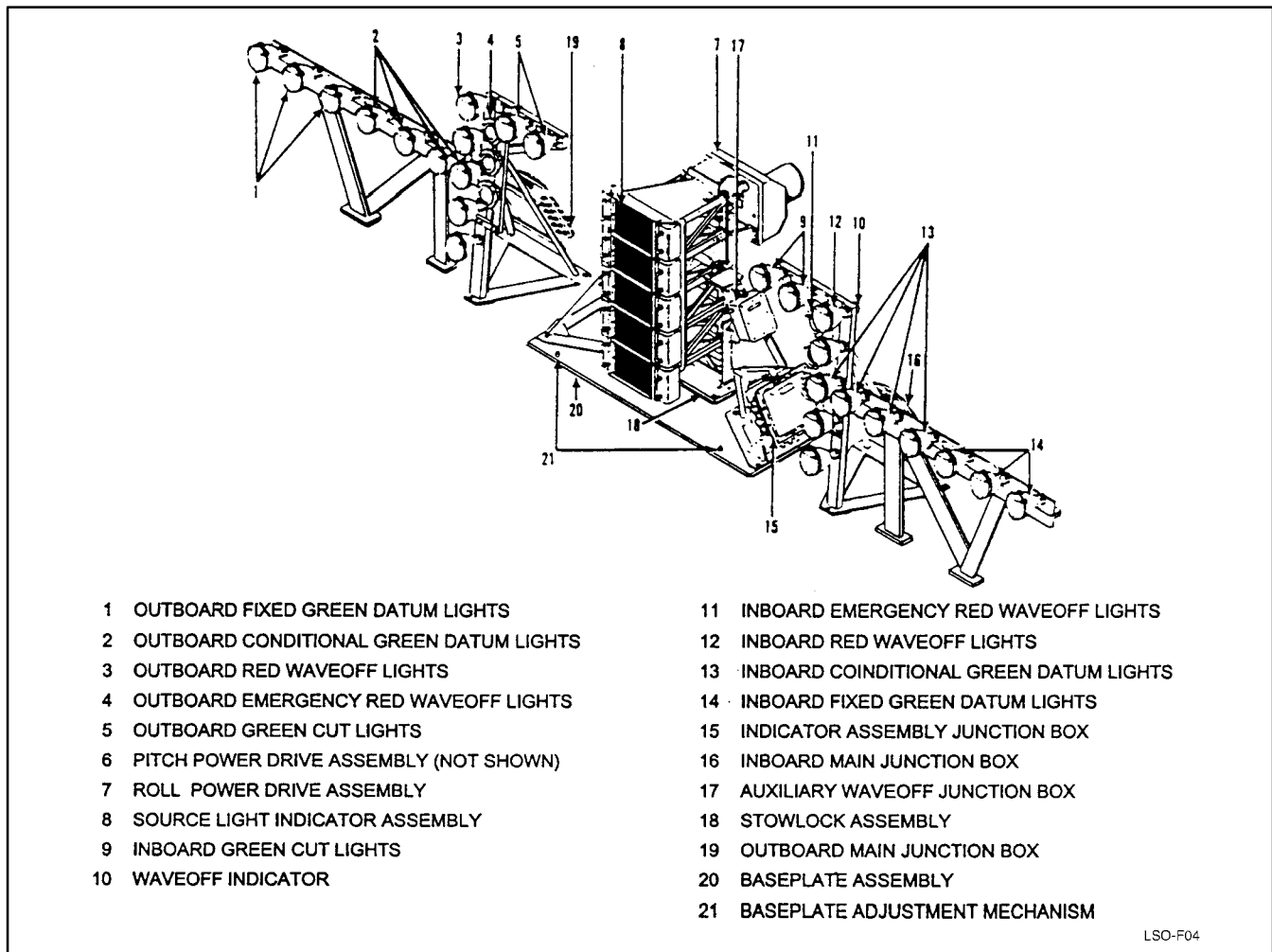

Figure 4-5. Deck-Edge Assembly (FLOLS)

Four waveoff lights (red) and three or four emergency waveoff lights (red) are mounted vertically on each side of the lens source lights. When a waveoff is initiated, the waveoff lights first flash at full intensity, then dim to the preset brightness. The emergency waveoff lights are on a separate circuit and act as a backup system to the normal waveoff lights.

Four horizontal cut lights (green) are located above the source lights (2 on each side). The cut lights are illuminated by means of a pushbutton on top of the LSO pickle switch (and by pushbuttons on all remote panels). The cut lights remain illuminated as long as the pushbutton is depressed; once released, the cut lights extinguish.

**4.2.5 Stabilization Modes.** The FLOLS stabilization computer receives signals from the ship's stable element to project a stabilized glideslope with respect to

the horizon under moving deck conditions. The following modes of FLOLS stabilization are employed.

**4.2.5.1 Line Stabilization.** Used as a backup to inertial mode, this mode stabilizes the FLOLS display for pitch and roll motions of the ship maintaining a predetermined line in space at the intersection of the FLOLS light plane and the true vertical plane through the centerline of the angled deck (Figure 4-6). This provides a completely stabilized glideslope referenced to the carrier deck, (glideslope moves with deck heave motion) as long as the pilot is on centerline of angled deck. Line mode is not stabilized for ship's heave (vertical displacement). Pilot perceived ball movement is because of ship's heave. Mode I's should be flown using line stabilization mode, inertial is acceptable.

**4.2.5.2 Inertial Mode of Stabilization.** The Primary mode of operation for the FLOLS. This Mode is

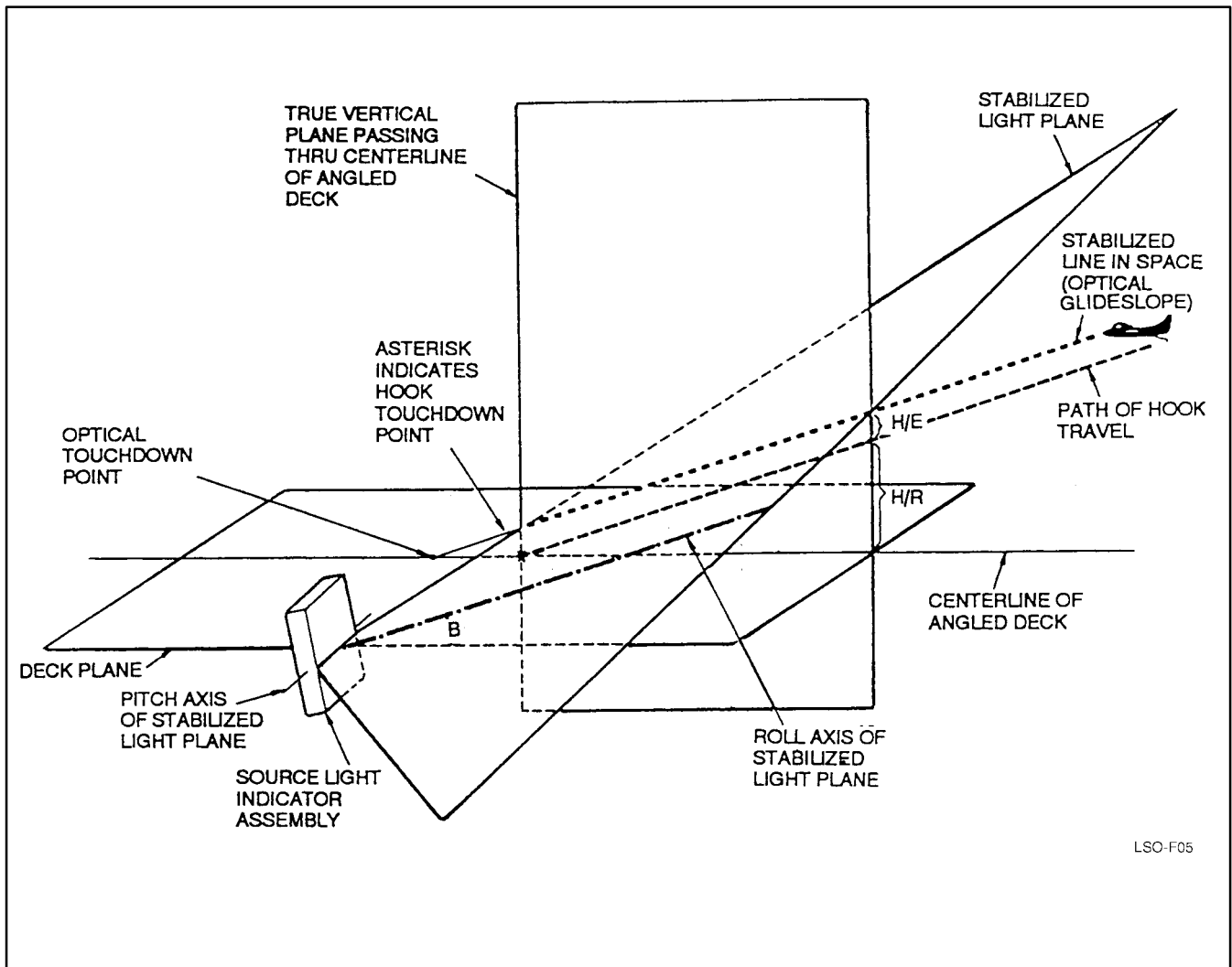

Figure 4-6. Geometry of Line Mode Stabilization

line stabilization with additional correction for ship's heave motion. It essentially stabilizes the glideslope regardless of carrier motion. The deck edge roll drive makes all corrections for heave stabilization. The pilot must be on the centerline of the angle to see a properly stabilized display. During heavy sea states (5/6) in inertial mode, the hook to ramp clearance and touchdown point indicators will occasionally display a negative or aft touchdown point respectively. The dynamic touchdown point varies more in inertial mode than it does in line mode. This is the sacrifice for a more stable light beam/glideslope for the pilots. A pilot on a perfect pass may hit any of the four wires, the ramp or bolter, depending on ramp motion and heave. At the moment of touchdown, the hook touchdown point will be displayed by the dynamic hook touchdown point indicator for a centered ball pass.

**4.2.5.3 Stabilization Limits.** Lens stabilization limits for the Mk 6 Mod 3 FLOLS are  $\pm 6^\circ$  pitch,  $\pm 10^\circ$  roll. It should be noted that in any discussion of deck motion and its associated effect on FLOLS, rate of pitch is just as important as amount of pitch. A moderate or even a small amount of pitch, normally within the stabilization capability of the FLOLS, can result in an unstabilized glideslope if the rate is rapid enough. The electric motor jackscrews in the FLOLS simply cannot position the roll and pitch of the lens box stack quickly enough when the deck excursions are rapid.

An additional stabilization feature limits the glideslope to a deck angle of not less than  $1^\circ$ . Thus, with a  $4^\circ$  basic angle, stabilization is limited to  $3^\circ$  stern ramp up ( $2.5^\circ$  on a  $3.5^\circ$  basic angle). In a typical pitching deck

situation, this limitation (vice stabilization limits) usually results in apparent lens lag.

**4.2.6 Effects of Deck Motion.** During flight operations, deck motion seldom exceeds  $\pm 1.5^\circ$  pitch,  $\pm 2.2^\circ$  in roll, and 5.5 feet in heave. Using basic geometry, each 1-foot aircraft vertical deviation from optimum glideslope moves the hook touchdown point forward or aft in the landing area by the following distances:

BASIC GLIDESLOPE ANGLE	DISTANCE IN FEET
3°	19.1
3.5°	16.4
3.75°	15.3
4°	14.3

Thus, 5.5 feet in heave will move the hook touchdown point  $\pm 90$  feet on a  $3.5^\circ$  glideslope. Note also that  $3^\circ$  of pitch ( $1.5^\circ$  up,  $1.5^\circ$  down), although not exceeding lens stabilization limits, equates to 24.1 feet of vertical ramp movement (based on CVN-71's 461-foot pitch axis to ramp distance).

**4.2.7 Effective Glideslope Due to Wind and Deck Motion.** The glideslope angle, referred to as the basic angle aboard ship, is the fixed pitch angle around which the lens assembly stabilizes. A basic angle setting of  $3.5^\circ$  is most commonly used, with  $4^\circ$  used for higher wind-over-deck conditions (38+ knots) or on the small decks when hook-to-ramp clearance is near the 10-foot minimum. In moderate wind-over-deck conditions (32 to 37 knots), a  $3.75^\circ$  basic angle may be desirable. In Figure 4-7, note that decreased closure rate of aircraft to ship caused by wind-over-deck reduces the actual glideslope flown (effective glideslope).

WIND OVER DECK (KNOTS)	BASIC ANGLE (DEGREES)	EFFECTIVE GLIDESLOPE*
35	4	3.2
30	3.5	2.8

\*Based on a 130-knot approach speed

Aircraft landing stress limits are predicated on moderate deck conditions. Extreme deck motion may significantly increase these landing stresses; the ramp

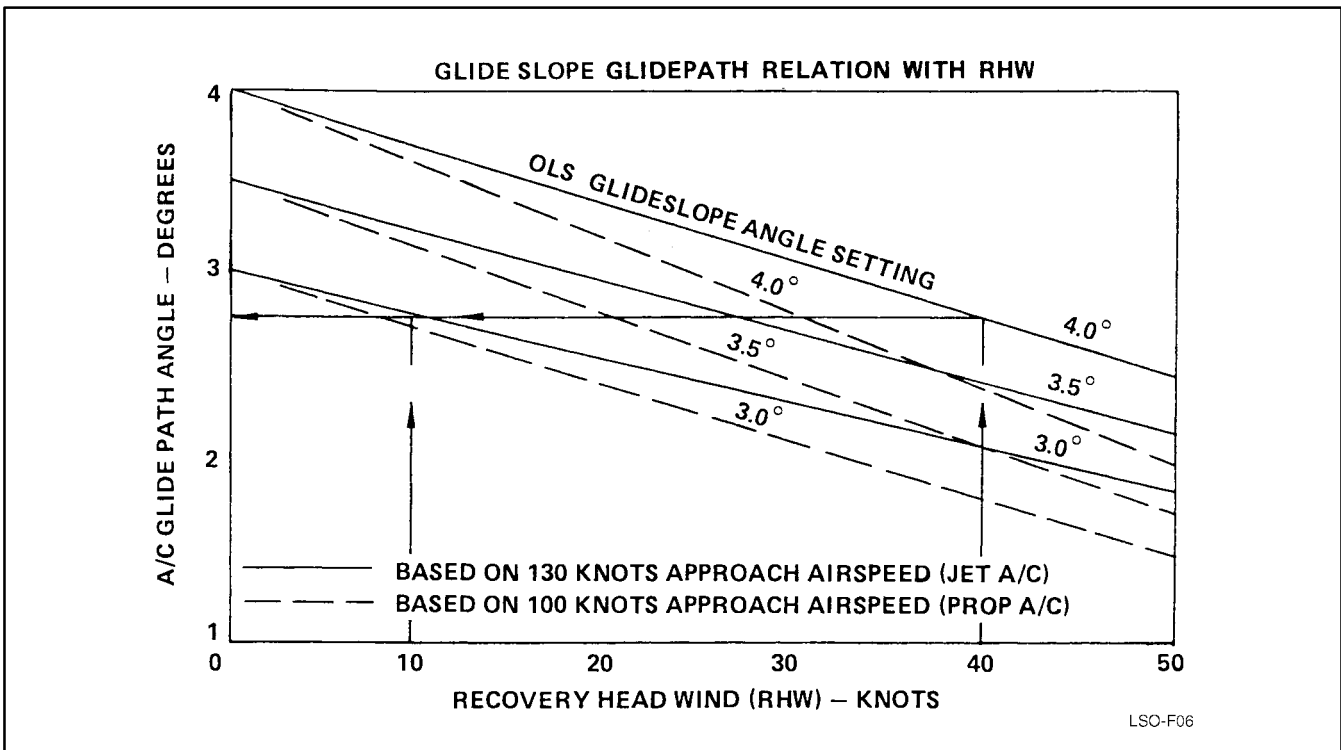

Figure 4-7. Glideslope Glidepath Relation with RHW

coming up at touchdown increases relative sink rate. Additionally, 1° of ramp down is the same as adding 1° to the glideslope as far as aircraft landing stresses are concerned. These deck motion factors are among the most critical to consider when landing aircraft on carriers.

During pitching deck conditions the aircraft hook may not engage the crossdeck pendant at the optimum angle. This may result in an apparent increase in the frequency of hook-skip bolters.

**4.2.8 Roll Angle and Hook-to-Eye.** The lens assembly may be tilted about two horizontal planes, at right angles to each other, the lens roll axis is parallel to the angle deck centerline, and the lens pitch axis is perpendicular to the angle deck centerline. The tilt in pitch, referred to as the basic angle, is seldom changed during a recovery (3.5°, 3.75°, or 4.0°) (Figures 4-8 and 4-9). Moving the lens about the roll axis rolls the light plane, causing the glideslope at the centerline of the landing area to be raised or lowered. This compensates for the various H/E distances to provide a constant hook path for all aircraft (Figure 4-10). H/E distance, which varies between aircraft, is the vertical distance

between the hook path and the pilot’s eye path relative to the carrier (Figure 4-11). Aircraft Recovery Bulletin No. 62-12 provides H/E values for all aircraft and configurations. These H/E values, along with basic angle, desired hook touchdown point, and ship’s static pitch/roll mistrim, are used by the FLOLS system to calculate and set the proper lens roll angle. Roll angles vary from 0 to 15 units. At 7.5 units of roll, the lens is vertical (zero tilt); at 15 units, the top of the lens is canted 7.5° outboard providing proper ramp clearance for the largest H/E aircraft. The selected basic angle will not change when the lens roll angle is increased or decreased.



Because of roll angle, extreme off-center approaches for aircraft with large H/E values may provide hazardous ramp clearance.

H/E values for most aircraft are such that the lens is upright or tilted outboard for normal configurations and normal hook touchdown points (a positive roll angle, greater than 7.5 units). No roll angle or basic angle settings are used for MOVLAS as the LSO manually

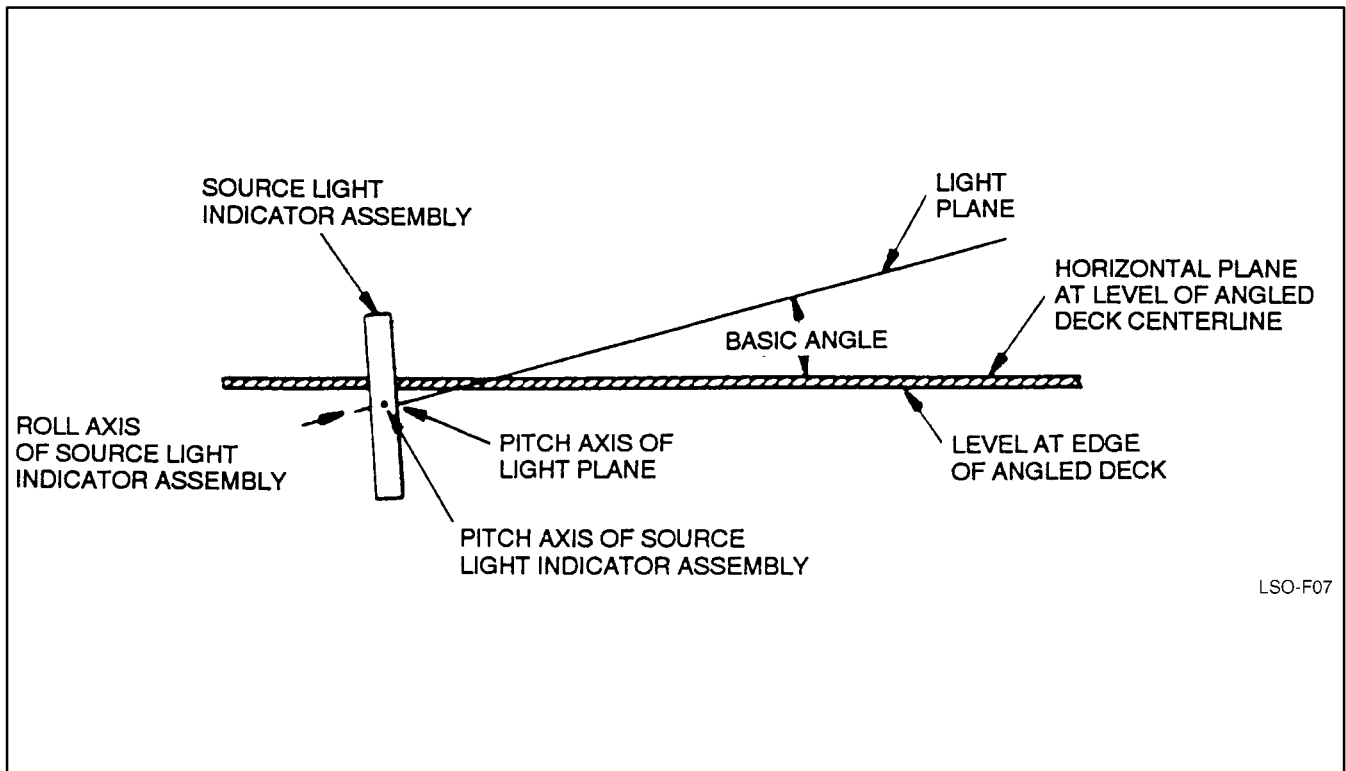

Figure 4-8. Determination of Basic Angle

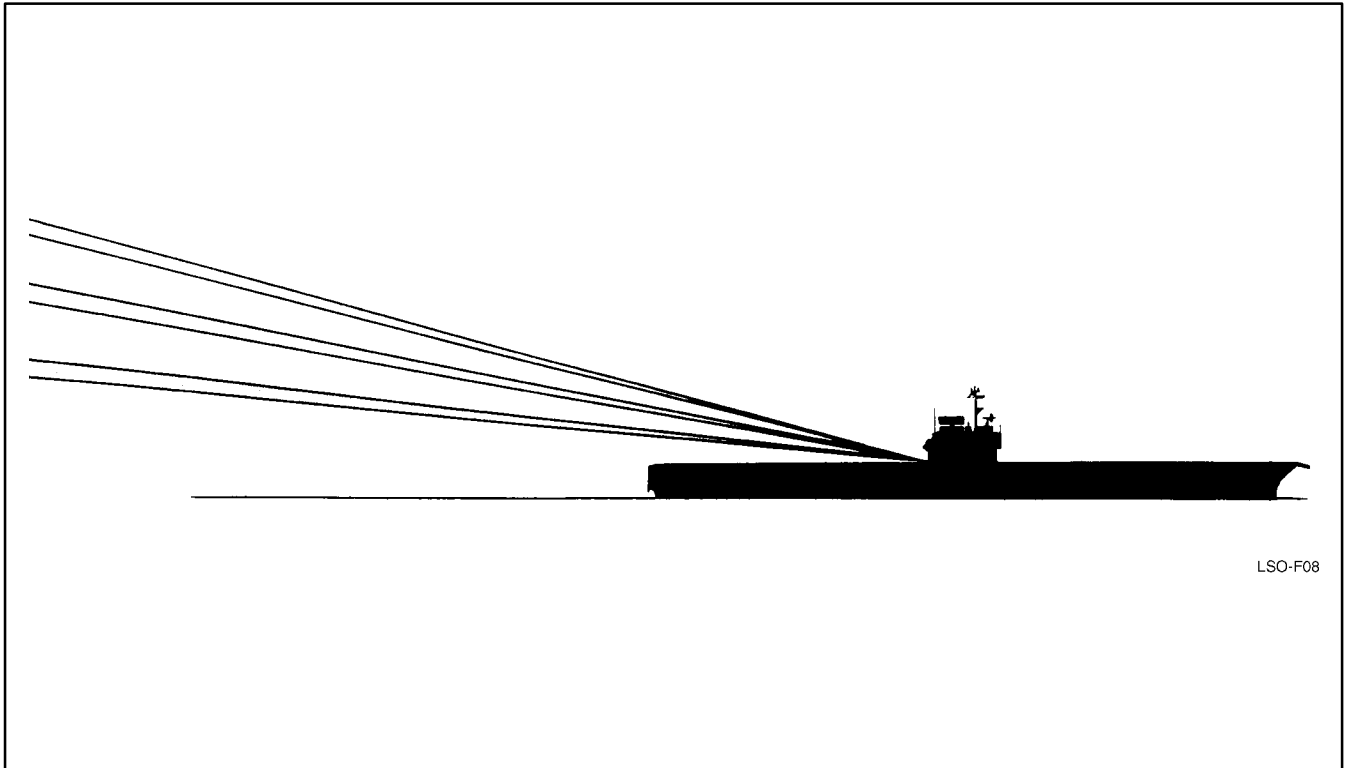

Figure 4-9. Effects of Pitch Angle (Basic Angle) Changes on Light Plane

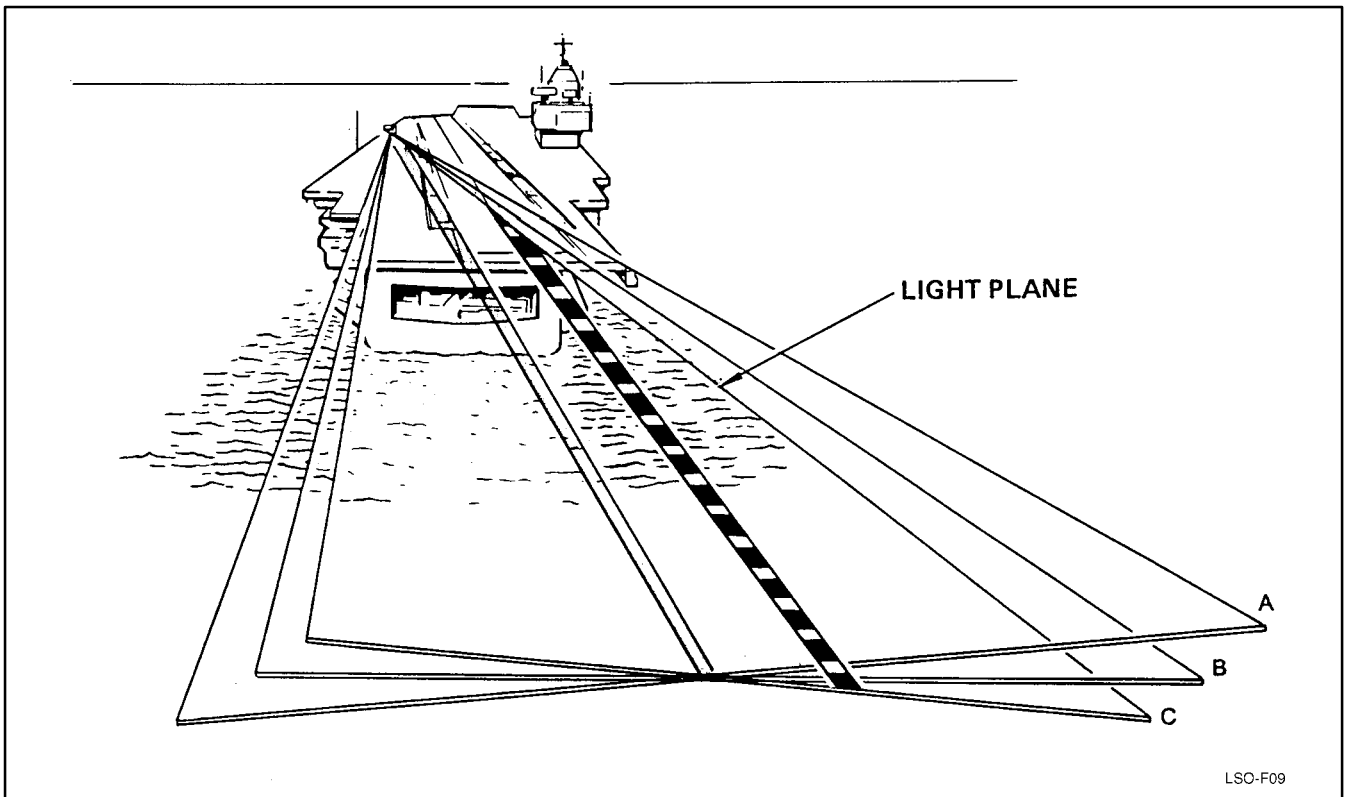

Figure 4-10. Effects of Hook-to-Eye Changes on Light Plane

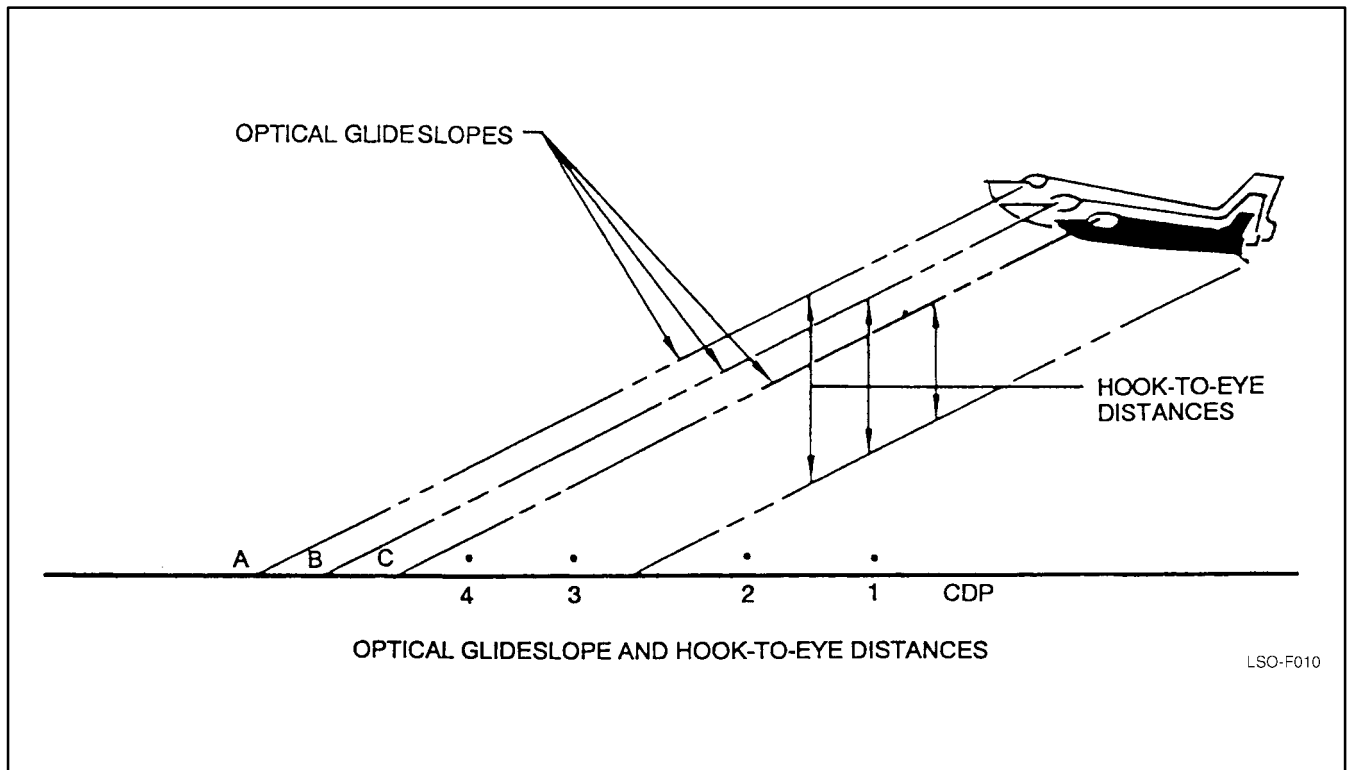

Figure 4-11. Optical Glideslope and Hook-to-Eye Distances

controls the ball to establish the proper glideslope. Most field optical landing systems use only basic angles; no roll angle adjustments are made, and each aircraft will have a different touchdown point based on its H/E value.

All published lens settings are intended to provide optimum hook glidepath, with a hook touchdown point halfway between the number two and three crossdeck pendants. Roll angle places the visual glideslope some distance above the hook glideslope which corresponds to each aircraft's H/E distance. H/E (in feet) is determined for each aircraft while properly configured, flying on-speed attitude, and with a centered ball. For many aircraft, a change in configuration will change H/E distance. H/E values for various configurations are specified in the Recovery Bulletins. If no preconfigured H/E pushbutton is available for the aircraft, configuration and adjustment for a nonstandard H/E must be made for FLOLS to provide the desired glide-path and hook touchdown point. Failure to maintain optimum aircraft attitude to touchdown may result in engagement of other than the targeted wire even with the aircraft on the visual glideslope (i.e., pilot sees a centered ball) at touchdown.

Deck centerline camber (i.e., the centerline is higher than the deck edge) is for water drainage. On most decks it is approximately 4 inches. All lens settings in the Recovery Bulletins compensate for deck camber.

### 4.3 MANUALLY OPERATED VISUAL LANDING AID SYSTEM

The Mk 1 Mod 2 MOVLAS is a backup shipboard visual landing aid system that is used when the primary optical system (FLOLS) is inoperable, when stabilization limits are exceeded, or for pilot/LSO training. The system presents glideslope information in the same visual form presented by the FLOLS system. There are three installation stations aboard ship (Figure 4-12):

**STATION 1:** Installation is immediately in front of the FLOLS and utilizes the FLOLS waveoff, datum, and cut light displays.

**STATION 2:** Installation is completely independent of the FLOLS. Because of cable resistance, it must be located on the port side not less than 75 feet nor more than 100 feet aft of the FLOLS assembly.



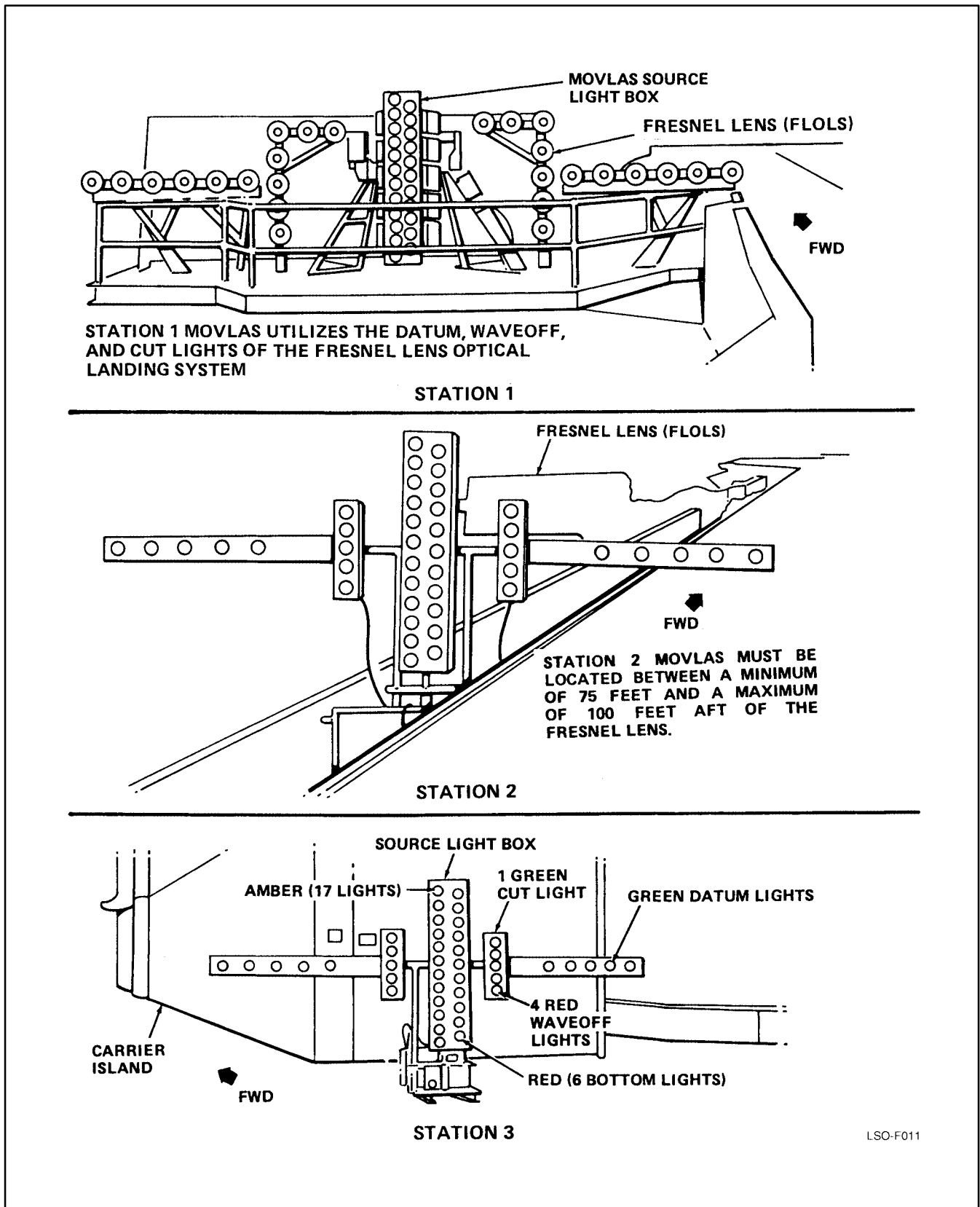

Figure 4-12. Manually Operated Visual Landing Aid System (MOVLAS) Mk 1 Mod 2 Shipboard, General Arrangement

STATION 3: Installation is mounted on a base assembly located on the flight deck on the starboard side. The approximate position is aft of the island and outboard of the safe parking line. The exact location can be determined by the air officer, LSO, or other cognizant personnel (i.e., CAFSUs). Utilization of this position may require on-deck aircraft movement.

**4.3.1 MOVLAS Construction.** The light box contains 23 vertically mounted lights that provide the meatball display. A set of perforated doors may be latched open or closed in front of the unit. When closed, the light intensity is decreased to approximately 3.5 percent of that with the shutters open. This doubles the range of light intensity control available from the power controller box and ensures adequate intensity range for day and night use. The bottom six lamps are red to provide coloring similar to the FLOLS low cell (they do not flash). Two toggle switches mounted on the LSO controller disable the lower and uppermost three lamps. With either switch in the disabled position, the controlling LSO can indicate to the pilot a glideslope position beyond the limits of the normal FLOLS system (i.e., ball off the top/bottom of the lens).

#### Note

Air wing policy should determine the position of the upper lamp enable switch. The lower lamp enable switch shall remain in the *Enabled On* position at all times.

For MOVLAS stations 2 and 3, a datum box unit is mounted on each side of the light box and contains five separate datum lamps, four waveoff lamps, and one cut lamp. The single perforated door is used to increase the range of intensity control for the waveoff and cut lights. Perforated doors are used for all lamps which are not continuously lighted to ensure sufficient line voltage across the filaments to light the lamp instantly.

The LSO controller is located at the LSO workstation. A handle on the controller enables the LSO to select the position of the meatball. The pickle switch is attached to the end of the controller handle. As the handle on the LSO controller is moved up or down, it lights three or four consecutive lamps in the light box, thus providing an LSO controlled meatball. Detents are located at the horizontal or centered ball position and near the bottom just prior to the red ball going off the bottom.

Independent controls are provided for intensity adjustment of the datum and source lights, with a combined control for the cut and waveoff lights. When activated, waveoff lights flash at a rate of 90 times a minute.

Because the controller detents proved inadequate in use, MOVLAS Service Change No. 13 added a repeater light box to the system. The repeater monitors every other light on the light box and allows the LSO to visually monitor the glideslope he is presenting to the pilot while facing the approaching aircraft (Service Change No. 13 also added the disable switch to the uppermost three lamps). A separate MOVLAS repeater is also integrated into the left side of the LSO HUD console. A small panel opens behind which there is a mirror that reflects the MOVLAS repeater image to the LSO.

Additional information about MOVLAS may be found in NAVAIR 51-40ACA-3 (Mk 2 Mod 2 land-based MOVLAS) or NAVAIR 51-40ACA-2 (Mk 1 Mod 2 shipboard MOVLAS).

## 4.4 LSO HEADS-UP DISPLAY

The Mk 1 Mod 0 LSO HUD console system (Figure 4-13) provides the LSO with real time aircraft, deck motion, deck status, and trend information in a consolidated display. It provides the LSO a dynamic visual display of all critical aircraft landing factors including range, rate of descent, true or closing airspeed, and lineup and glideslope data, as well as indicators of wind-over-deck relative to the landing area, clear/foul deck status, aircraft type, and approach mode. Ramp motion/ship's trim information is also available. A MOVLAS repeater, 21MC intercom, and two UHF radio barrel switch controls are also located on the console.

## 4.5 LSO BASE CONSOLE

The LSO Base Console (Figure 4-14), located to the right of the LSO HUD, consolidates several essential LSO equipment items. These include: the stabilization remote panel (A230A), FLOLS lighting remote control panel (A730A), radio set control panel (WSC-3), deck status light control panel, 19MC intercom panel or monitor, phone panel assembly, and a connector panel assembly with receptacles for sound powered phones, Aldis lamp, LSO handsets, and portable switch assemblies (pickle switches).

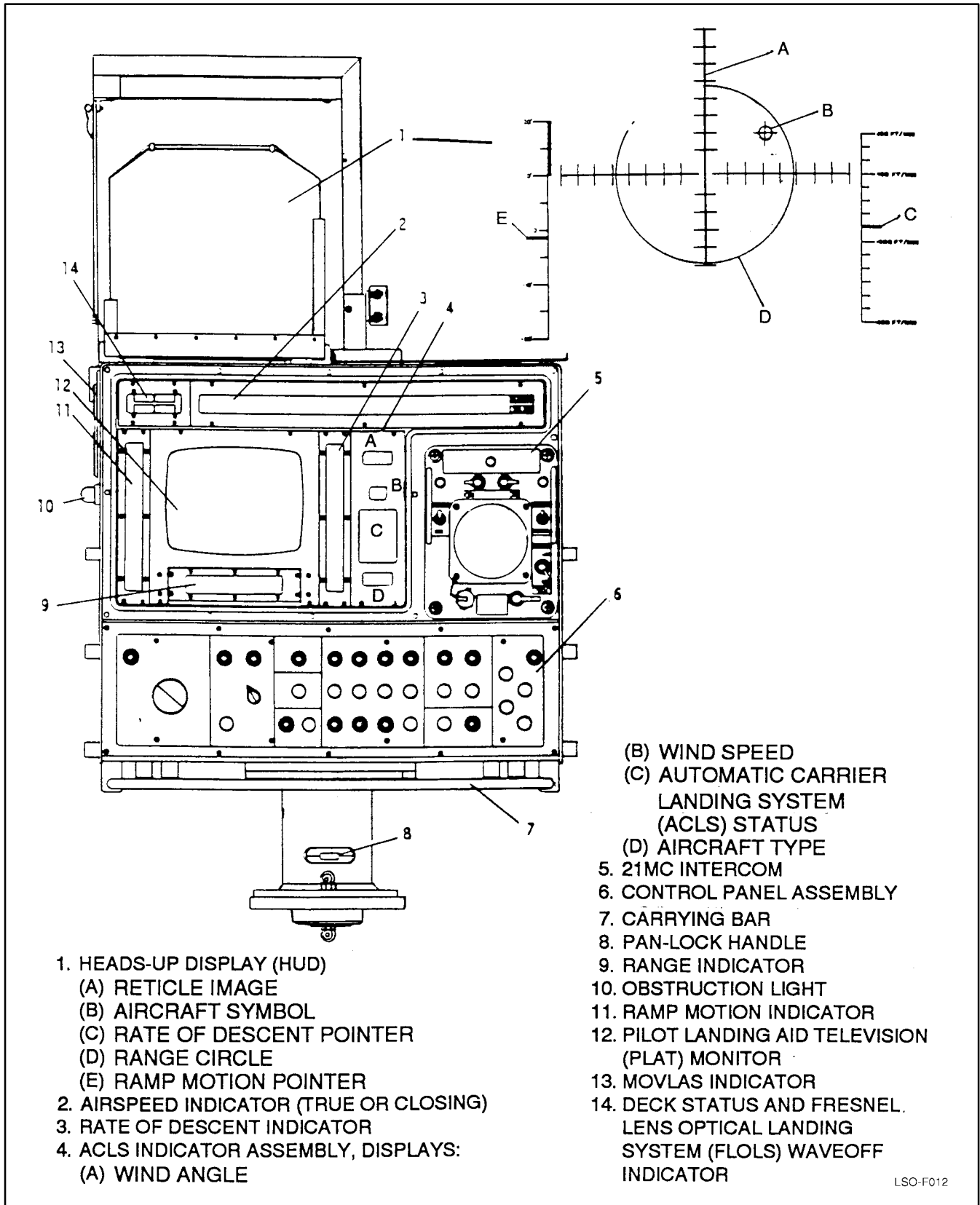
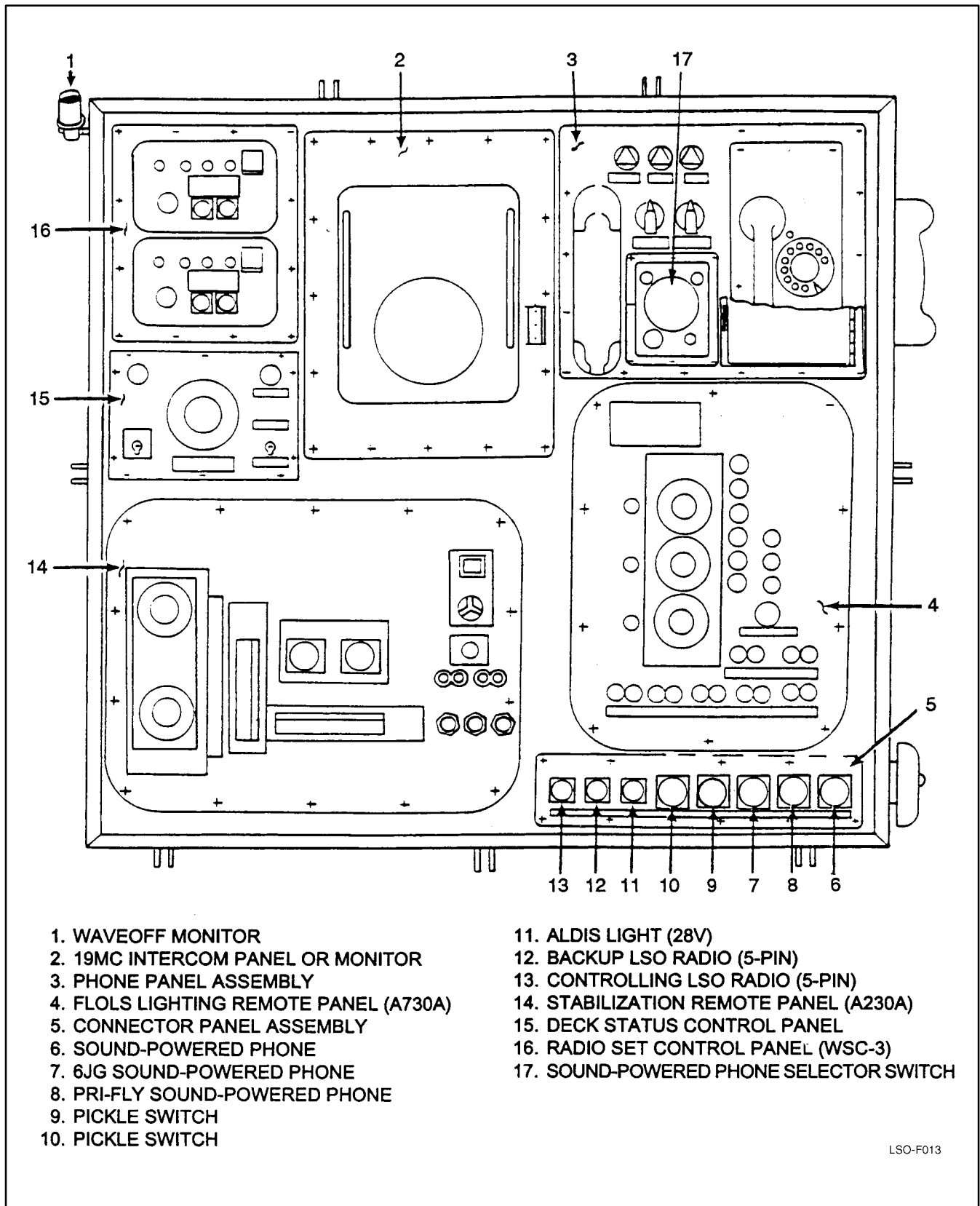

Figure 4-13. Mk 1 Mod 0 LSO Heads-Up Display (HUD) Console



- |  |   |
|--|---|
| 1. WAVEOFF MONITOR                     | 11. ALDIS LIGHT (28V)                   |
| 2. 19MC INTERCOM PANEL OR MONITOR      | 12. BACKUP LSO RADIO (5-PIN)            |
| 3. PHONE PANEL ASSEMBLY                | 13. CONTROLLING LSO RADIO (5-PIN)       |
| 4. FLOLS LIGHTING REMOTE PANEL (A730A) | 14. STABILIZATION REMOTE PANEL (A230A)  |
| 5. CONNECTOR PANEL ASSEMBLY            | 15. DECK STATUS CONTROL PANEL           |
| 6. SOUND-POWERED PHONE                 | 16. RADIO SET CONTROL PANEL (WSC-3)     |
| 7. 6JG SOUND-POWERED PHONE             | 17. SOUND-POWERED PHONE SELECTOR SWITCH |
| 8. PRI-FLY SOUND-POWERED PHONE         |   |
| 9. PICKLE SWITCH                       |   |
| 10. PICKLE SWITCH                      |   |

LSO-F013

Figure 4-14. LSO Base Console

The stabilization remote panel (A230A) (Figure 4-15) contains six indicators, including: a basic angle meter, commanded hook-to-ramp clearance indicator, commanded hook touchdown point indicator, ship trim angle meters (pitch/roll), and H/E meter (ship dependent).

The FLOLS lighting remote control panel (A730A) (Figure 4-16) provides LSO controls and indicators for datum, cut, and waveoff light intensity, low cell intensity, source light intensity, system go/no-go indicators, and pushbutton cut and waveoff light switches.

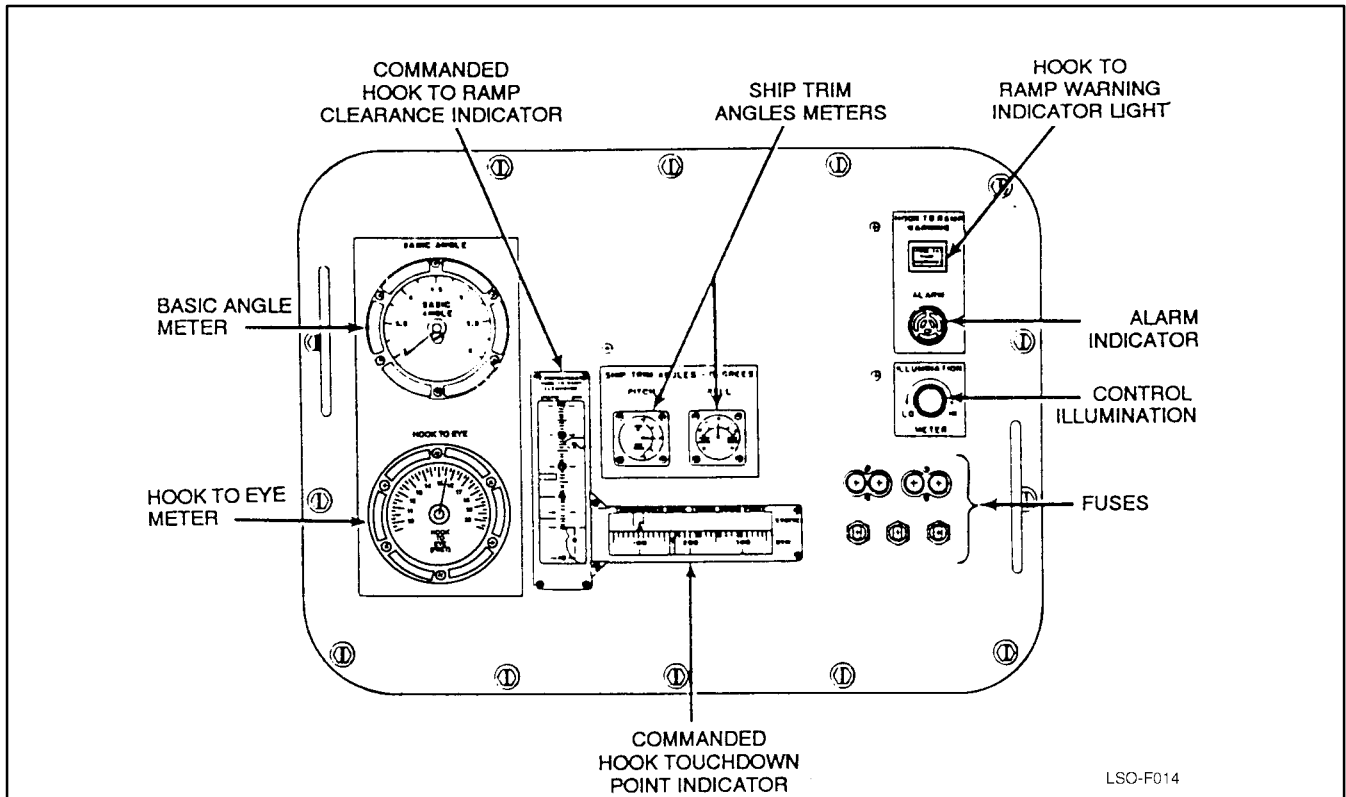

Figure 4-15. Stabilization Remote Panel (A230A)

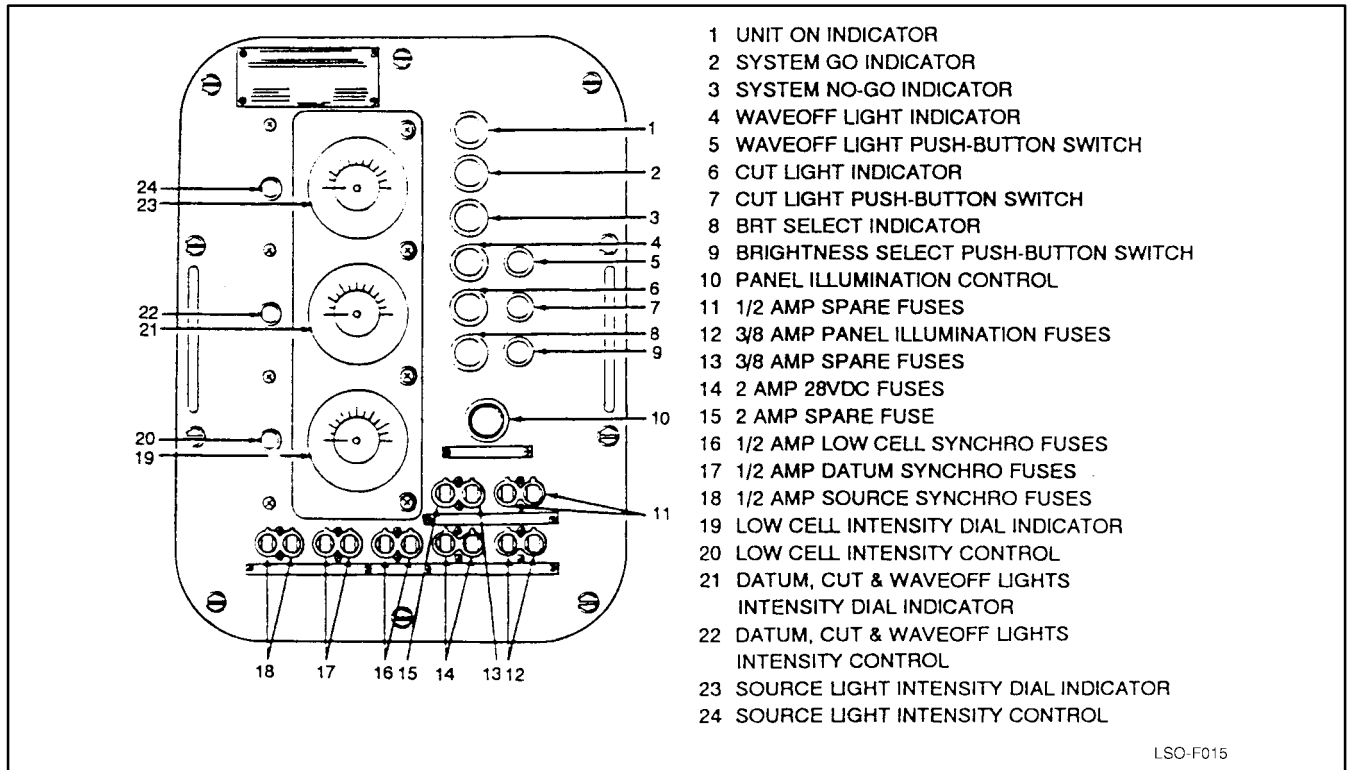

Figure 4-16. Lighting Remote Control Panel (A730A)

PART III

# Normal Procedures

Chapter 5 — Shore-Based Procedures

Chapter 6 — Shipboard Procedures





## CHAPTER 5

# Shore-Based Procedures

## 5.1 BRIEFING AND DEBRIEFING

**5.1.1 Precarrier Briefing.** The LSO shall ascertain that pilots/NFOs are thoroughly prepared in all respects for carrier landing operations.

The following subjects shall be covered by the LSO in briefings for pilots/NFOs prior to and, as deemed necessary, during carrier landing operations:

1. Carrier configurations
  - a. Recovery systems
    - (1) Fresnel lens, MOVLAS, LSO talkdown approaches, and ACLS procedures (if applicable)
      - (a) Systems design
      - (b) Capabilities
      - (c) Limitations
      - (d) Special procedures.
    - (2) Arresting gear and barricade
      - (a) Design
      - (b) Capabilities
      - (c) Limitations.
  - b. Deck configuration
  - c. PLAT/ILARTS
  - d. Deck, hull, and mast lighting system and control
2. Communications and communications discipline
  - a. Channelization
  - b. Voice reports.
3. Carrier operating procedures
  - a. Launch and departure procedures
    - (1) Deck procedures: Taxi/power considerations
    - (2) Catapult procedures
    - (3) Case I/II/III departure procedures
    - (4) Voice reports
    - (5) EMCON
    - (6) Launch emergencies: Ship, aircraft (consult aircraft NATOPS flight manual).
  - b. Check-in and marshal procedures
  - c. Approach procedures
    - (1) Case I/II/III
    - (2) CV-1/2/3 approaches
    - (3) Mode I/IA/II/III ACLS, ASR, self-contained approaches
    - (4) EMCON/ZIP LIP
    - (5) Downwind recovery
    - (6) Voice reports
    - (7) NORDO aircraft approaches.
  - d. VFR pattern
    - (1) Entry
    - (2) Break (interval)
    - (3) Downwind
    - (4) Abeam position
    - (5) Approach turn

- (6) Spin
- (7) Delta.
- e. Glideslope techniques
  - (1) Start position
  - (2) Airspeed/angle-of-attack control
  - (3) Lineup
  - (4) Glideslope error corrections
  - (5) Touchdown
  - (6) Effects of wind
  - (7) Effects of deck motion
  - (8) LSO calls (standard phraseology and responses)
  - (9) MOVLAS/pitching deck recovery.
- f. Bolter
- g. Waveoff
  - (1) Mandatory
  - (2) Own waveoff
  - (3) Technique.
- h. Night operations
  - (1) Lack of depth perception
  - (2) Radar altimeter
  - (3) Instrument scan/scan transition
  - (4) Aircraft lighting.
- i. Bingo procedures
  - (1) Fuel state
  - (2) Profile.
- j. Barricade procedures
  - (1) LSO-to-pilot 10-line barricade brief.
- k. Emergency procedures
  - (1) LSO equipment malfunction
  - (2) Ship equipment malfunction
  - (3) Aircraft emergencies
    - (a) Low fuel state
    - (b) Hook malfunction
    - (c) Brake failure
    - (d) Single engine/compressor stalls
    - (e) Landing gear malfunctions
    - (f) Launch bar/tow link malfunctions
    - (g) Ditching
    - (h) Fire
    - (i) Loss of canopy
    - (j) Flight control malfunctions
  - (k) Other emergencies from Section V of aircraft NATOPS flight manual.
- (4) Ejection.
- 4. Operations and air department briefings. The following areas should be briefed by cognizant operations and air department personnel prior to CV operations. Student naval aviators shall be briefed by the parent squadron LSO.
  - a. Deck handling procedures
  - b. Air operations procedures
  - c. Communications
  - d. Catapult launch procedures
  - e. CATCC procedures
  - f. SAR procedures.

**5.1.2 Simulator Procedures Briefing.** The LSO shall conduct a formal briefing with all pilots prior to simulator syllabus flights covering the procedures and training objectives to be accomplished.

**5.1.3 Conduct of Field Carrier Landing Practice Briefings.** The following subjects shall be covered by the LSO in lectures prior to and, as necessary, during FCLP training:

1. Fresnel lens, MOVLAS, LSO talkdown approaches, and ACLS procedures (if applicable)
  - a. Systems design, capabilities, and limitations
  - b. Special procedures.
2. Communications and communications discipline
3. General FCLP procedures
  - a. Course rules
  - b. Pattern, turns, and dimensions
  - c. Altitude control
  - d. Speed control and angle of attack
  - e. Attitude control
  - f. Lineup
  - g. Landing
  - h. Night procedures
    - i. APC control (if applicable)
    - j. Emergency procedures
    - k. LSO calls (standard phraseology and responses).
4. Specific FCLP procedures
  - a. Takeoff/entry
  - b. Climbout
  - c. Break (interval)
  - d. Upwind turn
  - e. Downwind leg
  - f. Landing checklist

- g. Abeam position: “(Modex), abeam, gear, (fuel state), (pilot’s name)”

**Note**

If unable to call “Abeam, gear” (e.g., gear in transition or aircraft on the ball), make the gear call prior to the ball call on the first pass.

- h. Approach turn
- i. Voice report (at normal meatball acquisition position)
  - (1) Modex number
  - (2) Type aircraft
  - (3) Ball or Clara
  - (4) Fuel state (nearest 100 pounds)
  - (5) Auto (if applicable).
- j. Glideslope and entry
- k. Glideslope technique
  - l. Landing
- m. Waveoff
  - (1) Mandatory (including test/close-in waveoff)
  - (2) Own waveoff
  - (3) Techniques involved.
- n. Aircraft lighting (determined by local conditions)
- o. Charlie procedures
- p. Bingo procedures
- q. Loss of LSO radio or two-way communications
- r. NORDO aircraft procedures.

**5.1.4 Postsimulator/Postflight Debriefing.**

The LSO shall debrief each pilot as soon as practicable following each simulator or FCLP flight regarding procedures and landing performance during the period. The LSO should use this debriefing to discuss any

significant trends in landing performance and recommended corrective action.

## 5.2 SIMULATOR TRAINING

Carrier landing simulators shall be used to the maximum extent practicable in preparation for shipboard operations. The LSO shall develop a simulator syllabus to supplement FCLP training and reinforce precarrier briefing material. Each pilot should complete the simulator syllabus prior to carrier operations.

### 5.2.1 CV Approach/Departure Procedures.

The simulator training syllabus should include, at a minimum, one complete case III departure, marshal, ACLS approach, and recovery. Loss of radio procedures should be reviewed and executed. Environmental conditions should be varied and the pilot should be required to execute both precision and nonprecision approaches to minimums.

**5.2.2 Emergency Procedures.** The carrier landing simulator syllabus should include emergency procedures training in the following areas:

1. **NORDO** (in all phases of flight)
2. Loss of navigation aids
3. Common aircraft emergencies (peculiar to aircraft type)
4. Aircraft emergencies/abnormal configurations affecting landing performance
5. Shipboard casualties (i.e., failure of navigation aids, drop lights, lens, etc.)
6. Pitching deck recovery
7. Computation of Bingo fuel requirements and execution of Bingo profile.

## 5.3 FCLP

Field carrier landing practice is defined as that phase of required flight training that precedes carrier landing operations. It should simulate, as nearly as practicable, the conditions encountered during carrier landing operations.

**5.3.1 Personnel Requirements.** A qualified LSO shall be on station for all day FCLP operations. For night operations, the qualified LSO shall have an assistant (not necessarily an LSO or pilot) present whenever more than two aircraft are in the FCLP pattern.

### 5.3.2 Traffic Pattern Control Responsibilities.

Although tower personnel may be responsible for control of aircraft entering and departing the FCLP pattern and non-FCLP aircraft during concurrent operations, the LSO shall monitor all aircraft in the pattern to ensure proper interval and adherence to briefed FCLP pattern procedures.

**5.3.3 Preflight Briefing.** Pilots shall be briefed prior to each FCLP period in accordance with the NATOPS flight manual. The following items are to be included:

1. Takeoff and recovery time
2. Weather briefing
3. Alternate Bingo field
4. Formation procedures
5. Traffic rules and terrain of bounce field
6. Pattern
7. Gross weight limitations
8. Radio discipline
9. Lost communication procedures
10. Field lighting
11. Alternate approach procedures
12. Emergencies
13. Type of field arresting gear and location
14. Waveoff/lineup response
15. No acknowledgment of "ball" call
16. Final recovery instructions
17. Debrief arrangements.

**5.3.4 Conduct of FCLP.** The following equipment checks shall be made by LSOs prior to FCLP operations:

1. Functional check of visual landing aids (cut and waveoff lights, pole check, intensity, etc.)
2. All lighting facilities for proper operations
3. Radios
4. Aldis lamp or spotlight (night only).

Each pilot shall have demonstrated proficiency in the following:

1. Waveoff — at least one waveoff (technique or test) per FCLP period.
2. Lineup response — at least one test of lineup response per FCLP period.
3. Simulated shipboard radar controlled approaches should be practiced during at least one night FCLP period. Where applicable, FCLP in conjunction with shore-based SPN-42 is highly desirable to familiarize pilots with procedures from an ACLS to visual approach.
4. NORDO approaches — including proper response to cut lights and waveoff lights.
5. MOVLAS approaches.
6. Aircraft simulated emergency approaches.
7. Pilot response to no verbal or visual acknowledgment of the ball call should be frequently tested during FCLP.

#### **Note**

Conduct of FCLP during deployed operations with less than the minimum prescribed equipment may be conducted at the discretion of the senior cognizant LSO.

## **5.4 PILOT PERFORMANCE EVALUATION**

### **5.4.1 Minimum Number of FCLP Periods.**

Chapter 6 establishes the requirement for FCLP refresher prior to carrier operations when a pilot has not made a CV landing in over 30 days. The number of FCLP periods (and total number of FCLP landings) required to prepare a pilot for CV landings will vary with individual pilot skills, experience, and currency in aircraft type. The senior command LSO should submit to the commanding officer, via the operations officer, a list of anticipated FCLP requirements for each pilot prior to commencing precarrier deployment training. This list should also include simulator requirements. These requirements should be adjusted as necessary according to individual performance. The senior command LSO is ultimately responsible for certifying to the commanding officer that an individual is prepared for CV flight operations.

**5.4.2 FCLP Performance Records.** Fleet squadrons shall maintain records of all squadron pilot FCLP landings from the beginning of shore-based operations until the end of the next extended deployment.

### **5.4.3 LSO Certification of Pilot Performance.**

FCLP training shall be completed to the satisfaction of the senior air wing LSO (senior command LSO, if not assigned to an air wing) prior to carrier qualification. During this training period, the pilot should demonstrate his ability to operate with appropriate configurations and simulated emergency conditions. When this has been completed, an oral or written recommendation shall be submitted by the senior LSO to the pilot's commanding officer certifying pilot day/night FCLP qualification. In the case when 60 days have elapsed since a pilot's last CV landing, the senior command LSO shall submit a memorandum to the appropriate staff/type LSO certifying day/night readiness of pilot(s) to include the number of FCLP periods (day/night) and number of carrier related simulators. Reciprocal acceptance between commands of FCLP qualification and LSO certification is authorized. The senior LSO shall recommend revocation of a certification at any time a pilot's standard of performance is less than satisfactory.



## CHAPTER 6

# Shipboard Procedures

## 6.1 BRIEFING AND DEBRIEFING

**6.1.1 Carrier Qualification/Currency Landing Procedures Briefing.** The carrier configurations, communications and communications discipline, and carrier operating procedures outlined in the precarrier briefing discussed in [Chapter 5](#) shall be completed within 10 days of carrier qualification/currency carrier landings.

**6.1.2 Postflight Debriefing.** The controlling LSO shall debrief pilots as soon as practicable after all carrier landings. During carrier qualification and currency carrier landing evolutions, the LSO should debrief each pilot, if practicable, concerning his day landing performance prior to night carrier landings.

**6.1.3 Pilot Landing Trend Debriefs.** The LSO shall periodically debrief each pilot concerning his carrier landing trends. Debriefs should be annotated on the pilot's Carrier Landing Trend Analysis sheet (OPNAV Form 3760/7 1) or APARTS-generated trend analysis forms. For squadrons or detachments cross-decking, the departing air wing staff LSO shall ensure the relieving air wing staff LSO receives trend analyses and written debriefs on all pilots in that squadron or detachment.

**6.1.4 Recurrent CV Procedures Training.** The LSO should conduct CV procedure training periodically during extended carrier deployments. The training should include, at a minimum, the following portions of the precarrier briefing discussed in [Chapter 5](#).

1. Carrier configurations
2. Communications and communications discipline
3. Carrier operating procedures.

**6.1.5 Special Operations Procedures Briefing.** The LSO is responsible for briefing procedures pertinent to special carrier recovery operations (day/night EMCON, E-2 controlled approach, etc.).

## 6.2 CARRIER QUALIFICATIONS

### 6.2.1 Definitions

1. Initial carrier qualifications — Pilot's first day/night carrier qualification.
2. Requalification — Pilot's day/night currency exceeds 12 months in type/model/series. Initial carrier qualification requirements apply, unless otherwise specified in [paragraph 6.2](#).
3. Transition carrier qualification — First day/night carrier qualification in type/model/series aircraft for aviators that have previously completed initial day/night carrier qualification in another type/model/series aircraft (e.g., F-14 to F/A-18). Initial carrier qualification requirements apply, unless otherwise specified in [paragraph 6.2](#). Transition requirements between various series within a type/model/series (e.g., F-14A to F-14B) shall be determined by the cognizant typewriting/FRS with Force LSO concurrence.
4. Currency — Pilot meets the currency requirements of [Figure 6-1](#).

#### 6.2.1.1 Minimum Landings for Initial, Transition, and Requalification

##### 6.2.1.1.1 Day Qualification

1. Twelve landings, ten of which shall be arrested.

##### 6.2.1.1.2 Night Qualification

1. Eight landings, six of which shall be arrested.

#### Note

A pilot attempting initial night qualification shall fulfill all requirements for initial qualification even though he may have previously completed day qualification only.

DAY					
DAYS SINCE LAST DAY CURRENT	REQUIREMENTS PRIOR TO A DAY LANDING	WEATHER	DECK	DIVERT FIELD	CURRENCY REQUIREMENT
1-14 days	FCLP not required	Ships mins	ALL conditions	N/R	1 arrested landing
15-29 days	FCLP refresher at the discretion of the C.O.	TACAN mins	Relatively steady <sup>(1)</sup> , or	Divert available	1 arrested landing
30-59 days	FCLP refresher <sup>(2)</sup>	TACAN mins	Relatively steady <sup>(1)</sup> , or	Divert available	1 arrested landing
60 days to 6 months	FCLP refresher <sup>(2)</sup>	TACAN mins	Relatively steady <sup>(1)</sup> , and	Divert available	4 landings 2 shall be arrested <sup>(8)</sup>
Dual F/A-18A-D and F/A-18 E/F qualification currency <sup>(11)</sup>	FCLP refresher <sup>(2)</sup>	TACAN mins	Relatively steady <sup>(1)</sup> , and	Divert available	4 landings in the least current series, 2 shall be arrested. 1 additional arrested landing in the other series if not already current
6-12 months	FCLP refresher <sup>(2)</sup>	700/3	Relatively steady <sup>(1)</sup> , and	Divert available	4 landings 2 shall be arrested <sup>(8)</sup>
Dual F/A-18A-D and F/A-18 E/F qualification currency <sup>(11)</sup>	FCLP refresher <sup>(2)</sup>	700/3	Relatively steady <sup>(1)</sup> , and	Divert available	4 landings in the least current series, 2 shall be arrested. 1 additional arrested landing in the other series if not already current
Greater than 12 months	Refer to initial qualification				Refer to initial qualification
NIGHT <sup>(3)</sup>					
DAYS SINCE LAST NIGHT CURRENT	REQUIREMENTS PRIOR TO A NIGHT LANDING OR NIGHT CAT SHOT <sup>(6, 7, 9)</sup>	WEATHER	DECK	DIVERT FIELD	CURRENCY REQUIREMENT
1-7 days	None	Ships mins	ALL conditions	N/R	1 arrested landing (T/G or arrested) <sup>(10)</sup>
8-14 days	1. One day landing that day to include a day cat shot  OR 2. Two day landings, one of which shall be arrested, one day cat shot and not less than one hour of flight time within a 36 hour period prior to the night landing	TACAN mins	ALL conditions	N/R	1 arrested landing (T/G or arrested) <sup>(10)</sup>
Dual F/A-18A-D and F/A-18 E/F qualification currency <sup>(11)</sup>	3. None, if the aircrew has had one night arrested landing in the other series in the previous 7 days.			N/A	

Figure 6-1. Operating Criteria for Qualified Pilots (Sheet 1 of 3)



NIGHT <sup>(3)</sup> (Cont.)					
DAYS SINCE LAST NIGHT CURRENT	REQUIREMENTS PRIOR TO A NIGHT LANDING OR NIGHT CAT SHOT <sup>(6, 7, 9)</sup>	WEATHER	DECK	DIVERT FIELD	CURRENCY REQUIREMENT
15-21 days	1. Two day landings, one of which shall be arrested, within a 36 hour period prior to the night landing. This shall include one cat shot <sup>(4)</sup> in the day light hours preceding the night landing, and not less than 1 hour of flight time (day or night).	TACAN mins	Relatively steady <sup>(1)</sup> , or	Divert available	1 arrested landing
Dual F/A-18A-D and F/A-18 E/F qualification currency <sup>(11)</sup>	2. Two day landings, in that series, one of which shall be arrested, within 36 hour period prior to the night landing. This shall include one cat shot <sup>(4)</sup> in the day light hours preceding the night landing, and not less than 1 hour of flight time (day or night).	TACAN mins	Relatively steady <sup>(1)</sup> , or	Divert available	1 arrested landing
22-29 days	1. Two day landings, one of which shall be arrested, within a 36 hour period prior to the night landing. This shall include one day cat shot <sup>(4)</sup> in the day light hours preceding the night landing, and not less than 1 hour of flight time (day or night).	TACAN mins	Relatively steady <sup>(1)</sup> , or	Divert available	1 arrested landing
Dual F/A-18A-D and F/A-18 E/F qualification currency <sup>(11)</sup>	2. Once current in one series refer to the 8-14 days, requirement 1 or 2 for the other series.	N/A			
30-59 days	1. Four day landings, two of which shall be arrested, within a 48 hour period prior to the night arrested landing. This shall include a cat shot <sup>(4)</sup> and arrested landing during the daylight hours immediately preceding the night landing, and not less than 1 hour of flight time (20 minutes of which should be at night).	700/3	Relatively steady <sup>(1)</sup> , and	Divert available	1 arrested landing
Dual F/A-18A-D and F/A-18 E/F qualification currency <sup>(11)</sup>	2. Once current in one series refer to the 8-14 days requirements 1 or 2 for the other series.	N/A			
60 days to 6 months	Four day landings, two of which shall be arrested, within a 48 hour period prior to the night arrested landing. This shall include a cat shot <sup>(4)</sup> and arrested landing during the daylight hours immediately preceding the night landing, and not less than 1 hour of flight time (20 min. of which should be at night).	700/3	Relatively steady <sup>(1)</sup> , and	Divert available	2 arrested landings
6 to 12 months	Four day landings, two of which shall be arrested, within a 48 hour period prior to the night arrested landing. This shall include a cat shot <sup>(4)</sup> and arrested landing during the daylight hours immediately preceding the night landing, and not less than 1 hour of flight time (20 min. of which should be at night).	1000/3 <sup>(5)</sup>	Relatively steady <sup>(1)</sup> , and	Divert available	4 landings 2 shall be arrested <sup>(10)</sup>

Figure 6-1. Operating Criteria for Qualified Pilots (Sheet 2)

NIGHT <sup>(3)</sup> (Cont.)					
DAYS SINCE LAST NIGHT CURRENT	REQUIREMENTS PRIOR TO A NIGHT LANDING OR NIGHT CAT SHOT <sup>(9)</sup>	WEATHER	DECK	DIVERT FIELD	CURRENCY REQUIREMENT
Greater than 12 months	Refer to initial qualification.				

Subj: NOTES FOR PILOT CURRENCY REQUIREMENTS ICO LSO NATOPS **FIGURE 6-1**

Note 1 — Relatively steady deck is defined as less than 6 feet of ramp movement at the centerline (i.e., ±3 feet change in hook-to-ramp).

Note 2 — See Pilot Performance Evaluation in [paragraph 5.4](#).

Note 3 — For currency purposes, a landing within 1/2 hour of sunset shall not be counted as a night carrier landing unless it is quite dark due to cloud coverage.

Note 4 — For multi-piloted aircraft with two aviators qualified in model at the controls, catapult launches may be counted by both pilots for refresher catapult shot criteria.

Note 5 — May be waived to 700/3 by OTC.

Note 6 — Day requirements are good for 36 hours after first night arrested landing.

Note 7 — A fleet experienced aviator whose intention is not to CQ may take a night cat shot if he has completed one day landing and one cat shot during the 48 hours preceding the night cat shot, or 4 day landings within 72 hours.

Note 8 — Currency requirements must be completed prior to any landings with passengers.

Note 9 — The requirement for 1 hour of flight time does not apply to the night cat shot.

Note 10 — Night T/G landings are not recommended for currency unless operational necessity dictates.

Note 11 — See Dual F/A-18A-D and F/A-18E/F qualification requirements on [page 6-6, paragraph 6.3.1, Step 10](#).

Figure 6-1. Operating Criteria for Qualified Pilots (Sheet 3)

**Note**

- Night touch-and-go's are for CAT I initial carrier qualification and not intended for pilots who have night carrier qualified before, nor are they to be utilized for refresher/currency where not specifically authorized in **Figure 6-1**. Any touch-and-go is required to be a satisfactory pass in which an arrestment would normally occur. For aviators that have previously been night carrier qualified in any type/model/series aircraft, qualification requirements shall be reduced from eight landings to six arrested landings.
- Initial and transition qualification shall be conducted by a designated training LSO for that type/model/series aircraft. This requirement may be waived

by the type commander to utilize a designated staff LSO. Requalification of a fleet-experienced aviator may be conducted by a designated staff LSO.

- Wing-qualified LSOs assigned to the Naval Strike Test Squadron, Patuxent River, are authorized to conduct day-only transition carrier qualification and/or re-qualification of test pilots in lieu of a training qualified LSO.

**6.2.1.2 Waiver Criteria.** The minimum requirements listed above may be waived by the type commander or his designated representative to not less than four day and four night arrested landings for fleet-experienced aviators.\* This waiver will be judiciously granted, contingent upon pilot experience, demonstrated performance, and only upon recommendation of the squadron LSO.

\*The term fleet-experienced aviators applies to individuals who have been carrier qualified and operationally current in the same model aircraft within the last 4 years.

**6.2.1.3 Training Command Instructors and Students.** As prescribed by Chief of Naval Air Training.

### 6.2.2 Limitations for Initial Carrier Qualifications

1. A qualifying pilot shall not exceed in any period of continuous flight duty (crew day), as defined by OPNAVINST 3710.7 series:
  - a. Ten arrested landings
  - b. Four night arrested landings
  - c. Six and one-half hours in the cockpit

#### Note

For E-2 and C-2 aircraft, the 6.5-hour rule shall apply to left-seat time (pilot at the controls) only.

- d. Three flights.

#### Note

A flight begins with the first field takeoff or carrier catapult launch and ends when (1) the pilot makes his last arrested landing on the carrier in that aircraft, or (2) makes a full stop landing at a field facility. A CQ period that ends with a divert or bingo shall be counted as one flight.

2. No longer than 5 days should elapse between the last FCLP period and the first carrier landing. When qualification will occur on board a carrier with IFLOS installed, a minimum of three **IFLOLS** FCLP periods shall be flown prior to any carrier landing.
3. Provided other operational limitations have not been exceeded and upon the recommendation of the controlling LSO, the carrier commanding officer may waive daily landing limitations for pilots who have been previously night qualified in any T/M/S to the following:
  - a. Total arrested landings: 12
  - b. Total night arrested landings: maximum of 6.

4. A minimum of eight day landings, six of which shall be arrested, shall be completed prior to a pilot participating in night carrier qualification. Following completion of the required minimum day landings, the LSO may recommend to the carrier commanding officer that the pilot participate in night qualification landings. Participation in night qualification landings in no way represents pilot day qualification. The minimum arrested landings for initial qualification remain 10 day and 6 night. If the controlling LSO considers that a pilot's performance warrants additional landings, such recommendation shall be made to the carrier commanding officer.
5. A minimum of two carrier landings, at least one of which shall be arrested, the other a successful touch and go (no bolters), and one catapult launch shall be completed during the daylight hours preceding night qualification landings. After completing the first night qualification landing, fleet experienced aviators\* will be considered to have satisfied this requirement for a period not to exceed 36 hours for subsequent night carrier qualification. The 36-hour rule does not apply to CAT I pilots.
6. Carrier qualification should be completed within a 30-day period.
7. During the first night of initial night qualification, qualifying pilots shall have a minimum of 20 minutes of flight time prior to their first night landing of that night. This requirement is optional on subsequent nights.
8. Carrier qualification for fixed-wing aircraft shall be conducted within divert range of a suitable shore facility airfield with not less than circling minimums. If any part of the descent is **IFR**, sufficient fuel must be included for a standard instrument penetration and approach. It is the responsibility of each participating unit to guarantee that valid Bingo information for their particular aircraft is available and in use aboard the carrier.
9. All night carrier aircraft operations shall be CATCC controlled.
10. Multiplace carrier aircraft shall carry only a minimum flightcrew aboard during carrier qualification landings. Qualification landings shall not

be conducted with qualifying pilots aboard other than the pilot and/or copilot, unless dictated by operational necessity, except for necessary transportation to/from the ship.

11. For qualification purposes, a landing within one-half hour of sunrise or sunset shall not be counted as a night carrier landing unless it is quite dark (e.g., because of cloud coverage). The senior cognizant LSO shall make this determination.
12. Carrier qualifications shall normally be conducted with a minimum ceiling of 1,000 feet and 3 statute miles visibility. When authorized by the OTC, carrier qualification landings may be conducted with a ceiling of not less than 700 feet and not less than 3 statute miles visibility.
13. Carrier qualification should not be conducted with recovery headwinds less than 20 knots or greater than 40 knots.
14. Deck movement shall not exceed  $\pm 3$  feet of ramp motion. The decision to continue qualification landings when deck motion exceeds  $\pm 3$  feet rests with the carrier commanding officer and senior LSO recommendations.
15. The number of aircraft in the pattern should be limited to six.
16. During night **CARQUAL**, CCA shall utilize a single frequency to control all aircraft in the **CARQUAL** pattern.
17. The LSO shall make timely divert recommendations to the air officer based on unsatisfactory pilot performance or unsatisfactory **CARQUAL** conditions around the ship.
18. Aircraft or equipment parked forward of the LSO platform shall not obstruct the LSO's ability to observe any part of the landing area.
19. The carrier commanding officer shall have the authority to approve waivers or deviations from the procedures contained herein.

**6.2.3 LSO Certification of Pilot Performance.**

The cognizant LSO shall report orally and in writing when individual pilots have completed day/night carrier qualification. The originals of such reports shall be

delivered to the appropriate squadron commanding officer or wing commander who will certify the pilot as day/night carrier qualified. Copies shall be provided for pilot training jackets and LSO files. Reciprocal acceptance between commands of carrier qualification and LSO certification is authorized. The senior cognizant LSO may recommend revocation of a qualification anytime a pilot's standard of performance is less than satisfactory.

**6.3 CURRENCY CRITERIA FOR CARRIER QUALIFIED PILOTS**

**6.3.1 Limitations for Currency/Refresher Landings.** In addition to the criteria established in **Figure 6-1**, the following is applicable:

1. Minimum currency requirements established by **Figure 6-1** do not imply adequate pilot proficiency. Completion of additional landings required for pilot qualifications, pilot proficiency, and operational readiness of embarked units is the responsibility of the carrier commanding officer and air wing commander.
2. Operating criteria of **Figure 6-1** for multipiloted aircraft shall apply to the pilot at the controls. However, a divert field is not required if the qualifying pilot has been night current within 59 days, both pilots are NATOPS qualified in model, and one pilot is night current. Prior to a pilot's first exposure to IFLOLS, a minimum of one IFLOLS FCLP period shall be flown before any attempted carrier landing. This requirement is waivable only by the carrier commanding officer and CAG.
3. When FCLP refresher is required, unless unusual operating circumstances dictate, no longer than 10 days should elapse between the last FCLP period and the first carrier landing.
4. In maintaining night currency, Mode I ACLS approaches shall be closely monitored to ensure that consecutive Mode I approaches do not adversely affect pilot proficiency. Mode I ACLS approaches shall not be used to regain night currency once such currency has lapsed.
5. Flightcrew composition for any currency landing shall be at the discretion of the squadron commanding officer.
6. Multiplace carrier aircraft should carry only a minimum flightcrew aboard during carrier

qualification landings. Qualification landings should not be conducted with qualifying pilots aboard other than the pilot and/or copilot, unless dictated by operational necessity, except for necessary transportation to/from the ship.

7. For currency purposes, a landing within one-half hour of sunrise or sunset shall not be counted as a night carrier landing unless it is quite dark (e.g., because of cloud coverage). The senior cognizant LSO shall make this determination.
8. Night landings while at anchor shall not be used to meet the currency requirements in **Figure 6-1** without the specific approval of the carrier commanding officer.
9. For day or night currency landings, MOVLAS may be utilized to recover aircraft if deck movement or stabilization limits preclude normal use of the FLOLS within the limits of **Figure 6-1**. Use of the MOVLAS in such circumstances shall be predicated on LSO currency/proficiency in MOVLAS control, as determined by the senior cognizant LSO.

10. **OPERATIONAL CURRENCY BETWEEN F-18A-D AND F-18E/F.** In order to be simultaneously current in both the F-18A-D and the F-18E/F, the following conditions must be met. A particular "background" is defined as one complete fleet tour.

a. F-18A-D background

- (1) Have greater than 30 F-18E/F hours PIC
- (2) Full initial F-18E/F Carrier Qualification completed
- (3) Have completed full initial F-18A-D Carrier Qualification or be in compliance with F-18A-D Carrier Qualification currency requirements
- (4) Current NATOPS Qualifications in both F-18A-D and F-18E/F
- (5) One flight in both aircraft in the previous 14 days.

b. F-14A-D background

- (1) Have greater than 250 F-18E/F hours PIC

- (2) Full initial F-18E/F Carrier Qualification completed
- (3) F-18A-D CAT 4 with full initial Carrier Qualification completed
- (4) 30 hours PIC in the F-18A-D, waiverable to 10 hours with AIRPAC/AIRLANT approval
- (5) Current NATOPS Qualifications in both F-18A-D and F-18E/F
- (6) One flight in both aircraft in the previous 14 days.

Once all of the above requirements are met an aircrew can operate both the F-18A-D and the F-18E/F in the carrier environment. Flight in either aircraft will satisfy the 1 night trap in previous 7-day requirement.

11. The carrier commanding officer shall have the authority to approve waivers or deviations from the procedures contained herein.

## 6.4 NORMAL RECOVERY OPERATIONS

The primary responsibility for determining acceptable pilot performance during the final approach to the carrier rests with the LSO.

**6.4.1 Personnel Requirements.** The following personnel are required on the LSO platform for day Case I/II operations:

1. A wing- or training-qualified LSO
2. An assistant LSO (whenever available)
3. A qualified enlisted phone talker
4. A qualified enlisted hook spotter.

The following personnel are required for night/Case III recovery operations:

1. A wing-qualified LSO
2. An assistant LSO
3. A bookwriter (whenever available)
4. A qualified enlisted phone talker
5. A qualified enlisted hook spotter.

The following personnel are optional for all recovery operations:

1. The deck caller

When the CV (N) CO, CAG and CAG LSO desire to use the deck caller position, it is to be manned by a qualified LSO team member that has undergone proper training by the air wing staff LSO. Specific responsibilities of the deck caller are:

- a. Stand in a position visually in front of the controlling LSOs with an unobstructed view of the angle deck and signal if men or equipment are in the landing area.
- b. Signal an obstruction in the landing area (LA) by raising his hand over his head
- c. When all obstructions are clear of the LA, he lowers his hand and moves behind the controlling and backup LSOs.

**WARNING**

The presence or absence of the deck status caller is not an indication of clear/foul deck. Clear/Foul deck status is signaled to the LSOs by the AGO and handled per [paragraph 6.4.4](#).

Used in this way, it is a direct indication to the controlling and backup LSOs that the waveoff window is either one hundred feet (obstructions in the LA) or ten feet (no obstructions in the LA). If the landing area is obstructed in any manner at the 100-foot waveoff point, the controlling or backup LSO shall wave the aircraft off. **The deck caller shall not be used as an indicator of clear or foul deck.** The arresting gear officer is the sole person designated to indicate clear/foul deck status (LA clear, arresting gear in battery and set for the correct aircraft), and signals this to all parties via the deck status lights. When the deck is foul due to obstructions in the landing area, the deck caller is only indicating that the 100-foot clearance waveoff window shall be used. If the deck is not obstructed, the deck caller has no function and moves out of sight. With no deck obstruction, waveoffs are predicated on the conditional factors of the approaching aircraft, but in no case will the clearance be less than 10 feet if the deck is foul.

**6.4.2 LSO Responsibilities.** These responsibilities include:

1. While embarked aboard the carrier, duty LSOs shall keep the air officer informed of their whereabouts during flight quarters.
2. Upon reporting aboard a carrier for carrier operations, the LSO should meet with the air officer and [CATCC](#) officer to discuss the conduct of air operations in the LSO's area of responsibility.
3. The senior embarked LSO is responsible for the proper indoctrination and training of the LSO phone talkers and hook spotters. Specific job responsibilities for phone talkers and hook spotters shall be defined by the senior LSO.

Additionally, the senior LSO on the platform shall ensure the proper training and procedures of the required enlisted watchstanders.

- a. Enlisted PHONE TALKER — Has the primary responsibility for informing LSO's of the status of the arresting gear, weight setting, wire run-out and wire number and shall be tied into the arresting gear sound powered (6JG) phone circuit. It is their responsibility to call "foul deck" when gear is not in battery and any aircraft is in the groove. The tone and volume of these calls shall increase as the aircraft nears the waveoff window. These calls shall only cease when the deck becomes clear or the aircraft is waved off.
  - b. Enlisted HOOK SPOTTER — Responsible to check aircraft at the 180 (Case I/II) or prior to 1 NM (Case III) position for proper configuration and call: "aircraft type, gear down, hook up/down and good/flashing approach light." They shall be tied to PriFly, [CCA](#), [FOLS](#) and [ILARTS](#) control rooms via sound powered (11JG) phone circuit. The Hook Spotter shall call "Lens set, aircraft type" for each approach. They shall also notify the LSOs of any [FOLS](#) or [ILARTS](#) degrade or failure.
4. The senior LSO on the platform is responsible for the conduct of all platform operations and ensuring all team members are thoroughly briefed regarding platform procedures.
  5. The senior cognizant LSO on the platform shall at all times ensure that the assigned controlling and

backup LSOs are of sufficient experience and qualification level given the present operational situation. Factors that should be considered in determining controlling and backup LSO assignments include, but are not limited to, the following:

- a. Day/night recovery operations
- b. Weather and environmental conditions (ceiling, visibility, winds)
- c. Deck motion
- d. MOVLAS proficiency (if MOVLAS in use)
- e. LSO platform equipment malfunctions (e.g., PLAT, HUD, radio)
- f. Pilot proficiency/currency
- g. Aircraft fuel state, aircraft with multiple approaches
- h. Aircraft malfunctions
- i. LSO currency in controlling type aircraft recovering
- j. Shipboard equipment malfunction (e.g., missing CDP)
- k. Deck conditions (e.g., obscured lineup reference, static mistrim)
- l. Type of recovery operations (e.g., CARQUAL, CARQUAL refresher, normal embarked operations, EMCON operations).

The senior cognizant LSO on the platform is ultimately responsible for balancing the need to conduct LSO training with the operational realities of the current situation. When conducting LSO training, close supervision by a wing- or staff-qualified LSO is required. The supervising LSO, if not specifically functioning as the controlling or backup LSO, may consider utilizing a third UHF handset and/or pickle while conducting training of junior LSOs.

- 6. The LSO shall make the following equipment checks prior to recovery operations:
  - a. Functional check of visual landing aids

- b. All lighting facilities for proper operation (centerline, landing area lights and deck status lights)
- c. Radio check prior to each recovery (EMCON permitting)
- d. Relative wind indicator
- e. Sound-powered phones
- f. Windscreen operation
- g. Escape net condition and evacuation route
- h. Platform safety equipment
  - i. Aldis lamp or spotlight (night only)
  - j. LSO HUD
  - k. PLAT/ILARTS on and adjusted.
- 7. The air officer/LSO shall keep each other informed concerning conditions that affect the recovery of aircraft, including malfunctioning or inoperative equipment, aircraft emergencies, wind and weather conditions, and ship's trim and list.
- 8. During recovery operations, LSO responsibilities include the following:
  - a. Controlling all fixed-wing aircraft approaches after the 180° position
  - b. Ensuring that approaching aircraft are properly configured
  - c. Monitoring the operation of the FLOLS and crosschecking the approach radar/TLS glide-path angle setting
  - d. Assisting in controlling aircraft that have radio failure by flashing the cut or waveoff lights in accordance with standard NATOPS visual signals
  - e. Whenever possible, maintaining visual contact with all aircraft in the Case I/II/III pattern
  - f. Monitoring wind-over-deck and deck motion
  - g. Assisting pilots through informative, advisory, and imperative communications to

maintain approach parameters within acceptable limits

- h. Monitoring arresting gear settings, lens settings, and deck status
  - i. Evaluating aircraft approach performance and recording deviations for postflight pilot debriefs
  - j. Determining acceptable aircraft performance during the final approach, and waving off aircraft that exceed or will exceed acceptable approach parameter limits.
9. The LSO should be familiar with the landing characteristics of each aircraft under his control as described in the individual aircraft's NATOPS flight manual. Additionally, he should have a working knowledge of the effects of aircraft malfunctions upon approach configuration and speed, pilot workload, and flight characteristics.
10. It is the LSO's responsibility to wave off aircraft in sufficient time for the pilot to effect a safe maneuver utilizing standard procedures. Wave-offs necessitated by poor pilot technique that could result in an in-flight engagement shall only be initiated by the LSO.

**6.4.3 Recovery Procedures for Final Approach.** The pilot shall be familiar with procedures pertaining to the carrier landing pattern and approaches delineated in [Chapter 5](#) of the CV NATOPS Manual.

**6.4.3.1 Specific LSO and Pilot Recovery Procedures**

- 1. Transition to LSO control occurs at the 180° position in the Case I/II pattern, at 3/4 nm for a Case III precision approach (1-1/4 nm for a jet/ 1 nm for a turboprop nonprecision approach), or upon transmission of "Paddles contact."
- 2. The LSO radio transmission "Paddles contact" may occur any time during an approach when the LSO visually determines that an aircraft requires additional control to arrive within acceptable start parameters. Once "Paddles contact" has been transmitted, the LSO assumes control and CATCC should refrain from further transmissions

until the completion of the approach, or at such time the LSO elects to return the aircraft to CATCC control.

- 3. In the Case I/II pattern, the LSO shall monitor each aircraft's approach turn from the 180° position. He shall immediately wave off any aircraft that will fly too short a groove length. For Case III approaches, the LSO should monitor each aircraft's CCA and be prepared to initiate "Paddles contact" control.
- 4. At the normal "Ball" call position (i.e., rolling wings level in the groove for Case I/II, or at approach minimums for Case III), when the pilot has usable FLOLS or MOVLAS, lineup, and angle of attack reference, the following shall be transmitted (if not EMCON or ZIP LIP): Modex number, type aircraft, "Ball," fuel state to the nearest hundreds pounds, "Auto"/"Coupled" (if applicable). If the pilot does not have glideslope reference (e.g., no ball, sun glare, or poor visibility), then the call "Clara" shall replace the ball call. If the pilot does not have usable lineup information (e.g., wet landing area, sun glare, or poor visibility), then the call "Clara lineup" shall be transmitted.
- 5. If the pilot is experiencing any aircraft difficulty that may significantly affect his ability to fly a safe approach and landing, he shall make every effort to notify the ship (through CATCC, Marshal, Tower, etc.) prior to final approach. In any case, he shall inform the LSO of the difficulty at the "Ball" call. Such difficulties are not limited to aircraft configuration problems alone; loss of primary attitude reference, angle of attack malfunction, controllability problems, pilot vertigo, or other difficulties that may necessitate additional LSO assistance should be conveyed.
- 6. The pilot shall report loss of meatball (i.e., "Clara"); if no timely amplifying verbal information is received from the LSO, he shall initiate his own waveoff.
- 7. If APC is disengaged or a Mode I approach is downgraded, "Manual" or "Downgrading" should be reported.
- 8. During ZIP LIP or EMCON conditions, or for a NORDO aircraft, the LSO shall acknowledge control of the aircraft on final approach with a



steady (3-second) flash of the cut lights. In doing so, the LSO is also acknowledging that the pilot has meatball acquisition, lineup reference, and angle of attack. Subsequent flashes of the cut lights by the LSO command a pilot response of adding power, the degree of which is indicated by the duration of the cut light signal.

**6.4.4 Foul Deck Waveoff.** The waveoff point is defined as a moving window through which the aircraft passes and is the latest point where normal pilot technique will result in a safe waveoff. Many factors must be considered in determining this point, including aircraft/engine performance, approach dynamics, and environmental conditions (i.e., sink rate, angle of bank, deck movement, visibility).

Foul deck waveoff responsibility rests equally with the controlling and backup LSOs. Additionally, when in the opinion of the air officer, the deck will remain foul throughout an aircraft's approach (i.e., arresting gear malfunctions, personnel or equipment in the landing area, etc.), he should advise the LSO via the 5MC, "No chance, foul/closed deck." The LSO shall immediately initiate the waveoff using the FLOLS/ MOVLAS wave-off lights and a UHF radio transmission (EMCON permitting).

With an aircraft crossing the ship's wake during Case I/II operations, or with an aircraft approaching 3/4 nm during Case III operations, the controlling and backup LSOs shall each raise their pickle switch arm above their heads as a visual signal and reminder anytime the deck status is foul (except for MOVLAS, when the backup LSO is the only LSO to raise his arm). The LSOs shall lower their arms only upon receipt of a clear deck signal, or upon waving off the approaching aircraft for a foul deck.

During normal recovery operations, the LSO shall initiate a foul deck waveoff such that normal waveoff response will allow the aircraft to pass no closer than 10 feet to the landing area. If aircraft, personnel, or equipment are in the landing area, the waveoff shall prevent the aircraft from passing within 100 feet of the highest obstacle in the landing area.

## WARNING

If at any time doubt exists as to the condition causing a Foul Deck, in the interest of safety, 100 feet window SHALL be the default.

**6.4.5 Optical Landing System Limits.** The LSO must be cognizant of the stabilization limitations of the FLOLS. Stabilization limits vary with individual FLOLS, pitch severity, pitch rate, and associated roll and heave. The LSO shall consider utilizing MOVLAS when FLOLS stabilization has, in the LSO's estimation, been exceeded. The recommendation to utilize MOVLAS must take into account air wing MOVLAS currency and response, LSO MOVLAS proficiency, and all environmental conditions.

**6.4.6 Wind Over Deck (WOD) Requirements.** Optimum and minimum RHW information is contained in Aircraft Recovery Bulletin Nos. 10-10, 26-, and 29-series. RHW should be maintained as close as possible to the optimum velocity and the centerline of the landing area.

## CAUTION

The LSO shall immediately inform the air officer of any adverse wind conditions unsafe to aircraft recovery, and the air officer shall inform the LSO of downwind recovery situations. EMCON conditions permitting, pilots shall be advised of adverse wind conditions or downwind recoveries.

**6.4.7 Safety Precautions.** The LSO platform shall be manned when directed by the air officer, and at all times when he broadcasts, "Man all recovery stations." If access to the LSO platform is obstructed (e.g., by turning aircraft spotted for launch), the LSO team shall be readily available to man their recovery station as soon as the area becomes clear. Once the LSO platform is manned with the required personnel of [paragraph 6.4.1](#), the LSO shall report "manned and ready" to the air officer. The LSO platform shall be manned and ready prior to activation of the [OLS](#) for

fixed-wing recoveries. Operation of the OLS for use as a reference for V/STOL aircraft will not normally require the presence of a fixed-wing LSO.

If, during launch or recovery operations, any part of the aircraft strikes the ramp, aircraft, or equipment on deck or ship's structure other than normal flight deck protrusions (crossdeck pendants, flight deck light covers, ILARTS centerline cameras, PLAT heads, or waist catapult ramp), no further effort shall be made to effect a normal carrier arrestment. A divert or barricade is required in this case.

**6.4.8 MOVLAS Training.** LSOs shall acquaint themselves and receive adequate training with the MOVLAS ashore prior to using it aboard ship. To maintain proficiency with the MOVLAS, air wing staff LSOs should train air wing pilots and LSOs frequently.

**6.4.9 MOVLAS During Carrier Qualifications.** Use of MOVLAS for carrier qualifications, during initial, transition, and refresher CQ is not prohibited.

**6.4.10 MOVLAS Operating Procedures.** Positioning the MOVLAS ball to indicate proper glidepath tasks the LSO's ability to monitor all required safety parameters concurrently (i.e., landing area, deck status light, wind, aircraft glideslope, lineup, airspeed, PLAT, MOVLAS repeater, pitching deck, etc.). LSO scan breakdown can occur even under ideal conditions. Added difficulty occurs when attempting to lead pilot-induced excessive sink rates or when accentuating ball movement. To optimize the safe recovery of aircraft utilizing the MOVLAS the following procedures shall be used:

1. EMCON conditions permitting, pilots shall be advised when unplanned MOVLAS recoveries, whether practice or actual, are in progress and station location of the MOVLAS.



During night/Case III recovery operations, failure to notify pilots of MOVLAS recovery may result in dangerous situations if pilots respond to glideslope indications intended for other aircraft.

**Note**

MOVLAS recoveries under EMCON conditions may result in mandatory LSO radio transmissions because of safety-of-flight considerations.

2. When the MOVLAS is installed at station 1, turn off the FLOLS source light to preclude double images.
3. Monitor subsequent aircraft on final (especially during Case III operations) to preclude multiple aircraft from flying the same ball.
4. After aircraft touchdown or when not under positive control, the control handle should be lowered to the full-down position, displaying a low red ball, until the next aircraft is under LSO control.

The upper and lower MOVLAS power lamp on/off switches enable/disable power to the upper and lower three MOVLAS lamps, respectively. Placement of the MOVLAS control handle to the full-up or full-down position will display an amber ball or red ball, respectively, if that power lamp switch is in the ENABLED ON position. Conversely, placement of the MOVLAS control handle to the full-up or full-down position will not display a ball if that respective power lamp switch is in the OFF position.



The lack of visual glideslope information for aircraft not under positive LSO control (as with the MOVLAS controller handle in the full-up or full-down position and the respective lamp switch disabled) may result in an unsafe deviation below glidepath if the pilot attempts to correct for a perceived "Clara" high condition.

5. Upon initiating a technique waveoff with the pickle switch, the LSO shall immediately transmit a "waveoff" over UHF and lower the MOVLAS control handle to the full-down position.

6. Caution shall be exercised when using station 3 (starboard side) because of scan breakdown (especially with left-seat-piloted aircraft).
7. During night/no-horizon pitching deck operations, the only source of information concerning deck movement or ship's trim is the HUD ramp

motion indicator. The LSO's ability to accurately determine and present glideslope information via MOVLAS is significantly reduced. Under this circumstance, timely placement of plane guard ship/helicopter or flares/light sonobuoys to give an artificial horizon reference for the LSO is recommended.



PART IV

# Emergency Procedures

Chapter 7 — Emergency Procedures



## CHAPTER 7

# Emergency Procedures

## 7.1 INTRODUCTION

This chapter outlines the procedures to be followed in the event of an emergency situation or an equipment malfunction during FCLP or carrier landing operations. It supplements the doctrine set forth in other NATOPS manuals. Aboard ship, the LSO shall immediately advise the air officer whenever a malfunction is suspected or known so that corrective action can be initiated. Shore-based equipment malfunctions shall be reported to the commander fleet air detachment or station operations officer, as appropriate.

The LSO (field) and air officer (at sea) should delta aircraft in the landing pattern when an emergency aircraft is within 3 miles of landing so that the emergency aircraft has a clear landing area.

### Note

Procedures described herein are intended for use to safely recover aircraft already airborne. Every effort should be made to correct existing malfunctions. Continued operations under such conditions or with malfunctioning equipment is not recommended.

## 7.2 SHORE-BASED EMERGENCIES

### 7.2.1 FCLP Pattern Emergencies

1. Loss of LSO radio
  - a. If FCLP aircraft can continue in the landing pattern under tower control, FCLP landings may continue at the discretion of the controlling LSO.
  - b. The bingo signal, when necessary, shall be given by alternating waveoff and cut lights.

2. Loss of aircraft radio
  - a. Aircraft experiencing loss of radio in the FCLP pattern shall discontinue FCLP and land. The LSO shall signal clearance to land with cut lights.
  - b. For outlying field operations, bingo signal shall be given if the controlling LSO wishes the NORDO aircraft to proceed to the primary field as briefed.
  - c. LSOs shall notify tower of the NORDO aircraft.
3. No approach lights — Aircraft without approach lights shall be waved off, visually checked for proper landing configuration, and directed to make a full stop landing at night.
4. Aircraft at night with loss of exterior lights — Aircraft without exterior lights shall be directed to make a full stop landing. Other pattern aircraft shall be advised of the position of the darkened aircraft.

## 7.3 SHIPBOARD EMERGENCIES

Whenever normal operating procedures are modified because of emergencies or malfunctions such as those discussed in the following paragraphs, the pilot shall be informed of existing circumstances and procedures being employed.

### 7.3.1 Aircraft Emergencies

1. No approach lights — During night operations, aircraft without approach lights shall be waved off for a visual check of landing gear, launch bar/tow link (if applicable), and hook status. The following exceptions apply:
  - a. For F-14 aircraft, simultaneous illumination of at least one wingtip and at least one glove position light may be substituted for an approach light.

**WARNING**

For F-14 aircraft, with nose wheel door closed (e.g., gear up) the lower fuselage forward anti-collision light can be mistaken for a flashing approach light.

- b. For all multicrew aircraft, except the EA-6B aircraft, where cockpit configuration permits at least two aircrewmembers to visually confirm landing gear indications, verbal confirmation of “gear down and locked” may be substituted for an approach light.
  - c. Verbal confirmation of “gear down and locked” may be substituted for an approach light for aircraft in extremis. Prior liaison with the ship’s commanding officer shall be accomplished to identify what constitutes an extremis situation.
2. Abnormal aircraft configurations — The LSO shall verify with the pilot the exact configuration, gross weight, and final approach speed of any aircraft approaching in an abnormal configuration. He shall verify the lens setting and the wind-over-deck requirement for the aircraft configuration/approach speed combination. He should also rebrief the pilot concerning any procedures peculiar to the aircraft in its abnormal configuration (i.e., afterburner on touchdown, use of DLC, etc.).

When consulting the [ARBs](#) to determine the required head wind, the LSO and Air Officer should *not* as a general rule add 6 knots as recommended as a note in the beginning of each ARB without considering adverse effects of higher wind conditions. Some aircraft in certain abnormal landing configurations have better flight characteristics under lower wind conditions. Higher WOD could be detrimental.

3. Aircraft lighting malfunctions (night) — At night, abnormal aircraft lighting configurations because of lighting or other aircraft malfunctions pose many potential problems for the LSO. These problems may include the following: misidentification or late identification of aircraft type; misidentification of a navigation or other aircraft

light as an approach light; inability to confirm aircraft configuration; degradation of depth or range perception, associated with loss of normal visual cues; and effects of autokinesis from a singular aircraft light source. The LSO should be aware of these potential problems and how they may complicate his ability to provide proper control of aircraft. The LSO shall positively confirm aircraft type and configuration if any doubt exists.

For aircraft without any external lights at night, the LSO’s ability to provide timely control is severely limited. The decision to recover an aircraft under these circumstances rests solely with the commanding officer.

### 7.3.2 Landing Aid Malfunctions

1. Complete landing aids failure/damage
  - a. CARQUALS — Discontinue landings.
  - b. Deployed/refresher — The use of a divert field, if available, should be considered. If none are available and aircraft fuel state does not permit delay:
    - (1) Establish positive radio contact with each aircraft that is commencing approach
    - (2) Primary control is by radio talkdown (PRC-90 if necessary)
    - (3) Radio transmission shall be the primary means of waveoff
2. Partial OLS failure/damage
  - a. CARQUALS — Discontinue landings.
  - b. Deployed/refresher — Rig MOVLAS and continue recovery, with radio as backup.
3. When consecutive aircraft approaches result in above or below glidepath conditions:
  - a. CARQUALS — Discontinue landing until a thorough check of OLS settings and monitoring equipment is made.
  - b. Deployed/refresher — Rig MOVLAS and continue recovery, with radio as backup. A complete check of the OLS settings and



monitoring equipment shall be made immediately upon completion of the recovery.

4. Malfunctioning landing aid stabilization under steady deck conditions
  - a. CARQUALS — Discontinue landings.
  - b. Deployed/refresher — Rig MOVLAS and continue recovery, with radio as backup.
5. Waveoff lights inoperative
  - a. CARQUALS — Discontinue landings.
  - b. Deployed/refresher — Continue landings with radio transmission as primary means of waveoff.

### 7.3.3 Communication Emergencies (General).

Visual communications to be used in the event of radio failure or during EMCON shall be in accordance with the CV NATOPS Manual.

#### Note

The LSO shall acknowledge control of the approaching aircraft by illuminating the cut lights for 3 seconds at the normal meatball acquisition point. Subsequent illumination of the cut lights indicates to jet/turboprop aircraft that a power addition is required. Immediate power response is mandatory.

### 7.3.4 Communication Emergencies (Day)

1. Loss of LSO radios
  - a. CARQUALS — Discontinue landings. Advise air officer to initiate delta or bingo instructions, as appropriate.
  - b. Deployed/refresher — PriFly shall notify aircraft in pattern that LSO radio is out and transmit “Waveoff” if LSO uses waveoff lights.
2. Loss of all ship’s radios
  - a. CARQUALS — Discontinue landings. Use visual signals with OLS or from LSO platform to delta or bingo, as appropriate.

b. Deployed/refresher — Continue landings at the discretion of the OTC.

### 3. Loss of aircraft radios

#### a. CARQUALS with receiver

- (1) Pilot shall be given landing instructions and aircraft shall remain aboard when arrested.
- (2) PriFly shall transmit bingo fuel states each time the aircraft approaches abeam. The pilot shall acknowledge with a wingrock.
- (3) If unable to get aboard, pilot shall initiate own bingo when fuel state dictates. Another aircraft should be designated as an escort.

b. CARQUALS with no receiver — Aircraft should be diverted.

c. Deployed/refresher — With or without receiver, make normal approach and landing.

### 7.3.5 Communication Emergencies (Night)

#### 1. Loss of LSO radios

- a. CARQUALS — Discontinue landings. Give delta or bingo instructions, as appropriate.
- b. Deployed/refresher — The LSO shall inform CCA via sound-powered phone of the radio failure. The LSO shall accept control of each aircraft from CCA via sound-powered phone as the aircraft reaches approximate meatball acquisition position. At this time, CCA shall transmit to the pilot of each aircraft that the LSO has assumed control of the approach and the LSO shall use standard visual signals as necessary.

#### 2. Loss of all ship’s radios

- a. CARQUALS — Discontinue landings. The senior officer of each unit airborne should organize a flight of his unit members and proceed to divert field.
- b. Deployed/refresher — Continue landings or bingo at the discretion of the OTC. Use standard

visual signals on the OLS, or from the LSO platform, or from PriFly, as appropriate.

3. Loss of aircraft radios

a. CARQUALS

- (1) Without receiver, pilot should be diverted.
- (2) With receiver, pilot shall be given landing instructions and aircraft shall remain aboard when arrested. CATCC shall transmit bingo fuel state each time the aircraft commences approach. If unable to get aboard, pilot shall bingo when fuel state dictates. Another aircraft should be designated as an escort.

b. Deployed/refresher — NORDO aircraft with flight leader

- (1) The lead pilot calls “Ball” and receives normal reply from the LSO.
- (2) After receiving acknowledgment, the lead pilot makes the appropriate light signal, breaks off to the left, then parallels final bearing, allowing the NORDO aircraft to continue the approach visually. The NORDO aircraft shall receive cut lights from the LSO following breakaway.
- (3) The lead pilot shall position his aircraft to be rejoined by the NORDO aircraft in the event of a bolter or waveoff.

c. Deployed/refresher — NORDO aircraft without a flight leader

- (1) The pilot makes the approach with lights as indicated in the CV NATOPS Manual.
- (2) The pilot squawks the appropriate code on IFF.
- (3) The LSO shall acknowledge positive control of the NORDO aircraft by the cut light signal. An aircraft with transmitter only receives the same acknowledgment as the NORDO aircraft. Without acknowledgment, the pilot shall execute his own waveoff.

d. Deployed/refresher — NORDO aircraft without external lights and without a flight leader

- (1) The pilot shall squawk the appropriate code in IFF and commence a normal approach, but shall not land without visual acknowledgment by the LSO.
- (2) If visual acknowledgment is not received, the pilot shall execute a normal waveoff into the bolter pattern and expect pattern priority and acknowledgment on the next approach.
- (3) After determining the aircraft will not have any external lights, the senior LSO shall recommend recovery/divert to the air officer.

**WARNING**

Under these conditions, the LSO’s ability to determine aircraft configuration and provide assistance to the approaching aircraft is severely limited. The decision to recover aircraft under these circumstances rests solely with the commanding officer.

- (4) The cut lights, when used as an acknowledgment signal, shall be given as near the normal meatball reporting position as possible.

**7.3.6 Miscellaneous LSO Equipment Malfunction.** The LSO shall notify the air officer of the malfunction or loss of any required equipment listed in [Part II, Chapter 4](#). The decision to continue recovery operations with any required LSO equipment inoperative shall rest with the commanding officer.

**7.3.7 Excessive Deck Motion.** The decision to continue flight operations during periods of excessive deck motion must be made after considering many factors. These factors include but are not limited to the following: amount and rate of pitch, associated heave and roll, day or night, visibility and horizon, air wing and LSO proficiency, tanker and divert availability. Although there are no hard and fast numbers to define excessive motion, as a general rule, deck motion in excess of 20 feet of pitch in anything less than 5 seconds

of periodicity should be viewed as an emergency situation. MOVLAS is the primary method of recovering aircraft during excessive deck motion, depending on other factors previously mentioned. LSO workload will be very high in these conditions. The LSO will most likely be required to make nearly continuous voice transmissions during pitching deck operations regardless of whether MOVLAS or FLOLS is utilized. The LSO will most likely be required to utilize a steeper than normal glideslope as well as to ensure adequate hook-to-ramp clearance during extreme pitch cycles.

**WARNING**

Recovery of fixed-wing aircraft during pitching deck operations has a higher risk of hard landings, ramp strikes, off-center engagements, and in-extremis low fuel states airborne because of inability to get aboard and lower overall boarding rate.

**7.3.8 Ship Static Mistrim.** Recovery operations shall not be conducted under static mistrim conditions which would result in hook-to-ramp clearances of less than 10 feet for a normal pendant recovery or 8 feet for a barricade recovery. For a pendant recovery, a change in commanded hook touchdown point or, wind permitting, a higher FLOLS basic angle setting should be considered to correct the low hook to ramp. MOVLAS may also be utilized.

**WARNING**

Under conditions of significant static roll mistrim, without a defined horizon (night or Case III), pilots may be prone to level their wings with the listing deck and establish an insidious lineup drift during the latter stages of an approach. A lineup drift upon rollout may also be aggravated.

**Note**

A barricade recovery using FLOLS glideslope information under mistrim conditions which preclude targeting of the optimum hook touchdown point reduces the probability of successful engagement. Under these conditions, MOVLAS should be used.

**7.3.9 Barricade Engagements.** The LSO shall verify with the pilot the exact configuration, gross weight, and final approach speed of the aircraft to engage the barricade. Based upon environmental conditions, he shall recommend to the air officer whether the FLOLS or MOVLAS should be used for the approach. If the FLOLS is to be utilized, the LSO shall verify setting of a 4° basic angle, the proper hook touchdown point, and ensure hook-to-ramp clearance is at or above the minimum of 8 feet. Additionally, he shall verify wind-over-deck requirements for the planned gross weight/approach speed combination.

The controlling LSO should brief the pilot concerning the following procedures:

1. Deck motion
2. Wind over deck
3. Importance of lineup/drift control
4. Importance of airspeed control/maximum engaging speed
5. Importance of glideslope control to touchdown
6. Loss of OLS in close (because of barricade stanchions)
7. LSO voice calls
8. Cut
9. Inability to execute late waveoff
10. Four-degree glideslope or MOVLAS (as appropriate).



PART V

# Extreme Weather Condition Operations

Chapter 8 — Extreme Weather Condition Operations





## CHAPTER 8

# Extreme Weather Condition Operations

## 8.1 ABSENCE OF HORIZON REFERENCE

When environmental conditions at night are such that no visible horizon exists, consideration should be given to utilizing a plane guard destroyer or helicopter aft of the ship to provide a reference point for the LSO. A series of Mk 58 marine markers placed astern of the ship can also provide a useful reference.

### Note

Reflection of light from low ceilings may induce pilot vertigo because of the perception of constantly changing horizons.

## 8.2 RESTRICTED VISIBILITY/CEILING OPERATIONS

Recovery operations with ceilings as low as 200 feet and visibility as low as one-half mile severely limit the time available for the LSO to acquire the approaching aircraft, evaluate aircraft type and configuration, and provide assistance to the pilot. Under extreme low ceiling/visibility conditions, the LSO should use all available means to track and determine aircraft position to facilitate LSO visual acquisition at greater ranges. This may include use of LSO HUD SPN-42/46 information, close attention to CATCC CCA calls for approaching aircraft, and aircraft illumination of landing/taxi lights. The LSO will frequently visually acquire the approaching aircraft prior to the pilot having positive reference to the landing environment (meatball and lineup). Late acquisition of aircraft necessitates that

the LSO be prepared to provide immediate, concise, meaningful voice calls to assist the pilot in getting to stabilized approach parameters for recovery.

## 8.3 EXCESSIVE DECK MOTION

Recovery operations under conditions of excessive deck motion are discussed in [Chapter 7](#) of this manual.

## 8.4 EXCESSIVE WIND-OVER-DECK OPERATIONS

Turbulence and ramp burble increase significantly with RHW values in excess of optimum, resulting in an increased frequency of high landing gear loading.

Winds starboard of the angle also adversely affect recovery conditions. The burble, aft of the ramp, becomes stronger and moves closer to the ship as the magnitude of recovery crosswind is increased. The airflow disturbance requires corrective pilot technique if the recovery crosswind exceeds 7 knots for all carriers. Even with corrective pilot technique, sinking speeds 3 to 6 feet per second in excess of those experienced during normal (no recovery crosswind) operations can be expected. For these reasons, recovery headwind should be maintained as closely as possible to the optimum velocity and the centerline of the landing area. Shipboard aircraft recovery operations with recovery crosswinds in excess of those specified should be avoided. Refer to Aircraft Recovery Bulletin No. 10-10.





PART VI

# Communications

Chapter 9 — Communications





## CHAPTER 9

# Communications

## 9.1 GENERAL

The LSO shall possess a thorough knowledge of visual and radio communication procedures as well as complete familiarity with the operation of all available communication equipment, including ACLS data link if applicable. In addition, he should ensure that all pilots under his cognizance are periodically examined on their knowledge of visual communication procedures.

## 9.2 RADIO COMMUNICATIONS

Under normal recovery conditions, the LSO should restrict his radio transmissions to the minimum necessary to provide positive corrective signals to the pilot during the actual approach. It must be realized, however, that at some times (i.e., initial stages of FCLP, excessive deck motion, restricted ceiling/visibility, etc.) the number of LSO radio transmissions will be greater than normal. Radio communications may be used for airborne brief/debrief at the discretion of the controlling LSO whenever the situation requires it. This includes the pattern and final approach.

The LSO should not permit perceived pressure to maintain total radio silence during EMCON training or ZIP LIP conditions to override his absolute responsibility for the safe recovery of aircraft.

## 9.3 STANDARD LSO PHRASEOLOGY

The LSO must on occasion use radio transmissions to effect safe aircraft recovery. Calls that are too frequent or verbose actually degrade pilot training and performance. Safety of flight requires that pilots receive short meaningful transmissions that can be instantly understood. **Figure 9-1** contains a listing of standard LSO informative, advisory, and imperative phrases.

LSOs shall train pilots on these standard LSO voice calls, their meanings, and the correct response to them. LSOs shall adopt a voice call strategy that is primarily limited, under normal conditions, to the calls listed herein. Such a strategy will reduce pilot confusion or misinterpretation of any nonstandard calls.

## 9.4 RADIO COMMUNICATIONS DURING EMERGENCY SITUATIONS

During emergency situations such as loss of visual landing aids, reduced cockpit visibility, excessive deck motion, etc., the LSO will often be required to give pilots a complete radio talkdown, providing lineup, glideslope, and corrective information. The LSO should brief the pilots as time permits on format for the talkdown as well as expected pilot responses to calls.

**INFORMATIVE CALLS**

Used to inform pilots of existing situations.

<b>TRANSMISSION</b>	<b>MEANING</b>	<b>RESPONSE (Aircraft in Manual Mode)</b>	<b>RESPONSE (Aircraft in APC Mode)</b>
"You're (a little) high."	Aircraft is (slightly) above optimum glide-slope.	Adjust sink rate with power/nose attitude to establish center ball.	Adjust sink rate with nose attitude to establish center ball. (Avoid using in close.)
You're (a little) low."	Aircraft is (slightly) below optimum glide-slope.	Adjust glide slope immediately.	Adjust glide slope immediately.
"You're going high (low)."	Unless corrected, aircraft will go above (below) optimum glide-slope.	Adjust sink rate with power/nose attitude to maintain center ball.	Adjust sink rate with nose attitude to maintain center ball.
"You're on centerline."	Self-explanatory.	N/A	N/A
"You're on glideslope/glidepath."	Self-explanatory.	N/A	N/A
"You're on speed."	Self-explanatory.	N/A	N/A
"You're lined up left/right."	Aircraft has undershot/overshot centerline.	Reestablish centered lineup.	Reestablish centered lineup.
"You're drifting left/right."	Aircraft is drifting left/right of center-line.	Correct lineup to centerline.	Correct lineup to centerline.
"You're (a little fast/slow)." (To be followed by "Go manual" if auto.)	Self-explanatory.	Adjust nose attitude/power to establish optimum AOA.	APC is not maintaining aircraft at optimum AOA. Disengage APC and adjust power/attitude to maintain optimum AOA.
"Roger Ball" ("Auto"/"Coupled" as appropriate).	LSO acknowledges pilot has meatball acquisition, lineup reference, and angle of attack.	N/A	N/A
"Paddles contact."	LSO assuming control from CCA.	N/A	N/A
"The deck is moving/down/up (a little)."	OLS information may be invalid (to be followed by advisory/imperative calls).	Adjust power and attitude under LSO guidance.	Adjust attitude under LSO guidance.
"The deck is steady."	OLS information is valid	Fly normal approach.	Fly normal approach.
"Winds are (slightly) starboard/port/axial."	Self-explanatory.	Monitor lineup to maintain centerline.	Monitor lineup to maintain centerline.
"You're underpowered/overpowered."	Self-explanatory.	Adjust attitude and power as required.	Not used.
"Ship's in a starboard/port turn."	Self-explanatory.	Adjust lineup as necessary.	Adjust lineup as necessary.
"MOVLAS recovery."	MOVLAS is in use.	Fly published pattern altitude until "Roger ball" received.	Fly published pattern altitude until "Roger ball" received.

Figure 9-1. Standard Radio Phraseology (Sheet 1 of 4)

**ADVISORY CALLS**

Used to direct pilot's attention to potential difficulties and prevent possible control errors.

<b>TRANSMISSION</b>	<b>MEANING</b>	<b>RESPONSE (Aircraft in Manual Mode)</b>	<b>RESPONSE (Aircraft in APC Mode)</b>
"Keep your turn in."	If angle of bank is not adjusted, the aircraft will overshoot the centerline.	Adjust angle of bank,	Adjust angle of bank.
"Check your lineup." (Start only.)	Aircraft lineup is not optimum.	Correct lineup drift or position to maintain aircraft on centerline.	Correct lineup drift or position to maintain aircraft on centerline.
"Back to the right/left."	Aircraft is drifting such that if drift is not corrected, it will overshoot the centerline.	Correct lineup drift to remain on centerline.	Correct lineup drift to remain on centerline.
"Don't settle." "Don't go low."	Aircraft will settle below optimum glideslope if not corrected.	Check sink rate and meatball to avoid settling below glideslope.	Check sink rate and meatball to avoid settling below glideslope.
"Don't climb." "Don't go high."	Aircraft is on or above optimum glideslope with insufficient rate of descent to maintain constant glideslope.	Adjust power/attitude to stop the ball from rising.	Adjust power/attitude to stop the ball from rising.
"Don't go any lower (higher)."	Aircraft is maintaining position well below (above) optimum glideslope with insufficient or no correction.	Adjust power/attitude to make positive correction toward optimum glideslope.	Adjust attitude to make positive correction toward optimum glideslope.
"Hold what you've got."	OLS information is invalid. Present rate-of-descent is correct to maintain proper glideslope.	Adjust power/attitude. Hold present rate-of-descent and optimum airspeed.	Adjust attitude. Hold present (optimum) rate-of-descent.
"Fly the ball."	OLS information is valid.	Scan the lens and adjust power/attitude to maintain optimum glideslope.	Scan the lens and adjust attitude to maintain optimum glideslope.
"Easy with it."	Magnitude of power correction immediately preceding this transmission is excessive.	Reduce magnitude of power correction to intercept and reestablish optimum glideslope and airspeed.	Reduce magnitude of nose attitude correction to intercept and reestablish optimum glideslope and airspeed.
"Easy with your nose."	Magnitude of nose attitude correction immediately preceding this transmission is excessive.	Reduce magnitude of nose attitude correction to establish optimum aircraft attitude.	Not used.
"Easy with your wings."	Magnitude of lineup correction immediately preceding this transmission is excessive.	Reduce magnitude of lineup correction to intercept and reestablish centerline.	Reduce magnitude of lineup correction to intercept and reestablish centerline.

Figure9-1. Standard Radio Phraseology (Sheet 2)

**IMPERATIVE CALLS**

Used to direct the pilot to execute a specific control action. MANDATORY IMMEDIATE RESPONSE

<b>TRANSMISSION</b>	<b>MEANING</b>	<b>RESPONSE (Aircraft in Manual Mode)</b>	<b>RESPONSE (Aircraft in APC Mode)</b>
"A little power."	Aircraft is decelerating or settling.	Correct with power.	Not used.
"Power back on."	Pilot has made an excessive power reduction.	Add power to maintain optimum glideslope/AOA.	Disengage APC. Add power to maintain optimum glideslope/AOA.
"Power."	Aircraft is low/slow.	Add power.	Disengage APC. Refer to Note.
"Burner."	Aircraft is extremely underpowered or in extremis.	Select afterburner power.	Select afterburner power.
"Go manual."	Disengage APC.	Not used.	Disengage APC. Refer to Note.
"Attitude." ("A little attitude.")	Manual: Aircraft nose is low. Auto: Aircraft is low/setting or nose is low.	Increase nose attitude (slightly) to establish landing attitude.	Increase nose attitude (slightly) to reduce sink rate or to establish landing attitude.
"(A little) right/left rudder."	Aircraft does not have enough right or left rudder and will land yawed right or left if not corrected.	Adjust rudder to return aircraft to balanced flight.	Note applicable.
"(A little) right for lineup." "(A little) come left."	Aircraft will land left/right if not corrected.	Correct lineup to centerline, then level wings.	Correct lineup to centerline, then level wings.
"Bolter."	Self-explanatory.	Add 100 percent power and execute bolter in accordance with model NATOPS manual.	Add 100 percent power and execute bolter in accordance with model NATOPS manual.
"Waveoff" or "Waveoff, foul deck."	Self-explanatory.	Execute waveoff in accordance with model NATOPS manual.	Execute waveoff in accordance with model NATOPS manual.
"Waveoff up the starboard side."	Discontinue turning attempt to overfly the landing area.	Execute waveoff in accordance with model NATOPS manual starboard of the landing area (island).	Execute waveoff in accordance with model NATOPS manual starboard of the landing area (island).
"Cut."	Aircraft is in a position to land.	For barricade recovery, retard throttle(s) to idle and secure engine(s) once safely on deck.	For barricade recovery, retard throttle(s) to idle and secure engine(s) once safely on deck.
"Speedbrakes."	Speedbrakes are extended.	Retract speedbrakes.	Retract speedbrakes.
"Extend speedbrakes."	Self-explanatory.	Comply.	Comply.

Figure 9-1. Standard Radio Phraseology (Sheet 3)

**IMPERATIVE CALLS (Cont.)**

<b>TRANSMISSION</b>	<b>MEANING</b>	<b>RESPONSE (Aircraft in Manual Mode)</b>	<b>RESPONSE (Aircraft in APC Mode)</b>
"Drop your hook."	Self-explanatory.	Comply.	Comply.
"Drop your gear."	Self-explanatory.	Comply.	Comply.
"Drop your flaps."	Self-explanatory.	Comply.	Comply.
"Level your wings."	Aircraft is in angle of bank.	Comply.	Comply.
"Downgrade."	Disengage ACLS.	Disengage ACLS.	Disengage ACLS.
"DLC."	Self-explanatory.	Activate DLC (down).	Activate DLC (down).
"Climb."	Aircraft has bolted/waved off but has not established proper attitude/power for positive rate of climb.	Adjust nose attitude to optimum, level wings, and maintain MRT (burner if required) to establish positive rate of climb.	
<p><b>Note</b> Aircraft is considered to be in manual mode immediately after this call. Manual calls/responses are subsequently applicable.</p>			

Figure 9-1. Standard Radio Phraseology (Sheet 4)





PART VII

# NATOPS Evaluation, Pilot Performance Records and Aircraft Mishap Statements

[Chapter 10 — NATOPS Evaluation](#)

[Chapter 11 — Pilot Performance Records](#)

[Chapter 12 — Aircraft Mishap Statements](#)



## CHAPTER 10

# NATOPS Evaluation

## 10.1 INTRODUCTION

**10.1.1 Concepts.** The standard operating procedures prescribed in this manual optimize the safety and efficiency of LSO operations. The NATOPS evaluation is intended to evaluate compliance with NATOPS procedures by observing and grading individuals and units. This evaluation is tailored for compatibility with various operational commitments and missions of both Navy and Marine Corps units. The primary objective of the NATOPS evaluation program is to assist the type commander LSO in improving LSO readiness and safety through constructive comment. Maximum benefit from the NATOPS evaluation program will only be achieved through the active, vigorous support of all LSOs.

**10.1.2 Implementation.** The type commander LSO shall supervise the implementation of the NATOPS qualification and evaluation program. Individual evaluations are a prerequisite to certification for each level of LSO qualification. Unit evaluations shall be conducted by the type commander LSO during the normal carrier workup cycle prior to extended deployment. Instruction in, and adherence to, NATOPS procedures is the responsibility of the senior cognizant LSO, and should be on a routine basis within each unit to obtain maximum benefits from the program.

## 10.2 FIELD LSO QUALIFICATION

**10.2.1 Formal Ground Training.** Prior to certification for field qualification, the LSO trainee should complete initial formal ground training at the U.S. Navy LSO School. The trainee shall receive instruction in the following subject areas from a designated LSO:

1. Operation of the Mk 8 Mod 1 Fresnel lens
2. Operation of Mk 8 Mod 0 Fresnel lens or Mk 9/10 mirror systems (if installed at the command's primary FCLP facilities)

3. Operation of MOVLAS and MOVLAS technique (if installed at the command's primary FCLP facilities)
4. Glideslope geometry/hook touchdown point calculations for field equipment, and FLOLS pole check procedures.
5. Operation of UHF communications equipment at command's primary FCLP facilities
6. Shore-based arresting gear
7. Aircraft shore-based emergency landing characteristics/procedures (for each type/model aircraft operated by command)
8. Course rules/FCLP procedures for command's primary FCLP facilities.

**10.2.2 Field Experience.** The LSO under training shall receive sufficient field training under the supervision of a designated LSO to ensure the LSO under training can safely control day/night FCLP operations. He should also receive training in control of aircraft using MOVLAS (if available).

**10.2.3 Field Evaluation.** A designated LSO shall evaluate the LSO under training's ability to safely control day/night FCLP operations (using both the normal lens/mirror, LSO talkdowns, and MOVLAS if available) prior to certification.

**10.2.4 Certification.** Based upon a favorable evaluation from the senior squadron LSO and concurrence from the air wing LSO/Marine air wing LSO, the air wing commander/Marine air wing commander may grant field LSO qualifications. A copy of the approval letter shall be forwarded to the type commander. The letter shall include a statement that the LSO has completed initial formal ground training or has received instruction in the required subject areas specified in [paragraph 10.2.1](#).

## 10.3 SQUADRON LSO QUALIFICATION

**10.3.1 Formal Ground Training.** The LSO should complete initial formal ground training at the

U.S. Navy LSO School prior to qualification as a squadron LSO. The LSO shall receive instruction in the following subject areas from a designated LSO prior to certification as a squadron LSO:

1. Required formal ground training for field qualification
2. CV and LSO NATOPS Manuals
3. Aircraft launch procedures and recovery bulletins
4. LSO shipboard workstation and equipment
5. AN/SPN-41 and AN/SPN-42/46
6. PLAT/ILARTS
7. Catapults and arresting gear
8. Barricade
9. MOVLAS technique
10. Glideslope geometry/hook touchdown point calculations
11. Received training in LSO trainer (device 2H111) (as available)
12. Pilot debriefing techniques
13. APARTS computer program
14. LSO recordkeeping and trend analysis.

**10.3.2 Shipboard Experience.** The LSO under training shall receive sufficient training under the supervision of a wing-designated LSO to ensure the LSO under training can safely control shipboard recovery of one or more type aircraft under the following conditions:

1. Day and night operations
2. Relatively steady deck
3. Fresnel lens and MOVLAS (daylight operations).

**10.3.3 Written and Practical Evaluation.** The LSO shall complete a written evaluation covering all areas of formal ground training listed in this chapter and administered by the senior air wing staff LSO prior to

certification. Additionally, the senior staff LSO shall evaluate the LSO's ability to safely control day/night FCLP and day/night shipboard recovery of aircraft using both the Fresnel lens and MOVLAS (daylight). Night shipboard recovery operations are not required for squadron qualification in C-2 type aircraft.

**10.3.4 Certification.** Once the above training requirements have been successfully completed, and based upon a favorable evaluation from the senior staff LSO, the air wing commander shall submit a letter recommending squadron qualification to the type commander. The letter shall include a statement indicating that the LSO has completed initial formal ground training or has received instruction in the required subject areas specified in [paragraph 10.3.1](#). The type commander shall forward a copy of the approval letter to the Bureau of Naval Personnel (PERS 433) or Commandant of the Marine Corps (Code MMOA2) for entry into the individual's permanent record.

## **10.4 WING LSO QUALIFICATION**

**10.4.1 Formal Ground Training.** The LSO shall complete the initial formal ground training syllabus of the U.S. Navy LSO School prior to wing LSO qualification.

**10.4.2 Shipboard LSO Experience.** The LSO under training shall receive sufficient training under the supervision of the senior air wing staff LSO to ensure that individual's ability to control a majority of the air wing aircraft aboard ship in day/night and all weather and deck conditions, without assistance, using the Fresnel lens, MOVLAS, and LSO talkdowns.

**10.4.3 Written and Practical Evaluation.** The LSO shall complete a written evaluation covering the subject areas discussed in the initial formal ground training syllabus and administered by the senior air wing staff LSO prior to certification. The senior staff LSO shall evaluate the LSO's ability to safely control FCLP and shipboard recovery of air wing aircraft and function as a watch team leader instructing proper control techniques and platform strategy.

**10.4.4 Certification.** Once the above training requirements have been successfully completed, and based upon a favorable evaluation from the senior staff LSO, the air wing commander shall submit a letter recommending wing qualification to the type

commander. The letter shall include a statement indicating that the LSO has completed initial formal ground training. The type commander shall forward a copy of the approval letter to the Bureau of Naval Personnel (PERS 433) or Commandant of the Marine Corps (Code MMOA2) for entry into the individual's permanent record.

## 10.5 TRAINING LSO QUALIFICATION

**10.5.1 Prerequisites.** The LSO shall have, as a minimum, a Wing LSO Designation prior to commencing training for a FRS Training LSO qualification.

### Note

A Squadron LSO designation will suffice for commencing training for a CNATRA Training LSO qualification.

**10.5.2 Formal Ground Training.** The LSO shall complete the initial formal ground training and FRS/TRACOM formal ground training courses of the U.S. Navy LSO School prior to training LSO qualification.

**10.5.3 Classroom Training Experience.** Prior to certification of training LSO qualification, the LSO shall demonstrate the ability to present the precarrier briefing syllabus to pilots undergoing initial in-type carrier qualification.

**10.5.4 Field Experience.** Prior to certification of training LSO qualification, the LSO shall demonstrate the ability to safely control day/night FCLP operations and conduct effective postflight debriefs with pilots preparing for initial in-type carrier qualification.

**10.5.5 Shipboard Experience.** Prior to certification of training LSO qualification, the LSO shall demonstrate, under the supervision of a training LSO, the ability to safely control day/night initial in-type carrier qualification landings and conduct effective postflight debriefs.

### Note

Control of night carrier landings is not required for training LSO qualification for aircraft types whose mission does not require night carrier operations.

**10.5.6 Certification.** Upon satisfactory evaluation and recommendation by the senior training LSO, the squadron commanding officer shall recommend training qualification via letter to the type commander (training command squadron commanding officers shall forward letters to the type commander, via the training wing commander). The type commander shall forward a copy of the approval letter to the Bureau of Naval Personnel (PERS 433) or Commandant of the Marine Corps (Code MMOA2) for entry into the individual's permanent record.

## 10.6 STAFF LSO QUALIFICATION

**10.6.1 Formal Ground Training.** The LSO shall complete the advanced formal ground training syllabus of the U.S. Navy LSO School prior to staff LSO qualification.

**10.6.2 Shipboard Currency.** Prior to certification of staff LSO qualification, the LSO shall demonstrate, under the supervision of a staff LSO, proficiency in safely controlling all air wing aircraft aboard ship in day/night and all weather and deck conditions, without assistance, using the Fresnel lens, MOVFLAS, and LSO talkdowns.

**10.6.3 Certification.** Upon satisfactory evaluation and recommendation by the senior staff LSO, the air wing commander shall recommend staff qualification via letter to the type commander. The type commander shall forward a copy of the approval letter to the Bureau of Naval Personnel (PERS 433) for entry to the individual's permanent record.

## 10.7 CARRIER AIR WING PREDEPLOYMENT LSO EVALUATION

**10.7.1 General.** In supervising the implementation of the NATOPS qualification and evaluation program, the cognizant type commander LSO shall evaluate the LSO training program and team performance of each carrier air wing prior to extended deployment. Training air wings, reserve air wings, and fleet readiness squadrons shall be evaluated at least every 18 months.

**10.7.2 Formal Ground Training Program Evaluation.** The type commander LSO shall administer a written examination to all trainee, squadron, wing, training, and staff LSOs covering appropriate material from the initial and advanced formal ground

training syllabi and aircraft recovery bulletins appropriate to the specific ship and aircraft of the embarked air wing. Designated LSOs shall demonstrate a working knowledge of the examination material commensurate with their level of designation. Failure to do so may result in revocation of LSO designation at the discretion of the type commander LSO.

**10.7.3 Shipboard LSO Team Performance Evaluation.** The type commander LSO shall evaluate the ability of the air wing's LSOs to safely and expeditiously control shipboard recovery of aircraft in day/night and all weather and deck conditions using the Fresnel lens, MOVLAS, and LSO talkdowns.

### **10.8 LSO TRAINING STATUS MATRIX**

The LSO training status matrix shall be completed by the senior air wing LSO, **TRAWING** LSO, **FRS** LSO, or Marine air wing LSO on a quarterly basis. The matrix is due to the type commander LSO with a copy to Bureau of Naval Personnel (PERS 433) (or Marine

liaison officer, U.S. Navy LSO School for Marine LSOs); CNATRA (Code N333); and OIC, LSO School, on the 15th of January, April, July, and October. The remarks/recommendations column is used to identify LSOs that are particularly qualified to advance in the LSO pipeline. Comments should include estimation of further qualification, identification of problem areas, and recommendation for future assignment. The senior LSO should debrief individual LSOs on their progress toward further qualification at least on a quarterly basis. Refer to **Figure 10-1**.

### **10.9 REMOVAL OF LSO DESIGNATION**

When it is necessary to remove an LSO's designation, the senior cognizant LSO shall make a recommendation to the LSO's commanding officer. If the LSO's commanding officer concurs in the recommendation, a letter shall be forwarded via the chain of command to the Bureau of Naval Personnel (PERS 1651) or Commandant Marine Corps (Code MMOA2) requesting such action. Commanding officers shall cite the reasons for removing the LSO's designation.







## CHAPTER 11

# Pilot Performance Records

## 11.1 INTRODUCTION

The effectiveness and combat readiness of the aircraft carrier depends on the overall efficiency of carrier landing operations. To effectively carry out assigned missions, each aviator must be able to perform a carrier approach and landing within the standards set for this evolution. The cognizant commanding officer and air wing commander shall be immediately informed about those pilots who display unsafe practices or unsatisfactory progress. The LSO shall recommend to the commanding officer or air wing commander either additional field/carrier work or immediate grounding and evaluation of those individual pilots concerned.

## 11.2 LOG BOOKS

The controlling LSO shall maintain a field and carrier logbook. Comments should be sufficiently detailed to enable the LSO to give a comprehensive debrief to the pilots concerned. The Landing Signal Officer's Log, OPNAV 3760/76 (5-87) (S/N 0107-LF-037-6390), may be used for documentation.

The Senior Air Wing Staff LSO shall ensure that all COD shipboard approaches are logged in a separate COD log maintained in the Air Operations office on board the ship.

## 11.3 PILOT PERFORMANCE RECORDS

The LSO shall keep a smooth carrier landing trend analysis for all pilots making carrier landings in aircraft

for which his command is reporting custodian, using OPNAV Form 3760/7 1 (Figure 11-1) or by using the APARTS (Figure 11-2). The pilot performance record should be updated daily, reviewed and debriefed routinely, and the pilot and his commanding officer notified of any unsatisfactory trends. LSO logbooks and pilot performance records are privileged and personal documents. Extracts from them are authorized for official use provided they are interpreted and compiled by the LSO concerned.

### 11.3.1 Automated Performance Assessment and Readiness Training System.

APARTS is a computer software program designed to assist the LSO in recording and analyzing pilot and LSO carrier landing performance information. The system provides various summaries for individual pilots, squadrons, or an entire air wing. The results may be displayed on the computer screen or printed out for a hard copy record (Figure 11-2). Copies of fleet and FRS APARTS programs, including operating manuals, may be obtained from the U.S. Navy LSO School.

## 11.4 STANDARD LOG SYMBOLS

The following symbols are in common use for recording comments concerning approaches/landings during FCLP and carrier operations. The symbols used in APARTS are also listed. If there is no corresponding APARTS symbol, the space is left blank.

CARRIER LANDING TREND ANALYSIS OPNAV FORM 3780/71 (REV. 7-71)												
PILOT <b>ROGER BALL</b> SQUADRON <b>VFA-00</b> SHIP <b>CV-00</b>												
YEAR <b>1990</b> ACFT <b>F-18</b>												
DATE	D N	GR	GLIDE SLOPE & SPEED ERRORS				CONTROL POWER	ERRORS ATTITUDE	LINE UP AND WINGS	WIRES	REMARKS - INCLUDE USE OF APC AND ANCLS	
			OT	X	IM	IC						
6/2	⊙	(OK)	H		(H)		(NDTL)		1 2 3 4	A		
6/2	⊙	WO				DEC CP	NEPIC		1 2 3 4			
6/2	⊙	(OK)				SRD B	DNTL	(PLIC)	1 2 3 4			
6/4	⊙	OK						RJFWIC	1 2 3 4			
6/6	⊙	(OK)	H						1 2 3 4			
6/7	⊙	OK							1 2 3 4			
6/7	⊙	(OK)	(SLO)			(H) OCCO			1 2 3 4			
6/8	⊙	C				2H) CO →	EG		1 2 3 4	LANDED ON WO		
6/8	⊙	I				(LO)	(LOB)		1 2 3 4	I		
6/9	⊙	-	HF					WJX-IM	1 2 3 4	LIG		
6/15	⊙	WO						(OSX)	1 2 3 4			
6/15	⊙	OK							1 2 3 4			
6/16	⊙	(OK)	NEP S			LO →	NEPNU		1 2 3 4			
6/16	⊙	PT				OC H			1 2 3 4			
6/16	⊙	-				SRD H		NDIC	1 2 3 4			
6/18	⊙	(OK)				SRD F →			1 2 3 4			
6/18	⊙	-				TMP B	TMPI C	DRWAR	1 2 3 4	TWA		
6/20	⊙	(OK)				ACC		AA	1 2 3 4			
	D N								1 2 3 4			
	D N								1 2 3 4			
	U N								1 2 3 4			
	D N								1 2 3 4			
	D N								1 2 3 4			

LSO-F018

Figure 11-1. Carrier Landing Trend Analysis Form

SQUADRON: ALL TREND ANALYSIS							AIRCRAFT: ALL				
RECOVERY PERIOD: 9006021200 - 9006201200							DAY/NITE/ALL: ALL				
PILOTS SELECTED: BALL, ROGER							MOVLAS: ALL RECOVERIES				
DATE	GLIDE SLOPE AND SPEED ERRORS						CONTROL ERRORS		LINEUP & WING	OTHER	WIRE #
	GRADE	AW	X	IM	IC	AR	POWER	ATT			
06/02D	(OK)		H	(H)				(NDTL)			2
06/02N	WO				DEC	CD	NEPIC				WO
06/02N	(OK)				SRD	B		DNTL			4
06/04D	OK								(DLIC)		3
06/06D	(OK)	H							RUFWIC		4
06/07D	OK					(B)					4
06/07D	(OK)	(SLO)			(/)		OCCOIC				4
06/08D	C			OC(H)	CD	CD	_EGIC_ _EGAR			.	T1
06/08N	M1		(LO)			(LO) (B)					2
06/09D	—	H F							LULX LULIM		4
06/15D	WO		LIG								WO
06/15D	OK					(S)			(OSX)		2
06/16D	(OK)		S	LO	LO		NEPAW				1
06/16N	B			OCS	H	^				^AR	B
06/16N	—			SRD	H	\		NDIC			1
06/18D	(OK)		OCSLO		F	F					3
06/18N	—					B	TMPIC		DRWAR LRWDIW		4
06/20D	(OK)				ACC				AA		2
TOTAL # OF APPROACHES – 18											

Figure 11-2. APARTS Trend Analysis Form

11.4.1 General Symbols

<u>SYMBOL</u>	<u>APARTS SYMBOL</u>	<u>MEANING</u>
WO	WO	Waveoff
WOP	WOP	Waveoff Pattern
OWO	OWO	Own Waveoff
TWO	TWO	Test Waveoff
TLU	TLU	Test Lineup
<u>OK</u>	<u>OK</u>	Perfect pass
OK	OK	Reasonable deviations with good corrections
(OK)	(OK)	Fair. Reasonable deviations
—	—	No-grade. Below average but safe pass
<del>C</del> →	C	Cut. Unsafe, gross deviations inside waveoff window
<del>B</del> ↗	B	Bolter
NC	NC	No count (used in grade column)
( )	( )	Parentheses around any symbol signifies "a little" (e.g., (F) means "a little fast")







<u>SYMBOL</u>	<u>APARTS SYMBOL</u>	<u>MEANING</u>
<u>      </u>	<u>Comment</u>	Underline. For emphasis
PATT	PATT	Pattern
Ⓐ	(A)	APC/Auto
<del>Ⓐ</del>		APC/Auto downgraded to manual
	M1	Mode I ACLS (record in grade column)
↗		Mode I ACLS, uncoupled after the ball call
•	•	A dot between two symbols indicates "on" (e.g., S• LUIC)
—	—	A dash between two symbols indicates "to" (e.g., HIM-IC)
SQUARE	Comment [ ]	A square around any symbol indicates that a signal was not answered
CIRCLE	Comment ( )	A circle around any symbol indicates that a signal was answered too slowly
Ⓞ	OC	When used as a prefix to any symbol, " " indicates "over controlled"

## 11.4.2 Descriptive Symbols

<u>SYMBOL</u>	<u>APARTS SYMBOL</u>	<u>MEANING</u>	<u>SYMBOL</u>	<u>APARTS SYMBOL</u>	<u>MEANING</u>
AA	AA	Angling approach	HO	HO	Hold off
ACC	ACC	Accelerate	LIG	LIG	Long in the groove
AFU	AFU	All "fouled" up	LL	LL	Landed left
B	B	Flat glideslope	LLU	LLU	Late lineup
	C	Climbing	LO	LO	Low
CB	CB	Coming back to lineup	LR	LR	Landed right
CD	CD	Coming down	LTR	LTR	Left to right
CH	CH	Chased	LU	LU	Lineup
CO	CO	Come-on	LUL	LUL	Lined up left
CU	CU	Cocked up	LUR	LUR	Lined up right
DD	DD	Deck down	LWD	DLW	Left wing down
DEC	DEC	Decelerate	N	N	Nose
DL	DL	Drifted left	NC	NC	Nice correction
DN	DN	Dropped nose	ND	ND	Nose down
DR	DR	Drifted right	NEA	NEA	Not enough attitude
DU	DU	Deck up	NEP	NEP	Not enough power
EG	EG	Eased gun	NERD	NERD	Not enough rate of descent
F	F	Fast	NERR	NERR	Not enough right rudder
FD	FD	Fouled deck	NESA	NESA	Not enough straight away
GLI	GLI	Gliding approach	NH	NH	No hook
H	H	High	NSU	NSU	Not set up

**NAVAIR 00-80T-104**

<u>SYMBOL</u>	<u>APARTS SYMBOL</u>	<u>MEANING</u>
OR	OR	Overrotate
OS	OS	Overshoot
OSCB	OSCB	Overshot coming back
P	P	Power
PD	PD	Pitching deck
PNU	PNU	Pulled nose up
ROT	ROT	Rotate
RUD	RUD	Rudder
RUF or 	RUF	Rough
RWD	DRW	Right wing down
RR	RR	Right rudder
RTL	RTL	Right to left
S	S	Settle
SD	SD	Spotted deck
SHT	SHT	Ship's turn
SKD	SKD	Skid
SLO	SLO	Slow
SRD	SRD	Stopped rate of descent
ST	ST	Steep turn
TCA	TCA	Too close abeam

<u>SYMBOL</u>	<u>APARTS SYMBOL</u>	<u>MEANING</u>
TMA	TMA	Too much attitude
TMP	TMP	Too much power
TMRD	TMRD	Too much rate of descent
TMRR	TMRR	Too much right rudder
TTL	TTL	Turned too late
TTS	TTS	Turned too soon
TWA	TWA	Too wide abeam
W	W	Wings
WU	WU	Wrapped up
XCTL	XCTL	Cross control
	^	Over the top
	LLWD	Landed left wing down
	LRWD	Landed right wing down
	LNF	Landed nose
	3PTS	Landed 3 points
	/	Fly through the glideslope (going up)
	\	Fly through the glideslope (going down)

11.4.3 Symbol Suffixes

<u>SYMBOL</u>	<u>APARTS SYMBOL</u>	<u>MEANING</u>	<u>SYMBOL</u>	<u>APARTS SYMBOL</u>	<u>MEANING</u>
CCA	CCA	Carrier controlled approach	IM	IM	In the middle (middle one-third of the glideslope)
OT	OT	Out of turn (as aircraft rolls wings level)	IC	IC	In close (last one-third of glideslope)
BC	BC	Ball call	AR	AR	At the ramp
X	X	At the start (first one-third of glideslope)	TL	TL	To land
			IW	IW	In the wires
			AW	AW	All the way





## CHAPTER 12

# Aircraft Mishap Statements

## 12.1 GENERAL

It is incumbent upon the LSO to prepare detailed and complete statements regarding aircraft mishaps. It is recognized that the LSO is usually in the best position to evaluate incidents culminating in carrier landing mishaps. The following is an outline of items that are pertinent to most CV landing mishaps. These items should be used, when applicable, in the preparation of LSO statements to aircraft mishap investigation boards. Controlling LSOs shall be afforded access to the PLAT/ILARTS tape (with sound) prior to preparing their statements.

### 12.1.1 LSO Mishap Statement

1. Narrative
  - a. State, as you saw them, the events as they occurred.
  - b. Include an explanation of your actions.
2. Environmental Factors
  - a. Weather — Include both observed and LSO-called.
  - b. Deck conditions — Include list, dutch roll, deck movement in feet, periodicity, and heave.
  - c. Wind — Both direction and velocity, gusts, wind shifts, shears, sink holes, turbulence in the groove, and crosswind component.
  - d. LSO equipment — State what was working or inoperative, and if all problems were passed to the air officer. State if any of the inoperative gear could have had an effect on the recovery.
  - e. LSO horizon — State what was being used as a horizon reference (destroyer position, flares, helo, nothing, etc.).
3. Air Operations
  - a. Had the LSO advised to cancel flight operations prior to the mishap?
  - b. Were air operations canceled after the mishap?
4. LSO Data
  - a. Type qualification, date received, aircraft qualified to wave at the field or ship, and day, night, and MOVLAS experience.
  - b. Date of last formal training.
  - c. Time in LSO duty status for that day, physical condition, and fatigue factor.
  - d. Warfare specialty, type aircraft qualified in as a pilot.
  - e. Any other aircraft qualified in as a pilot, cross-trained in, or received familiarization/orientation flights in.
5. Pilot Performance
  - a. Updated trend analysis from squadron LSO.
  - b. Narrative of the pilot's specific trends.
  - c. Comparison of pilot's performance to that of his experience-level peers.
- f. OLS — Intensity setting, lens settings, and status of deck and drop lights.

#### Note

An Embarked Landing Hazard Report shall be submitted utilizing the format contained in OPNAVINST 3750.6 anytime any part of the landing aircraft impacts on or below the round down, personnel, or equipment in the landing area, or for any other occurrences considered appropriate.



# INDEX

## A

Absence of horizon reference ..... 8-1  
 Air Officer ..... 1-2  
 Aircraft  
     crosstype training ..... 2-1  
     emergencies ..... 7-1  
     mishap statements ..... 12-1  
 Assignment ..... 1-4  
 Automated performance assessment and  
     readiness training system ..... 11-1

## B

Barricade engagements ..... 7-5  
 Briefing and debriefing ..... 5-1, 6-1  
     carrier qualification/currency landing  
         procedures briefing ..... 6-1  
     conduct of field carrier landing practice  
         briefings ..... 5-3  
     pilot landing trend debriefs ..... 6-1  
     postflight debriefing ..... 6-1  
     postsimulator/postflight debriefing ..... 5-3  
     precarrier briefing ..... 5-1  
     recurrent CV procedures training ..... 6-1  
     simulator procedures briefing ..... 5-2  
     special operations procedures briefing ..... 6-1

## C

Carrier air wing predeployment LSO  
     evaluation ..... 10-3  
     formal ground training program  
         evaluation ..... 10-3  
     general ..... 10-3  
     shipboard LSO team performance  
         evaluation ..... 10-4  
 Carrier qualification/currency landing  
     procedures briefing ..... 6-1  
 Carrier qualifications ..... 6-1  
     day qualification ..... 6-1  
     definitions ..... 6-1  
     limitations for initial carrier qualifications ... 6-5  
     LSO certification of pilot performance ..... 6-6

        minimum landings for initial, transition,  
         and requalification ..... 6-1  
     night qualification ..... 6-1  
     training command instructors and students ... 6-5  
     waiver criteria ..... 6-4  
 Circuitry ..... 4-3  
 Classroom training experience ..... 10-3  
 Command relationships and responsibilities of the  
     Landing Signal Officer ..... 1-1  
         air officer ..... 1-2  
         air wing commander ..... 1-2  
         LSO training model manager ..... 1-2  
         ship/air wing commanding officer ..... 1-2  
         squadron commanding officer ..... 1-2  
         type commander ..... 1-1  
 Communication emergencies ..... 7-3  
 Conduct of FCLP ..... 5-5  
 Conduct of Field Carrier Landing Practice  
     briefings ..... 5-3  
 Currency criteria for carrier qualified pilots ... 6-6  
     limitations for currency/refresher landings ... 6-6  
 CV approach/departure procedures ..... 5-4

## D

Datum, waveoff, and cut lights ..... 4-4  
 Day  
     carrier ..... 4-1  
     FCLP ..... 3-1  
     qualification ..... 6-1  
 Descriptive symbols ..... 11-5

## E

Effective glideslope due to wind and deck  
     motion ..... 4-7  
 Effects of  
     deck motion ..... 4-7  
     effects of temperature ..... 4-2  
 Emergency procedures ..... 5-4  
 Excessive deck motion ..... 8-1  
 Excessive deck motion ..... 7-4

## F

Factors affecting LSO readiness ..... 2-2

FCLP ..... 5-4  
 conduct of FCLP ..... 5-5  
 pattern emergencies ..... 7-1  
 performance records ..... 5-5  
 personnel requirements ..... 5-4  
 preflight briefing ..... 5-4  
 traffic pattern control responsibilities ..... 5-4  
 Field evaluation ..... 10-1  
 Field experience ..... 10-1, 10-3  
 Field LSO qualification ..... 10-1  
 certification ..... 10-1  
 field evaluation ..... 10-1  
 field experience ..... 10-1  
 formal ground training ..... 10-1  
 Field training ..... 2-1  
 Flight Deck Hazardous Duty Incentive  
 Pay (FDHIDP) ..... 1-4  
 Focal point and field of view ..... 4-3  
 Formal ground training ..... 2-1, 10-1  
 Foul deck waveoff ..... 6-11  
 Fresnel lens optical landing system ..... 4-2  
 circuitry ..... 4-3  
 datum, waveoff, and cut lights ..... 4-4  
 effective glideslope due to wind and deck  
 motion ..... 4-7  
 effects of deck motion ..... 4-7  
 effects of temperature ..... 4-2  
 focal point and field of view ..... 4-3  
 general operating intensities ..... 4-3  
 inertial mode of stabilization ..... 4-5  
 line stabilization ..... 4-4  
 optical characteristics ..... 4-2  
 roll angle and hook-to-eye ..... 4-8  
 stabilization limits ..... 4-6  
 stabilization modes ..... 4-5  
 system condition indicators ..... 4-4

**G**

General operating intensities ..... 4-3  
 General symbols ..... 11-4

**I**

Inertial mode of stabilization ..... 4-5  
 Intensities ..... 3-2

**L**

Landing aid malfunctions ..... 7-2  
 Landing Signal Officer  
 command relationships and  
 responsibilities of the ..... 1-1  
 role of ..... 1-1  
 Limitations  
 for currency/refresher landings ..... 6-6  
 for initial carrier qualifications ..... 6-5  
 Line stabilization ..... 4-5  
 Log books ..... 11-1  
 LSO  
 base console ..... 4-12  
 certification of pilot performance ..... 5-5, 6-6  
 designation category ..... 1-3  
 designations ..... 1-3  
 greenhouse and radios ..... 3-2  
 heads-up display ..... 4-12  
 LSO training model manager ..... 1-2  
 mishap statement ..... 12-1  
 recommended minimum LSO requirements .. 1-5  
 responsibilities ..... 6-8  
 seniority ..... 1-3  
 trainee nomination procedures ..... 1-3  
 training status matrix ..... 10-4  
 vehicle ..... 3-2  
 LSO Designations ..... 1-3  
 LSO designation category ..... 1-3  
 LSO trainee nomination procedures ..... 1-3  
 upgrading procedures ..... 1-3  
 LSO trainer (device 2H111) ..... 2-2  
 LSO Training Program ..... 2-1  
 aircraft crosstype training ..... 2-1  
 field training ..... 2-1  
 formal ground training ..... 2-1  
 shipboard training ..... 2-1

**M**

Manually operated visual landing aid system .. 4-10  
 MOVLAS construction ..... 4-12  
 Minimum currency requirements ..... 2-2  
 Minimum equipment for field carrier  
 landing practice (FCLP) operations ..... 3-1  
 day FCLP ..... 3-1  
 night FCLP ..... 3-1

Minimum equipment list for  
 shipboard operations . . . . . 4-1  
   day carrier . . . . . 4-1  
   miscellaneous LSO equipment malfunction . . 4-2  
   night carrier . . . . . 4-2  
 Minimum landings for initial transition and  
 requalification . . . . . 6-1  
 Minimum number of FCLP periods . . . . . 5-5  
 Miscellaneous LSO equipment  
 malfunction . . . . . 4-2, 7-4  
 Mk 8 fresnel lens . . . . . 3-2  
 MOVLAS . . . . . 3-2  
   construction . . . . . 4-12  
   during carrier qualifications . . . . . 6-12  
   operating procedures . . . . . 6-12  
   training . . . . . 6-12

**N**

NATOPS Evaluation . . . . . 10-1  
   concepts . . . . . 10-1  
   implementation . . . . . 10-1  
 Night carrier . . . . . 4-2  
 Night FCLP . . . . . 3-1  
 Night qualification . . . . . 6-1  
 Normal recovery operations . . . . . 6-7  
   foul deck waveoff . . . . . 6-11  
   LSO responsibilities . . . . . 6-8  
   MOVLAS during carrier qualifications . . . . 6-12  
   MOVLAS operating procedures . . . . . 6-12  
   MOVLAS training . . . . . 6-12  
   optical landing system limits . . . . . 6-11  
   personnel requirements . . . . . 6-7  
   recovery procedures for final approach . . . . 6-10  
   safety precautions . . . . . 6-11  
   specific LSO and pilot recovery  
   procedures . . . . . 6-10  
   wind over deck (WOD) requirements . . . . . 6-11

**O**

Operation and checks of shore-based  
 visual landing aids . . . . . 3-2  
 Optical  
   characteristics . . . . . 4-2  
   landing system limits . . . . . 6-11

**P**

Personnel requirements . . . . . 5-4, 6-7  
 Pilot  
   landing trend debriefs . . . . . 6-1  
   performance evaluation . . . . . 5-5  
   performance records . . . . . 11-1  
 Pilot Performance evaluation . . . . . 5-5  
   FCLP performance records . . . . . 5-5  
   LSO certification of pilot performance . . . . . 5-5  
   minimum number of FCLP periods . . . . . 5-5  
 Pilot performance records . . . . . 11-1  
   automated performance assessment and  
   readiness training system . . . . . 11-1  
 Pole check . . . . . 3-2  
 Postflight debriefing . . . . . 6-1  
 Postsimulator/postflight debriefing . . . . . 5-3  
 Precarrier briefing . . . . . 5-1  
 Preflight briefing . . . . . 5-4

**R**

Radio communications . . . . . 9-1  
   during emergency situations . . . . . 9-1  
 Recovery procedures for final approach . . . . . 6-10  
 Recurrent CV procedures training . . . . . 6-1  
 Removal of LSO designation . . . . . 10-4  
 Requirements for LSO designation . . . . . 2-2  
 Restricted visibility/ceiling operations . . . . . 8-1  
 Roll angle and hook-to-eye . . . . . 4-8  
 Role of landing signal officer . . . . . 1-1

**S**

Safety Precautions . . . . . 6-11  
 Selection of LSO trainees . . . . . 2-1  
 Ship static mistrim . . . . . 7-5  
 Ship/Air Wing Commanding Officer . . . . . 1-2  
 Shipboard  
   currency . . . . . 10-3  
   emergencies . . . . . 7-1  
   experience . . . . . 10-2  
   LSO experience . . . . . 10-2  
   training . . . . . 2-1  
 Shipboard emergencies . . . . . 7-1  
   aircraft emergencies . . . . . 7-1  
   barricade engagements . . . . . 7-5  
   communication emergencies (day) . . . . . 7-3  
   communication emergencies (general) . . . . . 7-3

**NAVAIR 00-80T-104**

communication emergencies (night) . . . . . 7-3  
excessive deck motion . . . . . 7-4  
landing aid malfunctions . . . . . 7-2  
miscellaneous LSO equipment malfunction . . 7-4  
ship static mistrim . . . . . 7-5  
Shore-based emergencies . . . . . 7-1  
    FCLP pattern emergencies . . . . . 7-1  
Simulator procedures briefing . . . . . 5-2  
Simulator training . . . . . 5-4  
    CV approach/departure procedures . . . . . 5-4  
    emergency procedures . . . . . 5-4  
Special operations procedures briefing . . . . . 6-1  
Specific LSO and pilot recovery procedures . . 6-10  
Squadron commanding officer . . . . . 1-2  
Squadron LSO qualification . . . . . 10-1  
    certification . . . . . 10-2  
    formal ground training . . . . . 10-1  
    shipboard experience . . . . . 10-2  
    written and practical evaluation . . . . . 10-2  
Stabilization  
    limits . . . . . 4-6  
    modes . . . . . 4-5  
Staff LSO qualification . . . . . 10-3  
    certification . . . . . 10-3  
    formal ground training . . . . . 10-3  
    shipboard currency . . . . . 10-3  
Standard log symbols . . . . . 11-1  
    descriptive symbols . . . . . 11-5  
    general symbols . . . . . 11-4  
    symbol suffixes . . . . . 11-7  
Standard LSO phraseology . . . . . 9-1  
Symbol suffixes . . . . . 11-7  
System condition indicators . . . . . 4-4

**T**

Touchdown points . . . . . 3-2

Traffic pattern control responsibilities . . . . . 5-4  
Training command instructors and students . . . . 6-5  
Training LSO carrier qualification (CQ)  
    requirements . . . . . 2-2  
Training LSO qualification . . . . . 10-3  
    certification . . . . . 10-3  
    classroom training experience . . . . . 10-3  
    field experience . . . . . 10-3  
    formal ground training . . . . . 10-3  
    prerequisites . . . . . 10-3  
    shipboard experience . . . . . 10-3  
Type commander . . . . . 1-1

**U**

Upgrading procedures . . . . . 1-3

**V**

Visual landing aids . . . . . 3-1  
    general . . . . . 3-1  
    Mk 8 fresnel lens . . . . . 3-2  
    MOVLAS . . . . . 3-2  
    Operation and checks of shore-based visual  
        landing aids . . . . . 3-2

**W**

Waiver criteria . . . . . 6-4  
Wind Over Deck (WOD) requirements . . . . . 6-11  
Wing LSO qualification . . . . . 10-2  
    certification . . . . . 10-2  
    formal ground training . . . . . 10-2  
    shipboard LSO experience . . . . . 10-2  
    written and practical evaluation . . . . . 10-2  
Written and practical evaluation . . . . . 10-2

**LIST OF EFFECTIVE PAGES**

Effective Pages	Page Numbers
Original	1 (Reverse Blank)
Original	3 (Reverse Blank)
Original	5 (Reverse Blank)
Original	7 (Reverse Blank)
Original	9 (Reverse Blank)
Original	11 thru 16
Original	17 (Reverse Blank)
Original	19 thru 23 (Reverse Blank)
Original	25 (Reverse Blank)
Original	1-1 thru 1-5 (Reverse Blank)
Original	2-1 thru 2-2
Original	27 (Reverse Blank)
Original	3-1 thru 3-2
Original	4-1 thru 4-16
Original	29 (Reverse Blank)

Effective Pages	Page Numbers
Original	5-1 thru 5-5 (Reverse Blank)
Original	6-1 thru 6-13 (Reverse Blank)
Original	31 (Reverse Blank)
Original	7-1 thru 7-5 (Reverse Blank)
Original	33 (Reverse Blank)
Original	8-1 (Reverse Blank)
Original	35 (Reverse Blank)
Original	9-1 thru 9-5 (Reverse Blank)
Original	37 (Reverse Blank)
Original	10-1 thru 10-6
Original	11-1 thru 11-7 (Reverse Blank)
Original	12-1 (Reverse Blank)
Original	Index-1 thru Index-4
Original	LEP-1 (Reverse Blank)

