



NATOPS FLIGHT MANUAL

NAVY MODEL

F/A-18A/B/C/D 161353 AND UP AIRCRAFT

THIS PUBLICATION SUPERSEDES A1-F18AC-NFM-000 DATED
1 AUGUST 2006 CHANGED 15 JUNE 2007

THIS PUBLICATION IS INCOMPLETE WITHOUT
A1-F18AC-NFM-200 and A1-F18AC-NFM-210

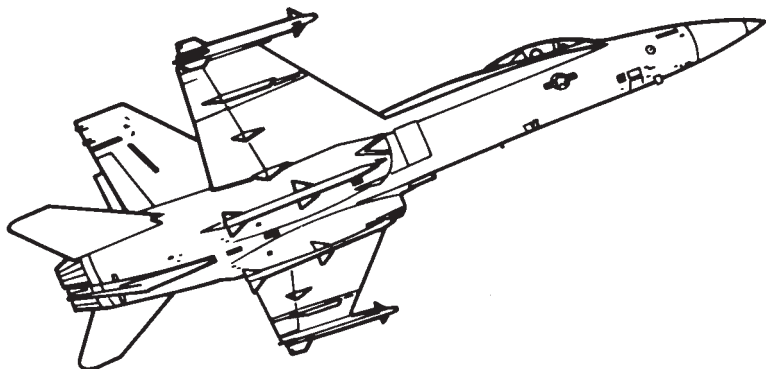

DISTRIBUTION STATEMENT C. Distribution authorized to U.S. Government agencies only and their contractors to protect publications required for official use or for administrative or operational purposes only, determined on 1 August 2006. Other requests for this document shall be referred to Commander, Naval Air Systems Command (PMA-265), RADM William A. Moffett Bldg, 47123 Buse Rd, Bldg 2272, Patuxent River, MD 20670-1547.

DESTRUCTION NOTICE - For unclassified, limited documents, destroy by any method that will prevent disclosure of contents or reconstruction of the document.

ISSUED BY AUTHORITY OF THE CHIEF OF NAVAL OPERATIONS AND
UNDER THE DIRECTION OF THE COMMANDER
NAVAL AIR SYSTEMS COMMAND.

THE AIRCRAFT	1
INDOCTRINATION	2
NORMAL PROCEDURES	3
FLIGHT CHARACTERISTICS	4
EMERGENCY PROCEDURES	5
ALL - WEATHER OPERATION	6
COMMUNICATION PROCEDURES	7
WEAPONS SYSTEMS	8
FLIGHT CREW COORDINATION	9
NATOPS EVALUATION	10
PERFORMANCE DATA	11
INDEX & FOLDOUTS	

A1-F18AC-NFM-000



NATOPS FLIGHT MANUAL

NAVY MODEL

F/A-18A/B/C/D 161353 AND UP AIRCRAFT

THIS PUBLICATION SUPERSEDES A1-F18AC-NFM-000 DATED
1 AUGUST 2006 CHANGED 15 JUNE 2007

THIS PUBLICATION IS INCOMPLETE WITHOUT
A1-F18AC-NFM-200 and A1-F18AC-NFM-210

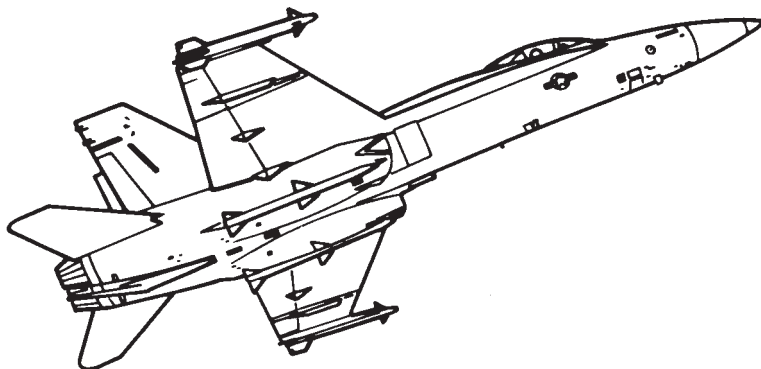

DISTRIBUTION STATEMENT C. Distribution authorized to U.S. Government agencies only and their contractors to protect publications required for official use or for administrative or operational purposes only, determined on 15 September 2008. Other requests for this document shall be referred to Commander, Naval Air Systems Command (PMA-265), RADM William A. Moffett Bldg, 47123 Buse Rd, Bldg 2272, Patuxent River, MD 20670-1547.

DESTRUCTION NOTICE - For unclassified, limited documents, destroy by any method that will prevent disclosure of contents or reconstruction of the document.

ISSUED BY AUTHORITY OF THE CHIEF OF NAVAL OPERATIONS AND
UNDER THE DIRECTION OF THE COMMANDER
NAVAL AIR SYSTEMS COMMAND.

THE AIRCRAFT	1
INDOCTRINATION	2
NORMAL PROCEDURES	3
FLIGHT CHARACTERISTICS	4
EMERGENCY PROCEDURES	5
ALL - WEATHER OPERATION	6
COMMUNICATION PROCEDURES	7
WEAPONS SYSTEMS	8
FLIGHT CREW COORDINATION	9
NATOPS EVALUATION	10
PERFORMANCE DATA	11
INDEX & FOLDOUTS	



DEPARTMENT OF THE NAVY
NAVAL AIR SYSTEMS COMMAND
RADM WILLIAM A. MOFFETT BUILDING
47123 BUSE ROAD, BLDG 2272
PATUXENT RIVER, MD 20670-1547

15 September 2008

LETTER OF PROMULGATION

1. The Naval Air Training and Operating Procedures Standardization (NATOPS) Program is a positive approach toward improving combat readiness and achieving a substantial reduction in the aircraft mishap rate. Standardization, based on professional knowledge and experience, provides the basis for development of an efficient and sound operational procedure. The standardization program is not planned to stifle individual initiative, but rather to aid the Commanding Officer in increasing the unit's combat potential without reducing command prestige or responsibility.
2. This manual standardizes ground and flight procedures but does not include tactical doctrine. Compliance with the stipulated manual requirements and procedures is mandatory except as authorized herein. In order to remain effective, NATOPS must be dynamic and stimulate rather than suppress individual thinking. Since aviation is a continuing, progressive profession, it is both desirable and necessary that new ideas and new techniques be expeditiously evaluated and incorporated if proven to be sound. To this end, Commanding Officers of aviation units are authorized to modify procedures contained herein, in accordance with the waiver provisions established by OPNAV Instruction 3710.7, for the purpose of assessing new ideas prior to initiating recommendations for permanent changes. This manual is prepared and kept current by the users in order to achieve maximum readiness and safety in the most efficient and economical manner. Should conflict exist between the training and operating procedures found in this manual and those found in other publications, this manual will govern.
3. Checklists and other pertinent extracts from this publication necessary to normal operations and training should be made and carried for use in naval aircraft.

A handwritten signature in black ink, appearing to read "S. R. Eastburg", is written over the typed name and title.

S. R. EASTBURG
Rear Admiral, United States Navy
By direction of
Commander, Naval Air Systems Command

NATOPS Flight Manual

CONTENTS

		Page No.
PART I	THE AIRCRAFT	
CHAPTER 1	The Aircraft	
1.1	AIRCRAFT DESCRIPTION	I-1-1
1.1.1	Meet The Hornet.....	I-1-1
1.1.2	Aircraft Dimensions.....	I-1-1
1.1.3	Aircraft Gross Weight.....	I-1-1
1.1.4	Mission.	I-1-2
1.2	BLOCK NUMBERS	I-1-2
CHAPTER 2	Systems	
2.1	POWER PLANT SYSTEMS.....	I-2-1
2.1.1	Engines.....	I-2-1
2.1.2	Automatic Throttle Control (ATC).....	I-2-8
2.2	FUEL SYSTEM	I-2-10
2.2.1	Survivability.....	I-2-10
2.2.2	Fuel Tank Pressurization and Vent.	I-2-10
2.2.3	Internal Transfer	I-2-11
2.2.4	External Transfer.....	I-2-13
2.2.5	Fuel Feed System.....	I-2-13
2.2.6	Fuel Recirculation System.	I-2-16
2.2.7	Fuel Dump System.	I-2-17
2.2.8	Fuel Lo Level Indications.....	I-2-17
2.2.9	Fuel Quantity Indicating System (F/A-18A/B).	I-2-18
2.2.10	Fuel Quantity Indicating System (F/A-18C/D).	I-2-19
2.2.11	Air Refueling System.	I-2-21
2.2.12	Ground Refueling System.....	I-2-22
2.3	FLIGHT PERFORMANCE ADVISORY SYSTEM	I-2-24
2.3.1	Flight Performance Advisory System (FPAS) (F/A-18A Aircraft AFTER AFC 253 OR 292, and F/A-18C/D Aircraft.).....	I-2-24
2.4	SECONDARY POWER SYSTEM	I-2-26
2.4.1	Airframe Mounted Accessory Drive (AMAD).....	I-2-26
2.4.2	Auxiliary Power Unit (APU).....	I-2-28
2.4.3	External Power Start.	I-2-29
2.4.4	Bleed Air Augmentation.	I-2-29
2.5	ELECTRICAL POWER SUPPLY SYSTEM	I-2-30

	Page No.
2.5.1	AC Electrical Power. I-2-30
2.5.2	DC Electrical Power (Aircraft 161353 THRU 161528 BEFORE AFC 049). I-2-31
2.5.3	DC Electrical Power (AIRCRAFT 161702 AND UP AND AIRCRAFT 161353 THRU 161528 AFTER AFC 049)..... I-2-35
2.5.4	External Electrical Power..... I-2-36
2.5.5	Circuit Breakers. I-2-37
2.6	LIGHTING I-2-37
2.6.1	Exterior Lighting. I-2-37
2.6.2	Interior Lighting..... I-2-39
2.7	HYDRAULIC POWER SUPPLY SYSTEM I-2-41
2.7.1	Pumps and Reservoirs. I-2-42
2.7.2	Hydraulic Circuits. I-2-42
2.7.3	Valves. I-2-42
2.7.4	Accumulators. I-2-43
2.8	FLIGHT CONTROL SYSTEM I-2-43
2.8.1	Application. I-2-43
2.8.2	Primary Flight Controls..... I-2-43
2.8.3	Secondary Flight Controls. I-2-54
2.8.4	Flaps. I-2-54
2.9	AUTOMATIC FLIGHT CONTROL SYSTEM (AFCS) I-2-60
2.9.1	AFCS Caution and Advisory Displays..... I-2-60
2.9.2	Pilot Relief Modes I-2-61
2.10	LANDING SYSTEM I-2-64
2.10.1	Landing Gear System..... I-2-64
2.10.2	Nosewheel Steering System. I-2-66
2.10.3	Brake System I-2-66
2.10.4	Launch Bar System..... I-2-68
2.10.5	Arresting Hook System. I-2-69
2.11	WING FOLD SYSTEM I-2-69
2.11.1	Wing Fold Handle. I-2-70
2.12	INSTRUMENTS I-2-71
2.12.1	Pitot-Static System..... I-2-71
2.12.2	Standby Attitude Reference Indicator..... I-2-71
2.12.3	Standby Airspeed Indicator..... I-2-72
2.12.4	Standby Altimeter. I-2-72
2.12.5	RADAR Altimeter Set (AN/APN-194(V))..... I-2-72
2.12.6	Standby Rate of Climb Indicator..... I-2-74
2.12.7	Clock. I-2-74

2.12.8	Integrated Fuel/Engine Indicator (IFEI) Time Displays (F/A-18 C/D).....	I-2-74
2.12.9	Standby Magnetic Compass.....	I-2-76
2.12.10	Angle-Of-Attack (AOA) Indexer.....	I-2-76
2.13	AVIONICS SUBSYSTEM	I-2-76
2.13.1	Mission Computer (MC) System.....	I-2-76
2.13.2	Master Modes.	I-2-87
2.13.3	Cockpit Controls and Displays.....	I-2-87
2.13.4	Multipurpose Display Group.....	I-2-87
2.13.5	Upfront Control (UFC).	I-2-109
2.13.6	Signal Data Computer (F/A-18C/D).....	I-2-112
2.13.7	Video Tape Recording System (VTRS) (Aircraft 161353 THRU 164912 BEFORE AFC 207).	I-2-112
2.13.8	Cockpit Video Recording System (Aircraft 164945 AND UP and Aircraft 163985 THRU 164912 AFTER AFC 207).....	I-2-114
2.13.9	Armpit Camera System.	I-2-115
2.13.10	Tactical Aircraft Moving Map Capability (TAMMAC).....	I-2-115
2.13.11	ALE-39 Countermeasures Dispensing Set (CMDS).	I-2-120
2.13.12	ALE-47 Countermeasures Dispensing Set.	I-2-120
2.14	FIRE DETECTION/EXTINGUISHING SYSTEMS	I-2-120
2.14.1	Fire Warning/Extinguisher Lights/Voice Alert.	I-2-120
2.14.2	Fire Extinguisher Pushbutton.....	I-2-120
2.14.3	APU Fire Extinguishing System.	I-2-121
2.14.4	Engine/AMAD Fire Extinguishing System.	I-2-121
2.14.5	Fire and Bleed Air Test Switch.	I-2-121
2.15	ENTRANCE/EGRESS SYSTEMS	I-2-122
2.15.1	Canopy System.	I-2-122
2.15.2	Boarding Ladder.....	I-2-127
2.15.3	Ejection Seat.	I-2-128
2.16	ENVIRONMENTAL CONTROL SYSTEM	I-2-137
2.16.1	Bleed Air System.	I-2-137
2.16.2	Cockpit Air Conditioning and Pressurization.....	I-2-139
2.16.3	Defogging System.....	I-2-140
2.16.4	Windshield Anti-Ice and Rain Removal System.	I-2-141
2.16.5	Suit Ventilation System.....	I-2-141
2.16.6	Anti-G System.....	I-2-141
2.16.7	Avionics Cooling and Pressurization.....	I-2-141
2.17	EMERGENCY EQUIPMENT	I-2-142
2.17.1	Jettison Systems.....	I-2-142
2.17.2	Warning/Caution/Advisory Lights and Displays.....	I-2-143

**Page
No.**

2.17.3	Voice Alert System.	I-2-144
2.17.4	TAWS - Terrain Awareness Warning System (SCS 17C AND UP). . .	I-2-145
2.17.5	GPWS - Ground Proximity Warning System (MC OFP 10A+ AND UP, 13C AND UP).	I-2-149
2.18	OXYGEN SYSTEM	I-2-154
2.18.1	Normal Oxygen Supply (LOT 4-12).	I-2-154
2.18.2	Emergency Oxygen Supply (LOT 4-12).	I-2-154
2.18.3	On-Board Oxygen Generating System (OBOGS) (LOT 13 AND UP). .	I-2-155
2.18.4	Emergency Oxygen (LOT 13 AND UP).	I-2-158
2.19	AIR DATA COMPUTER (ADC)	I-2-159
2.19.1	Angle-Of-Attack Probes.	I-2-159
2.19.2	Total Temperature Probe.	I-2-160
2.20	STATUS MONITORING SUBSYSTEM	I-2-160
2.20.1	Flight Incident Recorder and Aircraft Monitoring Set (FIRAMS) (F/A-18C/D).	I-2-160
2.20.2	Deployable Flight Incident Recorder Set (DFIRS) (Aircraft 164627 AND UP).	I-2-160
2.20.3	Avionic BIT.	I-2-163
2.20.4	Non-Avionic BIT.	I-2-181
2.20.5	Status Monitoring Backup.	I-2-182
2.20.6	Non-BIT Status.	I-2-182
2.21	JOINT HELMET MOUNTED CUEING SYSTEM (JHMCS)	I-2-185
2.21.1	Helmet Mounted Display (HMD)/Aft Helmet Mounted Display (AHMD).	I-2-185
2.21.2	Electronics Unit (EU).	I-2-188
2.21.3	Cockpit Unit (CU).	I-2-188
2.21.4	Magnetic Transmitter Unit (MTU).	I-2-188
2.21.5	Seat Position Sensor (SPS).	I-2-188
2.21.6	HMD/AHMD OFF/BRT Knobs.	I-2-188
2.21.7	Boresight Reference Unit (BRU).	I-2-188
2.21.8	HMD Video Recording.	I-2-188
2.21.9	Cautions/Advisories.	I-2-188
2.21.10	Configuration Check.	I-2-190
2.21.11	Built-In Test (BIT).	I-2-190
2.21.12	JHMCS Alignment.	I-2-192
2.21.13	HMD/AHMD Symbology.	I-2-199
2.21.14	Navigation Master Mode.	I-2-200
2.21.15	Mission Computer Failure.	I-2-200
2.21.16	Electronic Unit Failure.	I-2-200
2.21.17	Helmet Tracker Failure.	I-2-200
2.21.18	Helmet Not Installed.	I-2-200

**Page
No.**

2.22	FIGHTER/ATTACK/TRAINER/RECCE (F/A-18B/D)	I-2-201
2.22.1	F/A-18B/D Aircraft 161354 THRU 163778.....	I-2-201
2.22.2	F/A-18D Aircraft 163986 AND UP.	I-2-201
2.22.3	Aircraft Dimensions.....	I-2-201
2.22.4	Aircraft Gross Weight.....	I-2-201
2.22.5	Fuel Quantity.....	I-2-202
2.22.6	Canopy System.	I-2-202
2.22.7	Ejection Seat System.	I-2-202
2.22.8	Intercom Controls.	I-2-204
2.22.9	Rear Cockpit.	I-2-204

CHAPTER 3 Service and Handling

3.1	SERVICING	I-3-1
-----	-----------------	-------

CHAPTER 4 Operating Limitations

4.1	AIRCRAFT	I-4-1
4.1.1	Engine Limitations.	I-4-1
4.1.2	Airspeed Limitations.	I-4-2
4.1.3	Prohibited Maneuvers.	I-4-3
4.1.4	CG Limitations.	I-4-6
4.1.5	Lateral Weight Asymmetry Limitations.	I-4-6
4.1.6	Angle-of-Attack (AOA) Limitations.	I-4-7
4.1.7	Weight Limitations.	I-4-8
4.1.8	Acceleration Limitations.	I-4-9
4.2	EXTERNAL STORES.....	I-4-9
4.2.1	Limitations.	I-4-9
4.2.2	Banner Towing Limitations.....	I-4-9
4.2.3	Tow Banner Adapter Limitations.	I-4-9

PART II INDOCTRINATION

CHAPTER 5 Indoctrination

5.1	GROUND TRAINING SYLLABUS	II-5-1
5.1.1	Minimum Ground Training Syllabus.....	II-5-1
5.2	FLIGHT TRAINING SYLLABUS TRAINING PHASES	II-5-1
5.3	PERSONAL FLYING EQUIPMENT	II-5-1
5.3.1	Minimum Requirements.	II-5-1
5.4	QUALIFICATIONS AND CURRENCY REQUIREMENTS	II-5-1
5.4.1	Minimum Flight Qualifications.....	II-5-1
5.4.2	Requirements For Various Flight Phases.	II-5-1

Page No.

5.4.3 Ceiling/Visibility Requirements. II-5-2

5.4.4 Ferry Squadrons. II-5-2

5.5 WAIVERS II-5-2

5.5.1 Unit Commanders Authority. II-5-2

PART III NORMAL PROCEDURES

CHAPTER 6 Flight Preparation

6.1 MISSION PLANNING III-6-1

6.1.1 General. III-6-1

6.1.2 Flight Codes. III-6-1

6.2 BRIEFING/DEBRIEFING III-6-1

6.2.1 Briefing. III-6-1

6.2.2 Debriefing. III-6-3

CHAPTER 7 Shore-Based Procedures

7.1 PREFLIGHT CHECK III-7-1

7.1.1 Line Operations. III-7-1

7.1.2 Exterior Inspection. III-7-1

7.1.3 Before Entering Cockpit III-7-6

7.1.4 Interior Check III-7-9

7.1.5 Engine Start. III-7-13

7.1.6 Before Taxi III-7-18

7.1.7 Taxi. III-7-22

7.2 TAKEOFF III-7-23

7.2.1 Before Takeoff III-7-23

7.2.2 Normal Takeoff. III-7-23

7.2.3 Crosswind Takeoff. III-7-25

7.2.4 Formation Takeoff. III-7-25

7.2.5 After Takeoff. III-7-25

7.2.6 Climb. III-7-25

7.2.7 10,000 Feet. III-7-25

7.2.8 Cruise. III-7-26

7.3 LANDING III-7-26

7.3.1 Descent/Penetration. III-7-26

7.3.2 Approach. III-7-27

7.3.3 Touchdown. III-7-27

7.3.4 Nosewheel Steering. III-7-27

7.3.5 Landing Rollout. III-7-28

7.3.6 Braking Technique. III-7-28

7.3.7 Crosswind Landing. III-7-29

		Page No.
7.3.8	Wet Runway Landing.....	III-7-29
7.3.9	Asymmetric Stores Landing.....	III-7-30
7.3.10	Waveoff.	III-7-30
7.4	POSTFLIGHT	III-7-32
7.4.1	After Landing.	III-7-32
7.4.2	Hot Refueling.....	III-7-33
7.4.3	Before Engine Shutdown.	III-7-33
7.4.4	Engine Shutdown	III-7-34
7.5	REAR COCKPIT PROCEDURES (F/A-18B/D)	III-7-36
7.5.1	Before Entering Cockpit	III-7-36
7.5.2	Interior Check	III-7-36
7.5.3	Before Taxi	III-7-37
7.5.4	Before Takeoff	III-7-38
7.5.5	Descent/Penetration	III-7-38
7.5.6	Approach	III-7-38
7.5.7	After Landing	III-7-38
7.5.8	Before Engine Shutdown.....	III-7-39
7.6	NIGHT FLYING	III-7-39
7.6.1	External Light Management.	III-7-39
CHAPTER 8	Carrier-Based Procedures	
8.1	GENERAL	III-8-1
8.1.1	Carrier Electromagnetic Environment.....	III-8-1
8.1.2	Carrier INS Environment.	III-8-2
8.2	DAY OPERATIONS	III-8-2
8.2.1	Preflight.....	III-8-2
8.2.2	Engine Start.....	III-8-2
8.2.3	Taxi.	III-8-2
8.2.4	Hangar Deck Operation.....	III-8-3
8.2.5	Before Catapult Hook-Up.....	III-8-3
8.2.6	Catapult Hook-Up.....	III-8-4
8.2.7	Catapult Afterburner Operation.....	III-8-6
8.2.8	Catapult Launch.....	III-8-7
8.2.9	Catapult Suspend.....	III-8-8
8.2.10	Landing Pattern.	III-8-8
8.2.11	ATC Approach Mode Technique.....	III-8-9
8.2.12	Glideslope.	III-8-9
8.2.13	Waveoff.	III-8-9
8.2.14	ACL Mode 1 and 1A Approaches.	III-8-12
8.2.15	ACL Mode 2 Approach.	III-8-13
8.2.16	Arrested Landing and Exit From the Landing Area.....	III-8-14

**Page
No.**

8.3	NIGHT OPERATIONS	III-8-14
8.3.1	General.....	III-8-14
8.3.2	Preflight.....	III-8-17
8.3.3	Before Taxi.....	III-8-17
8.3.4	Taxi.....	III-8-17
8.3.5	Catapult Hook-Up.....	III-8-17
8.3.6	Catapult Launch.....	III-8-17
8.3.7	Aircraft or Catapult Malfunction.....	III-8-17
8.3.8	Landing Pattern.....	III-8-17
8.3.9	Arrestment and Exit From the Landing Area.....	III-8-17
8.4	SECTION CCA	III-8-17
 CHAPTER 9 Special Procedures		
9.1	FORMATION FLIGHT	III-9-1
9.1.1	Formation Taxi/Takeoff.....	III-9-1
9.1.2	Aborted Takeoff.....	III-9-1
9.1.3	Parade.....	III-9-3
9.1.4	Cruise Formation.....	III-9-3
9.1.5	Section Approaches/Landing.....	III-9-5
9.2	AIR REFUELING	III-9-6
9.2.1	Before Plug-in.....	III-9-6
9.2.2	Refueling Technique.....	III-9-6
9.3	BANNER TOWING SYSTEM	III-9-8
9.3.1	Banner Towed Target Equipment.....	III-9-8
9.3.2	Ground Procedures.....	III-9-8
9.3.3	Flight Procedures.....	III-9-8
9.3.4	Target Chase Procedures.....	III-9-10
9.4	NIGHT VISION DEVICE (NVD) OPERATIONS	III-9-11
9.4.1	Effects on Vision.....	III-9-11
9.4.2	Effects of Light.....	III-9-11
9.4.3	Weather Conditions.....	III-9-11
9.4.4	Object/Target Detection.....	III-9-12
9.4.5	Flight Preparation.....	III-9-12
9.5	SHORT AIRFIELD FOR TACTICAL SUPPORT (SATS) PROCEDURES	III-9-12
9.5.1	Landing Pattern.....	III-9-12
9.5.2	Approach.....	III-9-12
9.5.3	Waveoff.....	III-9-12
9.5.4	Arrested Landing.....	III-9-12
9.5.5	Bolter.....	III-9-12

**Page
No.**

9.5.6	Hot Seat Procedure.....	III-9-13
9.5.7	Alert Scramble Launch Procedures.....	III-9-13
9.6	AIRBORNE HMD ACCURACY CHECKS	III-9-15
9.6.1	HMD Alignment.....	III-9-15
9.6.2	Airborne HMD Accuracy Check with Radar.	III-9-16
9.6.3	Airborne HMD Accuracy Check with CATM/AIM-9X.	III-9-16
CHAPTER 10	Functional Checkflight Procedures	
10.1	GENERAL	III-10-1
10.2	FCF CHECKLIST - PROFILE A (Includes combined profiles B and C).....	III-10-2
10.2.1	F/A-18A/C (F/A-18B/D Front Cockpit)	III-10-2
10.2.2	Checkflight Requirements (Rear Cockpit).....	III-10-27
10.3	FCF CHECKLIST - PROFILE B	III-10-30
10.3.1	F/A-18A/C (F/A-18B/D Front Cockpit)	III-10-30
10.4	FCF CHECKLIST - PROFILE C	III-10-37
10.4.1	F/A-18A/C (F/A-18B/D Front Cockpit)	III-10-37
10.4.2	Checkflight Requirements (Rear Cockpit).....	III-10-43
10.5	FCF CHECKLIST - PROFILE D	III-10-44
10.5.1	Checkflight Requirements (Rear Cockpit).....	III-10-44
PART IV	FLIGHT CHARACTERISTICS	
CHAPTER 11	Flight Characteristics	
11.1	HANDLING QUALITIES.....	IV-11-1
11.1.1	Flight Control Modes.....	IV-11-1
11.1.2	HALF or FULL Flap Configuration.	IV-11-1
11.1.3	Auto Flap Configuration.....	IV-11-3
11.1.4	Pitch Stability.....	IV-11-3
11.1.5	Stick Force.	IV-11-3
11.1.6	Pitch Up.....	IV-11-4
11.1.7	G-Limiter.....	IV-11-4
11.1.8	Aircraft Stability and Dynamic Response.	IV-11-4
11.1.9	Flying Qualities with Lateral Weight Asymmetries.....	IV-11-6
11.2	OUT-OF-CONTROL FLIGHT (OCF)	IV-11-7
11.2.1	Departure Resistance.	IV-11-7
11.2.2	Departure Characteristics.....	IV-11-8
11.2.3	OCF Recovery.	IV-11-10
11.2.4	Falling Leaf Mode.....	IV-11-11

11.2.5	Spins.	IV-11-12
11.3	DEGRADED MODE HANDLING QUALITIES.....	IV-11-16
11.3.1	Single Engine Operation.	IV-11-17
11.3.2	FCS Degraded Modes (DEL/MECH).	IV-11-17
11.3.3	Loss of INS data to FCCs.	IV-11-18
11.3.4	Leading Edge Flap Failures.....	IV-11-19
11.3.5	Trailing Edge Flap Failures.....	IV-11-19
11.3.6	Gain Override.....	IV-11-19
11.4	CENTER OF GRAVITY (CG)	IV-11-21
11.4.1	CG Determination.	IV-11-21

PART V EMERGENCY PROCEDURES

EMERGENCY INDEX

CHAPTER 12 General Emergencies

12.1	GENERAL.....	V-12-1
12.1.1	Immediate Action Items.	V-12-1
12.1.2	Warnings, Cautions, and Advisories.....	V-12-1

CHAPTER 13 Ground Emergencies

13.1	ENGINE FAILS TO START/HUNG START	V-13-1
13.2	HOT START	V-13-1
13.3	GROUND FIRE	V-13-1
13.3.1	HOT BRAKES/BRAKE FIRE.	V-13-2
13.4	EGRESS	V-13-3
13.5	BRAKE FAILURE/EMERGENCY BRAKES	V-13-4

CHAPTER 14 Takeoff Emergencies

14.1	EMERGENCY CATAPULT FLYAWAY	V-14-1
14.2	ABORT	V-14-2
14.3	GO AROUND.....	V-14-3
14.4	LOSS of DIRECTIONAL CONTROL DURING TAKEOFF or LANDING (BLOWN TIRE, NWS FAILURE)	V-14-3

Page No.

14.5 LOSS OF THRUST ON TAKEOFF V-14-4

14.6 LANDING GEAR FAILS TO RETRACT V-14-5

14.7 WOW SYSTEM FAILURE V-14-7

CHAPTER 15 Inflight Emergencies

15.1 ENGINE FIRE IN FLIGHT V-15-1

15.2 AFTERBURNER FAILURE V-15-1

15.3 UNRESPONSIVE ENGINE V-15-1

15.3.1 ENGINE STUCK AT MIL (AFTER DESELECTING AFTERBURNER) V-15-1

15.3.2 STUCK THROTTLE/ ENGINE FAILS TO RESPOND V-15-2

15.4 ENGINE FAILURE V-15-3

15.5 ASYMMETRIC THRUST EFFECTS V-15-4

15.6 ENGINE STALL V-15-4

15.7 RESTART V-15-5

15.8 POWER TRANSMISSION SHAFT (PTS) FAILURE..... V-15-9

15.9 HYDRAULIC FAILURE V-15-9

15.10 FUSELAGE FUEL LEAK V-15-15

15.11 FUEL TRANSFER FAILURES V-15-16

15.11.1 Aircraft 161353 THRU 161519 BEFORE AFC 039. V-15-16

15.11.2 Aircraft 161353 THRU 161519 AFTER AFC 039 AND 161520 AND UP. V-15-17

15.12 FEED TANK TRANSFER FAILURE V-15-17

15.13 EXTERNAL TANK TRANSFER FAILURE V-15-17

15.14 UNCOMMANDED FUEL DUMP V-15-18

15.15 EMERGENCY TANKER DISENGAGEMENT V-15-19

15.16 CSC MUX FAILURE V-15-19

		Page No.
15.17	DOUBLE GENERATOR OR DOUBLE TRANSFORMER-RECTIFIER FAILURE	V-15-19
15.17.1	Double Generator Failure.....	V-15-19
15.17.2	Transformer-Rectifier Failure.	V-15-19
15.18	LOSS OF DC ESSENTIAL BUS	V-15-21
15.18	AMAD CAUTION	V-15-26
15.19	AMAD PR CAUTION	V-15-26
15.20	OXYGEN LEAK (Aircraft 161353 THRU 164068)	V-15-26
15.21	HYPOXIA/LOW MASK FLOW/NO MASK FLOW.....	V-15-27
15.22	OBOGS DEGRADE/FAILURE (Cautions of any duration)	V-15-28
15.23	COCKPIT TEMPERATURE HIGH	V-15-29
15.24	COCKPIT SMOKE, FUMES, OR FIRE	V-15-30
15.25	LOSS OF CABIN PRESSURIZATION.....	V-15-31
15.26	DISPLAY MALFUNCTION	V-15-32
15.27	EXTERNAL STORES JETTISON	V-15-32
15.28	ADC FAILURE EFFECTS.....	V-15-34
15.29	FCS FAILURE INDICATIONS AND EFFECTS	V-15-34
15.29.1	Invalid FCS Status Display	V-15-34
15.30	FCS FAILURE	V-15-45
15.31	AOA PROBE DAMAGE	V-15-45
15.31.1	AOA Indications with AOA Probe Damage.....	V-15-45
15.31.2	Jammed AOA Probe On Takeoff.....	V-15-47
15.32	PITOT STATIC PROBE DAMAGE.	V-15-48
15.33	DIRECT ELECTRICAL LINK (DEL)	V-15-49
15.33.1	Digital DEL - DEL ON Caution.	V-15-49
15.33.2	Digital DEL.	V-15-49
15.33.3	Analog DEL.	V-15-50
15.34	UNCOMMANDED PITCH AND ROLL EXCURSIONS	V-15-51

15.34.1	Uncommanded Roll Excursion with Aileron Surface Missing/Damaged.....	V-15-52
15.35	MECH ON CAUTION	V-15-56
15.36	MECH ON WITH AIL AND RUD OPERATIVE	V-15-56
15.37	MECH ON WITH AIL AND RUD OFF.....	V-15-57
15.38	FLAPS OFF CAUTION	V-15-57
15.38.1	LEF FAILED (WITH INBOARD POSITION FAILED UP BEYOND 4° OVER-TRAVEL STOP).....	V-15-58
15.38.2	LEF FAILED (WITH INBOARD POSITION LESS THAN 4° UP) OR TEF FAILED	V-15-59
15.39	FLAP SCHED CAUTION	V-15-59
15.40	NWS CAUTION	V-15-60
15.41	AILERON FAILURE/AIL OFF CAUTION	V-15-60
15.42	JAMMED CONTROLS	V-15-60
15.43	OUT-OF-CONTROL FLIGHT (OCF)	V-15-60
15.43.1	Departure.....	V-15-61
15.43.2	Falling Leaf.....	V-15-61
15.43.3	Spin.	V-15-61
15.43.4	OCF Recovery Procedures.....	V-15-62
15.43.5	Post Departure Dive Recovery	V-15-62
15.44	CONTROLLABILITY CHECK	V-15-63
CHAPTER 16	Landing Emergencies	
16.1	SINGLE ENGINE FAILURE IN LANDING CONFIGURATION ..	V-16-1
16.2	SINGLE ENGINE WAVEOFF/BOLTER	V-16-2
16.3	SINGLE ENGINE APPROACH AND LANDING	V-16-2
16.4	FORCED LANDING	V-16-6
16.5	PLANING LINK FAILURE	V-16-6
16.6	LANDING GEAR UNSAFE/FAILS TO EXTEND.....	V-16-8
16.7	LANDING GEAR EMERGENCY EXTENSION	V-16-9

**Page
No.**

16.8	HOOK FAILS TO EXTEND	V-16-15
16.9	LANDING WITH AFT CG	V-16-15
16.10	AUTO FLAP LANDING	V-16-16
16.11	FIELD ARRESTMENT	V-16-16
16.11.1	Field Arresting Gear.....	V-16-16
16.11.2	Short Field Arrestment.....	V-16-16
16.11.3	Long Field Arrestment.....	V-16-17
16.12	FIELD ARRESTMENT GEAR DATA	V-16-17
16.13	BARRICADE ARRESTMENT	V-16-17
CHAPTER 17	Ejection	
17.1	EJECTION	V-17-1
17.1.1	General Injury Risks.	V-17-2
17.1.2	Injury Risks For Lighter Weight Crewmembers.	V-17-2
17.1.3	Injury Risks For Heavier Weight Crewmembers.	V-17-3
17.1.4	Low Altitude Ejection.	V-17-3
17.1.5	High Altitude Ejection.	V-17-4
17.1.6	Ejection Procedures.....	V-17-4
17.2	DITCHING	V-17-4
17.3	SEAWATER ENTRY	V-17-5
CHAPTER 18	Immediate Action	
18.1	GENERAL.....	V-18-1
18.2	APU FIRE LIGHT	V-18-1
18.3	DUAL L BLEED and R BLEED WARNING LIGHTS / L/R ATS CAUTION / DUAL L/R BLD OFF CAUTION	V-18-1
18.4	SINGLE L BLEED or R BLEED WARNING LIGHT	V-18-1
18.5	FIRE LIGHT	V-18-2
18.6	ENGINE CAUTIONS/ ENGINE STALL	V-18-2
18.7	OBOGS DEGD CAUTION	V-18-2
18.8	FLIGHT CONTROL CAUTIONS	V-18-3

Page No.

18.9 FLAPS OFF CAUTION V-18-3

18.10 HOT START V-18-3

18.11 BRAKE FAILURE/EMERGENCY BRAKES V-18-3

18.12 EMERGENCY CATAPULT FLYAWAY V-18-3

18.13 ABORT V-18-3

18.14 LOSS OF DIRECTIONAL CONTROL DURING TAKEOFF OR LANDING (BLOWN TIRE, NWS FAILURE) / PLANING LINK FAILURE V-18-4

18.15 DOUBLE GENERATOR OR DOUBLE TRANSFORMER - RECTIFIER FAILURE V-18-4

18.16 HYPOXIA/LOW MASK FLOW/NO MASK FLOW V-18-4

18.17 COCKPIT SMOKE, FUMES, OR FIRE V-18-4

18.18 LOSS OF CABIN PRESSURIZATION..... V-18-4

18.19 CABIN CAUTION LIGHT..... V-18-5

18.20 OCF RECOVERY V-18-5

18.21 SINGLE ENGINE FAILURE IN LANDING CONFIGURATION... V-18-5

PART VI ALL WEATHER PROCEDURES

CHAPTER 19 Instrument Flight

19.1 INSTRUMENT FLIGHT VI-19-1

19.1.1 Before Takeoff..... VI-19-1

19.1.2 In Flight..... VI-19-1

19.1.3 Approaches VI-19-1

19.2 DEGRADED SYSTEMS VI-19-1

CHAPTER 20 Extreme Weather Procedures

20.1 ICE AND RAIN..... VI-20-1

20.1.1 Ground Operation VI-20-2

20.1.2 In Flight VI-20-2

20.2 TURBULENT AIR AND THUNDERSTORM OPERATION VI-20-4

CHAPTER 21	Hot Weather Procedures	
21.1	BEFORE TAKEOFF	VI-21-1
21.2	IN FLIGHT	VI-21-1
21.3	DESCENT	VI-21-1
21.4	AFTER LANDING	VI-21-1
CHAPTER 22	Cold Weather Procedures	
22.1	EXTERIOR INSPECTION	VI-22-1
22.2	BEFORE ENTERING COCKPIT	VI-22-1
22.3	INTERIOR CHECK	VI-22-1
22.4	ENGINE START	VI-22-1
22.5	BEFORE TAXI	VI-22-1
22.5.1	Aircraft 164196 THRU 164912 BEFORE AFC 216.	VI-22-1
22.6	TAKEOFF	VI-22-2
PART VII	COMM-NAV EQUIPMENT AND PROCEDURES	
CHAPTER 23	Communication-Identification Equipment	
23.1	INTERCOM SYSTEM	VII-23-1
23.1.1	Volume Control Before AFC 268.	VII-23-1
23.1.2	Volume Control After AFC 268.	VII-23-1
23.2	VHF/UHF AND MIDS COMMUNICATION SYSTEM	VII-23-1
23.2.1	VHF/UHF/MIDS Controls and Indicators.	VII-23-3
23.2.2	Normal and Plain Operation.....	VII-23-6
23.3	SECURE SPEECH SYSTEM (KY-58)	VII-23-7
23.3.1	KY-58 Control Panel Assembly.	VII-23-7
23.3.2	Controls and Indicators.	VII-23-7
23.3.3	KY-58 Operation.	VII-23-8
23.4	HAVE QUICK OPERATION AND OPTIONS (ARC-210) (AIRCRAFT 164945 AND UP, F/A-18A AFTER AFC 253 OR 292 AND AIRCRAFT 163427 THRU 164912 AFTER AFC 185.)	VII-23-9
23.4.1	Preset Mode.	VII-23-9

23.4.2	Using HQ Time Options.	VII-23-10
23.5	SINGGARS OPERATION AND OPTIONS	VII-23-13
23.5.1	Preset Mode.	VII-23-13
23.5.2	Using Time Options in SG Display.	VII-23-13
23.5.3	Performing Electronic Remote Fill (ERF) with ERF Option.	VII-23-14
23.6	IDENTIFICATION SYSTEM	VII-23-15
23.6.1	Combined Interrogator Transponder (Aircraft 165222 AND UP, F/A-18A AFTER AFC 292, AND Aircraft 163985 THRU 165221 AFTER AFC 236).	VII-23-15
23.6.2	IFF Controls and Indicators.	VII-23-18
23.6.3	IFF Emergency Operation.	VII-23-20
23.7	COMMUNICATION-NAVIGATION-IDENTIFICATION INTERFACE	VII-23-20
CHAPTER 24	Navigation Equipment	
24.1	NAVIGATION CONTROLS AND INDICATORS.....	VII-24-1
24.1.1	UFC.	VII-24-1
24.1.2	Moving Map - Digital Map Set (DMS) (163985 AND UP).....	VII-24-1
24.1.3	HSI Display.	VII-24-2
24.1.4	DDI.	VII-24-6
24.1.5	HUD.	VII-24-6
24.1.6	Sensor Control Panel.	VII-24-6
24.1.7	Course Select Switch.....	VII-24-10
24.1.8	Communication Control Panel.	VII-24-10
24.2	INERTIAL NAVIGATION SYSTEM (INS)/GLOBAL POSITIONING SYSTEM (GPS)	VII-24-10
24.2.1	Inertial Navigation Unit (INU).	VII-24-11
24.2.2	INS BIT.....	VII-24-13
24.2.3	INS Alignment Modes.	VII-24-13
24.2.4	INS Check Display.	VII-24-22
24.2.5	Waypoints, Offset Aimpoints (OAP) and Offsets.	VII-24-23
24.2.6	Position Keeping.	VII-24-39
24.2.7	Position Updating.	VII-24-40
24.2.8	NAV/TAC Bank Limit Options (MC OFP 13C AND UP).....	VII-24-42
24.2.9	Steering.	VII-24-42
24.2.10	Designation.....	VII-24-48
24.2.11	INS Updates (Not available in AINS)	VII-24-53
24.3	ADF (Automatic Direction Finder).....	VII-24-54
24.4	TACAN (Tactical Air Navigation).	VII-24-55
24.4.1	TACAN BIT.....	VII-24-55

Page No.

24.4.2 TACAN Mode Selection. VII-24-56
 24.4.3 TACAN Programming. VII-24-56
 24.4.4 TACAN Position Keeping. VII-24-56
 24.4.5 TACAN Position Updating. VII-24-57

24.5 ILS (INSTRUMENT LANDING SYSTEM) VII-24-61
 24.5.1 ILS Receiver..... VII-24-61
 24.5.2 ILS Decoder. VII-24-61
 24.5.3 ILS BIT. VII-24-61
 24.5.4 ILS Initialization. VII-24-61
 24.5.5 ILS Steering..... VII-24-62

24.6 DATA LINK SYSTEM VII-24-64
 24.6.1 Automatic Carrier Landing Mode..... VII-24-64

CHAPTER 25 Backup/Degraded Operations

25.1 MISSION COMPUTER NO. 1 FAILURE VII-25-1
 25.1.1 Status Monitoring Functions..... VII-25-1
 25.1.2 Navigation Functions. VII-25-1
 25.1.3 Backup HUD Display..... VII-25-1
 25.1.4 Backup HSI Display..... VII-25-1

25.2 BACKUP ATTITUDE AND NAVIGATION SYSTEM VII-25-2
 25.2.1 Standby Attitude Reference Indicator..... VII-25-2
 25.2.2 Static Power Inverter. VII-25-2
 25.2.3 Magnetic Azimuth Detector..... VII-25-2
 25.2.4 Backup Attitude and Navigation System Controls and Indicators. ... VII-25-2

25.3 NAVIGATION BACKUP VII-25-3
 25.3.1 Navigation Controls and Indicators VII-25-4
 25.3.2 Backup Heading Mode Control. VII-25-4

25.4 BACKUP FREQUENCY CONTROL VII-25-5

CHAPTER 26 Visual Communications

CHAPTER 27 Deck/Ground Handling Signals

PART VIII WEAPONS SYSTEMS

PART IX FLIGHT CREW COORDINATION

CHAPTER 28 Crew Resource Management

28.1 DEFINITION IX-28-1

Page No.

28.2 CRITICAL SKILLS OF CREW RESOURCE MANAGEMENT IX-28-1

28.2.1 Decision Making..... IX-28-1

28.2.2 Assertiveness. IX-28-1

28.2.3 Mission Analysis..... IX-28-1

28.2.4 Communication..... IX-28-1

28.2.5 Leadership. IX-28-1

28.2.6 Adaptability/Flexibility. IX-28-2

28.2.7 Situational Awareness..... IX-28-2

28.2.8 Factors That Degrade Crew Resource Management IX-28-2

28.3 FLIGHT MEMBER POSITIONS IX-28-2

28.3.1 Mission Commander..... IX-28-2

28.3.2 Pilot In Command..... IX-28-3

28.3.3 Formation Leader..... IX-28-3

28.3.4 Crew Member..... IX-28-3

28.3.5 Weapons and Sensors Officer. IX-28-3

28.4 AIRCREW RESPONSIBILITIES BY FLIGHT PHASE..... IX-28-3

28.4.1 Mission Planning and Briefing..... IX-28-3

28.4.2 Pretakeoff. IX-28-3

28.4.3 Takeoff/Departure..... IX-28-4

28.4.4 Enroute..... IX-28-4

28.4.5 Recovery..... IX-28-4

28.4.6 Mission Critique..... IX-28-4

28.5 SPECIAL CONSIDERATIONS IX-28-5

28.5.1 Functional Checkflights..... IX-28-5

28.5.2 Formation Flights..... IX-28-5

28.5.3 Air Combat Maneuvering (ACM). IX-28-5

28.6 EMERGENCIES IX-28-5

PART X NATOPS EVALUATION

CHAPTER 29 NATOPS Evaluation

29.1 CONCEPT X-29-1

29.1.1 Implementation..... X-29-1

29.1.2 Definitions..... X-29-1

29.2 GROUND EVALUATION X-29-2

29.2.1 General..... X-29-2

29.3 FLIGHT EVALUATION X-29-3

29.3.1 Mission Planning/Briefing..... X-29-3

29.3.2 Preflight/Line Operations..... X-29-3

29.3.3 Taxi X-29-4

**Page
No.**

29.3.4 Takeoff (*)..... X-29-4
29.3.5 Climb/Cruise X-29-4
29.3.6 Approach/Landing (*)..... X-29-4
29.3.7 Communications..... X-29-4
29.3.8 Emergency/Malfunction Procedures (*). X-29-4
29.3.9 Post Flight Procedures X-29-4
29.3.10 Mission Evaluation. X-29-4
29.3.11 Applicable Publications..... X-29-4
29.3.12 Flight Evaluation Grading Criteria..... X-29-5
29.3.13 Flight Evaluation Grade Determination..... X-29-5

29.4 NATOPS EVALUATION QUESTION BANK X-29-6

**PART XI PERFORMANCE DATA
APPENDIX
FOLDOUTS**

LIST OF ILLUSTRATIONS

	Page No.
PART I	THE AIRCRAFT
CHAPTER 1	The Aircraft
Figure 1-1	General Arrangement (F/A-18A/C) I-1-2
Figure 1-2	Block Numbers..... I-1-3
CHAPTER 2	Systems
Figure 2-1	Afterburner Light-Off Time I-2-2
Figure 2-2	Throttle Grips..... I-2-4
Figure 2-3	Engine Monitor Display (EMD) I-2-6
Figure 2-4	Tank 1 and 4 Fuel CG Control and FUEL XFER Caution Schedule . I-2-14
Figure 2-5	Fuel Display..... I-2-21
Figure 2-6	Fuel Quantity (F/A-18A/C)..... I-2-23
Figure 2-7	FPAS Display I-2-25
Figure 2-8	Secondary Power Supply I-2-27
Figure 2-9	Electrical System..... I-2-33
Figure 2-10	Ground Power Panel and Placard I-2-38
Figure 2-11	Hydraulic System I-2-44
Figure 2-12	Flight Control System Functional Diagram I-2-46
Figure 2-13	Control Stick I-2-47
Figure 2-14	SPIN Recovery Display..... I-2-50
Figure 2-15	Flap Schedules I-2-56
Figure 2-16	FCS Status Display..... I-2-59
Figure 2-17	AFCS Controls and Indicators..... I-2-62
Figure 2-18	Emergency/Parking Brake Handle..... I-2-68
Figure 2-19	Angle of Attack Indexer I-2-77
Figure 2-20	Mission Computer Functions and Multiplex System I-2-79
Figure 2-21	MUMI Display I-2-85
Figure 2-22	Menu Display I-2-90
Figure 2-23	Electronic Attitude Display Indicator..... I-2-91
Figure 2-24	HI/MPCD/AMPCD Controls and HSI Symbology I-2-97
Figure 2-25	HUD Controls..... I-2-100
Figure 2-26	HUD Symbology I-2-105
Figure 2-27	HUD Symbology Degrades I-2-110
Figure 2-28	Upfront Control (UFC)..... I-2-111
Figure 2-29	AMU Maintenance Format..... I-2-117
Figure 2-30	Map Loading Format..... I-2-117
Figure 2-31	Canopy Birdstrike Resistance..... I-2-125
Figure 2-32	Canopy Controls I-2-126
Figure 2-33	Boarding Ladder I-2-127
Figure 2-34	SJU-17 Ejection Modes..... I-2-129

**Page
No.**

Figure 2-35	Leg Restraint System.....	I-2-132
Figure 2-36	Survival Kit	I-2-135
Figure 2-37	Cockpit Pressurization Schedules.....	I-2-139
Figure 2-38	TAWS ON/OFF Pushbutton	I-2-146
Figure 2-39	TAWS HUD Visual Recovery Cue - Pull Up (VRT)	I-2-148
Figure 2-40	TAWS HUD Visual Recovery Cue - Pull Up (ORT)	I-2-149
Figure 2-41	Visual Warning Cue	I-2-153
Figure 2-42	OBOGS Monitor	I-2-156
Figure 2-43	Status Monitoring Subsystem	I-2-161
Figure 2-44	Flight Aids Reversion Mechanization	I-2-163
Figure 2-45	Caution/Advisory Indications.....	I-2-166
Figure 2-46	BIT Control Display.....	I-2-168
Figure 2-47	ADC/INS/GPS BIT - AUTO BIT Display	I-2-176
Figure 2-48	DSPL/EPI (IFEI)/UFC BIT Displays	I-2-177
Figure 2-49	Configuration Display (Sample)	I-2-183
Figure 2-50	INS Post Flight Data Displays	I-2-184
Figure 2-51	JHMCS Upper HVI Routing	I-2-187
Figure 2-52	HMD Controls	I-2-189
Figure 2-53	Boresight Reference Unit.....	I-2-190
Figure 2-54	Displays BIT Sublevel.....	I-2-191
Figure 2-55	HMD/AHMD Test Patterns.....	I-2-193
Figure 2-56	Coarse Alignment	I-2-194
Figure 2-57	Fine Alignment.....	I-2-197
Figure 2-58	Alignment Verification	I-2-199
Figure 2-59	General Arrangement (F/A-18B/D)	I-2-202
Figure 2-60	Fuel Quantity (F/A-18B/D).....	I-2-203
Figure 2-61	Hand Controllers (F/A-18D Aircraft 163986 AND UP).....	I-2-208

CHAPTER 4 Operating Limitations

Figure 4-1	Airspeed Limitations	I-4-3
Figure 4-2	System Limitations.....	I-4-3
Figure 4-3	Acceleration Limitations.....	I-4-10
Figure 4-4	External Stores Limitations	I-4-12

PART II INDOCTRINATION

PART III NORMAL PROCEDURES

CHAPTER 7 Shore-Based Procedures

Figure 7-1	Checklist Display.....	III-7-24
Figure 7-2	Field Landing Pattern Typical.....	III-7-31

CHAPTER 8 Carrier-Based Procedures

**Page
No.**

Figure 8-1	Launch Trim	III-8-5
Figure 8-2	Carrier Landing Pattern	III-8-10
Figure 8-3	Carrier Controlled Approach (CCA)	III-8-11
Figure 8-4	ACL Mode 1 and 1A Approaches	III-8-15
Figure 8-5	ACL Mode 2 Approach	III-8-16

CHAPTER 9 Special Procedures

Figure 9-1	Formation Takeoff Runway Alignments	III-9-2
Figure 9-2	Formations	III-9-4

CHAPTER 10 Functional Checkflight Procedures

Figure 10-1	EGT and N 1 Limits	III-10-15
-------------	--------------------------	-----------

PART IV FLIGHT CHARACTERISTICS

CHAPTER 11 Flight Characteristics

Figure 11-1	F/A-18B/D Departure Regions	IV-11-9
Figure 11-2	Reference CG	IV-11-21
Figure 11-3	CG Correction For Configuration/Stores/Ordnance	IV-11-21
Figure 11-4	CG Worksheet	IV-11-22
Figure 11-5	Sample Problem, CG for a F/A-18C Model, Lot 14 Aircraft, Gear Down	IV-11-23
Figure 11-6	Sample Problem, CG for a F/A-18C Model, Lot 14 Aircraft, Gear Up	IV-11-24
Figure 11-7	CG Travel Due To Fuel Consumption - F/A-18A 161353 THRU 163175 With CG Control System	IV-11-25
Figure 11-8	CG Travel Due To Fuel Consumption - F/A-18B 161354 THRU 161360 Without CG Control System	IV-11-26
Figure 11-9	CG Travel Due To Fuel Consumption - F/A-18B 161704 THRU 163123 With CG Control System	IV-11-27
Figure 11-10	CG Travel Due To Fuel Consumption - F/A-18C 163427 THRU 164691	IV-11-28
Figure 11-11	CG Travel Due To Fuel Consumption - F/A-18C 164693 AND UP...	IV-11-29
Figure 11-12	CG Travel Due To Fuel Consumption - F/A-18D 163434 THRU 164692	IV-11-30
Figure 11-13	CG Travel Due To Fuel Consumption - F/A-18D 164694 AND UP...	IV-11-31
Figure 11-14	CG vs Tanks 1 & 4 Fuel - F/A-18A	IV-11-32
Figure 11-15	CG vs Tanks 1 & 4 Fuel - F/A-18B	IV-11-32
Figure 11-16	CG vs Tanks 1 & 4 Fuel - F/A-18C 163427 THRU 164691	IV-11-32
Figure 11-17	CG vs Tanks 1 & 4 Fuel - F/A-18C 164693 AND UP	IV-11-33
Figure 11-18	CG vs Tanks 1 & 4 Fuel - F/A-18D 163434 THRU 164692	IV-11-33
Figure 11-19	CG vs Tanks 1 & 4 Fuel - F/A-18D 164694 AND UP	IV-11-33

PART V	EMERGENCY PROCEDURES	
CHAPTER 12	General Emergencies	
Figure 12-1	Warning/Caution/Advisory Displays	V-12-3
CHAPTER 14	Takeoff Emergencies	
Figure 14-1	Maximum Weight for 100 FPM Single Engine Rate of Climb	V-14-6
CHAPTER 15	Inflight Emergencies	
Figure 15-1	Spooldown Restart Envelope	V-15-7
Figure 15-2	Windmill Restart Envelope	V-15-7
Figure 15-3	Crossbleed Restart Envelope	V-15-8
Figure 15-4	APU Restart Envelope	V-15-8
Figure 15-5	Hydraulic Flow Diagram	V-15-11
Figure 15-6	Hydraulic Subsystems Malfunction Guide	V-15-12
Figure 15-7	Flight Control Effects Due To Hydraulic Failure	V-15-13
Figure 15-8	Emergency Power Distribution	V-15-22
Figure 15-9	External Stores Jettison Chart.....	V-15-33
Figure 15-10	FCS Failure Indications and Effects	V-15-35
Figure 15-11	AOA Probe Indications and Effects.....	V-15-48
CHAPTER 16	Landing Emergencies	
Figure 16-1	Maximum Altitude for 100 FPM Single Engine Rate of Climb	V-16-1
Figure 16-2	Recommended Maximum Single Engine Recovery Weight	V-16-4
Figure 16-3	Landing Gear Emergency Flow Chart.....	V-16-12
Figure 16-4	Landing Gear Malfunction – Landing Guide.....	V-16-13
Figure 16-5	Field Arrestment Gear Data.....	V-16-19
Figure 16-6	CV Recovery Matrix.....	V-16-21
CHAPTER 17	Ejection	
Figure 17-1	Ejection Sink Rate Effect	V-17-6
Figure 17-2	Minimum Ejection Altitude	V-17-9
Figure 17-3	Ejection Procedures	V-17-15
Figure 17-4	Ditching.....	V-17-39
PART VI	ALL WEATHER PROCEDURES	
CHAPTER 20	Extreme Weather Procedures	
Figure 20-1	Icing Danger Zone	VI-20-3

PART VII COMM-NAV EQUIPMENT AND PROCEDURES**CHAPTER 23 Communication-Identification Equipment**

Figure 23-1	Upfront Control (UFC).....	VII-23-3
Figure 23-2	UFC COMM Display.....	VII-23-5
Figure 23-3	KY-58 Control Panel Assembly.....	VII-23-7
Figure 23-4	UFC Have Quick Display.....	VII-23-10
Figure 23-5	UFC Manual Data Fill Display.....	VII-23-11
Figure 23-6	UFC SINCGARS Display.....	VII-23-13
Figure 23-7	UFC Electronic Remote Fill Display.....	VII-23-14
Figure 23-8	UFC IFF Display.....	VII-23-16

CHAPTER 24 Navigation Equipment

Figure 24-1	Navigation Controls and Indicators.....	VII-24-7
Figure 24-2	TAMMAC Mode Selections.....	VII-24-9
Figure 24-3	INS CV Align.....	VII-24-16
Figure 24-4	INS Ground Align.....	VII-24-19
Figure 24-5	INS Inflight Align.....	VII-24-20
Figure 24-6	INS Alignment Display with GPS.....	VII-24-21
Figure 24-7	NAV/INS Check Display.....	VII-24-23
Figure 24-8	GPS Point Data Display.....	VII-24-24
Figure 24-9	INS Programming.....	VII-24-31
Figure 24-10	Position Keeping.....	VII-24-40
Figure 24-11	Position Updating Displays.....	VII-24-43
Figure 24-12	Waypoint/OAP Direct Great Circle Steering.....	VII-24-44
Figure 24-13	Waypoint/OAP Course Line Steering.....	VII-24-45
Figure 24-14	AUTO Sequential Steering.....	VII-24-50
Figure 24-15	Navigation Designation (NAVDSG).....	VII-24-51
Figure 24-16	Overfly Designation.....	VII-24-52
Figure 24-17	TACAN Mode Selection.....	VII-24-56
Figure 24-18	TACAN Programming.....	VII-24-58
Figure 24-19	TACAN Direct Great Circle Steering.....	VII-24-59
Figure 24-20	TACAN Course Line Steering.....	VII-24-60
Figure 24-21	ILS Initialization.....	VII-24-61
Figure 24-22	ILS Steering.....	VII-24-63
Figure 24-23	DDI Link 4 ACL Display.....	VII-24-65
Figure 24-24	HUD ACL Display.....	VII-24-69
Figure 24-25	Traffic Control Couple Display.....	VII-24-70
Figure 24-26	ACL Mode 1 Display.....	VII-24-72
Figure 24-27	ACL Mode 2 Steering Display.....	VII-24-73
Figure 24-28	T/C Guidance to Marshal.....	VII-24-74
Figure 24-29	ACL Control - Marshal to Touchdown.....	VII-24-77

CHAPTER 25 Backup/Degraded Operations

Figure 25-1 Standby Attitude Reference Indicator VII-25-3

CHAPTER 26 Visual Communications

Figure 26-1 Visual Communications..... VII-26-1

CHAPTER 27 Deck/Ground Handling Signals

Figure 27-1 Deck Ground Handling Signals VII-27-2

PART VIII WEAPONS SYSTEMS

PART IX FLIGHT CREW COORDINATION

PART X NATOPS EVALUATION

PART XI PERFORMANCE DATA

FOLDOUTS

Figure FO-1 Front Cockpit F/A-18A/B Aircraft FO-3

Figure FO-2 Rear Cockpit F/A-18B Aircraft FO-7

Figure FO-3 Front Cockpit F/A-18C/D Aircraft 163427 thru 163782 FO-11

Figure FO-4 Rear Cockpit F/A-18D Aircraft 163434 thru 163778 FO-15

Figure FO-5 Front Cockpit F/A-18C/D Aircraft 163985 And Up FO-19

Figure FO-6 Rear Cockpit F/A-18D Aircraft 163986 And Up FO-23

Figure FO-7 Electrical Bus Power Aircraft 161353 thru 161528 FO-27

Figure FO-8 Electrical Bus Power Aircraft 161702 And Up FO-29

Figure FO-9 Ejection Seat (SJU-5/6) FO-31

Figure FO-10 Ejection Seat (SJU-17 (V) 1/A-2/A) FO-33

Figure FO-11 Fuel System FO-37

Figure FO-12 Environmental Control System FO-43

INTERIM CHANGE SUMMARY

The following Interim Changes have been canceled or previously incorporated in this manual:

INTERIM CHANGE NUMBER(S)	REMARKS/PURPOSE
1 thru 88	Previously Incorporated or Canceled

The following Interim Changes have been incorporated in this Change/Revision:

INTERIM CHANGE NUMBER	REMARKS/PURPOSE
89	FCC v 10.7/FCF ENG Run-up
90	Uncommanded Roll Excursion with Aileron Missing/Damaged

Interim Changes Outstanding - To be maintained by the custodian of this manual:

INTERIM CHANGE NUMBER	ORIGINATOR/DATE (or DATE/TIME GROUP)	PAGES AFFECTED	REMARKS/PURPOSE
91	142001Z OCT 09	II-5-2, V-12-12, V-18-5	Multiple changes

P 142001Z OCT 09
 FROM COMNAVAIRSYS COM PATUXENT RIVER MD//4.0P//
 TO ALL HORNET AIRCRAFT ACTIVITIES
 INFO COMNAVAIRSYS COM PATUXENT RIVER MD//5.0F/4.1//
 COMNAVAIRFOR SAN DIEGO CA//N455/N421B//
 COMNAVSAFECEN NORFOLK VA//11//
 PEOTACAIR PATUXENT RIVER MD//PMA265//
 FLTREADCEN SOUTHWEST SAN DIEGO CA//6.2//
 FLTREADCENSOUTHEAST JACKSONVILLE FL//3.3.3//
 STRKFITRON ONE TWO TWO
 DCMA BOEING ST. LOUIS OPS//RDOAA/RDDF/RDDP//
 SECINFO/U/-//
 MSGID/GENADMIN,USMTF,2008/COMNAVAIRSYS COM AIR-4.0P//
 SUBJ/FA-18A-D AIRCRAFT NATOPS PUBLICATIONS INTERIM CHANGE//
 REF/A/DESC:EML/COMNAVAIRFOR/06OCT2009//
 REF/B/DESC:DOC/COMNAVAIRSYS COM/14JUL2009//
 REF/C/DESC:A1-F18AC-NFM-000/COMNAVAIRSYS COM/15SEP2008//
 REF/D/DESC:A1-F18AC-NFM-500/COMNAVAIRSYS COM/15SEP2008//
 REF/E/DESC:A1-F18AC-NFM-700B/COMNAVAIRSYS COM/15SEP2008//
 REF/F/DESC:A1-F18AC-NFM-700C/COMNAVAIRSYS COM/15SEP2008//
 NARR/REF A IS COG CONCURRENCE.
 REF B IS AIRS 2009-147.
 REF C IS FA-18A-D NATOPS FLIGHT MANUAL (NFM-000), A1-F18AC-NFM-000,
 DTD 15 SEP 2008.
 REF D IS FA-18A-D NATOPS POCKET CHECKLIST (PCL-500), A1-F18AC-NFM-500,
 DTD 15 SEP 2008.
 REF E IS FA-18A-D FUNCTIONAL CHECKFLIGHT CHECKLIST PROFILE B (FCFCL B),
 A1-F18AC-NFM-700B, DTD 15 SEP 2008.
 REF F IS FA-18A-D FUNCTIONAL CHECKFLIGHT CHECKLIST PROFILE C (FCFCL C),
 A1-F18AC-NFM-700C, DTD 15 SEP 2008.//
 POC/VICKI CAPSTAFF/FC FACILITATOR/UNIT:PMA-265/NAME:PATUXENT RIVER
 MD/TEL:301-342-0255/TEL:DSN 342-255/EMAIL:VICKI.CAPSTAFF@NAVY.MIL//
 GENTEXT/REMARKS/1. THIS MESSAGE IS ISSUED IN RESPONSE TO REFS A AND
 B. THIS MESSAGE ISSUES INTERIM CHANGE (IC) NUMBER 91 TO REF C, IC
 NUMBER 61 TO REF D, IC NUMBER 13 TO REF E, AND IC NUMBER 12 TO REF F.
 2. SUMMARY.
 A. THIS MESSAGE ADDS MISCELLANEOUS CHANGES TO REFS C THRU F.
 B. THIS MESSAGE REFERENCES BOTH REPLACEMENT PAGES FOR SOME OF
 THE CHANGES AND DETAILS PEN AND INK CHANGES ON THE REMAINDER.
 BOTH PEN AND INK AND REPLACEMENT PAGES SHALL BE INCORPORATED
 TO COMPLETE THIS IC.
 C. REPLACEMENT PAGES CONTAINING THESE CHANGES FOR DOWNLOADING
 AND INSERTION INTO REFS C THRU F WILL BE ATTACHED TO THIS
 INTERIM CHANGE MESSAGE WHEN IT IS POSTED ON THE NATEC AND
 AIRWORTHINESS WEBSITES (SEE LAST PARA BELOW).
 D. ENSURE IC INFORMATION IS PEN AND INKED TO REFS E AND F (FCFCL
 PROFILES B AND C) IC SUMMARY PAGES AS NO REPLACEMENT PAGES
 ARE PROVIDED.
 3. THE REPLACEMENT PAGES IMPACT THE FOLLOWING NATOPS FLIGHT
 MANUAL AND ASSOCIATED CHECKLIST. THE REPLACEMENT PAGE PACKAGE
 INCLUDES THE FOLLOWING PAGES:
 A. REF C (FA-18A-D NFM-000), PAGES: 33 (REVERSE BLANK), II-5-1,
 II-5-2, V-12-11, V-12-12, AND V-18-5 (REVERSE BLANK).
 B. REF D (FA-18A-D PCL-500), PAGES: B, C, E81 AND E82.
 C. TO ENSURE THE PDF PAGES PRINT TO SCALE: SELECT PRINT

AND VIEWING PRINT SETUP WINDOW, ENSURE "NONE" IS
SELECTED IN THE PAGE SCALING DROPDOWN.

4. MAKE THE FOLLOWING PEN AND INK CHANGES:

A. CHANGE REF C (FA-18A-D NFM-000) AS FOLLOWS:

- (1) CHAPTER 10, FUNCTIONAL CHECKFLIGHT PROCEDURES; PAGE III-10-32, PARA 10.3.1.2, ENGINE START, STEP 14:
(A) DELETE: 9 AND 10.
(B) ADD: 10 AND 11.
- (2) CHAPTER 10, FUNCTIONAL CHECKFLIGHT PROCEDURES; PAGE III-10-40, PARA 10.4.1.2, ENGINE START, STEP 19:
(A) DELETE: 14 AND 15.
(B) ADD: 15 AND 16.
- (3) CHAPTER 12, GENERAL EMERGENCIES; PAGE V-12-29, FIG 12-1, WARNINGS/CAUTIONS/ADVISORY DISPLAYS (SHEET 27), FCS CAUTIONS, INDICATOR ROW, FCES, CAUSE/REMARKS COLUMN, WARNING:
(A) DELETE: 190 KCAS.
(B) ADD: 160 KCAS.
- (4) CHAPTER 12, GENERAL EMERGENCIES; PAGE V-12-30, FIG 12-1, WARNINGS/CAUTIONS/ADVISORY DISPLAYS (SHEET 28), FCS CAUTIONS, INDICATOR ROW, FCES, CAUSE/REMARKS COLUMN, WARNING:
(A) DELETE: 190 KCAS.
(B) ADD: 160 KCAS.
- (5) CHAPTER 12, GENERAL EMERGENCIES; PAGE V-12-31, FIG 12-1, WARNINGS/CAUTIONS/ADVISORY DISPLAYS (SHEET 29), FCS CAUTIONS, INDICATOR ROW, FCES, CAUSE/REMARKS COLUMN, WARNING:
(A) DELETE: 190 KCAS.
(B) ADD: 160 KCAS.
- (6) CHAPTER 16, LANDING EMERGENCIES; PAGE V-16-21, FIGURE 16-6, CV RECOVERY MATRIX, ENGINES SECTION, MALFUNCTION COLUMN:
(A) DELETE: SINGLE ENGINE.
(B) ADD: SINGLE ENGINE APPROACH AND LANDING.
- (7) CHAPTER 16, LANDING EMERGENCIES; PAGE V-16-21, FIGURE 16-6, CV RECOVERY MATRIX, ENGINES SECTION, PAGES -000/-500 COLUMN:
(A) DELETE: V-16-1/E41.
(B) ADD: V-16-2/ E38.

B. CHANGE REF D (FA-18A-D PCL-500) AS FOLLOWS:

- (1) EMERGENCY PROCEDURES, PAGE E38, SINGLE ENGINE APPROACH PROCEDURE, STEP 1:
(A) DELETE: PG 51 (400 ENGINES) OR PG 75 (402 ENGINES).
(B) ADD: PG 52 (400 ENGINES) OR PG 78 (402 ENGINES).
- (2) EMERGENCY PROCEDURES, PAGE E46, CV RECOVERY MATRIX, ENGINES SECTION, MALFUNCTION COLUMN:
(A) DELETE: SINGLE ENGINE.
(B) ADD: SINGLE ENGINE APPROACH AND LANDING.
- (3) EMERGENCY PROCEDURES, PAGE E46, CV RECOVERY MATRIX, ENGINES SECTION, NATOPS PAGES NFM-000/500 COLUMN:
(A) DELETE: V-16-1/E41.
(B) ADD: V-16-2/ E38.
- (4) EMERGENCY PROCEDURES; PAGE E105, FCS CAUTIONS, INDICATOR

- ROW, FCES, CAUSE/REMARKS COLUMN, WARNING:
 (A) DELETE: 190 KCAS.
 (B) ADD: 160 KCAS.
- (5) EMERGENCY PROCEDURES; PAGE E107, FCS CAUTIONS, INDICATOR ROW, FCES, CAUSE/REMARKS COLUMN, WARNING:
 (A) DELETE: 190 KCAS.
 (B) ADD: 160 KCAS.
- (6) EMERGENCY PROCEDURES; PAGE E108, FCS CAUTIONS, INDICATOR ROW, FCES, CAUSE/REMARKS COLUMN, WARNING:
 (A) DELETE: 190 KCAS.
 (B) ADD: 160 KCAS.
- (7) EMERGENCY PROCEDURES, PAGE E127, HYD CAUTIONS, CORRECTIVE ACTION COLUMN, IF NO X(S), STEP 8:
 (A) DELETE: (-400 P 50, -402 P 75).
 (B) ADD: (-400 P 52, -402 P 78).
- (8) EMERGENCY PROCEDURES, PAGE E149, BINGO, 400 ENGINE, LAST NOTE AT BOTTOM OF PAGE:
 (A) DELETE: (P E172).
 (B) ADD: (P E168).
- (9) EMERGENCY PROCEDURES, PAGE E171, BINGO, 402 ENGINE, LAST NOTE AT BOTTOM OF PAGE:
 (A) DELETE: (P E194).
 (B) ADD: (P E190).
- C. CHANGE REF E (FA-18A-D FCFCL-700B) AS FOLLOWS:
 (1) FUNCTIONAL CHECKFLIGHT PROCEDURES, PROFILE B; PAGE 7, ENGINE START, STEP 14:
 (A) DELETE: 9 AND 10.
 (B) ADD: 10 AND 11.
- D. CHANGE REF F (FA-18A-D FCFCL-700C) AS FOLLOWS:
 (1) FUNCTIONAL CHECKFLIGHT PROCEDURES, PROFILE C; PAGE 8, ENGINE START, STEP 19:
 (A) DELETE: 14 AND 15.
 (B) ADD: 15 AND 16.
5. POINTS OF CONTACT:
 A. LT JASON DALBY, VFA-125, NATOPS PROGRAM MANAGER, TEL DSN 949-1727 OR COMM (559) 998-1727, EMAIL: JASON.DALBY@NAVY.MIL.
 B. NAVAIR POCS:
 (1) MARTY SCANLON, NATOPS IC COORDINATOR, TEL DSN 757-6045 OR COMM (301) 757-6045, EMAIL: MARTIN.SCANLON@NAVY.MIL
 (2) ED HOVANESIAN, F/A-18E/F CLASS DESK, TEL DSN 757-7573 OR COMM (301) 757-7573, EMAIL: EDWIN.HOVANESIAN@NAVY.MIL.
 (3) LCDR BEN KELSEY, 4.0P NATOPS OFFICER, DSN 995-2502, COM 301-995-2505, EMAIL: BEN.KELSEY@NAVY.MIL.
 (4) AIRWORTHINESS GLOBAL CUSTOMER SUPPORT TEAM, COMM (301) 757-0187, E-MAIL: AIRWORTHINESS@NAVY.MIL.
6. THIS MESSAGE WILL BE POSTED ON THE NATEC WEBSITE, WWW.MYNATEC.NAVY.MIL WITHIN 48 HOURS OF RELEASE. NEW NATOPS IC MESSAGES MAY BE FOUND IN TWO PLACES ON THIS WEBSITE:
 A. IN THE NATOPS IC DATABASE FOUND UNDER THE TMAPS OPTION.
 B. IN THE AFFECTED PUBLICATION(S) JUST AFTER THE IC SUMMARY PAGE. IF THE IC MESSAGE INCLUDES REPLACEMENT PAGES, THEY WILL BE ADDITIONALLY PLACED WITHIN THE MANUAL AND REPLACED PAGES DELETED. MESSAGES ARE NORMALLY POSTED IN THE DATABASE BEFORE APPEARING IN THE PUBLICATION. THIS MESSAGE WILL ALSO

- BE POSTED ON THE AIRWORTHINESS WEBSITE, AIRWORTHINESS.NAVAIR.NAVY.MIL. IF UNABLE TO VIEW THIS MESSAGE ON EITHER THE NATEC OR AIRWORTHINESS WEBSITES, INFORM THE NATOPS GLOBAL CUSTOMER SUPPORT TEAM AT (301) 342-0870, DSN 342-0870, OR BY EMAIL AT NATOPS@NAVY.MIL.
- C. INFORMATION REGARDING THE AIRWORTHINESS PROCESS, INCLUDING A LISTING OF ALL CURRENT INTERIM FLIGHT CLEARANCES, NATOPS AND NATIP PRODUCTS ISSUED BY NAVAIR 4.0P, CAN BE FOUND AT OUR WEBSITE: AIRWORTHINESS.NAVAIR.NAVY.MIL.
 - D. E-POWER FOLDER NUMBER 870984. AIRWORTHINESS TRACKING NUMBER 34998.//

Xavier Prines, NATIP Deputy Division Head, 4.0P, 10/14/2009

SUMMARY OF APPLICABLE TECHNICAL DIRECTIVES

Information relating to the following technical directives has been incorporated in this manual.

Change Number	ECP Number	Description	Visual Identification	Effectivity
AFC 021	00033	Adds fuel/air heat exchangers	None	(R)161353 thru 161519 (P)161520 and up
AFC 027	00044	Installs differential leading edge flaps	None	(R)161353 thru 161519 (P)161520 and up
AFC 029	00024	Installs MLG dual chamber shock absorber	MLG dual chamber shock absorber installed	(R)161353 thru 161519 (P)161520 and up
ASC 008	00044C1	Installs 7.3 PROM	DDI configuration display FCSA 75 FCSB 75	(R)161353 thru 161519 (P)161520 and up
ASC 015	00149	Mission Computer OFP reload Removes autopilot heading hold preselection	DDI configuration display MC1 210; MC2 210	(P)161353 thru 161924
ASC 017	00155	Radar computer-power supply	DDI configuration display RDR 101D DDI configuration display RDR 102B	(R)161353 thru 161528 (R)161702 thru 161924 (P)161925 thru 161987
ASC 018	00155	Armament computer OFP reload	DDI configuration display SMS 120B	(R)161353 thru 161824 (P)161925 thru 161987
	00003	Adds AN/ALR-67(V) radar warning	RWR azimuth indicator	(P)161702 and up
	00019	INS OFP load	DDI configuration display INS 300	(P)161520 and up
	00023	330 gallon external tanks	Round tanks	
	00026	Adds L (R) IN TEMP caution displays	None	(P)161702 and up
	00044	AOA indexer/approach light switch point change	None	(P)161529 and up

Change Number	ECP Number	Description	Visual Identification	Effectivity
AFC 053	00054C1	Installs 8.2.1 PROM	DDI Configuration display FCSA 83, FCSB 83	(P)161702 thru 161987
	00055C1	Adds tank 4 motive flow shutoff valve to improve negative G flight time	None	(R)161353 thru 161924 (P)161925 and up
AFC 039	00069	Removes external canopy jettison handles	No external canopy jettison handles	(P)162826 and up
	00072C1	Fuel sequencing for CG control	None	(R)161353 thru 161924 (P)161520 and up
AFC 049	00074	Adds sealed lead acid battery	None	(R)161353 thru 161528 (P)161702 and up
AFC 18	00077C1, C2	Replaces feed tank ejector pumps with turbo pumps	None	(R)161353 thru 161924 (P)161925 and up
AFC 048	0090	Additional Weapon Capability	HUD air-to-air symbology changes	(P)162394 and up
	00121R1	Installs ac bus isolation circuits in electrical system	GEN TIE light on caution lights panel	(R) 161353 thru 161987 (P)162394 and up
ASC 020	00142R1/ R2	Flight Control Computer Software Update 8.3.3 PROM	DDI Configuration Display: FCSA 99, FCSB 99	(R) 161353 thru 161987 (P) 162394 and up
AFC 070	00178R1	F/A-18C/D Block Upgrade	IFEI	(P)163427 and up
	00158R2	Installs motive flow boost pump pressure switch	None	(R)161353 thru 163118 (P)163119 and up
	00210	Installs improved landing gear control handle assembly	None	(P)162826 and up
ACC 446		Install SEAWARS parachute harness sensing-release units	SEAWARS parachute canopy release fittings	All
IASC 025 IASC 026 IASC 027	00243R1	Omnibus software update	DDI configuration display: MC1 85A+, MC2 85A+, RDR 85A+, INS 84B, LST 85A, SMS 85A+, FCSA 99, FCSB 99	(R)161248 thru 163164 (P)163165 thru 163175

Change Number	ECP Number	Description	Visual Identification	Effectivity
IASC 031 IASC 032 IASC 033	00252	Omnibus software update	DDI configuration display: MC1 87X, MC2 87X, RDR 87X, SMS 87A or 87D,	(R)161353 thru 163175 (P)163427 and up
	00255	F/A- 18C/D Night Attack Capability	Independent Aft Cockpit	(P)163985 and up
	00255R3	IFEI brightness control	Video record control panel	(P)164865 and up
AFC 090	00165R1	Automatic battery cutoff	MMP ENABLE/BRCU switch next to nose wheelwell DDI	(R)161353 thru 163118 (P)163119 and up
	00249	Flight Computer Software Up- date 10.1 PROM	DDI configuration display: FCSA 107, FCSB 107	(P)163699 and up
AFC 081 IAYC 853	00231	APU & ACFT Electrical Mod	None	(R)161353 thru 163175 (P)163427 and up
AFC 102	00300	LEX Fence Installation	LEX Fence	(R)161353 thru 163726 (P)163727 and up
	00318	Omnibus Software Update	DDI configuration display: MC1 89A or 89C, MC2 89A or 89C, RDR 89X, MU 89C , SDC 89D , CSC 89X , SMS 89A	(R)161353 thru 163982 (P)163985 and up
	00233	Naval Aircrew Common Ejec- tion Seat (NACES)	Ejection Seat	(P)164196 and up
	00288	On-Board Oxygen Generating System (OBOGS)	Oxygen Panel	(P)164196 and up
AFC 184 AFC 185	00292 R2	AN/ARC-210 (V) (Have Quick /SINGARS) Radio	None	(P)164945 and up (R)163427 thru 164912
AFC 126	00321	Deployable Flight Incident Re- corder Set (DFIRS)	DDI configuration Display: DFIRS	(R)164627 thru 164724 (P)164725 and up
	00350	Enhanced Performance Engine	Engine Monitor Display	(P)164693 and up
	00369	Oxygen Console Disconnect	Pilot's Service Panel	(P)164196

Change Number	ECP Number	Description	Visual Identification	Effectivity
AFC 175	00379	AN/ALE-47 Chaff Dispensers	Warning Advisory Threat Panel	(P)165171 and up
	00383	Omnibus Software Update	DDI configuration display: MC1 91C or 92A, MC2 91C or 92A, RDR 91C, SMS 91C or 92A, FCSA 91C, FCSB 91C, SDC 91C, CSC 91C, ADC 91X	(R)161353 thru 163982 (P)163985 and up
	00405	Miniature Airborne Global Positioning Receiver (MAGR)	Mumi display	(R)163427 thru 164912 (P)164945 and up
	00426	Nuclear Consent Switch	Aft Right Console	(R)163986 thru 164738 (P)164866 and up
	00466	Omnibus Software Update	DDI configuration display: MC1 09C , MC2 09C , RDR 89X, SMS 09C , SDC 09C, CSC 09C or 89X, ADC 09C	(R)163427 thru 164897 (P)164898 and up
IASC 61 IASC 62	00466	Omnibus Software Update	DDI configuration display: MC1 10A, MC2 10A, RDR 89X, SMS 10A, SDC 09C, CSC 09C , ADC 09C	(R)161353 thru 163175
AFC 207	00468 R1	Cockpit Video Recording System Improvement	Video Cameras mounted on top of canopy frame	(R)163985 thru 164912 (P)164945 and up
AFC 200	00470	6th MUX Bus	None	(R)163427 thru 163782
AFC 247	00507 NI843R1	Birdstrike Resistant Windshield	None	(R)161353 thru 163782 (P)165183 and up
AFC 236	00520	Combined Interrogator-Transponder (CIT)	None	(P)165222 and up (R)163985 thru 165221
AFC 231 AFC 232	00521	Embedded Global Positioning System /INS (EGI)	None	(R)161925 thru 163175
AFC 225	00529	Addition of 5th MUX bus	None	(R)161734 thru 163175
ASC 75	00535	FCC OFP Update to V10.5.1 (91C*-004)	DDI configuration display	(R)161353 and up
AFC 244	00549	ATARS	DDI configuration display	(R) 164649 and up

Change Number	ECP Number	Description	Visual Identification	Effectivity
IASC 78 thru IASC 87	00557	Omnibus Software Update	DDI configuration display: MC1 11C, MC2 11C, RDR 11C, SMS 11C, SDC 09C, CSC 91C, ADC 91X	(R)163427 thru 164992 (P)165171 and up
IASC 103 IASC 104		Omnibus Software Update	DDI configuration display: MC1 10A+, MC2 10A+	(R)161353 thru 163175
IASC 78 REV A		Omnibus Software Update	DDI configuration display: MC1 11C+, MC2 11C+	(R)163427 and up
AFC 253	00560	Avionic Upgrade	Menu Display: MC1 15C, MC2 15C	(R)162394 thru 163175
AFC 258	00573	Crash Survivable Flight Inci- dent Recorder Set (CSFIRS)	None	(R)163427 thru 164279
AFC 268	00575	Amplifier Control	ACI Panel	(R)163427 and up
AFC 269	00576	DCS	DDI configuration display	(R)163427 and up
AFC 270	00577	MIDS	DDI configuration display	(R)163427 and up
IASC 077		Omnibus Software Update	DDI configuration display: MC1 12A, MC2 12A	(R)161353 thru 163175
IASC 89	00578	Omnibus Software Update	DDI configuration display: MC1 13C, MC2 13C, SMS 13C, SDC 13C, CSC 93C, ADC 93X	(R)163427 and up
AFC 292	00583	Avionic Upgrade	Menu Display: MC1 15C, MC2 15C	(R)162394 thru 163175
AFC 493	00583R4	NACES Ejection Seat	NACES ejection seat	(R)162394 thru 163175
ASC 139	00595	FCC OFP Update to V10.7(91C*-006)	DDI configuration display	(R)161353 and up
ASC 108	TDL 501	Omnibus Software Update	DDI configuration display: MC1 15C, MC2 15C, SMS 15C, SDC 15C	(R)162394 and up
ASC	TDL 701	Omnibus Software Update	DDI configuration display: MC1 17C, MC2 17C, SMS 17C	(R)162394 and up
AFC 216	NI0826	OBOGS Solid State Monitor	Electronic BIT button	(R)164196 thru 164912
AFC 233	NI2693	ALE-39 Reset Switch	Antenna Select Panel	(R)161353 thru 164992

Change Number	ECP Number	Description	Visual Identification	Effectivity
AFC 209 AVCs 4525, 4526, 4527	NI0830	NVDS Compatible Cockpit Lighting System	None	(R) 161702 thru 163782
AFC 380	NI0953	Advanced Multipurpose Color Display	AMPCD	(R) 163985 and up
AFC 327	ECP 563	Tactical Aircraft Moving Map Capability	None	(R) Lots 12 and up
ASC	TDL	Omnibus Software Update	DDI configuration display: MC1 19C, MC2 19C, SMS 19C	(R) 162394 and up
AFC 400	570R1	Joint Helmet Mounted Cueing System	DDI configuration display: HMD	(R) 164197 and up
AFC 444	570R4	Joint Helmet Mounted Cueing System	BRU mounted in aft cockpit	(R) 164196 and up
AFC 194	00949	XC-75 Video Camera/ V82AFBTV-12 Video Recorder	Video Camera	(R) 162394 and up
	TDL AL0202	Omnibus Software Update	DDI configuration display: MC1 20X, MC2 20X, SMS 20X	(R) Lot 6 and up
AFC 446	6217	Cabin Pressurization Warning System	Caution Lights Panel	(R) Lot 3 and up

(R) Retrofit (P) Production

Information relating to the following recent technical directives will be incorporated in the future change.

Change Number	ECP Number	Description	Visual Identification	Effectivity

LIST OF ABBREVIATIONS/ACRONYMS

A

A/A	air-to-air
A/C	aircraft
ac	alternating current
ACCUM	accumulator
ACPT	accept
ADB	aircraft discrepancy book
ADC	air data computer
ADF	automatic direction finding
ADIZ	air defense identification zone
ADS	air data sensors
ADV	advisory
AFCS	automatic flight control system
A/G	air-to-ground
AGL	above ground level
AHRS	attitude heading reference system
AI	air interrogation
AIL	aileron
AIM	air intercept missile
AINS	aided inertial navigation system
ALDR	altitude loss during recovery
ALE-47	countermeasure dispensing set
ALM	almanac
ALR-67	radar warning receiver
AMAD	airframe mounted accessory drive
AMPCD	advanced multipurpose color display
AN/ALE-39	countermeasures dispensing set
AN/APN-194	radar altimeter set
AN/ARN-514	VOR/ILS system
AN/ASN-139	inertial navigation system
AOA	angle of attack
AOB	angle of bank
A/P	autopilot
APU	auxiliary power unit
APPR	approach
ARI	attitude reference indicator
AQ	align quality
ASL	azimuth steering line
ASPJ	airborne self protection jammer
AT SCV	air turbine starter control valve
ATARS	advanced tactical air reconnaissance system
ATC	air traffic control
ATC	automatic throttle control
ATS	air turbine starter

ATSCV air turbine starter control valve
 ATTH attitude hold
 AUG augment
 AUR aural
 AUTO automatic
 AVMUX avionics multiplex

B

BAC1 bank angle control 1
 BADSA backup air data sensor assembly
 BALT barometric altimeter
 BARO barometric
 BCN beacon
 BINGO minimum fuel required to return to base
 BIT built-in test
 BLD bleed
 BLIM bank limit
 BLIN bit logic inspection
 BNK bank
 BRCU battery relay control unit
 BRG bearing
 BRK brake
 BRT bright

C

°C degrees Celsius
 CAS control augmentation system
 CAUT caution
 CB circuit breaker
 CD countdown
 CDP compressor discharge pressure
 CD ROM compact disk read only memory
 CFIT controlled flight into terrain
 CG center of gravity
 CHAN channel
 CHKLST checklist
 CIT combined interrogator/transponder
 CK check
 CKPT cockpit
 CLR clear
 CMDS countermeasures dispensing set
 CMPTR computer
 CNI communication, radio navigation, and identification
 COMM communication radio
 CONT PVU continuous precision velocity update
 CPL coupled
 CPLD coupled
 CPU central processor unit
 CPWS cabin pressurization warning system
 CRS course
 CRYPTO cryptographic or coded transmission

CSEL	selected course
CSFIRS	crash survivable flight incident recorder system
CSS	control stick steering
CTR	center
CV	carrier
CVRS	cockpit video recording system

D

DBS	doppler beam sharpened
DC	designator controller
dc	direct current
DCS	digital communication system
DDI	digital display indicator
DEGD	degraded
DEL	direct electrical link
ΔP	hydraulic filter indicator
DFIRS	deployable flight incident recorder system
DISCH	discharge
D/L	data link
DMA	defense mapping agency
DME	distance measuring equipment
DMS	digital map set
DN	down
DSS	data storage set
DSU	data storage unit
DTE	data transfer equipment

E

E BATT	emergency battery
EADI	electronic attitude display indicator
EC	erase controller
ECA	electrical control assembly
ECS	environmental control system
EGI	embedded INS/GPS
EGT	exhaust gas temperature
EHPE	estimated horizontal position error
ELEV	elevation
EMCON	emission control
EMD	engine monitor display
ENG	engine
ENGL	english
ENRT	enroute
ENT	enter
EPE	enhanced performance engine
EPR	engine pressure ratio
EQUIP	equipment
EST	estimated
ET	elapsed time
EU	electronic unit
EXT	external

EXTD	extend
F	
°F	degrees Fahrenheit
FCCA	flight control computer A
FCCB	flight control computer B
FCES	flight control electronic system
FCF	functional check flight
FCS	flight control system
FE	fighter escort configuration
FF	fuel flow
FIRAMS	flight incident recording and monitoring system
FLBIT	fuel low BIT
FO	foldout
FOD	foreign object damage
FPAS	flight performance advisory system
F-QTY	fuel quantity
FT	foot, feet
FUS	fuselage
G	
G or g	gravity
G	guard
GB	gyro bias
GCU	generator converter unit
GEN	generator
GEN TIE	generator tie
G-LIM	g-limiter
GND	ground
GPS	global positioning system
GPWS	ground proximity warning system
GRCV	guard receive
GXMT	guard transmit
H	
HARM	high-speed antiradiation missile
HDG	heading
HDG/SLV	heading slaved
HERR	horizontal error
HI	high
HMD	helmet mounted display
HOOK	arresting hook
HPWS	high pressure water separator
HSEL	heading select
HSI	horizontal situation indicator
HUD	head up display
HVC	HUD video camera
HYD	hydraulic
HYD1	hydraulic system 1
HYD2	hydraulic system 2
I	
IBIT	initiated built in test

ICAO	international civil aviation organization
ICS	intercommunication control set
ID	identification
IFA	inflight alignment
IFEI	integrated fuel-engine indicator
IFF	identification friend or foe
ILS	instrument landing system
IM	inner marker
IMC	instrument meteorological conditions
IMU	inertial measurement unit
INIT	initialize or initiate
INOP	inoperative
INS	inertial navigation system
INST	instrument
INSTR	instrument
INU	inertial navigation unit
INV	invalid
I/P	identification of position
IR	infrared
ISOL	isolate

J

JETT	jettison
------	----------

K

KCAS	knots calibrated air speed
KGS	knots ground speed
KIAS	knots indicated air speed
kt	knots
KTAS	knots true airspeed

L

L	left
L ACC	lateral accelerometer
LAT	latitude
lb(s)	pound(s)
LBA	limit basic aircraft
L BAR	launch bar
LDDI	left digital display indicator
LDG	landing
LED	light emitting diode
LEF	leading edge flaps
LEX	leading edge extension
LG	landing gear
LI	left inboard
LINK-16	secure, jam-resistant, nodeless data link
LMDI	left multipurpose display indicator
LO	left outboard
LO	low
LONG	longitude
LOS	line of sight

LPU	life preserver unit
LRU-23/P	liferaft
LT	light
LTOD	local time of day
M	
M	manual
MAC	mean aerodynamic chord
MAD	magnetic azimuth detector
MAGR	miniaturized airborne GPS receiver
MAGVAR	magnetic variation
MAX	maximum thrust
MC	mission computer
MDC	mission data loader
MECH	mechanical link
MER	multiple ejector rack
MFS	multifunction switch
MIDS	multifunctional information distribution system
MIL	military thrust
MM	middle marker
MMP	maintenance monitor panel
MPCD	multipurpose color display
MSDRS	maintenance signal data recording set
MTRC	metric
MTRS or m	meters
MU	memory unit
MUMI	memory unit mission initialization
MUX	multiplex bus
MVAR	magnetic variation

N

N_1	fan rpm
N_2	compressor rpm
N_H	engine compressor high pressure turbine speed
NABITS	non-avionic built in test
N ACC	normal accelerometer
NACES	navy aircrew common ejection seat
NAS	national air space
NATOPS	naval air training and operations procedures standardization
NAV	navigation
NAV CK	navigation check
ND	nose down
NM	nautical miles
NORM	normal
NOTAMS	notice to airmen
NOT RDY	not ready
NOZ	exhaust nozzle position
NU	nose up
NVD	night vision devices
NVG	night vision goggles
NWS	nosewheel steering

O

OAP	offset aim point
OBOGS	onboard oxygen generating system
OCF	out of control flight
OFFP	operational flight program
OIL	engine oil pressure
OM	outer marker
ORIDE	override
OTG	operational tactical guides
OVFLY	overfly
OVRSPD	overspeed
OXY	oxygen

P

P	pitch
PCL	pocket checklist
PER	position error rate
PIO	pilot induced oscillation
PLF	parachute landing fall
PNL	panel
POS	position
pph	pounds per hour
ppm	pounds per minute
PR	pressure
PROC	processor
PROM	programmable read only memory
psi	pounds per square inch
PTS	power transmission shaft
PTTI	precise time and time interval
PVT	position, velocity, and time
PVU	precision velocity update

Q

QDC	quick disconnect connector
QTY	quantity

R

R	right
R	roll
RALT	radar altimeter
RCDR	recorder
RCVY	recovery
RDC	right designator controller
RDDI	right digital display indicator
RDR	radar
REC	radar elevator control
RECCE	reconnaissance
REJ	reject
RI	right inboard
RLG	ring laser gyro
R-LIM	roll rate limiter

RMDI	right multipurpose display indicator
RNG	range
RO	right outboard
ROC	rules of combat
ROE	rules of engagement
RPM	revolutions per minute
RSET	reset
RSRI	rolling surface to rudder interconnect
R/T	receive/transmit
RTC	real time clock
RTN	return
RUD	rudder
RWR	radar warning receiver

S

SA	situational awareness
SATS	short airfield for tactical support
SARI	standby attitude reference indicator
SCH	simplified combined harness
SCS	software configuration set
SDC	signal data computer
SDC	signal data converter
SEAWARS	seawater parachute release mechanism
SEQ	sequence
SIF	selective identification feature
SJU-17	ejection seat
SKU-10/A	seat survival kit
SMS	stores management set
SOP	standard operating procedures
SPD	speed
SPD BRK	speed brake
SPN	spin
SRM	spin recovery mode
STAB	stabilator
STBY	standby
STD HDG	stored heading
SUPT	support
S/W	software
SW	switch

T

T ₁	engine inlet temperature
TAC	tactical
TAMMAC	tactical aircraft moving map capability
TAS	true air speed
TAWS	terrain awareness warning system
TCN	tacan
TDC	throttle designator controller
TDP	turbine discharge pressure
TDU-32/B	aerial banner target

TEF	trailing edge flaps
TEMP	temperature
TGT	target
TK PRESS	fuel tank pressure
T/O	takeoff
TOT	time on target
TRU	transformer-rectifier unit
TTG	time to go
U	
U BATT	utility battery
UFC	upfront control
UHF	ultra high frequency
UNLK	unlock
UPDT	update
UTC	universal coordinated time
UTM	universal transverse mercator
V	
VDC	volts, direct current
VEL	velocity
VER	vertical ejector rack
VERR	vertical (position) error
VFR	visual flight rules
VHF	very high frequency
VIB	vibration
VMC	visual meteorological conditions
VOL	volume
VOR	VHF omnidirectional ranging
VSH	video sensor head
VTRS	video tape recording system
W	
W	waterline symbol
WARN	warning
W DIR	wind direction
WDSHLD	windshield
WGS	world geodetic survey
W off W	weight off wheels
W on W	weight on wheels
WOW	weight on wheels
WOWB	weight on wheels both
WSO	weapons and sensors officer
W SPD	wind speed
WYPT	waypoint
X	
X	control surface inoperative
XFER	transfer
Y	
Y	yaw
YDS	yards

ZTOD

zulu time of day

Z

PREFACE

SCOPE

This NATOPS manual is issued by the authority of the Chief of Naval Operations and under the direction of Commander, Naval Air Systems Command in conjunction with the Naval Air Training and Operating Procedures Standardization (NATOPS) program. It provides the best available operating instructions for most circumstances, but no manual is a substitute for sound judgment. Compound emergencies, available facilities, adverse weather or terrain, or considerations affecting the lives and property of others may require modification of the procedures contained herein. Read this manual from cover to cover. It is the air crewman's responsibility to have a complete knowledge of its contents.

APPLICABLE PUBLICATIONS

The following applicable publications complement this manual:

A1-F18AC-NFM-200 (Performance Data Supplement for aircraft with F404-GE-400 engines)

A1-F18AC-NFM-210 (Performance Data Supplement for aircraft with F404-GE-402 enhanced performance engines)

A1-F18AC-NFM-500 (Pocket Checklist)

A1-F18AC-NFM-600 (Servicing Checklist)

A1-F18AC-NFM-700 A,B,C and D (Functional Checkflight Checklists)

NTRP 3-22.2-FA18A-D (classified NATIP volume)

NTRP 3-22.4-FA18A-D (unclassified NATIP volume)

Current F/A-18 A-D tactics, techniques and procedures sources

NTRP 3-22.5-FA18A-D (Tactical Manual Pocket Guide)

HOW TO GET COPIES

Additional copies of this manual and changes thereto may be procured through the local supply system from NAVICP Philadelphia via DAAS in accordance with NAVSUP P-409 (MILSTRIP/MILSTRAP), or a requisition can be submitted to Naval Supply Systems Command via the Naval Logistics Library (NLL) website, www.nll.ahf.navy.mil. This publication is also available to view and download from the Naval Air Technical Data and Engineering Service Command (NATEC) website, <https://www.natec.navy.mil> or at the Naval Air Systems Command (NAVAIR) Airworthiness website <https://airworthiness.navair.navy.mil>.

AUTOMATIC DISTRIBUTION (WITH UPDATES)

This publication and changes to it are automatically sent to activities that are established on the Automatic Distribution Requirements List (ADRL) maintained by NATEC, in San Diego, CA. If there is continuing need for this publication, each activity's Central Technical Publication Librarian must coordinate with the NATOPS Model Manager of this publication to ensure appropriate numbers of this and associated derivative manuals are included in the automatic mailing of updates to this publication.

NOTE

Activities not coordinating with the NATOPS Model Manager unit for more than 12 months may be dropped from distribution.

UPDATING THE MANUAL

To ensure that the manual contains the latest procedures and information, NATOPS review conferences are held in accordance with the current OPNAVINST 3710 series.

CHANGE RECOMMENDATIONS

Recommended changes to this manual or other NATOPS publications may be submitted by anyone in accordance with OPNAVINST 3710.7 series. Change recommendations of any nature, (URGENT/PRIORITY/ROUTINE) should be submitted directly to the Model Manager via the Airworthiness website (<https://airworthiness.navair.navy.mil>) into the AIRS (Airworthiness Issue Resolution System) database. The AIRS is an application that allows the Model Manager and the NATOPS Office, Naval Air Systems Command (NAVAIR) AIR-4.0P to track all change recommendations with regards to NATOPS products. The Model Manager will be automatically notified via email when a new recommendation is submitted. A classified side of the website is available to submit classified information via the SIPRNET. Routine change recommendations can also be submitted directly to the Model Manager (via your unit NATOPS Officer if applicable) on OPNAV Form 3710/6 shown on the next page.

The address of the Model Manager of this aircraft/publication is:

Commanding Officer
VFA-125
Naval Air Station
Lemoore, CA 93246-5125
Attn: F/A-18 A-D Model Manager
DSN: 949-1727
Commercial: (559) 998-1727

NATOPS CHANGE RECOMMENDATION
 OPNAV/FORM 3710/6(4-90) S/N 0107-LF-009-7900

DATE _____

TO BE FILLED IN BY ORIGINATOR AND FORWARDED TO MODEL MANAGER

FROM (originator)		Unit			
TO (Model Manager)		Unit			
Complete Name of Manual/Checklist	Revision Date	Change Date	Section/Chapter	Page	Paragraph

Recommendation (be specific)

CHECK IF CONTINUED ON BACK

Justification

Signature	Rank	Title
-----------	------	-------

Address of Unit of Command

TO BE FILLED IN BY MODEL MANAGER (Return to Originator)

FROM	Date
------	------

TO

Reference

(a) Your change Recommendation Dated _____

Your change recommendation dated _____ is acknowledged. It will be held for action of the review conference planned for _____ to be held at _____

Your change recommendation is reclassified URGENT and forwarded for approval to _____ by my DTG _____

/S/ _____
 MODEL MANAGER

_____ AIRCRAFT

YOUR RESPONSIBILITY

NATOPS manuals are kept current through an active manual change program. Any corrections, additions, or constructive suggestions for improvement of its contents should be submitted by urgent, priority or routine change recommendations, as appropriate.

NATOPS FLIGHT MANUAL INTERIM CHANGES

Interim changes are changes or corrections to NATOPS manuals promulgated by CNO or COMNAVAIRSYSCOM. Interim changes are issued either as printed pages, or as a naval message. The Interim Change Summary page is provided as a record of all interim changes. Upon receipt of a change or revision, the custodian of the manual should check the updated Interim Change Summary to ascertain that all outstanding interim changes have been either incorporated or canceled; those not incorporated shall be recorded as outstanding in the section provided.

CHANGE SYMBOLS

Revised text is indicated by a black vertical line in either margin of the page, like the one printed next to this paragraph. The change symbol shows where there has been a change. The change might be material added or information restated. A change symbol in the margin by the chapter number and title indicated a new or completely revised chapter.

WARNING, CAUTIONS, AND NOTES

The following definitions apply to WARNINGS, CAUTIONS, and Notes found throughout the manual.

WARNING

An operating procedure, practice, or condition, etc., that may result in injury or death, if not carefully observed or followed.

CAUTION

An operating procedure, practice, or condition, etc., that may result in damage to equipment, if not carefully observed or followed.

NOTE

An operating procedure, practice, or condition, etc., which is essential to emphasize.

WORDING

The concept of word usage and intended meaning which has been adhered to in preparing this manual is as follows:

“Land as soon as possible” means to land at the first site which a safe landing can be made.

“Land as soon as practical” means extended flight is not recommended. The landing site and duration of flight is at the discretion of the pilot in command.

“Shall” has been used only when application of a procedure is mandatory.

“Should” has been used only when application of a procedure is recommended.

“May” and “need not” have been used only when application of a procedure is optional.

“Will” has been used only to indicate futurity, never to indicate any degree of requirement for application of a procedure.

AIRSPPEED

All airspeeds in this manual are in knots calibrated airspeeds unless stated in other terms.

TERMINOLOGY

To standardize terminology throughout this publication, the following guidelines should be followed:

- a. When specifying a switch, handle, or knob to be actuated in an emergency procedure, the name of the switch, handle or knob should be written as it is labeled in the cockpit (i.e. LDG GEAR handle).
- b. When referencing a position of a switch, handle, or knob, the label as shown in the cockpit should be used (i.e. ECS MODE switch – OFF/RAM).
- c. LOT numbers should be used vice BUNO numbers when the entire LOT is affected. For multiple LOTs use LOT XX–XX or LOT XX and up as appropriate.
- d. For MC OFP’s use terminology such as “Prior to MC OFP 18E” or “MC OFP 18E and up” to avoid requiring a NATOPS change with each subsequent OFP release.
- e. Procedures which are nested in other procedures such as the Emergency Oxygen Procedure should contain only immediate action items.
- f. When emergency procedures are referenced in the PCL, page numbers should be included to facilitate quick location of the referenced procedure.

MANUAL DEVELOPMENT

This NATOPS Flight Manual was prepared using a concept that provides the aircrew with information for operation of the aircraft, but detailed operation and interaction is not provided. This concept was selected for a number of reasons: reader interest increases as the size of a technical publication decreases, comprehension increases as the technical complexity decreases, and accidents decrease as reader interest and comprehension increase. To implement this streamlined concept, observance of the following rules was attempted:

- a. The pilot shall be considered to have above-average intelligence and normal (average) common sense.
- b. No values (pressure, temperature, quantity, etc.) which cannot be read in the cockpit are stated,

except where such use provides the pilot with a value judgement. Only the information required to fly the aircraft is provided.

- c. Notes, Cautions, and Warnings are held to an absolute minimum, since, almost everything in the manual could be considered a subject for a Note, Caution, or Warning.
- d. No Cautions or Warnings or procedural data are contained in the Descriptive Section, and no abnormal procedures (Hot Starts, etc.) are contained in the Normal Procedures Section.
- e. Notes, Cautions and Warnings are not used to emphasize new data.
- f. Multiple failures (emergencies) are not covered.
- g. Simple words in preference to more complex or quasi-technical words are used and, unnecessary and/or confusing word modifiers are avoided.

A careful study of the NATOPS Flight Manual will probably disclose a violation of each rule stated. In some cases this is the result of a conscious decision to make an exception to the rule. In many cases, it only demonstrates the constant attention and skill level that must be maintained to prevent slipping back into the old way of doing things.

In other words, the “Streamlined” look is not an accident, it takes constant attention for the NATOPS Flight Manual to keep its lean and simple concept to provide the pilot with the information required.

F/A-18A/C



HORNET

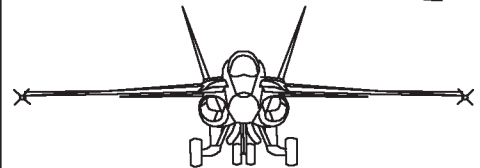
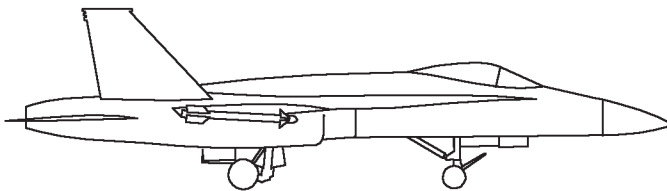
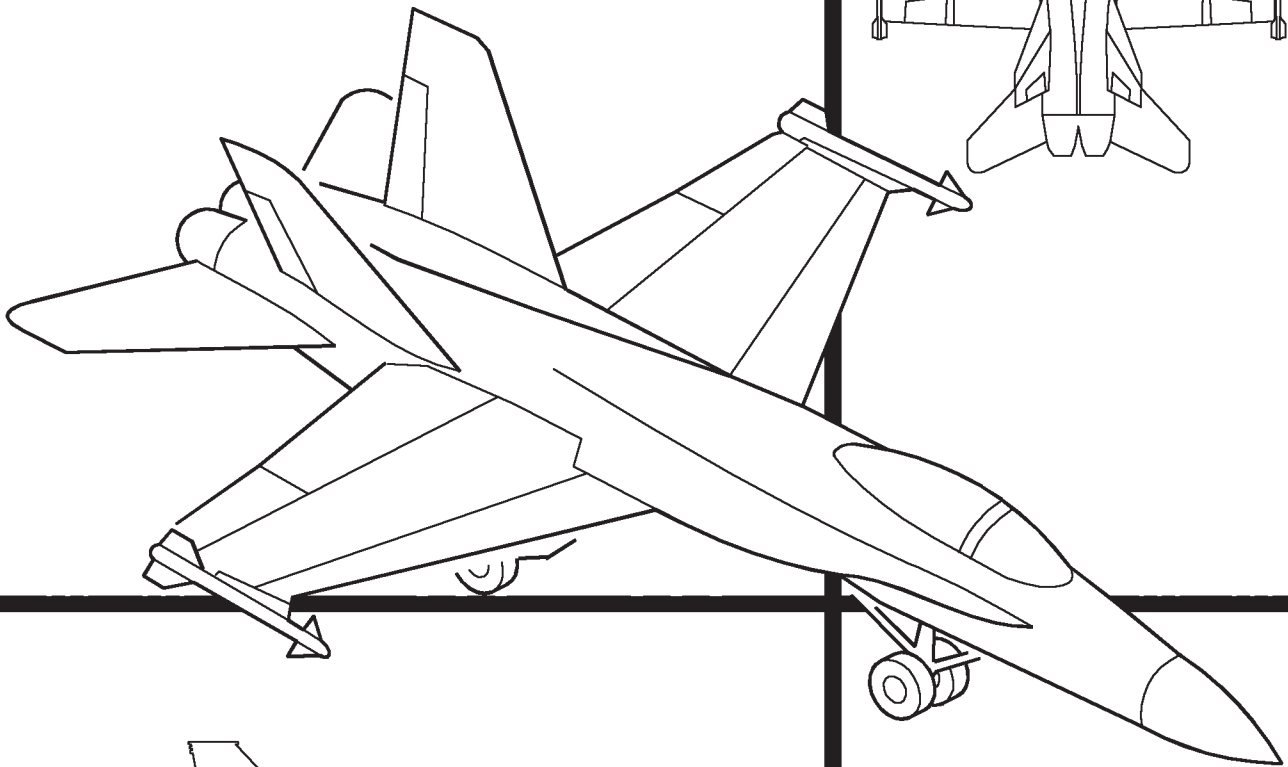
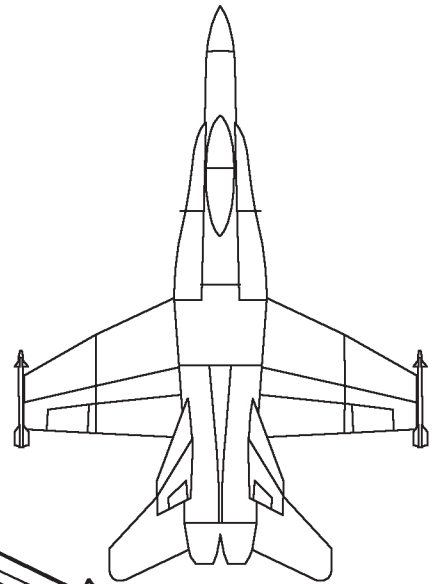

18AC-NFM-00-(4-1)31-CATI

PART I

THE AIRCRAFT

Chapter 1 - Aircraft and Engine

Chapter 2 - Systems

Chapter 3 - Servicing and Handling

Chapter 4 - Operating Limitations

CHAPTER 1

The Aircraft

1.1 AIRCRAFT DESCRIPTION

1.1.1 Meet The Hornet. The F/A-18A/C Hornet is a single-place fighter/attack aircraft built by McDonnell Douglas Aerospace. See figure 1-1 for general arrangement and Cockpits Foldout section for cockpit arrangement. It is powered by two General Electric F404-GE-400 or F404-GE-402 (enhanced performance) turbofan engines with afterburner. The aircraft features a variable camber mid-wing with leading edge extensions (LEX) mounted on each side of the fuselage from the wing roots to just forward of the windshield. The twin vertical stabilizers are angled outboard 20° from the vertical. The wings have hydraulically actuated leading edge and trailing edge flaps and ailerons. The twin rudders and differential stabilators are also hydraulically actuated. The speed brake is mounted on the top side of the aft fuselage between the vertical stabilizers. The pressurized cockpit is enclosed by an electrically operated clam shell canopy. An aircraft mounted auxiliary power unit (APU) is used to start the engines. On the ground, the APU may be used to supply air conditioning or electrical and hydraulic power to the aircraft systems.

1.1.2 Aircraft Dimensions. The approximate dimensions of the aircraft are as follows:

Span (Wings Spread) with missiles	40 feet 5 inches
without missiles	37 feet 6 inches
Span (Wings Folded)	27 feet 6 inches
Length	56 feet
Height (To Top of Fins)	15 feet 3 inches
Height (To Top of Closed Canopy)	10 feet 6 inches

1.1.3 Aircraft Gross Weight. Basic aircraft gross weight varies from 24,000 to 25,000 pounds. Refer to applicable DD 365F for accurate aircraft weight.

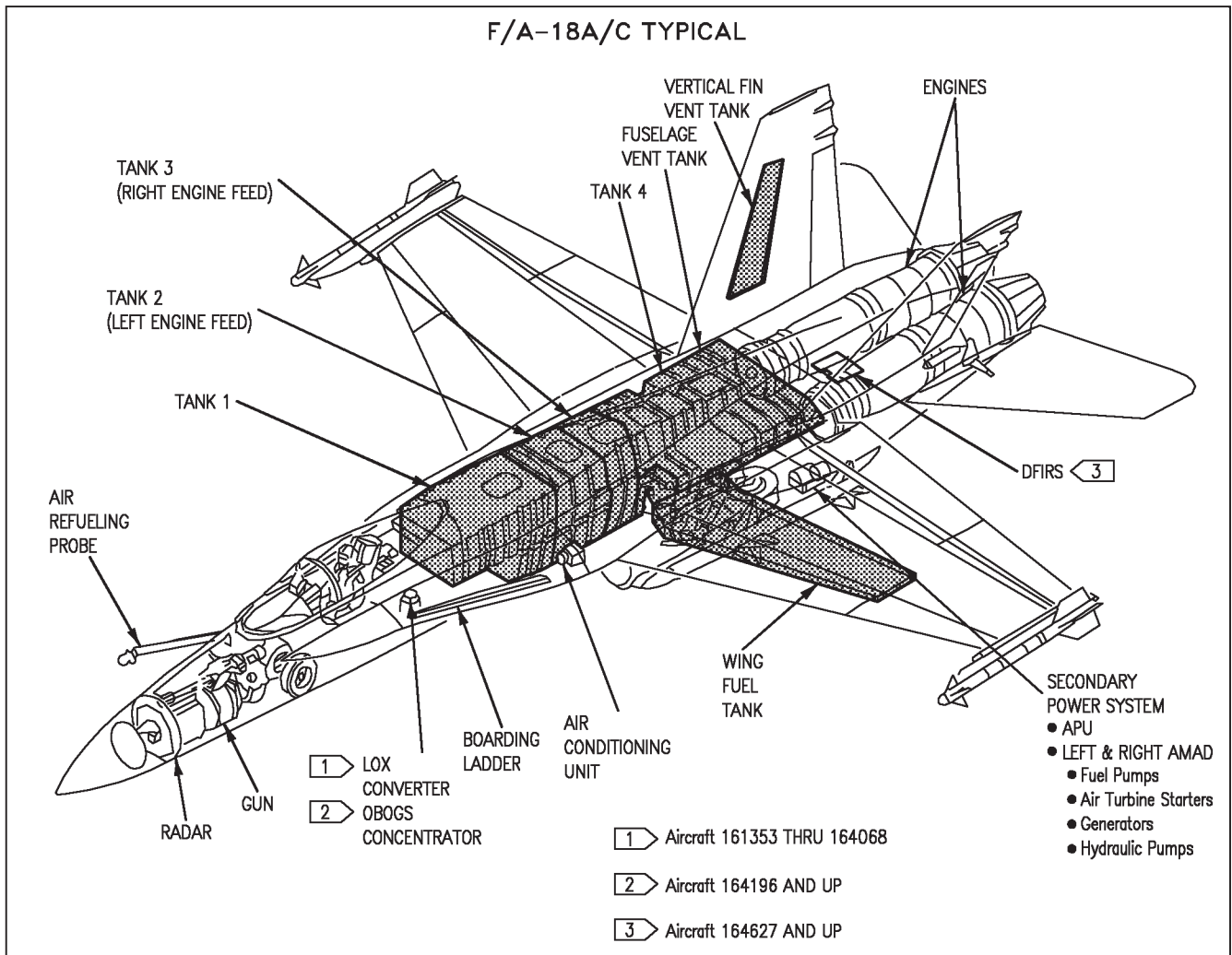

18AC-NFM-00-(5-1)31-SCAN

Figure 1-1. General Arrangement (F/A-18A/C)

1.1.4 Mission. The aircraft has an all-weather intercept, identify, destroy, and ground attack capability. Air-to-air armament normally consists of AIM-9, AIM-7, and AIM-120 missiles and a 20 mm gun. Various air-to-ground stores may be carried. Mission range may be extended with the addition of up to three external fuel tanks.

1.2 BLOCK NUMBERS

See figure 1-2 for block numbers which correspond to aircraft serial numbers (BUNO).

F/A-18A F/A-18B 161705 161707

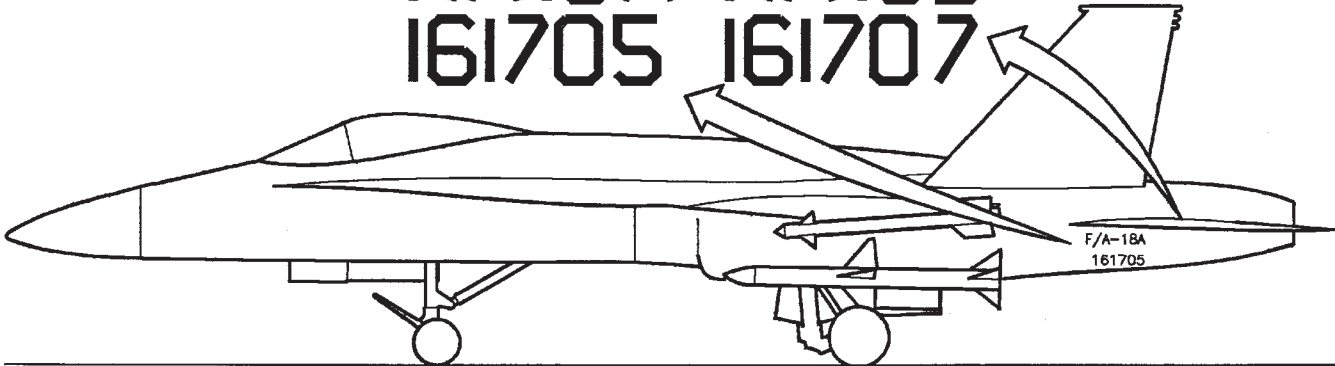

F/A-18A		F/A-18B		
LOT 4	BLOCK 5 (3) 161353, 161358, 161359 BLOCK 6 (8) 161361 thru 161367 161519 BLOCK 7 (9) 161520 thru 161528	LOT 8	BLOCK 17 (24) 162826 thru 162835, 162837 thru 162841, 162843 thru 162849, 162851, 162852 BLOCK 18 (25) 162853 thru 162856, 162858 thru 162863, 162865 thru 162869, 162871 thru 162875, 162877 thru 162881 BLOCK 19 (27) 162882 thru 162884, 162886 thru 162909	
LOT 5	BLOCK 8 (10) 161702, 161703, 161705, 161706, 161708, 161709, 161710, 161712, 161713, 161715 BLOCK 9 (17) 161716, thru 161718, 161720 thru 161722, 161724 thru 161726, 161728 thru 161732, 161734 thru 161736 BLOCK 10 (23) 161737 thru 161739, 161741 thru 161745, 161747 thru 161761	LOT 9	BLOCK 20 (24) 163092 thru 163103, 163105 thru 163109, 163111 thru 163114, 163116 thru 163118 BLOCK 21 (26) 163119 thru 163122, 163124 thru 163145 BLOCK 22 (30) 163146 thru 163175	
LOT 6	BLOCK 11 (17) 161925 thru 161931, 161933 thru 161937, 161939 thru 161942, 161944 BLOCK 12 (20) 161945, 161946, 161948 thru 161965 BLOCK 13 (22) 161966 thru 161987		LOT 4	BLOCK 5 (4) 161354 thru 161357 BLOCK 6 (1) 161360 BLOCK 8 (4) 161704, 161707, 161711, 161714 BLOCK 9 (4) 161719, 161723, 161727, 161733 BLOCK 10 (3) 161740, 161746, 161924
LOT 7	BLOCK 14 (18) 162394 thru 162401, 162403 thru 162407, 162409 thru 162412, 162414 BLOCK 15 (28) 162415 thru 162418, 162420 thru 162426, 162428 thru 162444 BLOCK 16 (33) 162445 thru 162477		LOT 5	BLOCK 11 (3) 161932, 161938, 161943 BLOCK 12 (1) 161947 BLOCK 14 (3) 162402, 162408, 162413 BLOCK 15 (2) 162419, 162427 BLOCK 17 (3) 162836, 162842, 162850 BLOCK 18 (4) 162857, 162864, 162870, 162876 BLOCK 19 (1) 162885
			LOT 6	BLOCK 20 (3) 163104, 163110, 163115 BLOCK 21 (1) 163123 BLOCK 22 (0)

18AC-NFM-00-(3-1)17-CAT1

Figure 1-2. Block Numbers (Sheet 1 of 3)

F/A-18C

LOT 10

BLOCK 23 (23)

163427 thru 163433,
163435,
163437 thru 163440,
163442 thru 163444,
163446,
163448 thru 163451,
163453, 163455,
163456

BLOCK 24 (21)

163458, 163459,
163435 thru 163463,
163465 thru 163467,
163469 thru 163471,
163473,
163475 thru 163481,
163483 thru 163485,

BLOCK 25 (17)

163487,
163489 thru 163491,
163493 thru 163496,
163498, 163499,
163502 thru 163506,
163508, 163509

LOT 11

BLOCK 26 (25)

163699,
163701 thru 163706,
163708 thru 163719,
163721 thru 163726

BLOCK 27 (26)

163727 thru 163733,
163735 thru 163748,
163750 thru 163754

BLOCK 28 (25)

163755 thru 163762,
163762 thru 163770,
163772 thru 163777,
163779 thru 163782,

LOT 12

BLOCK 29 (20)

163985, 163987,
163988, 163990,
163992, 163993,
163995, 163996,
163998 thru 164000,
164002 thru 164004,
164006 thru 164008,
164010, 164012,
164013

BLOCK 30 (16)

164015, 164016,
164018, 164020,
164021, 164023,
164025, 164027,
164029 thru 164031,
164033, 164034,
164036, 164037,
164039

BLOCK 31 (18)

164041, 164042,
164044, 164045,
164047, 164048,
164050, 164052,
164054, 164055,
164057, 164059,
164060, 164062,
164063, 164065,
164066, 164067

LOT 13

BLOCK 32 (17)

164197,
164199 thru 164202,
164204 thru 164206,
164208 thru 164210,
164212 thru 164215,
164217, 164218

BLOCK 33 (23)

164220 thru 164223,
164225 thru 164227,
164229 thru 164236,
164234 thru 164236,
164238 thru 164240,
164242 thru 164244,
164246 thru 164248

BLOCK 34 (24)

164250 thru 164253,
164255 thru 164258,
164260 thru 164262,
164264 thru 164266,
164268 thru 164271,
164273 thru 164278

LOT 14

BLOCK 35 (22)

164627 thru 164648

BLOCK 36 (11)

164654, 164655,
164657, 164658,
164660, 164661,
164663, 164664,
164666, 164668,
164669

BLOCK 37 (13)

164671, 164673,
164675, 164676,
164678, 164680,
164681, 164682,
164684, 164686,
164687, 164689,
164691

LOT 15

BLOCK 38 (12)

164693,
164695 thru 164698,
164700, 164701,
164703, 164704,
164706 thru 164708

BLOCK 39 (12)

164709, 164710,
164712, 164713,
164715, 164716,
164718 thru 164722,
164724

BLOCK 40 (12)

164725, 164727,
164728, 164730,
164731 thru 164734
164736, 164737,
164739, 164740

F/A-18D

LOT 10

BLOCK 23 (8)

163434, 163436,
163441, 163445,
163447, 163452,
163454, 163457

BLOCK 24 (8)

163460, 163464,
163468, 163472,
163474, 163479,
163482, 163486

BLOCK 25 (7)

163488, 163492,
163497, 163500,
163501, 163507,
163510

LOT 11

BLOCK 26 (3)

163700, 163707,
163720

BLOCK 27 (2)

163734, 163749

BLOCK 28 (3)

163763, 163771,
163778

LOT 12

BLOCK 29 (10)

163986, 163989,
163991, 163994,
163997, 164001,
164005, 164009,
164011, 164014

BLOCK 30 (10)

164017, 164019,
164022, 164024,
164026, 164028,
164032, 164035,
164038, 164040

BLOCK 31 (10)

164043, 164046,
164049, 164051,
164053, 164056,
164058, 164061,
164064, 164068

LOT 13

BLOCK 32 (7)

164196, 164198,
164203, 164207,
164211, 164216,
164219

BLOCK 33 (7)

164224, 164228,
164233, 164237,
164241, 164245,
164249

BLOCK 34 (6)

164254, 164259,
164263, 164267,
164272, 164279

LOT 14

BLOCK 35 (0)

BLOCK 36 (10)

164649 thru 164653,
164656, 164659,
164662, 164665,
164667

BLOCK 37 (10)

164670, 164672,
164674, 164677,
164679, 164683,
164685, 164688,
164690, 164692

LOT 15

BLOCK 38 (4)

164694, 164699,
164702, 164705

BLOCK 39 (4)

164711, 164714,
164717, 164723

BLOCK 40 (4)

164726, 164729,
164735, 164738

Figure 1-2. Block Numbers (Sheet 2 of 3)

F/A-18C

LOT 16
BLOCK 41 (9)
 164865, 164867,
 164869, 164871,
 164873, 164875
 164877, 164879,
 164881
BLOCK 42 (12)
 164883, 164885,
 164887, 164889,
 164890, 164891,
 164892, 164893,
 164894, 164895,
 164896, 164897,
BLOCK 43 (13)
 164899, 164900,
 164902, 164903,
 164904, 164905,
 164906, 164907,
 164908, 164909,
 164910, 164911,
 164912
LOT 17
BLOCK 44 (7)
 164946, 164948,
 164950, 164952,
 164954, 164956,
 164958
BLOCK 45 (12)
 164960, 164962,
 164964, 164966,
 164968, 164970,
 164972, 164973,
 164974, 164975,
 164976, 164977
BLOCK 46 (15)
 164978, 164979,
 164980, 164981,
 164982, 164983,
 164984, 164985,
 164986, 164987,
 164988, 164989,
 164990, 164991,
 164992
LOT 18
BLOCK 47 (12)
 165171 thru 165182
BLOCK 48 (12)
 165183 thru 165194
BLOCK 49 (12)
 165195 thru 165206

LOT 19
BLOCK 50 (24)
 165207 thru 165230
LOT 20
BLOCK 51 (10)
 165399 thru 165408
LOT 21
BLOCK 52 (1)
 165526

F/A-18D

LOT 16
BLOCK 41 (9)
 164866, 164868,
 164870, 164872
 164874, 164876,
 164878, 164880
 164882
BLOCK 42 (3)
 164884, 164886,
 164888
BLOCK 43 (2)
 164898, 164901,
LOT 17
BLOCK 44 (8)
 164945, 164947,
 164949, 164951,
 164953, 164955,
 164957, 164959,
BLOCK 45 (6)
 164961, 164963,
 164965, 164967,
 164969, 164971
BLOCK 46 (0)
LOT 18
BLOCK 47 (0)
BLOCK 48 (0)
BLOCK 49 (0)

LOT 19
BLOCK 50 (0)
LOT 20
BLOCK 51 (8)
 165409 thru 165416
LOT 21
BLOCK 52 (14)
 165527 thru 165532
 165680 thru 165687

Figure 1-2. Block Numbers (Sheet 3 of 3)

CHAPTER 2

Systems

2.1 POWER PLANT SYSTEMS

2.1.1 Engines. The aircraft is powered by two General Electric engines: F404-GE-400 in Lot 13 and below and either F404-GE-400 or F404-GE-402 in Lot 14 and up. The military thrust of each F404-GE-400 engine is approximately 10,700 pounds with maximum afterburner thrust in the 16,000 pound class. The military thrust of each F404-GE-402 engine is approximately 10,900 pounds with maximum afterburner thrust in the 18,000 pound class. The aircraft thrust-to-weight ratio is in the 1 to 1 class. The engine is a low bypass axial-flow turbofan with afterburner. The three-stage fan (low pressure compressor) is driven by a single stage turbine. Approximately one-third of the fan discharge air is bypassed to the afterburner for combustion and cooling. The seven-stage high pressure compressor is also driven by a single stage turbine. The first and second stage compressor stators are variable. Fourth stage compressor air is used by the engine anti-ice system. A set of variable inlet guide vanes are mounted in front of both the fan and compressor to direct the inlet air at the best angle for the existing engine operation. Atomized fuel and compressor discharge air is mixed and ignited in the combustion chamber. These ignited gases then pass through the compressor and fan turbines and out the engine exhaust. Afterburner operation uses added atomized fuel mixed with the combustion discharge gases and the bypass fan discharge air to produce additional thrust. The electrical control assembly, variable exhaust nozzles, main fuel control, and afterburner fuel control provide coordinated operation of the engine through every part of its envelope. The engine accessory gearbox, driven by the compressor rotor, powers the lubrication and scavenge oil pumps, variable exhaust nozzle power unit, alternator, main fuel pump and control, and afterburner fuel pump and control. An aircraft-mounted auxiliary power unit is used to start the engines.

2.1.1.1 Air Induction System. The air induction system is designed to provide compatible air to the engine. The system uses a fixed geometry compression ramp, a fuselage boundary layer diverter system and a ramp boundary layer bleed system. The compressor ramp provides the correct oblique shock wave for inlet air at most Mach numbers.

NOTE

Engine inlet duct rumble may be present at Mach numbers greater than 1.75.

The fuselage boundary layer diverter system prevents low energy air from entering the inlets. This low energy air is diverted below the fuselage. The rear part of the compression ramp is porous to prevent this boundary layer air from entering the inlet. Part of the boundary layer air is bled through a fixed area outlet into the fuselage boundary layer diverter channel. The other part exits on top of the wing through inlet duct doors, when open.

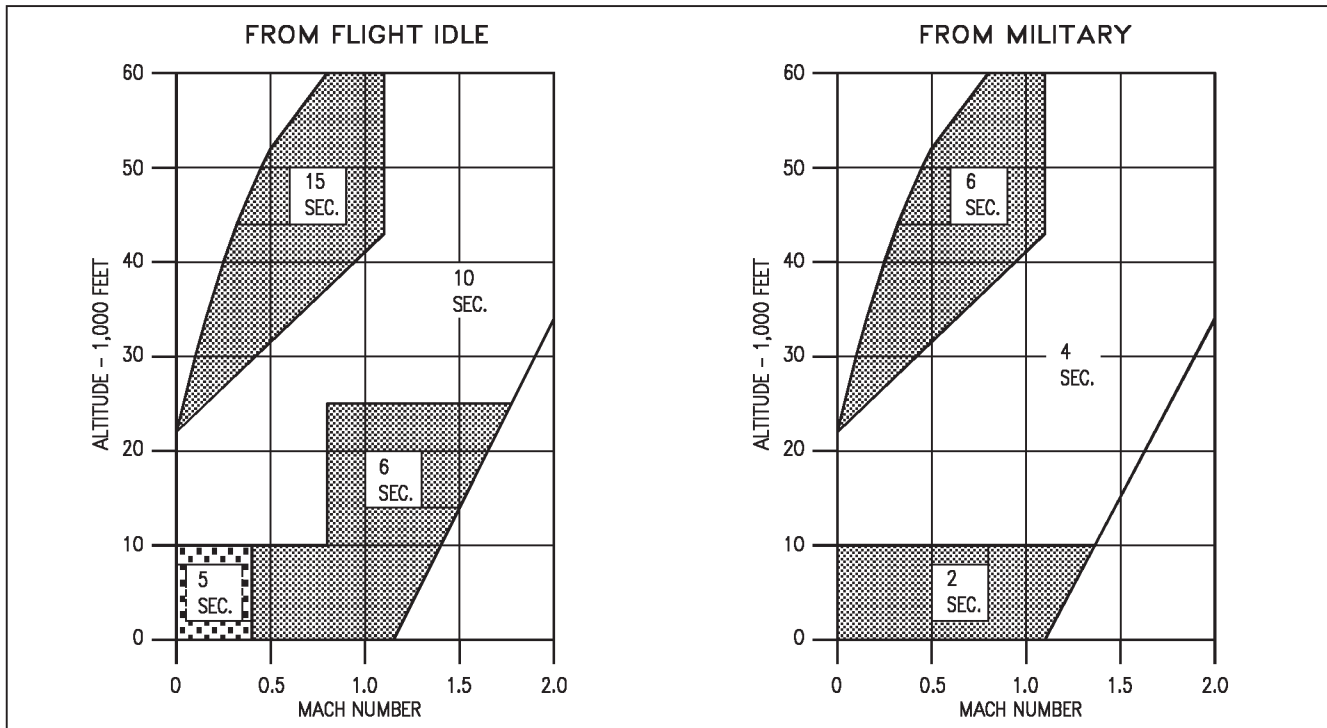

1BAC-NFM-00-(6-1)31-CATI

Figure 2-1. Afterburner Light-Off Time

2.1.1.1.1 Inlet Duct Doors. The electrically operated inlet duct doors (one for each inlet) automatically open at Mach 1.33 (accelerating) and close at Mach 1.23 (decelerating). The doors are controlled by the flight control computer.

2.1.1.1.2 Engine Control System. The engine control system consists of the throttle, main fuel control, electrical control assembly (ECA) and afterburner fuel control. Throttle movement is mechanically transmitted to a power lever control. The power lever control acts as a power booster and positions the main fuel control. If the automatic throttle control is engaged, it schedules the power lever control for existing engine power requirements and the throttle follows this movement. Below MIL power, throttle movement and compressor inlet temperature (through the main fuel control) control the compressor speed (rpm). At MIL and above, fan speed is controlled by the ECA as a function of inlet temperature. At and above military power, the ECA senses engine and aircraft parameters, computes engine schedules and maintains engine limits.

NOTE

A lockup device in the main fuel control prevents thrust reduction below military if aircraft speed is Mach 1.23 or higher.

2.1.1.1.3 Afterburner Fuel Control. The afterburner fuel control schedules fuel flow to the pilot spraybar and main spraybars. When the throttle is advanced to afterburner, ignition is turned on, the exhaust nozzle opens slightly above the MIL position, the low pressure turbine discharge temperature schedule is temporarily reset to a lower value, and afterburner pilot spraybar fuel flow and minimum afterburner main fuel flow begins. When afterburner light-off is detected, ignition is turned off and afterburner main fuel flow increases to the level selected by the throttle position. Since main fuel flow is withheld until a positive light-off is attained, a hard light should not occur. Refer to figure 2-1 for afterburner light-off time. A successful afterburner light-off is indicated by the exhaust nozzle opening

to a position greater than MIL (scheduled as a function of power lever angle (PLA)). Nozzle position at MAX power is approximately 50 % greater than MIL.

2.1.1.4 Ignition System. The ignition system contains an independent engine mounted alternator, electrical control unit, ignition exciter, a main igniter and an afterburner igniter. During engine start, moving the throttle from OFF to IDLE turns on ignition. Ignition remains on until the engine reaches 45 % rpm. Engine ignition also comes on if a flame-out occurs or when afterburner is selected. Afterburner ignition comes on when the throttle is moved into afterburner and remains on until an afterburner light-off is sensed. If more than 50 % afterburner is selected, ignition is automatically turned on if an afterburner blowout occurs.

2.1.1.5 Lubrication System. The lubrication system is self-contained and consists of a pressure-filled supply tank, lubrication pump, scavenge pumps, oil filter, oil cooler, gearbox, engine sumps, scavenge screens, magnetic chip detectors, pressure transducer, pressure regulator, and interconnecting piping. Oil gravity-flows from the tank to the pump. A pressure transducer, the engine oil pressure transmitter, is located in the pump output line. The engine oil pressure transmitter is an electrical transmitter that does not have any control authority and is used for monitoring purposes only. The engine oil pressure transmitter sends an electrical signal to the cockpit pressure indicator. The loss of engine oil pressure would lead to engine vibrations, RPM would decrease, and the engine would eventually seize.

2.1.1.6 Engine Anti-Ice. A separate engine bleed air system, internal to the engine and from a different compressor stage than the aircraft bleed air, is used for engine anti-ice.

2.1.1.6.1 Engine Anti-Ice Switch

ON	Activates the engine anti-ice system.
OFF	Deactivates the engine anti-ice system.
TEST	Checks ice detector operation and turns on INLET ICE display.

2.1.1.7 Engine Controls and Instruments

2.1.1.7.1 Engine Crank Switch. An engine crank switch is on the left console. The switch has positions of L (left), OFF and R (right). During engine start, placing the switch to L or R starts engine crank for the corresponding left or right engine. The switch is electrically held in the L or R position. As the engine accelerates to a self-sustaining rpm, the switch automatically returns to OFF.



Ensure engine speed is below 30 % N₂ before actuating the engine crank switch. Failure to do so may shear the air turbine starter shaft.

2.1.1.7.2 Throttles. Movement of the throttles is transmitted by mechanical linkage to the engine mounted power lever controls. The engine mounted power lever controls convert the linear mechanical movement from the throttles to rotary motion that moves the fuel control input arms. During manual operation, pneumatic throttle boost actuators powered by environmental control system (ECS) air reduce the force required to move the throttles. During automatic throttle control (ATC) operation, the pneumatic boost actuators are disengaged. A friction adjusting lever is mounted next to the right

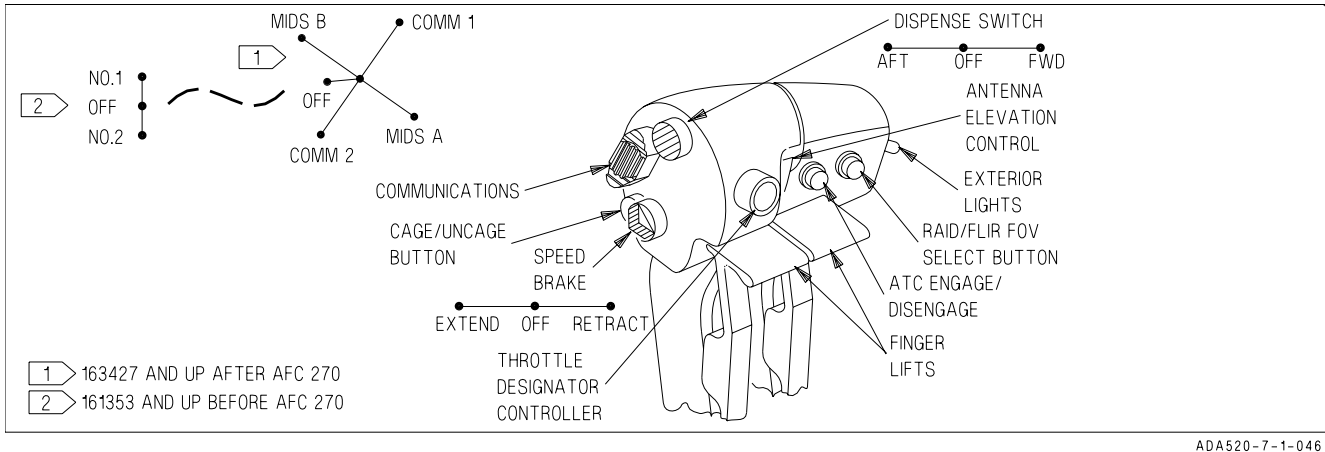

Figure 2-2. Throttle Grips

throttle. Advancing the throttles from OFF to IDLE (during engine start) opens the engine fuel control shutoff valves and activates engine ignition. Finger lifts, on the front of each throttle, must be raised to place the throttles OFF. With weight on the wheels, launch bar retracted and the arresting hook UP or with weight off the wheels, afterburner operation is initiated by advancing the throttles through the MIL detent gates into MAX. On the ground, an afterburner lockout system helps guard against inadvertent afterburner selection. With weight on the wheels and launch bar extended or the arresting hook DOWN, the afterburner lockout extends and the finger lifts must be raised or a force of approximately 32 pounds must be applied before the throttles can be moved to MAX. A retractable inflight IDLE stop extends with weight off the wheels and provides a higher IDLE rpm and reduced acceleration time to MIL.

NOTE

During high g maneuvers when moving the throttle to idle, the flight idle stop may retract and allow selection of ground idle.

With weight on the wheels, the inflight stop is retracted and the ground IDLE stop is used. Moving the throttles to OFF closes the engine fuel control shutoff valves, stopping fuel flow to the engines. The throttle grips (figure 2-2) contain switches that provide various systems control without moving the hand from the throttles.

2.1.1.7.3 Dispense Switch. The dispense switch is located on the top inboard side of the right throttle. The switch is used to dispense flares and chaff.

ALE-39 Countermeasure System -

- Forward CHAFF
- Center OFF
- Aft FLARE

ALE-47 Countermeasure System -

Forward	Provides semi-automatic consent. Dispenses chaff singles (C/F mode).
Center	OFF
Aft	Initiates the selected manual program. Dispenses flare singles (C/F mode).

2.1.1.7.4 Engine Monitor Indicator (EMI) (F/A-18A/B).**NOTE**

If one or more of the engine parameters are blank or frozen, that parameter may be invalid. If the parameter is invalid, the associated engine caution will be inhibited.

The engine monitor indicator contains a left and right display for RPM %, EGT °C, FF PPH (fuel flow), NOZ POS % (nozzle position) and OIL PSI (oil pressure).

RPM %	Displays compressor rpm. Range is 0 to 110 % rpm with 1 % rpm increments.
EGT °C	Displays turbine exhaust gas temperature (T_5). Range is 0 to 999 °C with 1 °C increments.
FF PPH	Displays main engine fuel flow only (afterburner fuel flow is not displayed). Range is 300 to 15,000 pounds per hour with 100 pounds per hour increments. The tens and units positions have fixed zeros. When fuel flow is less than 350 PPH, zero is displayed.
NOZ POS %	Displays nozzle position. Range is 0 to 100 % with 10 % increments.
OIL PSI	Displays engine oil pressure. Range is 0 to 200 psi with 10 psi increments.

2.1.1.7.5 Integrated Fuel/Engine Indicator (IFEI) Engine Display (F/A-18C/D).**NOTE**

If one or more of the engine parameters are blank or frozen, that parameter may be invalid. If the parameter is invalid, the associated engine caution will be inhibited.

The integrated fuel/engine indicator (IFEI) engine display, located on the lower left side of the main instrument panel, contains a left and right liquid crystal display for RPM (N_2) %, TEMP (EGT) °C, FF (fuel flow) PPH, NOZ (nozzle position) %, and OIL (oil pressure) psi. During engine starts without external electrical power, only RPM and TEMP are displayed by battery power until the APU comes on line. With the APU on line or external power, all engine data is displayed. If the IFEI stops receiving data from the signal data computer, the IFEI flashes the last data received until communication with the signal data computer is restored.

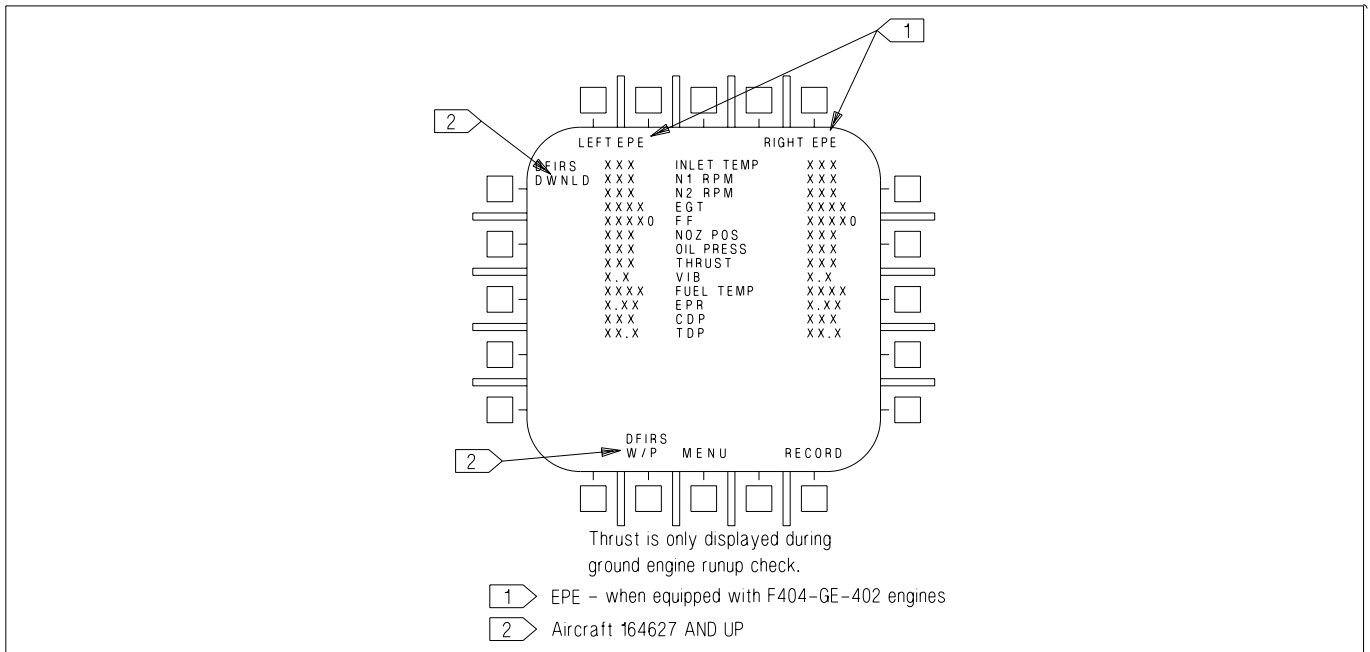

ADA520-8-1-045

Figure 2-3. Engine Monitor Display (EMD)

RPM	Displays engine N ₂ rpm from 0 to 199 %.
TEMP	Displays turbine exhaust gas temperature (EGT) from 0 to 1,999 °C.
FF	Displays main engine fuel flow only (afterburner fuel flow is not displayed). Range is 300 to 199,900 pounds per hour with 100 pound per hour increments. When fuel flow is less than 320 PPH, zero is displayed.
NOZ	Displays exhaust nozzle position from 0 to 100 % open in 10 % increments.
OIL	Displays engine oil pressure from 0 to 195 psi in 5 psi increments.

2.1.1.7.6 Engine Monitor Display (EMD).

NOTE

If one or more of the engine parameters are blank or frozen, that parameter may be invalid. If the parameter is invalid, the associated engine caution will be inhibited.

The engine monitor display (figure 2-3) may be selected on either DDI by pressing MENU, then pressing ENG. On aircraft equipped with F404-GE-402 engines, LEFT EPE and RIGHT EPE appear at the top line of the EMD. If a malfunction exists, pressing RECORD will assist the ground crew during troubleshooting.

INLET TEMP	Engine inlet temperature in °C.
N ₁ RPM	Fan speed in % rpm.
N ₂ RPM	Compressor speed in % rpm.
EGT	Exhaust gas temperature in °C.
FF	Fuel flow in pounds per hour.
NOZ POS	Nozzle position in %.
OIL PRESS	Oil pressure in psi.
THRUST	Thrust in %.
VIB	Engine vibration in inches per second.
FUEL TEMP	Engine inlet fuel temperature in °C.
EPR	Engine pressure ratio (ratio of exhaust pressure to ambient inlet pressure). On aircraft 161925 AND UP with weight off wheels, EPR is a ratio of exhaust pressure to ambient total inlet pressure. On all aircraft, EPR is valid only during ground static conditions.
CDP	Compressor discharge pressure in psia.
TDP	Turbine discharge pressure in psia.
RECORD	When button is pressed, existing displays are recorded on a magnetic tape. On aircraft 161925 AND UP, when power is first applied to the aircraft, the RECORD option is not displayed until the mission computer initialization is complete. When the RECORD button is pressed and recording is in progress, the RECORD display is boxed.
DFIRS W/P	This function is not operational. (Aircraft 163427 THRU 164279 AFTER AFC 258 and aircraft 164627 AND UP)
DFIRS DWNLD	Downloads DFIRS/CSFIRS data to MU for easier retrieval. (Aircraft 163427 THRU 164279 AFTER AFC 258 and aircraft 164627 AND UP)

2.1.1.7.7 Caution and Advisory Displays. The following engine related caution and advisory displays may appear on the DDI:

CAUTION

ENG MATCH	One engine is F404-GE-400 and other engine is F404-GE-402.
L or R OVRSPD	Designated fan or compressor rpm high.
L or R EGT HIGH	Either engine EGT over limit.

L or R IN TEMP	Designated engine inlet temperature is out of limits. Operation behind another aircraft's exhaust may cause a false caution. On aircraft 161925 AND UP, the L and R IN TEMP caution is inoperative on the ground with engine rpm below approximately 76 %. However, a false caution may be displayed if rpm is above approximately 76 %.
L or R STALL	Stall detected.
L or R FLAMEOUT Aircraft 161925 AND UP	Designated engine failed. To prevent false cautions the system is deactivated until after normal engine start and anytime the throttle is placed below IDLE.
INLET ICE	Icing condition in either engine inlet.
L or R DUCT DR	Designated inlet duct door closed above Mach 1.33 or open below Mach 1.23.
L or R OIL PR	Designated engine oil pressure out of limits.
L or R BOOST LO	Designated fuel boost pressure low.

ADVISORY

L or R HEAT	Designated engine anti-ice switch ON.
-------------	---------------------------------------

In addition, the ENGINE LEFT (RIGHT) voice alert is activated when any of the following cautions are displayed: L or R OVRSPD, L or R EGT HIGH, L or R IN TEMP, L or R FLAMEOUT, L or R OIL PR and L or R STALL.

2.1.2 Automatic Throttle Control (ATC). The automatic throttle control is a two mode system that automatically maintains angle of attack (approach mode) or airspeed (cruise mode) by modulating engine thrust in the range of flight idle through military. Automatic transition between the two modes or single-engine engagement is not possible. When either mode is engaged, the ECS air to the torque boosters is shut off, the throttles are initially backdriven, a stop is extended in the power lever control (PLC) to limit throttle travel from flight idle to MIL, and an ATC advisory is displayed on the HUD. If either mode does not engage when selected, or automatically disengages after engagement, the ATC display flashes for 10 seconds and is then removed from the HUD. If a force of approximately 12 pounds (with friction off) is applied to either throttle the system automatically disengages. This force is sufficient to permit the hand to follow throttle movement without causing disengagement. It is recommended that the friction lever be in the full aft position and both throttles set between flight idle and MIL before engaging ATC. If a mechanical failure occurs, a force of approximately 68 pounds (with friction off) is required to override the system. When either mode is engaged, changing the FLAP

switch between AUTO and HALF or FULL automatically disengages the system. If the system is disengaged for any reason, it remains disengaged until reengagement is initiated by the pilot.

NOTE

Momentary force applied to the throttle(s) (throttle rap) may not disengage the ATC system. The force must be applied and held for a minimum of 0.10 second.

If the ATC commands the throttles to MIL, it may not be possible to manually advance the throttles into the afterburner range without first disengaging the ATC through momentary throttle reduction using more than 12 pounds of force.

If the throttle(s) are being held against the flight idle or MIL stop as ATC is disengaged, the stops may not disengage until pressure is removed from the throttle(s).



Auto throttle system performance will be degraded if preflight FCS BIT produces BLIN code 124, 322, 336, 4124, 4322, 4336, 4522, 4526, 4527, 4773, or 4774. Do not utilize the auto throttle system. Use of ATC with these codes could result in uncommanded throttle movements.

2.1.2.1 ATC Approach Mode. The ATC approach mode is engaged by pressing and releasing the ATC button on the left throttle with the FLAP switch in HALF or FULL and the trailing edge flaps extended at least 27°. When ATC is engaged in the approach mode, the flight control computer modulates engine thrust to maintain on-speed AOA. The computer uses inputs of AOA, normal load factor, stabilator position, pitch rate, and angle of bank to generate command signals. These signals drive the engine mounted throttle control units which in turn command the engine fuel controls. The computer uses AOA as the primary input to generate command signals. However, normal load factor provides increased stability, stabilator position provides increased or decreased thrust for pilot induced pitch changes, pitch rate provides lead during pitch maneuvers, and bank angle provides additional thrust during banking maneuvers. Normal disengagement is accomplished by pressing the ATC button or applying and holding force to either throttle. Automatic disengagement occurs for the following reasons:

- Flap AUTO up
- AOA sensor failure
- Two or more failures of either trailing edge flap
- Trailing edge flap deflection less than 27°
- ATC button fails
- FCES channel 2 or 4 fails
- WOW
- FCS reversion to MECH or to DEL in any axis
- Left and right throttle angles differ by more than 10° for more than 1 second
- Bank angle exceeds 70°
- Any internal system failure
- Selection of GAIN ORIDE

2.1.2.2 ATC Cruise Mode. The ATC cruise mode is engaged by pressing and releasing the ATC button on the left throttle with the FLAP switch in AUTO. When ATC is engaged in the cruise mode, the existing airspeed is used by the flight control computer to modulate engine thrust to maintain this existing airspeed. The existing airspeed is the airspeed being sent from the ADC to the flight control computers via the mission computers. An ADC failure inhibits the ATC cruise mode of operation. The FCC uses true airspeed from ADC via the mission computers at the time of engagement to generate a command signal. This signal is then used as a reference to generate an error signal that drives the engine mounted throttle control units. Normal disengagement is accomplished by pressing the ATC button or applying and holding force to either throttle. Automatic disengagement occurs for the following reasons:

- Flaps HALF or FULL
- ATC button fails
- FCES channel 2 or 4 fails
- FCS reversion to MECH or to DEL in any axis
- Left and right throttle angles differ by more than 10° for more than 1 second
- ADC true airspeed failure
- ADC degrade
- Any internal system failure

2.2 FUEL SYSTEM

Refer to Fuel System, Foldout Section, for fuel system illustration. Fuel is carried internally in four interconnected fuselage tanks and two internal wing (wet) tanks. External fuel is carried in 315 or 330 gallon tanks which may be mounted on the centerline and/or inboard wing station pylons. A fuel quantity indicating system provides fuel quantity indications in pounds. All tanks may be refueled on the ground through a single pressure refueling point. Airborne, they can be refueled through the aerial refueling probe. The internal wing tanks, tank 1, and tank 4 are transfer tanks. Tanks 2 and 3 are engine feed tanks. The tanks are arranged so internal fuel gravity transfers (at a reduced rate) even if the transfer pumps fail. Regulated engine bleed air pressure transfers fuel from the external tanks and also provides a positive pressure on all internal fuel tanks. Float type fuel level control valves control refueling of all tanks. These same valves are used to control transfer from the internal wing tanks to tanks 1 and 4 in A/B aircraft, and to tank 2 from the left wing tank and to tank 3 from the right wing tank in F/A-18C/D aircraft. Jet level sensors are used to control transfer from tanks 1 and 4 to tanks 2 and 3. All internal and external tanks except tanks 2 and 3 (and internal wing tanks in F/A-18C/D aircraft) may be dumped overboard from an outlet in each vertical fin. All internal fuel tanks are vented through the vent outlet in each vertical fin. The external tanks are vented through the vent outlets in their individual tanks.

2.2.1 Survivability. The internal wing tanks contain foam for fire/explosion protection. The lower section of the feed tanks are self sealing for “get home” protection. Fuel lines are routed inside the tanks where possible. Fuel feed lines in the main landing gear wells are wrapped with a self-sealing protective shell.

2.2.2 Fuel Tank Pressurization and Vent. The pressurization and vent system provides regulated engine bleed air pressure to all internal tanks to prevent fuel boil-off at altitude and to the external tanks for fuel transfer. The system also provides pressure relief of the fuel tanks during climbs and vacuum relief of the fuel tanks during descent if the pressurization system fails. All tanks are pressurized any time engine bleed air is available, electrical power is on, weight is off the main gear, the air refueling probe is retracted, and in F/A-18A/B aircraft, the HOOK handle is UP or in F/A-18C/D aircraft, either the HOOK handle or the LDG GEAR handle is UP. All external tanks can be

pressurized any time by placing either external tank fuel control switch to ORIDE (HOOK handle must be up in A/B aircraft). The internal tanks vent into the fuselage vent tank which in turn is vented through the vertical fin vent tanks to an outlet in each vertical fin. Any fuel in the vertical fin vent tank returns to the vent tank by gravity flow. Any fuel that accumulates in the vent tank is returned to tanks 2 and 3 by scavenge pumps.

2.2.2.1 Tank Pressurization Caution Display. With MC OFP 10A AND UP, a TANK PRESS caution indicates the internal tanks are pressurized on the ground, or low internal tank pressure inflight above 20,000 feet. With MC OFP 13C AND UP, a TK PRES LO caution indicates low internal tank pressure inflight above 20,000 feet and a TK PRES HI caution indicates the internal tanks are pressurized on the ground, or high internal tank pressure inflight. TANK PRESS or TK PRES LO are also displayed above 20,000 feet when depressurization is caused by extending the inflight refueling probe, or moving the hook handle down (F/A-18A/B aircraft), or moving the hook handle and the landing gear handle down (F/A-18C/D aircraft). With TANK PRESS or TK PRES LO displayed inflight and either a low fuel state or hot fuel, fuel may boil off and be vented. A high rate of descent may damage the fuel cells. With TK PRES HI displayed inflight, high g maneuvering may result in structural damage.

2.2.2.2 Vent Fuel Caution Display. On aircraft 161249 THRU 161357, the VENT FUEL caution display on the DDI indicates that fuel is in the left and/or right vertical fin vent system.

2.2.2.3 External Tank Pressurization Caution Display. An EXT TANK caution display on the DDI indicates the external tanks are pressurized with the aircraft on the ground.

2.2.3 Internal Transfer

2.2.3.1 Internal Transfer (F/A-18A/B). Normal fuel transfer is accomplished by ejector pumps powered by motive flow. Motive flow pressure is produced by two motive flow/boost pumps, each driven by an airframe mounted accessory drive (AMAD). If an AMAD or pump failure occurs, the other pump produces sufficient motive flow pressure to power all the ejector pumps. The ejector pumps in the internal wing tanks automatically transfer fuel to tanks 1 and 4 when the fuel level control valves in these two tanks open. The ejector pumps in tanks 1 and 4 transfer fuel to tanks 2 and 3 when the jet level sensors in the feed tanks are uncovered, allowing their transfer control valves to open. On aircraft 161925 AND UP AFTER AFC 039, fuel transfer from tanks 1 and 4 is shut off during negative g flight. After tank 1, tank 4 or a wing tank empties, fuel low level floats shut off motive flow to the ejector pump in that tank.

2.2.3.2 Internal Transfer (F/A-18C/D). Normal fuel transfer is accomplished by motive flow powered ejector pumps in the internal wing tanks and turbine-driven pumps in tanks 1 and 4. Motive flow pressure is produced by two motive flow/boost pumps, each driven by an airframe mounted accessory drive (AMAD). Two separate motive flow systems exist, with the right AMAD pump powering the transfer pumps in the right wing and tank 4 and the left AMAD pump powering the transfer pumps in the left wing and tank 1. If an AMAD or motive flow/boost pump failure occurs, a cross-motive valve opens, allowing the good side to power all the transfer pumps. The wings transfer first and transfer is controlled by the feed tank fuel level control valves. The ejector pumps transfer left wing fuel to tank 2 and right wing fuel to tank 3. When tanks 2 and 3 deplete to jet level sensor control range, the turbine-driven pumps in tanks 1 and 4 transfer fuel to tanks 2 and 3 when the sensors are uncovered, allowing the transfer control valves to open. Fuel transfer from tanks 1 and 4 is shut off during negative g flight. After tank 1 or tank 4 empties, fuel low level floats shut off motive flow to the turbine-driven pump in that tank. The ejector pumps do not shut off when the internal wing tanks are empty.

2.2.3.3 Internal Wing Tank Fuel Control Switch. An internal wing tank fuel control switch, labeled INTR WING is on the EXT LT panel.

NORM	Provides automatic fuel transfer of the internal wing tanks.
INHIBIT	Electrically closes the wing damage control valve (F/A-18A/B) or the wing motive flow control valves (F/A-18C/D) and the wing refuel level control valves and switches the diverter valves to the feed tank position. The closed wing damage control valve or wing motive flow control valves prevent normal transfer of the internal wing fuel. The closed wing level control valves prevent air refueling of and external transfer to the internal wing tanks. Gravity transfer allows transfer of some wing fuel at a reduced rate and quantity to tank 4. The repositioned diverter valves return recirculated fuel directly to the feed tanks.

2.2.3.4 CG Control. Aircraft 161353 THRU 161519 AFTER AFC 039 AND 161520 AND UP are equipped with a CG control system which automatically controls tank 1 fuel transfer to maintain proper aircraft CG. The system periodically shuts off tank 1 fuel transfer to keep tank 1 and tank 4 properly balanced. CG control operates until the FUEL LO caution comes on, or tank 4 drops below 150 pounds. When tank 4 reaches 150 pounds, tank 1 should indicate:

- 1,350 to 1,700 pounds (F/A-18A)
- 750 to 1,100 pounds (F/A-18B)
- 1,375 to 1,550 pounds (F/A-18C)
- EMPTY (F/A-18D)

See figure 2-4. Aircraft 161353 THRU 161519 BEFORE AFC 039 are not equipped with a CG control system; refer to figure 11-7 for normal tank 1 and tank 4 fuel levels.

NOTE

On aircraft with CG control, if tank 4 fuel transfer fails tank 1 does not transfer fuel until the FUEL LO caution comes on. After the FUEL LO caution comes on, tank 1 transfers fuel to both engine feed tanks until the FUEL LO caution is removed. Tank 1 fuel transfer then remains cyclic until it is empty.

2.2.3.5 CG Caution Display (MC OFF 10A AND UP). On Aircraft 161353 THRU 161519 AFTER AFC 039 AND 161520 AND UP, a CG caution display indicates that tank 1 and tank 4 fuel is not sequencing properly. CG may be further aft than normal. Refer to Flight Characteristics, Chapter 11. The caution does not come on if the air refueling probe is extended, or the fuel level in tank 4 drops below 450 pounds (F/A-18A/B/C) or 2,800 pounds (F/A-18D).

2.2.3.6 FUEL XFER Caution Display (MC OFF 13C AND UP). A FUEL XFER caution display indicates that tank 1 and tank 4 fuel is not sequencing properly. CG may be further aft than normal. Refer to Flight Characteristics, Chapter 11. The caution does not come on if the air refueling probe is extended, or the fuel level in tank 4 drops below 450 pounds (F/A-18A/B/C) or 2,800 pounds (F/A-18D).

2.2.3.7 Gravity Transfer. If any or all transfer pumps fail, internal fuel transfers by gravity. The flow rate is dependent on the difference in the fuel level between tanks (head pressure) and most of the transfer fuel is available. It may require sideslip to gravity transfer internal wing tank fuel. The wing tank fuel transfers to tank 4 through gravity transfer lines. Tank 4 and tank 1 transfer to tank 3 and

tank 2, respectively, through flapper valves. A nose down attitude may be required to transfer most of the lower portion of tank 4 fuel to tank 3.

2.2.4 External Transfer. External fuel is transferred by conditioned engine bleed air pressure. A single regulator supplies pressurization to all installed external tanks when weight is off the wheels, the air refueling probe is retracted, and in F/A-18A/B aircraft, the HOOK handle is up or in F/A-18C/D aircraft, either the HOOK handle or LDG GEAR handle is UP. Once the external tanks are pressurized, shut-off valves controlled by the external tank fuel control switches provide selection of fuel transfer from either the external wing tanks only, the external centerline tank only or all three external tanks at the same time. All external tanks can be pressurized any time either external tank fuel control switch is in ORIDE (arresting hook handle must be up in F/A-18A/B aircraft). On F/A-18C/D aircraft, selecting ORIDE also overrides any Signal Data Computer (SDC) stop transfer command. With the external tanks pressurized, fuel transfers when the FUEL LO caution is displayed (the air refueling probe must be retracted in F/A-18C/D aircraft), regardless of the position of the external tank fuel control switches.

NOTE

On F/A-18C/D aircraft, selecting ORIDE on both EXT TANKS fuel control switches may inhibit centerline tank transfer.

2.2.4.1 External Tank Fuel Control Switches. Two EXT TANKS fuel control switches, labeled WING (for external wing tanks) and CTR (for centerline tank), are on the FUEL panel.

NORM	With the external tank(s) pressurized, external fuel transfers to any internal tank that accepts it.
STOP	With the external tank(s) pressurized, external fuel does not transfer until FUEL LO caution display is on.
ORIDE	Pressurization of and fuel transfer from all installed external tanks is provided (HOOK handle must be up in F/A-18A/B aircraft). The other external tank fuel control switch must be in STOP if fuel transfer from its tank(s) is not desired.

2.2.4.2 External Transfer Caution Display. On F/A-18C/D aircraft, an EXT XFER caution display on the DDI indicates that external fuel is available and should have transferred. The caution is also displayed when external fuel is available at BINGO and FUEL LO.

2.2.5 Fuel Feed System. There are two separate fuel feed systems, one for each engine; however, an interconnecting crossfeed system provides fuel feed to both engines from a single fuel feed system if one system fails. An AMAD driven fuel pump provides pressurized fuel flow to each engine. Each pump is a two-stage pump. One stage supplies fuel to the engine and the other stage supplies high pressure fuel to the motive flow system. On aircraft 161353 THRU 161924 BEFORE AFC 018, each AMAD pump is fed from a separate feed tank by an ejector pump powered by motive flow from the AMAD pump. On aircraft 161353 THRU 161924 AFTER AFC 018, and 161925 AND UP, each AMAD pump is fed from a separate feed tank by a turbo pump powered by motive flow from the AMAD pump. Motive flow from each AMAD pump is also used to cool the accessories on that side of the aircraft and to power the transfer pumps. The left engine is normally fed from tank 2 by the left AMAD pump and the right engine is normally fed from tank 3 by the right AMAD pump.

F/A-18 A/B
FUEL XFER CAUTION SCHEDULE
(CG CAUTION WITH MC OFF 10A AND UP)

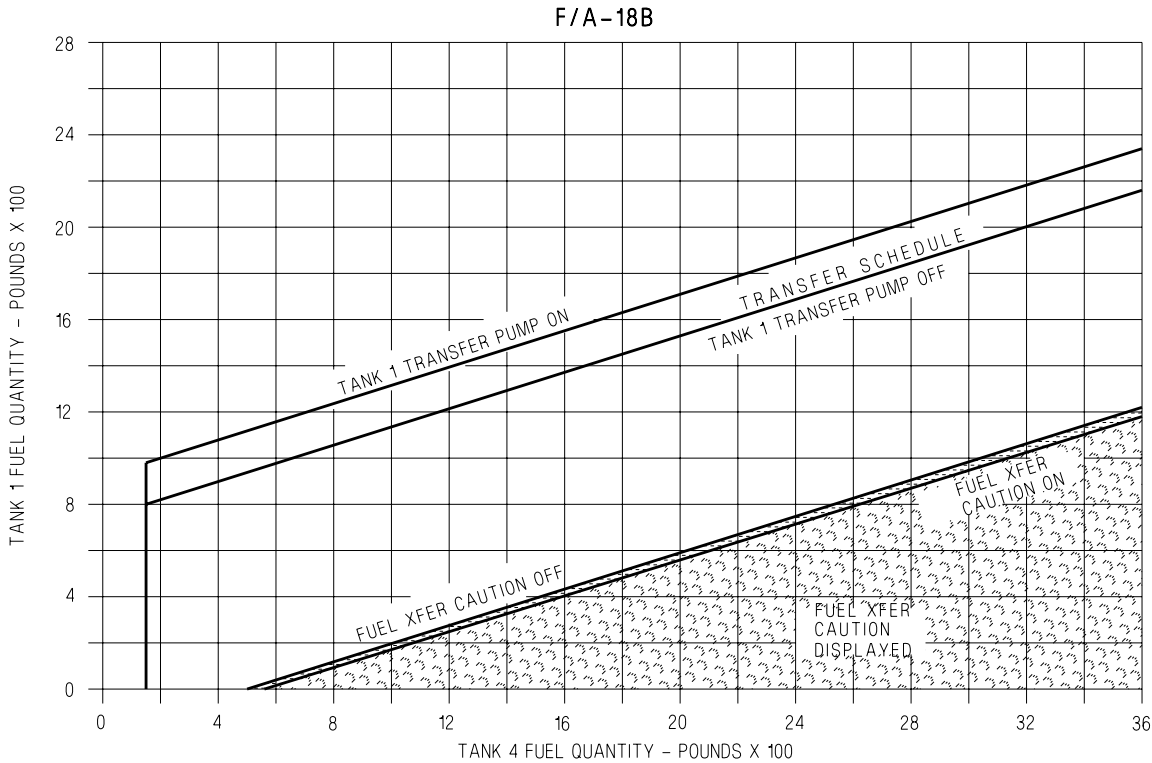
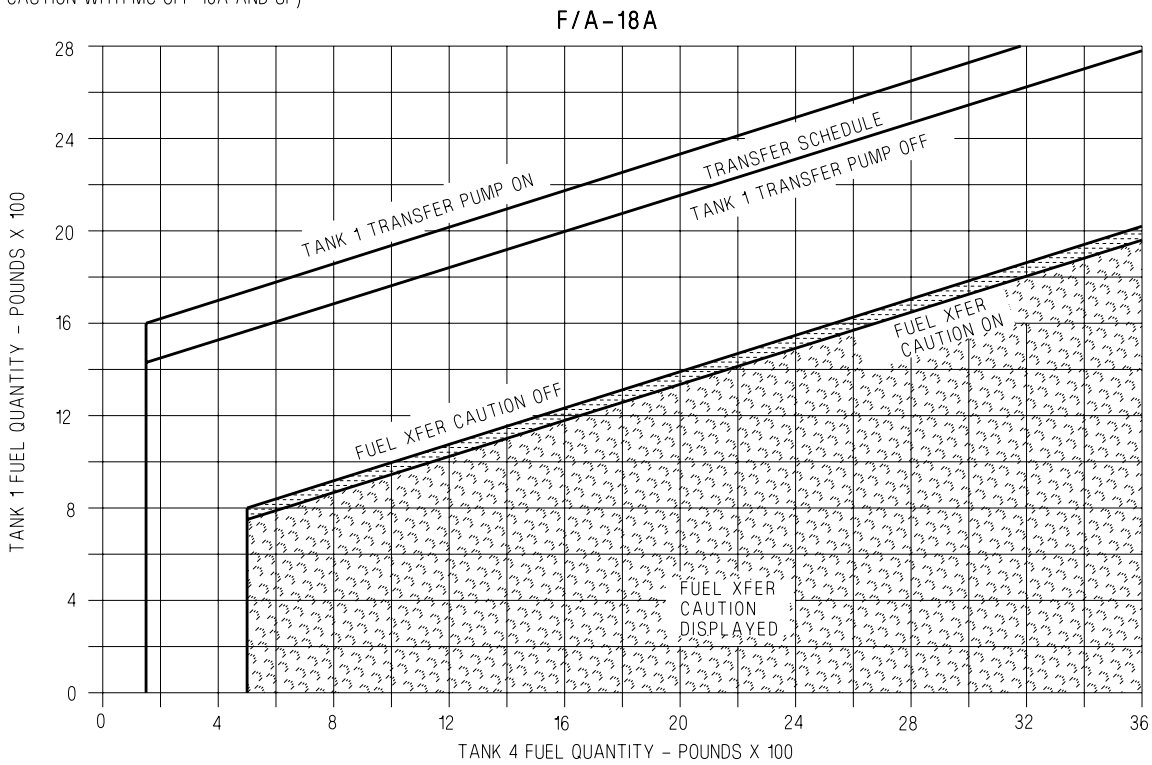

ADA520-9-1-047

Figure 2-4. Tank 1 and 4 Fuel CG Control and FUEL XFER Caution Schedule (Sheet 1 of 2)

F/A-18C/D
FUEL XFER CAUTION SCHEDULE

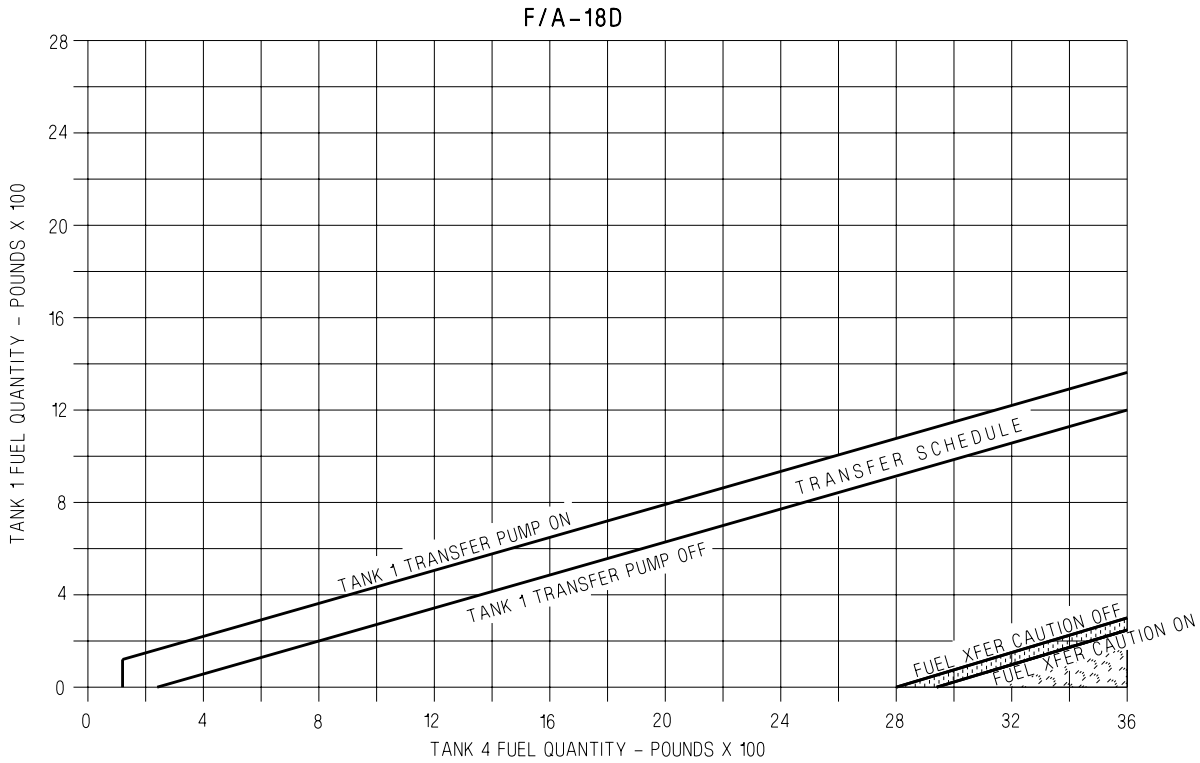
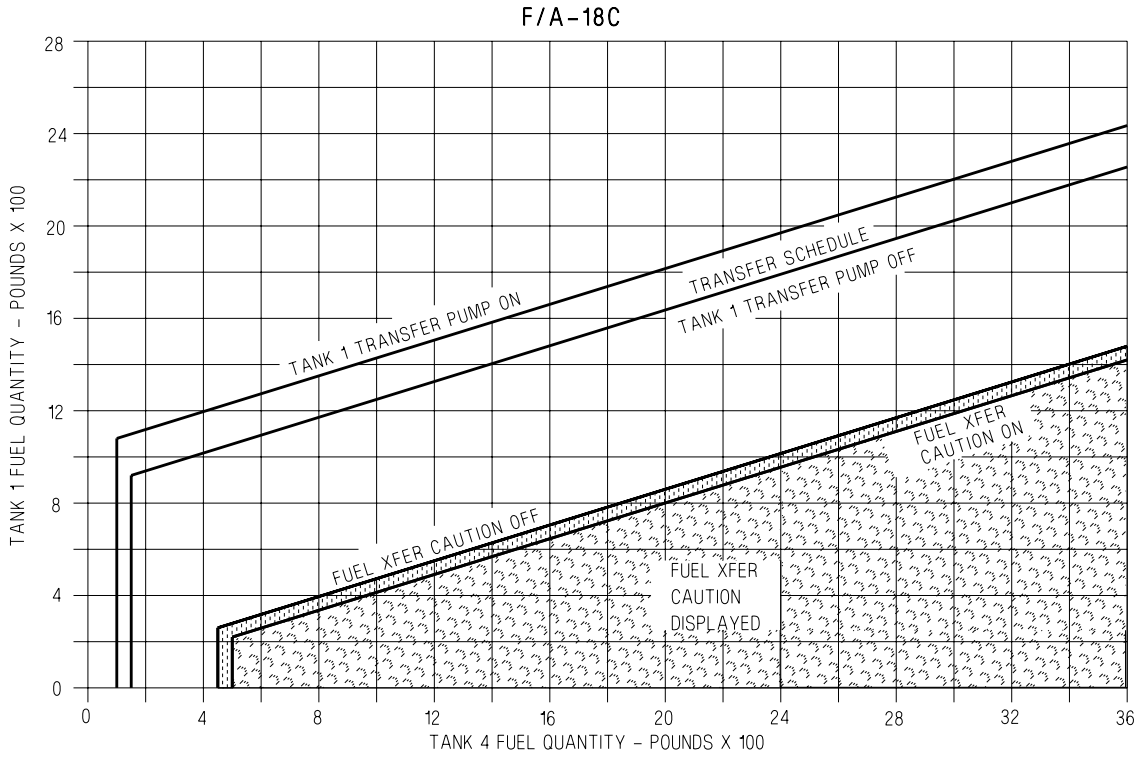

ADA520-9-2-047

Figure 2-4. Tank 1 and 4 Fuel CG Control and FUEL XFER Caution Schedule (Sheet 2 of 2)

2.2.5.1 AMAD Pump BOOST LO Caution Display. An L or R BOOST LO caution is displayed on the DDI if the AMAD pump engine feed pressure is lost on that side. With an L or R BOOST LO caution, a normally closed crossfeed valve downstream from the AMAD pumps opens to allow the good AMAD pump to feed both engines at rates sufficient for MIL power.

On aircraft 161353 THRU 163118 BEFORE AFC 070 and 161353 THRU 161924 AFTER IAFC 056, the fuel boost pressure switches are removed. Without fuel boost pressure switches, the L or R BOOST LO cautions are inoperative and the crossfeed valve is always open (unless a FIRE light is pressed).

2.2.5.2 Fuel Feed With Failed Ejector or Turbo Pump. If an ejector or turbo pump fails, fuel gravity feeds through the inducer inlet to the AMAD driven fuel pump. In this condition, and with high feed tank fuel temperature and high altitude flight, the fuel feed system may not supply enough fuel for the intended power setting but the gravity system provides adequate engine fuel feed for non-afterburner operation.

On aircraft without boost pressure switches, the crossfeed valve remains open and both engines are supplied primarily from the feed tank with an operative ejector or turbo boost pump.

2.2.5.3 Fuel Feed With Loss Of Motive Pressure. If motive flow pressure is lost on either side, the interconnect valve between tanks 2 and 3 opens to allow fuel from the tank with the failed pump to gravity transfer to the other tank. The good ejector or turbo pump supplies fuel from both feed tanks to its AMAD pump. Accessory cooling is not available on the inactive side.

2.2.5.4 Negative G Baffles. Negative g baffles in the feed tanks provide limited fuel supply during negative g or inverted flight. No sustained zero g capability is provided. Transition from positive to negative g may cause display of the L and/or R BOOST LO caution(s).

2.2.5.5 APU Fuel Feed. The APU receives its fuel supply from the left engine feed line upstream of the left engine feed shutoff valve.

2.2.5.6 Left and Right Fire Warning Lights. Lifting the guard and pressing either or both fire warning lights electrically closes the corresponding engine feed shutoff valve at the feed tanks, closes the crossfeed valve and arms the corresponding engine fire extinguisher system. The system operates anytime power is on the aircraft or the battery switch is not OFF.

2.2.6 Fuel Recirculation System. The fuel recirculation system cools the AMAD accessories and HYD 1 and 2 hydraulic oil. Part of the engine motive flow fuel passes through an AMAD oil heat exchanger to absorb heat from the AMAD accessories and through a hydraulic oil heat exchanger to cool the hydraulic oil. On aircraft 161520 AND UP and 161353 THRU 161519 after AFC 021, this fuel then passes through a fuel/air heat exchanger to partially dissipate the heat absorbed from the AMAD and HYD oil heat exchangers. This partially cooled fuel then passes through a diverter valve. Fuel from the diverter valve normally goes to the internal wing tanks where it is further cooled. Normally, as long as fuel is being recirculated, there is as much as 200 pounds fuel in the internal wing tanks but may be less (even zero) at high power settings. If the INTR WING switch is in INHIBIT or the FUEL LO caution is displayed (either engine feed tank at or below 800 pounds), the diverter valves direct the fuel into tanks 2 and 3. In F/A-18C/D aircraft, the recirculated fuel is directed to tanks 2 and 3 during idle descent. Also, with weight on the wheels, tanks 1 and 4 not empty and engine inlet fuel temperature above 80°C, the recirculated fuel is directed to tank 4. This improves fuel heat management.

2.2.6.1 Fuel Hot Caution Display. An L or R FUEL HOT caution display on the DDI indicates the designated engine fuel feed temperature exceeds 79°C. Some loss of cooling occurs with the INTR

WING switch in INHIBIT. With high ambient temperature and low fuel flow (IDLE rpm) it may be necessary to increase fuel flow to prevent a FUEL HOT display.

2.2.7 Fuel Dump System. All fuel except engine feed tank fuel (and internal wing tank fuel in C/D aircraft) may be dumped by placing the DUMP switch, on the FUEL control panel, to ON. The DUMP switch is spring-loaded to the lever-locked OFF position and is electrically held in the ON position (with the BINGO caution display off, and the FUEL LO light off). Fuel can be dumped at any time by holding the switch ON. With the dump valve open, the ejector or turbo pumps in tanks 1 and 4 force fuel out each vertical fin dump outlet. The internal wing fuel (A/B aircraft) and external fuel (if INHIBIT and STOP are not selected) transfers fuel into tanks 1 and 4, and is then dumped. Dump rate is 600 to 1,000 pounds per minute. Dumping continues until:

- a. OFF is selected on the DUMP switch.
- b. The BINGO caution display comes on, at which time the DUMP switch automatically returns to OFF, terminating fuel dumping.
- c. Tanks 1 and 4 are empty.
- d. Either engine feed tank fuel drops below the FUEL LO level regardless of total internal fuel quantity.



Simultaneous selection of fuel dump and afterburner during high AOA maneuvering may cause fuel to ignite with resulting fuselage damage.

NOTE

In the F/A-18C/D, with either engine secured, significantly lower and/or cyclic dump rates have been experienced. On aircraft 163427 AND UP, the INTR WING switch must be set to NORM to ensure adequate fuel dumping. When the right engine is secured, lower dump rates follow immediately and may be accompanied by a CG caution. When the left engine is secured, lower dump rates are experienced as total fuel reaches 6,500 pounds (when tank 4 is empty).

2.2.7.1 Dump Open Caution Display. A DUMP OPEN caution display on the DDI indicates that the fuel dump valve is open with OFF selected.

2.2.8 Fuel Lo Level Indications. The fuel low level indicating system is completely independent of the fuel quantity indicating system. When the fuel level in either feed tank drops to 800 ± 100 pounds a FUEL LO light on the caution lights panel comes on which activates the "FUEL LOW" voice alert, a FUEL LO caution display on the DDI appears, and the MASTER CAUTION light comes on. Once activated, the FUEL LO light and caution display remains on for a minimum of 1 minute even though the activation may have been caused by a transient condition. When the fuel low warning system is

activated, external fuel (if STOP has been selected) transfers, provided the external tanks are pressurized, and the diverter valves in the hot fuel recirculation system direct fuel to the engine feed tanks. Fuel dumping, if selected, terminates.

WARNING

If the FUEL LO caution comes on, it must be assumed that at least one feed tank is below 800 pounds regardless of fuel gage readings.

2.2.9 Fuel Quantity Indicating System (F/A-18A/B). The fuel quantity indicating system provides readings, in pounds, of usable internal and total fuel. See figures 2-6 and 2-54.

The system components

include the fuel quantity indicator, a built-in test (BIT) and a BINGO caution display.

The refueling system has a volumetric shutoff controlled by pilot valves in the top of each tank. The volume of fuel with full tanks does not change. Because fuel density can vary from 6.13 pounds/gallon at 100° F to 7.38 pounds/gallon at -40° F, the total internal fuel quantity with full tanks can vary from 9,740 pounds to 11,730 pounds for the F/A-18A or from 9,120 pounds to 10,980 pounds for the F/A-18B.

2.2.9.1 Fuel Quantity Indicator. A combination pointer-counter fuel quantity indicator is on the lower left side of the main instrument panel. The pointer indicates usable internal fuel (with readings multiplied by 1000). The counter indicates usable internal and external fuel. Two other counter positions, marked LEFT and RIGHT, and a selector switch provides individual tank monitoring and a test of the indicator. An OFF indicator is displayed if electrical power is not available. With the OFF indicator out of view, an ID flag is displayed if inputs from an intermediate device to the fuel quantity indicator are in error. False fuel indications occur during and immediately following maneuvering flight.

2.2.9.2 Fuel Quantity Selector Switch.

BIT	A spring loaded position that starts BIT of the system.
FEED	Fuel remaining in the respective engine feed tank is displayed.
TRANS	Fuel remaining in tank 1 (LEFT) and tank 4 (RIGHT) is displayed.
INTER WING	Fuel remaining in the internal wing tanks is displayed.
EXT WING	Fuel remaining in the external wing tanks is displayed.
EXT CTR	Fuel remaining in the centerline tank is displayed in the LEFT counter (RIGHT indicates zero).

2.2.9.3 Fuel Quantity BIT. The BIT system only tests the fuel quantity indicator and an intermediate device that receives signals from the individual tank sensor probes. It does not test the fuel tank sensor probes or the wiring to the intermediate device. With the fuel quantity indicator OFF flag out of view, note internal and feed tank fuel quantities. The following indications are present during BIT.

With the BINGO bug set above 6,200 pounds -

- a. Internal (pointer) and total (counter) indicates 6,000 \pm 200 pounds.
- b. LEFT and RIGHT (counters) indicate 600 \pm 50 pounds.
- c. After pointer and counters reach the above values (must occur within 15 seconds), the ID flag is not in view.
- d. The FUEL LO, BINGO, CG (on aircraft 161520 AND UP) and G-LIM 7.5 G cautions are displayed on the DDI and the FUEL LO and MASTER CAUTION lights come on. The "Bingo", "Fuel Low", and "Flight Controls" voice alerts are activated. The FUEL advisory appears on the DDI if any of the above DDI cautions do not appear within 15 seconds after initiating BIT with the fuel quantity selector switch.
- e. When the fuel quantity selector switch is released the pointer and counters return to their previous value, the BINGO, CG and G-LIM 7.5 G cautions are removed, the FUEL LO caution light and accompanying MASTER CAUTION light remain on for 1 minute and then go out.

2.2.9.4 BINGO Caution. The BINGO caution appears on the DDI at a preset value controlled by the pilot. An adjustable index (bug) on the face of the indicator may be set to any internal fuel quantity by turning the BINGO knob. Fuel dumping, if selected, terminates when the BINGO caution is displayed. The "Bingo" voice alert is activated when the BINGO caution comes on. With MC OFP 19C, the "Bingo" voice alert sounds every 30 seconds until the BINGO fuel level is set below current fuel on board.

2.2.9.5 Fuel Advisory. The FUEL advisory appears on the DDI if any of the following cautions do not appear within 15 seconds after initiating BIT with the fuel quantity selector switch: FUEL LO, BINGO, or CG (aircraft 161520 AND UP).

2.2.10 Fuel Quantity Indicating System (F/A-18C/D). The fuel quantity indicating system provides readings, in pounds, of usable internal and total fuel. See figures 2-6 and 2-64. The system components include the integrated fuel/engine indicator (IFEI), a BIT and the BINGO caution.

The refueling system has a volumetric shutoff controlled by pilot valves in the top of each tank. The volume of fuel with full tanks does not change. Because fuel density can vary from 6.13 pounds/gallon at 100° F to 7.38 pounds/gallon at -40° F, the total internal fuel quantity with full tanks can vary from 9,740 pounds to 11,730 pounds for the F/A-18C or from 9,120 pounds to 10,980 pounds for the F/A-18D.

2.2.10.1 Integrated Fuel/Engine Indicator. The IFEI fuel display window contains three digital counters to provide dynamic fuel quantity indications (figure 2-6). The upper digital counter displays total aircraft fuel quantity (10-pound increments). The middle digital counter displays total internal fuel quantity (10-pound increments). A digital counter legend is displayed to the right of the upper and middle counters (T - total fuel, I - internal fuel). The lower digital counter displays the selected BINGO fuel quantity (100-pound increments). The UP and DOWN arrows on the IFEI provide BINGO level adjustments from 0 to 20,000 pounds in 100 pound increments (BINGO counter scrolls if arrow keys are depressed for more than one second). Individual fuel tank monitoring is provided by the QTY pushbutton. False fuel indications occur during and immediately following maneuvering flight. In LOT 12 and up, the IFEI is NVG compatible.

2.2.10.2 Fuel Quantity Selector Pushbutton. The QTY pushbutton allows sequential selection of the five sub-level fuel quantity format displays. The digital counter legends are displayed to the right of the upper and middle digital counters to identify the format displayed.

Sub-level	Fuel Quantity Indicated	Legend	Counter
1	Left Feed Tank (#2) Right Feed Tank (#3)	FL FR	Upper Middle
2	Left Transfer Tank (#1) Right Transfer Tank (#4)	TL TR	Upper Middle
3	Left Wing Tank Right Wing Tank	WL WR	Upper Middle
4	Left External Tank Right External Tank	XL XR	Upper Middle
5	Centerline Tank	C	Upper

NOTE

When in sub-level 1 thru 5 the BINGO counter is replaced by the total fuel counter. BINGO level is not adjustable in sub-levels 1 thru 5.

2.2.10.3 Fuel Low BIT. The built-in test FLBIT system tests the entire FUEL LO warning system. FLBIT is initiated from the FUEL display (FLBIT pushbutton) on the DDI. A satisfactory test results in a FUEL LO caution, voice alert, and MASTER CAUTION indication being generated within 13 seconds of FLBIT initiation. NO TEST is displayed next to tank 2 or 3 if its respective fuel quantity is low prior to FLBIT initiation or next to tank 3 if tank 2 fails FLBIT. The FLBIT option is boxed during the FLBIT sequence. The FUEL LOW BIT is inoperative when the FUEL LO caution is displayed or if there is a failure in the Signal Data Computer (SDC).

2.2.10.4 Bingo Caution Display. A BINGO caution display appears on the DDI when the internal fuel quantity reaches the preset value controlled by the pilot. In the C/D aircraft the pilot enters his selected Bingo value with the pushbuttons on the IFEI. Fuel dumping, if selected, terminates when the BINGO caution is displayed. The BINGO voice alert is activated when the BINGO caution comes on. With MC OFP 19C, the "Bingo" voice alert sounds every 30 seconds until the BINGO fuel level is set below current fuel on board.

2.2.10.5 DDI Fuel Display. The FUEL display (figure 2-5), which is menu selectable, is available inflight and on the ground. Displayed is the fuel available in each tank, total internal fuel, total internal and external fuel, and currently selected BINGO fuel. A moving caret is shown on the right side of each tank to indicate the ratio of fuel available to tank fuel capacity. The SDC checks each fuel probe validity and uses this data to determine system degraded performance. The loss of valid fuel quantity information for a given tank is indicated by display of 0 pounds fuel and INV (invalid). Loss of valid information is as follows:

- a. All probes in a tank declared invalid by the SDC (except left or right feed tanks).
- b. Tank 1 aft probe invalid while forward probe reads zero fuel.
- c. Tank 4 forward and center probes invalid while aft probe reads zero.

An estimated (EST) fuel quantity is determined by the SDC and displayed as follows:

- a. Use only the valid fuel probes in a multi-probe tank to estimate fuel available.

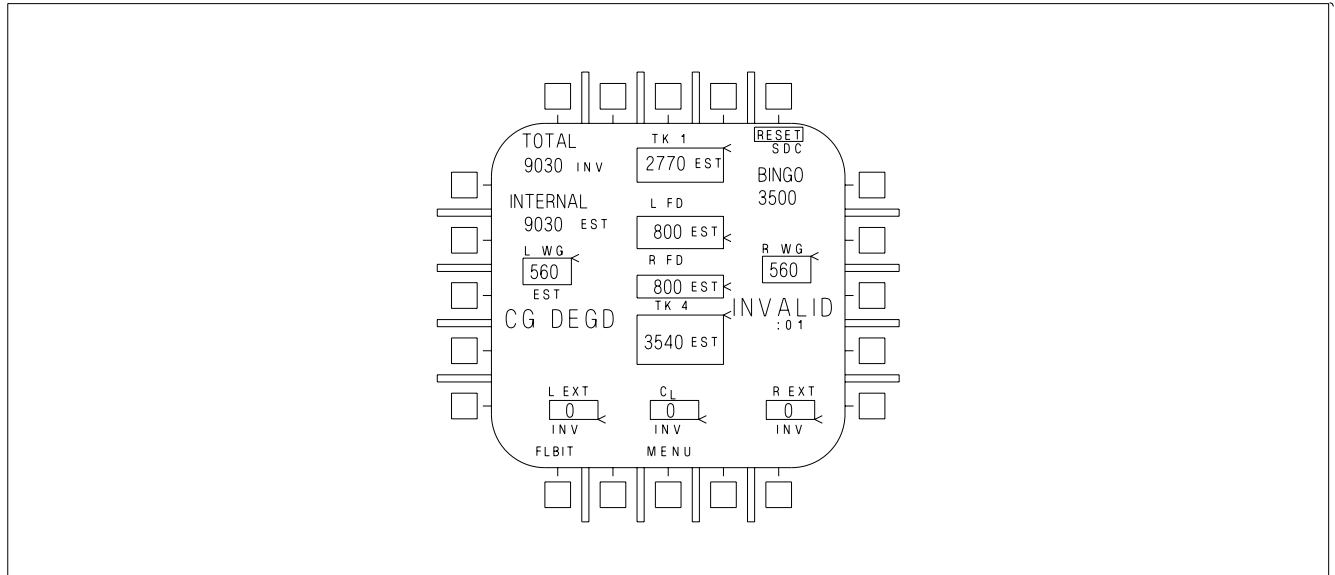

ADA520-140-1-045

Figure 2-5. Fuel Display

- b. Fuel probe invalid in left or right feed tank:
- (1) Display 0 pounds if FUEL LO is present.
 - (2) Display 800 pounds if FUEL LO is not present.

The internal fuel and total fuel displays the sum of valid and/or estimated tank quantities. Each is cued as EST or INV as determined by the appropriate tank information with INV displayed if INV and EST both apply.

2.2.10.6 Fuel Quantity Advisory Display. A F-QTY advisory displayed on the DDI indicates SDC or gaging system failure which affects the display of fuel quantity or center-of-gravity information. The advisory is activated if:

- a. The MC loses communication with the SDC.
- b. The SDC reports an internal or gaging system failure.
- c. Any tank quantity is invalid.
- d. The SDC reports output discretes severed.

An F-QTY advisory, resulting from the MC loss of communication with the SDC or the SDC reporting internal or gaging system failure, results in the following fuel display conditions:

- a. All fuel quantities held at the last displayed value (valid EST or INV).
- b. A flashing INVALID cue displayed along with a minutes and seconds (XX:XX) timer which indicates the duration since the displayed fuel quantities were last updated.

2.2.11 Air Refueling System. A hydraulically operated inflight refueling probe is on the right side of the fuselage forward of the windshield. The probe is extended and retracted by the HYD 2A system and controlled by a guarded PROBE switch on the FUEL panel. An emergency extension system uses

APU accumulator pressure to extend the probe.

RETRACT	Retracts the air refueling probe and reestablishes fuel tank pressurization.
EXTEND	Extends the air refueling probe, turns on the probe light, if the exterior lights master switch is on, and depressurizes the fuel tanks. The external tanks will not transfer unless either external tank fuel control switch is in ORIDE.
EMERG EXTD	Opens the emergency air refueling probe selector valve and the APU arming valve and extends the probe with APU accumulator pressure. Retains all other functions as the EXTEND position.

2.2.11.1 Probe Unlock Caution Display. A PROBE UNLK caution display on the DDI indicates that the probe is not fully retracted with the PROBE switch in RETRACT.

2.2.11.2 Internal Wing Tank Fuel Control Switch.

NORM	Permits refueling and transfer of the internal wing tanks.
INHIBIT	Prevents refueling of the internal wing tanks, prevents fuel transfer from the internal wing tanks except by gravity, and diverts recirculated fuel to the engine feed tanks.

2.2.11.3 External Tank Fuel Control Switches.

NORM	Permits selected external tank(s) to be refueled.
STOP	Prevents refueling of selected external tank(s).
ORIDE	Provides pressurization of and fuel transfer from all installed external tanks during refueling (HOOK handle must be up in F/A-18A/B aircraft). The other external tank fuel control switch must be in STOP if fuel transfer from its tank(s) is not desired.

2.2.12 Ground Refueling System. All fuel tanks are pressure fueled through a single point receptacle. Refer to A1-F18AC-NFM-600 for ground fueling procedures.

TANK	USABLE FUEL			
	GALLONS		POUNDS	
		JP-5	JP-4	
Number 1	418	2,840	2,720	
Number 2 Left Engine Feed	263	1,790	1,710	
Number 3 Right Engine Feed	206	1,400	1,340	
Number 4	532	3,620	3,460	
Total Fuselage	1,419	9,650	9,230	
Left and Right Internal Wings	85	85	580	580
	170		1,160	1,100
Total Internal	1,589	10,810	10,330	

EXTERNAL TANK(S)

Elliptical Wing or Centerline Tank	314	2,140	2,040
Cylindrical Wing or Centerline Tank	330	2,240	2,150

NOTES

- The fuel quantities, in pounds, are rounded off to the nearest 10 pounds. Therefore, the actual gallons times 6.8 or 6.5 will not necessarily agree with the pounds column.
- Fuel weights are based on JP-5 or JP-4 at 6.8 or 6.5 pounds per gallon and a temperature of 15°C (59°F).

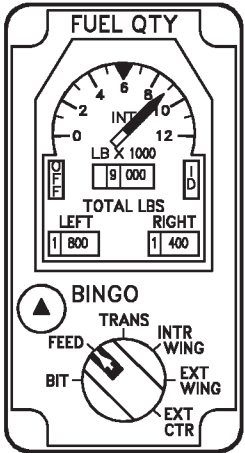

F/A-18A

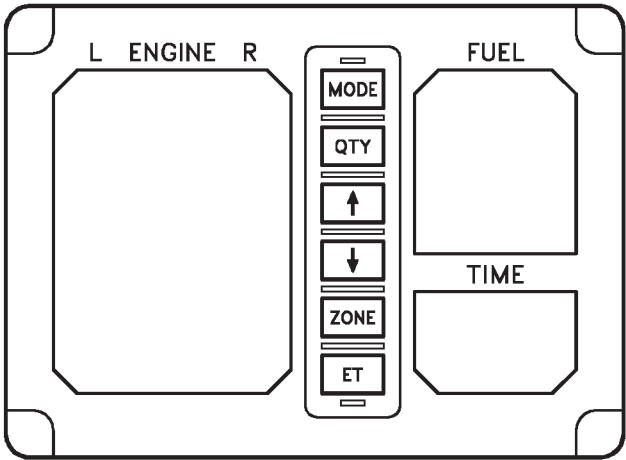

F/A-18C

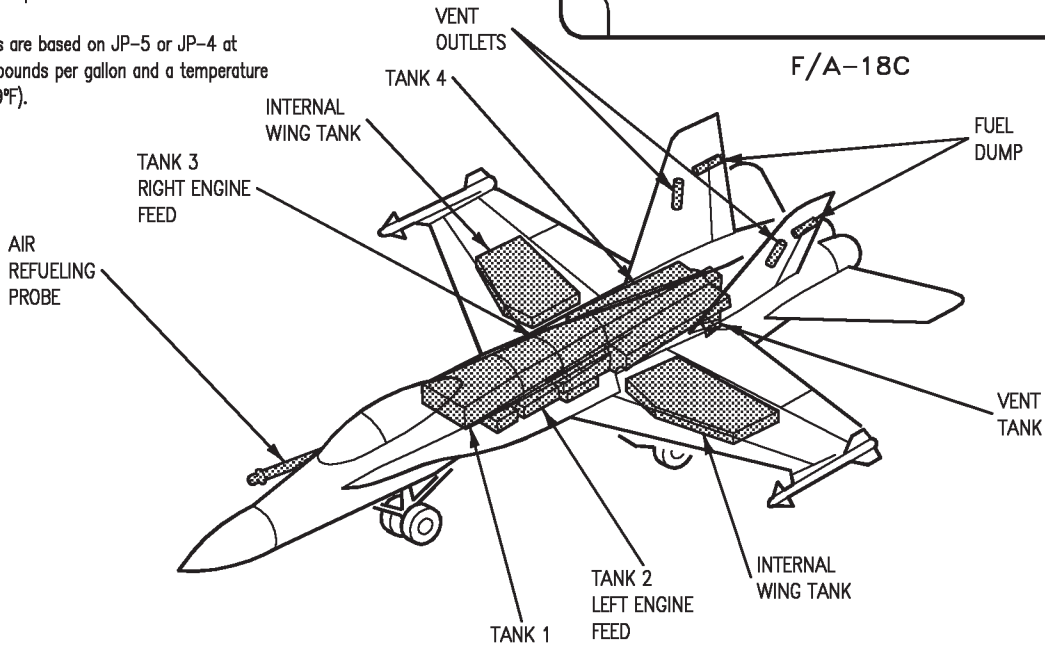

Figure 2-6. Fuel Quantity (F/A-18A/C)

2.3 FLIGHT PERFORMANCE ADVISORY SYSTEM

2.3.1 Flight Performance Advisory System (FPAS) (F/A-18A Aircraft AFTER AFC 253 OR 292, and F/A-18C/D Aircraft.) The FPAS advises the pilot of the altitude and airspeed corresponding to maximum inflight fuel efficiency based on current operating conditions. The range and airspeed calculated by the FPAS algorithm appears on the FPAS display (figure 2-7). The FPAS display appears when the FPAS option is selected on the SUPT MENU. The FPAS display is divided into five areas: the current range and endurance area, the optimum range and endurance area, the Waypoint/TACAN steering area, the fuel flow area, and the default area. With engines running and weight on wheels (W on W), only the optimum and default areas are valid. All areas are valid with weight off wheels (W off W). The Waypoint/TACAN steering area is valid with W off W when Waypoint or TACAN steering is selected on the HSI display.

2.3.1.1 FPAS Display

2.3.1.1.1 Default Area. Temperature, stores drag, and fuel flow parameters, if invalid, do not have a fatal impact on FPAS calculations. If one or more of these parameters become invalid, the invalid parameter(s) are displayed in the default area (figure 2-7).

2.3.1.1.2 Current Range Area. The current range area on the FPAS display (figure 2-7) informs the pilot of range to 2,000 lb fuel remaining at current altitude and Mach, the best Mach to fly at the current altitude to maximize range, and range to 2,000 lb fuel flown at that Mach number. If total onboard fuel goes below 2,500 lb the FPAS calculations are done to 0 lb and the TO 2000 LB legend changes to TO 0 LB. If TAS exceeds Mach 0.9 the range at current Mach and altitude is invalid and the word Mach is displayed under RANGE. If the parameters associated with the current range area become invalid the current range area displays XXXX and an FPAS advisory is displayed below the ENDURANCE legend in place of the endurance value. When any of the preconditions is not valid, the range and endurance values display XXXX and an FPAS advisory is displayed. Fuel remaining is monitored and a DDI caution is displayed when calculated fuel remaining on arrival is less than 2,000 pounds.

2.3.1.1.3 Current Endurance Area. The current endurance area of the FPAS display (figure 2-7) informs the pilot of endurance to 2,000 lb (0 lb) fuel remaining at current altitude and Mach number, the best Mach to fly at current altitude to maximize endurance, and endurance to 2,000 lb (0 lb if fuel remaining is less than 2,500 lb) fuel at that Mach number. When TAS exceeds Mach 0.9, the endurance at current altitude and Mach number becomes invalid and LIM is displayed under ENDURANCE. If parameters associated with the current endurance area become invalid the current endurance area is Xd out.

2.3.1.1.4 Optimum Range Area. The optimum range area on the FPAS display (figure 2-7) shows the altitude and Mach number at which to fly to achieve maximum range (also displayed) to 2,000 lb (0 lb if fuel remaining is less than 2,500 lb) of fuel. If parameters associated with optimum endurance area become invalid the numerical display area is Xd out.

2.3.1.1.5 Optimum Endurance Area. The optimum endurance area on the FPAS display (figure 2-7) shows the altitude and Mach number at which to fly to achieve maximum endurance (also displayed) to 2,000 lb (0 lb if fuel remaining is less than 2,500 lb) of fuel. If parameters associated with optimum endurance area become invalid the numerical display area is Xd out.

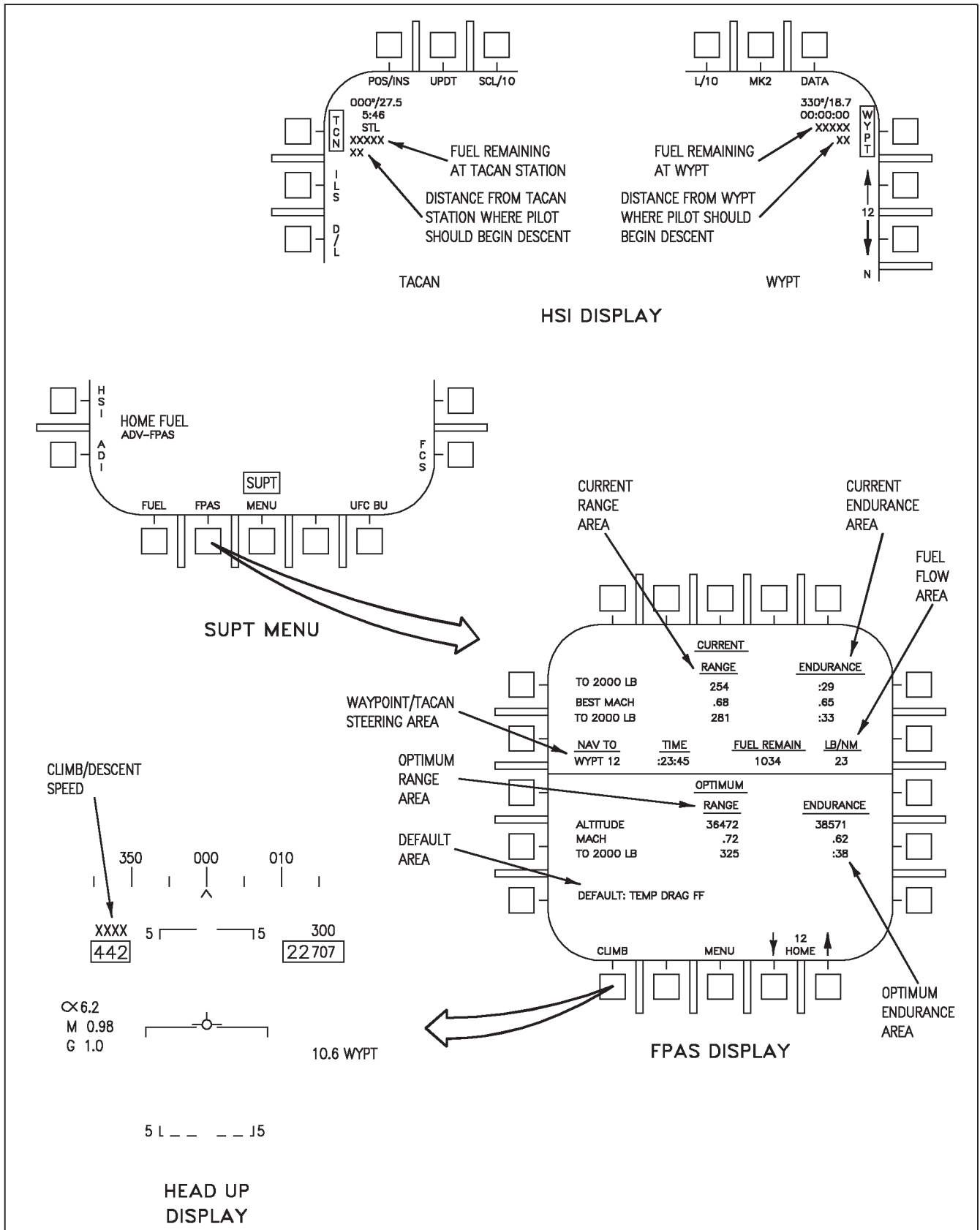

18AC-NFM-00-(318-1)31-CATI

Figure 2-7. FPAS Display

2.3.1.1.6 Waypoint/TACAN Steering Area. If waypoint or TACAN steering is selected on the HSI display (figure 2-7), the waypoint or TACAN station selected, the arrival time at current conditions, and the fuel remaining at arrival is displayed on the FPAS display. The fuel remaining at arrival and the number of miles (if greater than 99 miles, 99 miles is displayed) from the waypoint or TACAN station to begin descent is displayed on the HSI display. If time to waypoint, fuel remaining, or TACAN station is invalid, Xs are displayed. If fuel remaining is calculated to be less than 0 lb, 0 is displayed. If TAS exceeds Mach 0.9 the fuel remaining is blanked.

2.3.1.1.7 Fuel Flow Area. The total fuel flow rate (both engines combined) in pounds per nautical mile is displayed (figure 2-7) whenever the engines are running.

2.3.1.1.8 Climb Pushbutton. Pressing the climb pushbutton on the FPAS display enables the climb air speed prompt on the HUD if the HUD reject switch is in the normal position. When selected, the CLIMB legend is boxed. If not in the NAV master mode, the climb pushbutton is removed from the FPAS display.

2.3.1.2 HOME FUEL Caution. When the calculated fuel remaining at the home waypoint reaches 2,000 lbs, the master caution aural tone is triggered, the master caution light is turned on, and the caution message HOME FUEL is displayed on the DDI. The home waypoint is set to 0 at power up. The pilot can increment/decrement the home waypoint, providing FPAS has the ability to calculate the HOME FUEL caution, by using the up/down arrows on the FPAS display. The range for the home waypoint is 0 to 24 (MC OFP 10A AND UP) or 0 to 59 (MC OFP 13C AND UP). The mechanization is circular, in that if waypoint 59 is selected and the up arrow is pressed the home waypoint returns to 0. The home waypoint must be steady for 5 seconds before the HOME FUEL caution logic can begin. If FPAS cannot calculate the HOME FUEL caution, the home waypoint is X'd out and the up and down arrows are removed from the display. The HOME FUEL caution is not activated if weight is on wheels, the refueling probe is extended, or for 5 seconds after the pilot selects a new home waypoint. With MC OFP 13C AND UP, the HOME FUEL caution resets if: the refueling probe is extended, the aircraft transitions from weight off wheels to weight on wheels, the landing gear is cycled from up to down to up, or the HOME WAYPOINT is changed.

2.3.1.3 FPAS Advisory. The FPAS advisory is displayed on the DDI if the FPAS system loses the capability to calculate the HOME FUEL caution.

2.3.1.4 HSI with Waypoint or TACAN Steering Selected. If waypoint or TACAN steering is selected on the HSI display, the fuel remaining at arrival and the miles from the waypoint or TACAN station to begin descent are displayed on the HSI display. When FPAS cannot calculate fuel remaining and the point to begin descent, invalid Xs are displayed for these parameters. If TAS exceeds Mach 0.9, blanks are displayed. If fuel remaining at the waypoint or TACAN station is less than the TO XXXX LB legend, the WYPT number, the TO XXXX LB legend on the FPAS display and the fuel remaining on both the FPAS and HSI displays is flashed.

2.4 SECONDARY POWER SYSTEM

Figure 2-8 shows the major components of the secondary power system.

2.4.1 Airframe Mounted Accessory Drive (AMAD). There are two AMAD gearboxes, one for each engine. Each AMAD is mechanically driven by its corresponding engine through a power transmission shaft. Either AMAD (but not both at the same time) may also be driven pneumatically through an air turbine starter (ATS) by the auxiliary power unit (APU), opposite engine bleed air (crossbleed), or an

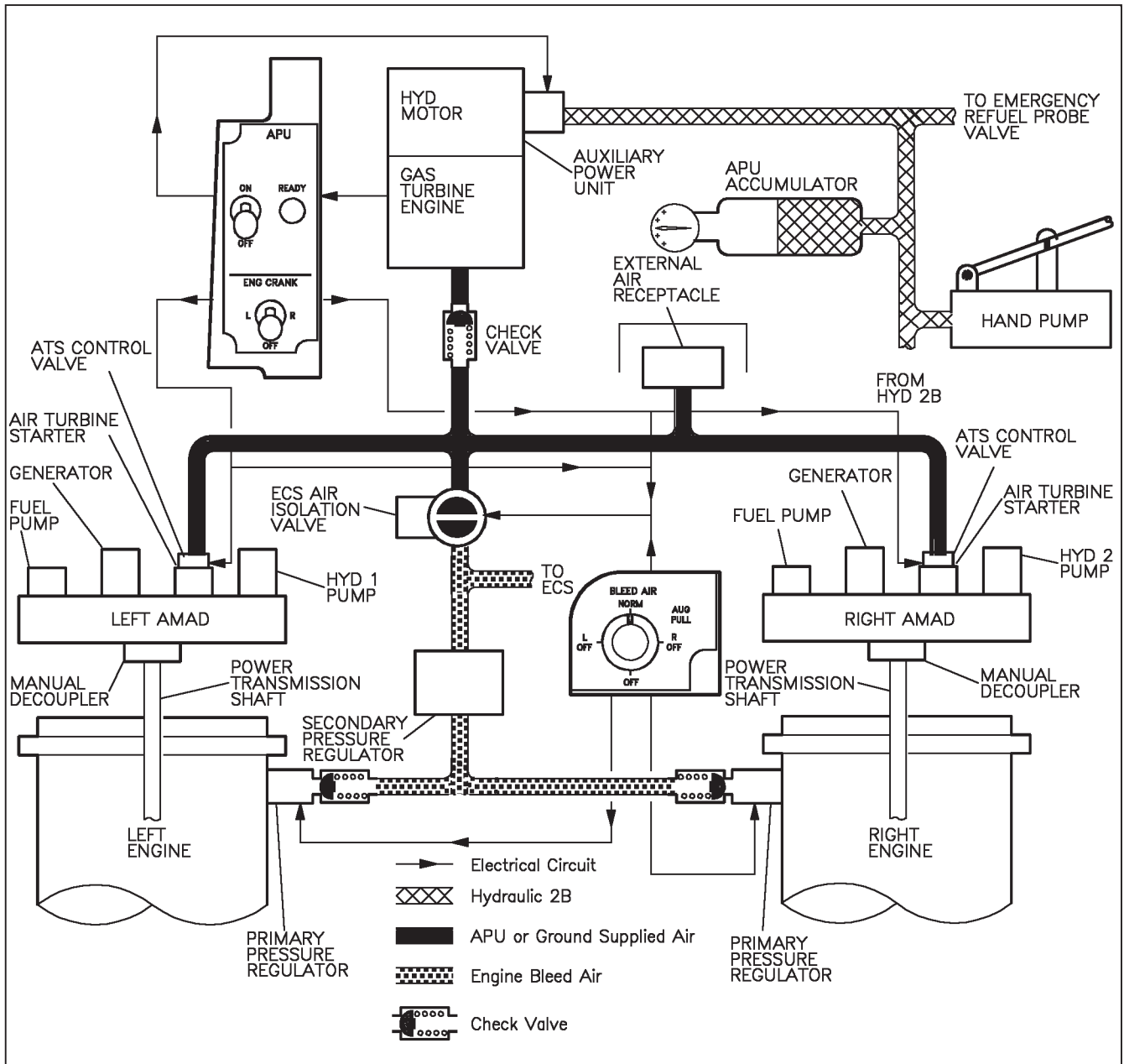

18AC-NFM-00-(11-1)31-CATI

Figure 2-8. Secondary Power Supply

external air supply. Each AMAD mechanically drives a fuel pump, an AC generator, and a hydraulic pump.

For first engine start, the APU or external air supply drives the ATS which in turn drives the AMAD and cranks the engine. For the second engine start, the APU, external air, or crossbled from the first engine may be used to drive the opposite ATS and crank the second engine.

For accessory drive only (maintenance use), either engine may be decoupled from the AMAD, and the APU may be used to drive the decoupled AMAD and its attached accessories. On aircraft through 161519, use of external air is not authorized to drive the decoupled AMAD.

During normal engine operation, each AMAD and its accessories are driven by the corresponding engine via the power transmission shaft.

NOTE

Failure of the power transmission shaft (PTS) will result in the display of the associated GEN, BOOST LO, and both HYD circuit cautions.

If one engine fails and the engine core is rotating freely, crossbleed or the APU may be used to keep the failed engine AMAD operating.

2.4.1.1 L and R AMAD Caution Display. The L or R AMAD caution display on the DDI indicates that the corresponding AMAD oil temperature is too high.

2.4.1.2 L and R AMAD PR Caution Display. On aircraft 161925 AND UP, the L or R AMAD PR caution on the DDI indicates that the corresponding AMAD oil pressure is low.

2.4.2 Auxiliary Power Unit (APU). The APU is a small aircraft mounted gas turbine engine used to generate a source of air to power the air turbine starter(s) or to augment the engine bleed air supply to the ECS. It is situated on the underside of the fuselage between the engines, with both intake and exhaust facing downwards. A hydraulic motor powered by the APU accumulator, normally charged by HYD 2B, is used to start the APU. A hand pump may be used to charge the accumulator. The aircraft battery provides electrical power for the APU ignition and start control circuits. The APU uses aircraft fuel.

Operation of the APU is automatic after the APU switch, on the left console, is placed to ON. The APU may be shut down at any time by placing the APU switch to OFF. After the APU has completed its start cycle a green READY light comes on. After the second generator is on line, the APU runs approximately 1 minute then the APU switch returns to OFF.

Limited inflight testing has been performed and indicates that with at least one generator off line, the APU will start inflight below 10,000 feet and 250 KCAS. The inflight exhaust of the APU may cause blistering and peeling of the aft fuselage paint. To ensure sufficient accumulator pressure, HYD ISOL ORIDE should be selected for 10 seconds prior to attempting inflight start.

2.4.2.1 APU Switch. The APU switch is a two-position switch with positions of ON and OFF.

OFF	Provides a manual shutdown for the APU.
ON	Starts the start cycle of the APU. Switch is electrically held in the ON position and automatically returns to OFF 1 minute after the second generator comes on the line provided the bleed air knob is not in AUG PULL.

2.4.2.2 APU ACCUM Caution Display. An APU ACCUM caution display on the DDI and caution light panel indicates the APU accumulator pressure is low. With this display, APU start, emergency gear extension, emergency extension of the air refueling probe and emergency nosewheel steering may not be available.

2.4.2.3 Start Cycle.



- On Aircraft 161353 THRU 163175 BEFORE IAYC 853, to minimize the potential of APU surge, ensure generator switches are ON, bleed air aug is OFF, and do not shut down the APU while cranking an engine when opposite engine is running.
- In all cases of engine start, generator switch should be on as it provides overspeed cutout protection for the ATS.

2.4.2.3.1 Both Engines From APU. Either engine may be started first; however, starting the right engine first provides normal hydraulic pressure to the brakes. After the APU READY light is on, place the electrically held engine crank switch to R. This opens the right air turbine starter control valve (ATSCV) and APU air powers the ATS. The ATS in turn cranks the right engine by way of the AMAD gearbox and power transmission shaft. After the right generator comes on the line the engine crank switch automatically returns to OFF. The left engine is started the same way as the right. One minute after the second generator comes on the line the APU shuts down.

2.4.2.3.2 Cross Bleed From First Engine. The first engine should be at a minimum 80 % rpm and 1,900 pph fuel flow. With the APU off, the engine crank switch controls the ATSCV and the ECS air isolation valve. Placing the engine crank switch to the second engine permits compressor bleed air from the operating engine to pass through the open ECS air isolation valve and the other ATSCV to crank the second engine. After the second generator comes on the line the engine crank switch returns to off and the ECS air isolation valve closes.

2.4.2.3.3 Air Turbine Starter Caution Display. An L or R ATS caution may be displayed on the DDI. The L or R ATS caution indicates the starter is turning at too high an rpm.

2.4.3 External Power Start. If the APU is not used, an external air source may be used to start the engine(s). After the bleed air knob is placed to OFF, and external air is applied in the right wheelwell, the start procedure is the same as when using the APU.

2.4.4 Bleed Air Augmentation. On the ground, the APU may be used to augment engine bleed air for ECS operation. The bleed air knob must be in any position except OFF (NORM preferred). With both generators on the line and the APU running, selecting AUG PULL overrides the APU automatic shutdown and directs APU air to the ECS to augment engine bleed air. With both generators on the line and the APU shut down, the AUG PULL position must be selected before the APU can be restarted. If the AUG PULL position is selected with only one engine operating, augmentation air is terminated during the second engine start but is regained after both engines are running. Moving both throttles to MIL or above terminates augmentation air, causes the bleed air knob to move out of the

AUG PULL position and after 1 minute shuts down the APU. Pushing the bleed air knob down also terminates augmentation air and after 1 minute shuts down the APU.



On aircraft 161353 THRU 163175 BEFORE IAYC 853, to minimize potential of APU damage due to surging, use bleed air aug only when absolutely necessary to maintain cooling.

Before securing bleed air aug (by pushing center of bleed air aug switch) with engine(s) running, slowly advance one engine to 80 % N_2 rpm. To secure the bleed air aug with no engines running, push the center of the bleed air aug switch then wait 10 seconds before securing the APU.

2.5 ELECTRICAL POWER SUPPLY SYSTEM

The electrical power supply system consists of two AC generators, two transformer-rectifiers, two batteries with integral battery chargers on aircraft 161353 THRU 161528, BEFORE AFC 049, or a single battery charger transformer-rectifier unit (TRU) which charges both batteries on aircraft 161702 AND UP, and aircraft 161353 THRU 161528 AFTER AFC 049, and a power distribution (bus) system. External electrical power can be applied to the bus system on the ground. In the absence of external electrical power, battery power is provided for engine starts, whether using the onboard APU or external air. See Electrical System, figure 2-9 and Foldout Section, for electrical system simplified schematics.

2.5.1 AC Electrical Power. Two ac generators are the primary source of electrical power. The two generators are connected for split bus nonsynchronized operation. This means that with both generators operating each generator supplies power to an independent, isolated aircraft bus. If one generator fails, it drops off the line and power from the remaining generator is automatically provided to the bus of the failed (or turned off) generator. Either generator is capable of supplying power to the entire system. Each generator is activated automatically when its control switch is in the NORM position; and the generator is connected to its buses when voltage and frequency are within prescribed limits (approximately 60 % engine rpm). A protection system within the generator converter unit (GCU) protects against damage due to undervoltage, overvoltage, over and under frequency, and feeder faults. If a fault or malfunction occurs, the generator converter unit removes the affected generator from its buses. Except for under speed, the control switch of the affected generator must be cycled to bring the generator back on the line after the fault or out-of-tolerance condition occurs. For an under speed condition, the generator comes back on the line automatically when in-tolerance speed is restored. A generator may be removed from its buses at any time by placing the generator control switch to OFF. On aircraft 162394 AND UP, and 161353 THRU 161987 AFTER AFC 048, in the event that both generators become inoperative due to a bus or equipment fault the bus tie contactors and the ac bus isolation and generator auto reset logic circuit interact isolating the ac buses. Approximately 1 second after the dual outage the logic circuit attempts to reset both generators. If the cause(s) of the dual outage has cleared, both generators come back on line powering their respective buses. If the cause of the outage has not cleared when automatic generator reset is attempted, the generator that normally powers the faulted bus/failed equipment is not restored, and that bus remains unpowered. The other generator comes on line and powers its associated bus and equipment. The ac bus isolation and generator auto reset circuit is prevented from operating whenever the parking brake is set. Beside the parking brake not being set, the generator tie control switch must be in NORM and the battery switch must be ON for the circuit to operate.

2.5.1.1 Generator, GEN TIE Caution Lights, and Displays. Three caution lights, labeled L GEN, R GEN and GEN TIE are on the caution lights panel. The L GEN and R GEN caution lights and the L GEN and R GEN caution displays come on whenever their respective generator drops off the line. On aircraft 162394 AND UP, the GEN TIE caution light advises the pilot that the bus tie contactors are deenergized and the ac buses are isolated. The generator tie control switch, located outboard of the throttles on the left console, allows the pilot to override the ac bus isolation and generator auto reset circuitry and reenables the automatic bus tie ac circuit. These lights operate in conjunction with the MASTER CAUTION. In event of dual generator failure, the MASTER CAUTION light comes on (tone inoperative); however, the generator caution lights and displays and the generator tie caution light do not come on.

2.5.1.2 Generator Control Switches. Two generator control switches, one for each generator, are on the electrical power panel. They are two-position toggle switches with positions OFF and NORM.



Cycling of generators airborne in an attempt to regain failed/degraded systems may result in loss of additional systems.

2.5.1.3 Generator TIE Control Switch. On aircraft 162394 AND UP, and 161353 THRU 161987 AFTER AFC 048, the generator tie control switch, outboard of the exterior lights panel on the left console, has positions NORM and RESET. The guarded switch must be in NORM (battery switch in ON) for the bus tie circuit and the ac bus isolation and generator auto reset circuit to operate. The RESET position is used to reset the bus tie circuit after a fault causing the bus tie to open is cleared. Reset is performed by placing the switch to RESET and back to NORM. A ground engine start without the parking brake set results in illumination of the GEN TIE caution and requires cycling of the generator tie control switch to reset the bus isolation circuitry.

2.5.2 DC Electrical Power (Aircraft 161353 THRU 161528 BEFORE AFC 049). Two transformer-rectifiers and two batteries with integral battery chargers are provided. The output of both transformer-rectifiers are connected in parallel, however, protection is provided so that a short on a bus of one transformer-rectifier does not affect the other transformer-rectifier. If one transformer-rectifier fails, the other transformer-rectifier powers the entire DC system. No cockpit warning of single transformer-rectifier failure is provided. The batteries, designated utility or U battery, and emergency or E battery, are used for engine start when external power or aircraft generator power is not available, and are used to power the essential 24/28 volt dc bus when both transformer-rectifiers are lost. The U battery also powers the maintenance 24/28 volt dc bus when both transformer-rectifiers are inoperative. This allows operation of the canopy and maintenance monitor on the ground without any other electrical power on the aircraft. The batteries are controlled by a single battery switch. The system supplies battery power to the essential bus when both transformer-rectifiers are lost and the battery switch is positioned to ON or ORIDE. With the battery switch ON, the essential bus is automatically sequenced between the two batteries. The essential bus and start bus are initially powered by the utility battery, and as the utility battery becomes depleted the essential bus (but not the start bus) transfers to the emergency battery. An ORIDE position is provided on the battery switch to allow selection of the emergency battery in the event the automatic sequencing system fails. In addition, the switch is provided with an OFF position to prevent depletion of the batteries while the aircraft is parked. The batteries charge regardless of the position of the battery switch, providing power is being

supplied to the battery chargers by the transformer-rectifiers. In addition, the E battery 24 volt dc bus which is connected directly to the emergency battery, and the U battery 24 volt dc bus which is connected directly to the utility battery, are powered as long as their respective battery retains a charge.



To prevent damage to the battery bus contactors and/or batteries, do not leave the BATT switch in ON or ORIDE for extended periods without generators on-line or external power on the aircraft. After engine shut-down, ensure BATT switch is OFF and the BATT SW caution light is not ON.

2.5.2.1 Battery Switch

- OFF Batteries can be charged, but battery contactors will not energize to connect a battery to the essential bus in response to low voltage conditions.
- ON Enables control circuitry of both battery contactors so the U battery contactor will automatically close in response to a low voltage condition on the left 28 volt dc bus, and the E battery contactor will subsequently close in response to a low voltage condition from the U battery output and left 28 volt dc bus.
- ORIDE Energizes E battery contactor regardless of charge status of U battery, providing voltage on left 28 volt dc bus is absent or low. Position can be used to connect E battery to the essential buses in the event U battery contactor fails to energize with switch in the ON position.

2.5.2.2 Battery Caution Lights and Displays. Three caution lights, the U BATT, E BATT and BATT SW are associated with operation of the batteries. All three cautions are displayed on both the DDI and caution lights panel. The MASTER CAUTION comes on in conjunction with these lights. The U BATT and E BATT lights come on to indicate a low state of charge of their respective batteries, and operate only with the battery switch in the ON or ORIDE position. The BATT SW light alerts the pilot to check the position of the battery switch. The light coming on, on the ground, without ac electrical power on the aircraft indicates (unless APU start about to be made) that batteries are being depleted and switch should be placed to OFF. The BATT SW light coming on in the air normally indicates that the battery switch is in the OFF or ORIDE position and should be placed to the ON position. The BATT SW light coming on in the air with the battery switch ON indicates that the essential bus is energized by battery power (double generator or double transformer-rectifier failure) and that battery energy should be conserved.

AIRCRAFT 161702 AND UP, 161353 THRU 161987 AFTER AFC 048 AND AFC 049

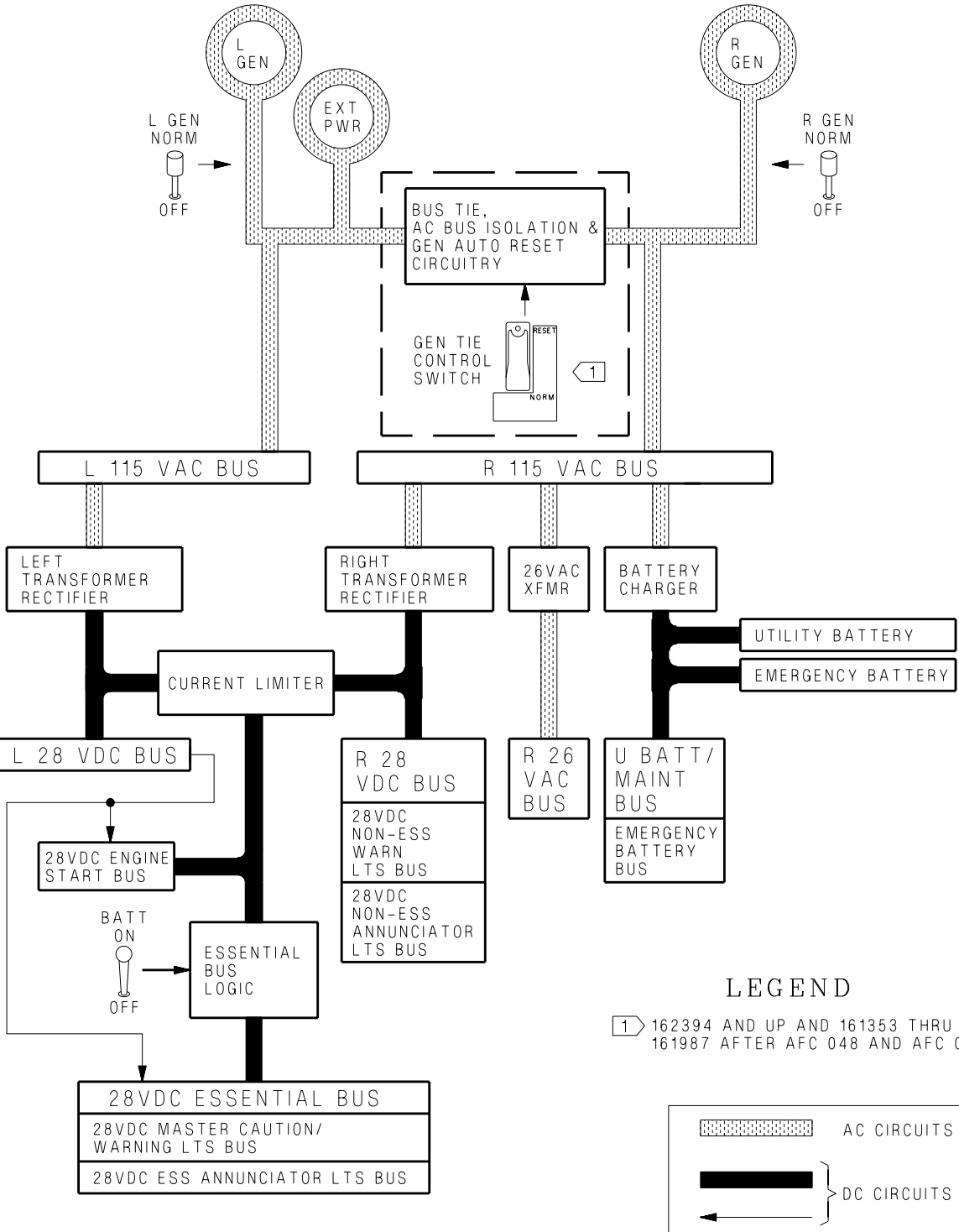

LEGEND

1 162394 AND UP AND 161353 THRU 161987 AFTER AFC 048 AND AFC 049.

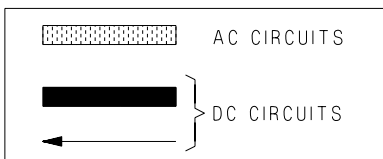
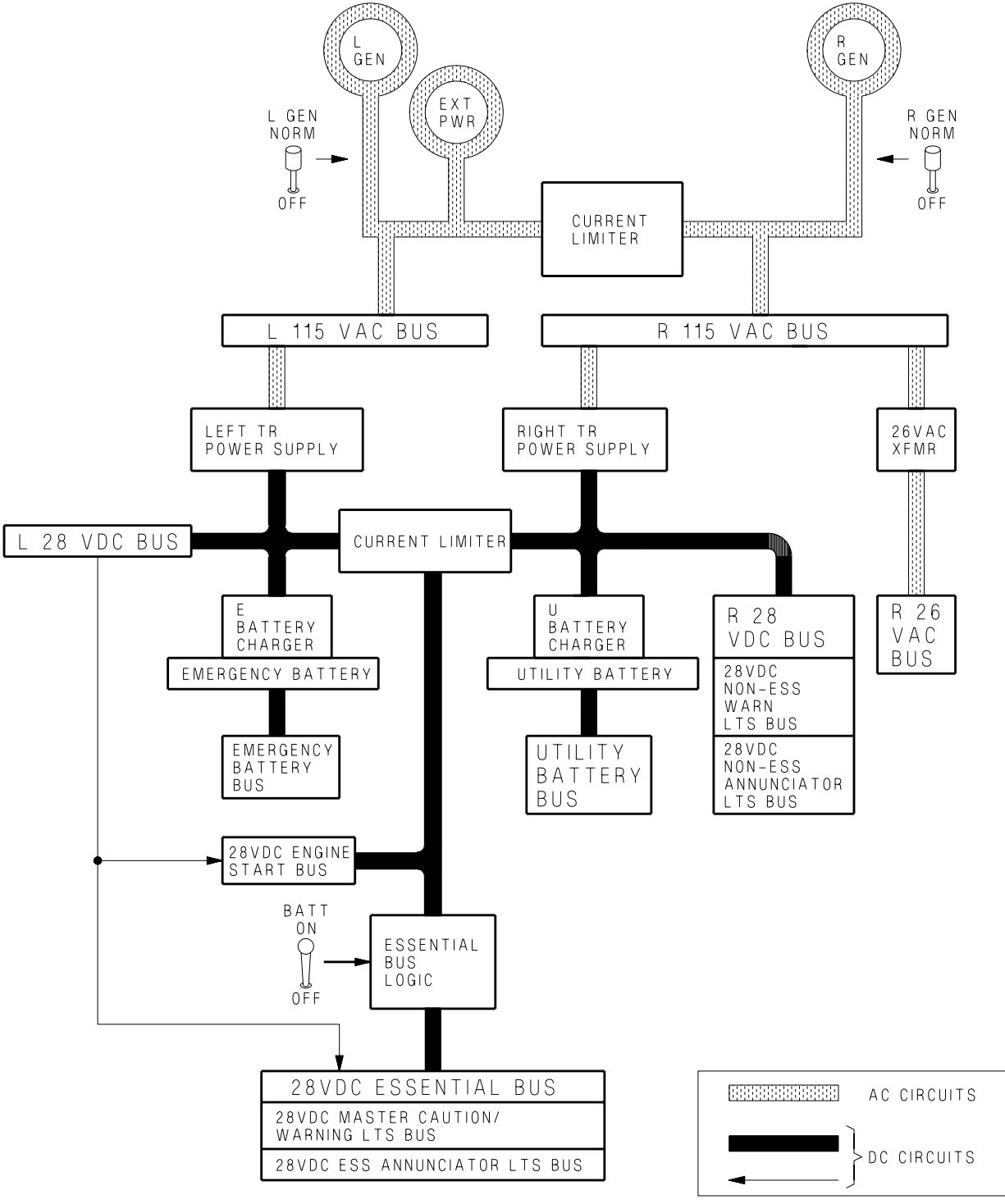

Figure 2-9. Electrical System (Sheet 1 of 2)

ADA520-350-2-043

AIRCRAFT 161353 THRU 161528
BEFORE AFC 048 AND AFC 049



ADA520-350-1-043

Figure 2-9. Electrical System (Sheet 2 of 2)

2.5.3 DC Electrical Power (AIRCRAFT 161702 AND UP AND AIRCRAFT 161353 THRU 161528 AFTER AFC 049). Two transformer-rectifiers and two 7.5 ampere-hour sealed lead acid batteries with a single battery charger are provided. The transformer-rectifiers are connected in parallel and protection is provided so that a short on a bus of one transformer-rectifier does not affect the other transformer-rectifier. If one transformer-rectifier fails, the other transformer-rectifier powers the entire DC system. No cockpit warning of single transformer-rectifier failure is provided. The batteries, designated utility or U battery, and emergency or E battery, are used for engine starts when external power or aircraft generator power is not available, and are used to power the essential 24/28 volt dc bus when both transformer-rectifiers are lost. The utility battery powers the U BATT/maintenance bus directly which allows operation of the canopy and maintenance monitor on the ground without any other electrical power on the aircraft. In addition, the emergency battery powers the E BATT bus directly. The E/U BATT voltmeter is used to monitor voltage on the U and E batteries. The single battery charger supplies charging power directly to the utility battery and, through the E battery charging contactor, to the E battery. The charger receives power from the right 115 volt ac bus and provides charging power to the U battery whenever ac power is on the aircraft. For the E battery to receive charge, the left 28 volt dc bus must be powered to energize the E battery charging contactor. The batteries are controlled by a single battery switch on the electrical power panel. The system supplies battery power to the essential bus when both transformer-rectifiers are lost and the battery switch is in ON or ORIDE. With the switch ON, the normal flight position, and the left 28 volt dc bus de-energized, the U battery automatically powers the essential and engine start 24/28 volt dc buses. When the U battery depletes to 20.5 volts or below for over 0.5 second, the E battery automatically powers the essential 24/28 volt dc bus (but not the 24/28 volt engine start bus). Placing the battery switch to ORIDE connects the E battery to the essential 24/28 volt dc bus regardless of the status of the left 28 volt dc bus or the U battery. The ORIDE position is provided to allow selection of the E battery if the automatic switching circuits associated with the ON position fail. The OFF position is provided to prevent depletion of the batteries when the aircraft is parked. The batteries charge regardless of the position of the battery switch, provided ac power is on the aircraft.



To prevent damage to the battery bus contactors and/or batteries, do not leave the BATT switch in ON or ORIDE for extended periods without the generators on the line. After engine shutdown, ensure BATT switch is OFF and the BATT SW caution light is not ON.

2.5.3.1 Battery Switch.

- | | |
|-----|--|
| OFF | Batteries can be charged, but battery contactors will not energize to connect a battery to the essential bus (start bus) in response to low voltage conditions. Both voltmeters are inoperative. |
| ON | Enables control circuitry of both battery contactors, so that the U battery contactor will automatically close in response to a low voltage condition on the left 28 volt dc bus, and the E battery contactor will subsequently close in response to a low voltage condition from the U battery output. U and E voltmeters indicate voltage on their respective batteries. On aircraft 162394 AND UP, position enables the bus tie circuit and the ac bus isolation and generator auto reset circuit. On aircraft 163119 AND UP, an automatic battery cutoff circuit is provided which cuts off the battery from the essential dc bus 5 minutes after internal or external ac power is removed from the aircraft while on the ground with the battery switch ON. |

ORIDE Energizes E battery contactor, regardless of status of U battery or left 28 volt dc bus. Position can be used to connect E battery to the essential buses in the event U battery contactor fails to energize. With switch ON only E voltmeter is operative. On aircraft 162394 AND UP, position disables the bus tie circuit and the ac bus isolation and generator auto reset circuit.

2.5.3.2 E/U BATT Voltmeter. The E/U BATT voltmeter, which combines a U battery voltmeter and E battery voltmeter in one indicator, is on the electrical power panel. Voltage is indicated in 1-volt increments from 16 to 20 volts, and in 2-volt increments from 20 to 30 volts. The scales are marked at 24 volts and 20.5 volts (the U battery voltage at which the E battery will automatically power the essential 24/28 volt dc bus). With the battery switch OFF, the voltmeters are inoperative and the indicator needles indicate 16 volts. With the battery switch ON both voltmeters are operative; with the switch in ORIDE only the E voltmeter is operative.

2.5.3.3 BATT SW Caution Light/Display. The BATT SW caution light on the caution lights panel is associated with operation of the batteries. A BATT SW caution display on the DDI (with ac power on the aircraft) and the MASTER CAUTION comes on in conjunction with the caution light. The BATT SW caution alerts the pilot to check the position of the battery switch. The light coming on, on the ground, without ac power on the aircraft indicates that batteries are being depleted and switch should be placed OFF unless APU start is about to be made. The BATT SW light coming on in the air normally indicates that the battery switch is in OFF or ORIDE and should be placed to ON. The BATT SW light coming on in the air with the battery switch in ON indicates that the essential bus is energized by battery power (double generator or double transformer-rectifier failure) and that battery energy should be conserved.

2.5.3.4 Automatic Battery Cutoff. On aircraft 161353 THRU 163118 AFTER AFC 090 and 163119 AND UP, an automatic battery cutoff circuit is provided which cuts off the battery from the essential dc bus 5 minutes after internal or external ac power is removed from the aircraft while on the ground with the battery switch in ON. Once the battery cutoff is activated, the battery can be reconnected to the essential dc bus for additional 5-minute periods by either of three procedures: momentarily placing the APU switch ON, cycling the battery switch to OFF then ON, or cycling the MMP enable switch in the nosewheel well to RESET and back to NORM with the battery switch out of the ON position. The automatic battery cutoff circuit has no effect on operation of the ORIDE position of the battery switch.

2.5.4 External Electrical Power. External electrical power may be connected to the aircraft bus system through an external electrical power receptacle on the left side of the forward fuselage. The aircraft buses are energized by external power in the same manner as if a generator were operating. On aircraft 162394 AND UP, the aircraft buses are energized as above provided the battery switch is OFF or the parking brake is set. If the battery switch is ON and the parking brake is not set, the ac buses associated with the right generator are not energized. This condition is indicated by the GEN TIE caution coming on. Some aircraft systems do not energize immediately upon application of external power. Power can be applied to these systems through actuation of ground power switches.

2.5.4.1 External Power Switch. The external power switch, on the ground power panel on the left console (figure 2-10), controls application of external power to the aircraft electrical buses. If the external power is not of the proper quality (within voltage, phase and frequency limits), the external power monitor senses this and disconnects or prevents the external power from being connected to the aircraft.

RESET	Must be selected before external power can be applied to aircraft buses. The RESET position is spring loaded to NORM.
NORM	Allows the aircraft electrical buses to be energized by external power if no aircraft generators are operating, providing external power is of proper quality and this switch is first positioned to RESET.
OFF	Disconnects external power from the aircraft.

2.5.4.2 Ground Power Switches. Four ground power switches are provided on the ground power panel (figure 2-10) on the left console. Each controls a group of systems and/or instruments (listing is on a placard above the panel) and prevents operation of the systems/instruments on external power, unless the switch is placed to the ON position.

AUTO	System/instrument is automatically deenergized with external power on.
ON	System/instrument can be energized by external power for maintenance purposes. When a generator comes on the line, the switch returns to AUTO.

NOTE

- With an overheat condition present, all ground power switches in the ON position (solenoid held) revert to the AUTO position, and cannot be returned to ON until the overheat condition is corrected.
- When the first ground power switch is set to ON, the avionics under-cool warning temperature switch performs an internal BIT (approximately 3 seconds). During BIT, the ground power switch(es) must be held ON or it reverts to AUTO.
- On aircraft 161353 THRU 162889, setting any ground power switches to ON with an engine driven generator on line activates a false MMP code 884 (ground power circuit fail).

2.5.5 Circuit Breakers. Two circuit breaker panels containing essential breakers are located above the right and left consoles. The panel above the left console contains the following breakers: FCS CHAN 1, FCS CHAN 2, SPD BRK and LAUNCH BAR. The panel above the right console contains the following breakers: FCS CHAN 3, FCS CHAN 4, HOOK and LG.

2.6 LIGHTING

2.6.1 Exterior Lighting. Exterior lights are controlled from the exterior lights panel, the left vertical panel, and the left throttle grip.

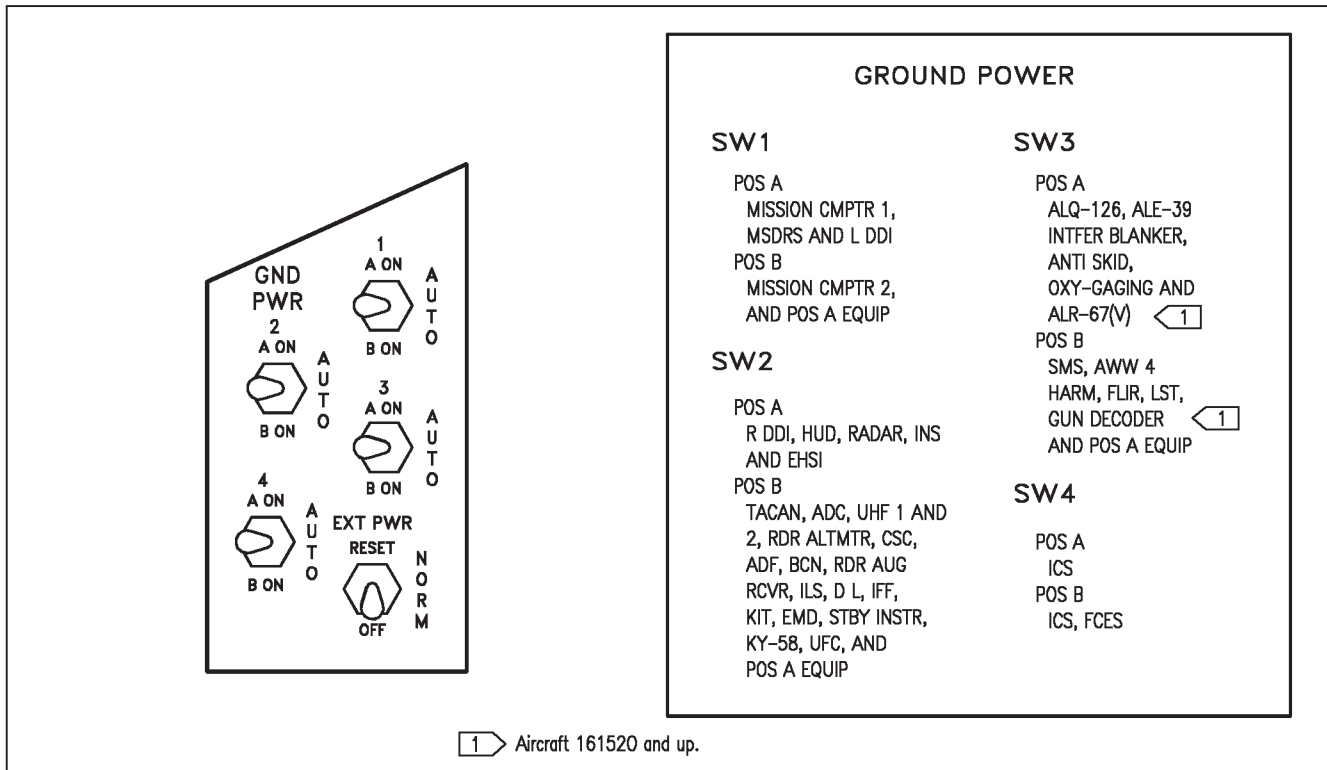

18AC-NFM-00-(12-1)31-CAT1

Figure 2-10. Ground Power Panel and Placard

2.6.1.1 Exterior Lights Master Switch. The exterior lights master switch, on the outboard left throttle grip, provides a master control for the following exterior lights: position lights, formation lights, strobe lights, arresting hook floodlight and refueling probe light.

- | | |
|-----------|---|
| OFF (AFT) | Power for lights controlled by switch is cut off. |
| ON (FWD) | Power is available for lights controlled by switch. |

2.6.1.2 Position Lights. The position lights include a white light just below the tip of the right vertical tail fin, three green lights on the right side of the aircraft, and three red lights on the left side of the aircraft. The green and red lights are at the following locations on their respective sides of the aircraft: wing tip, LEX forward of the wing root, and under the wing at the wingfold hinge. The position lights are controlled by the POSITION lights knob on the exterior lights panel which provides variable lighting between positions OFF and BRT. The exterior lights master switch must be ON for the position lights knob to operate.

2.6.1.3 Formation Lights. Eight formation lights are provided. Two lights are on each wing tip and show above and below a wing tip missile when installed, two lights are on the outboard of the vertical tail fins, two lights are on the aft fuselage below the vertical tail fins, and two lights are on either side of the forward fuselage just forward of the LEX. The formation lights are controlled by the FORMATION lights control knob on the exterior lights panel which provides variable lighting between positions OFF and BRT. The exterior lights master switch must be ON for the formation lights knob to operate.

2.6.1.4 Strobe Lights. Two red anti-collision strobe lights, one on each outboard vertical tail fin, are provided. The strobe lights are controlled by the STROBE lights switch on the exterior lights panel. The exterior lights master switch must be ON for the strobe lights switch to be operative.

OFF	Lights are off.
BRT	Lights illuminate at full intensity.
DIM	Lights illuminate at reduced intensity.

2.6.1.5 Landing/Taxi Light. A combination landing and taxi light is on the nose gear strut. The light is controlled by the LDG/TAXI light switch on the left vertical panel.

OFF	Light is off.
ON	If the landing gear handle is in DN and the landing gear is down, the light is on.

2.6.1.6 Approach Lights/Arresting Hook Floodlight. Three approach lights are on the nose gear strut. With all landing gear down and locked, and weight off the gear, the lights come on as a function of angle of attack. A green light indicates a high angle of attack, an amber light indicates optimum angle of attack and a red light indicates a low angle of attack. The operating approach light flashes if the arresting hook is not down and the HOOK BYPASS switch, on the left vertical panel, is in CARRIER. If the HOOK BYPASS switch is in FIELD, the lights do not flash. The FIELD position is solenoid held and reverts to CARRIER when the arresting hook is lowered or electrical power is shutdown after flight. On aircraft 161353 THRU 162909, an arresting hook floodlight on the left inboard landing gear door (when installed) illuminates the arresting hook area when the approach lights are on, provided the exterior lights master switch is on. The approach lights are dimmed whenever the warning/caution/advisory lights are dimmed. The arresting hook floodlight cannot be dimmed. On aircraft 163092 AND UP, the arresting hook floodlight is removed.

2.6.2 Interior Lighting. Except for the utility floodlight, UFC display lighting, AOA indexer lights, and IFEI display lighting, all controls for the interior lights are on the interior lights panel on the right console.

2.6.2.1 Mode Switch (AIRCRAFT 163985 AND UP). The MODE switch is used to select the cockpit lighting mode. In aircraft 163985 THRU 164740, the MODE switch has positions of NORM and NVG. The NORM position permits the maximum brightness range for the warning, caution, and advisory lights and the main and console panel lighting. The NVG position provides night vision goggle compatible lighting. In aircraft 164865 AND UP, the MODE switch has positions of NVG, NITE, and DAY. The DAY position permits the maximum brightness range for the warning, caution, and advisory lights and the main and console panel lighting. The NITE position provides reduced brightness for the warning, caution, and advisory lights, and normal intensity for the main and console lighting. The NVG position provides reduced brightness for the warning, caution, and advisory lights, disables the integral console lighting, and enables NVG compatible flood lights to illuminate the consoles.

2.6.2.2 NVG Compatible Cockpit Lighting Retrofit. On aircraft 161702 THRU 163782 AFTER AFC 209, AVCs 4525, 4526, AND 4527 the cockpit lighting system is modified to provide compatible NVG lighting. The master arm control panel, right and left advisory and threat panels, caution light panel, radar altimeter, and UFC panel are modified to emit less light (NVG compatible). The chart light,

utility light, eight floodlights, and lock/shoot lights are replaced with the new night attack lights. The function of the knobs and switches on the interior lights panel is unchanged, however; the total brightness for a given position is now reduced.

2.6.2.3 Console Lighting. Integral and light panel lighting for the left and right consoles, the hydraulic pressure indicator, and both cockpit circuit breaker panels are controlled by the CONSOLES knob which provides variable lighting between positions OFF and BRT.

On aircraft 163985 AND UP with the MODE knob in NORM, the CONSOLES knob provides variable lighting between OFF and BRT. With the MODE knob in the NVG position, the CONSOLES knob provides variable NVG floodlighting between OFF and BRT for the consoles.

2.6.2.4 Instrument Lighting. Integral and light panel lighting for the instrument panel, UFC background, right and left vertical panels (except for the hydraulic pressure indicator) and standby magnetic compass are controlled by the INST PNL knob which provides variable lighting between positions OFF and BRT. The strobe shoot light does not illuminate when the instrument lights are on. On aircraft 163985 AND UP, the INST PNL knob provides variable lighting between OFF and BRT, with the MODE switch in either NORM or NVG.

2.6.2.5 Flood/Chart Lighting. Eight white floodlights are provided for secondary lighting. Three console floodlights are above each console, and an instrument panel floodlight is located to either side of the instrument panel. A chart light is installed on the canopy arch. On aircraft 161353 THRU 163782 the flood lights are controlled by the FLOOD knob and MODE switch. With the flood switch in the COCKPIT position, the flood knob provides variable flood and chart lighting between OFF and BRT. In the CHART position, the flood knob provides variable chart lighting between OFF and BRT. On aircraft 163985 AND UP, the flood lights are controlled by the FLOOD knob and MODE switch. On aircraft 163985 THRU 164740 with the MODE switch in the NORM position, or on aircraft 164865 AND UP with the MODE switch in DAY or NITE the floodlights are controlled by the FLOOD knob which provides variable lighting between OFF and BRT. The FLOOD knob is inoperative with the MODE switch in the NVG position. An NVG compatible chart light is controlled by the CHART knob and rotates in two axis with variable lighting between OFF and BRT. The chart light operates independent of the MODE switch position.

2.6.2.6 IFEI Lighting. In aircraft 164865 AND UP, the IFEI brightness control knob on the video recorder panel provides variable IFEI lighting between OFF and BRT, with the MODE switch on the interior light panel in either the NITE or NVG position.

2.6.2.7 Utility Flood Light. A portable utility floodlight is provided and normally stowed above the right console: an alligator clip attached to the light may be used to fasten the light at various locations in the cockpit at the pilot's discretion. The light contains a knob which provides variable lighting from off to bright, and a button which when pressed causes the light to come on at full intensity. The light also contains a rotary selector for red or white lighting.

On aircraft 163985 AND UP, the utility floodlight is NVG compatible with white and blue/green lenses.

2.6.2.8 Emergency Instrument Light. A white emergency instrument light on the right side of the instrument panel comes on to illuminate the standby flight instruments when double generator or double transformer-rectifier failure occurs. The light comes on whenever a BATT SW caution light comes on. There is no cockpit control for the emergency instrument light.

2.6.2.9 Engine Instrument Light. The engine instrument light is a stationary non-dimmable low intensity floodlight which provides lighting for the engine monitor indicator or integrated fuel/engine indicator when the APU switch is in the ON position.

2.6.2.10 WARNING/CAUTION Lights Knob. A knob labeled WARN/CAUT is provided on the interior lights control panel to vary the brightness of the warning/caution/advisory lights within the low intensity range. On aircraft 161353 THRU 164740, warning/caution/advisory lights can be switched to the low intensity range by placing the warning/caution lights knob momentarily to RESET, if the INST PNL knob is out of the OFF position, and either the FLOOD knob is out of OFF but less than 70 % of BRT or the flood switch is in CHART. On aircraft 164865 AND UP, the RESET function is performed by the MODE switch. On aircraft 163985 THRU 164740, the warning/caution lights come on at a reduced brightness in the NVG mode. The lighting system defaults to the NORM mode with power interruption. On aircraft 164865 AND UP, the warning/caution lights come on at a reduced brightness in the NITE and NVG mode. Once in the low intensity range, the warning/caution/advisory lights can be brought back to high intensity by turning the MODE switch to the DAY position. With power interruption and the MODE switch in NVG, the lighting system remains in the NVG mode when power is restored. With power interruption and the MODE switch in DAY or NITE, the lighting system defaults to the DAY mode when power is restored.

2.6.2.11 Lights Test Switch. A lights test switch, labeled LT TEST, is provided to test the warning/caution/advisory lights in addition to the AOA indexer lights and the integrated fuel/engine indicator LCD displays on F/A-18C/D aircraft. The switch only operates with AC power on the aircraft.

F/A-18A/B aircraft -

TEST	Serviceable warning/caution/advisory lights and AOA indexer lights come on. On F/A-18A 163146 AND UP; ALSO F/A-18A 161353 THRU 163145 AFTER IASC 030, the landing gear aural tone also comes on.
OFF	The switch is spring loaded off.

F/A-18C/D aircraft -

TEST	Serviceable warning/caution/advisory lights and AOA indexer lights come on. On the integrated fuel engine indicator the leading 1s are displayed for RPM, TEMP, FF and OIL, and the remainder of the LCD locations indicate 0s. On F/A-18C, the landing gear aural tone also comes on.
OFF	The switch is spring loaded off.

2.7 HYDRAULIC POWER SUPPLY SYSTEM

Hydraulic power is supplied by two separate systems (HYD 1 and HYD 2). Each system consists of two hydraulic circuits (circuit A and circuit B). See Hydraulic System, figure 2-11. The two hydraulic systems are identical with the exception of the fluid supply line from the hydraulic system 2 reservoir assembly to the APU hydraulic hand pump. The left, or system 1, provides power to the primary flight control surface actuators exclusively. The right, or system 2, also provides power to the primary flight control actuators and additionally supplies power to the speedbrake and non-flight control actuators.

Redundancy to the flight control actuators is achieved either by simultaneously pressurizing the actuator from both systems or by supplying pressure to the actuator from one system while the other system is in a back-up mode.

2.7.1 Pumps and Reservoirs. The hydraulic pump for system 1 is mounted on the left AMAD (Airframe Mounted Accessory Drive) and the pump for system 2 is mounted on the right AMAD. The pumps contain a pressure regulating feature which keeps the pump output at approximately 3,000 psi. A pressure relief valve in the filter and pressure relief valve hydraulic unit prevents over pressurization of the hydraulic system and subsystems. A transducer in each reservoir continuously relays system pressure to a hydraulic pressure indicator on the lower right main instrument panel. Each reservoir has a reservoir level sensing (RLS) system which shuts off a leaking branch circuit (HYD 1A, HYD 1B, HYD 2A, or HYD 2B) when the leak reduces the fluid level below a certain level. When the RLS shuts a branch circuit off and the circuit pressure drops below 1,500 psi, a circuit pressure switch causes the MASTER CAUTION light and the appropriate HYD 1A, HYD 1B, HYD 2A or HYD 2B caution display on the DDI to come on. The A circuit shuts off when the reservoir level drops to 60 % of full. The A circuit comes back on the line and the B circuit shuts off when the reservoir drops to 32 % of full. The B circuit comes back on the line and no cautions are displayed when the reservoir level drops below 4 % of full.

2.7.2 Hydraulic Circuits. Before the output pressure in each of the two hydraulic systems is routed from the reservoir to subsystems, it is divided into circuit A and circuit B. Each circuit has a circuit shutoff feature to protect the other circuit from depletion due to leakage in the circuit. To prevent fluid loss due to leakage, when the landing gear is up, an isolation valve in both circuit A and circuit B of hydraulic system 2 shuts off pressure to the NWS, launch bar, anti-skid, brakes, and nose gear, as these components are not normally utilized during flight. Circuit 2B isolation can be overridden for inflight recharging of the APU accumulator by holding the hydraulic isolate override switch to HYD ISOL ORIDE. Hydraulic system 2 also has a forward and aft priority valve to monitor demand on portions of the hydraulic system and provide priority for the flight control actuators. If demands on the system are great enough that pressure upstream of the priority valve decreases to approximately 2,200 psi or less, the priority valve completely blocks hydraulic flow through the valve until the demands on the system reach a point that is within the system's capability to maintain approximately 2,200 psi upstream of the priority valve. There are three hydraulic filter ΔP indicators in each main wheelwell. Two are in the aft outboard corner of the wheelwell and one is in the center of the aft bulkhead. A popped ΔP indicator indicates that the filter is clogged.

2.7.3 Valves. Aft Isolation Valve - The aft isolation valve isolates the APU start, hand pump, APU accumulator, brake accumulator, and the emergency inflight refueling probe actuator from the remainder of the hydraulic system while weight off wheels. This valve is open with weight on wheels. This valve can be opened by the aircrew inflight by the activation of the HYD ISOL switch to ORIDE. This capability allows the APU accumulator to be recharged inflight.

Forward Isolation Valve - The forward isolation valve isolates the nose landing gear, launch bar, nosewheel steering, and brakes with the landing gear up and locked. The valve is open when the landing gear handle is lowered.

APU Arming Valve - The APU arming valve is activated by rotating and pulling the landing gear handle (emergency gear extension) or moving the probe switch to EMERG EXTD. This allows stored hydraulic pressure in the APU accumulator to be used to emergency extend the inflight refueling probe, emergency landing gear extension, emergency nosewheel steering and emergency brakes.

Aft priority Valve - The aft priority valve shuts off hydraulic pressure to the arresting hook retract actuator and speedbrake actuator during high flight control demand. When sufficient hydraulic

pressure is available, pressure is again available to these actuators. The valve is not pilot controllable.

Forward Priority Valve - The forward priority valve shuts off hydraulic pressure to the gun, refueling probe actuator, landing gear, launch bar, nosewheel steering, and brakes during high flight control demand. When sufficient hydraulic pressure is available, pressure is again available to these actuators. The valve is not pilot controllable.

Landing Gear Control Valves - Landing gear control valves isolate the landing gear from the remainder of the hydraulic system with the landing gear up and locked.

2.7.4 Accumulators. Two accumulators are provided in the system 2 circuitry, an auxiliary power unit (APU) accumulator and a brake accumulator. Both accumulators can be charged with a hand pump on the ground. In flight the APU accumulator can be charged from circuit 2B by positioning the Hydraulic Isolation Override switch (HYD ISO) to ORIDE. It is recommended that the switch be held in ORIDE for at least 10 seconds to get a full charge.

The brake accumulator is continuously charged in flight by a trickle charge restrictor in circuit 2A. The brake accumulator can also be charged in flight by circuit 2B if the HYD ISO switch is positioned to ORIDE and either:

- (a) Emergency landing gear extension is selected or,
- (b) Emergency IFR probe extension is selected.

The APU accumulator serves to start the APU and to provide emergency back-up hydraulic power to refuel probe extension and nosewheel steering. The brake accumulator, in conjunction with the APU accumulator, provides emergency pressure to unlock/lock the landing gear and operate the brakes. A brake accumulator pressure gage is provided on the lower left instrument panel. Another brake accumulator pressure gage is provided in the nose wheelwell. Both gages receive the same signal from a common sensor on the brake accumulator manifold. HYD 2A pressure, through a trickle charge restrictor, compensates the brake accumulator for temperature changes and normal internal leakage when the hydraulic isolate valve is closed.

2.8 FLIGHT CONTROL SYSTEM

2.8.1 Application. The flight control system characteristics and mechanization for aircraft described in this manual varies between aircraft, and may vary on a particular aircraft as a result of various modifications. While changes in characteristics and mechanization may involve structural and mechanical differences, such changes are associated with the particular Programmable Read-Only Memory (PROM) installed in the flight control computers.

2.8.2 Primary Flight Controls. The primary flight controls are the ailerons, twin rudders, differential/collective leading edge flaps, differential/collective trailing edge flaps and differential/collective stabilators. See figure 2-12, Flight Control System Functional Diagram. Hydraulic actuators position the control surfaces. Stick and rudder feel are provided by spring cartridges. Although there is no aerodynamic feedback to the stick and rudder pedals, the effect is simulated by flight control computer scheduling of control surface deflection versus pilot input as a function of flight conditions. Normally, inputs to the hydraulic actuators are provided by the two flight control computers (FCC A and FCC B) through the full authority control augmentation system (CAS). A direct electrical link (DEL) automatically backs up the CAS. DEL is normally a digital system but has an analog mode for backup aileron and rudder control. If digital DEL fails, a mechanical link (MECH) automatically provides roll and pitch control through a direct mechanical input from the stick to the stabilator actuators. MECH bypasses both flight control computers and the stabilator actuator servo valves.

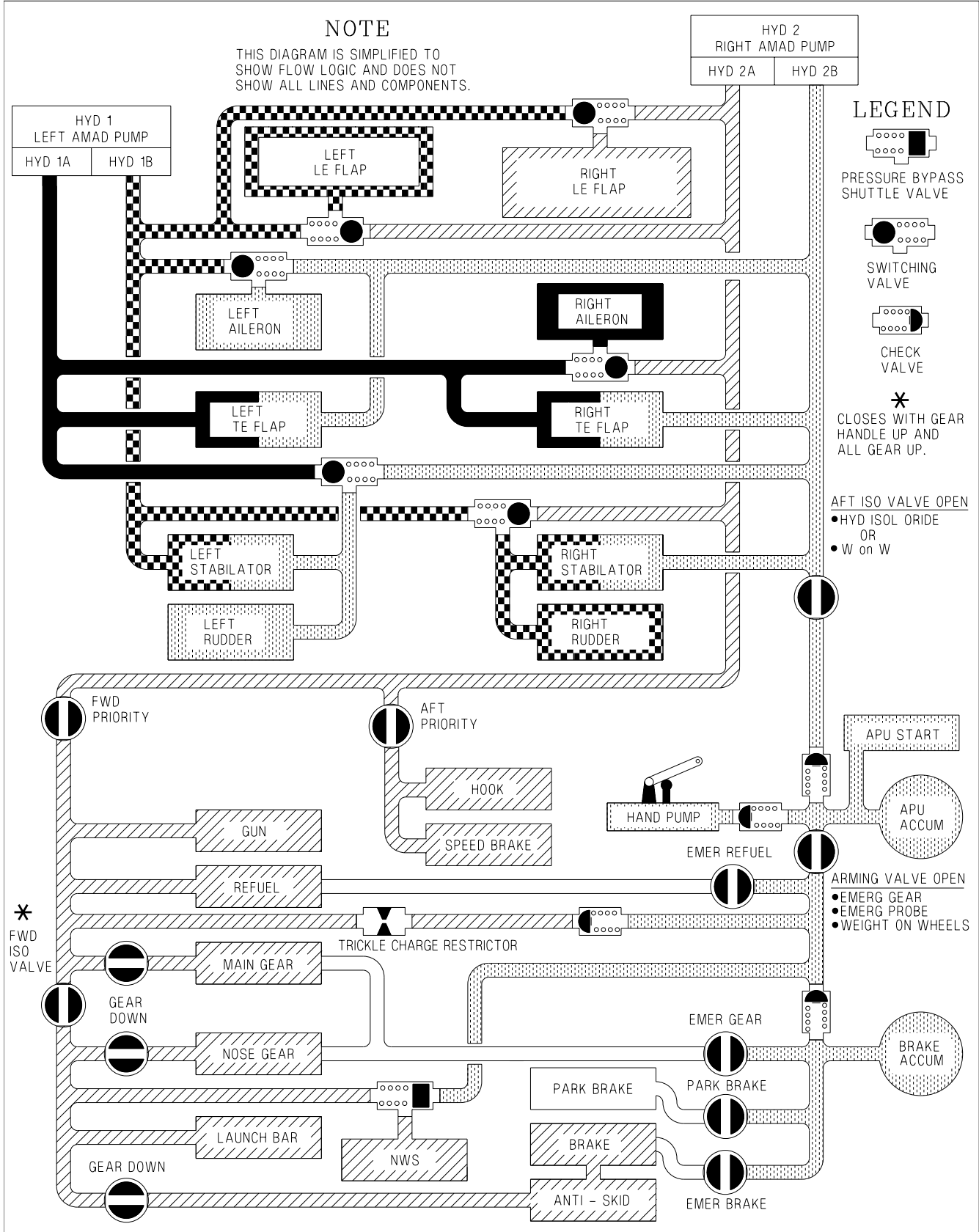

ADA520-63-1-045

Figure 2-11. Hydraulic System

Multiple redundant paths ensure that single failures have no effect and multiple failures have minimum effect on control. Figure 2-12 shows the redundancies and the inputs used to provide the desired flight characteristics.

2.8.2.1 Hydraulic Power. Hydraulic power is supplied by HYD 1 and HYD 2 to all primary flight control actuators (see figure 2-11). Failure of either HYD 1 or HYD 2 does not affect flight control when configured in flaps AUTO (UP), however, failure of either HYD system when configured flaps HALF or flaps FULL may cause an uncommanded yaw and roll transient as the switching valves cycle. The uncommanded yaw and roll may be severe under certain situations such as single engine and high or low speed flight. The uncommanded yaw and roll transient may last three to 6 seconds.

WARNING

Avoid intentional engine shutdown while configured in flaps HALF or FULL. An uncommanded yaw and roll may result when the switching valves switch.

The system is arranged to minimize the probability of loss of control to any surface or the loss of control of one surface due to catastrophic damage to the lines or actuator powering any other surface.

2.8.2.2 Pilot Controls

2.8.2.2.1 FLAP Switch. The FLAP switch selects which of the two flight control computer modes (auto flap up or takeoff and land) is active and thus determines the flight characteristics for those conditions.

AUTO	Flight controls in auto flap up mode.
HALF	Flight controls in takeoff and land mode below 250 knots. Flight controls in auto flap up mode above 250 knots.
FULL	Flight controls in takeoff and land mode below 250 knots. Flight controls in auto flap up mode above 250 knots.

2.8.2.2.2 Control Stick. The stick grip contains the pitch and roll trim switch, sensor control switch, air-to-ground weapon release button, gun/missile trigger, air-to-air weapon select switch, undesignate/nosewheel steering button and on aircraft 164279 AND UP, the RECCE event mark switch. An autopilot/nosewheel steering disengage switch (paddle switch) is mounted below the stick grip (see figure 2-13). Stick position sensors transmit an electrical signal proportional to stick displacement from neutral to the flight control computers.

2.8.2.2.3 Rudder Pedals. Movement of the rudder pedals transmits a proportional electrical signal to the flight control computers. The rudder pedals are also used for nosewheel steering and brakes. In F/A-18B and F/A-18D aircraft configured as trainers, the rear cockpit pedal input can cancel front cockpit pilot input. In F/A-18D aircraft 163986 AND UP configured for night attack, the rear cockpit rudder pedals are fixed and disconnected from the brakes, rudder, and nosewheel steering.

2.8.2.2.4 Rudder Pedal Adjust Lever. Pressing the rudder pedal adjust lever on the main instrument panel releases the rudder pedals. Both pedals are then forced aft by springs and pushed forward by the pilot to the desired position. Releasing the lever locks the rudder pedals in the new position.

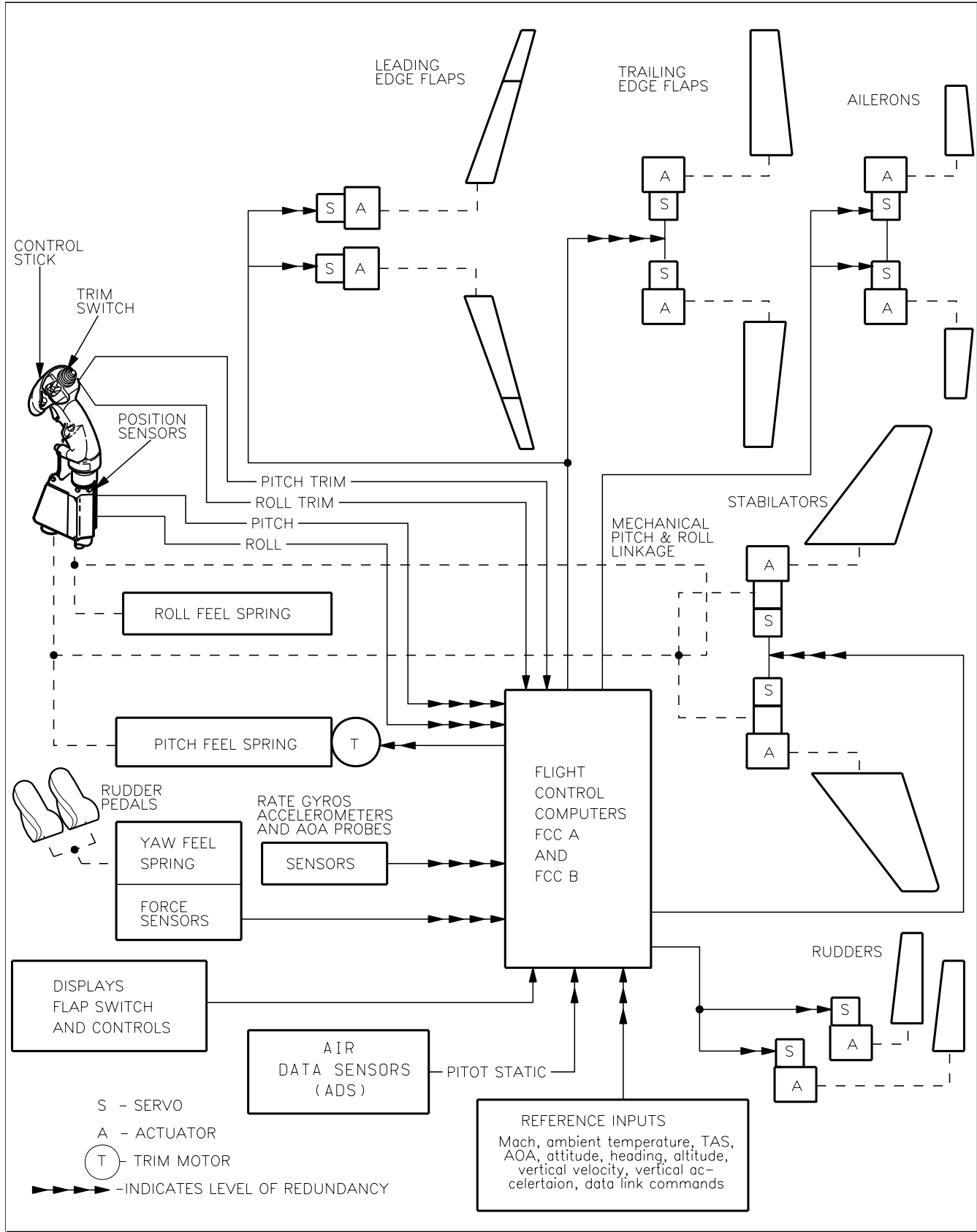

18AC-NFM-00-(13-1)37-CAT1

Figure 2-12. Flight Control System Functional Diagram

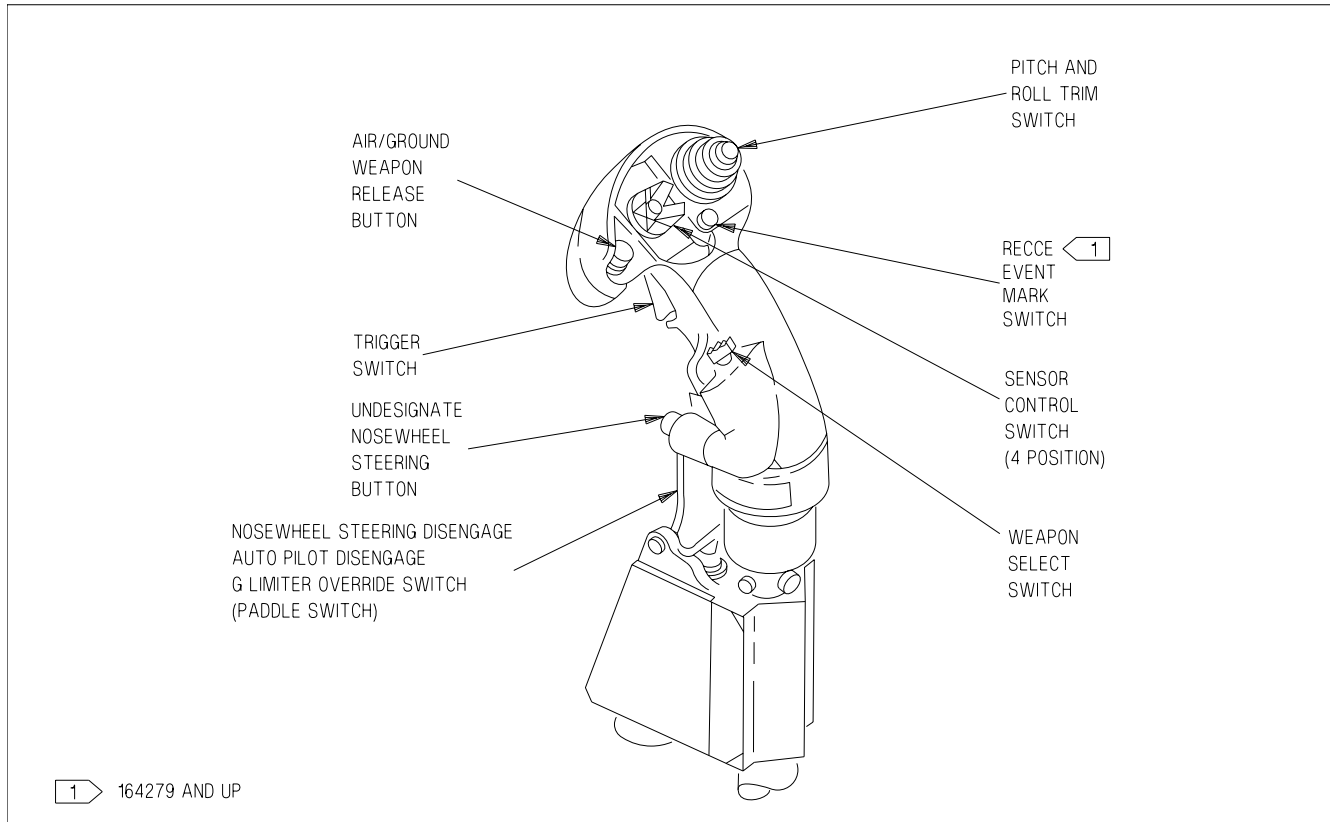

ADA520-14-1-039

Figure 2-13. Control Stick

2.8.2.2.5 Pitch and Roll Trim Switch. Normally, movement of the pitch and roll trim switch electrically biases the flight control computers and the stick does not move. Little if any pitch trim is required in the auto flap up mode due to the automatic trimming functions within the flight control computers. In MECH, pitch trim moves the control stick fore and aft, changing the stick neutral point. There is no mechanical lateral trim.

2.8.2.2.6 Rudder Trim Knob. Movement of the rudder trim knob on the FCS control panel electrically biases the flight control computers. The rudder pedals do not move.

2.8.2.2.7 T/O Trim Button. The T/O Trim button is in the center of the rudder trim knob on the FCS panel. With WOW, holding the button pressed drives the roll and yaw trim to the neutral position, stabilator to 12° nose up, and zeros the MECH stick position. When the roll and yaw control surfaces are trimmed to neutral and the stabilator to 12° nose up, the TRIM advisory is displayed on the DDI until the button is released. Actuation of roll trim within 20 seconds of FCS IBIT with wings folded inhibits roll trim. Roll trim is reactivated by pressing the T/O Trim button with WOW. In flight and CAS, pressing the T/O Trim button only neutralizes the MECH stick position.

2.8.2.2.8 FCS RESET Button. The FCS RESET button on the FCS panel is used to reset the flight control computers after a transient malfunction.

2.8.2.2.9 GAIN Switch. The GAIN switch on the FCS panel is described under Secondary Flight Controls, this section.

2.8.2.3 G Limiter. The g limiter prevents exceeding the aircraft positive g limit under most conditions while permitting full symmetrical and unsymmetrical (rolling) maneuvering. The reference for symmetrical pilot commands is the aircraft design load (+7.5 g at 32,357 pounds gross weight). Unsymmetrical pilot command limits are dependent on lateral stick position and vary from the symmetrical limit with small lateral stick displacement to 80 % of the symmetrical limit with full lateral stick displacement. A g limiter override feature allows an increase in the command limit g for emergency use.

Below 44,000 pounds gross weight, the positive symmetrical command limit is calculated based on fuel state and stores loading. Above 44,000 pounds gross weight, the positive symmetrical command limit is fixed at +5.5 g. The negative symmetrical command limit is fixed at -3.0 g at all gross weights and stores loading. Longitudinal stick displacement required to achieve command limit g varies with airspeed and gross weight. When the command limit g is reached, additional aft stick does not increase g. The positive command limit g is reduced when decelerating through the transonic region. This reduction may be as much as 1.0 g providing the available g is not reduced below +5.0 g.

WARNING

Rapid aft stick movement, with or without g limiter override, commands a very high g-onset rate. This high g-onset rate can cause immediate loss of consciousness without the usual warning symptoms of tunnel vision, greyout, and blackout. Consciousness may not return for more than 20 seconds after the g level is reduced to near 1 g.

The g limiter may be overridden by momentarily pressing the paddle switch with the control stick near full aft. Command limit g is then increased by 33 %. A G-LIM OVRD caution is displayed and the MASTER CAUTION light and tone come on. A code is stored in the nose wheelwell DDI when the g limiter is overridden. Override is disengaged when the control stick is returned to near neutral.

A CG, R-LIM OFF, CAUT DEGD, MC1, or MC2 caution, stores management system failure, FCC/MC mux bus communication failure, or invalid fuel quantity cause the positive symmetrical command limit to be set at 7.5 g regardless of gross weight or stores loading. A G-LIM 7.5 G caution is displayed, the MASTER CAUTION comes on and a “FLIGHT CONTROLS, FLIGHT CONTROLS” voice warning sounds.

G overshoot can occur under any flight conditions. G should be continuously monitored. Under the following conditions, g should be carefully monitored:

- G-LIM 7.5 g caution displayed
- Positive g with gross weight over 44,000 pounds
- Fuel less than 3,300 pounds
- Negative g with gross weight over 32,357 pounds
- MC1 failure

2.8.2.4 Actuator Exerciser Mode. An actuator exerciser mode is incorporated to improve cold weather start-up of the FCS. On the ground, the pilot can initiate the exerciser mode by simultaneously holding the FCS BIT consent switch ON and pressing the FCS RESET button. When initiated, the mode cycles the stabilators, flaps, ailerons, and rudders through 20 % of full travel for 10 cycles in 20 seconds. The operation can be stopped before 20 seconds have elapsed by pressing the paddle switch. The mode should be used in cold weather or any time an initial FCS RESET fails.

2.8.2.5 Departure Warning Tone. Departure warning tones do not indicate NATOPS limits. The audio departure warning tone is initiated at 40°/second yaw rate. The beep frequency increases with yaw rate up to 60°/second yaw rate. Above 60°/second yaw rate, the frequency remains constant. Above 35° AOA and below -7° AOA, the tone comes on at a constant frequency and yaw rate warning is no longer available.

With FLAP switch in FULL, the departure warning tone is initiated at 12° AOA and becomes constant at 32° AOA; with FLAP switch in HALF, the tone starts at 15° and becomes constant at 35°.

WARNING

In GAIN ORIDE, no departure warning tone is initiated at 12° AOA FULL flaps or 15° AOA HALF flaps. Inadvertently exceeding these conditions could result in a departure from controlled flight.

With air-to-ground/tanks store codes loaded on the wing pylons and the rack hooks closed, a steady tone is heard at or above 25° AOA except for aircraft 162394 AND UP, with tanks on stations 3 and 7 and no stores on stations 2, 5, or 8, where a steady tone is heard at or above 33° AOA. The tone comes on at +35°/-7° if all stores indicate HUNG. If there are any additional stores on board that are not HUNG, the AOA tone will still come on at +25°/-7° AOA.

The departure warning tone is enunciated at completion of FCS IBIT.

2.8.2.6 Spin Recovery System. The spin recovery system, when engaged, puts the flight controls in a spin recovery mode (SRM). This mode, unlike CAS, gives the pilot full aileron, rudder and stabilator authority without any control surface interconnects and all rate and acceleration feedbacks are removed. The leading edge flaps are driven to 33° ±1° down and the trailing edge flaps are driven to 0° ±1°.

Spin recovery system engagement depends on the position of the spin recovery switch.

2.8.2.6.1 Spin Recovery Switch and Light. The spin recovery switch on the map gain/spin recovery panel allows the pilot to select the conditions required for the flight controls to engage in the spin recovery mode. The SPN RCVY light, adjacent to the switch, is on when the spin recovery switch is in RCVY.

NORM Spin recovery mode engaged when all of the following conditions are met:

1. Airspeed 120 ±15 knots.
2. Sustained, uncommanded yaw rate.
3. Stick is placed in the direction indicated on the DDI spin recovery display.

The flight controls revert to CAS anytime the stick is placed in the wrong direction (i.e. prospin), the airspeed increases above about 245 knots, or the yaw rate decreases to less than 15°/second.

RCVY Spin mode engaged when airspeed is 120 ±15 knots. The flight controls revert to CAS when the airspeed increases above about 245 knots. Full authority prospin controls can be applied with the switch in RCVY and spin mode engaged.

2.8.2.6.2 DDI Spin Recovery Displays

a. Spin Recovery Switch in NORM. With the airspeed at 120 ±15 knots and a sustained, uncommanded left yaw rate with positive g or sustained, uncommanded right yaw rate with negative g,



appears on both DDIs (see figure 2-14).

With the airspeed at 120 ±15 knots and a sustained, uncommanded right yaw rate with positive g or sustained, uncommanded left yaw rate with negative g,



appears on both DDIs.

When the stick is placed in the indicated directions, the words

SPIN MODE

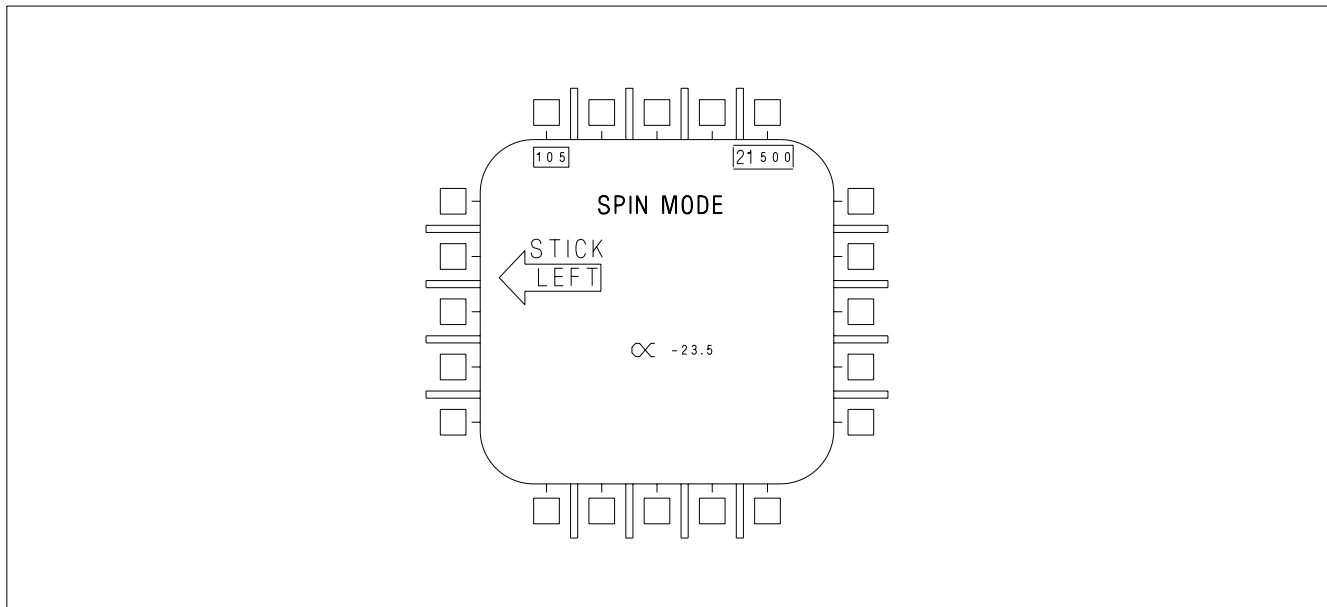

ADA520-142-1-045

Figure 2-14. SPIN Recovery Display

are replaced by

**SPIN MODE
ENGAGED**

When yaw rate ceases, or the airspeed increases above about 245 knots, the spin recovery display is replaced by the MENU display.

b. Spin Recovery Switch in RCVY. When the spin recovery switch is placed to RCVY

SPIN MODE

appears on both DDIs.

If the airspeed decreases to 120 ± 15 knots, the words

SPIN MODE

are replaced by

**SPIN MODE
ENGAGED**

If a sustained yaw rate develops, the words **STICK RIGHT** or **STICK LEFT** with an accompanying arrow also appear on the DDI.

When the airspeed increases above about 245 knots

SPIN MODE

appears on both DDIs and the flight controls revert to CAS.

Airspeed appears in the upper left corner, altitude appears in the upper right corner, and AOA appears in the lower center of the spin recovery display.



During highly oscillatory out-of-control motion, rapid cycling of the command arrows may occur. Under these conditions, the stick should be released until command arrow cycling stops. During intermediate and high yaw rate spin mode recoveries, removal of the command arrow may be delayed. Under these conditions, anti-spin controls should be neutralized (sustained command arrow present) only if spin rate has stopped and the AOA warning tone is no longer present.

2.8.2.7 Flight Control Computers (FCC). Two flight control computers (FCC A and FCC B) provide the computations which determine the flight characteristics. Electrical signals generated by movement of the stick grip and rudder pedals are transmitted (each signal on four different channels) to both FCC. The computers use the pilot inputs and inputs from various aircraft and internal sensors to determine proper outputs to the control actuators for desired aircraft response. The multiple channel inputs and outputs are continuously monitored by the FCC for agreement. When there is disagreement, the erroneous signal is discarded or, if this cannot be determined, the control system is

automatically switched to a degraded mode which does not use that signal. For survivability, one channel from each computer is routed through the upper part of the aircraft and the other channel is routed through the lower part. The stabilator and trailing edge flap servos receive four channel signals from the FCC. The aileron, rudder, and leading edge flap servos receive two channel signals. FCC A is powered by the essential 28 volt dc bus. FCC B is powered by the right 28 volt dc bus. Both computers are normally cooled by avionics air but ram air can be selected for FCC A cooling. The FCCs are provided with separate power inputs which are connected directly to the battery/charger. FCC A is connected to the emergency battery and the FCC B is connected to the utility battery. Should a power interruption occur on the main DC bus, sensors within the flight control computer automatically switch to the backup power source for up to 7 seconds. This ensures the flight control computers have uninterrupted power to maintain full FCES performance during all predictable bus switching transients.

2.8.2.7.1 FCS HOT Caution. The FCS HOT caution light and FCS HOT caution on the DDI indicates an overtemperature in FCC A or the right transformer-rectifier.

2.8.2.7.2 FCS or AV COOL Switch

NORM	Both FCC and both transformer-rectifiers cooled by avionics air.
EMERG	FCC A and right transformer-rectifier cooled by ram air. FCC B and left transformer-rectifier cooled by avionics air. Once EMERG selected, selection of NORM does not switch FCC A and right transformer-rectifier cooling back to avionics air.

2.8.2.7.3 FCC Circuit Breakers. FCS channel 1 and channel 2 (FCC A) circuit breakers are on the left essential circuit breaker panel under the left canopy rail. FCS channels 3 and 4 (FCC B) circuit breakers are on the right essential circuit breaker panel under the right canopy rail.

2.8.2.8 Control Augmentation System (CAS). The longitudinal control system uses air data scheduled pitch rate, normal acceleration (N_z) and angle-of-attack (AOA) to compute stabilator actuator commands. The aircraft response is compared to the pilot command and the stabilator servoactuator is driven to reduce the difference to zero. Since, in the auto flaps up mode, any uncommanded pitch rate or g is reduced to zero, the aircraft is constantly trimmed to steady state hands-off 1 g flight and there is little or no occasion for manual trim. Pitch rate and g (N_z) feedbacks improve pitch characteristics and g control at medium to high airspeeds. Air data scheduled pitch rate feedback improves maneuvering characteristics and provides increasing stick-force-per-g at low to medium airspeeds. AOA feedback provides increasing stick force with increasing AOA above 22°. In the takeoff and land modes, AOA and pitch rate feedbacks are used to augment inherent airframe pitch damping and stability. The computer nulls the difference between the trim AOA and actual AOA. In turns, pitch rate feedback maintains tight pitch attitude control.

The lateral control system uses ailerons, differential trailing edge flaps, differential leading edge flaps, differential stabilator, and rudders to achieve the desired roll characteristics. Scheduled air data roll rate feedback is used to augment inherent airframe roll damping. At high airspeeds, aileron travel versus stick movement is reduced and the ailerons do not deflect above 600 knots. Differential stabilator and differential trailing edge flap travel is reduced at high speed to prevent exceeding structural limits. The leading edge flaps deflect differentially up to $\pm 3^\circ$ when below 30,000 feet and above Mach 0.7. Differential flaps are not used in the takeoff or land modes nor above 10° AOA in the auto flaps up mode. At low airspeeds, aileron and differential stabilator travel are reduced with increasing AOA to minimize adverse yaw. Differential stabilator may also be limited due to a pitch

command which has priority. With lateral stick deflection, the rolling-surface-to-rudder interconnect (RSRI) schedules increasing rudder deflection as a function of decreasing airspeed and increasing AOA for roll control, coordination, and to reduce adverse yaw. With wing pylon mounted air-to-ground stores or tanks code set in the armament computer and the rack hooks for those stores closed, maximum roll rate is automatically reduced about 33 %. If all stores are shown as HUNG, roll rate limiting is removed; however, an R-LIM OFF caution appears on the DDI.

The directional control system uses twin rudders for yaw control. The FCS nulls yaw rate to provide yaw damping. Lateral acceleration feedback (N_Y) improves turn coordination. RSRI and roll-rate to rudder crossfeed (scheduled with AOA) are used for roll coordination. At low to medium AOA, full rudder pedal deflection provides $\frac{1}{2}$ rudder deflection. At high AOA, the RSRI and rudder-to-rolling surface interconnects combine with rudder pedal inputs to make full rudder deflection available. At high air speeds, rudder deflection is reduced to avoid exceeding structural limits. The control system includes specific logic to improve flying qualities above 20° AOA. Sideslip feedback to the ailerons and differential stabilator improves the resistance to out-of-control flight. Sideslip rate feedback to the ailerons and differential stabilator improves the damping of lateral-directional oscillations. For rolls, the differential stabilator deflects opposite to the intended roll direction to improve roll performance above 35° AOA. A means to temporarily boost roll performance above 30° AOA is provided when lateral stick and pedal are applied in the same direction. Excessive pitch/roll inertial coupling is prevented by giving temporary priority to the pitch axis during simultaneous roll and large pitch inputs. In the takeoff and land modes, rate of change of sideslip feedback augments aerodynamic directional damping and stability. For takeoff or land modes, rudder toe-in is used to improve the longitudinal stability and to provide early rotation during takeoff or bolter. Rudder toe-in/toe-out is a function of AOA with maximum toe-in (30°) at low AOA (less than 2°) or WOW and decreases proportionally thru 0° to 15° toe-out at 11° AOA.

2.8.2.9 Direct Electrical Link (DEL). A direct electrical link in each axis provides continued electrical operation of the flight controls after multiple system failures make CAS operation impossible. See FCS Failure Indications and Effects, Chapter 15. In DEL, stability and control is degraded. There are two DEL modes, digital and analog. With any axis in digital DEL, a DEL ON caution is displayed on the DDI. The FCS reverts to analog roll DEL and analog yaw DEL if there are three digital processor failures. In addition, the analog roll DEL function is activated if three channels to the aileron are Xd out and the analog yaw DEL function is activated if three channels to the rudder are Xd out. If the aircraft selects analog yaw DEL, the control laws also activate the digital roll DEL function. There is no analog pitch DEL mode. The DEL ON caution is not displayed when in the analog roll DEL mode. The DEL ON caution is displayed when in analog yaw DEL since digital roll DEL has been activated.

WARNING

Extreme caution should be used in analog DEL. Flight in this configuration has not been flight tested.

With the FLAP switch in AUTO, pitch digital DEL provides control of the stabilators after three similar pitch rate gyro or normal accelerometer failures. With the FLAP switch in HALF or FULL, pitch digital DEL provides control of the stabilators after three similar pitch rate gyro failures. Pitch trim rates in digital DEL are 25 % of CAS rates. There is no analog DEL mode in pitch.

Roll digital DEL provides roll control after three similar roll rate gyro failures. Trim is not affected. RSRI provides rudder displacement for roll coordination. Roll analog DEL provides an additional path to the ailerons for roll control after three digital processor failures. Analog DEL provides a direct

electrical path from the stick sensors to the aileron servos without an air data input. Analog DEL provides rudder coordination through an analog stick to rudder interconnect. There is no aileron trim capability in analog DEL.

Yaw digital DEL provides directional control after three similar yaw rate gyro failures. Rudder displacement versus rudder pedal force is decreased with increasing airspeed. Yaw digital DEL also reverts the roll axis to digital DEL as the roll rate feedback would be destabilizing in this condition. Yaw analog DEL provides rudder control through rudder servo commands without airspeed correction (feel) after three digital processor failures. There is rudder trim in both the digital and analog DEL mode.

2.8.2.10 Mechanical Linkage (MECH). Mechanical linkage provides backup control of the stabilators for pitch and roll control. A MECH ON caution is displayed on the DDI. See FCS Failure Indications and Effects, Chapter 15. In the mechanical mode, stick movement directly controls the stabilator actuators bypassing all force sensors, the flight control computers, all air data, all motion feedbacks, servos, and associated electrical wiring. A mode select actuator (ratio changer) increases stabilator movement versus stick movement when the FLAP switch is in HALF or FULL to provide added pitch authority. Pitch trim moves the stick fore and aft, changing the stick neutral point. There is no mechanical lateral trim.

In normal flight, the mechanical flight control command (MECH) does not exactly follow the flight control computer commanded position. Stick movement is transmitted to the stabilator actuator through the mechanical system to command a fixed amount of stabilator deflection. The same stick movement transmitted through the flight control computer (FCC) is modified by many inputs to the FCC including: g, airspeed, altitude, pitch/roll rate, trim input, etc., to command a different amount of stabilator deflection.

If the aircraft reverts to MECH ON, the stabilator will slowly fade from the flight control computer commanded position into the mechanical system commanded position. The fading takes place at between $1/2^\circ$ to 1° of stabilator position per second. If the FCC/MECH mismatch is relatively small, the resulting aircraft pitch change is minimal. However, reversion transients have occurred with large mismatches between the FCC commanded and the mechanical system commanded stabilator positions at the time of the reversion to MECH. As the mismatch increases, so does the resulting pitch up or down.

As the difference between the FCC commanded position and the mechanical system commanded position is faded out, full stabilator authority is not available. The amount of mismatch is not immediately available to the pilot. Once the mismatch is faded completely out, full mechanical system authority is available. When the fade out is complete, the stabilator actuator responds purely to stick position.

Pitch control is less responsive in mechanical system than with the flight control computer. Full aft stick and nose up trim following a MECH reversion does not provide any more stabilator movement than just full aft stick. Trim inputs will relieve some of the spring pressure on the stick while the mismatch fades out giving full mechanical authority.

2.8.3 Secondary Flight Controls. The secondary flight controls are the collective leading edge flaps, collective trailing edge flaps, drooped ailerons, and speedbrake.

2.8.4 Flaps. The collective leading edge and trailing edge flaps are controlled as a function of the FCC mode to provide the desired flight characteristics throughout the flight envelope. Figure 2-15 shows representative schedules in the auto flap up mode. Maximum flap deflection is limited by Mach

number and airspeed. Leading edge flaps remain fully retracted at Mach 1.2 and above regardless of AOA. Trailing edge flaps remain fully retracted above Mach 1.0 regardless of AOA. The flaps may not reach the deflections shown in figure 2-15 at low altitude and high airspeed.

The LEF system incorporates a performance monitor to improve detection of marginal LEF systems using a predicted vs. actual rate monitor. If the LEF deflection rate is slower than the expected LEF deflection rate, the FCC asserts a BLIN 221 identifying the marginal LEF, but does not assert any accompanying cautions.

2.8.4.1 Flap Operation

SWITCH POSITION

FLAP OPERATION

AUTO	With weight off wheels, leading and trailing edge flaps are scheduled as a function of AOA. With WOW, leading and trailing edge flaps and aileron droop are set to 0°.
HALF	Below 250 knots, leading edge flaps are scheduled as a function of AOA. Trailing edge flaps and aileron droop are scheduled as a function of airspeed to a maximum of 30° at approach airspeeds. Above 250 knots, the flaps operate in the auto flap up mode and the amber FLAPS light comes on. On the ground, the leading edge flaps are set to 12°. The trailing edge flaps and aileron droop are set to 30°. With the wing unlocked, aileron droop is set to 0°.
FULL	Below 250 knots, leading edge flaps are scheduled as a function of AOA. Trailing edge flaps and aileron droop are scheduled as a function of airspeed to a maximum of 45° flaps and 42° aileron droop at approach airspeeds. Above 250 knots, the flaps operate in the auto flaps up mode and the amber FLAPS light comes on. On the ground, the leading edge flaps are set to 12°. The trailing edge flaps are set to 43° to 45° and aileron droop to 42°. With the wings unlocked, aileron droop is set to 0°.

2.8.4.2 GAIN Switch. The GAIN switch on the FCS panel allows the pilot to select a fixed value for speed, altitude, and AOA inputs to the flight control computers and thus a fixed leading and trailing edge flap position dependent on FLAP switch position.

SWITCH POSITION

FLAP OPERATION

NORM	Flaps operate as described under Flap Operation.
ORIDE	With the FLAP switch in AUTO, the leading and trailing edge flaps are fixed to 3° down and will not vary with airspeed and AOA. Aileron droop is set to 0°. The aircraft is easily controllable at normal cruise speeds. Remain subsonic and below 350 knots to maintain control system stability. Remain below 10° AOA to preclude departure. Transition to or from the landing configuration should be performed at 200 knots. The FLAPS light comes on and a CRUIS advisory is displayed on the DDI.

With the FLAP switch in HALF, remain below 200 knots and 15° AOA. Flight at 8.1° AOA results in best control characteristics. Refer to Chapter 11 for details. The leading edge flaps are fixed at 17° and will not vary with airspeed and AOA. The trailing edge flaps and aileron droop are fixed at 30°. The yellow FLAPS light comes on and a LAND advisory is displayed on the DDI. With the wings unlocked, aileron droop is set to 0°.

After transition with the FLAP switch in FULL, aircraft should remain below 160 knots and 12° AOA. Flight at 8.1° AOA results in best control characteristics. Refer to Chapter 11 for details. The leading edge flaps are fixed at 17° and will not vary with airspeed and AOA. The trailing edge flaps are fixed to 43° to 45° and the aileron droop is set to 42°. The FLAPS light comes on and a LAND advisory is displayed on the DDI. With the wings unlocked, aileron droop is set to 0°.

NOTE

- Stalls occur at a lower AOA with GAIN ORIDE selected due to fixed flap positions. Rotation following a bolter or touch and go will be sluggish due to a fixed rudder position.
- Alpha tone is disabled with GAIN ORIDE selected with FLAP switch in HALF or FULL.

2.8.4.3 Flap Position Lights. The HALF, FULL, and FLAPS lights are on the main instrument panel. A green light indicates the aircraft is within flight parameters for the flight control computer to

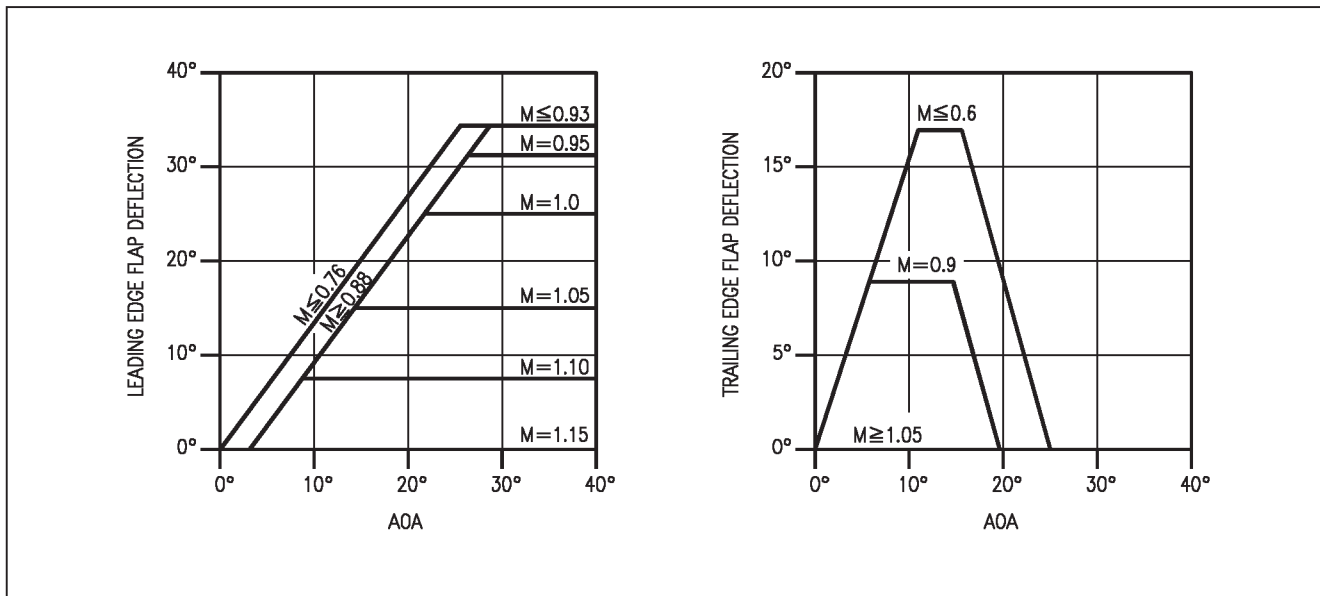

18AC-NFM-00-(15-1)31-CATI

Figure 2-15. Flap Schedules

adjust flap scheduling in accordance with the selected switch position. These lights, whether amber or green, should not be used as an indication of flap position. Actual flap position can only be verified by selecting the FCS display.

INDICATION	FLAP SWITCH POSITION
HALF (green)	FLAP switch in HALF and airspeed below 250 knots.
FULL (green)	FLAP switch in FULL and airspeed below 250 knots.
FLAPS (amber)	FLAP switch HALF or FULL and airspeed over 250 knots, abnormal flap condition (any flap is off or lacks hydraulic pressure), in spin recovery mode, or GAIN switch in ORIDE position.

2.8.4.4 CK FLAPS Caution Display. The CK FLAPS DDI caution is displayed at takeoff when the FLAP switch is in AUTO.

2.8.4.5 FCS Cautions

2.8.4.5.1 FCES Caution Light. The FCES (flight control electronic set) caution light, on the caution lights panel, comes on if any flight control function is lost or if there are three Xs in the same row.

2.8.4.5.2 FCS Caution Display. The FCS caution, on the DDI, is displayed anytime a failure in the flight control system occurs. If the failure is transient and can be reset, pressing the FCS RESET button removes the failure indication (Xs) from the FCS status page, displays the RSET advisory, and removes the FCS caution. If the failure does not reset, the failure indication remains displayed on the FCS status page along with the Xd out RSET advisory, and the FCS caution is removed. The FCS caution is displayed again if another flight control system failure occurs.

2.8.4.5.3 AIL OFF Caution Display. Either aileron off.

2.8.4.5.4 AUTO PILOT Caution Display. Uncommanded autopilot disengagement.

2.8.4.5.5 CHECK TRIM Caution Display. Horizontal stabilators not trimmed for takeoff.

2.8.4.5.6 DEL ON Caution Display. Any axis in digital DEL.

2.8.4.5.7 FC AIR DAT Caution Display. Left and right air data probes disagree.

2.8.4.5.8 FCS HOT Caution Display. Flight control computer A and/or right transformer-rectifier not receiving adequate cooling air.

2.8.4.5.9 FLAPS OFF Caution Display. Any flap off.

2.8.4.5.10 FLAP SCHED Caution Display. Flaps are not scheduling properly (see Chapter 15 discussion)

2.8.4.5.11 G-LIM 7.5 G Caution Display. G limiter set at +7.5 g symmetrical regardless of gross weight or stores loading.

2.8.4.5.12 G-LIM OVRD Caution Display. G limiter overridden. 133 % of design limit g is possible.

2.8.4.5.13 MECH ON Caution Display. Stabilator mechanically controlled.

2.8.4.5.14 NWS Caution Display. Flashing (on HUD) - loss or partial loss of HYD 2 pressure. Steady (on DDI) - nosewheel steering inoperative.

2.8.4.5.15 R-LIM OFF Caution Display. Wing pylon mounted air-to-ground stores or tanks set in armament computer with rack hooks for those stores closed or all stores HUNG and roll rate limiter inoperative. Do not exceed 1/2 lateral stick. Roll sensitivity is increased.

2.8.4.5.16 RUD OFF Caution Display. Either rudder off.

2.8.4.6 Voice Alert. Any FCS caution except CHECK TRIM, FCS, NWS, FC AIR DAT, G-LIM OVRD, or R-LIM OFF is accompanied by a “flight controls, flight controls” voice alert. An FCS HOT caution is accompanied by a “flight computers hot, flight computers hot” voice alert.

2.8.4.7 FCS Status Display. An FCS status display (figure 2-16) may be selected on a DDI. At top center, the display presents left and right leading edge flap (LEF), trailing edge flap (TEF), aileron (AIL), rudder (RUD), and stabilator (STAB) positions in degrees with arrows which indicate the direction from neutral. For example, the control positions shown in the figure are: left LEF 1° leading edge down, right LEF 1° leading edge down, left TEF 5° trailing edge down, right TEF 5° trailing edge up, left AIL 15° trailing edge down, right AIL 15° trailing edge up, both RUD 0°, left STAB 3° trailing edge down, right STAB 4° trailing edge up. The tolerance for all control position indications is $\pm 1^\circ$. The numbers and arrows change as control surface deflections change. At 0° (neutral), the arrows may point in either direction. A blank is displayed where the number is unreliable.

An X through the LEF, TEF, AIL, or RUD number, also referred to as a bold X, indicates that control surface is no longer being commanded by the FCC. A bold X through the stab number without a MECH ON caution indicates the FCC has detected one of the STAB’s two hydraulic power sources has failed and the STAB may be hinge-moment limited in a small portion of the flight envelope. A bold X through both the left and right STAB number, and the mech on caution, indicates the FCS has reverted to MECH mode.

On either side of the position indicators are boxes which represent the FCS channels. On the left side, reading left to right, the boxes represent channels 1 and 4 for the LEF, AIL, and RUD and 1 2 3 4 for the TEF and STAB. An X in one of these boxes indicates that the FCS is no longer using that channel to command the actuator due to a failure. On the right side, reading left to right, the boxes represent channels 2 and 3 for the LEF, AIL, and RUD and 1 2 3 4 for the TEF and STAB. On the lower right side of the DDI are boxes which display the status, by channel, of the CAS pitch (P), roll (R), and yaw (Y); the stick position sensors (STICK), the rudder pedal force sensors (PEDAL); the angle of attack sensing (AOA); the backup air data sensor assembly (BADSA); and the processor (PROC); and on F/A-18A AFTER AFC 253 OR 292, and F/A-18C/D, the normal accelerometer (N ACC) and lateral accelerometer (L ACC). An X opposite one of these components indicates a failure in the channel with the X. An X opposite degraded (DEGD) indicates a switch failure or, for the TEF and STAB, a single shutoff valve failure. Flight controls are not affected but the FCS should be reset.

NOTE

Except for the LEFs, the control surface position may fail to match the commanded position without indication to the aircrew.

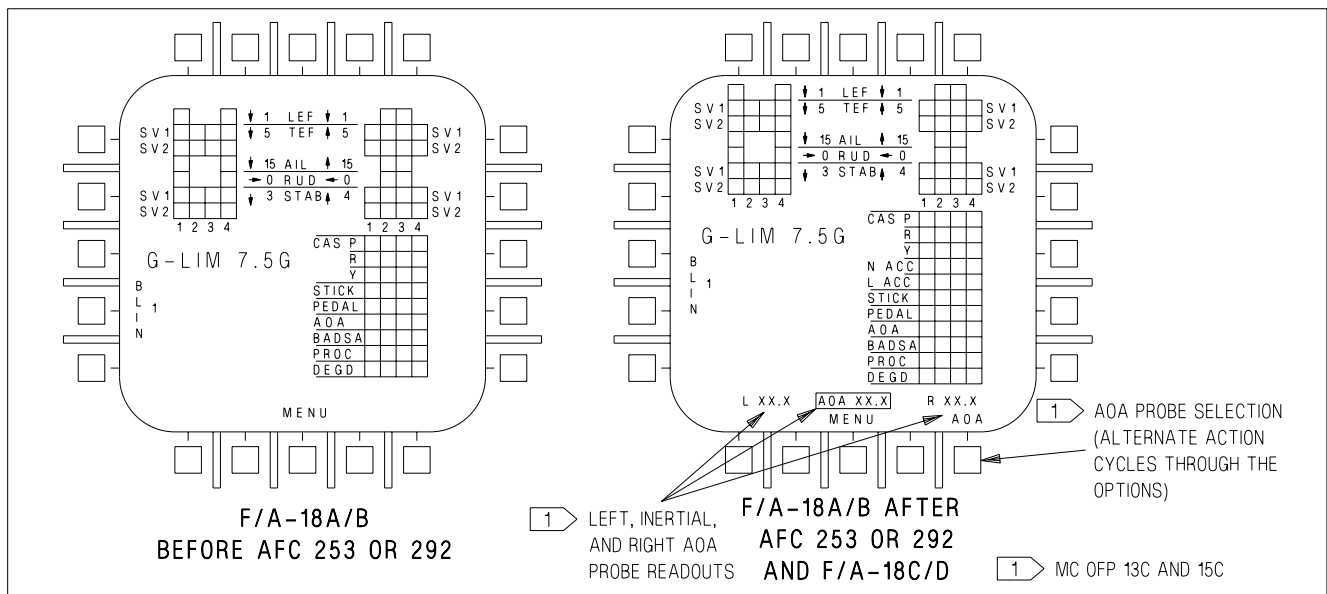

ADA520-341-1-045

Figure 2-16. FCS Status Display

NOTE

An X in both CH1 and CH3 of PROC row indicates INS data is not being provided to the FCCs for sideslip and AOA estimation calculations. There is no significant degradation to flying qualities, departure resistance or roll performance with these failure indications. (Above approximately 30° AOA in Flaps AUTO, the FCCs use INS data for sideslip and sideslip-rate feedback to provide roll coordination and departure resistance. If INS data is not available, sideslip control, departure resistance and roll performance may be slightly degraded). The PROC Xs in CH 1/3 may be caused by: an INS failure, accompanied by an INS ATT caution; by placing the ATT switch to STBY; or by an FCC-detected failure.

BLIN code display may be selected by channel. The calculated symmetrical positive g limit is displayed at the left center. An X over the value is displayed when a G-LIM 7.5 caution is present, fuel state is less than 3,300 pounds, or gross weight is over 44,000 pounds. The word INVALID replaces the G-LIM display when the FCS Status Display is unreliable. With MC OFP 13C AND 15C, left, inertial and right AOA probe readouts are presented at the bottom of the display only when AOA is valid. In GAIN ORIDE, with MC OFP 17C AND UP, the AOA probe selection button allows L, R or Inertial AOA readout to be boxed and selected, even when AOA has been declared invalid (if AOA is invalid the L and R readouts have an X across them). With MC OFP 13C AND UP, the L (left) and R (right) probe values, along with the INS (center) AOA value, are presented at the bottom of the display. In GAIN ORIDE, as long as the ADC continues to declare the AOA value (probe split <15.5°), the AOA probe selection button allows the L or R probe to be boxed and selected. The selected probe will drive the HUD E-bracket display and the INS provides the HUD AOA numeric.

2.8.4.8 Speedbrake. The speedbrake is mounted between the vertical stabilizers. It is controlled by a throttle mounted switch using left 28 volt dc bus power. It is powered by the HYD 2A system.

Airborne, when in the AUTO FLAPS UP mode, the speedbrake automatically retracts above 6.0 g or above 28° AOA and, when not in the auto flaps up mode, below 250 knots. For aircraft 161702 AND UP, the speedbrake extends with the flaps HALF or FULL so long as the switch is held in EXTEND. This is not recommended. The speedbrake operates normally on the ground.

2.8.4.8.1 Speedbrake Switch. The speedbrake switch is on the right throttle grip and has three unmarked positions.

Aft detent	Extends the speedbrake as long as the switch is held aft. Springloaded to center detent.
Forward detent	Retracts the speedbrake or maintains the speedbrake retracted and prevents creep.
Center detent	Stops the speedbrake in any position. The speedbrake may slowly creep open.

2.8.4.8.2 SPD BRK Light. The SPD BRK light, on the main instrument panel, comes on anytime the speedbrake is not fully retracted.

2.9 AUTOMATIC FLIGHT CONTROL SYSTEM (AFCS)

The automatic flight control system (autopilot) has two basic modes: pilot relief and data link. The pilot relief mode consists of heading hold, heading select, attitude hold, barometric altitude hold, radar altitude hold, control stick steering (CSS) and coupled steering. The data link mode consists of automatic carrier landing (ACL), precision course direction, and vector approach. With MC OFP 13C AND UP, the coupled steering consists of azimuth steering line couple (ASL), bank angle control (BNK), coupled waypoint steering (WYPT), coupled auto sequential steering (SEQ ()), and coupled TACAN steering (TCN). Refer to NTRP 3-22.4-FA18A-D NATIP and NTRP 3-22.2-FA18A-D NATIP for ASL and BNK information. Control of the automatic flight control modes is accomplished by the switches on the up front control (UFC), heading set switches on the heading and course set switches panel, and the autopilot disengage/nosewheel steering switch on the control stick (see figure 2-17). Before any mode can be selected bank must be less than or equal to 70°, pitch must be less than or equal to 45°, and the A/P pushbutton must be pressed. Selection of the A/P pushbutton displays the pilot relief options of: ATTH (attitude hold), HSEL (heading select), BALT (barometric altitude hold), RALT (radar altitude hold), and the CPL (coupled steering) option (if available) in the UFC option display windows. When a pilot relief option is selected via the UFC a colon (:) appears in front of the selected display and the selected mode appears on the DDI advisory display. If an option is not available, it is not displayed. When the CPL option is selected on the UFC, the flight controls will couple to that steering mode (in azimuth only). A bank limit, BLIM option, is available on the A/C DATA display. NAV BLIM sets a 30° fixed bank limit. TAC BLIM limits the bank angle between 30° and 60°, based on airspeed. An overfly (OVFLY) option is available on the WYPT DATA display. OVFLY is used during auto sequential steering when it is desired to overfly the waypoint, otherwise the aircraft will turn prior to the waypoint to capture the course to the next waypoint.

2.9.1 AFCS Caution and Advisory Displays. The following autopilot related caution and advisory displays may appear on the DDI:

CAUTION**MEANING**

AUTO PILOT Autopilot did not engage or A/P disengaged after it was selected for any reason except pilot actuation of the paddle switch. The caution is removed after 10 seconds or when the paddle switch is actuated. The autopilot can be commanded out of the BALT or RALT hold mode by CSS.

ADVISORY**MEANING**

A/P An autopilot mode is selected.

ATTH Attitude hold mode is selected.

BALT Barometric altitude hold mode is selected.

CPLD Coupled steering, automatic carrier landing (ACL), azimuth steering line (ASL), or bank angle control (BNK), is selected.

HSEL Heading select mode is selected.

RALT Radar altitude hold mode is selected.

2.9.2 Pilot Relief Modes

2.9.2.1 Autopilot. The basic autopilot (heading hold) is engaged by selecting the A/P pushbutton (at which time pilot relief options appear on the UFC) then selecting the ON/OFF pushbutton. Engagement is indicated by the A/P advisory on the DDI. Selecting the ON/OFF pushbutton is not required if ATTH, HSEL, BALT, RALT, or CPL (MC OFP 13C AND UP) option on the UFC is desired.

WARNING

Decolonizing any autopilot mode does not disengage the basic autopilot control stick steering (CSS) function. Activating the autopilot/nosewheel steering disengage lever (paddle switch) on the control stick with any autopilot mode selected disengages all autopilot modes. Failure to disengage autopilot modes with the paddle switch prior to landing (other than mode 1) results in CSS remaining engaged and may cause extreme aircraft pitch/PIO oscillations.

At this time the aircraft maintains the existing pitch attitude. If roll attitude is less than or equal to $\pm 5^\circ$ at engagement, the magnetic heading is maintained. If roll attitude at time of engagement is greater than $\pm 5^\circ$, the roll attitude is maintained. The pitch attitude hold reference can be changed with pitch CSS to any value between $\pm 45^\circ$ pitch. The pitch attitude reference can also be changed with the trim switch on the control stick at a rate of $0.5^\circ/\text{second}$. The roll attitude hold reference (if roll is greater than $\pm 5^\circ$) can be changed with roll CSS to any value between 5° and 70° of roll. The roll attitude reference can also be changed using the trim switch on the stick at a rate of $2^\circ/\text{second}$. The

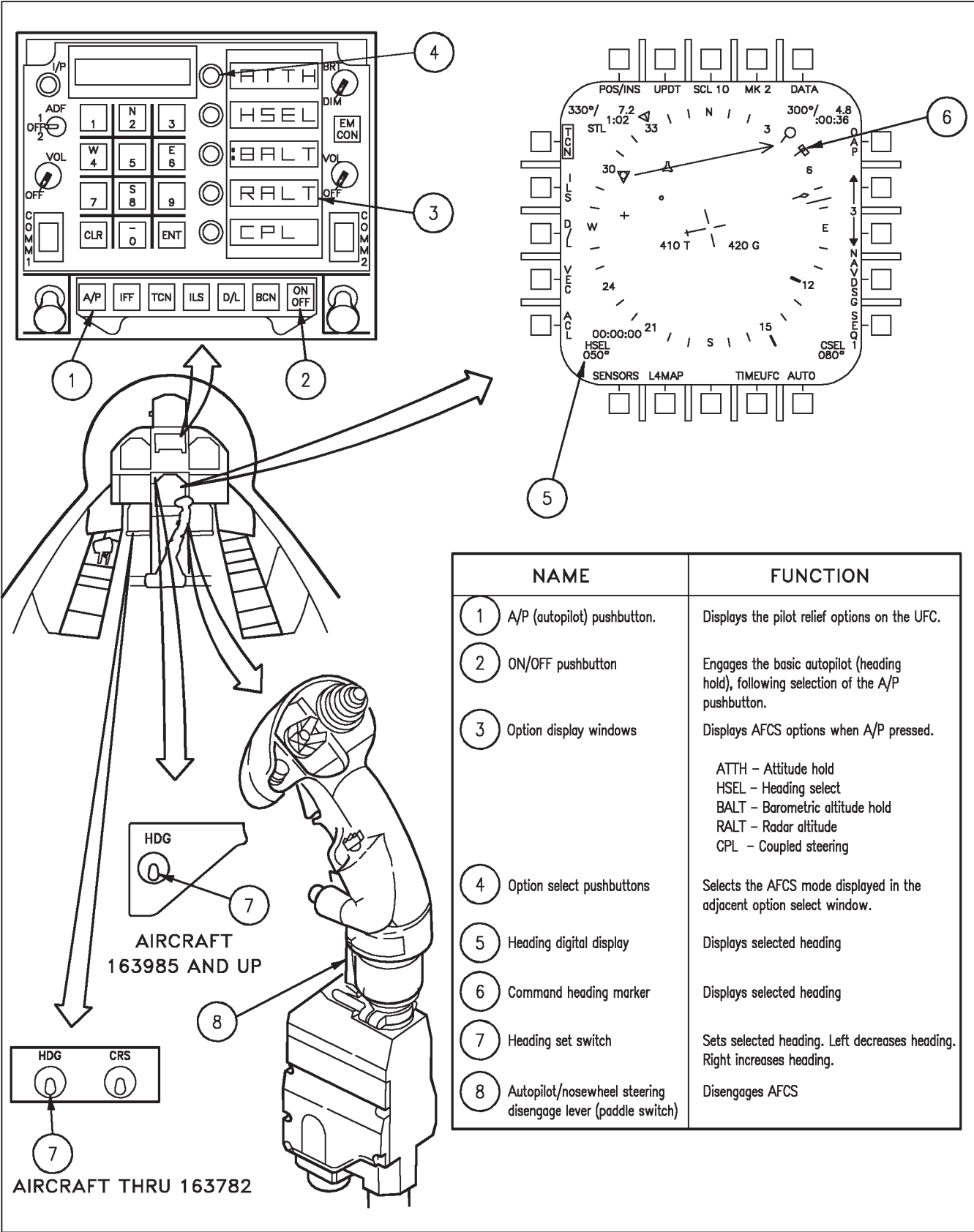

Figure 2-17. AFCS Controls and Indicators

magnetic heading reference (if roll is less than or equal to $\pm 5^\circ$) can be changed, or initially set with roll CSS. The roll trim switch also can change the reference magnetic heading.

NOTE

Pitch trim is reset to 8.1° AOA anytime the autopilot is disengaged while in the PA configuration, if AOA is greater than 6.0° .

2.9.2.2 Attitude Hold. Attitude hold is engaged by pressing the option pushbutton next to the option display window displaying ATTH. Engagement is indicated by a colon in the ATTH option window. At this time the aircraft maintains the existing pitch and roll attitude. The pitch attitude hold reference can be changed to any value between $\pm 45^\circ$ with pitch CSS or with the trim switch on the control stick (0.5° /second). The roll attitude hold reference can be changed to any value between $\pm 70^\circ$ with roll CSS or with the trim switch on the stick (2° /second).

2.9.2.3 Barometric Altitude Hold. To establish barometric altitude hold, press the button next to the option display window displaying BALT. The existing barometric altitude at time of engagement is captured and maintained. Heading or attitude hold is maintained, depending upon which mode was previously engaged. The operating range is 0 to 70,000 feet. ATTH, CPL (MC OFP 13C AND UP), or HSEL can be selected with BALT to provide lateral control. CSS causes reversion to heading or attitude hold, depending upon which was previously engaged.

2.9.2.4 Heading Select. To establish heading select mode, select the desired heading on the HSI display by using the heading set switch, located to the left of the center DDI. Press the button next to the option display window displaying HSEL. The aircraft turns from existing heading through the smallest angle to the selected heading. Heading hold is reestablished after the selected heading is captured. Existing pitch attitude is maintained. CSS is available.

2.9.2.5 RADAR Altitude Hold. To establish radar altitude hold, press the pushbutton next to the option display window displaying RALT. Engagement is indicated by a colon appearing in the window next to RALT. The existing radar altitude is maintained upon engagement. Radar altitude hold coverage is from 0 to 5,000 feet. If no other mode is selected, the lateral axis control remains in heading hold. In this configuration, either CSS or the roll trim switch can be utilized with automatic turn coordination up to 45° with altitude maintained. ATTH, CPL (MC OFP 13C AND UP) or HSEL can be selected with RALT to provide lateral control.

2.9.2.6 Coupled Steering (MC OFP 13C AND UP). The coupled steering options are: WYPT, OAP, SEQ#, and TACAN range bearing. To engage coupled steering, the desired steering option must be available and selected on the HSI display, MC1 must be communicating with the FCS, then press the pushbutton next to the UFC option display window displaying CPL. Engagement is indicated by a colon appearing in the window next to CPL and a CPLD advisory on the DDI. The flight controls are coupled (azimuth only) to whatever active steering mode that has been selected (boxed) on the HSI display. Once coupled steering is engaged attitude hold and heading select A/P options are not available. CSS is available in pitch only. Lateral stick displacement greater than 0.5 inch causes the autopilot to decouple from the steering mode. Great circle course can be selected to the fly-to-point, or a selected radial (course line) through the fly-to-point. If course line is selected prior to the fly-to-point, flight controls capture the selected radial, overfly the fly-to-point and continue on the out bound radial. A coupled bank limit option is available on the A/C data display and allows the pilot to select TAC or NAV bank angle limit mode. Selecting NAV limits the bank angle to a maximum of 30° . Selecting TAC limits the bank angle to a maximum of 30° to 60° (depending on airspeed). Refer to

Chapter 24 for detailed navigation steering information under Waypoint/OAP, Auto Sequential, and TACAN Steering.

2.10 LANDING SYSTEM

The landing system is made up of the landing gear, nosewheel steering, brakes, launch bar, and arresting hook.

2.10.1 Landing Gear System. The landing gear system is electrically controlled and hydraulically operated. The main gear is retracted aft into the fuselage and the nose gear is retracted forward. When the gear is extended, all gear doors remain open.

2.10.1.1 Landing Gear Control Handle. The landing gear is controlled by a two-position, wheel-shaped handle on the lower left side of the main instrument panel. Two conditions must be met before the gear can be raised: the aircraft must sense that weight is off all three landing gear and the launch bar must be retracted. When these conditions are met, the landing gear is raised by moving the handle up. If the launch bar is extended when the handle is raised, the main gear retracts but the nose gear remains extended. When the aircraft senses weight on any of the three landing gear, a mechanical stop in the landing gear control panel extends preventing movement of the handle from DN to UP. Moving the handle down lowers the gear.

2.10.1.2 Down Lock Override Button. The down lock override button is located to the left of the landing gear control handle. If the mechanical stop remains extended after takeoff preventing movement of the handle from DN to UP, a failure has occurred in the landing gear handle down lock circuit. Pressing and holding the DOWN LOCK ORIDE button retracts the mechanical stop from the landing gear control handle allowing it to be moved from DN to UP. The landing gear control handle must be full DN to allow the mechanical stop to properly engage upon landing. If the DOWN LOCK ORIDE button is pressed or the mechanical stop is not fully engaged in the landing gear control handle, the handle can be moved to UP on the ground and the gear will retract.

2.10.1.3 Weight-On-Wheels (WOW) System. Numerous aircraft systems function differently depending upon whether the aircraft is on the ground or is airborne. The most important of these functions include: various flight control laws, landing gear operation, master arm and stores jettison, fuel dump operation, AOA HUD indexers and approach lights, Automatic Throttle Control (ATC) and autopilot operation, pitot static, AOA and total temperature probe heating, fuel tank pressurization, and the inflight IDLE and afterburner lockout throttle stops. To determine when the aircraft is on the ground, a proximity switch on each gear indicates when there is weight on each of the wheels. There are a variety of failure conditions which may result in false indications of WOW or weight off wheels. These include: a misrigged landing gear WOW proximity switch, a WOW proximity switch failure, an improperly serviced landing gear strut, a landing gear control unit failure, or a problem with the aircraft wiring.



An uncommanded pitch up after takeoff may occur if a WOW system failure results in the aircraft sensing weight on wheels while inflight.

The first indication of the aircraft sensing WOW while inflight is the inability to raise the landing gear handle. Other possible indications include the CHECK TRIM caution, NWS on the HUD, and the CK FLAPS caution if the FLAP switch is moved to AUTO. The aircraft may then quickly undergo an

uncommanded pitch up which is caused by the large stabilator deflection present at takeoff. Normally, the stabilator deflection would be trimmed out automatically by the flight control system. As airspeed increases, the uncommanded pitch up rate increases. Maintaining airspeed as slow as practical helps control nose pitch up and assists in lowering the aircraft's nose. Above 180 knots, full forward stick alone does not stop aircraft nose up rotation, so nose down trim is required to regain control of the aircraft. The FLAP switch should also remain in HALF since the pitch up rate increases if the FLAP switch is moved to AUTO.

2.10.1.4 Landing Gear Warning Lights/Tone. The landing gear warning light is a red light in the gear handle. The light comes on when the gear is in transit and remains on until all three gear are down and locked when DN is selected, or all the gear doors are closed when UP is selected. The light remains on with the gear down and locked if the left or right main landing gear planing link is not locked. When the landing gear handle light has been on for 15 seconds the landing gear aural tone also comes on.

NOTE

Aircraft equipped with LGCU-01 do not provide an aural tone to the aircrew.

In addition, the gear handle light functions as a wheel warning in conjunction with a warning tone. The gear handle light flashes and a continuous rate beeping tone sounds when the gear handle is in the UP position, the aircraft is below 175 knots, altitude is less than 7,500 feet and rate of descent is greater than 250 feet per minute.

NOTE

The loss of calibrated airspeed and/or barometric altitude data results in activation of the landing gear handle warning light and tone. First reference the applicable standby airspeed or altitude indicator, then silence the tone.

The warning tone may be silenced by pressing the warning tone silence button next to the gear handle.

2.10.1.5 Landing Gear Position/Planing Link Failure Lights. There are three green landing gear position lights marked NOSE, LEFT and RIGHT, above the landing gear control handle. The lights indicate that the gear is down and locked, or that a planing link is not locked. The NOSE gear light comes on steady when the nose gear is down and locked. The LEFT and RIGHT lights come on steady when their respective gear is down and locked and flash if the gear is down and locked but a related planing link is not locked. On F/A-18A/C/D 163146 AND UP; ALSO F/A-18A/B 161353 THRU 163145 AFTER ASC 030, the planing link failure lights is accompanied by a continuous rate beeping tone.



Visual inspection does not confirm locked gear, only obvious damage and general position of gear.

2.10.1.6 Emergency Gear Extension. Emergency gear extension is done by rotating the gear handle 90° clockwise and pulling (approximately 1.5 inches) to the detent where the handle locks in place. This can be done with the handle in either UP or DN; however, the handle must be rotated 90° before

it is pulled. Rotating and pulling the gear handle opens the valves for the emergency landing gear control, the APU accumulator and the emergency brake accumulator. The nose landing gear extends by free fall aided by airloads, and the main landing gear extends by free fall aided by the side brace downlock actuator and the compressed shock absorber. If gear indicates unsafe following emergency extension, it may be the result of the APU accumulator arming valve not opening. Another way to open the APU accumulator arming valve is to emergency extend the IFR probe.

2.10.2 Nosewheel Steering System. The nosewheel steering system is a combination shimmy damper and dual mode steering system. It is electrically controlled by two switches on the stick grip and hydromechanically operated through inputs from the rudder pedals and flight control computers. With the flight control computers operating, momentarily pressing the nosewheel steering button activates and engages nosewheel steering in the low mode ($\pm 16^\circ$) and NWS is displayed on the HUD. Holding the nosewheel steering button pressed selects the high mode ($\pm 75^\circ$) and NWS HI is displayed on the HUD. With the wing handle unlocked and nosewheel steering in the low mode, pressing the nosewheel steering button causes the nosewheel steering to go to the high mode where it remains without holding the button pressed. Momentarily pressing the autopilot disengage switch (paddle switch) disengages nosewheel steering until reengaged by the nosewheel steering button. If the launch bar is extended, nosewheel steering is disengaged, however, the low mode may be engaged by pressing and holding the nosewheel steering button. On the ground, nosewheel steering is disengaged when power is removed from the aircraft. Nosewheel steering is also disengaged with weight off the nose gear. During landing, nosewheel steering is automatically engaged in the low mode with weight on the nose gear.

NOTE

Reversion of NWSHI to NWS (low gain) occurs within 4 to 60 seconds after touchdown due to LGCU BIT. NWSHI can be reselected.

If the high mode is desired during taxi, press and hold the nosewheel steering button. If the nosewheel steering system fails, NWS and FCS are displayed on the DDI as cautions, the MASTER CAUTION light comes on, and the NWS or NWS HI display is removed from the HUD. When failed, the nosewheel steering system reverts to a free swivelling mode.

NOTE

With a channel 2 or 4 FCS failure, normal nosewheel steering is lost. Emergency HI gain steering can be regained by pulling the failed channel circuit breaker, unlocking the wings, and pressing the nosewheel steering button. When the emergency HI gain NWS mode is entered, NWS indications may not be displayed on the HUD. If pressing the NWS button results in an FCS caution and single X in the powered channel, emergency HI gain is not available.

2.10.3 Brake System

2.10.3.1 Normal Brake System. The main landing gear wheels have full power brakes operated by toe action on the rudder pedals. An anti-skid system is combined with the normal system to prevent wheel skid. Normal brake pressure is supplied by HYD 2A. The anti-skid system modulates pilot demanded brakes to prevent tire skid.

2.10.3.2 Anti-Skid System. The anti-skid system is electrically controlled by a two position switch on the lower left portion of the instrument panel. The switch is lever-locked to OFF. A SKID advisory

display on the DDI is displayed if the landing gear is down and anti-skid ON is not selected. If anti-skid fails, the DDI displays ANTI SKID as a caution and the MASTER CAUTION light comes on. A touchdown protection circuit prevents brake application on landing until wheel speed is over 50 knots, or if a wet runway delays wheel spin-up, 3 seconds after touchdown. A locked wheel protection circuit releases the brakes if the speed of one main wheel is 40 % of the other main wheel. The locked wheel protection circuit is disabled at about 35 knots. The anti-skid system is totally disabled below 10 knots.

Anti-skid protection is bypassed when the ANTI SKID switch is off. Normally limited by the anti-skid system, 3,000 psi hydraulic brake pressure is available and regulated only by pilot brake pedal forces. When using brakes at high speed without anti-skid protection, there is a very small margin between effective braking and blown tires. Any force greater than approximately 55 to 60 lbs applied to the pedals (6° to 7° of pedal rotation) will likely result in blown tires with either the ANTI SKID switch OFF or emergency brakes selected. The use of normal (anti-skid off) brakes at high speed should be done with extreme caution. If braking without anti-skid is needed at high speeds, initially apply very light brake pedal pressure and gradually increase as required.

WARNING

Use of brakes without anti-skid at high speed can result in blown tires resulting in loss of directional control. If practical, rollout speed should be as slow as possible before applying brake pedal pressure.

CAUTION

ANTI SKID caution does not reappear and brakes may not be available for 13.5 seconds after cycling anti-skid switch inflight or 9.5 seconds during landing rollout, until BIT is completed.

NOTE

Hot brakes can be expected any time maximum effort braking is used with or without anti-skid at heavy gross weights (e.g., takeoff abort, or heavy landing).

2.10.3.3 Emergency Brake System. The emergency brake system uses normal system brakes with independent hydraulic lines carrying emergency hydraulic pressure to the brake shuttle valve. The system is activated by pulling the emergency/parking brake handle out to the detent. The emergency brake system is powered by the HYD 2B system or the brake accumulator backed up by the APU accumulator. Brake accumulator pressure is shown on a pressure gage on the lower left corner of the main instrument panel and is redlined to indicate pressure below 2,000 psig. However, an indication of 2,000 psig does not mean the onset of degraded braking. It is a warning that there are five full brake applications remaining before BRK ACCUM is displayed on the DDI as a caution and the MASTER CAUTION light comes on. This caution is displayed at 1,750 psi and represents the worst condition (maximum temperature) where the brake accumulator may be empty. When emergency brakes are selected, anti-skid is deactivated even if normal HYD 2A braking is available. No warning/caution is displayed for emergency brake selection. The system is deactivated by pushing the emergency/parking

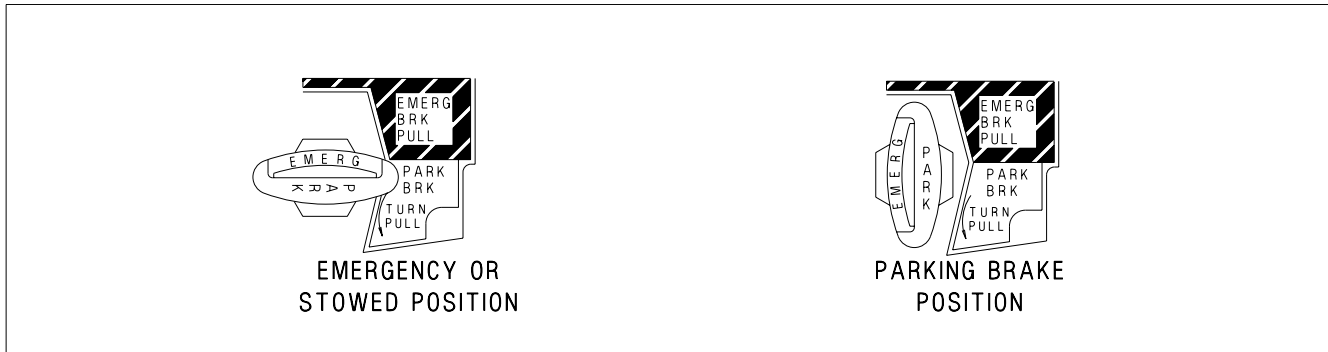

ADA520-18-1-045

Figure 2-18. Emergency/Parking Brake Handle

brake handle back into the stowed position. The handle must be fully stowed (F/A-18B/D both cockpits) to ensure anti-skid is available.



Due to system friction, the emergency parking brake handle may not return to the stowed position without pilot assistance (positive push) during the last part of its travel. If the handle is not fully stowed after selecting emergency brakes, the emergency brake system remains selected. Normal brakes and anti-skid protection cannot be regained until the handle is fully stowed.

2.10.3.3.1 Emergency/Parking Brake Handle. The combination emergency/parking brake handle (figure 2-18) is on the lower left corner of the main instrument panel. The handle is shaped such that EMERG is visible to the pilot when the handle is in the stowed or emergency position and PARK is visible to the pilot when the handle is rotated to the park position.

2.10.3.4 Parking Brake System. The parking brake system uses the same hydraulic lines, accumulators and actuation handle as the emergency brake system. The system is activated by rotating the emergency/parking brake handle 90° counterclockwise from the horizontal stowed position and pulling it out to a positive locked position. If the emergency brakes have been activated, it is necessary to reposition the handle to the stowed position then rotate it 90° counterclockwise and pull it to the locked position to select parking brakes. This action applies non-regulated pressure to the disc brakes. With the INS on, the parking brake set, and both throttles above about 80 % rpm, the PARK BRK caution and MASTER CAUTION come on. To release the parking brake, rotate the emergency/parking brake handle 45° counterclockwise from the extended position. This releases the lock and allows the handle to return to the horizontal stowed position.

2.10.4 Launch Bar System. The launch bar is hydraulically extended and retracted by redundant springs. A locking tab mechanically locks the launch bar in the up position. A two position (EXTEND and RETRACT) launch bar switch on the lower left corner of the main instrument panel controls launch bar operation. As the launch bar extends the green L BAR advisory light comes on. When the launch bar is fully extended it is held against the deck by deck load control springs. The control springs allow vertical movement of the launch bar during taxi. As the aircraft is taxied into the launch gear the launch bar drops over the shuttle and is held captive in the extended position as the shuttle is tensioned. On aircraft 161353 THRU 161715, when both throttles are advanced to or above MIL, a throttle switch is made, the green L BAR advisory light goes out and the launch bar switch returns to

RETRACT. Before AFC 081, if the launch bar switch is not deenergized to RETRACT after the throttles are advanced to MIL, the red L BAR warning light comes on. On aircraft 161716 AND UP, the launch bar switch does not return to RETRACT when both throttles are advanced to MIL or above. The green L BAR advisory light goes out when the switch is placed to RETRACT. If the red L BAR warning light is on with the switch in RETRACT, an electrical fault exists which prevents launch bar retraction after launch. At the completion of the catapult stroke, launch bar/catapult separation occurs and the return springs cause launch bar retraction which allows the landing gear to be retracted. If the launch bar fails to retract after the aircraft is launched, the red L BAR warning light comes on and the nosewheel does not retract. A launch bar circuit breaker is on the left essential circuit breaker panel and when pulled deenergizes the launch bar electrical system.

NOTE

Failure to place launch bar switch to retract may result in hydraulic seal failure.

2.10.5 Arresting Hook System. The arresting hook system consists of a retract actuator/damper, fail safe manual latch and release, universal hook shank pivot and replaceable hook point. Hook control is a manual system which automatically extends the hook in case of a failure of the release system. The arresting hook handle and hook light are on the lower right main instrument panel. The hook light remains on except when the hook is up and latched or is fully down. Hook extension is a free fall action assisted by a nitrogen charge in the actuator cylinder. Hook motion is dampened laterally by a liquid spring in the hook shank and vertically by the damper in the retract actuator cylinder which minimizes hook bounce and provides hold down force for arresting cable engagement.

Without proper N₂ pre-charge (insufficient arresting hook snubber pressure), the arresting hook does not fully extend due to HYD 2 backpressure and airloads. If the arresting hook fails to extend as a result of this condition, shutting down the right engine reduces HYD 2 backpressure and allows sufficient extension (35° compared to 56° normal).

2.10.5.1 Arresting Hook Handle. To extend the arresting hook, place the arresting hook handle down. The HOOK light comes on when the hook is in transit and goes out when the hook reaches the selected position. The light remains on if the hook is in contact with the deck and is prevented from reaching the hook down proximity switch. The HOOK light remains on any time the hook position does not agree with the handle position.

2.11 WING FOLD SYSTEM

Each outer wing panel is folded upward to a vertical position by a wing fold mechanical/electrical drive. A wing fold unlock flag in the upper surface wing fold area provides a visual indication of the wing lock pins in the unlocked position. The wing lock control and wing fold/spread control are combined in the wing fold handle on the lower right main instrument panel. A wing safety switch is located so that a safety pin can be manually installed from the underside of the wing when absolute prevention of wing fold or spread is desired. The ailerons are locked in neutral when the wings are folded.



To avoid damaging the flaps, ensure ailerons are not faired inboard prior to raising the flaps, conducting IBIT, or running FCS exerciser. Proper aileron position can be determined either visually or by verifying an aileron position of 0 or down arrow on the FCS page.

2.11.1 Wing Fold Handle. Normal folding and spreading the wings is accomplished through operation of the wing fold handle. To fold the wings, press the detent on the underside of the wing fold handle, pull out and rotate counterclockwise to FOLD. The MASTER CAUTION light comes on, a WING UNLK display appears on the DDI and the wing fold unlock flag appears. To spread the wings, rotate the wing fold handle clockwise to SPREAD. To lock the wings after they have fully spread, push the handle in. Wait 5 seconds after wings are fully spread before placing the WING FOLD handle to LOCK. When the lock pins are in place the WING UNLK display on the DDI disappears and the wing fold unlock flag is down flush with the top surface of the wing. The wings can be stopped and held in any intermediate position by placing the wing fold handle to HOLD. The ailerons must be faired prior to folding the wings. Normally 115 volts ac operates the wingfold drive unit and hydraulic power fairs the ailerons. However, both of these operations can be accomplished manually. The wings are unlocked by pulling out on the wing fold handle. The drive unit can then be driven with a speed handle through an opening in the lower wing surface just inboard of the trailing edge of the wing fold area.



- Placing the WING FOLD handle to LOCK before the wings are fully spread removes the WING UNLK caution even though the wings are not fully spread and also causes severe damage to the wing fold transmission.
- With wings folded, verify that both ailerons are X'd out before initiating any IBIT or exerciser mode tests. Lack of X'd out ailerons indicates hydraulic pressure is still being supplied to aileron actuator through a leaking swivel valve. IBIT testing without X'd out ailerons can result in damage to aileron hinge. PBIT BLIN 51 or IBIT BLINs 4263 and 70261 may result following IBIT when wings are folded. These BLIN codes do not require maintenance action prior to flight. However, if BLIN 51 does not reset after airborne, wing-fold function may not be available after landing.
- The wingfold control handle should smoothly go into the LOCK position. Forcing the handle could cause damage to the wingfold system.
- A 12 minute cool down period is required before cycling wing fold after two cycles maximum, with or without missiles installed. Failure to allow the cool down period may result in overheat damage to wing fold electric drive unit.

NOTE

- Do not cycle wingfold handle to FOLD until WING UNLK caution is observed.
- A cycle is from the spread position to the fold position and down to the spread position.

2.12 INSTRUMENTS

Refer to foldout section for cockpit instrument panel illustration. For instruments that are an integral part of an aircraft system, refer to that system description in this section.

2.12.1 Pitot-Static System. There are two pitot-static tubes mounted under the nose on each side forward of the nosewheel well. Each tube contains one pitot source and two static sources.

2.12.1.1 Pitot Heater Switch. The pitot heater switch on the ECS panel has positions ON and AUTO.

AUTO	Heaters are on when airborne.
ON	Heaters are on when ac power available.

2.12.1.2 Pitot Pressure. Pitot pressure from the right pitot tube is supplied to the air data computer and the air data sensor channel 2. Pitot pressure from the left pitot tube is supplied to the airspeed indicator and the air data sensor channel 1.

2.12.1.3 Static Pressure. The static sources from each pitot static tube are Td together and this pressure is supplied to the air data computer. The air data sensor channels 1 and 2, on 161520 AND UP, also receive static pressure from this Td static source. On 161353 THRU 161519, channel 1 receives static pressure from the left pitot static tube second source and channel 2 receives static pressure from the right pitot static tube second source. On all aircraft, the standby flight instruments receive static pressure from the left pitot static tube second source when the static source lever is set to NORMAL or from the right pitot static tube second source when set to BACKUP. The static source lever is under the right part of the instrument panel, forward of the right console. With lever in the horizontal position, the selector valve is in NORMAL, with lever in the vertical position, the selector valve is in BACKUP.

2.12.1.4 L/R Pitot HT Caution Display. With pitot heater switch in ON or AUTO while airborne, or in ON on the ground; a L PITOT HT and/or R PITOT HT caution display comes on if a malfunction occurs in the heater circuits.

WARNING

Failure of both AOA (ADSU) probe heaters in icing conditions may cause a sharp uncommanded nose down attitude, uncontrollable by normal stick forces or paddle switch actuation. Selection of gain override may regain stabilator control. Care should be used during recovery above 350 KIAS.

2.12.2 Standby Attitude Reference Indicator. The standby attitude reference indicator (SARI) is a self-contained electrically driven gyro-horizon type instrument. The right 115 volts ac bus normally powers it. If this power fails, an inverter operating off the essential 28 volts dc bus automatically powers it. An OFF flag appears if both power sources fail or the gyro is caged. Ideally the indicator should be in the caged and locked condition prior to application of power. If power has been applied with the indicator in the uncaged condition, wait at least 30 seconds after power application before caging. During caging the gyro initially cages to 4° pitch and 0° roll regardless of aircraft attitude. Caging when the aircraft is in a roll attitude greater than 5° cuts out the roll erection system and the gyro does not

erect properly. After 3 to 5 minutes, the indicator reads 0° in pitch and 0° in roll. Both readings assume the aircraft is straight and level. Pitch display is limited by mechanical stops at approximately 90° climb and 80° dive. As the aircraft reaches a near vertical orientation, the roll display experiences large rotations. An aircraft wings level attitude in the vertical orientation may result in large errors in either pitch or roll, or both. This is normal, and is not an indication of damage or improper function of the indicator. After completion of vertical maneuvers the indicator most likely requires caging in the normal cruise attitude, to eliminate the errors. Vertical maneuvers with a wing down condition of 7° or more usually do not develop significant gyro errors. A needle and ball are at the bottom of the instrument. A one-needle width turn is 90° per minute.

2.12.3 Standby Airspeed Indicator. The standby airspeed indicator displays airspeed from 60 to 850 knots indicated airspeed. It operates directly off left pitot pressure and left static pressure with NORMAL selected by the static source selector lever or right static pressure with BACKUP selected.

2.12.4 Standby Altimeter. The standby altimeter is a counter-pointer type. The counter drum indicates altitude in thousands of feet from 00 to 99. The long pointer indicates altitude in 50-foot increments with one full revolution each 1,000 feet. A knob and window permit setting the altimeter to the desired barometric setting. This setting is also used by the air data computer. The standby altimeter operates directly off the left static pressure with NORMAL selected by the static source selector lever or right static pressure with BACKUP selected.

2.12.5 RADAR Altimeter Set (AN/APN-194(V)). The radar altimeter set indicates clearance over land or water from 0 to 5,000 feet. Operation is based on precise measurement of time required for an electromagnetic energy pulse to travel from the aircraft to the ground terrain and return. Voice alert and/or warning tone and visual warnings are activated when the aircraft is at or below a selectable low altitude limit. The set consists of a receiver-transmitter, individual transmitting and receiving antennas, and a height indicator. The receiver-transmitter produces the energy pulses, transmits the energy to the ground, receives the reflected signal and processes this data for display as altitude by the head-up display unit (HUD) and the height indicator. The height indicator, on the instrument panel, consists of a calibrated scale from 0 to 5,000 feet, a push to test switch, a low altitude index pointer, an altitude pointer, an OFF flag, a low altitude warning light, and a BIT light. Other indicators and controls used with the radar altimeter set are the left or right digital display indicators (DDI) (for BIT checks), an altitude switch, UFC, HI/MPCD/AMPCD (for secondary radar low altitude warning), and the head-up display. The energized position of the emission control (EMCON) switch on the upfront control panel inhibits operation of the radar altimeter.

2.12.5.1 Primary Radar Low Altitude Warning. If the landing gear is up and locked and the radar altitude is less than the Low Altitude Limit index, the primary low altitude warning tone/voice alert is heard in the pilot's headset. With F/A-18A/B before AFC 253 or 292 a "WARNING, WARNING" voice alert is heard. With F/A-18A after AFC 253 or 292 and F/A-18C/D a "Whoop, Whoop" warning tone is heard. The voice alert or warning tone is activated at ground power-up to familiarize the pilot with the warning. When first activated in flight, the warning is continuously repeated until reset or disabled. The warning is reset by setting the low altitude index to an altitude below the present altitude or by climbing to an altitude above the low altitude index setting. The warning can be disabled by

pressing the :RALT button on the UFC or by commanding the UFC to another mode. Once disabled it cannot be triggered until after being reset as described above.

NOTE

With an MC1 failure, the voice alert/warning tone is not sounded when the aircraft descends below the altitude set by the low altitude index pointer.

2.12.5.2 Secondary Radar Low Altitude Warning. A secondary radar low altitude warning function is enabled by entering the appropriate altitude, up to a maximum of 5,000 feet on the UFC. The secondary radar low altitude warning provides a single voice alert warning “ALTITUDE, ALTITUDE” when the aircraft descends through the selected altitude. The warning can be disabled by entering zero feet as the stored altitude. Power up with WOW initializes the stored altitude to zero feet. Refer to part VII for information on entering altitude.

2.12.5.3 Barometric Low Altitude Warning. A barometric low altitude warning function is enabled by entering the appropriate altitude, up to a maximum of 25,000 feet on the UFC. The barometric low altitude warning provides a single voice alert warning “ALTITUDE, ALTITUDE” when the aircraft descends through the selected altitude. The warning can be disabled by entering zero feet as the stored altitude. Power up with WOW initializes the stored altitude to 5,000 feet. Refer to part VII for information on entering altitude. The barometric low altitude warning function does not affect operation of the radar altimeter low altitude warning function.

2.12.5.4 Controls and Indicators.

2.12.5.4.1 Push to Test Switch. Turning this switch clockwise applies power to the set. Further clockwise rotation positions the low altitude index pointer to increasing altitudes. Pushing in on the switch activates the BIT checks.

2.12.5.4.2 Altitude Pointer. This pointer indicates the altitude of the aircraft from 0 to 5,000 feet above the terrain.

2.12.5.4.3 Low Altitude Warning Light. This red light comes on to indicate the altitude pointer (aircraft altitude) is below the altitude set with the low altitude index pointer.

2.12.5.4.4 Low Altitude Index Pointer. This pointer sets the altitude at which the low altitude warning light comes on and the voice alert warning is heard.

2.12.5.4.5 BIT Light. This green light comes on during initiated BIT to indicate that the altimeter set is GO.

2.12.5.4.6 OFF Flag. The OFF flag is in view when the set is off, the pointer indication is unreliable, or the aircraft is more than 5,000 feet above ground level.

2.12.5.4.7 Altitude Switch. The ALT switch, on the HUD control panel, is used to select either radar altitude or barometric altitude for display on the HUD and as the primary altitude source for the mission computer. The switch has positions of BARO and RDR. When the switch is set to RDR (radar), the altimeter altitude followed by an R is displayed in the upper right part of the HUD display. If radar altitude becomes invalid, such as the aircraft exceeding the 5,000 feet AGL radar altimeter limit, barometric altitude is displayed and a B next to the altitude flashes to indicate barometric altitude is

being displayed. There is no cut-out for aircraft bank angle. Radar altitude is displayed until the reflected signal is lost. With large angles of bank and radar selected, erroneous altitudes are displayed.

2.12.5.4.8 BIT Checks. Radar altimeter BIT checks shall be initiated from the BIT display. The checks can also be performed using only the altimeter set height indicator. To manually start the normal BIT from the DDI, press the MENU pushbutton to obtain the menu display and then press the BIT pushbutton to obtain the BIT control display. With MC OFP 10A, press the ICS/IBS/RALT pushbutton. With MC OFP 13C AND UP, BIT can be initiated via ALL, AUTO, or NAV from the top level BIT display. At this time the BIT status message on the BIT display reads NOT RDY if the BIT is initiated during radalt time-in. If the BIT is initiated after time-in is completed, the BIT status reads GO indicating the radalt is operating correctly, RESTRT if the BIT is not completed within time limits, or DEGD if a WRA fail signal exists. To BIT check the set using only the height indicator, press the push to test switch.

WARNING

BIT only tests the height indicator and receiver transmitter. The proper installation and function of the antennas are not checked by either BIT method. Aircraft have experienced incorrect radar altimeter readings due to antenna and connection failures.

2.12.6 Standby Rate of Climb Indicator. The standby rate of climb indicator displays vertical speed on a scale from 0 to $\pm 6,000$ feet. It operates directly off the left static pressure with NORMAL selected by the static source selector lever or right static pressure with BACKUP selected.

2.12.7 Clock. A standard 8 day clock is installed.

2.12.8 Integrated Fuel/Engine Indicator (IFEI) Time Displays (F/A-18 C/D). Two time displays are on the integrated fuel engine indicator below the left DDI. The SDC supplies the time to the IFEI. For aircraft equipped with GPS the SDC time is equal to the GPS time. When the integrated fuel engine indicator is in the normal mode, the upper time display line shows local or zulu time as selected by the ZONE button. The bottom time display shows elapsed time and is controlled by the ET button. The upper time display is a six position liquid crystal display which displays 24 hour time in hours, minutes and seconds. Pressing the ZONE button changes the upper time display to local or zulu. When zulu time is shown, a Z legend appears to the right of the display. The lower time display is a five position liquid crystal (LCD) which displays elapsed time in hours, minutes and seconds. Pressing the ET button controls the stopwatch/elapsed time function as follows:

ET button actuation	Function
a. First (momentary)	Starts elapsed time
b. Second (momentary)	Freezes display, timing continues from first actuation
c. Third (momentary)	Returns display to running time
d. Subsequent (momentary)	Repeats action of second and third actuation
e. Press and hold (2 seconds or longer)	Stops elapsed time and resets to zero

2.12.8.1 Time Set Mode. The time set mode is used to set the real time clock in the signal data computer and to set the zulu time offset (plus or minus hours from local time). To enter time set mode and then set in the time, zulu offset, and date, proceed as follows:

Time Set button actuation	Function
a. Press MODE button twice within 5 seconds. Note that the displays reverts to the normal mode unless a button is pressed during any 30-second period.	The engine displays go blank, the hours in the upper time display flash and the lower time display goes blank. Fuel quantities and BINGO are blank. A flashing H is displayed in the right position of the lower fuel display. A T is displayed in the right position of the upper fuel display for hours, minutes and seconds time sets.
b. Press increment or decrement buttons.	Hours are set
c. Press QTY button.	Minutes flash and an M is displayed.
d. Press increment or decrement buttons.	Minutes are set, seconds go to 00 and time freezes.
e. Press QTY button again	Zulu time delta is displayed in the upper fuel display with (+) or (-) in the right position. DIF is displayed in the lower fuel display.
f. Press increment or decrement button.	Zulu time offset set
g. Press QTY button again.	Time display restarts. A flashing D is displayed in the right position of the upper fuel display for year, month and day sets. A flashing Y is displayed and the year is displayed in the upper time display.
NOTE	
Pressing the ET button or MODE button also restarts time and the system resets out of the time set mode and returns to the normal mode.	
h. Press increment or decrement button.	Year is set
i. Press QTY button again	A flashing M is displayed and the month is displayed in the upper time display.
j. Press increment or decrement button.	Month is set
k. Press QTY button again	A flashing D is displayed and the day is displayed in the upper time display.
l. Press increment or decrement button	Day is set
m. Press MODE button.	IFEI returned to normal mode

2.12.9 Standby Magnetic Compass. A conventional aircraft magnetic compass is mounted on the right windshield arch.

2.12.10 Angle-Of-Attack (AOA) Indexer. The AOA indexer (figure 2-19) is mounted to the left of the HUD. It displays approach angle of attack (AOA) with lighted symbols. Corresponding AOA indications are shown on the HUD. The indexer only operates with the landing gear down, W-off-W, a valid ADC AOA signal and a functional ADC. The lighted symbol(s) flash if the arresting hook is up and the hook bypass switch, on the left vertical panel, is in CARRIER. The symbols do not flash with the arresting hook up and the hook bypass switch in FIELD. The switch is solenoid held to FIELD and automatically goes to CARRIER when the arresting hook is lowered or aircraft power is removed. The AOA indexer knob on the HUD controls dimming of the symbols. All symbols light when the lights test switch on the interior lights control panel is held to TEST.

NOTE





On aircraft 161353 THRU 161519 without the latest configuration of air data computer installed, a discrepancy exists between optimum approach angle indications provided by the angle-of-attack bracket on the HUD and the angle-of-attack indexer lights. Thus, flying On Speed (velocity vector centered in AOA bracket) on the HUD produces a Slightly Slow indication on the indexer lights. On the other hand, flying On Speed on the indexer lights results in a slightly fast indication by the HUD AOA bracket display. Use of either instrument to set up the optimum approach angle is considered acceptable.

2.13 AVIONICS SUBSYSTEM

The avionics subsystem combines the integration and automation needed for one-man operability with the redundancy required to ensure flight safety and mission success. Key features of the system include highly integrated controls and displays; a highly-survivable quad-digital, control-by-wire primary flight control system; inertial navigation set with carrier alignment capability; and extensive built-in test capability. The avionic subsystems operate under the control of two mission computers with primary data transfer between the mission computers and the other avionic equipment via the mux buses.

2.13.1 Mission Computer (MC) System. The mission computer system consists of two digital computers (No. 1 and No. 2) which are high speed, stored program, programmable, general purpose

computers with core memory. Computer deselection is made with the MC switch on the MC/HYD ISOL panel. The two mission computers interconnect with the primary avionic equipment via the avionic multiplex (mux) buses. Mission computer No. 1 referred to as the navigation computer, performs processing for navigation, control/display management, aircraft built-in test (BIT), status monitoring operations and backup for mission computer No. 2. MC2, referred to as the weapon delivery computer, performs processing for air-to-air combat, air-to-ground attack, tactical control/display, and backup for MC1. On F/A-18A/B aircraft before AFC 225 there are three avionic mux bus channels (figure 2-20) with redundant paths (X and Y) for each channel. On F/A-18A/B aircraft after AFC 225 and some F/A-18C/D aircraft there are five avionic mux bus channels (figure 2-20) with redundant paths (X and Y) for each channel. Channel 1 links the mission computers and the flight control computers, air data computer, control converter (communication system control), armament control-processor set (stores management set), signal data computer (F/A-18C/D), HARM command launch computer, left digital display indicator, and one comm radio. Channel 2 links the mission computers

SYMBOL	AIRSPEED	INDEXER INDICATIONS ON	
		AIRCRAFT 161353 THRU 161519, WITH -906 ADC.	AIRCRAFT 161520 AND UP.
		AOA	AOA
	SLOW	8.9° TO 90.0°	9.3° TO 90.0°
	SLIGHTLY SLOW	8.1° TO 8.9°	8.8° TO 9.3°
	ON SPEED	6.9° TO 8.1°	7.4° TO 8.8°
	SLIGHTLY FAST	6.4° TO 6.9°	6.9° TO 7.4°
	FAST	0° TO 6.4°	0° TO 6.9°

SHADED INDICATES ILLUMINATED

18AC-NFM-00-(125-1)31-CATI

Figure 2-19. Angle of Attack Indexer

and the inertial navigation set, radar set, forward looking infrared (FLIR), laser detector tracker/strike camera, two-way data link, right digital display indicator (F/A-18A/B before AFC 225), one comm radio, on aircraft 163985 AND UP the navigation FLIR (NFLR) and digital map set (DMS), on aircraft 164627 AND UP the deployable flight incident recorder set (DFIRS) and GPS. Channel 3 provides data transfer between the two mission computers. On F/A-18A/B after AFC 225 and F/A-18C/D aircraft, channel 4 links the mission computers to the memory unit (MU), channel 5 links the mission computers to the right DDI, and on F/A-18A aircraft after AFC 292 and aircraft 165222 AND UP, ALSO 163985 THRU 165221 AFTER AFC 236 to the Combined Interrogator Transponder (CIT). On aircraft 163427 AND UP after AFC 270, MIDS is added to channel 4. On F/A-18A aircraft after AFC 253 or 292 and some F/A-18C/D aircraft there are six avionic mux bus channels. Channel 6 links the mission computers to the left DDI and the DMS.

The mission computer system performs the following:

- a. Computes and controls the data sent to the multipurpose display group.
- b. Uses input data to compute and generate missile launch and weapon release commands.
- c. Provides for mode control and option select for various avionics systems.
- d. Provides mode control and option select data from the multipurpose display group to avionic systems for control and computation.
- e. Outputs BIT initiate signals to various avionics systems.
- f. Receives equipment operational status from avionic and non-avionic systems. The mission computer system uses equipment status for multipurpose display group BIT status and advisory and caution display generation.

The computers receive inputs for navigational data and steering command computations from the inertial navigation system, air data computer system, electronic flight control system, multipurpose display group, TACAN, backup attitude, the navigation system and GPS. The computers control display symbology and information presented to the pilot by the multipurpose display group.

F/A-18A/B 3 CHANNEL

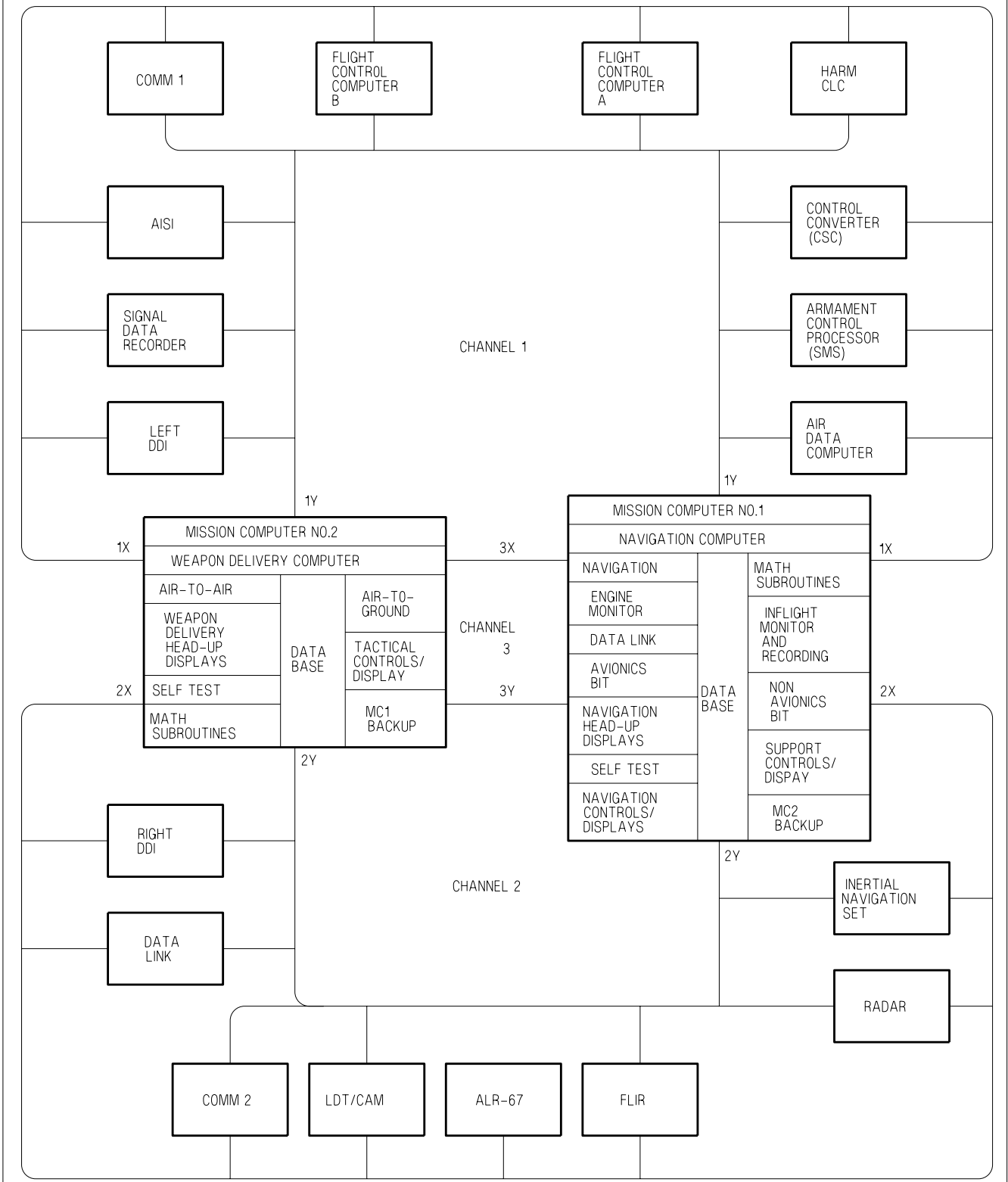

ADA520-19-1-045

Figure 2-20. Mission Computer Functions and Multiplex System (Sheet 1 of 5)

F/A - 18A/B 5 CHANNEL

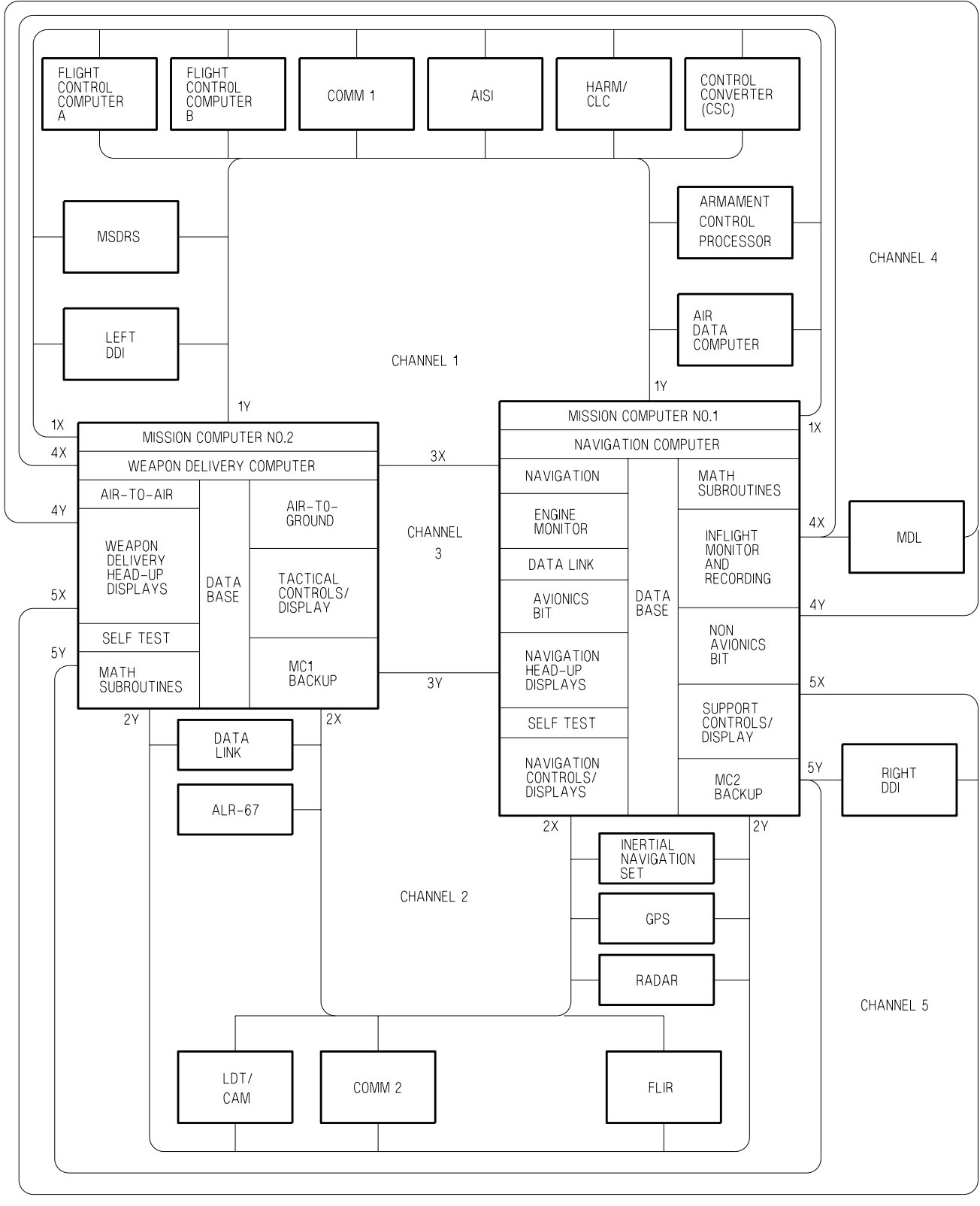

ADA520-19-4-045

Figure 2-20. Mission Computer Functions and Multiplex System (Sheet 2 of 5)

F/A-18A 6 CHANNEL

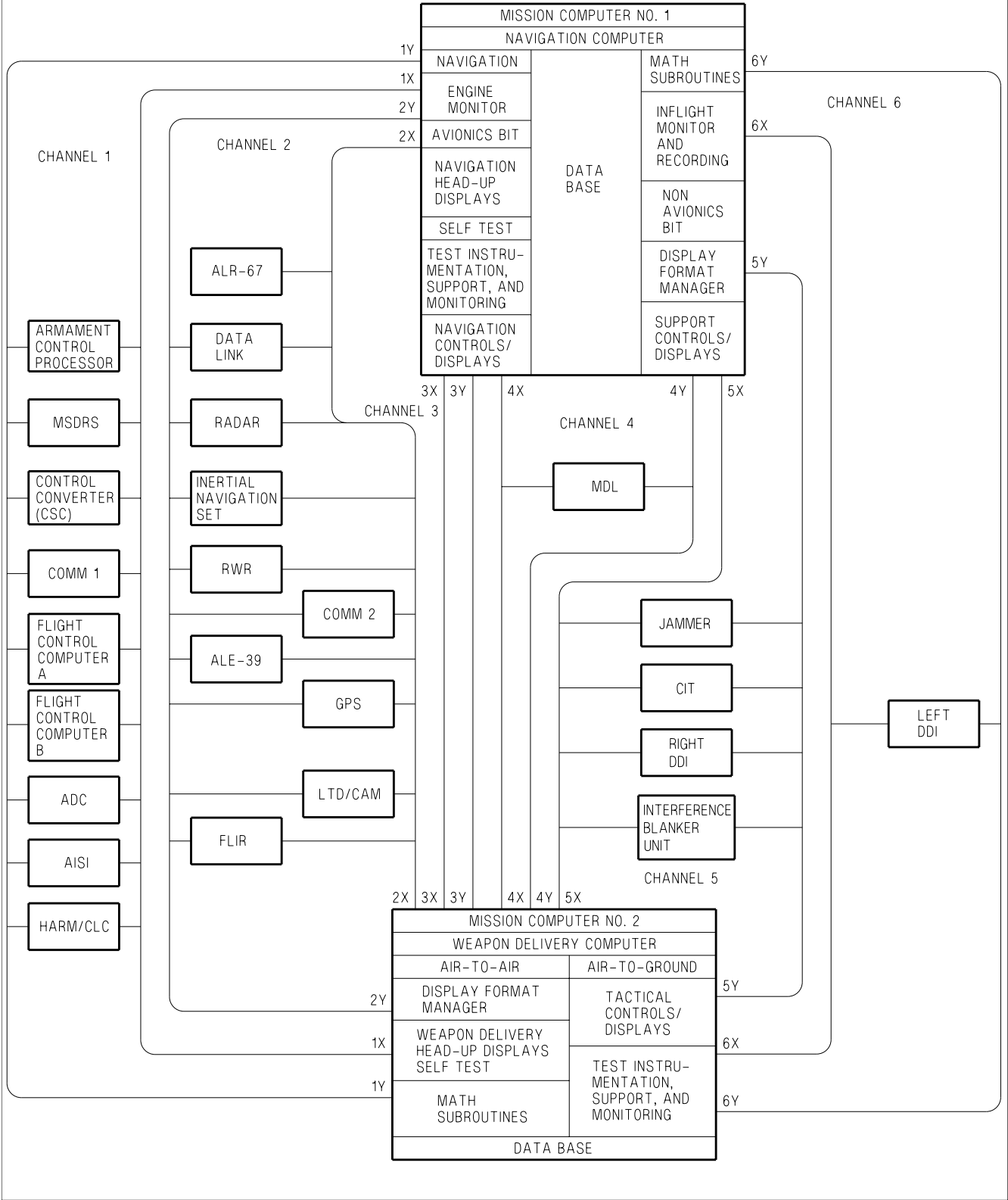

ADA520-19-5-045

Figure 2-20. Mission Computer Functions and Multiplex System (Sheet 3 of 5)

F/A-18C/D 5 CHANNEL

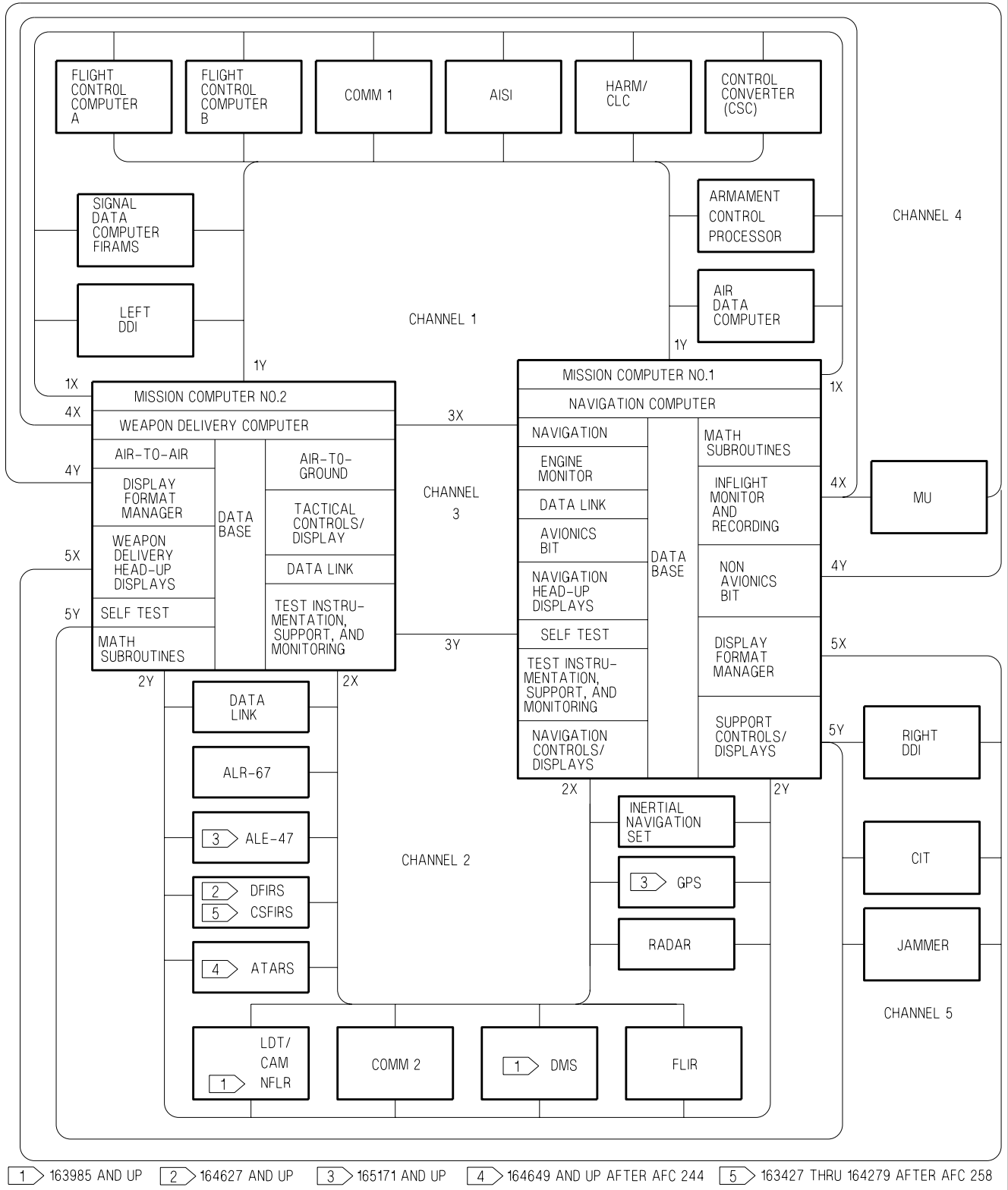

ADA520-19-2-045

Figure 2-20. Mission Computer Functions and Multiplex System (Sheet 4 of 5)

F/A-18C/D 6 CHANNEL

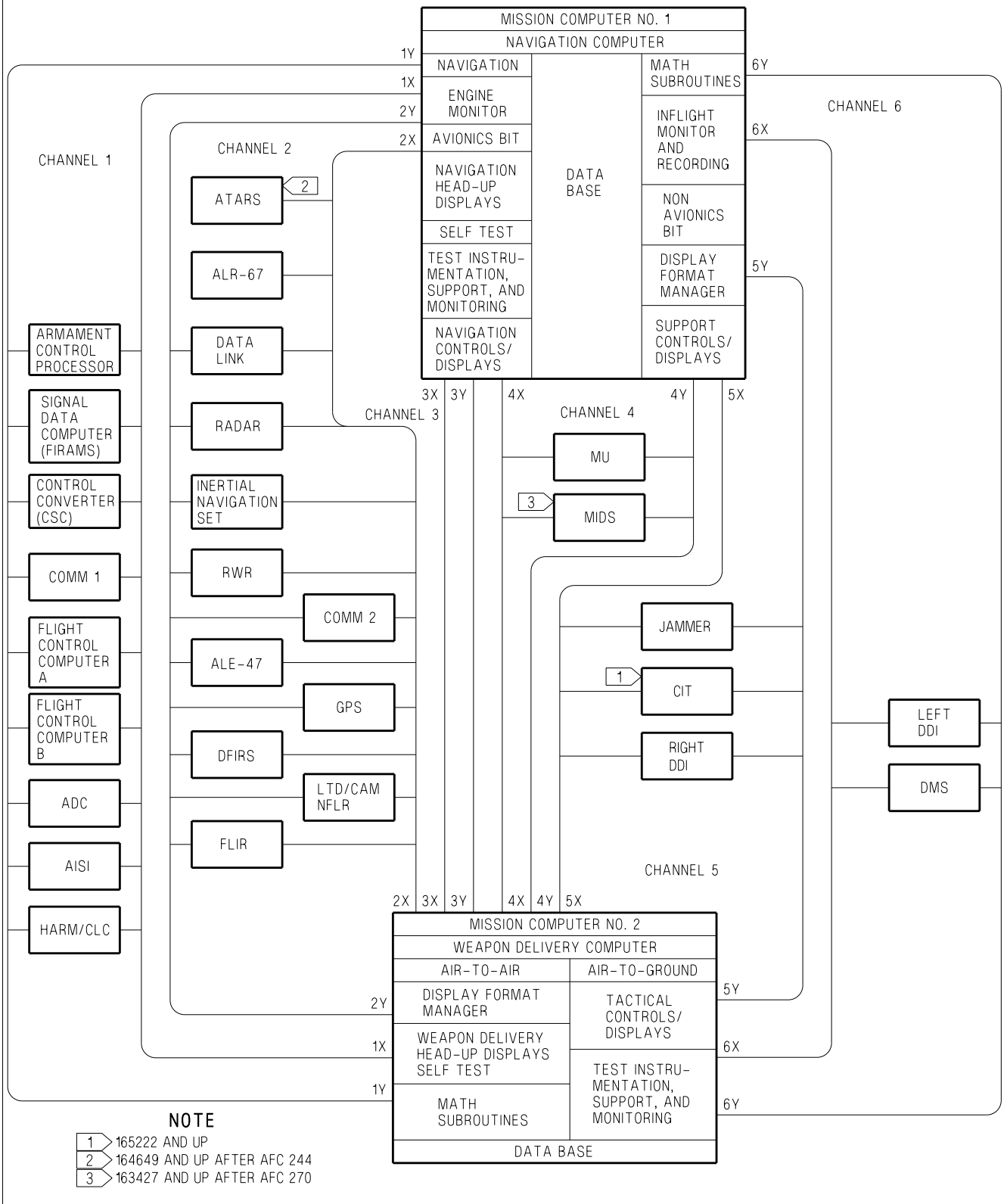

ADA520-19-3-046

Figure 2-20. Mission Computer Functions and Multiplex System (Sheet 5 of 5)

2.13.1.1 Mission Data Entry. Mission data (date and flight number) is manually loaded into the mission computer for data recorder documentation. To enter data into the mission computer perform the following:

- a. On the DDI - Press MENU, CHKLST, then ID
- b. On the UFC - Enter Julian Date (Option 1)
- c. On the UFC - Enter Flight (Option 2)

2.13.1.2 Mission Data Entry (MC OFP 12A, 13C AND UP). Mission Data can be manually loaded into the mission computer through the Memory Unit Mission Initialization (MUMI) display or can be automatically loaded. F/A-18A aircraft after AFC 253 or 292 the Mission Data Loader (MDL) is used to automatically load and store data. In F/A-18C/D aircraft, the Data Storage Set (DSS) is used to automatically load data. The DSS consists of the Memory Unit (MU) and the Memory Unit Mount (MUM) and provides memory storage for aircraft parameters, maintenance data, and avionic initialization data. The DSS receives, stores, retrieves, and transmits data with the mission computer.

2.13.1.2.1 Mission Initialization. The MDL, or MU provides the capability to load the following mission initialization files: HARM, MU ID, RADAR, RECCE, TACAN, WYPT/OAP, sequential steering, data link/ID, overlay controlled stores (OCS), with MC OFP 13C AND UP, bomb wind data, (with aircraft equipped with GPS) global positioning system waypoint (GPS WYPT), global positioning system almanac (GPS ALM), and Fighter Link Reference Point (FLRP). On aircraft 163427 AND UP AFTER AFC 270, COMM DCS initialization files can be loaded. Automatic loading is done at aircraft power up or when MUX communication is lost for more than 1 second and regained. If MUX communication is not regained, an MU LOAD caution is displayed and an AV MUX error message is displayed on the MUMI display. Manual loading may be done using the MUMI display.

2.13.1.2.2 Memory Unit Mission Initialization (MUMI) Display. The MUMI display (see figure 2-21) is accessible from the SUPT MENU and with WOW provides a visual indication of mission initialization files loaded from the MU/MDL. If the MU directory indicates that no user files are present, the MU ID displays NO IDENT. When the MU directory indicates a user file is present, MC 1 displays the option at the applicable pushbutton (with MC OFP 13C AND UP, MORE provides additional transfer options for weapons and DCS). When the pushbutton is pressed and the file is being read by MC 1, the option is boxed. If the read is successful, the file is loaded and the option is unboxed. When a file is present and errors have resulted from reading the file, the following occurs:

1. The MU ID displays NO IDENT.
2. The applicable load error is displayed (DL13), GPS ALM, GPS WYPT, HARM, OCS, RDR, RECCE, TCN, WYPT S/S, or COM.
3. MC 1 sends the appropriate maintenance code to the SDC.
4. If WOW, a MU LOAD caution is displayed on the DDI.

2.13.1.2.3 Erase Data (CRYPTO Switch). Setting the intercommunications amplifier control CRYPTO switch to the ZERO position sends an erase signal to the MU/MDL. This causes the MU/MDL to erase all data stored between predetermined memory locations.

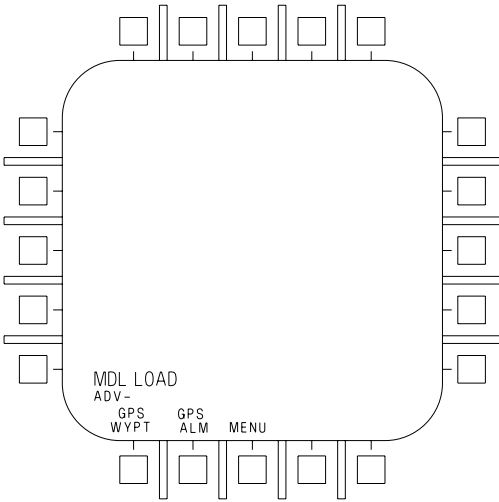

F/A-18 A/B WITH MC OFF 12A

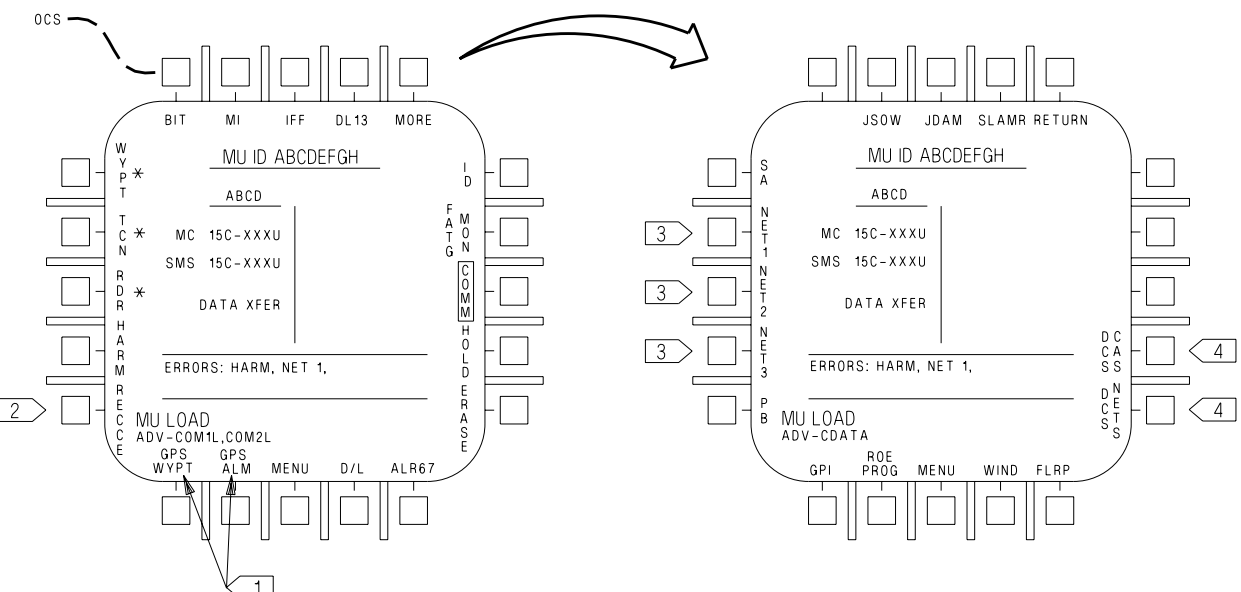

F/A-18 A AFTER AFC 253 OR 292 AND F/A-18 C/D

* W on W only (not available in flight)

- 1 165171 AND UP
- 2 164649 AND UP AFTER AFC 244

- 3 163427 AND UP AFTER AFC 270
- 4 163427 AND UP AFTER AFC 269

Figure 2-21. MUMI Display

ADA520-349-1-047

2.13.1.2.4 Erase and Hold Data. The erase controller (EC) within MC 1 provides the capability to automatically and manually erase or inhibit erasing of classified data contained in the MU/MDL, armament computer, and MC 1 and MC 2. When the EC determines classified mission initialization files have been read from the MU/MDL, the EC classified data management system is activated. When activated and aircraft is WOW, MC 1:

1. Displays HOLD, ERASE, and MC suspends option on the MUMI display.
2. Displays CDATA advisory.
3. Sends applicable maintenance code to SDC.

2.13.1.2.5 Automatic Erase. The MU/MDL, armament computer, MC 1, and MC 2 are automatically erased when all of the following criteria are met:

1. Airspeed is less than 50 KIAS.
2. Left and right engine power lever angle is less than 29°.
3. Weight on wheels.
4. Pilot does not select erase inhibit (HOLD) or MC SUSPEND options.

Automatic erase is also initiated by pilot ejection.

Automatic erase can be inhibited by selecting the HOLD pushbutton option.

1. HOLD boxed with MU displayed prevents automatic erase of the MU.
2. HOLD boxed with ALL displayed prevents automatic erase of all units (MU/MDL, armament computer, and MC 1 and MC 2).

The EC commands the MU/MDL, the armament computer, MC 1, then MC 2 to erase. The MC ERASE IN XX SEC countdown timer starts (60 seconds). During the countdown the MC SUSPEND pushbutton option cycles between boxed and unboxed. When the timer reaches zero, the decision to continue erasing the remainder of MC 1 and MC 2 depends on the MC SUSPEND pushbutton being deselected (unboxed). When deselected, the remaining erase of MC 1 and MC 2 is completed.

2.13.1.2.6 Manual Erase. Manual erase is initiated by pressing the ERASE pushbutton on the MUMI display. When pressed, ERASE is boxed and erasing proceeds the same as automatic erase. When erasing is complete, the ERASE pushbutton is unboxed. While erase is in progress one of the following is displayed on the MUMI display:

1. ERASING - erasing of unit is in progress.
2. COMPLETE - erasing of unit is complete.
3. FAILED - unit failed to erase.

When erase fails the MC 1 retains the MUMI ERASE and HOLD pushbutton options and displays the ERASE FAIL caution on the DDI. When erasing is complete MC 1 removes the ERASE, HOLD, and MC SUSPEND pushbutton options from the MUMI display, removes the CDATA advisory from the display, and resets the applicable maintenance code(s).

2.13.1.3 MC/HYD ISOL Panel. The MC switch has positions of 1 OFF, 2 OFF, and NORM. Placing the switch to 1 OFF turns off digital computer No. 1. Placing the switch to 2 OFF turns off digital computer No. 2. With the switch set to NORM, both No. 1 and No. 2 digital computers are turned on.

2.13.2 Master Modes. There are three master modes of operation: navigation (NAV), air-to-air (A/A), and air-to-ground (A/G). The controls, displays, and the avionic equipment operation are tailored as a function of the master mode which the pilot has selected. The navigation master mode is entered automatically when power is applied to the aircraft, when the air-to-air or air-to-ground modes are deselected, when the landing gear is lowered, when the SPIN mode activates, or when the aircraft has weight on wheels and the throttle position (power lever angle) is greater than 56°. The A/A master mode is entered either by pressing the A/A master mode button alongside the left DDI or by selecting an A/A weapon with the A/A weapon select switch on the control stick. The A/G master mode is selected by pressing the A/G master mode button. The selection is performed by the stores management set (SMS), and the SMS identifies the selected master mode to the mission computer.

2.13.2.1 Steering Information. The sources of steering information available in the NAV master mode are waypoint, TACAN, instrument landing system and data link. The data link modes available in the NAV master mode are vector and automatic carrier landing. TACAN and waypoint steering are mutually exclusive and selecting one automatically deselects the other. However, data link, ILS, and TACAN (or waypoint) steering can be provided simultaneously. The ACL mode is selectable only in the NAV master mode, and the vector mode is available in all master modes. With MC OFP 13C AND UP, steering information is used by the Automatic Flight Control System to provide coupled steering options.

2.13.3 Cockpit Controls and Displays. The cockpit controls and displays which are used for navigation operation are on the multipurpose display group and on the upfront control (UFC).

2.13.4 Multipurpose Display Group. The multipurpose display group consists of the right digital display indicator (DDI), the left DDI, the horizontal indicator (HI) on aircraft 161353 THRU 163782, the multipurpose color display (MPCD) on aircraft 163985 AND UP BEFORE AFC 380, the advanced multipurpose color display (AMPCD) on aircraft 163985 AND UP AFTER AFC 380, the digital map set (DMS), the head-up display (HUD), the CRS (course) set switch, and the HDG (heading) set switch. The multipurpose display group presents navigation, attack, and aircraft attitude displays to the pilot. The multipurpose display group converts information received from the mission computer system to symbology for display on the right and left DDIs, the HI/MPCD, and the HUD. The HUD camera records the outside world and HUD symbology. The left and right DDIs and the HI/MPCD contain pushbuttons for display selection and various equipment operating modes. Refer to Part VII for the operation of each component.

2.13.4.1 Digital Display Indicators (DDI). The right and left DDIs are physically and functionally interchangeable giving the ability to display desired information on either indicator or using either indicator to control the HUD or horizontal indicator displays. The left indicator is used primarily for stores status, built-in test status, engine monitor, caution, and advisory displays. The right indicator is normally used for radar and weapon video displays.

On aircraft 163985 AND UP the DDIs are NVG compatible and display three colors (red, yellow, and green) for stroke information. A monochrome version of the digital map can be selected on any of the

DDIs. Either DDI can provide raster generation for the HUD. A description of the various switches and controls on the right and left DDIs follows.

NOTE

It is possible that a transient condition may cause the displays to blank or provide an erroneous display on the left or right DDI, HI/MPCD/AMPCD, or HUD. The problem may be cleared by manually cycling the power to the right or left DDI.

2.13.4.1.1 Brightness Selector Knob. Placing this rotary knob to OFF prevents the indicator from operating. Placing the knob to NIGHT provides a lower brightness control range (with three settings) and no automatic contrast control. The knob in the AUTO position allows automatic brightness control circuits to compensate display brightness for changes in ambient lighting. Turning the knob to DAY provides a higher brightness control range with no automatic contrast control.

2.13.4.1.2 Brightness Control. This knob varies the intensity of the presentation.

2.13.4.1.3 Contrast Control. This knob varies the contrast between symbology and the dark background on any level of brightness.

2.13.4.1.4 Pushbuttons. There are 20 pushbuttons on each DDI which are used to select the function and the mode for proper indicator display.

2.13.4.1.5 Fault Indicator. The indicator displays unit operational status: white for failed and black for normal.

2.13.4.2 Menu Display (F/A-18A/B BEFORE AFC 253 OR 292). The menu display options (figure 2-22) are selected by pressing the MENU pushbutton (center bottom pushbutton). The desired display can then be selected by pressing the corresponding option pushbutton. Some of the options on the menu display are conditional and are not always displayed. FLIR, LST, and CAM are listed only if the equipment is communicating with the mission computer. HARM DSPLY is displayed when HARM is on board and CLC communicating. A/G missile display (WEDL DSPLY, MAV DSPLY, etc.) is displayed when the MC has determined from the armament control processor set that a weapon station has been selected which contains one of these weapons. LINK 4 is displayed only while an automatic carrier landing (ACL), or vector (VEC) is displayed.

If the navigation computer (MC1) is not on, BIT, ADI, FCS, UFC BU, CHKLST, and ENG are not displayed. If the weapon delivery computer (MC2) is not on, ADI, STORES, LST, and CAM are not displayed. If both mission computers are off, or not communicating with the display, the DDI displays only a flashing STANDBY in the center of the screen.

2.13.4.2.1 Menu Display (F/A-18A AFTER AFC 253 OR 292 AND F/A-18C/D). There are two MENU displays (figure 2-22), TAC (tactical) and SUPT (support) through which display selections can be made. On aircraft 163985 AND UP, the two menu formats can appear on any DDI or MPCD/AMPCD. On aircraft prior to 163985 the menu displays can appear only on the DDIs.

The TAC MENU display is indicated by the word TAC appearing just above the MENU option. The TAC MENU is selected by actuating the MENU option on any display (besides the TAC MENU display). The SUPT MENU display is indicated by the word SUPT appearing just above the MENU option. The SUPT MENU is selected by actuating the MENU option on the TAC MENU. With MC OFP 19C, MENU pushbutton legend is MENU with WonW. With WoffW, in the front cockpit only, aircraft system time is displayed in place of MENU in a four digit format of MMSS to facilitate postflight tape debriefs. Pushbutton functionality is unchanged.

The TAC MENU allows for selection of weapons, sensors, HUD, stores displays and, on aircraft 164649 AND UP after AFC 244, RECCE displays. The SUPT MENU allows for selection of flight type displays: ADI, HSI, HMD, BIT, MUMI, Checklist, Engines, Flight Controls, UFC backup, FPAS, and Fuel formats. In LOT 10 and up after AFC 270, DCS NETS, MIDS, and ROE PROG options are available. With MC OFP 17C, ROE/IFF PROG option is available.

Some of the options on the menu display are conditional and are not always displayed. NFLR, FLIR, LST, and CAM are listed only if the equipment is communicating with the mission computer. HARM DSPLY is displayed when HARM is on board and CLC communicating. A/G missile display (WEDL DSPLY, MAV DSPLY, etc.) is displayed when the MC has determined from the armament control processor set that a weapon station has been selected which contains one of these weapons.

If the navigation computer (MC1) is not on, only HSI is displayed on the SUPT menu and the TAC menu loses the SA option. If weapon delivery computer (MC2) is not on, the SUPT menu remains unchanged and the TAC menu loses the STORES, LST/CAM or NFLR, AWW-9/13, HARM, A/G displays. If both mission computers are off, or not communicating with the display, the DDI displays only a flashing STANDBY in the center of the screen.

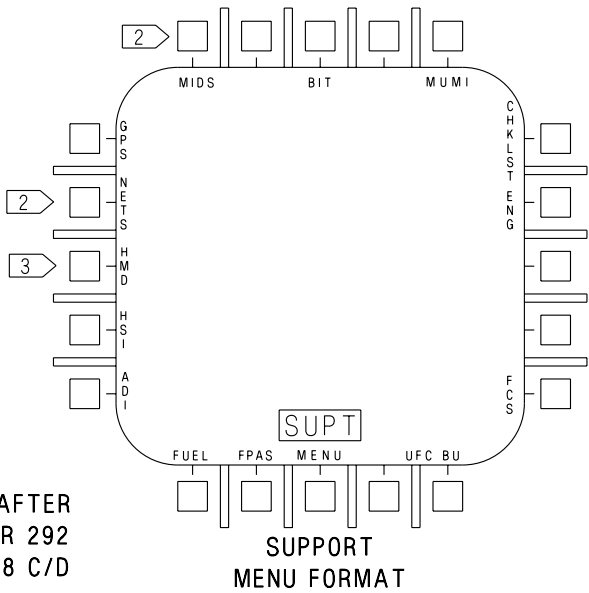
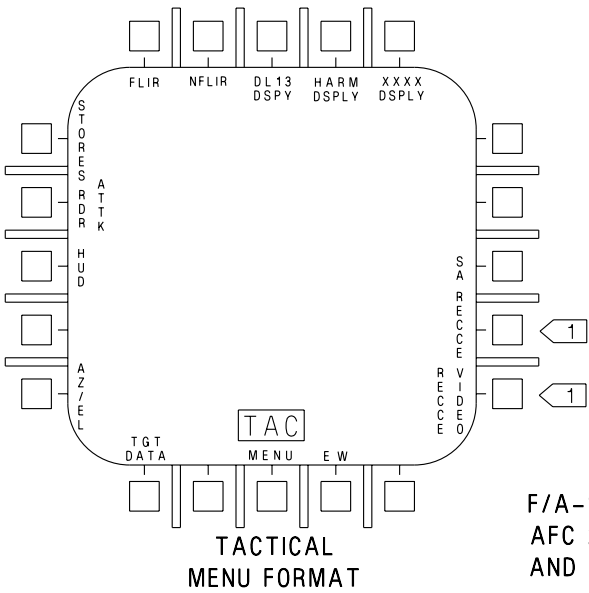
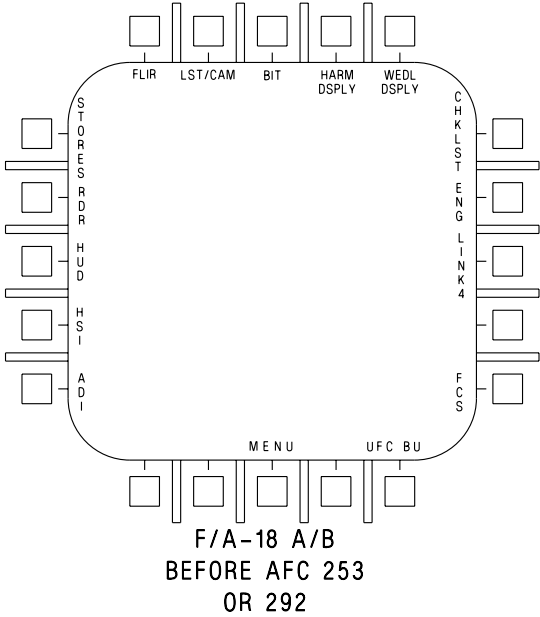

- 1 164649 AND UP AFTER AFC 244
- 2 163427 AND UP AFTER AFC 270
- 3 AFTER AFC 400

Figure 2-22. Menu Display

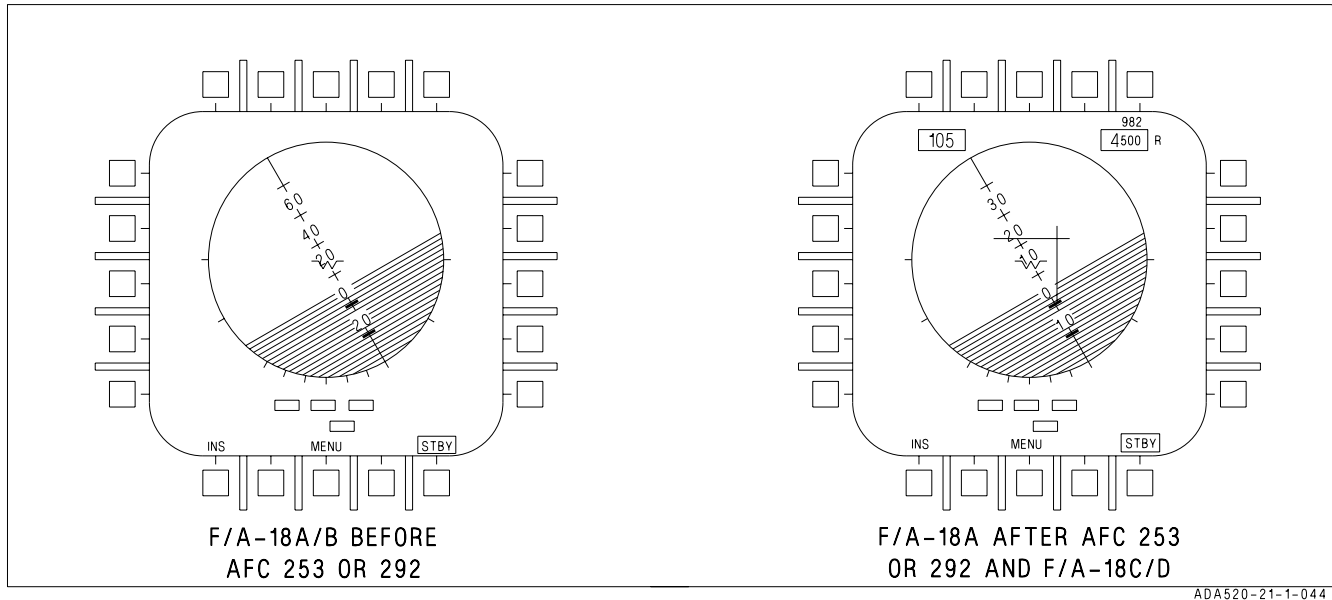

Figure 2-23. Electronic Attitude Display Indicator

2.13.4.3 Electronic Attitude Display Indicator (EADI). The electronic attitude display indicator is available for display on the left or right DDI as an alternative to the attitude display on the HUD (figure 2-23). A small circle is displayed on the ball to represent the zenith and a circle with an inscribed cross is displayed to represent the nadir. The pitch ladder is displayed in 20° increments with MC OFP 10A AND UP, or 10° increments with MC OFP 13C AND UP. A turn indicator which displays FCS yaw rate is provided below the ball. A standard rate turn (3° per second) is indicated when the lower box is displaced so that it is under one of the end boxes. The EADI display is selected by pressing the ADI pushbutton on the MENU.

Selecting the INS or STBY options at the bottom of the display determines the source of attitude information used to generate the display. Upon power-up with WOW, the EADI attitude initializes to STBY (STBY boxed), thus using the standby attitude reference indicator for attitude source information. With STBY boxed the EADI display should be compared to the visual display on the standby altitude reference indicator. If the pitch and roll attitude display does not correlate on the two instruments, the standby indicator is most likely defective, requiring maintenance. Selecting the INS option (INS boxed) uses attitude information provided by the INS. Selection of the INS or STBY on the EADI does not change the source of attitude data for the HUD.

With MC OFP 13C AND UP, airspeed and altitude are displayed in a box at the top left and altitude source is displayed to the right of the altitude box and the vertical velocity is displayed above the altitude box. When ILS is selected the deviation needles are displayed in reference to the waterline symbol. The ILS needles are in yellow when COLOR is selected on the Attack display.

2.13.4.4 HI (Aircraft 161353 THRU 163782). During normal operation, the HI provides aircraft heading, steering, and navigation information with a projected moving map display superimposed over the HI display, (with the 10 nm or 40 nm scale selected). The HI receives symbol generation and control signals from the left DDI under mission computer control. The description of the controls, pushbuttons, and indicator for the HI are the same as for the right and left DDIs except that the HI also has a mode selector knob, HI brightness selector knob, slew pushbutton, map brightness knob, and the menu option is not available.

2.13.4.4.1 Mode Selector Knob. The mode selector knob has positions of DATA, N-UP, NORM, and D-CTR. Placing the knob to DATA selects the index frame of the moving map display and enables the upfront control for entering the desired data frame number. The index provides a listing of data available on each frame. After a data frame has been selected the film can be stepped to adjacent frames by using the up arrow and down arrow pushbuttons on the HI. Selecting N-UP on the mode selector knob rotates the map to true north up. The lubber line remains on the aircraft's magnetic heading and the ground track is magnetic ground track. Placing the knob to NORM position selects track-up display. The compass rose is rotated to aircraft magnetic ground track. The aircraft symbol and the lubber line are at the aircraft magnetic heading. With the mode selector knob in D-CTR, decentered track-up display is selected with the aircraft symbol at the bottom of the display. The aircraft symbol and the lubber lines are at the aircraft magnetic heading. When the decentered mode is selected, the range scale at top center is doubled to indicate 20, 40, 80, 160, or 320, although the actual scale is unchanged. The reason for this is that the scale number is the distance from the aircraft symbol to the inside of the compass rose. In the decentered mode, the projected map is displayed when the scale indicates 20 and 80 miles.

2.13.4.4.2 HI Brightness Selector Knob. The knob has positions of OFF, NIGHT, and DAY. Placing the knob to OFF prevents the indicator from operating. Placing the knob to NIGHT provides a lower brightness control range. The knob in the DAY position provides higher brightness control range.

NOTE

- If the knob is in NIGHT position and the map filter is out of view or only partially in view, switch the knob to DAY for 2 seconds and then back to NIGHT. If the knob is in DAY position and the map filter is in view or partially in view, switch the knob to NIGHT for 2 seconds then back to DAY. If the knob is set to OFF and the DAY position is desired, switch from OFF to DAY in less than 0.5 second.
- To prevent damage to the moving map servos, keep the HI brightness selector knob in NIGHT or DAY and at least one DDI on whenever the aircraft is in motion.

2.13.4.4.3 Slew Pushbutton. Pressing the slew pushbutton on the HI assigns the TDC to the HI map for slewing. The map slew function is used for position updating and waypoint entry as well as to look at off-scale regions of the map. The word SLEW is displayed in the upper right corner of the HI while the TDC is assigned to the HI for map slewing.

When the TDC is pressed to slew the map (other than for a map position update or waypoint/OAP data entry), the following symbology is removed from the HI: TACAN symbol, waypoint/OAP symbol along with their respective bearing pointers and tails. The aircraft symbol is replaced with an X indicating the slew point. When slewing is completed the map freezes. Assigning the TDC elsewhere reverts the map to present position with the aircraft symbol displayed.

2.13.4.4.4 Map Brightness Knob. This knob varies the brightness intensity of the moving map display.

2.13.4.5 MPCD (Aircraft 163985 AND UP BEFORE AFC 380). The MPCD is an NVG compatible digital display capable of providing any MENU selectable format except the A/G radar display. The MPCD is driven by either the digital map set (DMS) for HSI displays, or the LDDI for all other MENU

selectable formats. Four momentary two-position rocker switches, located on the front of the MPCD, permit control of MPCD power, day/night viewing modes, brightness, and contrast.

NOTE

In F/A-18D (Aircraft 163986 AND UP), one of the two MPCDs must display HSI format from the DMS. The other MPCD may display any MENU selectable format. When one MPCD is DDI-driven, the opposite MPCD is DMS-driven and MENU is replaced with a TAKE option (on the DMS-driven MPCD only).

2.13.4.5.1 Night Brightness Selector. This rocker switch is located in the upper left corner of the MPCD and is used to turn the MPCD off (OFF position selected) or to select the lower brightness control (night) range and disable automatic contrast control (NITE position selected). If the MPCD is off, selecting NITE also turns the unit on. When NITE is selected, the display is NVG compatible and contrast may be manually adjusted with the contrast control.

2.13.4.5.2 Day Brightness Selector. This rocker switch is located in the upper right corner of the MPCD and is used to select the higher brightness control (day) range (DAY position selected) or to select the automatic brightness control to compensate the display brightness for changes in ambient lighting (AUTO position selected). If the MPCD is off, selecting DAY or AUTO also turns the unit on. When DAY is selected, automatic brightness control is disabled and display brightness may be manually adjusted with the brightness control. However, if a color display (digital map) is selected, the automatic brightness control circuits are automatically engaged.

2.13.4.5.3 Brightness Control. This rocker switch is located in the lower left corner of the MPCD. The brightness switch is enabled only when a mono raster display from the DMS is displayed; otherwise the brightness switch is disabled. Momentary actuations of the upper half of the switch incrementally increase the intensity of the display. Momentary actuations of the lower half incrementally decrease the intensity. If the switch is held in either position, the intensity is continuously adjusted to the upper or lower limits. If the brightness control is actuated while disabled, an AUTO legend appears at 200 % size to the left of the display center and is removed 5 seconds after the switch is released. If the brightness control is operating, a variable number from 0 to 9 appears at 200 % size to the right of the AUTO legend to indicate the current intensity setting and is removed 5 seconds after the switch is released.

2.13.4.5.4 Contrast Control. This rocker switch is located in the lower right corner of the MPCD. Momentary actuations of the upper half of the switch incrementally increase the contrast of the display. Momentary actuations of the lower half incrementally decrease the contrast of the display. If the switch is held in either position, the contrast is continuously adjusted to the upper or lower limits. When the contrast control is operated, a variable number from 0 to 9 appears at 200 % size to the right of the display center to indicate the current contrast setting. Five seconds after the switch is released, this number is removed.

2.13.4.6 AMPCD (Aircraft 163985 AND UP AFTER AFC 380). The AMPCD is an NVG compatible digital display capable of providing any MENU selectable format except the A/G radar display. The AMPCD is driven by either the digital map set (DMS) for HSI displays, or the LDDI for all other MENU selectable formats. Four momentary two-position rocker switches and a rotary knob, located on

the front of the AMPCD, permit control of AMPCD off/brightness, night/day viewing modes, symbology, gain, and contrast.

NOTE

In F/A-18D (Aircraft 163986 AND UP), one of the two AMPCDs must display HSI format from the DMS. The other AMPCD may display any MENU selectable format. When one AMPCD is DDI-driven, the opposite AMPCD is DMS-driven and MENU is replaced with a TAKE option (on the DMS-driven AMPCD only).

2.13.4.6.1 Off/Brightness Control. This rotary switch is located in the upper center of the AMPCD and is used to turn the AMPCD off (OFF position selected) or to select the brightness level. The brightness control is enabled only when a mono raster display from the DMS is displayed; otherwise the brightness control is disabled. If the brightness control is actuated while disabled, an AUTO legend appears at 200 % size to the left of the display center and is removed 5 seconds after the switch is released. If the brightness control is operating, a variable number from 0 to 9 appears at 200 % size to the right of the AUTO legend to indicate the current intensity setting and is removed 5 seconds after the switch is released.

2.13.4.6.2 Night/Day Brightness Selector. This rocker switch is located in the upper left corner of the AMPCD and is used to select the lower brightness control (night) range and disable automatic contrast control (NITE position selected) or to select the higher brightness control (day) range (DAY position selected). When NITE is selected, the display is NVG compatible and contrast may be manually adjusted with the contrast control. When DAY is selected, automatic brightness control is disabled and display brightness may be manually adjusted with the brightness control. However, if a color display (digital map) is selected, the automatic brightness control circuits are automatically engaged.

2.13.4.6.3 Symbology Control. This rocker switch is located in the upper right corner of the AMPCD. Momentary actuations of the upper half of the switch incrementally narrows the symbology, making it sharper and dimmer. Momentary actuations of the lower half incrementally widens the symbology, making it brighter and less sharp. If the switch is held in either position, the symbology is continuously adjusted to the upper or lower limits.

2.13.4.6.4 Gain Control. This rocker switch is located in the lower left corner of the AMPCD. Momentary actuations of the upper half of the switch incrementally increases background video brightness. Momentary actuations of the lower half incrementally decreases video brightness. If the switch is held in either position, the gain is continuously adjusted to the upper or lower limits.

2.13.4.6.5 Contrast Control. This rocker switch is located in the lower right corner of the AMPCD. Momentary actuations of the upper half of the switch incrementally increase the contrast of the display. Momentary actuations of the lower half incrementally decrease the contrast of the display. If the switch is held in either position, the contrast is continuously adjusted to the upper or lower limits. When the contrast control is operated, a variable number from 0 to 9 appears at 200 % size to the right of the display center to indicate the current contrast setting. Five seconds after the switch is released, this number is removed.

2.13.4.7 HSI Display Symbology. Basic HSI symbology such as the compass rose, ground track pointer, lubber line (for magnetic heading), true airspeed readout, ADF bearing pointer, groundspeed readout, and aircraft symbol are not described, however, they are shown in figure 2-24. The radar target and GEO REF symbols are described in NTRP 3-22.2-FA18A-D NATIP. The following paragraphs describe unique F/A-18 navigation symbology (figure 2-24). Refer to part VII for a description of how these symbols are integrated in with the navigation system.

1. Waypoint/OAP data. Data for the current steer to waypoint/OAP is displayed on the upper right corner of the HSI. Waypoint/OAP data consists of bearing, range, and TTG (time-to-go) up to 8:59:59 based on distance and ground speed. When a waypoint/OAP or offset to the OAP is designated (becomes a target), this data then relates to the target. When a waypoint is a waypoint that is transferred from GPS, an ID Code is displayed under the waypoint data. When GPS is coupled to the INS, an ID Code is displayed under the waypoint data.
2. TACAN data. TACAN data is displayed on the upper left corner of the HSI. TACAN data consists of bearing, range (slant range), TTG (based on distance and present ground speed), and the station identifier.
3. Waypoint/OAP symbology. Waypoint/OAP symbology consists of a waypoint/OAP symbol, bearing pointer and tail. The waypoint/OAP symbol indicates the position of the selected waypoint/OAP relative to the aircraft symbol. The waypoint/OAP bearing pointer and tail are displayed inside the compass rose and indicate bearing to the selected waypoint/OAP. Waypoint/OAP symbology is displayed whether or not waypoint/OAP steering is selected. When the selected waypoint/OAP is outside the HSI range scale, the waypoint/OAP symbol is limited at the inside of the compass rose coincident with the pointer. When a waypoint/OAP is designated, the waypoint/OAP symbol and circle inside the pointer change to a diamond shape. The offset symbol appears when steering is to an OAP. The offset symbol indicates the position of the offset relative to the OAP.
4. TACAN symbology. TACAN symbology consists of a TACAN symbol, TACAN bearing pointer and tail. The TACAN symbol indicates the position of the TACAN station relative to the aircraft symbol. The TACAN bearing pointer and tail are located outside of the compass rose and indicate bearing to the TACAN station. When the TACAN station is outside the HSI range scale, the TACAN symbol is limited at the inside of the compass rose. When TACAN range becomes invalid the TACAN symbol is not displayed.

NOTE

TACAN symbology displayed inside of the compass rose is filtered to prevent excessive movement of TACAN symbols due to RF interference. However, the "fly-to" needle displayed in the HUD with TACAN steering selected is not filtered and represents the raw data received by the TACAN. As a result, for brief periods of time, the HUD and HSI may display conflicting information regarding aircraft position with respect to the selected TACAN course line. Aircrew should use HUD displayed TACAN information when conducting TACAN approaches.

5. Heading select marker and readout. The heading select marker is maneuvered along the periphery of the compass rose using the HDG switch. The digital readout of the selected heading

is located on the lower left corner of the HSI. The heading select marker and digital readout are part of the heading select mode of the autopilot.

6. Course line arrow and readout. The course line arrow indicates the selected course to the waypoint/OAP or TACAN station. The course is selected using the CRS switch. The digital readout of the selected course is displayed on the lower right corner of the HSI. The course line arrow is not displayed when TACAN range is invalid. With MC OFP 13C AND UP, the perpendicular distance to the nearest 0.1 nm (up to a maximum of 99.9 nm) followed by C is displayed above the CSEL display. If a sequence is displayed with AUTO boxed and the current steer-to waypoint selected, then perpendicular distance to the sequence line is displayed as described above, but followed by S.
7. TDC assignment diamond. The TDC assignment diamond is displayed on the upper right corner of the HSI. This diamond indicates that the TDC is assigned to the HSI. In aircraft 163986 AND UP the TDC assignment diamond indicates control is assigned to both cockpits. Other symbols indicate front or aft cockpit TDC control and corresponding SLEW control options by actuating the sensor control switch AFT, while in the NAV or A/G master mode. The word SLEW is displayed in the TDC assignment diamond position when the SLEW pushbutton is pressed.
8. Coupled steering symbology. CPL and the source of the steering information is displayed on either side of the aircraft symbol in the center of the HSI display whenever the flight control system is coupled in azimuth to a steering source. Steering source can be WYPT, TCN, or SEQ#. The couple cue flashes for 10 seconds and then is removed if the steering signal is lost or becomes invalid.
9. Sequential steering lines. The sequential steering lines are displayed when a sequence is entered and when one of the sequence options (SEQ1, SEQ2, or SEQ3) is boxed. The sequential steering lines are available for display in all HSI modes and range scales. Sequential steering lines are not displayed at power up with WOW and are removed when magnetic heading is invalid, aircraft position is invalid, or map slew is selected.
10. Zulu time of day (ZTOD). ZTOD is displayed on the lower left corner of the HSI. For F/A-18A/B aircraft ZTOD must be set in order to be displayed. For F/A-18C/D aircraft that pass the FIRAMS real time clock power up BIT, ZTOD does not need to be entered. For F/A-18C/D aircraft that do not pass the FIRAMS real time clock power up BIT, ZTOD must be entered.
11. Groundspeed required. Groundspeed required appears below the current groundspeed readout. Groundspeed required indicates the groundspeed required to a target based on entered ZTOD, time on target (TOT), and the target.
12. Elapsed time (ET)/countdown (CD) time. ET and CD time are displayed on the lower right corner of the HSI. However, only one of the timers can be displayed at a time. Either ET or CD timer must be selected to be displayed. ET initializes to zero minutes and seconds and CD time initializes to six minutes and zero seconds.
13. Aircraft heading. Aircraft heading is indicated on the compass rose. Aircraft heading and bearing data can be selected as either magnetic or true. With true heading selected, the letter T appears below the lubber line and the word TRUE appears below the selected scale readout. There is no indication when magnetic heading is selected.

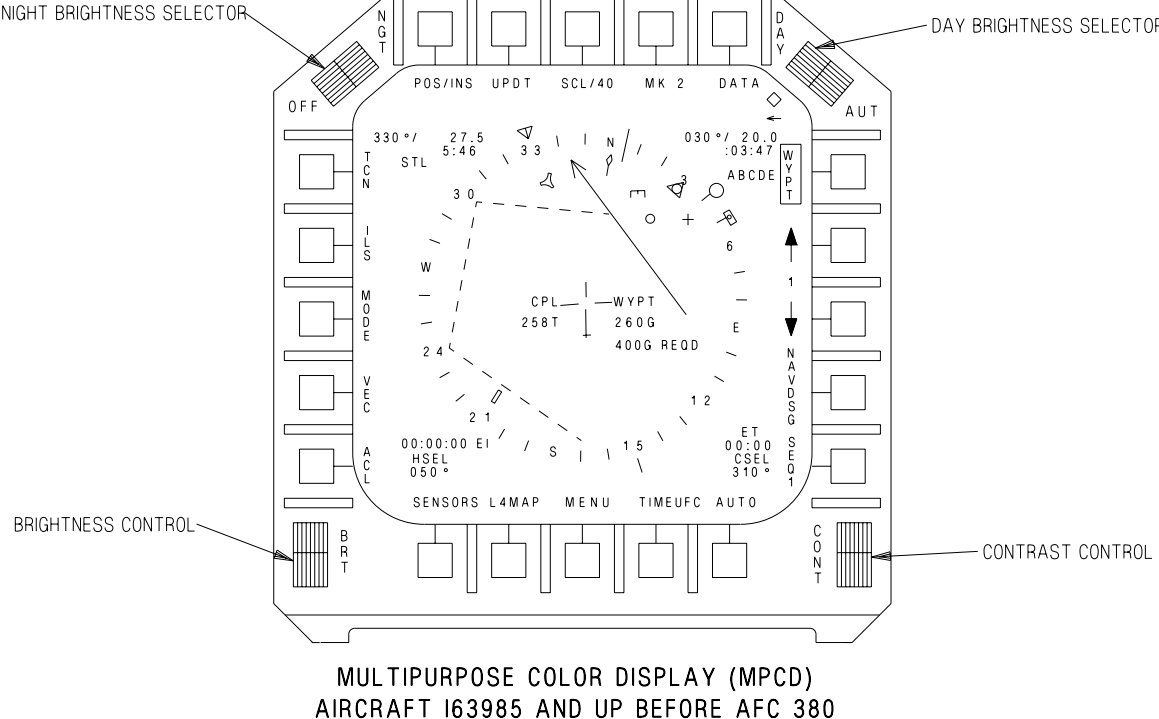
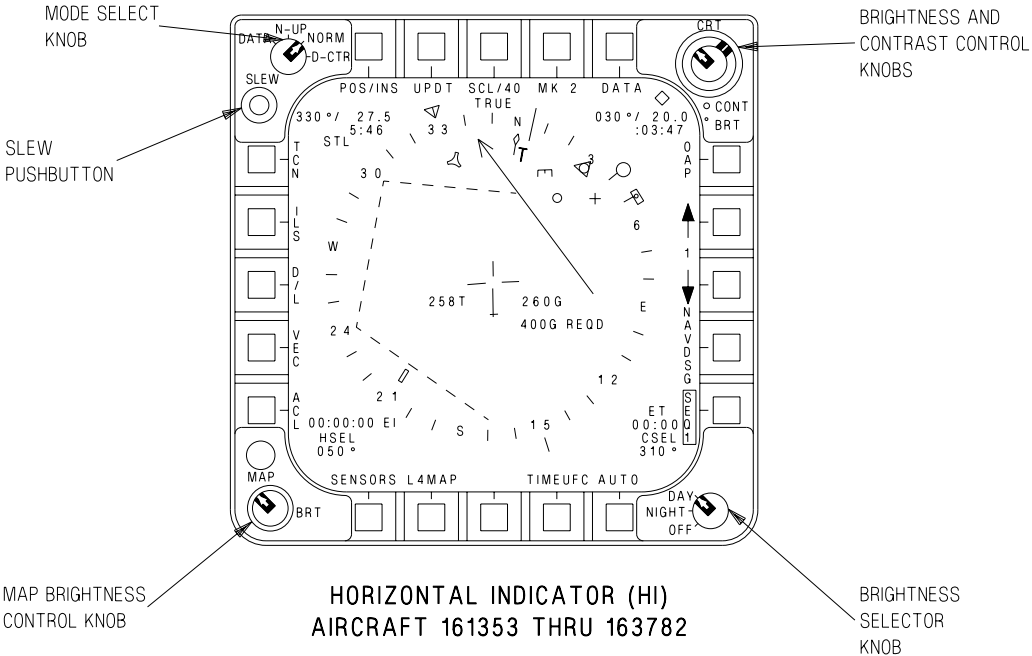

ADA520-124-1-051

Figure 2-24. HI/MPCD/AMPCD Controls and HSI Symbology (Sheet 1 of 3)

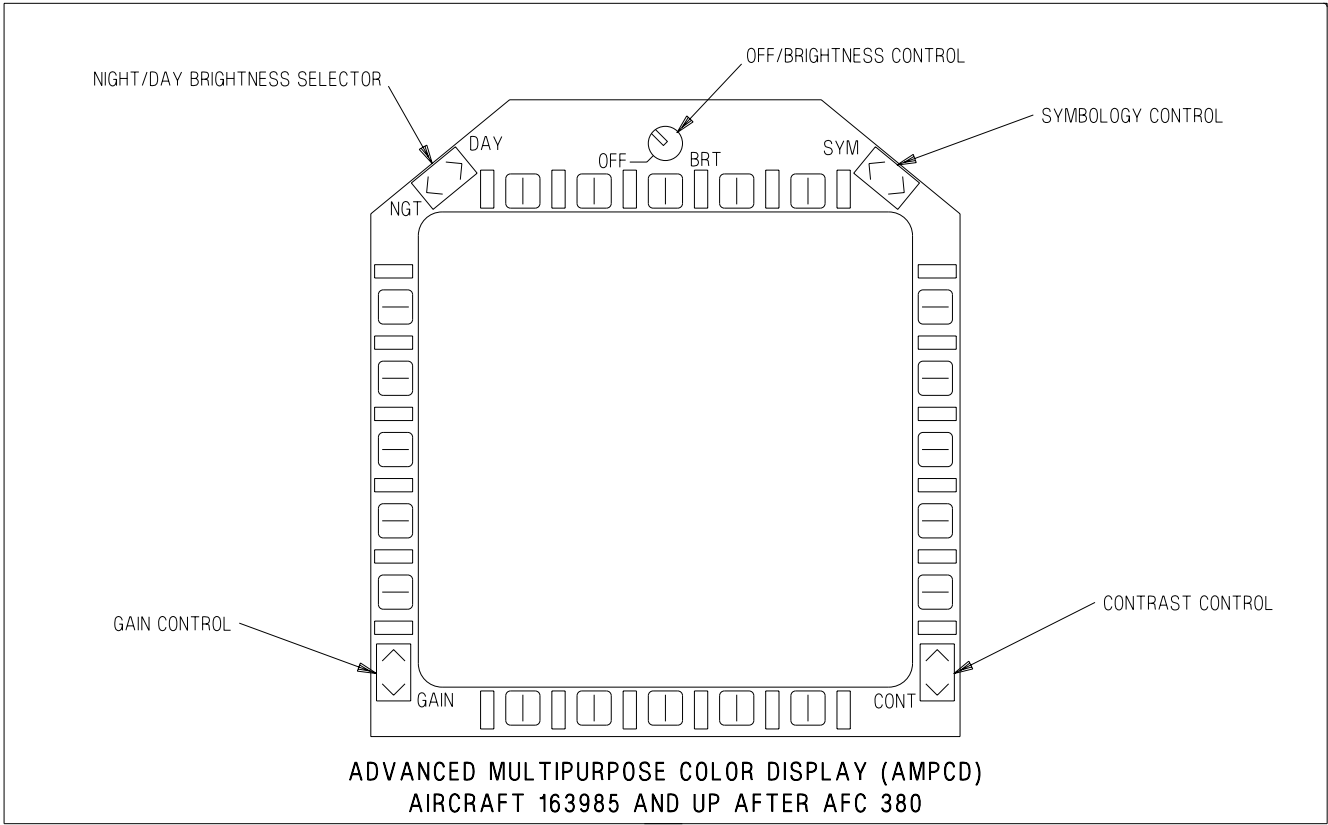

ADA520-124-3-051

Figure 2-24. HI/MPCD/AMPCD Controls and HSI Symbology (Sheet 2 of 3)

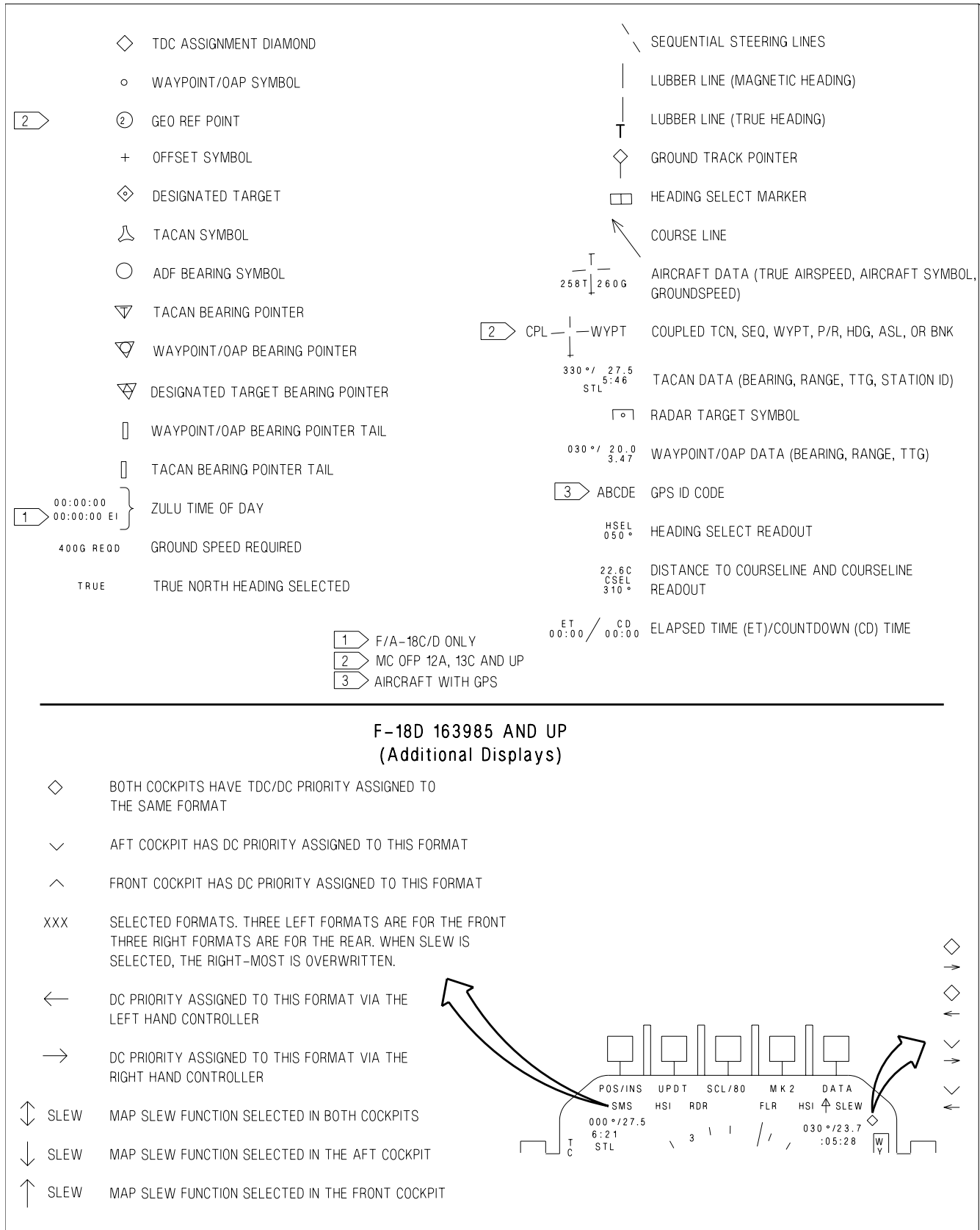

ADA520-124-2-047

Figure 2-24. HI/MPCD/AMPCD Controls and HSI Symbology (Sheet 3 of 3)

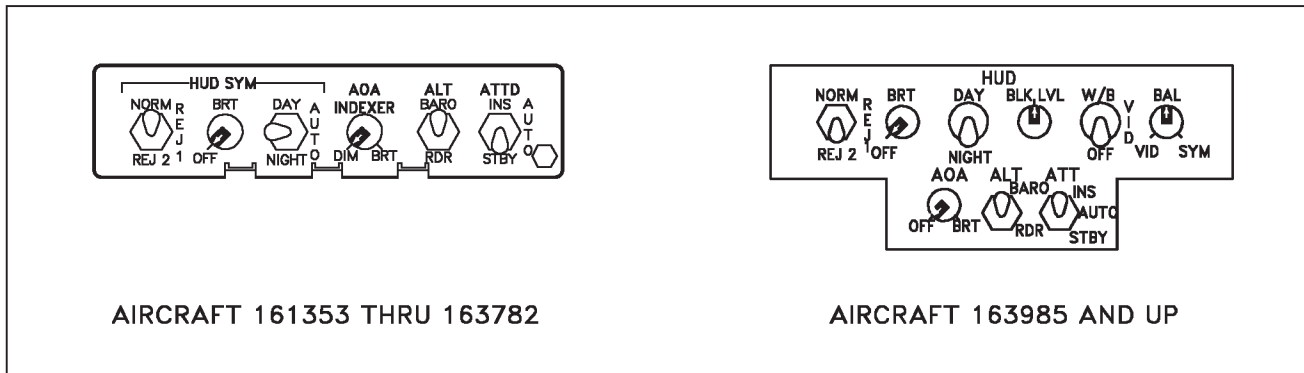

18AC-NFM-00-(138-1)31-CATI

Figure 2-25. HUD Controls

2.13.4.8 Head-Up Display (HUD). The HUD is on the center main instrument panel. The HUD is used as the primary flight instruments, weapon status, and weapon delivery display for the aircraft under all selected conditions. The HUD receives attack, navigation, situation, and steering control information from the left or right DDI symbol generators (under mission computer control), and projects symbology on the combining glass for head-up viewing. The HUD is electrically interfaced with the UFC. On aircraft 163985 AND UP the HUD has been enhanced by adding NVG compatible raster display capability so as to allow it to display NFLR video. The most visible change to the HUD can be noticed on the HUD control panel (figure 2-25) below the UFC.

2.13.4.8.1 HUD Symbology Reject Switch. This three-position toggle switch has positions of NORM, REJ 1, and REJ 2. With the switch placed to NORM, the normal amount of symbology is provided for all HUD displays. Placing the switch to REJ 1 removes aircraft mach number, aircraft g's, bank angle and pointer, airspeed box, altitude box, peak positive g, and required ground speed cue from the HUD. Placing the switch to REJ 2 removes all REJ 1 symbology plus the heading scale, current heading indication (caret/T), command heading marker, NAV/TACAN range, and the ET, CD, or ZTOD timer.

2.13.4.8.2 HUD Symbology Brightness Control. This knob is used to turn on the HUD and then varies the display intensity.

2.13.4.8.3 HUD Symbology Brightness Selector Knob. This is a three-position toggle switch with positions of DAY, AUTO, and NIGHT. Placing the switch to DAY provides maximum symbol brightness in conjunction with the HUD symbology brightness control. Placing the switch to AUTO allows automatic control of the contrast by the automatic brightness control circuit. On aircraft 163985 AND UP the AUTO position is deleted. With the switch set to NIGHT, a reduced symbol brightness is provided in conjunction with the HUD symbology brightness control.

2.13.4.8.4 HUD Video Control Switch (Aircraft 163985 AND UP). The video control switch is a three-position switch with positions of OFF, VID, and W/B. The video control switch enables NFLR video to be displayed on the HUD with selectable polarity (white hot/black hot).

2.13.4.8.5 Black Level Control (Aircraft 163985 AND UP). The black level control knob adjusts the NFLR video plus or minus $\frac{1}{2}$ a shade of gray per increment when rotated.

2.13.4.8.6 Balance Control (Aircraft 163985 AND UP). The balance control knob adjusts the stroke brightness relative to the raster brightness. Rotating the knob from 12 o'clock towards the VID position

holds the brightness of the video (as set by the brightness control knob) and reduces the brightness of the stroke symbology. The opposite is true when rotating the knob toward the SYM position.

2.13.4.8.7 AOA Indexer Control. This knob controls the brightness of the indexer lights.

2.13.4.8.8 Altitude Switch. This is a two-position toggle switch with positions of BARO and RDR. This switch is used to select either radar altitude (RDR) or barometric altitude (BARO) for display on the HUD, and as the primary altitude source for the mission computer.

2.13.4.8.9 Attitude Selector Switch. This three-position toggle switch has positions of INS, AUTO, and STBY. Placing the switch to AUTO or INS selects filtered INS data as the primary source of attitude information. With the ASN-130 installed, the INS automatically reverts to attitude heading reference system (AHRS) using unfiltered data if its processor fails. The mission computer automatically selects the standby attitude reference indicator for attitude information if the INS fails completely. Placing the switch to STBY selects the standby attitude reference indicator as the source of attitude information for the mission computer and displays. With the FCCs no longer receiving INS data, Xs are set in CH 1/3 of PROC row on the FCS page. With the ASN-139 or EGI installed, the INS automatically reverts to the standby attitude reference indicator. With the ASN-139 or EGI installed, a partial alignment may result in the gyro mode of the INS/EGI being activated. Selecting the attitude source on the EADI does not change the source of attitude data for the HUD.

2.13.4.8.10 Fault Indicator. The indicator displays unit operational status: white for failed and black for normal.

2.13.4.8.11 HUD Symbology. The following paragraphs describe HUD symbology as related to basic navigation, steering (direct great circle, courseline, and ILS), navigation target designation, advisories and landing, see figure 2-26. Refer to part VII for a description of how these symbols are integrated into the navigation system. Also, refer to part VII for unique ACL data link symbology. Refer to NTRP 3-22.2-FA18A-D NATIP and NTRP 3-22.4-FA18A-D NATIP for symbology concerning the A/A and A/G master modes, weapons, RWR and the data link vector mode.

1. Heading. The aircraft magnetic/true heading is indicated by the moving 30° heading scale. The actual aircraft heading is directly above the caret/T symbol. The moving heading scale provides trend information during turns. As the aircraft turns right, the scale moves from right to left. Magnetic or true heading may be selected. Magnetic heading is indicated by a caret below the heading scale. True heading selection is indicated by a T appearing below the current heading.
2. Airspeed. Calibrated airspeed from the air data computer is provided in the box on the left side of the HUD. The tops of the airspeed and altitude boxes are positioned at the aircraft waterline (4° up from the optical center of the HUD).
3. Altitude. The altitude presented in the box on the right side of the HUD may be either barometric altitude or radar altitude depending on the setting of the altitude switch on the HUD control panel. When the altitude switch is in BARO, barometric altitude is displayed. When the altitude switch is in RDR, radar altitude is displayed and is identified by an R next to the altitude. If the radar altitude is invalid, barometric altitude is displayed and a B next to the altitude flashes to indicate that barometric altitude is being displayed rather than radar altitude. With MC OFP 13C AND UP, an X displayed next to the barometric altitude indicates that the altitude value may be inaccurate. The thousand and ten thousand digits are 150% size numbers. The hundred, ten, and unit digits are 120% size numbers, except that below 1,000 feet they are 150% size.

4. Barometric setting. The barometric setting used by the air data computer (ADC) is the value set in the standby altimeter. When the barometer setting is changed on the standby altimeter, the ADC barometric setting is presented below the altitude on the HUD to provide a head-up baro-set capability. The display remains for 5 seconds after the change is made. In addition, the baro-set value is displayed and flashed for 5 seconds when the aircraft descends below 10,000 feet at an airspeed less than 300 knots.
5. Angle of attack. True angle of attack in degrees is displayed at the left center of the HUD. The primary source for this information is the ADC. If the ADC produces invalid AOA outputs, the MC uses FCC information to derive the AOA display. There is no pilot queuing when the MC switches AOA sources from ADC to FCC because both components get AOA information from the AOA probes. For lower AOA values, HUD AOA is an average of the AOA probe readings received by the ADC. Above 34° AOA, HUD AOA is estimated and provided by the INS.
6. Mach number. The aircraft mach number is displayed immediately below the angle of attack.
7. Aircraft g. Normal acceleration of the aircraft is displayed immediately below the Mach number.
8. Peak aircraft g. A peak positive g indication is displayed on the HUD below the normal g anytime a threshold of 4.0 g is exceeded. The peak positive g display can be removed by cycling the clutter reject switch to one of the reject positions.
9. Bank angle scale. A bank angle scale and pointer are displayed at the bottom of the HUD for bank angle reference up to 45°. At bank angles in excess of 47°, the bank angle scale pointer is limited at 45° and flashed.
10. Velocity vector. The velocity vector provides the pilot with an outside world reference with regard to actual aircraft flight path. The velocity vector represents the point towards which the aircraft is flying (aircraft flight path). The position of the velocity vector is limited to an 8° radius circle centered at the HUD optical center. If the velocity vector reaches this limit during high angle of attack flight or large yaw and/or drift angles, then it flashes rapidly to indicate that it does not accurately indicate flight path. With GPS or EGI installed, if the INS velocity data becomes unreliable, the mission computer utilizes the GPS information. If INS velocity data becomes unreliable the mission computer utilizes air data computer information and the last available wind data to compute the velocity vector and this degraded velocity vector is indicated by a slow flashing of the symbol. In the NAV master mode, the velocity vector may be caged to the vertical center line of the HUD by the cage/uncage switch on the throttle. When it is caged, a ghost velocity vector is displayed at the true velocity vector position if that position is more than 2° from the caged position. The flight path/pitch ladder and steering information are

referenced to the caged position. The ghost velocity vector flashes when limited. With MC OFP 13C AND UP, the flight path/pitch ladder is referenced to the waterline symbol when the velocity vector is caged.

WARNING

Sustained climbs and descents can result in uncued vertical velocity placement errors and subsequent HUD velocity placement errors. Error magnitudes increase at slower airspeeds and lower altitudes. Errors of up to 3° have been observed in the landing configuration. Three minutes of level flight may be required to allow the INS to correct the vertical velocity function.

11. Flight path/pitch ladder. The vertical flight path angle of the aircraft is indicated by the position of the velocity vector on the flight path/pitch ladder. The horizon and flight path/pitch angle lines represent the horizon and each 5° of angle between plus and minus 90°. Positive pitch lines are solid and are above the horizon line. Negative pitch lines are dashed and are below the horizon line. The outer segments of the lines point toward the horizon. Each line is numbered and the numbers rotate with the lines so that inverted flight can easily be determined. To aid in determining flight path angle when it is changing rapidly, the pitch lines are angled toward the horizon at an angle half that of the flight path angle. For example, the 50° pitch line is angled 25° toward the horizon. In level flight, the pitch lines are not angled. The zenith is indicated by a circle and the nadir is indicated by a circle with an X in it. Aircraft pitch angle can be determined by comparing the tops of the altitude and airspeed boxes (which represent the aircraft waterline) with the pitch ladder when the wings are level. However, since the flight path/pitch ladder normally rotates about the velocity vector, determination of pitch angle may be difficult at high roll angles.
12. Vertical velocity readout. This value is displayed above the altitude box and indicates vertical velocity in feet per minute. This is only displayed in the NAV master mode. Descent is indicated with a minus sign.
13. HUD landing symbology. When any two landing gear are down, the Mach number, g, and peak g are deleted and, an AOA bracket, extended horizon bar, and waterline symbol appear. The center of the AOA bracket represents the optimum approach AOA. The bracket moves lower with respect to the velocity vector as AOA increases and moves higher as AOA decreases.
14. Waypoint/OAP, mark point, TACAN, or target data. Waypoint/OAP and mark data consists of range (horizontal), the steer to point identifier (W, O, or M), and number, located on the lower right corner of the HUD. TACAN data consists of slant range and a morse code identifier located on the lower right corner of the HUD. When a steer to point is designated, range remains displayed and the steer-to point identifier changes to TGT.
15. Coupled steering symbology. With MC OFP 13C AND UP, while coupled steering is engaged CPL SEQ#, CPL WYPT, CPL TCN, CPL BNK or CPL ASL appear on the right side of the HUD display above the navigation data.
16. ILS symbology. When ILS steering is selected, an azimuth deviation bar (localizer) and elevation deviation bar (glideslope) appear on the HUD.

17. ZTOD, ET, and CD time. The ZTOD, ET, or CD time is displayed on the lower left corner of the HUD. These timers are mutually exclusive. Only one timer is available for display on the HUD at a time. Selecting any one automatically deselects the others. For F/A-18A/B aircraft, ZTOD must be set to be available for display. For F/A-18C/D aircraft, when the FIRAMS real time clock power up BIT passes, ZTOD does not need to be entered, but when the FIRAMS real time clock power up BIT does not pass, ZTOD must be entered. ET initializes to zero minutes and seconds. CD initializes to six minutes and zero seconds.
18. Command heading marker. When waypoint/OAP or TACAN direct great circle steering is selected, the command heading marker is displayed just below the heading scale.
19. Steering arrow and dots. When waypoint/OAP or TACAN course line steering is selected, the steering arrow and dots appear on the HUD.
20. Required ground speed cue. When steering is engaged to the target in a sequence, the required ground speed cue appears under the airspeed box.
21. Target designation symbology. When a target is designated, a target designation symbol (diamond) appears below the heading scale indicating target heading. Another target designation symbol (diamond) appears indicating the target line of sight (LOS).

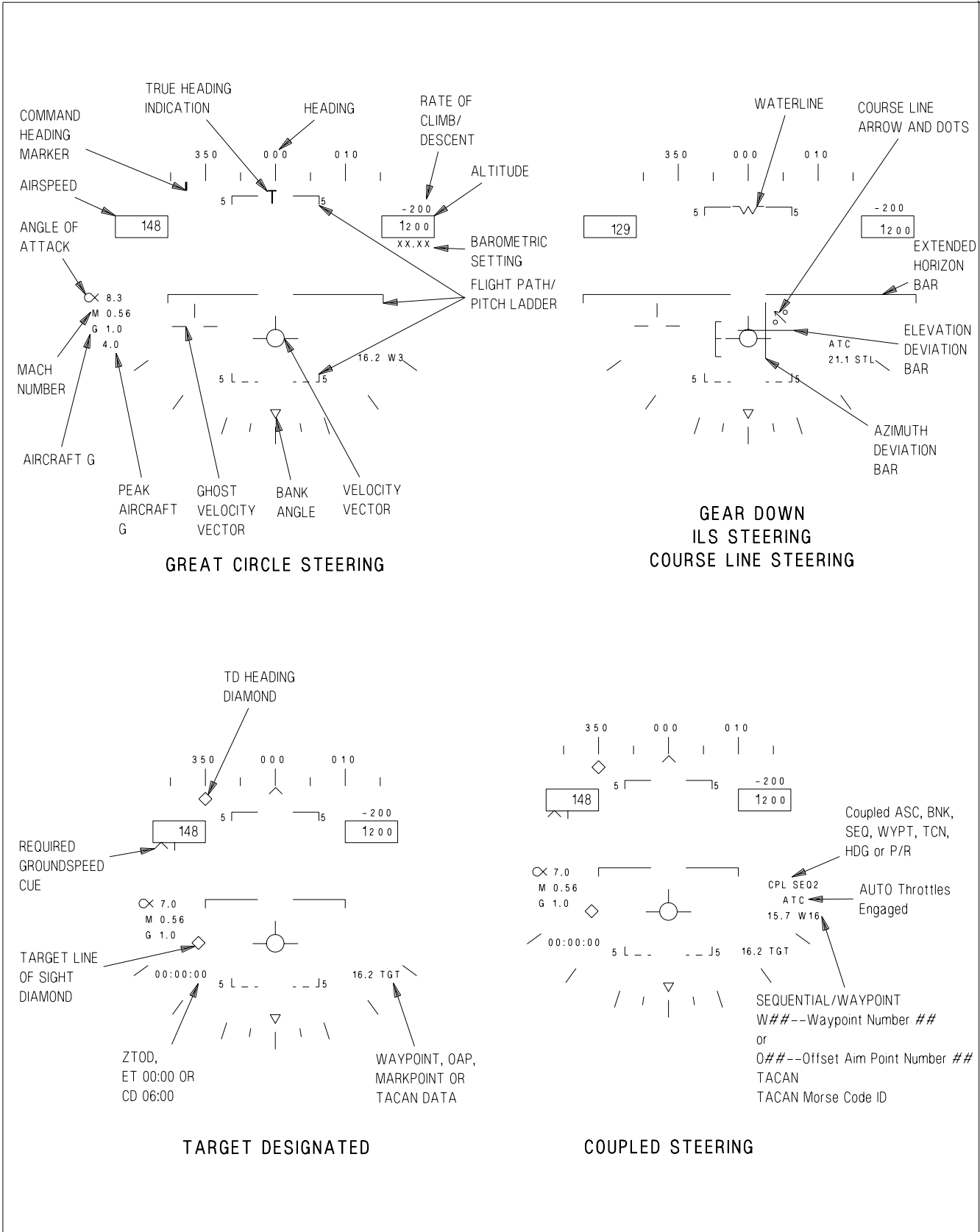

ADA520-23-1-045

Figure 2-26. HUD Symbology (Sheet 1 of 2)

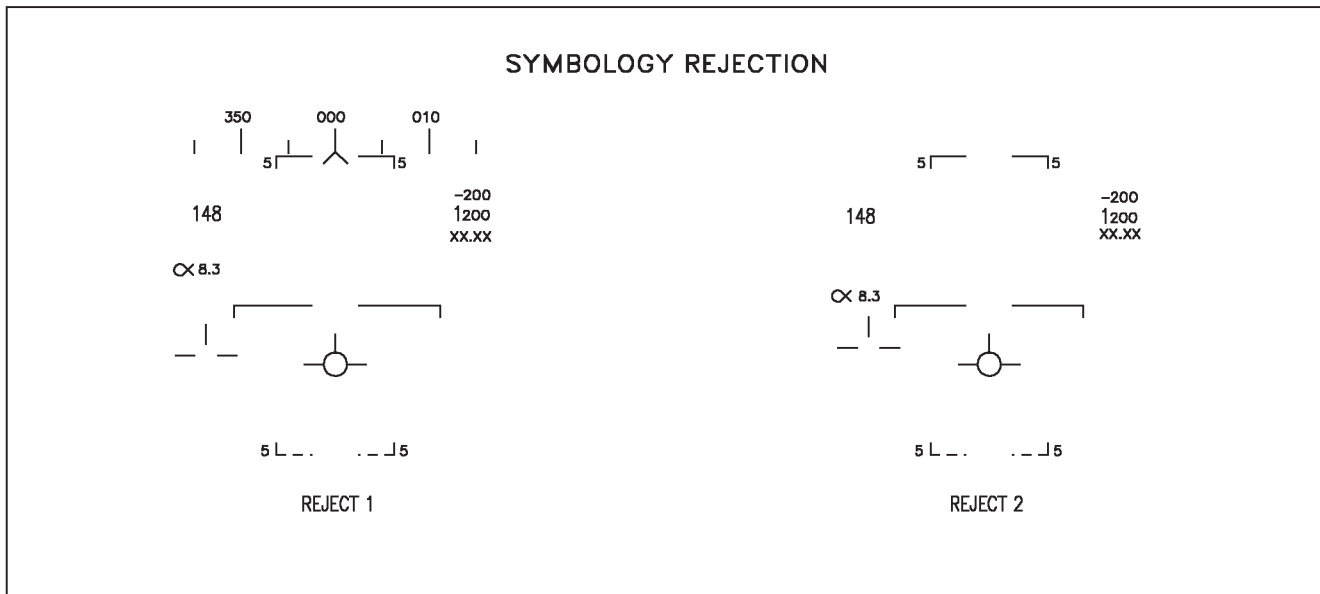

18AC-NFM-00-(23-2)31-CATI

Figure 2-26. HUD Symbology (Sheet 2 of 2)

2.13.4.8.12 HUD Symbology Degrades. The avionics suite has built-in redundancy with two mission computers for data management and two DDI for symbol generation. Likewise, if the attitude select switch is in the AUTO or INS position, back-up data sources are automatically selected to provide HUD symbology when specific failures are detected. Refer to figure 2-27, for the HUD displays discussed below.

2.13.4.8.13 INS Failure/HUD Symbology Degrades. When a failure occurs in the INS expect HUD bank angle, velocity vector, pitch ladder, and heading indications to be impacted. With GPS or EGI installed, the mission computer utilizes GPS information for the velocity vector. If INS attitude is valid but INS velocities are not valid, the mission computer automatically uses the INS attitude and GPS velocities to position a non-flashing velocity vector. With a degradation of the ADC, calibrated airspeed, barometric altitude, indicated Mach number, and vertical velocity indications may be impacted.

When the ASN-130 system reverts to the attitude heading reference system (AHRS) mode, the velocity vector flashes slowly indicating that the INS is still providing valid attitude information, but the ADC is now the data source for the velocity vector. An AHRS reversion can be the result of an INS BIT failure, or invalid INS velocity information. It is important to understand that AHRS is not an independent back-up platform, but actually a degraded INS system. In the AHRS mode, a very slight degrade in HUD attitude and velocity accuracy can be expected, warranting regular crosschecks of the standby instrumentation. A reversion to AHRS is accompanied by the master caution light, tone, and POS/ADC caution, provided that the INS has been selected on the HSI display as the position-keeping source.

When the INS experiences a total shutdown (dump) with the attitude select switch in AUTO or INS, or if the attitude switch is deliberately placed in standby, a stationary waterline symbol replaces the velocity vector indicating that the standby attitude reference indicator is now providing attitude data. This failure is normally accompanied by the master caution light, tone, and INS ATT caution. Place

the attitude select switch in the STBY position, crosscheck the HUD against standby instruments, and attempt an inflight alignment.

NOTE

If an INS ATT caution is set or the ATT switch is placed to STBY, Xs appear in CH 1/3 of the PROC row of the FCS page indicating FCCs no longer use INS data. There is no significant degradation to flying qualities, departure resistance or roll performance with these failure indications.

If power to the HUD is lost, either due to a fault or by placing the HUD symbology brightness control knob to OFF, the attitude selector switch becomes inoperative. If an insidious INS failure is followed by a HUD failure, the only accurate source of attitude information available is the standby attitude reference indicator. The electronic attitude display indicator can be selected as an alternative display on the DDI. The STBY option available on the EADI operates independent of the attitude selector switch and allows selection of the standby attitude reference indicator as the source for display attitude information.

Due to the tendency of the standby attitude reference indicator to precess, it is suggested that flying in instrument meteorological conditions (IMC) using the ARI as a primary attitude reference be minimized. A partial IFA is always recommended whenever possible to recover the INS attitude platform.

2.13.4.8.14 ADC Failure/HUD Symbology Degrades. An ADC failure results in loss of associated data from the HUD display as shown in figure 2-27. An ADC failure also inhibits operation of cruise flight Automatic Throttle Control and disables the altitude signal used for IFF altitude reporting. An ADC failure may affect cabin air flow, cabin air temperature, and vent suit temperature.

Normal accurate air data and magnetic heading inputs that are supplied by the ADC to the mission computers are lost. However, flight aids reversion mechanization provides information to the pilot from the next best available source (figure 2-39). HUD airspeed and BARO altitude boxes are empty, unless aircraft altitude is less than 5,000 feet AGL with RADALT to HUD, aircraft altitude AGL will be displayed in the HUD altitude box. Failure of the air data computer provides the pilot with the following indications:

IF GEAR UP -

1. Light in the gear handle and continuous beeping tone.
2. HUD airspeed box empty.
3. HUD altitude box empty if aircraft > 5,000 feet AGL.
4. HUD altitude box displays AGL with RADALT to HUD and aircraft < 5,000 feet AGL.
5. Standby instruments indicate correct altitude and airspeed.
6. BIT page indicates ADC - NOGO (A/B), MUX FAIL (C/D), or NOT RDY

IF GEAR DOWN -

1. HUD airspeed box empty.
2. HUD altitude box empty if aircraft > 5,000 feet AGL.
3. HUD altitude box displays AGL with RADALT to HUD.
4. AOA derived indication displayed on the HUD E-bracket.
5. Standby instruments indicate correct altitude and airspeed.
6. Internal/External AOA indexers inoperative

As the ADC degrades, loss of some or all of the following data from the HUD may occur:

1. Calibrated airspeed or barometric altitude. The loss of calibrated airspeed and/or barometric altitude data results in activation of the landing gear handle warning light and tone. First reference the applicable standby airspeed or altitude indicator, then silence the tone.
2. Angle of Attack. Loss of AOA requires no action on the part of the pilot, as the FCC automatically provides data for the HUD display. In fact, there is no indication provided to the pilot when this failure occurs.
3. Vertical velocity indicator. Upon loss of the vertical velocity indication, first check that the aircraft is in the NAV master mode and reference the standby vertical velocity indicator.
4. Mach number. Upon loss of the Mach number indication, reference the standby airspeed indicator.

The ADC can produce erroneous signals without cautions or advisories if the pitot or AOA probes receive damage. ADC inputs to the MC are used by the INS to help smooth or dampen pitch ladder and velocity vector position. A complete ADC failure does not immediately affect the pitch ladder/velocity vector, but these displays will eventually degrade. If subtle damage to the AOA probe is suspected, the pilot should make a crosscheck of airspeed with a wingman if possible. The standby airspeed indicator receives signals from the left pitot static probe, so it is accurate if only the right probe is damaged. AOA checks with a wingman should be made in landing configuration if a jammed AOA probe is suspected. Crosschecking with flaps AUTO may give a satisfactory crosscheck, but the probe may be bent in such a way that AOA anomalies are accentuated on landing configuration. Landing with automatic throttle control (ATC) may be affected. If damage is suspected, ATC during landing is not recommended.

With the exception of a single AOA probe jammed on takeoff (see paragraph 15.32) if an AOA probe becomes jammed (does not move), the ADC and FCCs continue to receive valid signals until the pilot executes a maneuver that causes the reading between the AOA probes to differ more than 15°. The pilot receives a master caution and FCS caution. HUD displayed airspeed may be inaccurate without pilot error indications if a pitot tube is damaged. Be alert for unannounced pitot tube or AOA probe damage after bird strikes, icing conditions, or IFR basket impact during air refueling.

With MC OFP 13C AND UP. Displays of the L and R AOA probe values, and the INS AOA (center) value, were added to the FCS status page. With MC OFP 13C and 15C, these AOA values are only displayed when the ADC declares the AOA valid (<15.5°). With MC OFP 17C and 19C, the L and R AOA values continue to be displayed even when the ADC declares the AOA invalid, but the values are lined out. The center AOA value is driven by the INS and is always displayed, regardless of AOA validity.

When the ADC declares AOA valid, the L and R AOA values can be boxed and selected, in the event one AOA is damaged. The center (INS) AOA value allows the pilot to compare against L and R AOA values to determine which is the good AOA probe. GAIN ORIDE must be selected to enable selection of a single probe to drive the HUD E-bracket. Even with one AOA probe selected, AOA indexer and approach lights are still driven by the average value to both probes and will be inaccurate. For carrier landings, advise the LSO that the external approach light indications are inaccurate.

If the ADC declares AOA invalid, the HUD E-bracket and AOA numeric displays disappear, and the indexer and external approach lights are inoperable.

2.13.4.8.15 HUD Advisory Data Symbology. The displays in figure 2-27 show some of the advisories that can appear on the HUD in the NAV master mode. The advisories are associated with nose wheel

steering, and approach power compensator. Although the advisories are shown on the gear down display, most of them can appear on the basic HUD display. Refer to Part VII for description of data link system and advisories.

The automatic throttle control/nosewheel steering advisories are displayed above the distance display whenever the ATC or the NWS is engaged. If the ATC is disengaged by any means other than actuation of the ATC engage/disengage switch, the advisory is flashed for 10 seconds before it is removed from the display or, if an attempt to engage ATC is not successful, then ATC is flashed for 10 seconds then removed.

2.13.4.8.16 HUD BIT Checks. The HUD has two methods of built-in tests: manually initiated and automatic test. Refer to Status Monitoring Subsystem, figure 2-38 for the procedures and displays used for the HUD BIT checks.

2.13.4.9 Course Set Switch. The course set switch manually sets the desired course on the HSI display.

2.13.4.10 Heading Set Switch. The heading set switch manually sets the heading marker on the desired heading on the HSI display.

2.13.5 Upfront Control (UFC). The UFC (figure 2-28) is on the main instrument panel below the HUD. The UFC is used to select autopilot modes and control the IFF, TACAN, ILS, data link, radar beacon, UHF radios and ADF. With AFC 270, D/L toggles between LINK 4 and LINK 16 and MIDS is turned on/off via TACAN or LINK 16. The UFC is used in conjunction with the two DDIs and the HI/MPCD/AMPCD to enter navigation, sensor, and weapon delivery data. UFC option selections and inputs are primarily transmitted directly to the communication system control for discrete control of the CNI equipment or for routing to the mission computers. In aircraft 163985 AND UP the UFC is NVG compatible. A description of the UFC switches and displays follows. Refer to Part VII for operating instructions for CNI equipment.

2.13.5.1 Brightness Control Knob. The knob has positions of BRT (bright) and DIM. The brightness of the display increases as the knob is rotated clockwise toward BRT.

2.13.5.2 Emission Control Pushbutton. This pushbutton is labeled EMCON. Pushing the button inhibits IFF, tacan, radar, radar beacon, radar altimeter, two-way data link, and Walleye from transmitting. The letters E, M, C, O, and N are displayed in a vertical column in the five option windows when EMCON is selected. Pushing the button again permits the transmitters to radiate.

2.13.5.3 I/P Pushbutton. Pushing this momentary pushbutton causes the IFF to respond to mode 1, 2, and 3 interrogations with identification of position response (IDENT).

2.13.5.4 ADF Function Select Switch. Actuating this switch to the 1 position selects comm 1 for ADF operation. In the OFF position ADF is disabled. In the 2 position comm 2 is selected for ADF operation.

2.13.5.5 Option Select Pushbuttons. The five pushbuttons select or deselect the displayed options.

2.13.5.6 Pilot Cueing. A colon (:) is displayed when an option is selected. The colon disappears when an option is deselected.

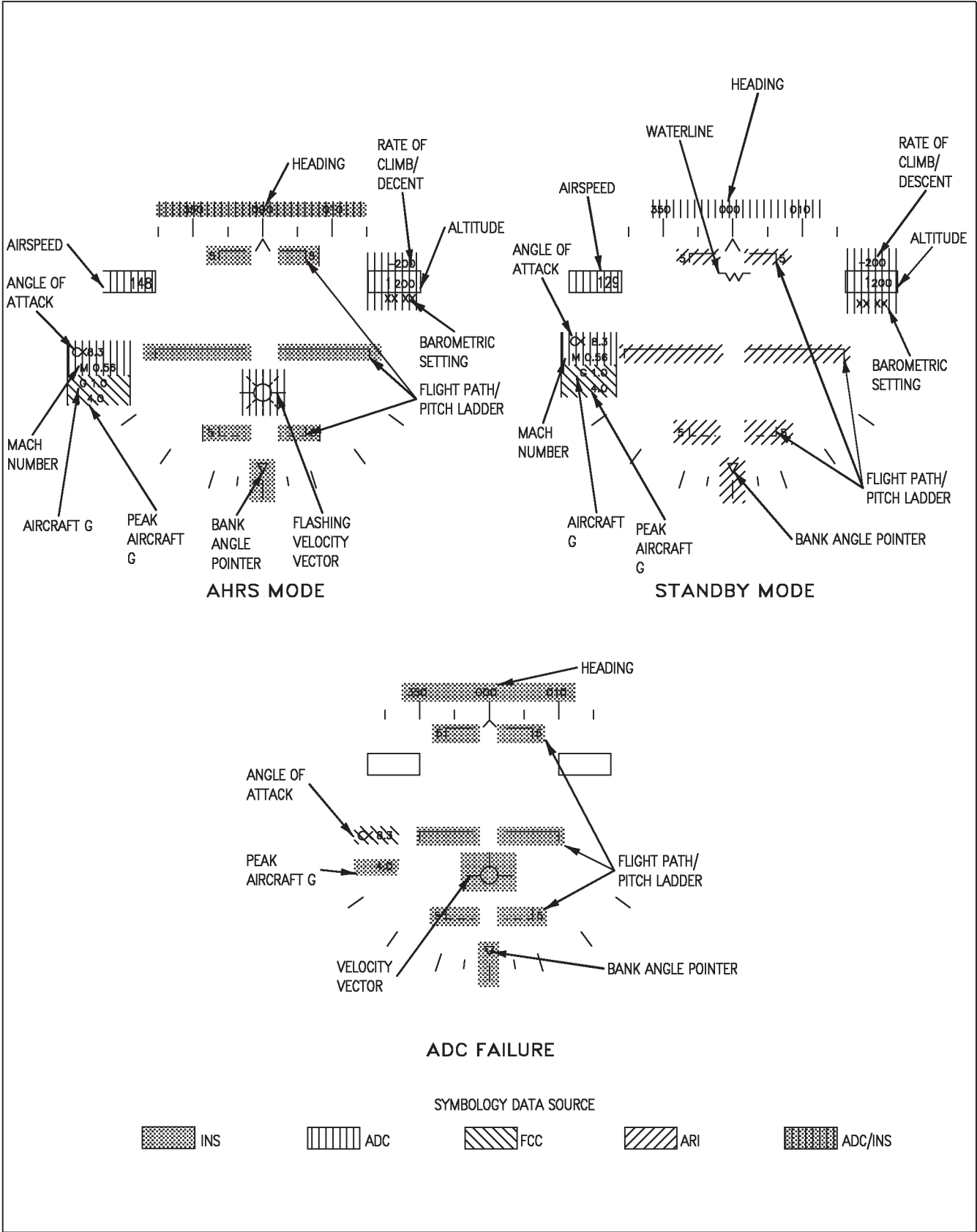

Figure 2-27. HUD Symbology Degrades

command from the mission computer terminates all prior activity, with all previous entries retained, and presents the options for the newly selected mode.

2.13.5.11 Volume Controls. Turning the volume control to the OFF position turns off the corresponding radio. The comm 1 and comm 2 channel display windows illuminate if the respective radios are on. Out of the OFF position, the knob controls the audio volume for the corresponding radio.

2.13.5.12 Channel Selector Knobs. Rotating the knob selects channel 1 thru 20, manual (M), or guard (G). The channel is displayed in the corresponding comm 1 or comm 2 channel display window. Pulling the spring-loaded knob causes the selected channel and its frequency to be displayed in the scratchpad and enables the control converter to change the frequency of the selected channel via the keyboard entry.

2.13.5.13 Channel Display Windows. When the corresponding radio is on, the selected channel (1-20, M or G) is displayed on the 16 segment alphanumeric display window. The diagonal display segment in the lower right quadrant of each display window illuminates whenever transmissions are received on comm 1 and comm 2, respectively.

2.13.6 Signal Data Computer (F/A-18C/D). The signal data computer (SDC), under mission computer control, records aircraft fatigue strain data, engine parameters when out of tolerance conditions occur, fuel information and aircraft and target parameters when targets are designated and weapons are delivered. It includes fuel transfer controls and gaging capabilities, incorporates ground support equipment fuel transfer and gaging fault isolation functions, and provides interface for multiple sensors and controls. It provides analog to digital conversion of aircraft parameters. In addition, BIT fail indications are stored in the SDC to be displayed by the maintenance status panel (MSP) for readout by maintenance personnel after the flight, or on the integrated fuel/engine indicator (IFEI) for readout during the flight.

The fuel format is available on any DDI by selection of the FUEL push button from the menu format, and the RESET SDC option is available from the fuel format. RESET SDC is used to reset the SDC by momentarily removing power to the SDC. When the push button is first pressed, the RESET portion of the button legend is boxed. The box is removed when the SDC reestablishes AVMUX communication or 15 seconds after the push button was pressed. The RESET SDC legend is removed from the fuel format if the CSC is not communicating on the AVMUX.

In aircraft equipped with GPS, it is important to manually load Zulu time as this aids in satellite acquisition. If local time is desired, it should be set after takeoff. The aircraft signal data computer is used to initialize GPS. At GPS power up, the SDC time and date are automatically sent to the GPS to aid it in the acquisition of satellites. Once the satellites are acquired for the first time, the GPS obtains a good satellite time. This time is then backloaded to the SDC, synchronizing the SDC with precise GPS time. The GPS is loaded with GPS precise time only once per cold start. Changing the SDC time or date with WOW reinitializes the GPS.

2.13.7 Video Tape Recording System (VTRS) (Aircraft 161353 THRU 164912 BEFORE AFC 207). The video tape recording system (VTRS) consists of a video tape recorder and a HUD video camera. In addition, the system utilizes other existing aircraft equipment.

2.13.7.1 DDI Video. Weapon video is provided by television or infrared sensors for display on the DDIs and for recording on the VTRS tape. Radar video is provided from the radar receiver for display on the DDI and for recording on the VTRS tape. The weapon and radar video recorded on the tape does not include the mission computer system symbology displayed on the DDI.

2.13.7.2 Video Tape Recorder. The video tape recorder accepts composite video from the HUD video camera or the left or right DDI along with headset audio, and provides a minimum of 30 minutes recording time on removable 3/4 inch U-matic tape cartridges. The headset audio is only available for recording when the KY-58 encryption function is inactive.

2.13.7.3 HUD Video Camera. The HUD black and white video camera (HVC) output of the HUD display superimposed on the image of the outside world is made available to the video tape recorder. The switches for operating the VTRS are on the HUD video camera control panel.

2.13.7.4 HUD Video Camera Control Panel. The HVC control panel contains a HUD/DDI selector switch, a mode selector switch, a BIT initiate pushbutton, and go/no-go indicators.

2.13.7.4.1 IFEI Brightness Control Knob. On aircraft 164865 AND UP, the IFEI brightness control knob provides variable IFEI lighting between OFF and BRT with the mode switch on the interior light panel in either NITE or NVG position.

2.13.7.4.2 HUD/DDI Selector Switch. The HUD/DDI selector switch has positions of HUD, L DDI, and R DDI.

HUD Head-up display imagery superimposed on the outside world is recorded.

L DDI The radar or weapons video supplied to the left DDI is recorded.

R DDI Information supplied to the right DDI same as left DDI and recorded.

2.13.7.4.3 Mode Selector Switch. The mode selector switch has positions of MAN, AUTO, and OFF.

MAN The VTRS is recording continuously. The HUD/DDI selector switch can be set to the desired position for recording.

AUTO If the aircraft is operating in the A/A or A/G master mode, the HUD video camera and the video tape recorder run continuously and record whatever is selected on the HUD/DDI selector switch. However, if the first detent on the trigger or the weapon release button is pressed, the VTRS automatically records the HUD display. If the A/G master mode is selected and the FLIR display is on either DDI, the VTR does not switch to record the HUD.

OFF The VTRS is inoperative.

When the HUD video is being recorded as a result of a trigger switch or weapon release button actuation, the HUD video continues to be recorded for a preset overrun time after the control is released. For Sidewinder launches and gun firing, the overrun time is 5 seconds. For Sparrow launches and A/G weapon releases, the overrun time is 10 seconds.

2.13.7.4.4 BIT Initiate Pushbutton. The pushbutton is pressed to test the HUD video camera. The GO and NO GO balls are normally black. If the BIT test is good, the GO ball shows green. If the BIT test is not good the NO GO ball shows orange.

2.13.7.5 Event Mark. When the weapon release button is pressed, an event mark signal is supplied to the HUD video camera. At that time a black box is generated by the camera and appears in the

upper left corner of the video signal going to the video tape recorder. When the trigger is actuated to the second detent position to launch a missile, the event mark is generated and recorded until the trigger is released.

2.13.7.6 Recorder On Light. The RCDR ON light, on the right warning/caution/advisory lights panel comes on when the recording system is recording.

2.13.8 Cockpit Video Recording System (Aircraft 164945 AND UP and Aircraft 163985 THRU 164912 AFTER AFC 207). The Cockpit Video Recording System (CVRS) consists of three color auto aperture cameras, two electronic units (EUs), and two 8 mm video recorders. One camera records the HUD and the other two record the left and right DDI's in the front cockpit. One video recorder is dedicated to the RDDI while the other is switchable between the HUD and the LDDI. The DDI cameras, Video Sensor Heads (VSHs), are mounted on top of the canopy frame, one on each side, aft of the DDI's. An EU is mounted directly aft of each VSH.

2.13.8.1 DDI Video. Weapon video, provided by television or infrared sensors, and radar video, provided from the radar receiver, is available for display on the DDI's and recording on the CVRS tapes. The weapon and radar video recorded on the tape includes the mission computer system symbology displayed on the DDI's.

With AFC 408, selecting ENABLE on the NUC WPN switch located above the left console next to the canopy manual handle permits raw video from the FLIR to be recorded when the HUD/LDDI switch is in LDDI and the FLIR display is on the LDDI. With the NUC WPN switch in ENABLE, only the LDDI will be recorded even if the mode selector switch is in AUTO.

2.13.8.2 Video Tape Recorders. One video tape recorder accepts video from the HUD color video camera or the LDDI VSH, and the other video tape recorder accepts video from the RDDI VSH. Both recorders accept headset audio and each provides a minimum of 120 minutes recording time on removable video tape cartridges. The headset audio is only available for recording when the KY-58 encryption function is inactive.

2.13.8.3 HUD Video Camera. The HUD color video camera (HVC) output of the HUD display superimposed on the image of the outside world is made available to the video tape recorder.

2.13.8.4 CVRS Control Panel. The switches for operating the CVRS are on the HUD video camera control panel. The control panel contains an IFEI brightness control knob, a HUD/LDDI selector switch, and a mode selector switch.

2.13.8.5 IFEI Brightness Control Knob. The IFEI brightness control knob provides variable IFEI lighting between OFF and BRT with the Mode switch on the interior light panel in either NITE or NVG position.

2.13.8.6 HUD/LDDI Selector Switch. The HUD/LDDI selector switch has positions of HUD and LDDI.

HUD	Head-up display imagery superimposed on the outside world is recorded.
LDDI	The radar or weapons video supplied to the LDDI is recorded.

2.13.8.7 Mode Selector Switch. The mode selector switch has positions of MAN, AUTO, and OFF.

MAN	The CVRS is recording continuously. The HUD/LDDI selector switch can be set to the desired position for recording.
AUTO	If the aircraft is operating in the A/A or A/G master mode, the video tape recorders run continuously. Selection of the first detent of the trigger, or pressing the weapon release button, automatically records the HUD display regardless of the HUD/LDDI switch position. If in A/G master mode with the FLIR display on either DDI, the HUD is not recorded automatically.
OFF	The CVRS is inoperative.

When the HUD video is being recorded as a result of a trigger switch or weapon release button actuation, the HUD video continues to be recorded for a preset overrun time after the control is released; for Sidewinder launches and gun firing, the overrun time is 5 seconds; for Sparrow launches and A/G weapon releases, the overrun time is 10 seconds.

2.13.8.8 BIT Initiate Pushbuttons. The pushbutton on the HUD video camera or the pushbuttons on the EUs are pushed to BIT the HUD video camera and/or EU/VSH. The GO and NO GO Light Emitting Diodes (LEDs) are normally not illuminated. If the BIT test is good, the GO LED shows green. If the BIT test is not good, the NO GO LED shows amber.

2.13.8.9 Event Marker. When the weapon release button is pressed, an event mark signal is supplied to the HUD video camera. At that time a black box is generated by the camera and appears in the upper left corner of the video signal going to the video tape recorder. When the trigger is pressed to the second detent position to launch a missile, the event marker is generated and recorded until the trigger is released.

2.13.8.10 Recorder On Light. The RCDR ON light, on the right warning/caution/advisory lights panel, comes on when the recording system is recording.

2.13.9 Armpit Camera System. The XC-75 is a monochrome video camera module. It uses a CCD (charge coupled device) solid state image sensor. The system is mounted in the aircraft in place of the forward night vision goggle (NVG) floodlight aft of the canopy control switch box. The camera system measures 1 3/4 X 1 3/16 X 3 5/8 inches , weighs approximately 5 ounces and is designed to operate in temperatures from -5 to 45 ° Celsius. The armpit camera is used to record information from the DDI.

2.13.10 Tactical Aircraft Moving Map Capability (TAMMAC)

The TAMMAC avionics subsystem provides a moving map capability to enhance operational effectiveness and survivability and addresses supportability/obsolescence issues facing existing moving map and data storage systems currently deployed.

TAMMAC effectively replaces three separate Weapons Replaceable Assemblies (WRAs), including the AN/ASQ-196 DVMS which consists of two WRAs; the Digital Map Computer (DMC) and the Digital Memory Unit (DMU), and the AN/ASQ-194 DSS which is a single WRA.

The TAMMAC subsystem consists of a new MU-1119/A Advanced Memory Unit (AMU), a new CP-2414/A digital map computer and a High Speed Interface Bus (HSIB) which connects the two. The DMC is a functional replacement for the existing DVMS. Data Transfer Devices (DTDs) used in conjunction with TAMMAC for transferring data to and from ground-based stations are Personal

Computer Memory Card International Association (PCMCIA) cards or PC cards. Ground-based stations that process data for TAMMAC include the Tactical Automated Mission Planning System (TAMPS) and the Automated Maintenance Environment (AME). Theater data is installed on the maploading card using TAMPS.

The AMU is a functional replacement for the existing DSS, more commonly referred to as the Memory Unit (MU). The AMU contains two PC card receptacles, one for maintenance (ground support) operations and one for mission (pilot) operations. This unique configuration allows maintenance and mission data to be separated both pre- and post-flight which reduces logistics coordination and facilitates operational readiness. Three types of PC cards are used in the TAMMAC subsystem operation: 1) Mission Card, 2) Maintenance Card, and 3) Map Loading Card.

2.13.10.1 TAMMAC Status Monitoring. TAMMAC status monitoring functions are based on the existing MU and DVMS status monitoring functionality. Some of the existing cautions, advisories, BIT mechanizations, and MSP codes that satisfied the requirements for the MU and DVMS were not changed. However, additional status monitoring functionality was added to accommodate changes to the MC/AMU/DMC interfaces including, but not limited to, the PC cards and the High Speed Interface Bus (HSIB).

All existing display references to the MU and DMC are unchanged. The TAMMAC AMU functionality discussed here equates to the MU nomenclature on all existing displays. The TAMMAC DMC equates to the DMC on all existing displays. The only operator change to the status monitoring BIT displays is the addition of the AMU MAINT option.

The MC verifies the AMU and DMC software configuration IDs are compatible with the MC software.

2.13.10.2 AMU Maintenance Format Options and Display Information. The AMU maintenance format contains two relay mode options, MAP LOAD and MBIT. MAP LOAD provides access to sublevel formats used to upload map theater data to the DMC. MBIT is used for troubleshooting and fault isolation.

Information displayed on the AMU maintenance format is limited to the MU OFP configuration ID. The OFP CONFIG identifies the OFP version currently installed in the AMU. See figure 2-29.

2.13.10.3 Map Theater Data Loading. Map theater data loading can include either updates to an existing theater load or a new theater load. In both cases, the map loading cards are processed on TAMPS and loaded in the DMC nonvolatile mass memory using the same procedure. The number of map loading cards is contingent on the size of the update or new theater load. The number of map loading cards can be as few as one or as many as seven.

Map theater data loading is controlled by the map loading format. The map loading format is accessed by selecting the MAP LOAD option (PB 11) on the AMU maintenance format as shown in figure 2-29. The map loading format contains three relay mode options; LOAD, ABORT, and RTN.

2.13.10.4 Map Loading Format Options. The LOAD option (PB 11) is used to initiate a theater load when a map loading card is installed in the AMU maintenance card receptacle and the AMU door is closed. Once the process is initiated, the LOAD option is removed from the format. Multiple card theater loads/updates require the insertion of another map card when prompted by the DDI display. Installing another map loading card and closing the AMU door continues the theater loading process. This procedure is repeated until all theater data is loaded. Map loading cards can be loaded in any sequence.

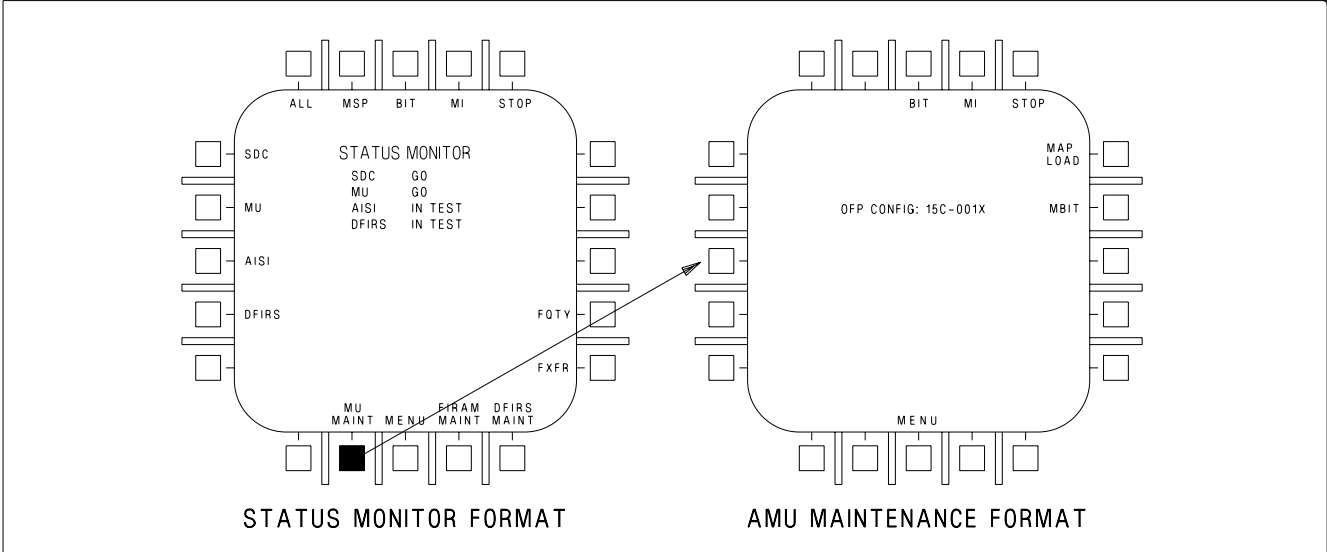

Figure 2-29. AMU Maintenance Format

ADA520-363-1-053

The ABORT option (PB 13) is used to abort a theater load in progress. It is removed from the display prior to and after completion of a load. To initiate an abort, the operator presses PB 13 which changes the option to ABORT ENABLE. Selection of ABORT ENABLE executes the abort process. The ABORT ENABLE legend is displayed for three seconds following selection of the ABORT option. If the operator does not select the ABORT ENABLE option within three seconds, the ABORT legend is redisplayed. The intent of this two-step abort process is to preclude any inadvertent operator initiated aborts from being performed. This abort process is permanent and the entire load process will be terminated.

Aborting a theater map load causes the aborted theater to be deleted. No maps in CHRT, DTED, or CIB will be available if a theater load is aborted. Previous theater maps are automatically deleted upon loading a new theater.

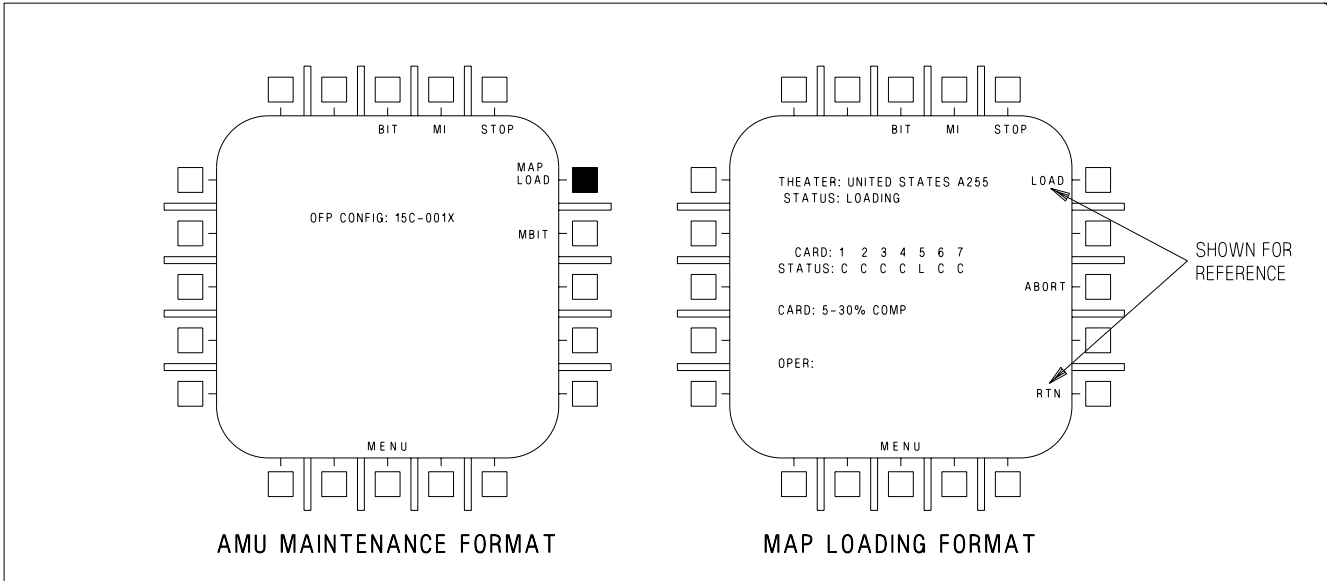

Figure 2-30. Map Loading Format

ADA520-364-1-053

The RTN option (PB 15) is used to return the AMU maintenance format if a theater load is not in progress. If a theater load is in progress, the RTN option is removed from the display.

2.13.10.5 Map Loading Format Status Information. Status information displayed on the map loading format provides the operator with on-line instructions and associated feedback necessary to perform a successful theater load. The information presented is grouped into several status fields; THEATER, STATUS, CARD/STATUS, CARD, and OPER.

The THEATER status field contains; theater identification, theater update revision letter, and the theater update version number that is stored on the map loading card currently being loaded. If at least one card is not installed in the AMU (to initiate the load), the field is blank. After a map loading card is loaded the theater identification information remains displayed as other cards are loaded.

The status field below the THEATER status field contains the overall status of the loading process. This field contains one of the following status indications:

HALTED - Indicates the load process has been halted (between successive cards).

LOADING - Indicates the load process has been initiated and/or is in progress.

ABORTED - Indicates the load process has been aborted.

NO DMS COMM - Indicates HSIB communications with the DMC have failed.

DMS FULL - Indicates the DMC nonvolatile mass memory is full.

LOAD ERROR - Indicates the load process has failed.

WRONG CARD - Indicates the card installed in the AMU maintenance card receptacle is not a Map loading card.

COMPLETE - Indicates the load process has successfully been completed.

CARD/STATUS fields contain status information regarding the PC cards used in the loading process. The CARD field indicates the card ID number(s) in the theater load card set. The maximum number of card IDs that can be displayed is seven. The card ID number(s) displayed is dependent on which order the cards are loaded. The STATUS field below the CARD field contains the actual load status of the card number directly above it. Once the card is installed and the load process initiated, the field contains one of the following status indications:

L - Indicates the card is currently being loaded.

F - Indicates the card has failed to load properly.

C - Indicates the card has been successfully loaded.

If none of the above conditions exists, the STATUS field is blank. If any card fails to load properly resulting in an "F" status, the operator has the option of reinserting the card in an attempt to obtain a successful load.

The CARD field contains the load status of the card that is currently installed. The card ID number is displayed followed by the percent complete (%) for the card. The percentage is displayed in 1% increments.

The OPER field contains instructions for the operator. The field contains one of the following instructional status indications. If any card has yet to be installed for loading, the OPER field is blank.

INIT LOAD - Indicates the AMU is ready to start the load process and the LOAD option needs to be selected.

CLOSE DOOR - Indicates the AMU door needs to be closed.

REMOVE CARD - Indicates the installed card has been successfully loaded and needs to be removed.

INSERT CARD - Indicates another card is required to complete the load process.

2.13.10.6 Map Loading Interruptions. Interruptions to the map theater data loading process can occur as a result of several events: loss of power to the MC, DMC, or AMU, operator aborts, or inadvertent transfers out of AMU relay mode.

If the AMU experiences a power loss greater than five seconds, or if the DMC experiences a power loss of any duration, or if the operator initiates an abort, the interruption in the loading process results in a nonrecoverable abort and the load process cannot be recovered without reloading all the cards.

If power is reapplied to the AMU within five seconds, then the load process can be recovered with minimum impacts. Once the operator reselects the map loading format, the status of the load prior to the interruption is reflected on the format status fields. If a card was in the process of being loaded when the interruption occurred, its status is blank indicating it has not been loaded. Selecting the LOAD option reinitializes the load process following this type of interruption.

2.13.10.7 AMU/PC Cards Cautions and Advisories. The AMU has the ability to trigger three caution and five advisory messages. The caution messages are: MU LOAD, ERASE FAIL, and S/W CONFIG. The advisory messages are: Maintenance Card Advisory (MNTCD), Mission Card Advisory (MSNCD), Classified Data Advisory (CDATA), AMU Full advisory (AMU FL), and the BIT advisory.

The MU LOAD caution is generated when the AMU door is open; if the AMU fails; if the AMU declares a card interface fail; if the AMU is mux fail or not ready; if the mission card is improperly formatted, not installed, or is declared failed by the AMU, if the initialization data is not downloaded, if an incorrect checksum is calculated. The MU LOAD caution is disabled while the AMU is in relay mode or the aircraft is in flight.

The ERASE FAIL caution is generated when the AMU has failed to erase its internal RAM memory buffer following a classified data transfer.

The S/W CONFIG caution is generated if the AMU and MC software are not compatible. When an AMU OFP checksum failure occurs, the AMU OFP software configuration ID displayed on the S/W configuration BIT sublevel format indicates XXXXXXXX.

The MNTCD advisory is generated when the AMU door is open, if the maintenance card is not installed or properly formatted, or if the AMU declares a maintenance card failure. The advisory only displays with WonW and clears in flight.

The BIT advisory is generated when the AMU is degraded or an AMU RAM classified erase failure occurs.

The CDATA advisory is generated when the mission card contains classified data. It is removed when a successful classified data erase of all avionics has been performed, or a successful classified data erase of all avionics except the mission card is performed and the ERASE (MU HOLD) option has been selected on the MUMI format.

The MU FL advisory used for the existing MU is changed for the AMU. The MU FL advisory indicates a data wraparound has occurred on the maintenance card and the corresponding MSP code (809) is set. When the MC determines there is not enough memory on the maintenance card to perform the next sequential write operation, it begins overwriting previously recorded data.

DFIRS data download requests do not cause a data wraparound to occur. If there is insufficient memory available, based on the current sequential write address pointer, the DFIRS data download request is not executed.

2.13.11 ALE-39 Countermeasures Dispensing Set (CMDS). The CMDS is used to dispense chaff, flares, and jammers for self protection against enemy radars and missiles. Refer to NTRP 3-22.2-FA18A-D NATIP.

2.13.12 ALE-47 Countermeasures Dispensing Set. The CMDS uses information from various Electronic Warfare (EW) systems to generate countermeasures dispensing programs. Refer to NTRP 3-22.2-FA18A-D NATIP.

2.13.12.1 ALE-47 Advisories. D LOW is displayed when any of the loaded categories' BINGO levels are reached. The dispense misfire D BAD advisory is displayed when a misfire has occurred.

2.14 FIRE DETECTION/EXTINGUISHING SYSTEMS

The fire detection and extinguisher system is made up of three fire warning/extinguisher lights, a fire extinguisher pushbutton, one fire extinguisher bottle, a fire test switch and dual-loop fire detection sensors. The extinguisher bottle is in the aft fuselage between the engines. The bottle contains a nontoxic gaseous agent which provides a one-shot extinguishing capability. Direct current electrical power (essential 24/28 volt dc and engine start 24/28 volt dc buses) is required to operate the system. The systems operate on battery power with the battery switch in either ON or ORIDE. The systems provide engine/AMAD and APU fire warning, emergency shutdown and selective fire extinguishing.

2.14.1 Fire Warning/Extinguisher Lights/Voice Alert. The three fire warning/extinguisher lights are pushbutton switch indicators which come on when a fire condition exists. Two of the fire warning/extinguisher lights are labeled FIRE, one is mounted on the top left corner and the other on the top right corner of the instrument panel. The two FIRE warning/extinguisher lights are guarded. The left FIRE light indicates a fire condition in the left engine bay. The right FIRE light indicates a fire condition in the right engine bay. The APU FIRE light is positioned inboard of the right FIRE light. It indicates a fire condition in the auxiliary power unit bay. A voice alert warning is activated anytime a fire warning light comes on. If the left FIRE light comes on, the ENGINE FIRE LEFT voice alert is activated. If the right FIRE light comes on the ENGINE FIRE RIGHT voice alert is activated. If the APU FIRE light comes on, the APU FIRE voice alert is activated. If more than one warning light comes on at the same time, the voice alert warning priority is: ENGINE FIRE LEFT, ENGINE FIRE RIGHT, then APU FIRE.

2.14.2 Fire Extinguisher Pushbutton. The fire extinguisher pushbutton switch is on the master arm panel and is labeled FIRE EXTGH. The switch has two lights. A yellow light labeled READY and a green light labeled DISCH (discharge). When READY is on, the fire extinguisher bottle is armed. The READY light comes on when the appropriate fire warning/extinguisher light is pressed. Pressing an

engine fire warning/extinguisher light shuts off fuel to the engine at the feed tank. With READY on, pressing the fire extinguisher pushbutton discharges the fire extinguisher bottle and turns on the DISCH light. There is no indication of actual discharge of the fire extinguisher bottle.

2.14.3 APU Fire Extinguishing System. The APU fire extinguishing system can be either manually or automatically actuated. To manually actuate the system, the fire extinguisher bottle is first armed and the APU shutdown by pressing the APU FIRE warning/extinguisher light. When pressed, the APU FIRE light stays in and a barber pole indication appears alongside the light. The extinguisher bottle is then discharged into the APU bay by pressing the FIRE EXTGH pushbutton with the READY light on. Discharge of the bottle is delayed 10 seconds after the light is pressed, allowing the APU time to spool-down before the extinguishing agent is introduced. If on the ground, the APU fire extinguishing system is actuated automatically. The result is the same as with manual actuation, with the APU shutting down immediately after a fire is detected and the fire extinguisher discharging into the APU bay 10 seconds later. The automatic system is prevented from operating during flight by the action of a WOW relay.

2.14.4 Engine/AMAD Fire Extinguishing System. Actuation of the engine/AMAD fire extinguishing system can only be performed manually. The system is armed by lifting the guard and pressing the affected FIRE warning/extinguisher light. This also shuts off fuel to the engine at the engine feed shutoff valves and closes the crossfeed valve. When pressed, the FIRE light stays in and a barber pole indication appears in the switch guard. The extinguisher bottle is discharged into the affected engine bay by pressing the FIRE EXTGH pushbutton with the READY light on. If more than one FIRE light is pushed, extinguishing agent is distributed to selected bays, but concentration is insufficient to extinguish fire.

**WARNING**

The probability of extinguishing a fire and preventing relights is greatly increased by immediately discharging the extinguisher.

2.14.5 Fire and Bleed Air Test Switch. Each of the three warning/extinguisher lights contains four individual light bulbs which are simultaneously tested by actuation of the lights test switch on the interior lights panel. Operation of the lights test switch tests only the light bulbs in the warning/extinguisher lights and requires ac electrical power on the aircraft. The fire/bleed air leakage detection sensors and associated circuits are tested by the fire and bleed air test switch. Operation of the fire and bleed air test switch requires power on the essential 24/28 volt dc bus. The fire and bleed air switch is on the fire test panel on the left console. When actuated to TEST A or TEST B, the fire warning, bleed air leak detection and voice alert warning circuitry for the designated loop is tested. If a malfunction exists in a fire detection loop associated with the APU FIRE warning/extinguisher light, none of the four individual bulbs in the indicator come on. If a malfunction exists in a fire detection loop associated with either FIRE warning/extinguisher light, only the individual bulb (or bulbs) associated with the malfunctioning sensor do not come on. Care must be taken to detect bulbs that are not on in the FIRE warning/extinguisher during the loop test. Switch actuation also turns on the L BLEED and R BLEED warning lights and the L BLD OFF and R BLD OFF caution displays while the switch is activated and closes the left and right bleed air pressure regulator and shutoff valves indicating the designated loop bleed air detection sensors and circuitry are operational. The L(R) BLEED warning lights go out after the switch is released to NORM. The L(R) BLD OFF caution displays remain on until the valves are reopened. To open the valves after test, there must be ac power on the aircraft and the bleed air knob must be rotated through OFF to NORM.

NORM	System provides normal fire and bleed air leak warning. Switch is spring loaded to this position.
TEST A	Turns on the three fire warning/extinguisher lights, activates the voice alert, turns on the two bleed air warning lights and two caution displays, indicating that Loop A fire detection sensors and circuitry are operational.
TEST B	Turns on the three fire warning/extinguisher lights, activates the voice alert, turns on the two bleed air warning lights and two caution displays, indicating that Loop B fire detection sensors and circuitry are operational.

During TEST A or B, the ENGINE FIRE LEFT voice alert warning is activated first. If the switch is held in the TEST position, the sequence is as follows: ENGINE FIRE LEFT, ENGINE FIRE RIGHT, APU FIRE, BLEED AIR LEFT, then BLEED AIR RIGHT.

2.15 ENTRANCE/EGRESS SYSTEMS

2.15.1 Canopy System. The cockpit area is enclosed by a clamshell type canopy. The main components of the canopy system are an electromechanical actuator which provides powered and manual operation of the canopy, and a cartridge actuated thruster with associated rocket motors for emergency jettison. Latching provisions consist of three latch hooks on the bottom of each side of the canopy frame and two forward indexer pins on the lower leading edge of the canopy frame. When the canopy is closed, the latch hooks and indexer pins engage fittings along the canopy sill and the canopy actuator rotates the canopy actuation link over-center, locking the canopy. A mechanical brake in the canopy actuator motor provides a redundant lock. An inflatable seal, installed around the edge of the canopy frame, retains cockpit pressure when the canopy is locked. A rain seal is installed outboard of the pressure seal to divert rain water away from the cockpit. The F/A-18A/B and F/A-18C/D windscreens have been tested to determine their bird strike resistance. See figure 2-31 for test results.

2.15.1.1 Normal Canopy Operation. Normal canopy operation is provided by the internal canopy control switch (figure 2-32) on the right side of the cockpit under the canopy sill. An external canopy control switch provides powered operation of the canopy from outside the aircraft. With no generator or external electrical power on the aircraft, battery power is available for at least five open/close cycles of the canopy. If no electrical power is available for canopy operation, a back-up crank system is provided to manually power the canopy actuator. Internally, the manual crank is under the left canopy sill. Externally, manual handcrank provisions are provided by a drive socket located flush on the mold line, outside of the internal handcrank. Internally, 70 counterclockwise crank turns are required to fully open the canopy; externally, 35 counterclockwise crank turns are required.

WARNING

For aircraft 163985 AND UP, a high voltage (100,000 volt) static electrical charge may build up in flight and be stored in the windscreen and canopy. To prevent electrical shock ensure that the static electricity has been discharged.

CAUTION

Taxiing with the canopy at an intermediate position can result in canopy attach point damage and failure. Do not open or close the canopy with the aircraft in motion.

2.15.1.1.1 Internal Canopy Switch. The internal canopy switch has three positions: OPEN, CLOSE and HOLD.

OPEN Raises canopy to maximum position. If selected when canopy is locked, the canopy unlocks, then moves 1.5 inches aft before rising. With WOW, the OPEN position is solenoid held until the maximum up position is reached, after which it is spring loaded to the HOLD position. The solenoid can be overridden at any time by placing the switch to HOLD. With weight off wheels, the switch must be held in the OPEN position to open the canopy.

CAUTION

Objects/Grimes light placed in the area near the canopy switch could inadvertently shift causing actuation of the canopy switch airborne resulting in loss of canopy.

HOLD Stops the canopy at any point during the open or close cycle.

CLOSE Lowers canopy. If held after canopy reaches canopy sill, canopy moves forward 1.5 inches and then locks. Locked condition indicated by MASTER CAUTION light and CANOPY display going out. CLOSE position is spring loaded to the HOLD position.

2.15.1.1.2 External Canopy Switch. Electrical operation of the canopy from outside the cockpit is provided for by the external canopy switch inside the external power receptacle door (door 9) on the left side of the aircraft below the canopy and LEX. The door is equipped with a quick release latch. The switch contains the same positions and operates identically to the internal canopy switch, except that the OPEN position is not solenoid-held.

2.15.1.1.3 Internal Manual Canopy Handcrank. A manual canopy handcrank is provided to manually open the canopy. The handcrank, under the left canopy sill, opens the canopy when the crank handle is turned approximately 70 turns in a counterclockwise direction. Before use, the handcrank handle must be unstowed by removing it from a stowage clip and socket and then inserted into the crank socket immediately above the stowage clip. A cable is provided to prevent loss of the handle if dropped. Cranking the handle clockwise closes the canopy.

2.15.1.1.4 External Manual Canopy Actuation Fitting. The external manual canopy actuation fitting, a 3/8 inch drive socket on the left side of the aircraft below the canopy, is used to manually operate the canopy. Inserting a 3/8 inch drive tool in the socket and then turning counterclockwise approximately 35 turns opens the canopy. Turning the drive tool clockwise closes the canopy.

2.15.1.1.5 Canopy Caution Display. A CANOPY caution display comes on when the canopy is unlocked. The CANOPY display comes on in conjunction with the MASTER CAUTION light.

2.15.1.2 Emergency Canopy System. For canopy jettison, a cartridge initiated thruster is utilized to unlatch the canopy by moving it 1.5 inches rearward, after which two canopy framemounted rocket motors fire to rotate the canopy up and aft, clear of the ejection seat path. The thruster, which provides attachment for the canopy actuator link during normal canopy operation, is activated by pulling any of the following: ejection seat firing handle, internal canopy jettison handle or, on aircraft 161353 THRU 162477, one of the two external canopy jettison handles (figure 2-32). The canopy can be jettisoned closed, open, or in any intermediate position.

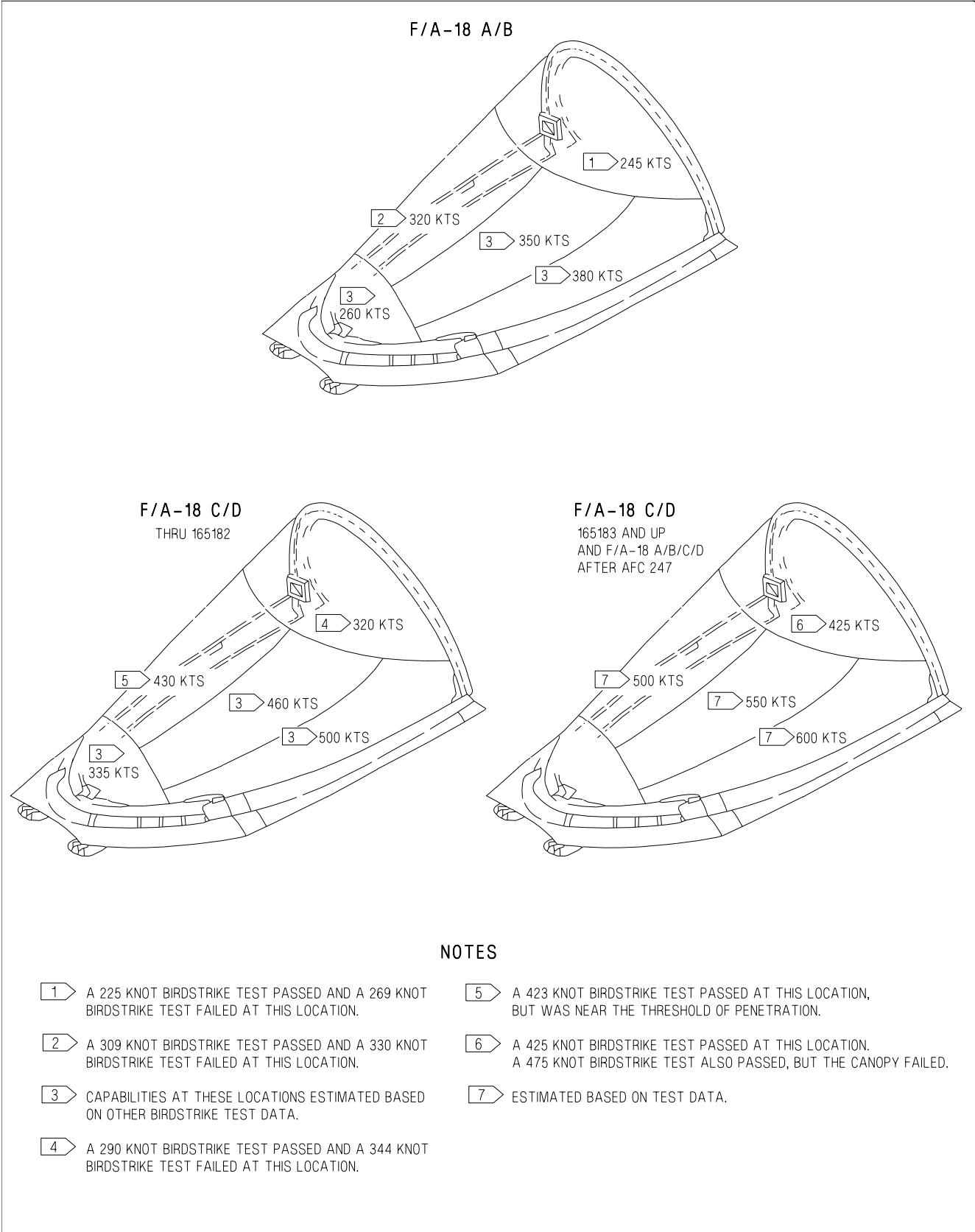

ADA520-325-1-043

Figure 2-31. Canopy Birdstrike Resistance

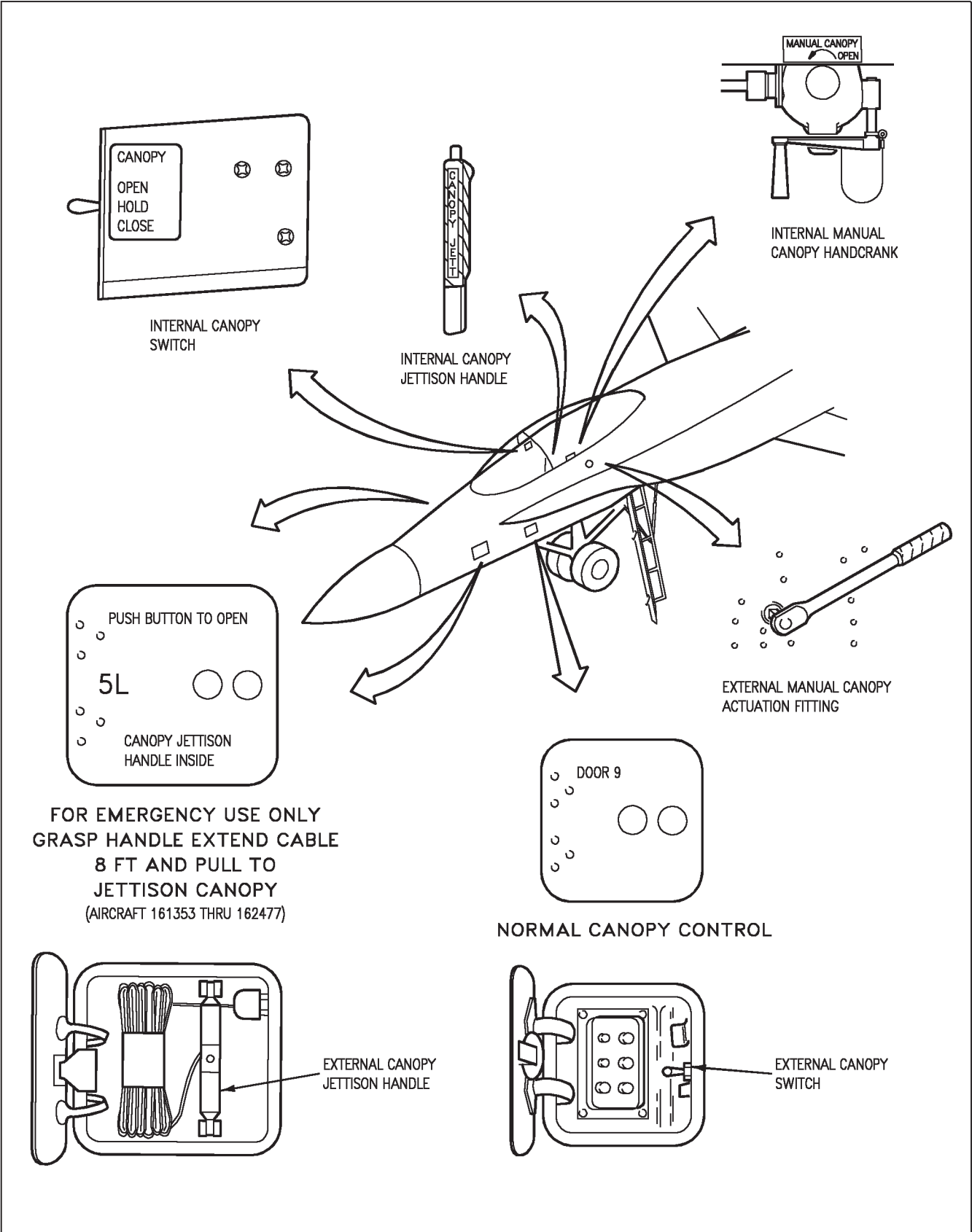
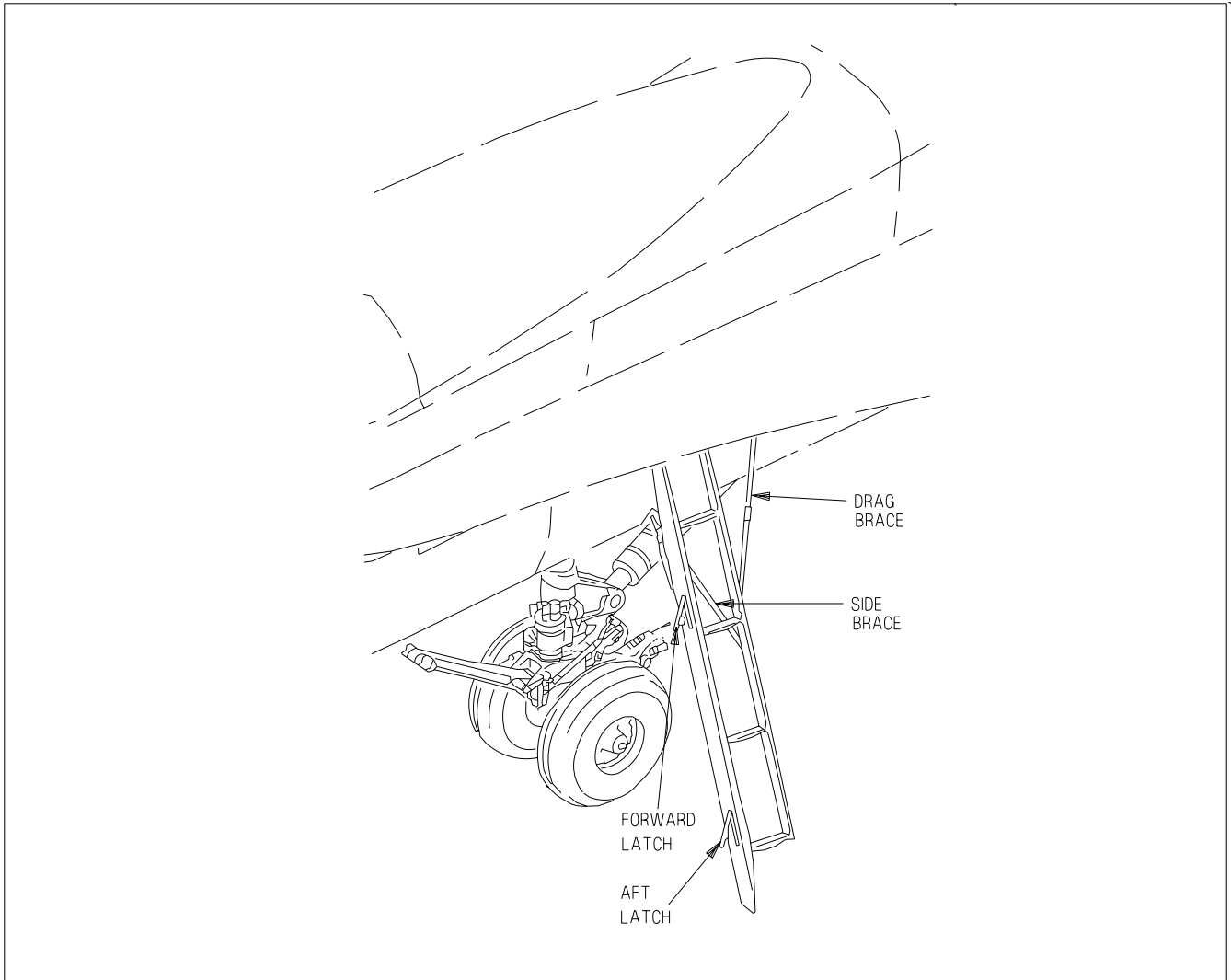

Figure 2-32. Canopy Controls



ADA520-26-1-045

Figure 2-33. Boarding Ladder

2.15.1.2.1 Internal Canopy Jettison Handle. A black and yellow striped canopy jettison handle is on the left inboard canopy sill just aft of the instrument panel. Pressing an unlock button on the tip of the handle and pulling the handle aft fires the canopy jettison system.

2.15.1.2.2 External Canopy Jettison Handles (Aircraft 161353 THRU 162477). The external canopy jettison handles are T-handles within door 5 on each side of the forward fuselage just below the LEX leading edge. They jettison the canopy from outside the aircraft. After pushing a release button to open the access door, the handle and its lanyard are played out 8 feet from the aircraft and then pulled to fire the canopy jettison system.

2.15.2 Boarding Ladder. A boarding ladder (figure 2-33), stowed under the LEX, provides access to the cockpit and upper aircraft area from the left side of the aircraft. Ladder extension and retraction can only be accomplished from outside the cockpit. To extend the ladder, manually support the ladder and release the forward and aft latches on the forward beam on the underside of the LEX, permitting the ladder to rotate down to the extended position. The drag brace locks when extended to its full length to provide longitudinal stability for the ladder. Lateral stability is provided for by the V-shaped side brace attached to the side of the fuselage. To stow the ladder, remove the rigid removable side

brace connection from the fuselage. Pull the collar on the drag brace down permitting the telescoping drag brace to unlock and compress as the boarding ladder is rotated up and aft to the stowed position. The forward and aft latches are manually engaged and locked by pushing them full up until they are locked flush with the forward beam. With electrical power on the aircraft, a LADDER caution display comes on whenever the proximity switch in the aft portion of the ladder well is not actuated. With the ladder stowed and the forward and aft latches locked, the LADDER caution display goes out.

2.15.3 Ejection Seat. The SJU-5/A and 6/A ejection seat (LOT 12 AND BELOW), the Naval Aircrew Common Ejection Seat (NACES) SJU-17(V)1/A, 2/A, and 9/A and NACES SJU-17A(V)1/A, 2/A, and 9/A (LOT 13 AND UP, and A+ aircraft AFTER AFC 493) are ballistic catapult/rocket systems that provide the pilot with a quick, safe, and positive means of escape from the aircraft. See Ejection Seat, Foldout section, for ejection seat illustrations. The seat system includes an initiation system which, after jettisoning the canopy and positioning the occupant for ejection, fires the telescopic seat catapult. In the event of a canopy jettison failure during ejection, canopy breakers on the top of the seat give the capability for ejection through the canopy. As the seat departs the aircraft and the catapult reaches the end of its stroke a rocket motor on the bottom of the seat is fired. The thrust of the rocket motor sustains the thrust of the catapult to eject the seat to a height sufficient for parachute deployment even if ejection is initiated at zero speed, zero altitude in a substantially level attitude.

NOTE

Safe escape is provided for most combinations of aircraft altitude, speed, attitude, and flight path within the envelope of 0 to 600 KIAS airspeed and 0 to 50,000 ft. altitude.

2.15.3.1 SJU-5/A and 6/A Seat. Shortly after departing the aircraft a drogue gun is fired to deploy the drogue chute. The drogue chute either remains attached to the top of the seat or is released to deploy the main parachute, depending on altitude and the number of g's applied on the seat. After a delay of 1.50 seconds, an automatic time release mechanism opens the main parachute container and releases the drogue chute to deploy the main parachute when conditions of altitude and g forces are met. The seat operates in three modes. At high altitude, the seat is allowed to freefall to below 14,500 feet MSL before the time release mechanism activates. At medium altitude, the time release mechanism actuates when the seat is below 13,000 and above 7,500 feet MSL and acceleration forces are below 3 g's. At low altitude, below 7,500 feet, g forces are not used as a condition for deploying the main parachute. The time release mechanism also releases the lap belts, inertia reel restraint straps, and leg restraint lines. Both the drogue gun and time release mechanism are actuated on ejection by trip rods attached to the aircraft structure.

The main parachute is a 17-foot aeroconical canopy type, stored along with the drogue chute(s) in a headbox container on top of the ejection seat. The parachute is steerable, and contains water deflation pockets which aid in dumping air from the canopy after landing in water.

The seat contains controls for seat height adjustment, and for locking and unlocking the inertia reel shoulder restraint straps. A survival kit is installed in the seat pan.

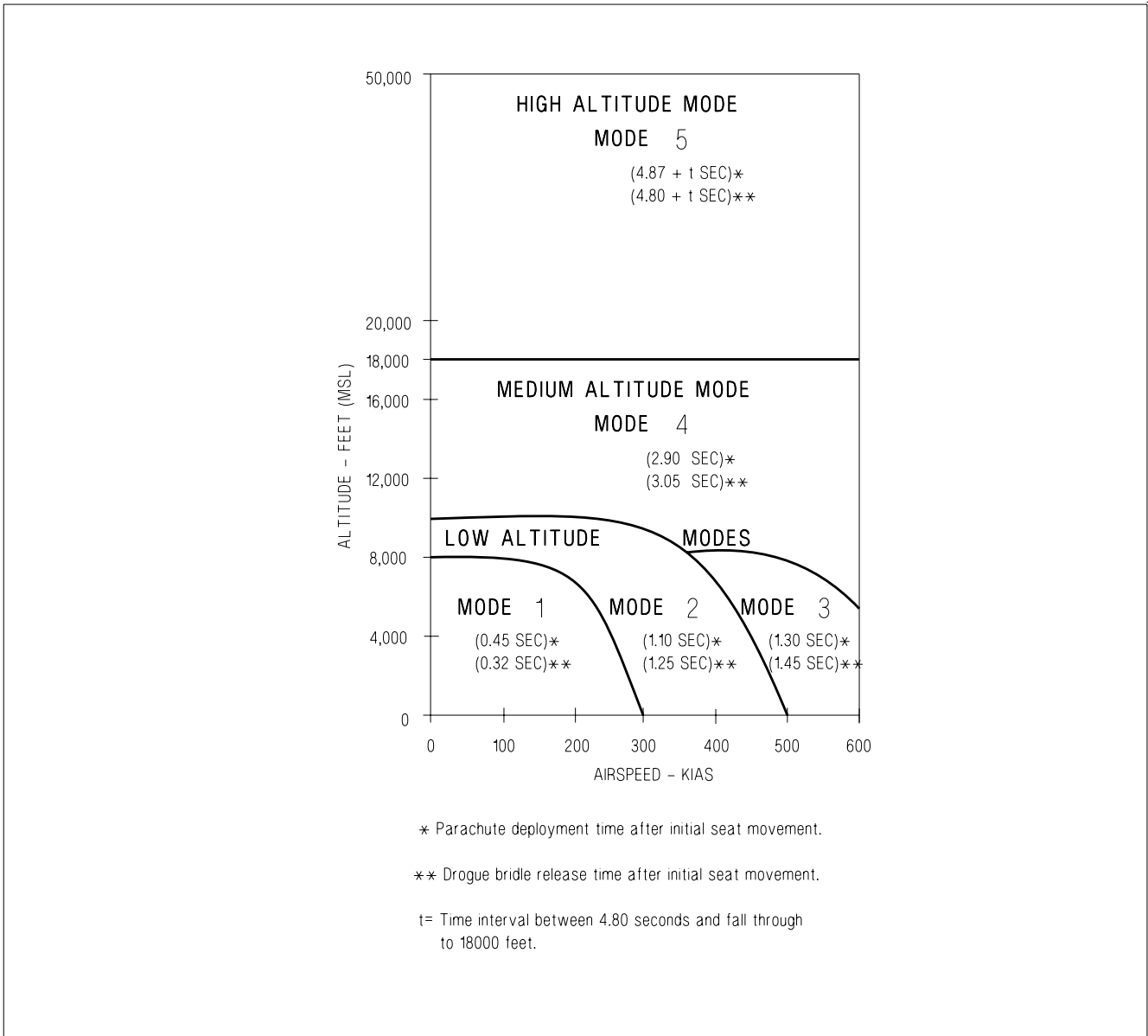

ADA520-146-1-045

Figure 2-34. SJU-17 Ejection Modes

WARNING

The 17-foot aeroconical parachute used in the SJU-5/A and 6/A seats can increase the risk of injury for crewmembers with nude weights above 213 pounds because of high rates of descent.

2.15.3.2 Seat SJU-17(V)1/A, 2/A, and 9/A, and SJU-17A(V)1/A, 2/A, and 9/A. Timing of all events after rocket motor initiation is controlled by the electronic sequencer which utilizes altitude, acceleration and airspeed information to automatically control drogue and parachute deployment, and seat/man separation throughout the ejection seat operational envelope. In the event of partial or total failure of the electronic sequence, a four second mechanical delay initiates a barostatic release unit which will free the occupant from the seat and deploy the parachute between 16,000 and 14,000 feet

MSL if the ejection occurred in or above this altitude range. The emergency barostatic unit operates immediately after a 4-second delay if the ejection occurred below 14,000 feet MSL. An emergency restraint release (manual override) system provides an additional back-up in the event of failure of the barostatic release unit. The seat is stabilized and the forward speed retarded by a drogue chute that is attached to the top and bottom of the seat. The parachute deployment rocket is automatically fired to withdraw the parachute from its deployment bag. Full canopy inflation is inhibited until the g forces are sufficiently reduced to minimize opening shock. There are five modes of operation. See figure 2-34 for parameters that determine the mode of operation and the corresponding parachute deployment and drogue chute release times. At high altitude the drogue chute deploys to decelerate and stabilize the seat. The seat falls drogue retarded to 18,000 feet MSL where the drogue is released, the main parachute is deployed, and seat/man separation occurs. At medium altitude, between 18,000 and 8,000 feet MSL, and at low altitude below 8,000 feet MSL parachute deployment is automatically delayed from 0.45 to 2.90 seconds (depending upon airspeed and altitude after seat first motion) to allow the drogue chute to decelerate and stabilize the seat depending upon airspeed and altitude.

The main parachute is a 21-foot aeroconical canopy type, stored in a headbox container on top of the ejection seat. The parachute is steerable, and contains water deflation pockets which aid in dumping air from the canopy after landing in water. The seat drogue chute is stored in a separate container on top of the drogue deployment catapult. The seat contains controls for adjusting seat height, and for locking and unlocking the inertia reel shoulder restraint straps. A survival kit is installed in the seat pan.

2.15.3.3 SEAWATER Activated Release System (SEAWARS). This is a seawater activated system that automatically releases the parachute from the crewmember. When the sensing-release units are immersed in seawater, cartridges are fired which allow the crewmember to separate from the parachute.

2.15.3.4 Ejection Control Handle. The ejection control handle, between the pilot's legs on the front of the seat pan, is the only means by which ejection is initiated. The handle, molded in the shape of a loop, can be grasped by one or two hands. To initiate ejection, a 20 to 40 pound pull removes the handle from its housing, and a continued pull of 30 to 60 pounds is required to pull both sears from the dual initiators. Either of the initiators can fire the seat. After ejection, the handle remains attached to the seat. The ejection control handle can be safed by the ejection seat safe/armed handle.

2.15.3.5 Ejection Seat SAFE/ARMED Handle. To prevent seat ejection, an ejection seat safe/armed handle is provided. The handle, forward on the right seat armrest, safeties the seat when rotated up and forward, and arms the seat when it is rotated aft and down. The safe/armed handle is locked when placed to either of these two positions and the handle must be unlocked before changing positions by squeezing a locking lever within the handle cutout. When in the armed position the visible portion of the handle (from the occupant's vantage point) is colored yellow and black with the word ARMED showing. In the safe position, the visible portion is colored white with the word SAFE showing. The seat is safed only when the word **SAFE** is entirely visible on the inboard side of the SAFE/ARM handle and the handle is locked in the detent. Placing the handle to the SAFE position causes a pin to be inserted into the ejection firing mechanism to prevent withdrawal of the sears from the dual seat initiators.

2.15.3.5.1 CK SEAT Caution (F/A-18C/D). The CK SEAT caution light is located on the caution light panel and repeats the DDI CHECK SEAT caution display. The caution comes on when the right throttle is at MIL or above, weight is on wheels, and the ejection seat is not armed.

2.15.3.6 Shoulder Harness Inertia Reel. Pilot shoulder harness restraint is provided by a dual strap shoulder harness inertia reel mounted in the seat below the parachute container. The dual inertia reel

shoulder straps connect to the parachute risers which in turn are buckled to seat occupant's upper harness. The inertia reel locks when the reel senses excessive strap velocity. Manual locking and unlocking of the reel is controlled by the shoulder harness lock/unlock handle on the left side of the seat bucket. During ejection a pyrotechnic cartridge is fired to retract the shoulder harness to position the seat occupant for ejection.

2.15.3.7 Shoulder Harness Lock/Unlock Handle. The shoulder harness lock/unlock handle on the left side of the seat bucket has two positions. To operate, the handle must be pulled up against spring pressure, moved to the desired position, and then released.

FORWARD (locked) The inertia reel prevents the reel straps from being extended and ratchets any slack in the straps back into the reel.

AFT (unlocked) The reel allows the pilot to lean forward, but the inertia portion of the reel continues to protect him by locking the reel when it senses excessive strap velocity. Once locked, the pilot can normally lean forward again after a slight release in pressure on the reel straps.

2.15.3.8 Leg Restraint System. A leg restraint system is located on the front of the ejection seat. The function of the system is to secure the occupant's legs to the seat during ejection. The system consists of two adjustable leg garters, a restraint line and a snubber box for each leg. One garter is worn on the thigh approximately 3 inches above the knee and one garter is worn on the lower leg in-line with the snubber as illustrated in figure 2-35. The restraint lines are routed through the garter rings and the snubber box. One end of each restraint line is secured to the cockpit floor and the other, after being routed through the snubber box and both garter rings, is secured to the seat just outboard of the snubber box by a releaseable pin. During ejection, inertia draws the legs in against the front of the seat bucket and the legs are retained in this position by the leg restraint line. The restraint line is snubbed and separates at the tension ring on each leg line. At man-seat separation, the pins on the other end of the lines are released by the time release mechanism. The pins are also released when the manual override handle is pulled. Both the lower garter and thigh garter contain a quick release buckle which disconnects the ring through which the leg restraint line runs, permitting the pilot to egress from the aircraft wearing both upper and lower garters. In addition, toe clips are installed on the tops of the rudder pedals to prevent contact between the toes and the instrument panel during ejection.

2.15.3.8.1 Leg Restraint Snubber Release Tabs. The leg restraint lines are adjusted to give the pilot more leg movement by pulling inboard the leg restraint snubber release tabs (figure 2-35) and simultaneously pulling the leg restraint lines forward through the snubber box.

2.15.3.9 Survival Kit (SKU-3/A). The SKU-3/A survival kit is used with the SJU-5/6 ejection seat and contains provisions for survival after ejection or ditching (figure 2-34, sheet 1). The kit is composed of a two-piece fiberglass container. The lower portion of the kit contains emergency provisions and an inflatable raft. The upper portion of the kit, containing a 50 cubic inch emergency oxygen supply, serves as the kit cover and has a seat cushion attached to the top. During ejection the emergency oxygen is tripped by an automatic oxygen operating cable lanyard attached to the cockpit floor. The kit contains an emergency oxygen green ring on the left forward part of the upper kit. A flexible oxygen and communications hose is installed in the left aft side of the upper kit to provide a connection to the pilot for oxygen and communications. After ejection or after the emergency oxygen green ring is pulled, emergency oxygen is supplied to the pilot through the hose until the emergency oxygen is exhausted.

The survival kit is secured to the seat by two lugs installed on the aft upper corners of the kit, and a lug installed through a bracket on the front of the kit. Two adjustable lap belt straps are installed on

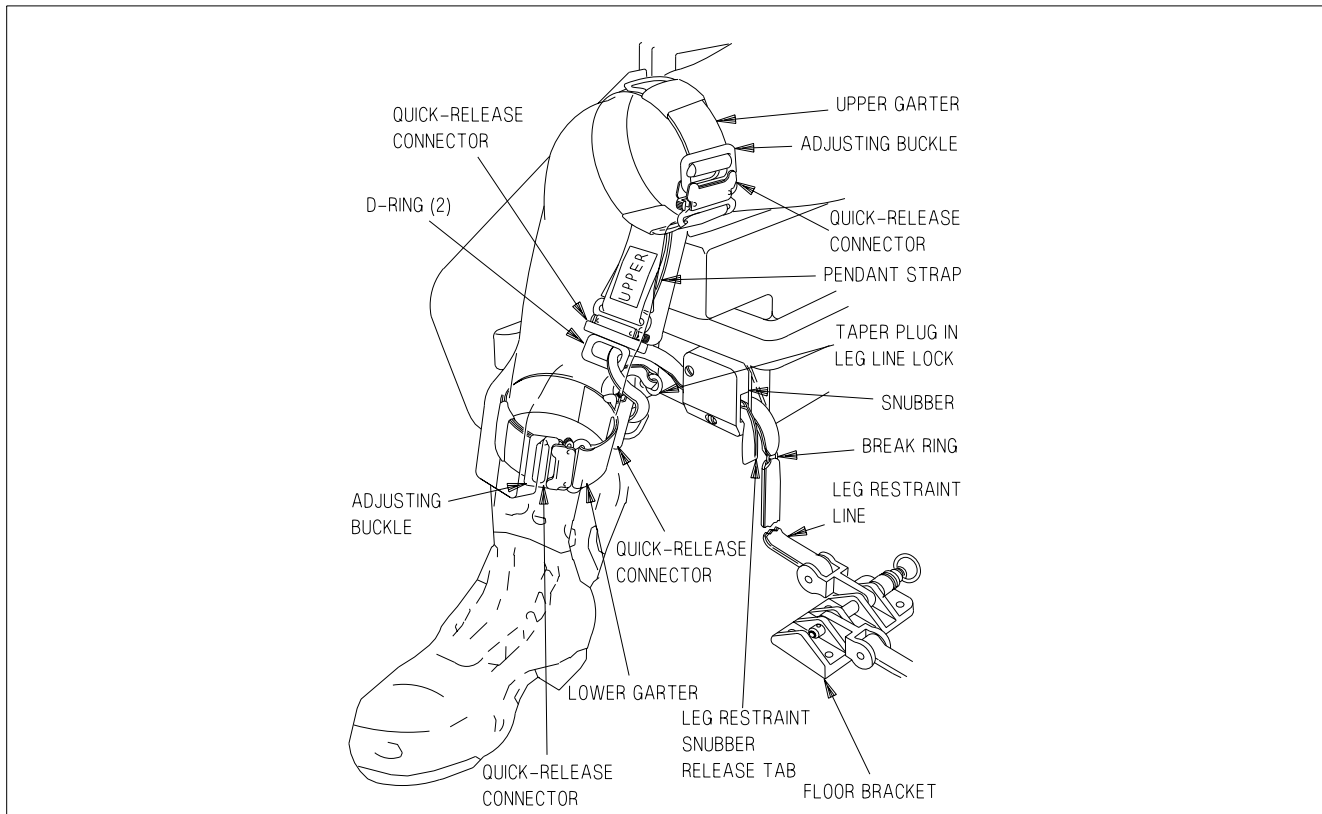

ADA520-27-1-045

Figure 2-35. Leg Restraint System

the sides of the kit. These straps connect to fittings on the pilot's lower torso harness to secure the pilot to the kit, and thus to the seat. The restraint provided by the three lugs is released by the action of the time release mechanism at seat-man separation after ejection, or by the action resulting from pulling the manual override handle. Additional restraint is provided by straps which connect the survival kit to sticker clips in the seat. The straps require a force of between 40 to 55 pounds to separate from the sticker clips at man-seat separation after ejection or during ground egress. The kit is equipped with an AN/URT-33A radio beacon locator which actuates during ejection at man-seat separation. The kit can be deployed after ejection during parachute descent by pulling the survival kit release handle on the right side of the kit. This unlocks the kit causing the lower half to fall away while remaining attached to the upper half by a dropline. The liferaft, also attached to the dropline, falls away by gravity and inflates. An equipment bag containing the other survival aids falls away but remains attached to the upper kit lid by a lanyard. If the pilot lands in water before deploying the survival kit, the liferaft can be inflated by pulling the survival kit release handle and then reaching into the kit and pulling the actuating cable on the liferaft CO₂ bottle.

2.15.3.10 Seat Survival Kit (SKU-10/A). The SKU-10/A survival kit is used with the SJU-17 ejection seats. This survival kit, which fits into the seat bucket, is a contoured rigid platform which contains an emergency oxygen system and a fabric survival rucksack (figure 2-36, sheet 2). A cushion on top of the platform provides a seat for the aircrew.

The rigid platform forms a hard protective cover to the survival package and oxygen system and is retained in position in the seat bucket by brackets at the front and lugs secured in the lower harness locks at the rear. Attached to the lugs are two adjustable lap belts with integral quick-release fittings.

A flexible oxygen and communication hose is installed in the left aft side of the upper kit to provide a connection to the aircrew for aircraft oxygen and communication. An emergency oxygen cylinder, pressure reducer and associated pipework are mounted on the underside of the platform. A green manual emergency oxygen operating handle is mounted on the left side of the platform and a pressure gage is on the inside face of the left leg support. The emergency oxygen can be activated manually by pulling the green emergency oxygen handle upwards. The green emergency oxygen handle can be reset, thus shutting off the flow of emergency oxygen, by pushing downward on the button on the front end of the emergency oxygen handle assembly. The emergency oxygen is automatically activated during ejection by a lanyard connected between the floor and the survival kit. An AN/URT-33A locator beacon is located in a cutout in the left leg support. The beacon is actuated during ejection by a lanyard connected to the emergency oxygen lanyard.

The survival rucksack is retained to the underside of the rigid platform by five fabric straps and a double cone and pin release system. The package accommodates a liferaft and survival aids. Two yellow manual deployment handles are mounted on the aft surface of the kit and pulling either handle enables the aircrew to deploy the raft and survival package after man/seat separation. The liferaft inflates automatically on survival package deployment and is attached to the survival package with a line. If the survival kit must be deployed after water entry, a snatch pull on the red manual activation handle, near the CO₂ bottle, is required to inflate the liferaft.

2.15.3.11 Manual Override Handle. A manual override handle permits releasing the pilot's lower harness restraints and the leg restraint lines for emergency egress, and permits resuming part of the ejection sequence (man-seat separation and main parachute deployment) in the event of sequencing failure during ejection. The manual override handle, on the right side of seat bucket and just aft of the ejection seat safe/arm handle, is actuated by first pressing a thumb button on the forward part of the handle and then rotating the handle up and aft. If the handle is actuated on the ground or in the air before ejection, the following restraints are released: survival kit attachment lugs, inertia reel straps, and the leg restraint lines. During ground emergency egress, after the manual override handle is pulled and the parachute riser fittings are released, the pilot is free to evacuate the aircraft with the survival kit still attached. On the SJU-5/6 seat, if the manual override handle is actuated after ejection before man-seat separation occurs, the following events take place: release of same restraints as described in the emergency ground egress, firing of the manual override initiator cartridge which fires both the time release mechanism and drogue gun secondary cartridge (if they haven't been fired), flaps of main parachute pack are unlocked, and the scissor shackle on the top of the seat is released to allow the drogue chute to deploy the main parachute. On the SJU-17 seats, if the manual override handle is actuated after ejection before man-seat separation occurs, the following events take place: release of survival kit attachment lugs, negative-g strap, leg restraint lines, inertia reel straps; firing of the manual override initiator cartridge; firing of the barostatic release unit; and firing of the parachute deployment rocket which deploys the parachute. The ejection seat safe/armed handle automatically rotates to the SAFE position whenever the manual override handle is actuated.

WARNING

Do not pull the manual override handle in flight. Pulling the handle disconnects the survival kit attachment lugs and leg restraint lines, inertia reel straps, and safeties the seat.

2.15.3.12 Seat Bucket Position Switch. The seat bucket position switch is on the left side of the seat bucket, forward of the shoulder harness lock/unlock handle. The forward switch position lowers the seat bucket, the aft position raises the seat bucket, and the center off position, to which the switch is

spring-loaded, stops the seat bucket. The maximum vertical travel of the seat bucket is 5.3 inches on the SJU-5/A and 6/A, 5.1 inches on the SJU-17(V)1/A, 2/A, and 9/A, and 6.1 inches on the SJU-17A(V)1/A, 2/A, and 9/A. The actuator should not be operated over 1 minute during any 8-minute period.

WARNING

- To prevent increased risk of thigh slap or leg contact injuries, aircrew with a buttock-to-knee length greater than 25.5 inches should not use either of the two forward backpad positions. Aircrew with buttock-to-knee length between 24.6 and 25.5 inches should not use the full forward backpad position.
- Actuation of the seat bucket position switch with the leg restraints under the seat bucket may result in an inadvertent ejection.

CAUTION

Actuation of seat bucket position switch with lap belts, shoulder harness, and/or leg restraints outside or under seat bucket may damage ejection seat, leg restraints, and/or Koch fittings.

2.15.3.13 Backpad Adjustment Mechanism (SJU-17A(V)1/A, 2/A, and 9/A). The backpad adjustment mechanism handle is on the seat bucket adjacent to the top left hand side of the backpad and is connected to the backpad by a linkage. The backpad has three positions, full forward, middle, and full aft which give a total forward/aft adjustment of 1.6 inches. When the handle is in the full up position, the backpad is full aft and when the handle is full down, the backpad is full forward. To move the backpad, the adjustment handle is moved within a quadrant until a spring-loaded plunger engages in one of the three detent positions in the quadrant. Set the backpad for personal comfort and best access to flight controls during initial strap-in and prior to flight.

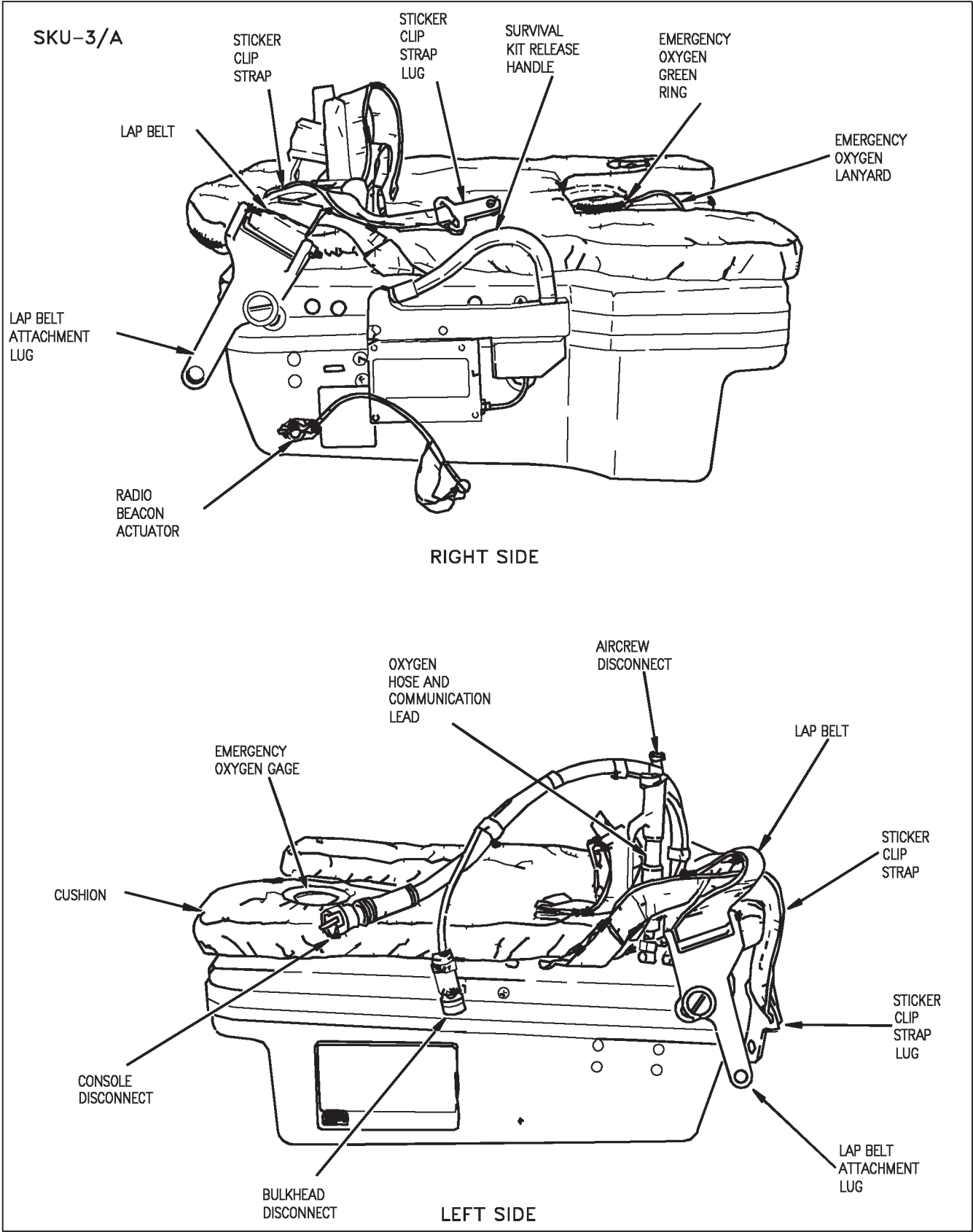

18AC-NFM-00-(28-1)31-SCAN

Figure 2-36. Survival Kit (Sheet 1 of 2)

SKU-10/A

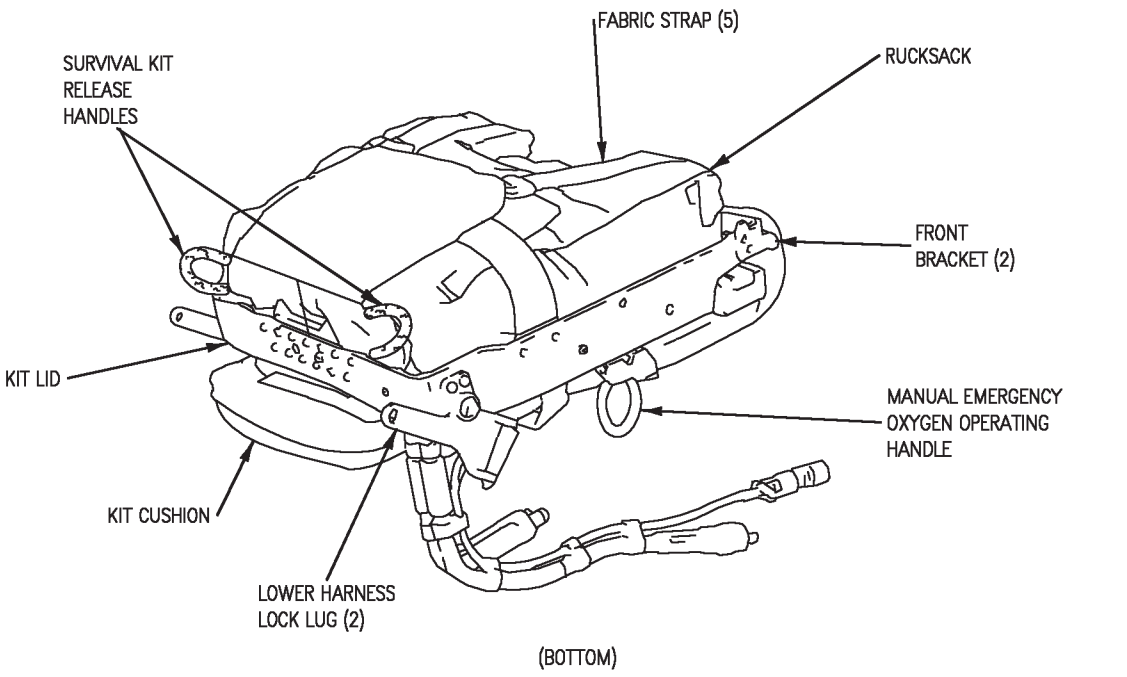
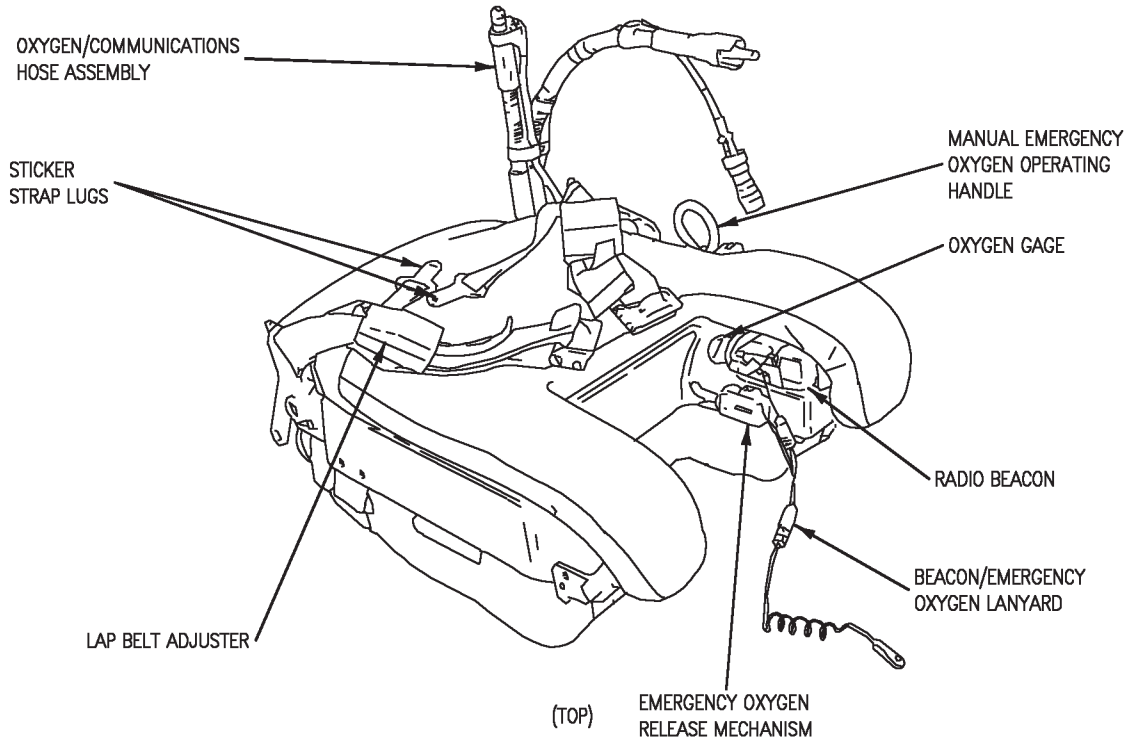

Figure 2-36. Survival Kit (Sheet 2 of 2)

2.16 ENVIRONMENTAL CONTROL SYSTEM

The environmental control system (ECS) provides conditioned air to the cockpit and avionics. The ECS also provides cockpit pressurization, OBOGS source air, anti-g suit pressure, fuel tank pressurization, throttle boost, windshield anti-ice and rain removal, windshield defog, canopy seal, and waveguide pressurization. The ECS uses bleed air from the engines for operation. See Environmental Control System, Foldout section, for environmental control system illustration.

2.16.1 Bleed Air System. Bleed air comes from the compressor section of each engine. A primary bleed air pressure regulator and shutoff valve is mounted on each engine and controls the flow of bleed air into the engine bay bleed air ducts. This valve can be manually commanded closed by the BLEED AIR knob, or is automatically commanded closed by the bleed air leak detection system, system overpressure sensor, or total loss of ac power. When the valve is commanded closed, the associated L or R BLD OFF caution is displayed.

The engine bay bleed air ducts are routed into the keel and are tied together. This common bleed air duct is routed through the secondary pressure regulator and shutoff valve which controls the flow of bleed air into the rest of the ECS. This valve can be manually commanded closed by the OFF position of the BLEED AIR knob, or is automatically commanded closed by the bleed air leak detection system or system overpressure sensor. The common bleed air duct is then routed from the keel across the top of the fuselage fuel tanks to the primary heat exchanger. For crossbleed engine starts, bleed air is routed to the air turbine starters through the isolation valve. A bleed air leak detection system which utilizes temperature-sensing elements is installed. Elements are routed on each engine bay bleed air duct. If a leak is detected in an engine bay bleed air duct, a single L or R BLEED warning light is illuminated, the associated “Bleed Air Left/Right” voice alert is annunciated, and the associated primary bleed air pressure regulator and shutoff valve is commanded closed resulting in a single L or R BLD OFF caution. An engine bay fire or missing engine borescope plug can also result in single bleed air leak indications. Bleed air leak detection elements are also routed along the common bleed air ducts. If a leak is detected in these common bleed air ducts, both L and R BLEED warning lights are illuminated, both “Bleed Air Left and Right” voice alerts are annunciated, both primary bleed air pressure regulator and shutoff valves are commanded closed resulting in both L and R BLD OFF cautions, and the secondary pressure regulator and shutoff valve is commanded closed.

WARNING

- BLD OFF cautions are based on command signals to the valves and are not an indication of actual valve position. A valve could still be open allowing bleed air to leak. The BLEED AIR knob should be turned to the appropriate OFF position to backup the automatic shutoff function.
- If a single BLEED warning light does not extinguish after the associated BLD OFF caution is displayed, a borescope plug may be leaking or the associated shutoff valve may still be open. Shutting down the associated engine will eliminate the leak. If both BLEED warning lights do not extinguish after both BLD OFF cautions are displayed, a shutoff valve may still be open. Reducing power on both engines will reduce the temperature and flow of the leak minimizing aircraft damage.

If a system overpressure occurs, both primary pressure regulator and shutoff valves are commanded closed resulting in both L and R BLD OFF cautions, and the secondary pressure regulator and shutoff valve is commanded closed. The system may be safely reset ONCE if the shutdown was due to an overpressure condition characterized by the display of both BLD OFF cautions without the “Bleed Air Left/Right” voice alerts.

The fire and bleed air test switch, described under Fire Detection/Extinguishing Systems, this section, tests the bleed air leak detection system. When the test is executed, both L and R BLEED warning lights are illuminated, both “Bleed Air Left and Right” voice alerts are annunciated, both primary bleed air pressure regulator and shutoff valves are commanded closed resulting in both L and R BLD OFF cautions, and the secondary pressure regulator and shutoff valve is commanded closed. The L and R BLEED warning lights go off when the switch is released but the three pressure regulator and shutoff valves do not open. To open the valves, the BLEED AIR knob must be rotated through OFF to NORM with AC power on the aircraft. The L (R) BLD OFF cautions remain on until the valves are commanded open.

2.16.1.1 Bleed Air Knob. The BLEED AIR knob, on the ECS panel on the right console, selects the engine bleed air source for the ECS system.

OFF	Shuts off bleed air from both engines.
R OFF	Selects bleed air from the left engine only.
L OFF	Selects bleed air from the right engine only.
NORM	Supplies bleed air from both engines.
AUG PULL	APU airflow augments engine bleed air flow for ECS operation. Position can only be used on the ground, is solenoid held, and reverts to off if electrical power is lost, or when both throttles are advanced to MIL power or greater. Bleed air knob must be in any position except OFF.

2.16.1.2 L(R) Bleed Air Warning Lights. The L and R BLEED air warning lights, on the left warning/caution/advisory lights panel, come on when a leak is detected in the left (right) bleed air system. They also come on during test of the bleed air leakage detection system. If a leak is detected in the common portion of bleed air ducting both warning lights illuminate.



The L/R BLEED AIR warning lights may not be seen by the pilot. The only indication to the pilot may be the voice alert.

2.16.1.3 L(R) Bleed Off Caution Displays. The L(R) BLD OFF caution displays come on whenever the left (right) bleed air pressure regulator and shutoff valve(s) are commanded closed. The cause of valve closure could be a leak or overpressurization in the bleed air system, or test of the bleed air leakage detection system. The display(s) remain on the DDI until the valve(s) are commanded open.

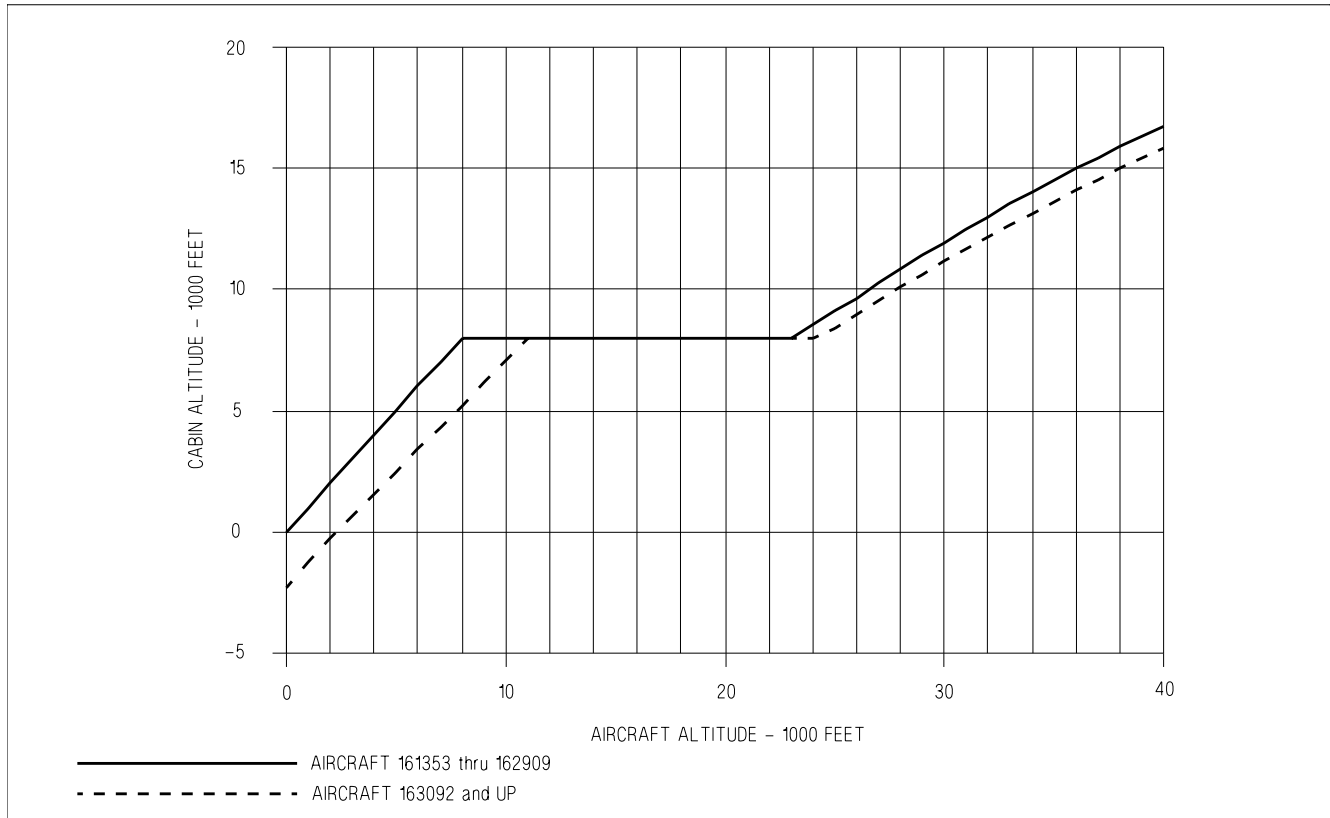

ADA520-358-1-045

Figure 2-37. Cockpit Pressurization Schedules

2.16.2 Cockpit Air Conditioning and Pressurization. Cockpit air conditioning and pressurization controls are on the ECS panel. The cockpit pressure altitude is shown on the cockpit altimeter on the lower center instrument panel. The pressurization schedules are different between aircraft 161353 THRU 162909 and aircraft 163092 AND UP. See figure 2-37.

WARNING

There is no caution in the event of loss of cockpit pressurization.

2.16.2.1 Mode Switch.

- | | |
|---------|--|
| AUTO | Cockpit and suit vent temperature maintained as selected by temperature knobs. |
| MAN | Cockpit and suit vent temperature directly controlled by temperature knobs. Manual mode applies maximum airflow to cockpit and avionics during ground operations. Significant airflow degradation occurs with increasing altitude. |
| OFF/RAM | ECS shut off. Cockpit ram air valve and liquid cooling air scoop opened. |

2.16.2.2 Temperature Knobs. The outer knob controls cockpit temperature as programmed by the mode switch. The inner knob controls suit vent air temperature as programmed by the mode switch.

2.16.2.3 Cabin Pressure Switch.

NORM	Cockpit pressurized by ECS
DUMP	Cockpit unpressurized
RAM DUMP	Cockpit ram air valve opens, ECS compressor/turbine output air to cockpit is shut off, and cabin pressure dump valve opens. Warm air is available through the cabin add heat valve to mix with the ram air.

2.16.2.4 Cabin Pressurization Warning System (CPWS). The CPWS pressure switch monitors cabin pressure and aircraft relays monitor related controls to warn aircrew of potentially hazardous cabin pressurization conditions.

2.16.2.4.1 CABIN Caution Light. The yellow CABIN caution light is located on the lower right caution lights panel. The light illuminates when cabin pressure altitude is above 21,000 +/- 1,100 feet. The light may not extinguish until cabin pressure altitude is below 16,500 feet.

WARNING

- CABIN light may appear with normal cabin pressurization when aircraft altitude is above 47,000 feet MSL. If altitude is maintained, aircrew should continuously monitor physiological condition.
- DCS may be experienced when operating with cabin pressure altitude above 25,000 feet even with a working oxygen system. Symptoms of DCS include pain in joints, tingling sensations, dizziness, paralysis, choking, and/or loss of consciousness.

NOTE

There is no corresponding DDI caution for the CABIN caution light.

2.16.2.4.2 CK ECS Caution Light. The yellow CK ECS caution light is located on the lower right caution lights panel. The light illuminates when the position of cabin pressurization related controls will inhibit cabin pressurization.

NOTE

There is no corresponding DDI caution for the CK ECS caution light.

2.16.3 Defogging System. The defogging system receives a portion of the conditioned air that is delivered to the cockpit and controlled by the mode switch and outer temperature knob as described above. The air is directed to a defog nozzle inboard of the forward portion of the windshield. The amount of defog air is controlled by the defog handle.

2.16.3.1 Defog Handle/Cockpit Louvers. The defog handle, on the right console outboard of the ECS panel, controls the division of air flow between the windshield defog outlets and the cockpit air outlets. As the handle is moved toward HIGH (forward), more air is diverted to the defog outlets. With

defog handle set within ten percent of HIGH, the air temperature increases. For maximum cockpit cooling, pull the defog handle full aft, the side louvers should be directed towards the body with the center louver fully closed. Care should be taken to return the handle to the normal position prior to descending into warm, humid conditions to avoid abrupt canopy fogging.

2.16.4 Windshield Anti-Ice and Rain Removal System. The windshield anti-ice and rain removal systems use the same air nozzle to direct warm air over the external windshield in order to improve pilot forward visibility in icing/raining conditions. Warm air is provided by mixing engine bleed air with output from the primary heat exchanger. Windshield air nozzle orientation is intended to affect (in flight) an area roughly 20 inches to the left and 9 inches to the right of centerline at design eye level and below. System operation is controlled by the WINDSHIELD switch.

2.16.4.1 Windshield Anti-Ice/Rain Switch. The windshield anti-ice/rain switch is on the right console aft of the defog handle.

OFF	No anti-ice/rain removal air flow. This center position is lever-locked and the switch must be pulled up before placing it to either of the other two positions.
ANTI ICE	High-volume high-pressure air at 250° F is distributed across the windshield.
RAIN	Low-volume low-pressure air at 250° F is distributed across the windshield.

2.16.4.2 Windshield Hot Display. If the temperature of the air being distributed across the windshield becomes excessive or the windshield temperature sensor fails a WDSHLD HOT caution is displayed on the DDI.

2.16.5 Suit Ventilation System. The suit ventilation system supplies temperature controlled and pressure regulated air to the pilot's vent suit disconnect located on the left console. Selected vent suit temperature is controlled by the air conditioning system controller operating the vent suit temperature sensor and vent suit temperature valve. The system is operational with the ECS MODE switch on the ECS panel, located on the right console, in MAN or AUTO. (See Mode Switch for operational control of the system.) Flow rate to the vent suit can be reduced below maximum by the use of the vent suit flow control knob on the pilot services panel located on the left console.

2.16.6 Anti-G System. The anti-g system allows air pressure into the suit proportional to the g force experienced. A button in the valve allows the pilot to manually inflate his suit. The system incorporates a pressure relief valve.

2.16.7 Avionics Cooling and Pressurization. Avionics cooling and pressurization is augmented by ram air if the flow drops below the desired value. If avionics cooling is inadequate, the AV AIR HOT caution display comes on. If the temperature in either flight control computer A or the right transformer-rectifier is high, FCS HOT caution display and light come on. Placing the AV COOL switch, on the lower right instrument panel, to EMERG opens a ram air scoop to supply cooling air to these units. The scoop cannot be closed in flight. A transient (up to 3 minutes) AV AIR HOT caution can occur in hot weather following transition from ground fan cooling at IDLE to conditioned air cooling with high throttle setting or with the APU operating in bleed air augmentation mode.

2.16.7.1 Fan Test Switch. The fan test switch located above the aft end of the right console permits maintenance testing of the cockpit avionics cooling fans.

2.17 EMERGENCY EQUIPMENT

2.17.1 Jettison Systems. The jettison systems consist of the emergency jettison system and the selective jettison system.

2.17.1.1 Emergency Jettison Button. The emergency jettison system utilizes the emergency jettison button to jettison all stores/launchers/racks from the BRU-32A racks on the five pylon weapon stations (2, 3, 5, 7, and 8). The landing gear handle must be up or weight off wheels to enable the emergency jettison button. The emergency jettison button, labeled EMERG JETT, is a momentary pushbutton on the left edge of the instrument panel and is painted with alternating black and yellow stripes. The button must be held pressed during the entire jettison sequence. Jettison is sequential by station pairs starting with stations 2 and 8, then stations 3 and 7, and finally, station 5. The BIT advisory and an SMS BIT status of DGD is the only enunciated indication of a stuck emergency jettison button.

NOTE

Hold EMERG JETT pressed for at least 375 msec to ensure all stores are jettisoned.

If the EMERG JETT button is stuck, emergency jettison is activated as soon as the aircraft goes W off W.

2.17.1.2 Selective Jettison. Selective jettison is performed using the SELECT JETT knob, in conjunction with the JETT STATION SELECT buttons, and jettisons stores in a safe condition. The stores or the launchers/racks (with any attached stores) can be jettisoned from the centerline and wing stations, and the missiles can be jettisoned from the fuselage stations.

Selective jettison requires ARM conditions satisfied and all the landing gear up and locked. ARM conditions are satisfied with WoffW, LDG GEAR handle UP, MASTER ARM switch in ARM, and SIM mode unboxed. ARM status can be confirmed on the STORES page. All the landing gear up and locked can be confirmed by the absence of the LDG GEAR handle warning light/landing gear warning tone with the LDG GEAR handle UP.

Selective jettison of the centerline and wing stations requires station(s) selection by the JETT STATION SELECT buttons and STORES or RACK/LCHR selection by the SELECT JETT knob. Selective jettison of a fuselage station missile requires R FUS MSL or L FUS MSL selection by the SELECT JETT knob.

With all the requirements met, selective jettison is performed by pressing the JETT center pushbutton in the SELECT JETT knob.

2.17.1.2.1 Station Jettison Select Buttons. The station jettison select buttons are on the left edge of the instrument panel below the emergency jettison button. The buttons are labeled CTR (center), LI (left inboard), RI (right inboard), LO (left outboard) and RO (right outboard). Pressing a button illuminates an internal light and selects a weapon station for jettison. The station jettison select buttons are also used in the backup A/G weapon delivery modes for weapon selection; refer to NTRP 3-22.4-FA18A-D and NTRP 3-22.2-FA18A-D NATIP.

2.17.1.2.2 Selective Jettison Knob. The selective jettison knob on the left vertical panel has rotary positions L FUS MSL, SAFE, R FUS MSL, RACK/LCHR, and STORES. L FUS MSL and R FUS MSL selects the required fuselage missile for jettison. The RACK/LCHR and STORES positions select what is to be jettisoned from the weapon stations selected by the station jettison select buttons. The

JETT center pushbutton activates the jettison circuits provided the landing gear is up and locked and the master arm switch is in ARM. The SAFE position prevents any selective jettison.

2.17.1.2.3 Auxiliary Release Switch. The auxiliary release switch, on the lower instrument panel, is used to enable jettison of hung stores or store and rack/launcher combinations from BRU-32/A racks on stations 2, 3, 5, 7, and 8. A need to use the auxiliary release switch is indicated by a hung indication on the DDI after selective jettison or a normal weapons release is attempted. Place the switch to ENABLE to select the auxiliary release function. The master arm switch must be in ARM. Initiate jettison by selecting RACK/LCHR or STORES on the selective jettison knob, select the hung store station by pressing the appropriate station jettison select button, and then press the JETT center pushbutton of the selective jettison knob. The SMS provides a jettison signal to fire the auxiliary cartridge in the BRU-32/A rack on which the hung store or store and rack/launcher combination is loaded. After the cartridge is fired, the store or rack/launcher is gravity dropped with the store in a safe condition. This switch is also used with some weapons for a second normal release attempt after these weapons have been hung during a first normal release attempt. Refer to NTRP 3-22.4-FA18A-D and NTRP 3-22.2-FA18A-D NATIP for these weapons and procedures.

2.17.2 Warning/Caution/Advisory Lights and Displays. The warning/caution/advisory lights and displays system provides visual indications of normal aircraft operation and system malfunctions affecting safe operation of the aircraft. The lights are on various system instruments and control panels in the cockpit. The red warning lights normally indicate a systems malfunction that could be a severe hazard to further flight, and may require immediate action. Caution lights and displays normally, but not always, indicate malfunctions that require attention but not immediate action. After the malfunction has been corrected, warning and caution lights and caution displays go out. Advisory lights and displays indicate safe or normal conditions and supply information for routine purposes. On aircraft 163985 AND UP, warning, caution and advisory displays are NVG compatible. Caution and advisory displays appear on the left, right or center DDIs, depending on the number of DDIs in operation. The advisory displays start at the bottom of the DDI display and are preceded by ADV. The caution displays, in larger characters than the advisory displays, appear immediately above the advisory displays. The caution lights, located on the caution lights panel and the instrument panel, are yellow lights. The advisory lights, scattered throughout the cockpit, are white or green. Turned on lights on the caution lights panel flash when overheated to prevent light damage.

2.17.2.1 Master Caution. A yellow MASTER CAUTION light, on the upper left part of the instrument panel, comes on when any of the caution lights or caution displays come on. The MASTER CAUTION light goes out when it is pressed (reset). An audio tone is initiated whenever the MASTER CAUTION light comes on. The tone is of 0.8 second duration. The tone consists of a 0.25-second sound followed by a 0.15-second sound of higher pitch, followed by one repetition of these sounds. Once sounded, the tone does not repeat unless the original condition causing the tone clears and recurs 5 seconds after the first tone, regardless of whether or not the MASTER CAUTION is reset. Additional cautions sound the tone, regardless of whether or not the MASTER CAUTION is reset, providing about 5 seconds have elapsed since the previous caution. Pressing the MASTER CAUTION when it is not illuminated causes the uncorrected caution and advisory displays on the DDIs to reposition to the left and to a lower level, provided there is available space vacated by corrected caution and advisory displays. To restack the cautions and advisories when the MASTER CAUTION is lighted, the MASTER CAUTION must be pressed twice: first, to turn off the MASTER CAUTION light and second, to reposition the caution and advisory displays. A reset MASTER CAUTION light (and tone) comes on providing there is at least one uncorrected caution present when weight is on the wheels and both throttles are moved beyond approximately 80 % rpm or, providing both throttles were below 80 % for at least 60 seconds.

2.17.2.2 Dimming and Test Functions. There are no provisions for testing the caution and advisory displays on the DDIs, and each DDI contains its own display dimming controls. The warning/caution/advisory lights are dimmed by the warning/caution lights knob, and they are tested by the lights test switch. See lighting equipment, this chapter, for operation of the warning/caution lights knob and the lights test switch. The following lights can be dimmed by the warning/caution lights knob, but once in the dimmed lighting range cannot be varied in intensity: MASTER CAUTION light, landing gear handle warning, L BAR warning, HOOK warning, L BLEED warning, R BLEED warning, APU FIRE warning, left and right engine FIRE warning.

2.17.3 Voice Alert System. For certain critical warnings and cautions, voice alert transmissions are sent to the pilot's headset. The message is repeated twice; for example, "APU FIRE, APU FIRE". The voice alert requires no reset action on the pilot's part and the alert is not repeated unless the original condition ceases for 5 seconds or more and then recurs. The ALTITUDE voice alert, when initiated by the primary radar low altitude warning, has a high priority for its first annunciation and is repeated continuously at the lowest priority until reset or disabled by the pilot. For cautions with voice alert, the voice alert replaces the master caution tone; however, the master caution tone backs up the voice alert system, and provides a tone if the voice alert system malfunctions. FIRE, APU FIRE, L BLEED, and R BLEED warnings are not backed up by the master caution tone. Voice alert is the only audio warning for these problems. With dual generator failure, the following voice alert warnings operate from battery power: APU FIRE, L(R) FIRE, and L(R) BLEED. The ALTITUDE voice alert warning, all voice alert cautions, and the master caution tone are inoperative on battery power during dual generator failure. Once a voice alert has been activated, it cannot be interrupted by a higher priority voice alert. All voice alerts play until completed.

CAUTION

IFF 4

DEL ON,
MECH ON,
FLAPS OFF,
AIL OFF,
RUD OFF,
FLAPS SCHED,
or G-LIM 7.5 G

FCS HOT

L(R) OVRSPD,
L(R) EGT HI,
L(R) IN TEMP,
L(R) FLAMEOUT,
L(R) OIL PR,
or L(R) STALL

FUEL LO

BINGO

VOICE ALERT

MODE 4 REPLY

FLIGHT
CONTROLSFLIGHT
COMPUTER HOT

ENGINE LEFT (RIGHT)

FUEL LOW

BINGO

WARNING

ALTITUDE LOW

L(R) BLEED AIR

L(R) FIRE

APU FIRE

1 ▷ MC OFP 10A

VOICE ALERT

ALTITUDE

1 ▷ WARNING

BLEED AIR LEFT (RIGHT)

ENGINE FIRE LEFT (RIGHT)

APU FIRE

2.17.4 TAWS - Terrain Awareness Warning System (SCS 17C AND UP). The terrain awareness warning system alerts the aircrew of a controlled flight into terrain (CFIT) condition during all mission phases. The system operates any time that the navigation mission computer (MC1) and TAMMAC digital mapping set (DMS) are functional. TAWS functions as a safety backup system and not as a performance aid. TAWS has been designed to eliminate false warnings, minimize nuisance warnings, and generate consistent aircrew response in all aircraft master modes. Five possible voice warnings are provided to indicate the correct initial response to an impending CFIT condition, and a visual cue is provided to indicate the recovery direction of pull, or in some instances, to command an increase in turn rate. All TAWS warnings should be treated as though an imminent flight into terrain condition exists. Pilot response to a TAWS warning should be instinctive and immediate.

TAWS uses data from the following inputs: ADC, FCC, INS, RADALT, GPS, and digital terrain elevation data (DTED). DTED resides in the DMS as part of TAMMAC and is used to provide the forward-prediction capability that protects against flight into rising terrain. The TAWS option is reached, by pressing MENU-HSI-DATA-A/C as shown in figure 2-38. The TAWS option boxes automatically at start-up.

When a DMS is not installed in the aircraft or is not operational, protection from CFIT events is provided by the Ground Proximity Warning System (GPWS). BIT may be initiated on the DMS by pressing the appropriate pushtile of the BIT display. The BIT can take up to 185 seconds to complete. During the BIT, TAWS is not operational. Therefore, the GPWS algorithm is used to determine the presence of possible CFIT events. There is no capability for pilot selection of GPWS if DMS is operational. The GPWS algorithm runs continuously with outputs being overwritten if TAWS is operational. This prevents erroneous values during an unexpected transition from TAWS to GPWS.

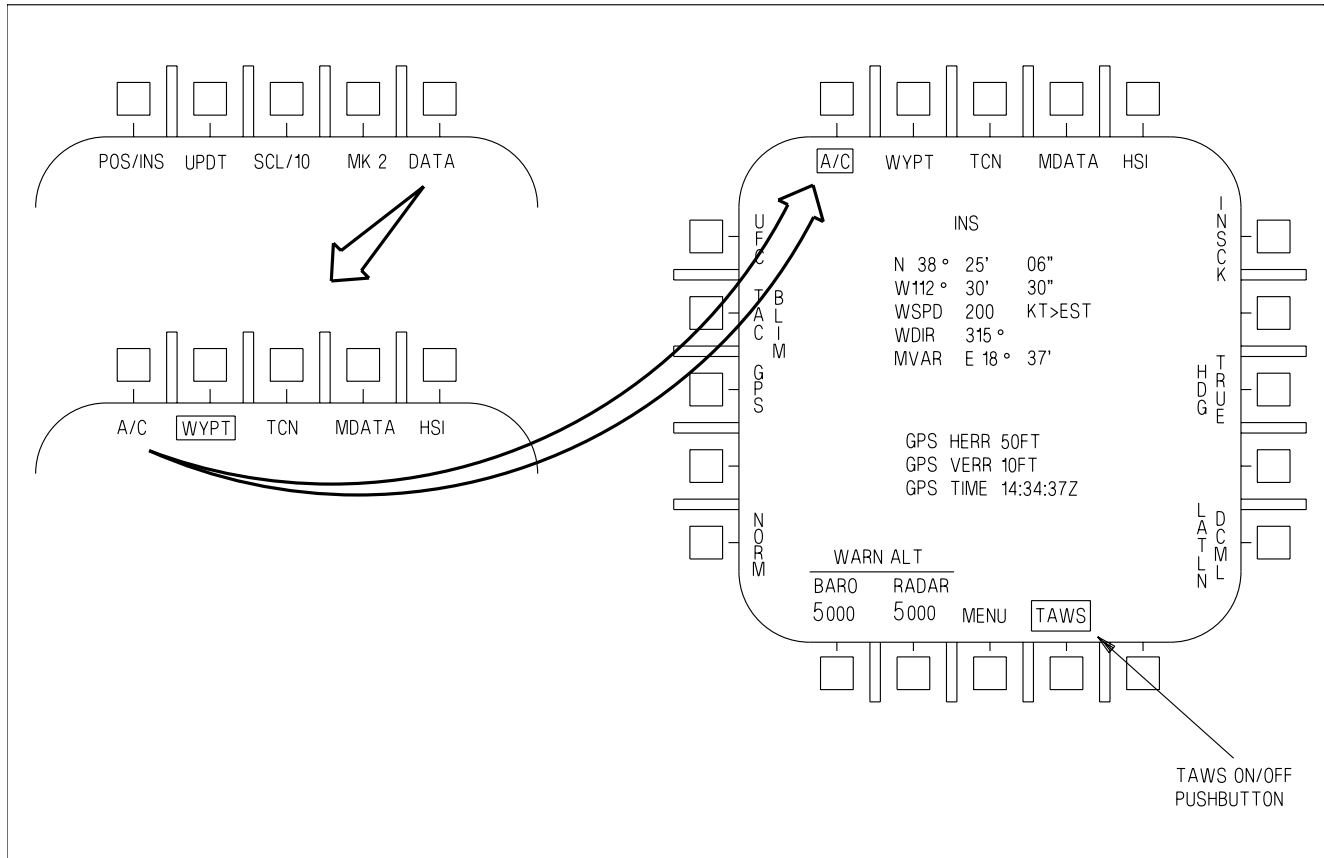

ADA520-359-1.049

Figure 2-38. TAWS ON/OFF Pushbutton

2.17.4.1 TAWS Modes. TAWS has two operational modes: TAWS-with-DTED, and TAWS-without-DTED. These modes switch automatically depending upon the available sensor data and flight phase. When the aircraft position (latitude and longitude) is accurately known and DTED for the local area has been loaded onto the DMS (during the theater load process), TAWS is in the TAWS-with-DTED mode and provides protection against varying terrain ahead of the aircraft. When the aircraft position is not accurately known, DTED for the local area is unavailable, or TAWS determines the aircraft is in a landing phase, TAWS transitions to the TAWS-without-DTED mode and provides protection against flight into level or descending terrain as GPWS does.

When operating over the ocean, DTED does not exist and TAWS will be in the TAWS-without-DTED mode. However, there is no degradation in protection because the ocean is relatively flat. As the aircraft approaches the coast or islands, DTED may be available (depending upon the theater load) and TAWS will automatically switch back to the TAWS-with-DTED mode.

Operation of TAWS in the TAWS-without-DTED mode is still an improvement over GPWS as TAWS incorporates a more robust performance model and additional input sensor redundancy.

2.17.4.2 TAWS Operation. TAWS incorporates signal processing that determines a best estimate of aircraft position and altitude (AGL and MSL). TAWS protection algorithm continuously computes two recovery trajectories: Vertical Recovery Trajectory (VRT) and Oblique Recovery Trajectory (ORT). VRT is the standard GPWS-like recovery: roll to wings-level, if needed, and pull to recover. ORT assumes that you maintain the current bank angle and pull to recover (increase turn rate). Both computed trajectories include the following assumptions:

- a. Pilot Response Time is the time from issuance of a TAWS warning to the time that the pilot actually initiates recovery. Pilot Response Time is set at 1.3 seconds.
- b. Roll Recovery Phase is the time necessary to roll the aircraft to near wings-level. This assumes at least $\frac{1}{2}$ lateral stick will be used for bank angles less than 70° and at least $\frac{3}{4}$ lateral stick will be used for bank angles $\geq 70^\circ$.
- c. G-Onset Phase is the time required to pull to the target recovery g. The target recovery g is 80 % of the instantaneous g available, or 5g, whichever is less. The g-onset phase assumes that rapid aft stick motion will be used (full deflection within $\frac{3}{4}$ second). In addition, TAWS assumes that throttles will be moved to MAX if below corner speed and to IDLE if above corner speed.
- d. Dive Recovery Phase is the remainder of the trajectory until terrain clearance is achieved. TAWS assumes a terrain clearance of 50 ft.

When TAWS senses that the aircraft is in the landing configuration, the recovery assumptions must change since the desire is to land. TAWS defines the landing phase as below 500 ft AGL, less than 200 KCAS, landing gear down and locked, and more than one minute since a waveoff or takeoff. In the landing phase, TAWS protects against landings of greater than the structural limit of the landing gear (1584 fpm). To allow this, TAWS switches to TAWS-without-DTED and provides a warning when the landing is predicted to exceed the structural limit of the landing gear.

TAWS provides protection against gear-up landings. When the aircraft is below 200 KCAS, below 150 ft AGL, more than one minute since waveoff or takeoff, and the landing gear is not down and locked, a TAWS warning is provided.

2.17.4.3 TAWS Warnings. TAWS provides clear, unambiguous, and directive aural and visual cues to the aircrew. Aural warnings provide the aircrew with a wake-up call and correct initial response while visual warnings provide the aircrew with correct follow-on recovery information.

2.17.4.3.1 Voice Warnings. TAWS uses the ACI to provide aural cues to the aircrew. The aural cues are distinct from any other cues that the aircrew may receive. The TAWS voice alert warnings are: "Roll-Left...Roll-Left", "Roll-Right....Roll-Right", "Pull-Up...Pull-Up", "Power...Power", and "Check Gear". Each of these warnings is issued at a level 3-6 dB above the present voice alerts. The TAWS voice warnings provide a wake-up call to the aircrew and indicate the most appropriate initial response for the given aircraft state, not necessarily the only required response. The aural cue repeats until the warning condition is cleared. TAWS aural warnings have priority over all current aural tones. Note that TAWS requires a -1018 or greater ACI load (or MIDS equivalent) which is capable of generating the "Roll Left/Right" warnings. Earlier ACI loads were only capable of generating "Roll Out" warnings and are not desired for use with TAWS.

A "Roll Right...Roll Right" warning is issued when a roll to the right is the correct initial response.

A "Roll Left...Roll Left" warning is issued when a roll to the left is the correct initial response.

A "Power...Power" warning is issued when the roll requirement conditions have not been met and adding power is the correct initial response. This occurs when the aircraft is below 200 KCAS, the AOA is above 8.5° for flaps HALF or FULL (or 18° AOA for up and away configuration) and the throttle is not already at MAX. The correct response to this warning is to select MAX afterburner.

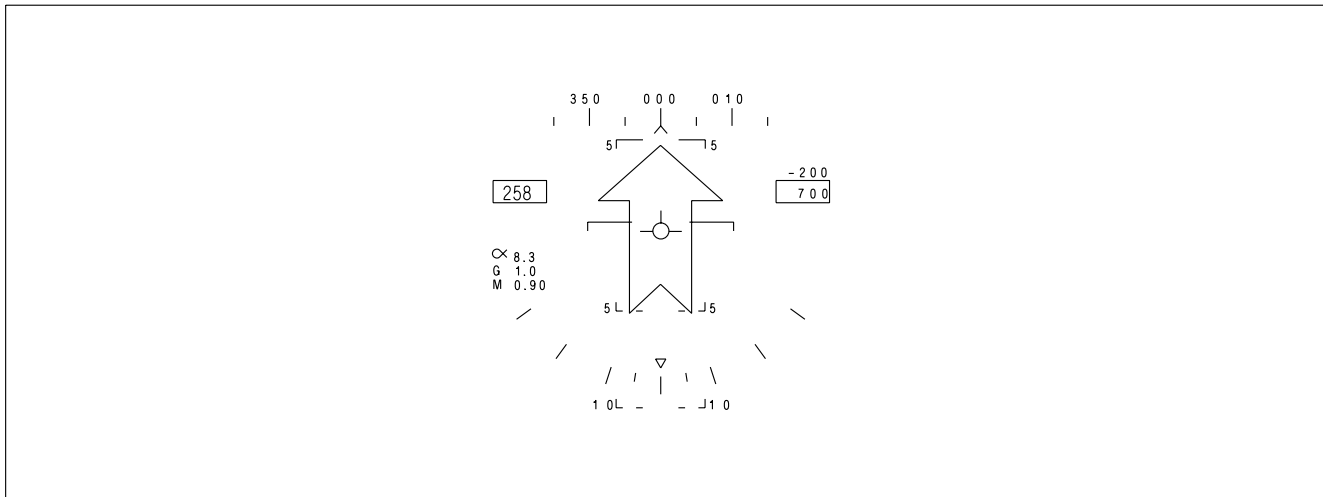

ADA520-360-1.049

Figure 2-39. TAWS HUD Visual Recovery Cue - Pull Up (VRT)

A "Pull Up...Pull Up" warning is issued when the above conditions have not been met and pulling up is the correct response or when the ORT is the recovery trajectory.

When a warning is given to protect against a gear-up landing, the following aural cues may be heard:

"Pull Up...Pull Up" followed two seconds later by "Check Gear" when the gear handle is in the UP position and a gear-up landing condition has been assessed (repeated every 4 seconds).

"Check Gear" repeated every 8 seconds when the gear handle is down and a gear up landing condition has been assessed.

2.17.4.3.2 Visual Warnings. A visual recovery arrow is provided in the center of the HUD and HUD format on the DDI. The recovery arrow indicates the direction of recovery. The visual warning is displayed when a CFIT condition is present and is removed when the CFIT condition is cleared.

TAWS visual recovery cues are designed to be used in conjunction with TAWS voice warnings. There are several voice warning/visual recovery cue combinations. When the arrow points UP in the HUD (i.e., along the lift vector), a longitudinal pull is the correct response and an aural "Pull Up...Pull Up" is heard. This is a VRT recovery if the aircraft is close to wings level, or it is an ORT (increased turn rate) recovery if the aircraft is banked such that the TAWS algorithm assessed that an increased turn rate would provide the quickest recovery from an impending CFIT condition. Figures 2-39 and 2-40 depict these two situations. Both situations require a longitudinal pull as the correct response, however, the first case (VTR) depicts a dive recovery while the second case (ORT) depicts a recovery requiring an increase in turn rate by increasing g when already in an established angle of bank.

When the arrow points anywhere other than UP in the HUD (i.e., not along the lift vector, but perpendicular to the horizon), it may be accompanied by either a "Roll Left (Right)"... "Roll Left (Right)" or "Pull Up...Pull Up" voice warning. The voice warning indicates the correct initial response, then the aircrew should roll or pull as required to place or maintain the TAWS recovery arrow straight up in the HUD (i.e., along the lift vector). For example, if a "Roll Left...Roll Left" voice warning is issued with an accompanying HUD recovery HUD recovery arrow displayed in the HUD that is perpendicular to the horizon, the correct response is to roll left to align the lift vector with the HUD recovery arrow and then perform a dive recovery. If a "Pull Up...Pull Up" voice warning is issued with an accompanying HUD recovery arrow displayed in the HUD that is perpendicular to the horizon, the correct response is to apply g along the current lift vector and then, referencing the HUD recovery

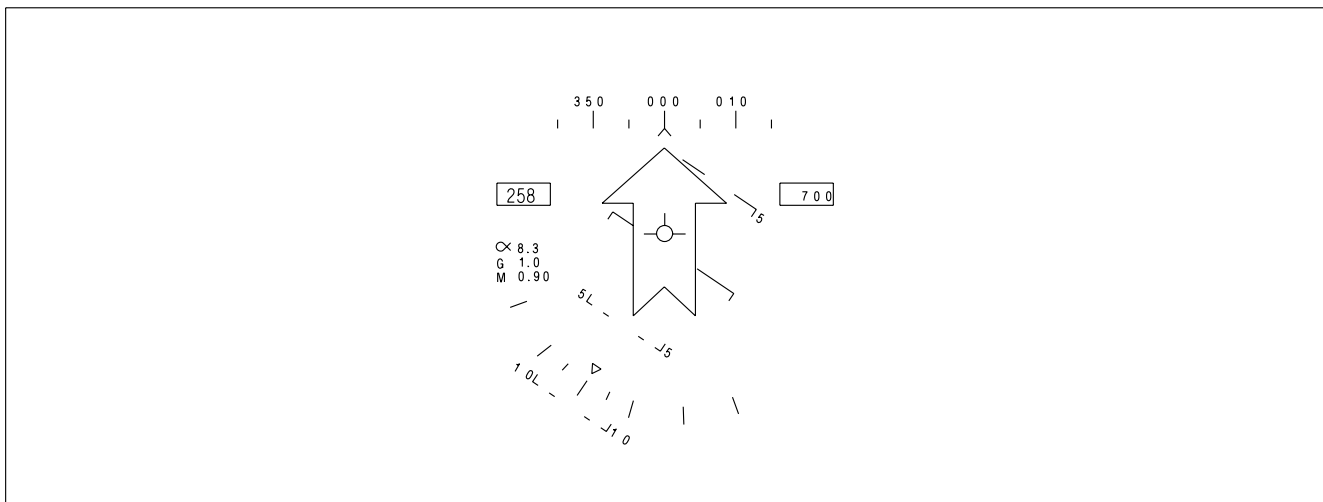

ADA520-361-1.049

Figure 2-40. TAWS HUD Visual Recovery Cue - Pull Up (ORT)

arrow, roll to align the lift vector with the HUD recovery arrow and perform a dive recovery. Figure 2-40 depicts a situation in which a roll or pull up aural warning could be issued. If a "Roll Right...Roll Right" aural warning was issued, a roll to the right would be the correct initial response and then a dive recovery would be continued with a longitudinal pull. If a "Pull Up...Pull Up" aural warning was issued, a longitudinal pull would be the correct initial response and then a roll to the right to align the lift vector with the HUD recovery arrow followed by a longitudinal pull for a dive recovery would be the follow-on recovery procedure.

2.17.4.4 HUD Reject 1. Reject 1 is enabled on non-night attack aircraft when the HUD is commanded to display a TAWS visual cue. In non-night attack aircraft, HUD write time limitations occur when the TAWS visual cue is displayed on the HUD. The write time limitation causes a loss of symbology. Enabling Reject 1 allows more important symbology to be displayed while less important symbology is not displayed.

2.17.4.5 ACI Configuration Check. There are three different ACI configurations in the F/A-18 aircraft. Lot 9 and lower ACIs are not TAWS/GPWS compatible. Lot X and above can have either of two TAWS software loads: -1016 and -1018. The -1016 ACIs can command these four aural cues: "Roll Out...Roll Out", "Pull Up...Pull Up", "Check Gear", and "Power...Power". The -1018 and greater ACIs added logic for replacing the "Roll Out...Roll Out" aural cue with "Roll Left...Roll Left" and "Roll Right...Roll Right". Due to the variety of possible combinations, on cold start power-up, the MC commands a "Roll Left...Roll Left" to the ACI to determine if it is in the -1018 configuration. If there is no response, the MC commands a "Roll Out...Roll Out" to the ACI to determine if the ACI is in the -1016 configuration. If no response is received the second time the MC attempts to command a "Roll Out...Roll Out", the TAWS/GPWS voice warnings will not be heard with MC OFPs prior to 19C. With MC OFP 19C, the TAWS/GPWS voice warnings will be replaced by the "Whoop...Whoop" warning tone. In all cases, the visual arrow will still be present when a warning is issued. With MC OFP 19C, the ACI advisory is displayed on the DDI when the ACI does not pass the GPWS configuration check during MC cold start.

2.17.5 GPWS - Ground Proximity Warning System (MC OFP 10A+ AND UP, 13C AND UP). GPWS is a safety backup system that warns the aircrew of impending controlled flight into terrain (CFIT).

The GPWS is executed by an algorithm within the mission computer OFP. It operates when MC1 is powered on. The GPWS option located on the A/C sublevel display allows the pilot to disable/enable the system. The GPWS option is reached by pressing MENU, HSI, DATA, A/C. The GPWS algorithm commands distinctive visual and aural cues to alert and direct recovery from an impending CFIT condition. All GPWS warnings should be treated as imminent flight into terrain, unless reassessed situational awareness dictates otherwise. Pilot response to a valid warning should be instinctive and immediate, using the maximum capabilities of the aircraft to recover until safely clear of terrain. The GPWS is inoperative with failed INS or ADC. It is recommended that the GPWS function be disabled to prevent false GPWS warnings during landing due to inaccurate vertical velocity.

WARNING

GPWS has no forward looking or predictive capability. It provides no protection under the following conditions:

- RADALT, ADC, MC1 or INS off or failed.
- Transonic flight (0.95 to 1.04 IMN) outside the valid RADALT data envelope.
- For 1.5 seconds after a break X is displayed.
- Less than 6 seconds after weight off wheels.
- Less than 5 seconds or greater than 120 seconds outside the valid RADALT data envelope ($\pm 50^\circ$ pitch and AOB).
- Dives greater than 50° after 2 minutes above 5,000 feet AGL.
- After a waveoff until exceeding a 1,000 fpm climb for 5 seconds.

GPWS provides only limited protection and may not provide adequate warning under the following conditions:

- Rising terrain of greater than 2° slope.
- Coast mode (5 to 120 seconds outside valid RADALT envelope).
With MC OFP 19C, full GPWS coverage is available when flying over level terrain at mean sea level.
- Within GPWS defined LAT envelope ($\pm 30^\circ$ AOB, 0 to 30° dive, 450 to 560 KCAS).
- Below 150 feet AGL and 200 KCAS.

2.17.5.1 Sensors/Modes. The GPWS is a look down system with no forward look capability. GPWS uses the RADALT, INS, and ADC, with the RADALT as the primary source of information for terrain clearance. RADALT data is considered valid by GPWS below 4,950 feet AGL and at a pitch or angle of bank less than 50° . Outside the valid RADALT data envelope, one of two options is used: 1) COAST mode: for level terrain protection continues after a 5-second delay for up to 2 minutes assuming a constant terrain elevation. With MC OFP 19C, full GPWS coverage is available when flying over level terrain at mean sea level. 2) BYPASS mode: for uneven terrain or while in the transonic region (Mach 0.95 to Mach 1.04) GPWS is turned off to prevent nuisance cues. (Terrain with less than a 2° slope is defined as level.) Full protection is resumed from both modes when valid RADALT data is restored.

2.17.5.2 CFIT Protection Provided - Altitude Loss During Recovery (ALDR).

Above 150 feet AGL -

GPWS provides CFIT protection by continuously calculating, at current flight conditions, the altitude required to recover above the terrain. A warning is issued when the altitude required for recovery, plus a variable safety buffer and an added terrain clearance altitude, is greater than the current altitude

above terrain. (The terrain clearance altitude varies between 30 feet, 50 feet, and 90 feet depending on flight conditions.) GPWS calculates the altitude required for recovery from a pilot response time, a roll to wings level, and a dive recovery. The allowable pilot response time varies, depending on flight conditions, and is at a minimum (0.5 second) in the GPWS LAT envelope ($\pm 30^\circ$ AOB, 0 to 30° dive, 450 to 560 knots). The altitude lost while rolling to wings level is based on a 1/2 to 3/4 lateral stick displacement roll at 1g. The altitude loss during the dive recovery is based on a target g onset rate and a target sustained g as shown below.

	Target g Onset Rate	Target Sustained g
Airspeed < 400 knots or AOB > 30°	80 % of available g onset rate up to 5g/second	80 % of g available up to 5g
Airspeed ≥ 400 knots and AOB $\leq 30^\circ$	80 % of available g onset rate up to 6g/second	90 % of g available up to 6g

NOTE

These g onset rates and sustained g levels require an aggressive pilot response.

Below 150 feet AGL -

Protection is provided by warnings issued when current flight conditions could potentially result in CFIT. The warnings are based on the time since weight-on-wheels or a waveoff and then on a combination of landing gear position, airspeed, altitude, and sink rate. (A waveoff is defined as 1000 fpm rate of climb for more than 5 seconds while below both 500 feet AGL and 200 knots.) The following conditions will cause a warning to be issued below 150 feet AGL:

1. When more than 60 seconds since weight-on-wheels or a waveoff:
 - a. Floor Altitude
Descending below 90 feet AGL with the airspeed greater than 200 knots.
 - b. Check Gear
Descending below 150 feet AGL with the landing gear not down and the airspeed less than 200 knots.
 - c. Landing Sink Rate
Descending below 150 feet AGL with the landing gear down, the airspeed less than 200 knots and a sink rate greater than a schedule designed to prevent hard landings. The allowable sink rate schedule varies from a maximum of 2,040 fpm to a minimum of 1,488 fpm based on altitude and weight.
 - d. Bank Angle
Below 150 feet AGL, airspeed less than 200 knots and the AOB greater than 45° for 1 second.
2. When less than 60 seconds since WOW or a waveoff:

- a. Floor Altitude
Descending below 90 feet AGL with the airspeed greater than 250 knots.
- b. Takeoff Sink Rate
Descending below 150 feet AGL with airspeed less than 250 knots and a sink rate greater than 300 fpm.

WARNING

- Below 150 feet AGL, GPWS does not directly account for the recovery capabilities of the aircraft so recovery may not be possible following a warning.
- At certain high speed, high gross weight conditions, overriding the g limiter may be required for recovery from dives greater than 50° and will likely be required for dives between 10° and 25°.
- No protection is provided for dives greater than 50° following a high altitude ingress (greater than 2 minutes above 5,000 feet AGL).

NOTE

High speed, heavy gross weight conditions vary from around 550 knots at 38,000 lb to about 480 knots at 48,000 lb.

2.17.5.3 GPWS Visual Cues. Once a GPWS warning is required, the visual warning cue, a steady arrow located in the center of the HUD, is displayed. See figure 2.41. The recovery arrow is always pointed perpendicular to the horizon in the direction of pull required for recovery. The visual warning cue is displayed simultaneously with the voice warning and is removed when GPWS calculates a CFIT condition no longer exists. There is no visual cue with a check gear warning.

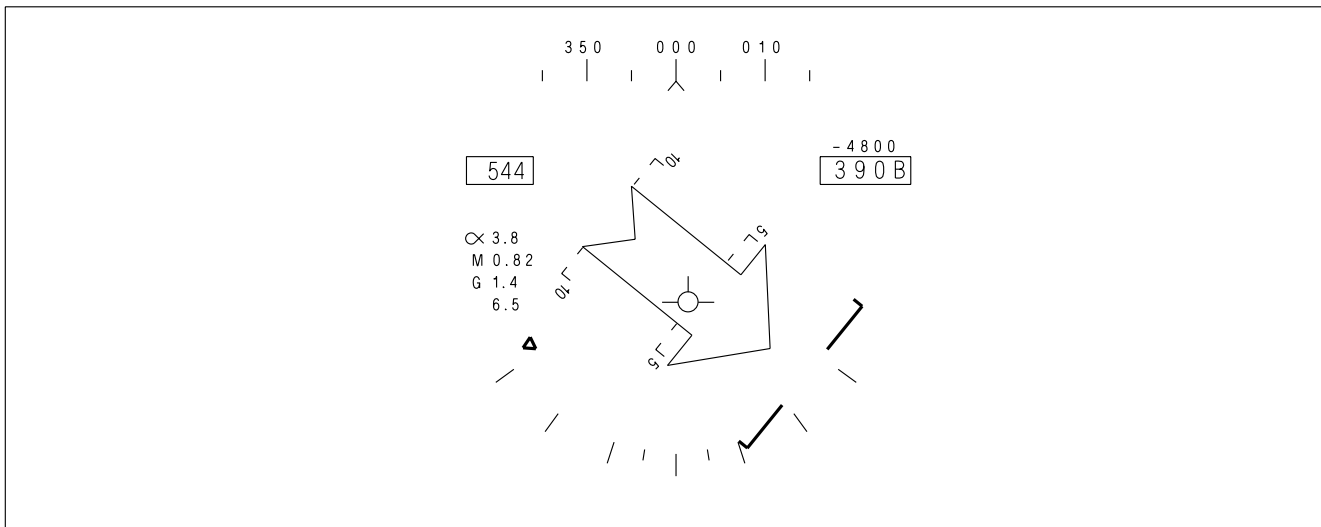

ADA520-377-1-058

Figure 2-41. Visual Warning Cue

2.17.5.4 GPWS Aural Cues.

NOTE

In aircraft with MC OFP 13C AND UP, MC1 does an ACI configuration check after the generator comes online during a cold start power-up. Successful completion of the check is indicated by system initiation of a "ROLL OUT" (for OFP 13C) or "ROLL LEFT" (for 15C) voice alert. If no voice alert is heard, GPWS is disabled and the GPWS option on the MENU/HSI/DATA/AC sublevel display will not be present. If an incorrect voice alert is heard on startup or the GPWS option is not present, notify maintenance and commence troubleshooting the GPWS, ACI, and CSC system components and wiring.

Along with the visual warning cue the system issues directive voice commands as follows:

If F/A-18A/B aircraft before AFC 253 or 292 -

The aural cue "RECOVER.....RECOVER" is used for all GPWS CFIT conditions. It has priority over all other cues and is twice as loud as the existing cues.

If F/A-18A aircraft after AFC 253 or 292 or F/A-18C/D aircraft -

"POWER.....POWER" if the airspeed is less than 210 knots.

"PULL UP.....PULL UP" if the airspeed is greater than or equal to 210 knots.

"CHECK GEAR.....CHECK GEAR" when descending below 150 feet AGL (less than 200 knots) if the gear is not down and locked and more than 60 seconds since a weight-on-wheels or a waveoff.

With MC OFP 11C and 13C - "ROLL OUT.....ROLL OUT" if the (AOB) angle of bank is greater than 45°.

With MC OFP 15C AND UP - "ROLL LEFT.....ROLL LEFT" or "ROLL RIGHT.....ROLL RIGHT" if the (AOB) angle of bank is greater than 45°.

The voice commands are repeated every 2 seconds (every 8 sec for check gear warnings) and in the C/D will automatically transition to the appropriate voice command for the current stage of recovery (e.g. “ROLL OUT.....ROLL OUT” followed by “PULL UP.....PULL UP” when AOB is returned to less than 45°). The voice commands are terminated when the appropriate recovery maneuver is initiated (e.g., a pull up initiated within 0.5g of the GPWS calculated target g).

WARNING

- Complying with the directive voice command but delaying other required actions may result in an unrecoverable situation (e.g., adding power but delaying an aft stick pull following the voice command “POWER.....POWER”).
- GPWS voice warnings are inhibited during RADALT warnings or during system voice alerts.

2.18 OXYGEN SYSTEM

2.18.1 Normal Oxygen Supply (LOT 4-12). Normal oxygen is supplied by a 10 liter liquid oxygen system. Oxygen is routed through a hose from the left console to the ejection seat then through the survival kit to the pilot’s oxygen regulator connector.

2.18.1.1 OXYGEN Supply Lever. A two-position ON/OFF OXYGEN supply lever is on the pilot’s service panel at the aft end of the left console.

WARNING

If OXYGEN supply lever is ON and the mask is not properly donned, the flow control valve could freeze in the open position and cryogenic burns could result.

2.18.1.2 Oxygen Quantity Gage. An oxygen quantity gage is on the pilot’s service panel. It is calibrated in liters from 0 to 10.

2.18.1.3 Oxygen Test Button. Pressing and holding the oxygen test button causes the pointer on the oxygen gage to rotate counterclockwise.

2.18.1.4 OXY LOW Display. An OXY LOW caution comes on when the oxygen quantity indication is below 1 liter. It also comes on when the oxygen test button is pressed and the pointer on the oxygen gage drops below 1 liter.

2.18.2 Emergency Oxygen Supply (LOT 4-12). A 10-minute supply of gaseous oxygen is contained in a bottle in the survival kit and is teed into the normal oxygen supply hose as it passes through the kit. A pressure gage is visible through a hole in the left front corner of the survival kit cushion. The emergency oxygen supply is activated automatically upon ejection. The emergency oxygen supply may be activated manually by pulling the emergency oxygen green ring under the inside of the left thigh.

WARNING

Under less than optimum conditions (low altitude, heavy breathing, loose-fitting mask, etc.), as few as 1.5 minutes of emergency oxygen may be available.

NOTE

If normal oxygen system is contaminated, pull the emergency oxygen green ring, then set the OXYGEN switch to OFF.

2.18.3 On-Board Oxygen Generating System (OBOGS) (LOT 13 AND UP). OBOGS provides oxygen rich breathing gas to the aircrew while either engine is operating. Engine bleed air is cooled and routed through the OBOGS inlet air shutoff valve to the OBOGS concentrator. The breathing gas is routed from the concentrator to a cockpit plenum, where the temperature is stabilized and a limited supply is stored for peak flow demands. From the plenum, the breathing gas flows through the pilot services panel oxygen disconnect, through the seat survival kit, to the aircrew regulators and masks.

WARNING

A leak or break in the breathing gas system anywhere from the pilot services panel oxygen disconnect to the mask will prevent either normal OBOGS breathing gas or emergency oxygen from being delivered to the mask in its intended concentration. Leaks and breaks may be difficult to locate and/or verify. If hypoxic symptoms are experienced or an OBOGS system degrade occurs, immediate descent below 10,000 feet cabin altitude is required to prevent severe or incapacitating hypoxia.

The OBOGS concentrator is powered by the left 115 volt ac bus. Two molecular sieve beds in the OBOGS concentrator remove most of the nitrogen from the engine bleed air. The nitrogen is dumped overboard while the remaining output of oxygen rich breathing gas is supplied to the aircrew.

2.18.3.1 OBOGS Monitor. The CRU-99/A solid state oxygen monitor is located on the left side of the seat bulkhead in the front cockpit and is powered by the Left 28 volt dc bus. The monitor continuously measures oxygen concentration in the OBOGS breathing gas and provides a discrete signal to activate the OBOGS DEGD caution if the oxygen concentration falls below a predetermined level.

WARNING

Loss of electrical power to the OBOGS monitor prevents reporting of OBOGS DEGD conditions.

The monitor performs a power-up BIT during a 2 minute warm-up period and conducts a periodic BIT every 60 seconds. No indication is provided if power-up or periodic BIT pass.

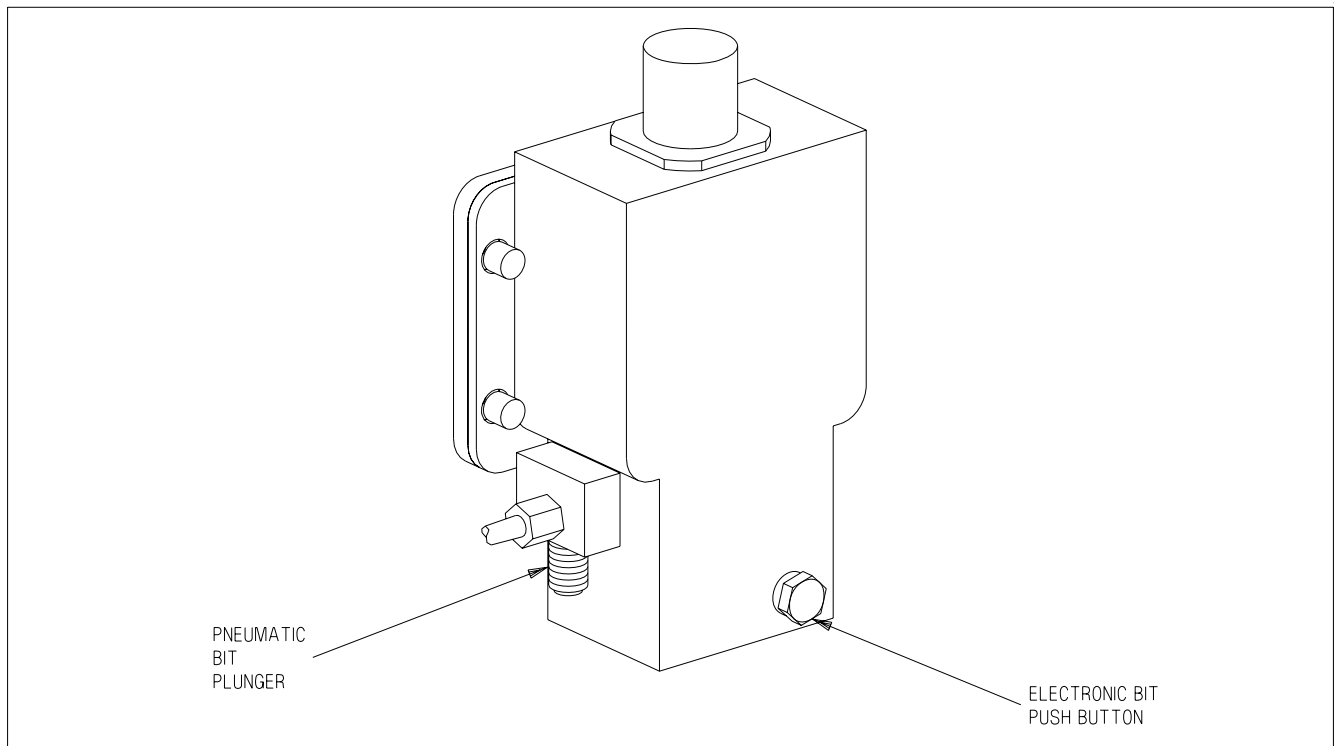

ADA520-357-1-045

Figure 2-42. OBOGS Monitor

Preflight BIT of the monitor is accomplished by using either the pneumatic BIT plunger or the electronic BIT pushbutton. Refer to figure 2-42. Pressing up and holding the pneumatic BIT plunger for 15 to 65 seconds tests the operation of the OBOGS monitor by diverting cabin air into the monitor to create a low oxygen concentration condition. Momentarily pressing and releasing the electronic BIT pushbutton tests the monitor electronically. Successful completion of either test activates the OBOGS DEGD caution, which clears automatically after BIT is complete and OBOGS resets to normal operation.

WARNING

Successful OBOGS monitor BIT is required prior to flight. A BIT failure indicates that there is no protection against inadequate oxygen concentration or hypoxia due to a degraded OBOGS monitor. Good breathing gas flow alone does not ensure adequate oxygen concentration.

2.18.3.1.1 OBOGS DEGD Caution. An OBOGS DEGD caution is set by the OBOGS monitor when oxygen concentration is below a predetermined level. The OBOGS DEGD caution threshold is always above cabin air conditions, in order to provide a physiological safety margin.

NOTE

Oxygen concentration may drop below the predetermined OBOGS DEGD level if breathing gas flow is unlimited. Removing the mask without placing the OXY flow knob to OFF, system leaks, and/or loose aircrew hose connections can overwhelm system capacity and may result in an OBOGS DEGD caution.

After a total loss of bleed air, OBOGS breathing gas flow will be available until the residual gas within the system is depleted. The residual oxygen concentration may be sufficient to keep the OBOGS DEGD caution from illuminating, but loss of system pressure will ultimately lead to inadequate pressure and an abrupt inability to breathe.

Low mask flow or increased breathing resistance may occur without an accompanying OBOGS DEGD caution, which indicates a potential system degradation that may result in oxygen levels below physiological requirements.

WARNING

When cabin altitude is above 10,000 feet, OBOGS DEGD caution procedures shall be executed for low mask flow, increased breathing resistance, or OBOGS DEGD cautions of any duration.

A single brief appearance of the OBOGS DEGD caution immediately following placing the OBOGS control switch to ON, turning the OXY FLOW knob to ON, or after donning or removing the mask is normal. Certain malfunctions affecting the OBOGS system also may momentarily OBOGS DEGD cautions. A momentary OBOGS DEGD caution may clear from the DDI so rapidly that the aircrew may be unable to determine the cause of the MASTER CAUTION light/tone.

CAUTION

Repeated unexplained MASTER CAUTION lights/tones may be an indication of OBOGS system degradation.

Even with the OBOGS DEGD caution displayed, OBOGS breathing gas under normal flow is of higher quality (i.e., oxygen concentration, partial pressure and purity) than cabin air. Once cabin altitude is below 10,000 feet, aircrew may elect to conserve emergency oxygen by resetting the

emergency oxygen release tab, then either removing the mask and breathing cabin air, or returning the OXY FLOW knob and the OBOGS control switch to ON and breathing through the mask.

WARNING

Pure oxygen accelerates recovery from hypoxia. Emergency oxygen shall be used whenever hypoxic symptoms are recognized.

2.18.3.2 Breathing Regulator. The aircrew torso mounted breathing regulator reduces both normal and emergency oxygen system operating pressures to breathing pressure levels. The regulator delivers undiluted OBOGS breathing gas or emergency oxygen to the aircrew at positive pressure, the limits of which increase automatically with altitude. It interfaces with the hose assembly, which connects with the seat survival kit oxygen disconnect.

2.18.3.3 OBOGS Control Switch. The OBOGS control switch, located on the left console in the front cockpit, is used to control electrical power to the OBOGS concentrator and the OBOGS inlet air shutoff valve.

ON Supplies electrical power and engine bleed air to the OBOGS concentrator.

OFF OBOGS system off.

2.18.3.4 OXY FLOW Knob. The OXY FLOW knob, located on the left console in both cockpits, is used to control the supply of OBOGS breathing gas to each aircrew's mask.

ON OBOGS flow supplied to the mask.

OFF OBOGS flow secured.

CAUTION

It is possible to place the OXY FLOW knob in an intermediate position between the ON and OFF detents, which may result in a reduced flow of breathing gas. The OXY FLOW knob should always be fully rotated to the ON or OFF detent position.

2.18.4 Emergency Oxygen (LOT 13 AND UP). Emergency gaseous oxygen is contained in a bottle in the seat survival kit. The bottle is connected into the OBOGS supply hose as it passes through the kit. From this point, the emergency oxygen and OBOGS breathing gas share a common path to the aircrew mask.

WARNING

A leak or break in the breathing gas system anywhere from the pilot services panel oxygen disconnect to the mask will prevent either normal OBOGS breathing gas or emergency oxygen from being delivered to the mask in its intended concentration. Leaks and breaks may be difficult to locate and/or verify. If hypoxic symptoms are experienced or an OBOGS system degrade occurs, immediate descent below 10,000 feet cabin altitude is required to prevent severe or incapacitating hypoxia.

A pressure gauge is visible on the inside left front of the survival kit. The bottle provides approximately 10–20 minutes of oxygen. Oxygen duration decreases with lower altitude.

WARNING

Under less than optimum conditions (low altitude, heavy breathing, loose-fitting mask, etc.), as few as 3 minutes of emergency oxygen may be available.

The emergency oxygen supply is activated automatically upon ejection. The emergency oxygen supply may be activated manually by pulling the emergency oxygen green ring on the outside of the left thigh. The emergency oxygen supply may be deactivated at aircrew discretion by pushing down on the release tab immediately forward of the green ring.

WARNING

With emergency oxygen selected, the OXY FLOW knob(s) shall be placed to OFF. If not secured, OBOGS system pressure may prevent emergency oxygen from reaching the breathing regulator. Additionally, the OBOGS control switch should be placed to OFF to backup the OXY FLOW knob.

2.19 AIR DATA COMPUTER (ADC)

The air data computer is a solid state digital computer which receives inputs from the angle-of-attack probes, total temperature probe, pitot static system, standby altimeter barometric setting, air refueling probe position, magnetic azimuth system, mission computer, and landing gear handle position. Accurate air data and magnetic heading are computed. Computed data is supplied to the mission computer system, altitude reporting function of the IFF, engine controls, environmental control system, landing gear warning, and the fuel pressurization and vent system.

2.19.1 Angle-Of-Attack Probes. The left and right angle of attack probes are the airstream direction sensing units. Case heaters are on whenever electric power is on the aircraft. Probe heaters are on when airborne. The approach and indexer lights operate from signals from the airstream detection sensing units. The AOA probe outputs go only to the ADC and each FCC. The outputs are electrically independent, not mechanically independent. The probes can be damaged in such a way that they freeze in position and continue to send signals to the ADC and FCCs. See HUD Symbology Degrades.

2.19.2 Total Temperature Probe. The total temperature probe is mounted on the lower left fuselage aft of the nosewheel. The probe heater is on when airborne. The air data computer uses total temperature to calculate ambient temperature.

2.20 STATUS MONITORING SUBSYSTEM

The status monitoring subsystem, figure 2-43, provides the pilot with simple displays of system status. Most information is derived from BIT mechanizations within the avionic sets and from nonavionic built-in tests (NABIT) implemented in the computer software for other aircraft subsystems.

The subsystem monitors engines and airframe operational status for unit failures and caution/advisory conditions when the mission computer system is operating. When the mission computer system detects a caution/advisory condition, it commands display of the applicable caution or advisory message on one of the cockpit DDIs. If the mission computer system detects a unit failure, it commands the subsystem to store the applicable maintenance code. Stored maintenance codes can be reviewed on the aircraft maintenance indicator in the nose wheelwell, on the DDI MAINT BIT display in F/A-18A/B aircraft, and on the IFEI in F/A-18C/D aircraft. The mission computer (MC) displays the subsystem BIT results on one of the cockpit DDIs.

Non-BIT equipment status include DDI configuration display ID numbers and INS terminal data.

2.20.1 Flight Incident Recorder and Aircraft Monitoring Set (FIRAMS) (F/A-18C/D). The FIRAMS consists of a signal data computer, a data storage set, an integrated fuel/engine indicator and a maintenance status panel. It functionally replaces the AN/ASM-612 Signal Data Recording Set (SDRS), the AN/ACU-12/A engine performance indicator, and the fuel quantity indicators and fuel intermediate device. The FIRAMS monitors selected engine, airframe, avionic, nonavionic, fuel gauging and consumable signals. It also performs conversions of sensed measurands, provides real time clock function, outputs discrete and analog data to associated equipment, communicates with the mission computer, displays maintenance and status codes, and displays fuel quantities and engine parameters, including fuel system health monitoring. FIRAMS also provides nonvolatile storage for flight incident, maintenance, tactical and fatigue data.

2.20.2 Deployable Flight Incident Recorder Set (DFIRS) (Aircraft 164627 AND UP). The DFIRS system consists of the Deployable Flight Incident Recorder Unit (DFIRU), the data transfer interface unit, and the pyrotechnic release system. The SDR consists of the flight incident recorder memory, beacon, battery, and antenna, all contained in a deployable aerodynamic airfoil located on the top on the fuselage between the rudders. DFIRS stores up to 30 minutes of flight incident data and deploys this data along with a rescue beacon, via the airfoil, when activated. The SDR is deployed upon pilot ejection or ground/water impact. The data stored on the flight incident recorder (FIR) is gathered by the mission computer from existing systems on the aircraft. DFIRS records flight data, cautions, advisories, and spin data. The FIR memory wraps around to the beginning when the end of memory is reached. Only the last 30 minutes of each flight is retained. The MC controls the rate and the type of data that is stored. DFIRS data recording starts when both throttles are advanced past 90° power lever angle (PLA), when ground speed exceeds 50 knots, or when W off W and airspeed is over 80 knots. DFIRS recording stops 1 minute after WOW, both throttles are less than 90° PLA, and the ground speed is less than 50 knots. All data during SPINs and MECH ON cautions are automatically recorded. A DFIRS DWNLD option is available on the engine display. Selecting this option downloads the DFIRS data to the MU for easier retrieval.

F/A-18A/B

STATUS CONTROLS AND READOUTS

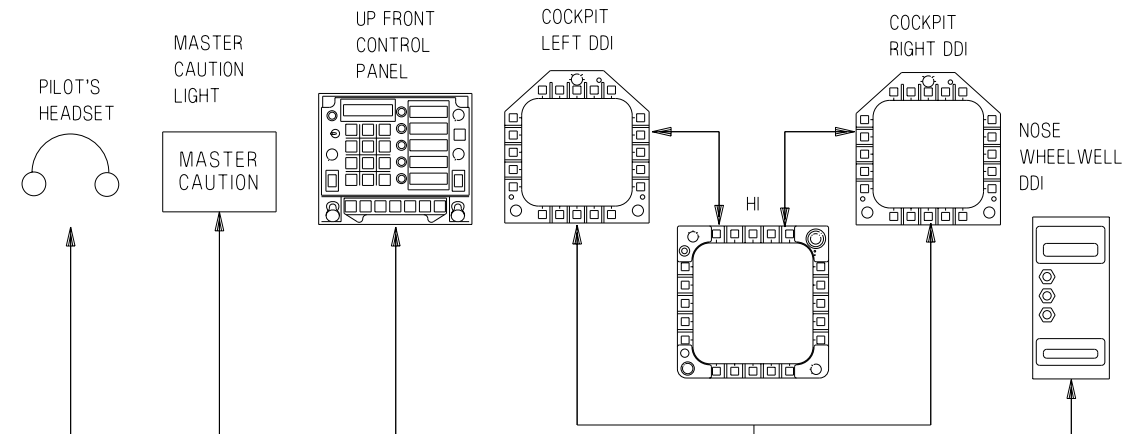

STATUS PROCESSING

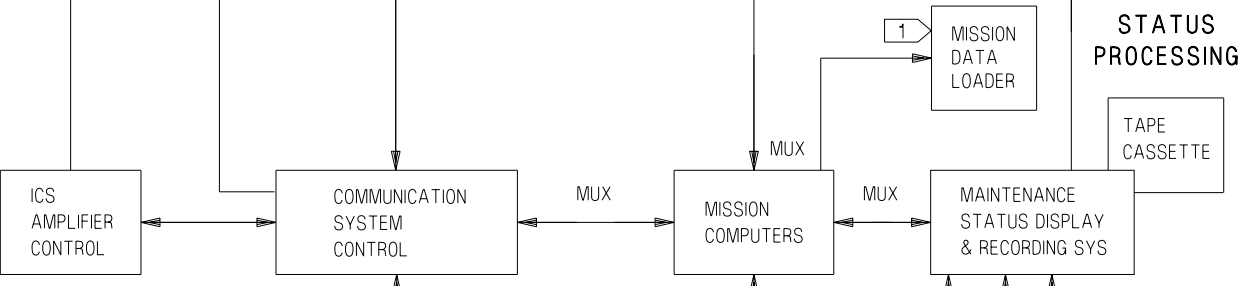

TESTED EQUIPMENTS

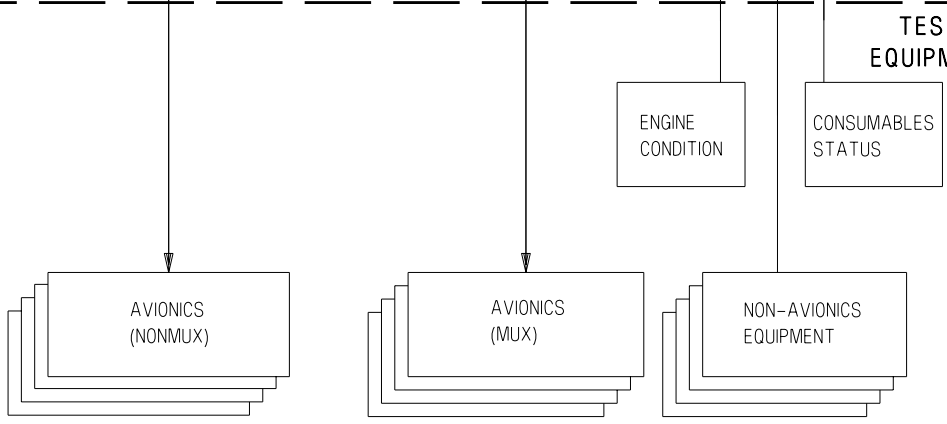

1 F/A-18A AFTER AFC 253 OR 292

Figure 2-43. Status Monitoring Subsystem (Sheet 1 of 2)

F/A-18C/D

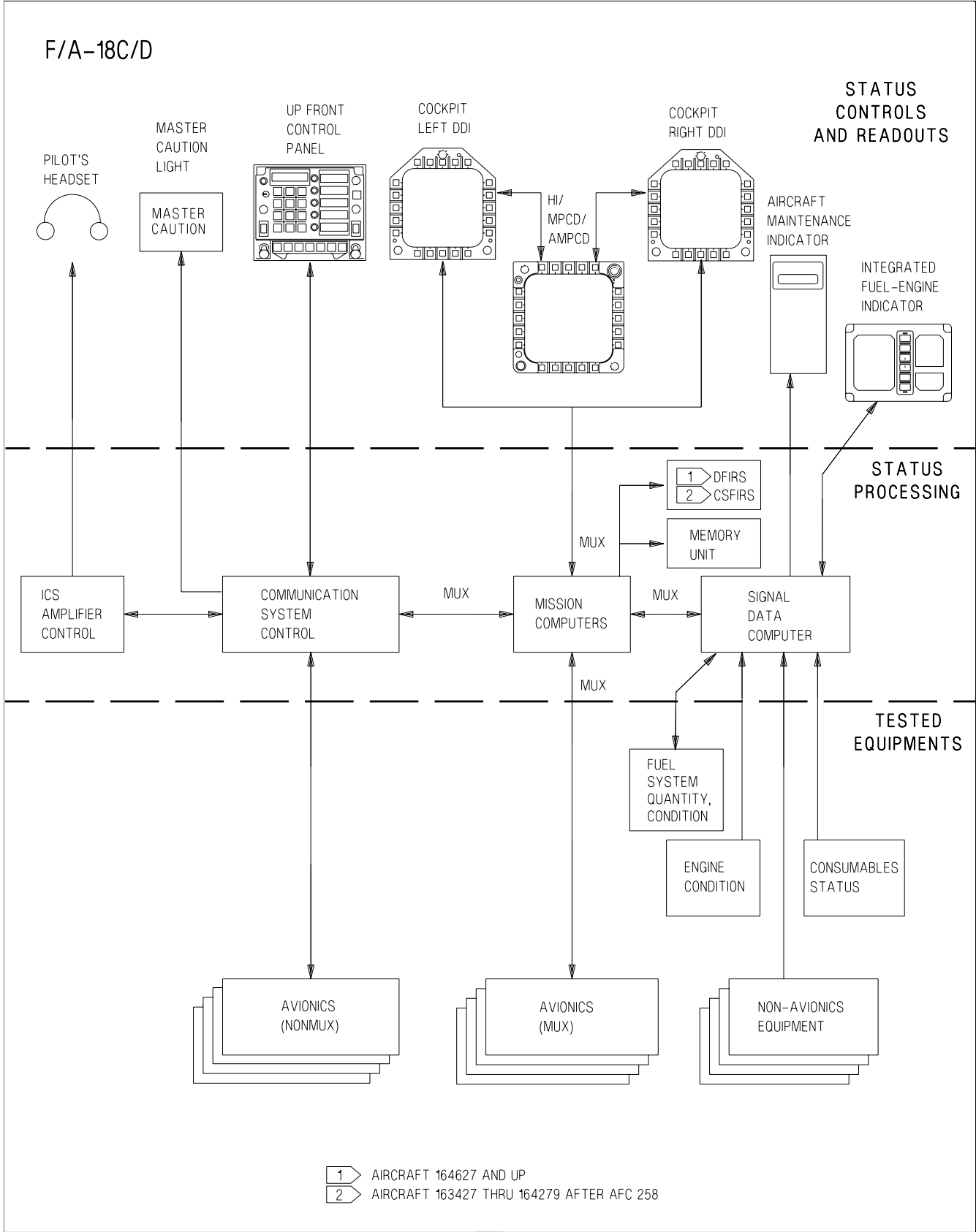

- 1 AIRCRAFT 164627 AND UP
- 2 AIRCRAFT 163427 THRU 164279 AFTER AFC 258

ADA520-29-2-051

Figure 2-43. Status Monitoring Subsystem (Sheet 2 of 2)

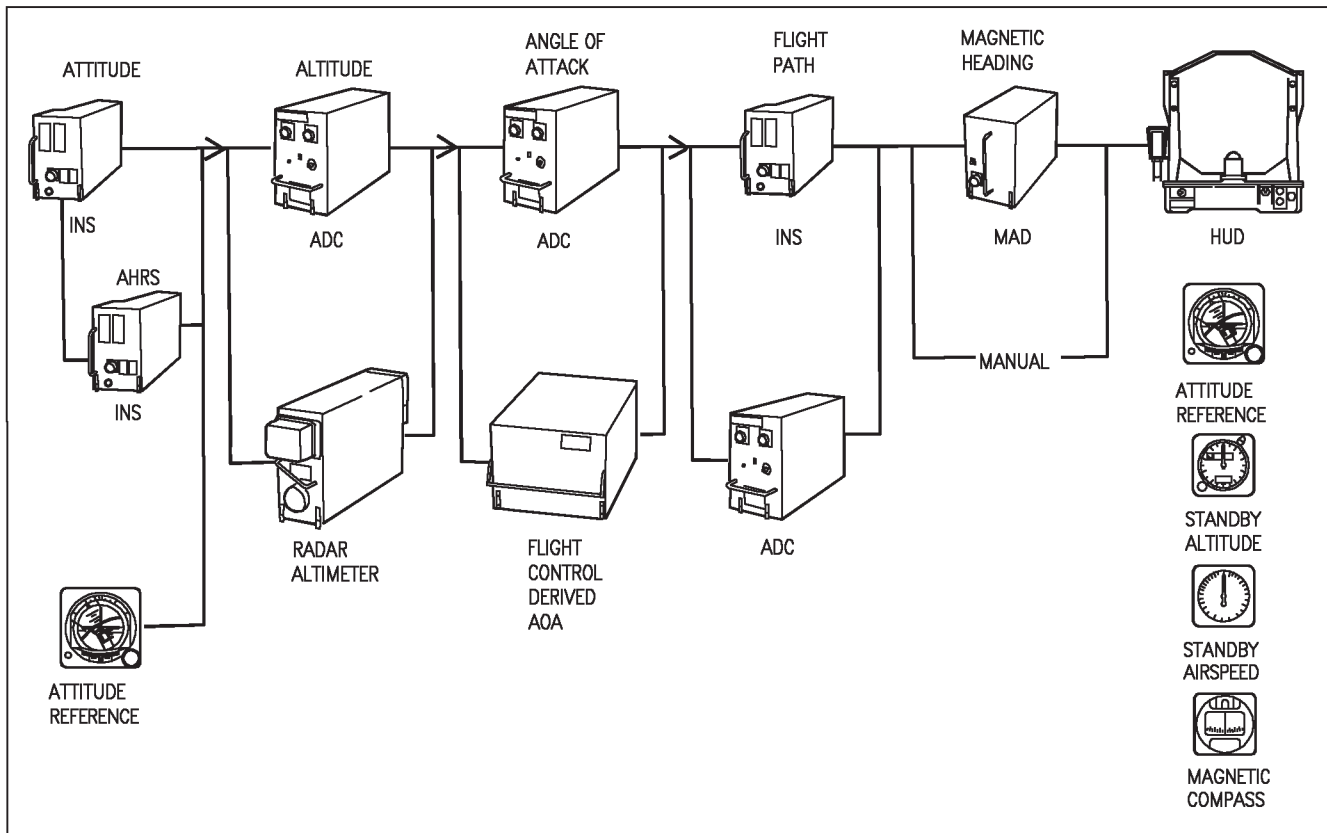

18AC-NFM-00-(30-1)31-SCAN

Figure 2-44. Flight Aids Reversion Mechanization

2.20.2.1 Crash Survivable Flight Incident Recorder System (CSFIRS) (Aircraft 163427 THRU 164279 AFTER AFC 258). The CSFIRS like the DFIRS is used to store data to aid in crash investigation. However, the CSFIRS is not deployable. The CSFIRS is attached to the aircraft and must be removed to retrieve crash data. CSFIRS is not installed in aircraft with DFIRS. The CSFIRS is located in the aft bay of the R LEX. The CSFIRS software emulates the DFIRS and records the same flight parameter data from the mission computer as the DFIRS. The CSFIRS can store up to 50 hours of flight data which can be retrieved by removing the CSFIRS and downloading to an MLVS. The CSFIRS also has the capability to download 30 minutes of flight data via the memory unit.

2.20.3 Avionic BIT. In most instances, two types of BIT are mechanized, periodic and initiated. Periodic BIT begins functioning upon equipment power application. It provides a failure detection capability that is somewhat less than that provided by initiated BIT in that it does not interfere with normal equipment operation.

Two forms of BIT derived data are supplied to the MC. One form is validity information associated with selected data. The second form is the equipment failure information which identifies failed assemblies. The MC uses these two forms of BIT data to implement reversion operation and advisories for the pilot as well as equipment status displays for both the pilot and maintenance personnel.

2.20.3.1 Reversion. When the BIT equipment determines that a function has exceeded a predetermined threshold, the data derived from that function is immediately indicated as not valid. The MC, upon receiving this indication, reverts to the next best available source which in many cases is as

accurate as the original source. This reversion is maintained as long as the data remains invalid from the primary source.

Figure 2-44 illustrates this concept for the flight aids. For each unit in the primary path, there is at least one alternate source of data for reversion. The pilot is provided appropriate display cuing only when a reversion results in some loss of capability or performance. For example, if angle of attack is lost from the ADC, the MC reverts to FCS derived angle of attack. No display change or pilot cuing is made since the accuracy of the alternate source is equivalent to the primary source. If, however, the altitude switch is in RDR and the radar altimeter fails, the MC removes the displayed radar altitude, replaces it with barometric altitude, and indicates the barometric altitude display via cuing. If altitude is lost from the ADC and the altitude switch is in the BARO, the MC removes the displayed altitude from the HUD. These examples illustrate three forms of degraded mode advisories: (1) reversion to an alternate data source of equivalent accuracy with no pilot cuing; (2) reversion to an alternate data source of lesser accuracy with pilot cuing; (3) and removal of displayed data when no acceptable alternate source is available. Refer to Part VIII for further discussion on weapon system reversions.

2.20.3.2 Equipment Status Displays. Equipment status displays (BIT, caution, and advisory) provide the pilot with continuous status of the avionics equipment and weapons. A cue to check equipment BIT status is the appearance of the BIT advisory display on either DDI or the HI/MPCD/AMPCD. The display is normally on the left DDI. A MENU selectable top level BIT format displays the status of failed, NOT RDY, or OFF systems of all avionics equipment which interface with the MC. When the BIT control display is selected on another display, the BIT advisory is removed until another BIT failure occurs.

Weapon and stores status is primarily displayed on the stores display (selected from the menu display). When the BIT display indicates a stores management system (SMS) failure, the affected stations and degree of failure are identified on the stores display as described in NTRP 3-22.4-FA18A-D and NTRP 3-22.2-FA18A-D NATIP. The BIT advisory and an SMS BIT status of DGD is the only enunciated indication of a stuck emergency jettison button.

Messages displayed as a function of equipment status are listed in the following table.

STATUS MESSAGE	APPLICABLE SYSTEM	MESSAGE DEFINITION
NOT RDY	All systems except MC1	Equipment OFF, not installed, or initializing.
IN TEST	All systems except MC1, MC2, and RWR	Initiated BIT in progress.
SF TEST	ALE-47, ATARS, AWW4, DMS, FLIR, GPS, LST, LTDR, MIDS, MP/CD/AMPCD, NFLR, RALT, RDR, SMS, and WPNS	Self test in progress (cannot be operator terminated).
GO	All systems	Initiated BIT completed without failure.
DEGD	All systems except MC1, MC2	Failure detected; equipment operation degraded.
1 NOGO 2 MUX FAIL	ADC, AISI, ALE-47, APX-111(V), ASPJ, ATARS, AWW4, CAM, CLC, COM1, COM2, CSC, DFIRS, D/L, DMS, FCSA, FCSB, FLIR, GPS, HARM, INS, LDDI, LDT, LST, LTDR, MC2, MIDS, MU, NFLR, RDR, RDDI, SDRS, SMS, SDC, and WPNS	Equipment ON but not communicating.
1 OH 2 OVRHT	ASPJ, ATARS, CAM, CSC, DFIRS, FCSA, FCSB, FLIR, INS, LDT, LST, LTDR, MIDS, NFLR, RDR, RWR, SMS, SDRS,	Overheat.
1 DEGD OH 2 DEGD+OVRHT	ASPJ, ATARS, CAM, CSC, DFIRS, FCSA, FCSB, FLIR, INS, LST, LDT, LTDR, MIDS, NFLR, RDR, RWR, and SMS	Detected failure and overheat.
RESTRT	All systems except MC1, MC2, and RWR	Reinitialize BIT; equipment did not respond to BIT command, remained in BIT too long and was terminated by MC.
1 OPRNL GO 2 OP GO	ALE-47, ATARS, DFIRS, GPS, MDL, MIDS, MU, NFLR, SMS, and WPNS,	SMS failure detected which does not affect capability to deliver currently loaded weapons.
2 PBIT GO	All systems except MC1, MC2, and RWR	IBIT has not been initiated and the system periodic BIT is not reporting any failures.
2 OFF	ATARS, BCN, CAM, COM 1, COM 2, D/L, IFF, ILS, MIDS, RALT, RDR, and TCN	System not communicating with AVMUX. OFF status indication.
1 MC OFP 10A AND UP 2 MC OFP 13C AND UP		
No indication (blank) adjacent to the equipment legend indicates that initiated BIT has not been run on the equipment and that the periodic BIT has not detected any faults. LDDI, RDDI, HI/MP/CD/AMPCD, and IFEI have unique degraded messages of DEGD 1, DEGD 2 and DEGD 1/2 in the F/A-18B/D to allow distinguishing BIT status failures of front seat displays (1) from rear seat displays (2).		

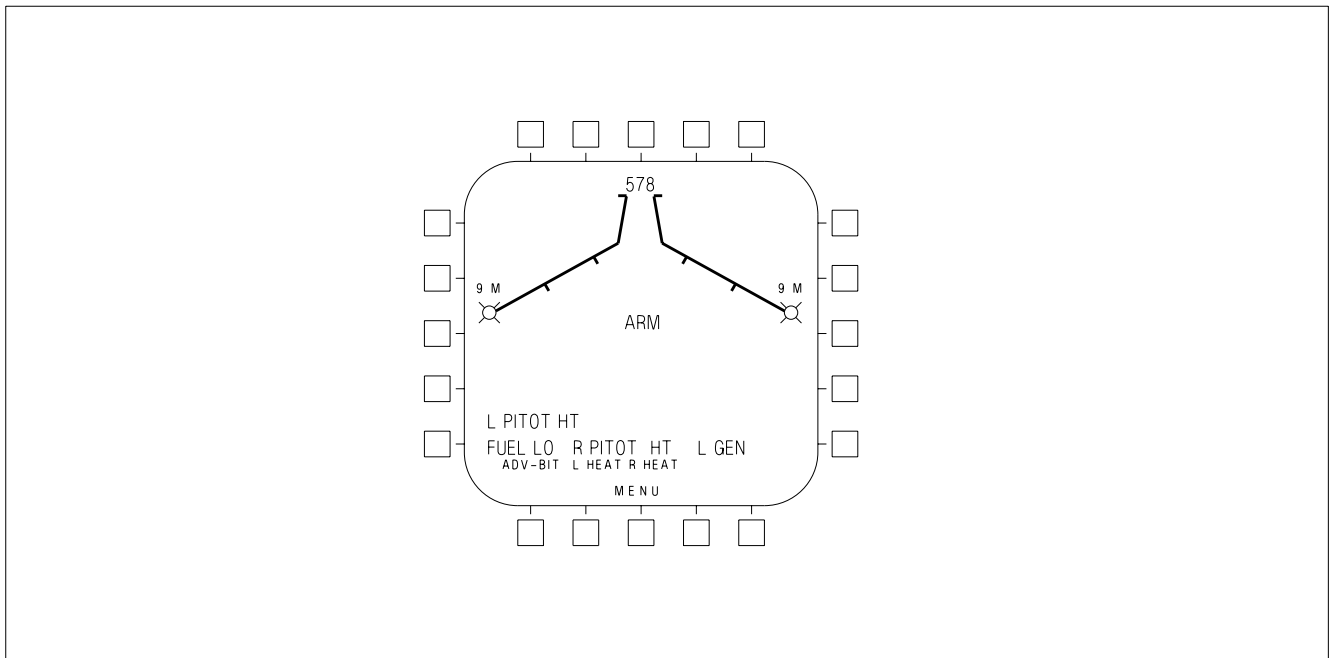

ADA520-32-1-045

Figure 2-45. Caution/Advisory Indications

2.20.3.2.1 Caution/Advisory Indications. Cautions and advisories are displayed on the left DDI except when the left DDI is used for BIT display or weapon video (figure 2-45). When the left DDI is off or failed, or when the LDDI is used for BIT or weapon video, cautions and advisories are displayed on the center display. If the left and center displays fail or are turned off, the right DDI displays the cautions and advisories. With MC OFP 13C AND UP, cautions and advisories automatically move to the center display when BIT is selected on the LDDI. Caution displays appear as 150 % -size letters compared to the normal message symbology size.

The caution displays are displayed as they occur beginning in the lower left portion of the DDI display and sequence to the right up to three displays across. Upon occurrence of the fourth caution, it re-indexes to the left edge above the first caution which appeared. With MC OFP 10A AND UP, this process can continue for up to seven lines with three caution displays in each line. If that many cautions occur, additional cautions may not be displayed until an open space is available on the right side of the top line. The oldest non-priority caution(s) is removed and the remaining cautions are moved left and down to display priority cautions such as: AIL ON, CAUT DEGD, DEL ON, FLAPS OFF, FLAPS SCHED, INS ATT, L(R)AMAD, L(R)AMAD PR, MECH ON or RUD OFF caution(s). If all 21 displayed cautions are priority cautions, no further cautions can be displayed without a priority caution being first removed. With MC OFP 13C AND UP, a dedicated caution display automatically replaces the HSI display if the number of cautions exceed three lines. The cautions are in the lower portion of the display with an aircraft symbol as a point of reference for the underlying map.

Advisory displays appear as 120 % -size letters on a single line beneath the caution displays. The advisories are preceded by an ADV legend and the individual advisories are separated by commas. A caution or advisory is removed when the condition ceases. If there is a caution or advisory displayed to the right of the removed caution or advisory, the display remains blank. Pressing the MASTER CAUTION light when the light is out repositions the remaining cautions and advisories to the left and down to fill the blank displays. When a caution occurs, the MASTER CAUTION light on the main instrument panel illuminates and the MASTER CAUTION tone or a voice alert is heard in the

headset. The MASTER CAUTION light is extinguished by pressing the light. Refer to Warning/Caution/Advisory Displays in chapter 12 for the display implications and corrective action procedures.

2.20.3.3 BIT Initiation (F/A-18A/B BEFORE AFC 253 OR 292). In addition to displaying equipment BIT status, the BIT control display (figure 2-46) is used to command initiated BIT. Those avionic sets identified by the legends on the display periphery have an initiated BIT capability. The pilot commands initiated BIT by pressing the adjacent button. The status messages are displayed as required as each equipment set enters, performs, and completes its BIT routine. BIT may be initiated one at a time or in any combination. In the case of the INS and FCS, additional switchology is required. Selection of AUTO BIT causes a simultaneous BIT of all equipment except those tested by the DSPL/EPI (IFEI)/UFC button. Performance of BIT assumes the required electrical and hydraulic power is applied to the equipment tested. Some systems require additional pilot BIT input.

2.20.3.4 BIT Initiation (F/A-18A AFTER AFC 253 OR 292 AND F/A-18C/D). In addition to displaying equipment BIT status, the BIT top level and eight sublevel displays (figure 2-46) are used to command initiated BIT. Those avionic set groups identified by the legends on the top level display periphery have an initiated BIT capability. BIT may be initiated for all operating units simultaneously except for some BITs that cannot be performed inflight. Figure 2-46 shows which initiated BITs are not allowed inflight. Additional steps are required to test the INS and FCS. BIT for individual units within groups may be initiated through the BIT sublevel displays.

Pressing BIT returns to the BIT top level display. Pressing STOP or MENU when BIT is in progress terminates initiated BIT. Performance of BIT assumes required electrical and hydraulic power is applied to the equipment tested.

TOP LEVEL FORMATS

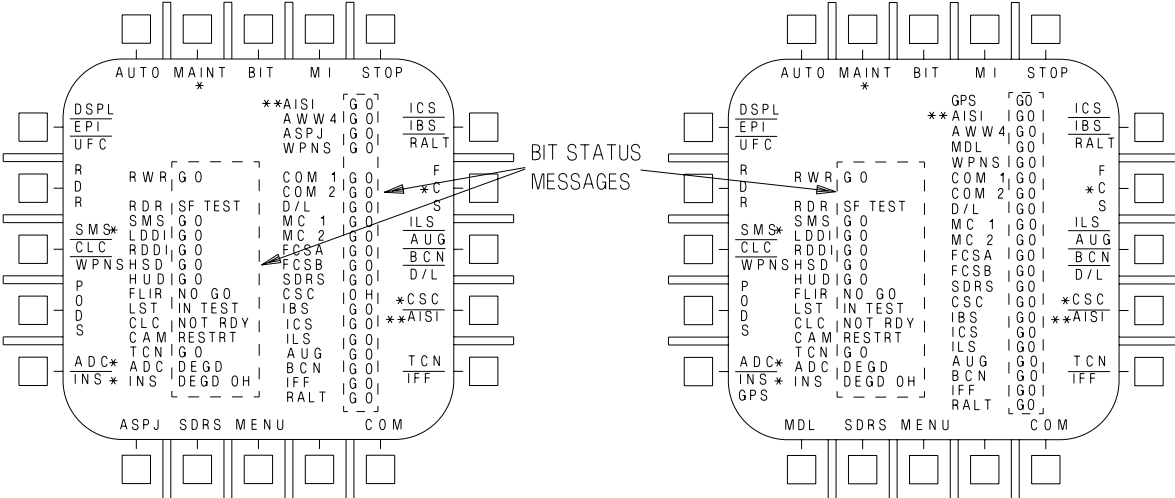

F/A-18A/B
BEFORE AFC 253 OR 292
WITH MC OFF 10A

F/A-18A/B
BEFORE AFC 253 OR 292
WITH MC OFF 12A

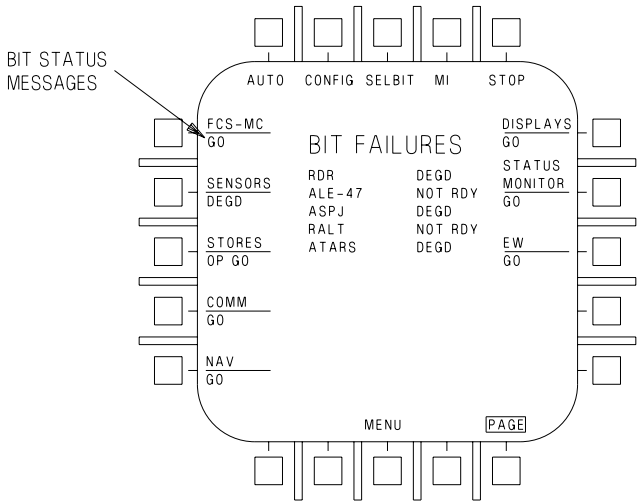

F/A-18 A AFTER AFC
253 OR 292
AND
F/A-18 C/D

NOTES

- * Initiated BIT is not allowed inflight (legends are only displayed on the ground).
- ** Removed if not installed (not communicating with MC).

Figure 2-46. BIT Control Display (Sheet 1 of 3)

SUB LEVEL FORMAT
F/A-18A AFTER AFC 253 OR 292 AND
F/A-18 C/D

FCS-MC, SENSORS, STORES, COMM BIT FORMAT

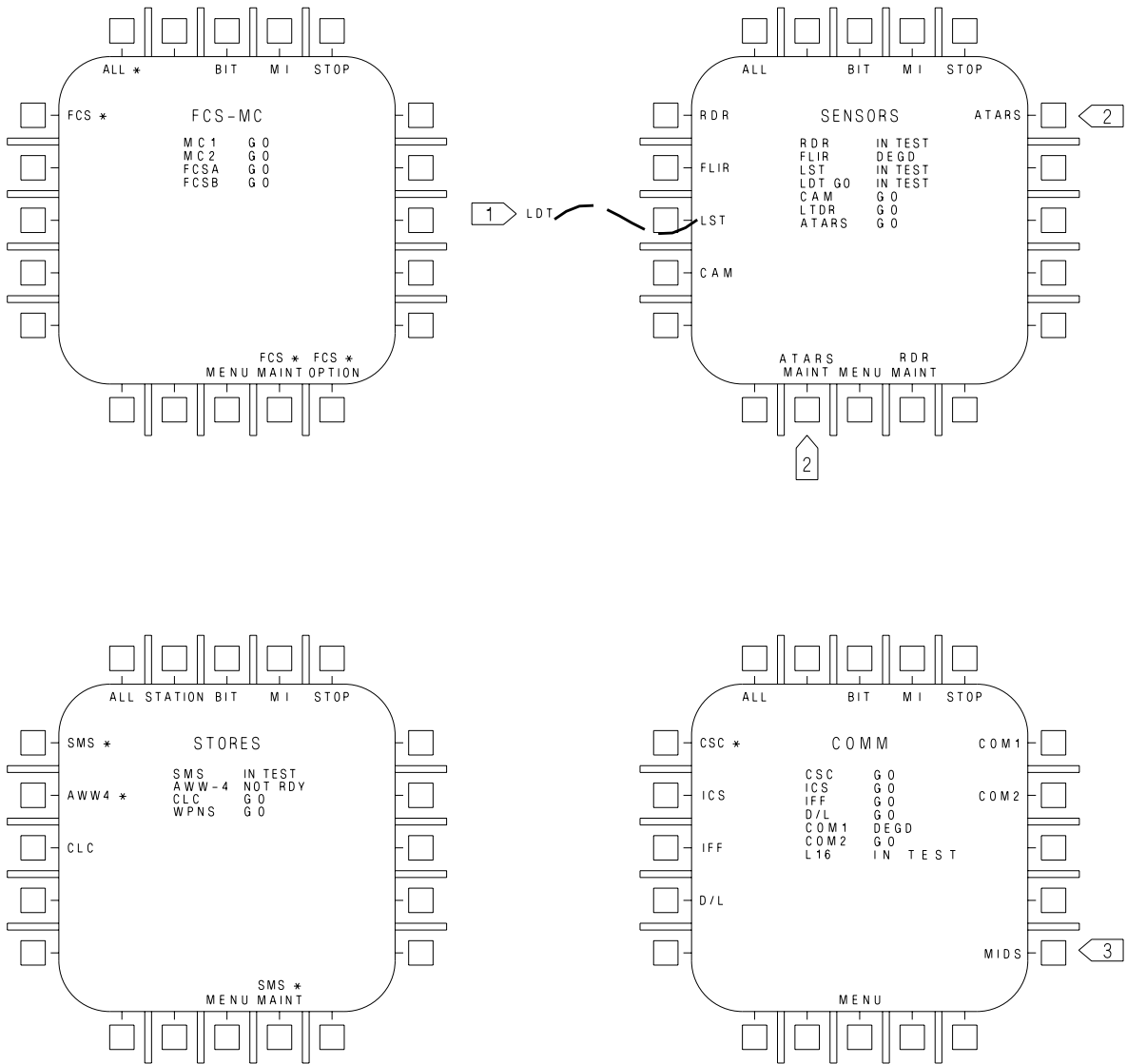

NOTE

* W on W only (not available INFLIGHT)

- 1 MC OFP 13C AND UP
- 2 164649 AND UP AFTER AFC 244
- 3 163427 AND UP AFTER AFC 270

Figure 2-46. BIT Control Display (Sheet 2 of 3)

2.20.3.4.1 All Equipment. Simultaneous initiated BIT of all equipment installed is performed by selecting AUTO on the BIT top level display. Equipment group, acronym and status are displayed at the display pushbuttons. Equipment group status indicates the lowest operating status reported by any unit in the tested group. Individual system status results other than GO, PBIT GO, IN TEST, SF TEST, and OP GO are displayed with a system acronym in the center of the display. If the equipment list is too long to be displayed on one page, a PAGE pushbutton is displayed. Pressing PAGE displays the remainder of the list that is on page 2. Pressing PAGE when page 2 is displayed returns page 1.

2.20.3.4.2 Equipment Groups. Initiated BIT of entire equipment groups is performed by selecting SELBIT (SELBIT option becomes boxed) on the BIT top level display and the desired equipment group pushbutton. One or more groups can be selected. Another way to select a group is to press the group pushbutton (with the SELBIT option not boxed) on the BIT top level display and then ALL on the group sublevel display. See figure 2-46.

2.20.3.4.3 Individual Units. Initiated BIT of an individual unit is performed by pressing the equipment group pushbutton on the BIT top level display which contains the desired unit. The display changes to a group sublevel display. Individual units from the group can then be tested by pressing the pushbutton adjacent to the desired acronym. System status for all systems in the group is displayed on the center of the display. Some systems require additional pilot BIT input.

2.20.3.5 System BIT Steps. The following includes certain initiated BIT which require steps in addition to pressing one of the buttons on the BIT display and reading the BIT status messages after the test is complete. Figure 2-47 shows which initiated BITs are not allowed inflight.

2.20.3.5.1 FCS Initiated BIT. For the FCS, the FCS BIT consent switch, on the right essential circuit breaker panel, must be held ON when initiated BIT is started. This prevents inadvertent initiation of BIT on the FCS for reasons of flight safety.

WARNING

Control surfaces move during initiated BIT with hydraulic power applied. To prevent personnel injury or equipment damage, be sure personnel and equipment are kept clear of control surfaces.

NOTE

- For initiated BIT to start, FCS BIT consent switch must be held for at least 2 seconds. If not held for the required time, RESTRT is displayed as the BIT display status message. If RESTRT displayed, repeat procedure.
- Initiated FCS BIT cannot be performed if nosewheel steering is engaged.
- For valid BIT reporting, do not operate switches or controls unless indicated. Do not rest feet on rudder pedals or hands on control stick.

1. If wings folded, check both ailerons Xd out.

With MC OFF 10A AND UP -

2. Select MENU/BIT on right DDI.
3. While simultaneously holding FCS BIT consent switch to ON, select the FCS pushbutton on the BIT display.

With MC OFF 13C AND UP -

2. Select SUPT MENU/BIT/FCS-MC on right DDI.
3. While simultaneously holding FCS BIT consent switch to ON, select the FCS pushbutton on the FCS-MC sublevel display.

All aircraft -

4. Release FCS button and FCS BIT consent switch when FCSA and FCSB BIT display status messages indicate IN TEST. At successful completion of initiated BIT, FCSA and FCSB BIT display status messages read GO. FCS initiated BIT requires less than 2 minutes.

2.20.3.5.2 Preflight FCS initiated BIT. The F/A-18 fly-by-wire flight control system uses redundant hardware to provide continued safe operation after component failures. The level of redundancy designed into the system was set by component failure rates, failure mode effects, aircraft mission time, and survivability considerations. The ability to provide safe operation is fundamentally based on the principle that there are no undetected (i.e. latent) failures prior to flight which would compromise system redundancy. It is not possible to have an in-flight Periodic BIT (PBIT) which can detect all degradations in a fly-by-wire system. Many redundant pathways can only be tested by setting system conditions that would be unsafe to establish in flight (e.g. verification of the ability to shut off an actuator). Preflight FCS initiated BIT was designed to provide those tests and thereby ensure the full redundancy of the flight control system is really available prior to flight. Without running Preflight FCS initiated BIT and performing the necessary maintenance, latent failures present in the system can result in unsafe conditions should additional failures occur in flight.

2.20.3.5.3 Preflight FCS initiated BIT Operation. Preflight initiated BIT consists of a series of tests which verify the integrity of the flight control system processors, actuators, sensors, and cockpit interfaces. Preflight FCS initiated BIT begins by testing lower level functions first. If preflight FCS initiated BIT detects a fault at this level which affects higher level functions, it halts and reports the fault(s). If preflight FCS initiated BIT did not halt at this point, false BIT Logic INspect (BLIN) codes would be generated on higher level functions which depend upon the failed lower level function for their operation. If preflight FCS initiated BIT detects a fault in a subsystem (e.g. left stabilator), testing of the failed subsystem is discontinued, and testing of unrelated subsystems (e.g., rudders, trailing edge flaps, etc.) continues.

WARNING

Since testing is not complete, preflight FCS initiated BIT must be run again after maintenance actions to complete all tests.

WARNING

Flight with a BLIN code could result in a flight control system failure and aircraft loss. Pressing the FCS reset button simultaneously with the paddle switch does not correct BIT detected flight control system failures, it simply clears the BLIN code from the display. IBIT must be re-run after clearing BLIN codes to ensure the detected failures no longer exist. If BLIN codes remain following IBIT, the aircraft requires maintenance to identify and correct failures in the flight control system.

2.20.3.5.4 Preflight FCS initiated BIT PASS/FAIL. A successful Preflight FCS initiated BIT results in a GO indication on the DDI. An unsuccessful Preflight initiated BIT indicates a system degradation. There may not be an X on the DDI FCS status page (MENU-FCS) since the degradation may be in a backup path which is not active until after a primary system failure. Launching in a degraded state (i.e., with BLIN codes) places the aircraft in a situation where a portion of the flight control system is operating without the normal redundancy.

2.20.3.5.5 Repetition of Preflight FCS initiated BIT. If an aircraft fails preflight FCS initiated BIT (i.e. BLIN codes present after preflight FCS initiated BIT) maintenance should be called to troubleshoot the system. After completing troubleshooting, a successful preflight FCS initiated BIT is necessary to ensure the system is fully operational. Except for cold weather operation, preflight FCS initiated BIT failure is indicative of a component degradation, i.e. hydraulic or electrical components are out of tolerance, or a cable conductor is intermittent (broken wire, loose connector pin, etc.)

2.20.3.5.6 Cold Weather and FCS Exerciser Mode. In cold weather, actuator components will not respond normally until hydraulic fluid temperature increases. Exerciser mode should be used to expedite monitors and system warm-up. During exerciser mode, a number of PBIT actuator monitors are ignored to prevent generation of nuisance BLIN codes. Thus in cold weather it is appropriate to re-attempt preflight BIT after running exerciser mode. Exerciser mode should not be used as a method to clear BLIN codes in normal start-up temperature conditions. BLINS cleared in this manner could be associated with hydraulic contamination or sticking control valves which could appear again in flight with catastrophic results.

CAUTION

Running exerciser mode in normal and hot weather environments may lead to hydraulic system overheat.

2.20.3.5.7 Running Preflight FCS Initiated BIT After Flight. A good (no codes) preflight BIT on the previous flight is no assurance against latent failures on the next flight. Electronic components have a propensity to fail on power application. Damage can occur during deck handling or maintenance activity not even associated with the flight controls. The only insurance is to run preflight BIT prior to flight.

2.20.3.6 SMS Initiated BIT. Safeguards have been built into the weapon system mechanization to allow SMS initiated BIT to be performed on the ground with weapons loaded and cartridges installed. During initiated BIT, weapon release signals and associated circuitry are not exercised unless all of the following interlocks are satisfied simultaneously: master arm switch to ARM, armament safety override in override, weapon load codes on stores processor set to zero, and no weapon ID detected on any weapon station. SMS initiated BIT should not be attempted until the above interlocks are in a safe condition. The SMS initiated BIT should be successfully completed within 180 seconds of initiation.

2.20.3.7 INS Initiated BIT. To perform initiated BIT in ASN-130 and 139 equipped aircraft, the INS must be in the TEST mode and a ground/carrier selection must be made to indicate where the BIT is being accomplished. When the ADC/INS (or AUTO) button (MC OFP 10A AND UP) or when the BIT/SELBIT/NAV/ALL, BIT/NAV/INS, or BIT/AUTO (with MC OFP 13C AND UP) is actuated, a status message of GND/CV? appears next to the INS legend in the status display area (figure 2-47). At the same time, GND and CV button labels appear along the bottom of the display. These options allow the operator to enter where the initiated BIT is to be performed, i.e., on the ground or on a carrier.

The INS BIT test is done by completing the steps below.

1. Check parking brake set.
2. For ground initiated BIT ensure waypoint zero is local latitude/longitude.

With MC OFP 10A AND UP -

3. Select MENU/BIT/ADC/INS (or AUTO) on right DDI and TEST on INS mode switch.

With MC OFP 13C AND UP -

3. Select MENU/BIT/SELBIT/NAV or MENU/BIT/NAV/INS or MENU/BIT/AUTO or MENU/BIT/NAV/ALL on the right DDI and TEST on the INS mode switch.

ASN-130 and 139 equipped aircraft -

4. Select INS LONG (if required) and GND or CV on DDI, and start clock. At successful completion of test BIT display status message reads GO. Maximum time for INS initiated BIT is 12 minutes and maximum time for INS initiated BIT and platform slew test is 45 minutes.

To perform BIT in EGI equipped aircraft, an INS/GPS pushbutton is provided on the NAV BIT display. Selecting the INS/GPS option provides BIT options for the EGI. A CV or GND INS/GPS BIT commands the EGI to perform a short BIT on both the INS and GPS. A short EGI BIT tests system functionality. A long CV or GND INS/GPS BIT commands the EGI to perform a short BIT on the GPS and a long BIT on the INS. The long BIT tests INS performance in addition to system functionality. A long EGI BIT requires approximately 4 minutes to complete.

2.20.3.8 AUTO BIT. If the AUTO button is pressed, BIT are initiated in parallel for all equipment turned ON and whose interlocks are satisfied. The test pattern associated with the DDI and HUD is not displayed when the AUTO option is used. Approximately 2.5 minutes are required for all AUTO BIT except FCS and INS.

On aircraft 161353 THRU 161528, an anomaly exists which causes a COM 1 failure indication any time an AUTO BIT is run. No maintenance code is set in the nose wheel well DDI. Judgement should be exercised in determining when there is an actual failure, with consideration given to irregularities such as communication difficulties during flight.

1. Check power applied to all systems requiring BIT and check required interlocks in safe condition.
2. Select MENU/BIT/AUTO on DDI.
 - a. All systems read GO (see figure 2-47) after required test period. Go indication is provided when system check is complete and OK. Other messages may be displayed if malfunctions are detected.

3. If FCS test required, perform FCS Initiated BIT above while substituting the AUTO button for the FCS button in the procedure.

Ensure the procedural warnings and notes are observed and that the AUTO button and FCS BIT consent switch are held simultaneously to initiate test.

4. If INS test required, perform INS initiated BIT above while substituting the AUTO button for the ADC/INS button in the INS Initiated BIT procedure.

2.20.3.9 Cockpit Displays Initiated BIT (MC OFF 10A AND UP). Operator participation in the detection of failures and the isolation of faults is required for the display equipment. The DSPL/EPI(IFEI)/UFC button calls up the MC generated test pattern on the DDI, HI/MPCD/AMPCD and HUD immediately after the BIT routine mechanized within each indicator is concluded. The test pattern can then be compared on the four displays for similarity, and individually for concentricity, intensity level, and alphanumeric clarity. Pushbutton tests are accomplished by actuating the button. A circle appears adjacent to the button when the functional test is successfully completed. In addition to displaying the DDI, HI/MPCD/AMPCD and HUD BIT test patterns, pressing the DSPL/EPI (IFEI)/UFC button initiates engine monitor indicator (EMI) and upfront control BIT checks. See figure 2-48.

Pressing the DSPL/EPI (IFEI)/UFC initiates BIT on three different equipment display groups. The following procedure can be used to test all groups simultaneously, or to test one or two of the display groups by performing the appropriate parts of the procedure. Regardless of whether the whole or a part of the procedure is required, the total time allowed for the test should be a minimum of 25 seconds. The EPI (IFEI) BIT display must be allowed to complete the described cycle before the BIT stop button is pressed. The reason for this is that when the DSPL/EPI (IFEI)/UFC BIT is initiated and the STOP button is pressed before the EPI (IFEI) BIT runs through to completion, the second half of the UFC BIT will be altered during the next test. If an alteration of the second half of the UFC BIT occurs, the problem might be cleared by running another EPI (IFEI) BIT to completion. The UFC would then test good during the next BIT check. The HI must be turned off during the UFC check or disruption of the UFC BIT results. On 161925 AND UP, running the BIT a minimum of 25 seconds and turning the HI off are not required.

1. Turn HI power off.
2. Select MENU/BIT/DSPL/EPI/(IFEI)/UFC on DDI (see figure 2-48).
3. Upfront control - CHECK
 - a. All outer segments of alphanumeric displays, all segments of numeric displays, and all option cues illuminate for 5 seconds.
 - b. All inner segments of alphanumeric displays, all segments of the numeric displays, and all option cues illuminate for the next 5 seconds.
4. Engine monitor indicator - CHECK
 - a. RPM - 50 %
 - b. EGT - 555°C
 - c. FF - 5200 PPH

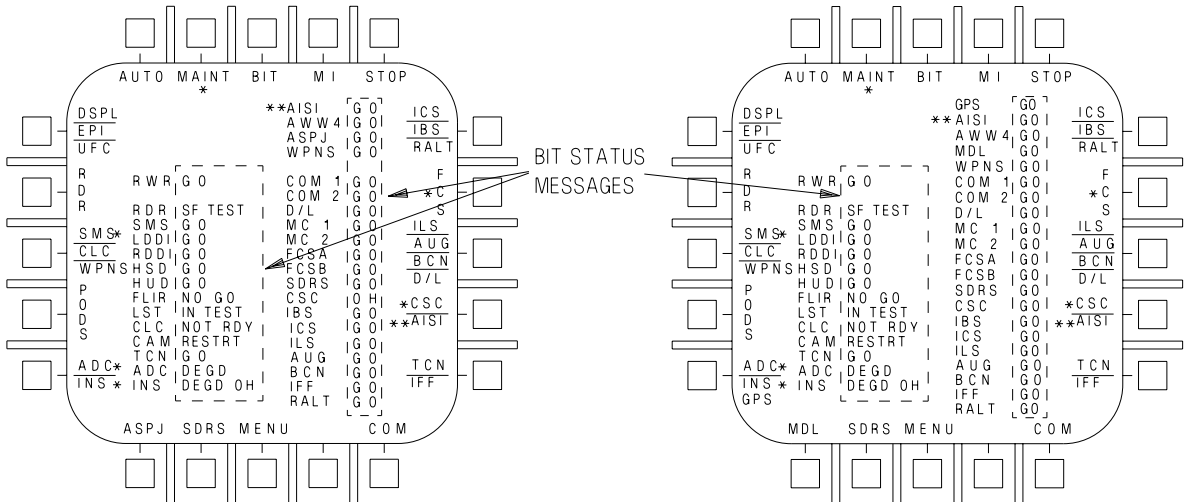

F/A-18A/B
BEFORE AFC 253 OR 292
WITH MC OFF 10A

F/A-18A/B
BEFORE AFC 253 OR 292
WITH MC OFF 12A

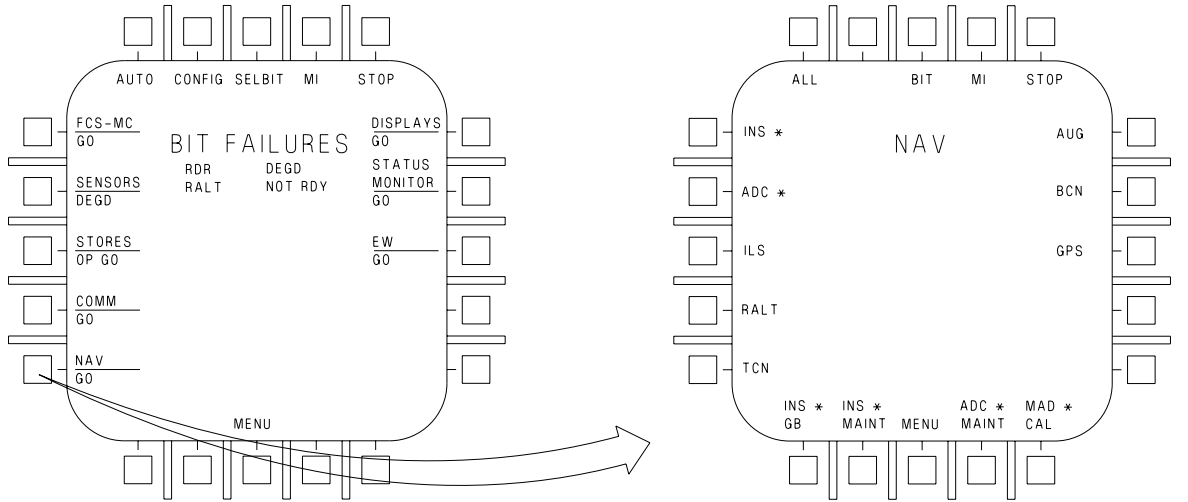

F/A-18 A AFTER AFC 253 OR 292 AND
F/A-18 C/D

* W on W only (not available INFLIGHT)

Figure 2-47. ADC/INS/GPS BIT - AUTO BIT Display

HUD, HI, AND DDI BIT DISPLAY

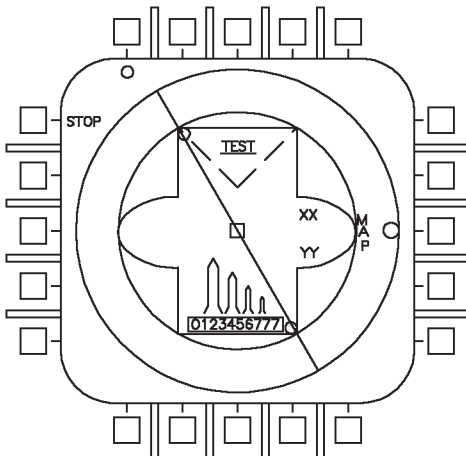

- A circle is displayed adjacent to the button only after individual button is actuated and it passed functional test.
- The diagonal line, 2 circles in the corners, film strip XX (map number), YY (select map number), and MAP button label only appear on the horizontal indicator.
- Stop button enables termination of CRT BIT.

HUD, HSI AND DDI BIT DISPLAY
AIRCRAFT 163985 AND UP

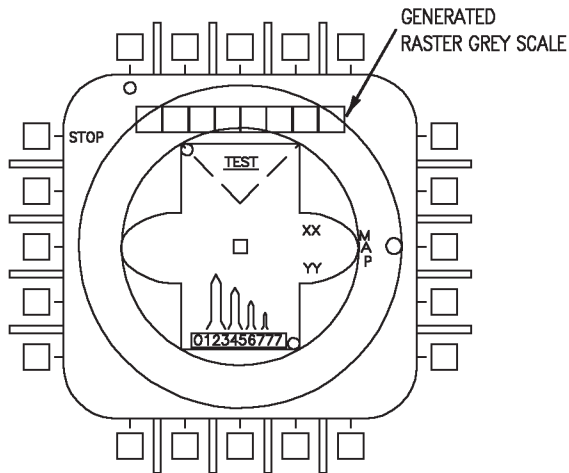

UPFRONT CONTROL BIT DISPLAY

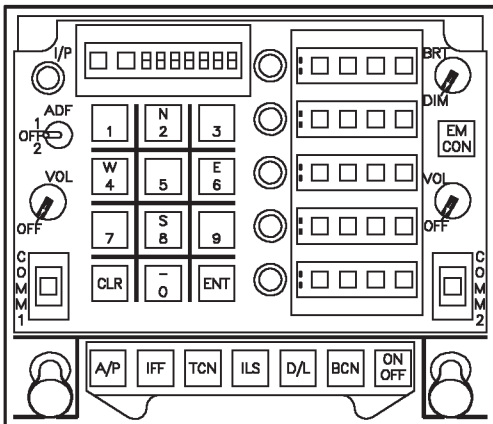

FIRST 5-SECOND PERIOD

All outer segments of alphanumeric displays, all segments of numeric displays, and all option cues illuminate.

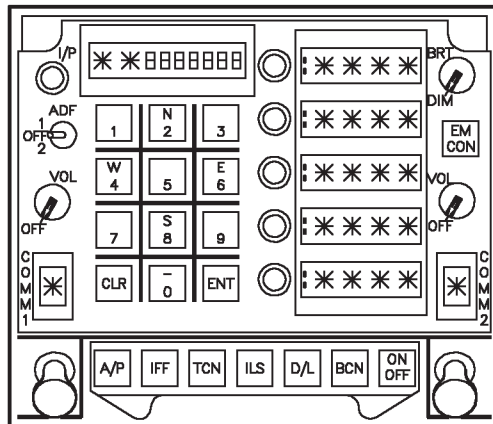

SECOND 5-SECOND PERIOD

All inner segments of alphanumeric displays, all segments of numeric displays, and all option cues illuminate.

Figure 2-48. DSPL/EPI (IFEI)/UFC BIT Displays (Sheet 1 of 2)

F/A-18A/B
ENGINE MONITOR
INDICATOR BIT DISPLAY

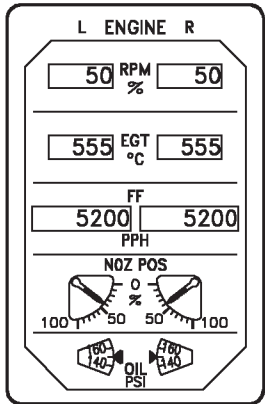

F/A-18C/D
IFEI BUTTON TEST DISPLAY

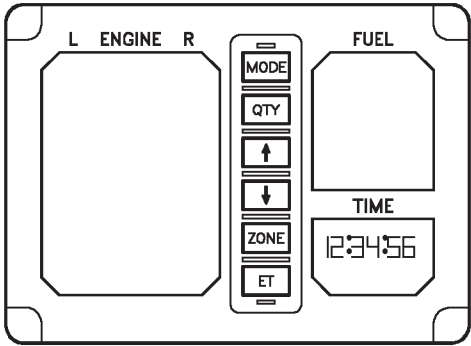

- Illustrated indications appear for 8 seconds.
- After 8 seconds, digits cycle from 0 to 9; most significant digit for RPM and FF only indicate 1 during this test.

IFEI ALL SEGMENTS DISPLAY

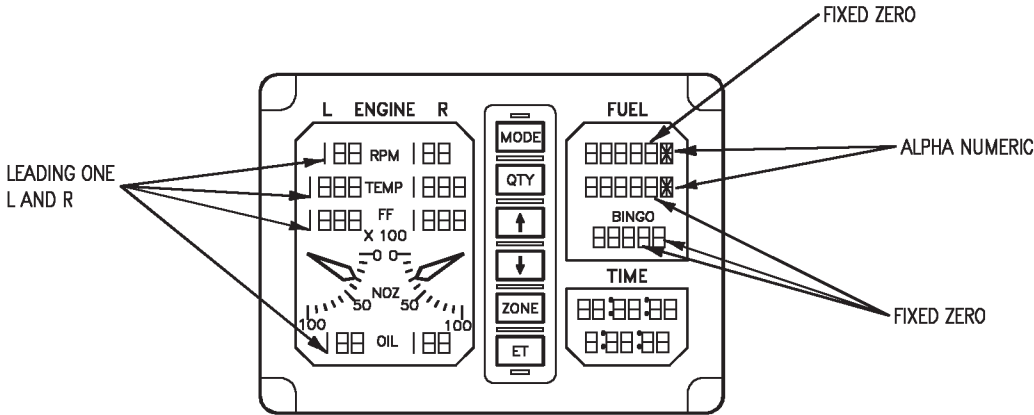

Figure 2-48. DSPL/EPI (IFEI)/UFC BIT Displays (Sheet 2 of 2)

- d. NOZ POS - 40 %
 - e. OIL - 150 PSI
5. Turn HI/MPCD/AMPCD power on.
 6. Select MENU/BIT/DSPL/EPI/(IFEI)/UFC on DDI.
 - a. DDI, HI/MPCD/AMPCD and HUD displays go blank momentarily, flash STANDBY and then display a test pattern.
 - b. DDIs have test pattern that is steady and in focus.
 - c. HUD and HSI test pattern displays flicker every 2 seconds but remain on.
 7. HUD, HI/MPCD/AMPCD, and DDI displays - CHECK
 - a. Display commonality.
 - b. Display concentricity.
 - c. Proper intensity.
 - d. Check right DDI pushbuttons starting with top left button on horizontal row. Circle appears next to pushbutton after it is pressed.
 - e. On aircraft 161353 THRU 163782 press MAP pushbutton on the HI. Test circle displayed next to MAP pushbutton and moving map filmstrip number displayed.
 - f. On aircraft 161353 THRU 163782 press MAP pushbutton to increment selected map number to same value as film strip number. Continual pressing of MAP pushbutton increments selected map number through range of three values, 01, 02, 03, and back to 01.
 - g. Check HI/MPCD/AMPCD pushbuttons as in 7.d. above.
 - h. Check left DDI pushbuttons as in 7.d. above pressing STOP button last. When STOP button is pressed, GO BIT display status messages on left DDI for LDDI, RDDI, HI/MPCD/AMPCD and HUD.

2.20.3.10 Cockpit Displays Initiated BIT (MC OFF 13C AND UP)

2.20.3.10.1 DDI/HI/MPCD/AMPCD/HUD Initiated BIT. Operator participation is required to detect failures and isolate faults in the display equipment. The BIT/DISPLAYS/DDI-MPCD-HUD pushbutton calls up the MC generated test patterns on the DDI, HI/MPCD/AMPCD and HUD immediately after each indicator BIT is concluded. The test pattern can then be compared on the four displays for similarity, and individually for concentricity, intensity level, and alphanumeric clarity. Pushbuttons are tested by actuating all the buttons. A circle appears adjacent to the button when the functional test is successfully completed.

Pressing DDI-MPCD-HUD initiates BIT on three different equipment display groups. The following procedure can be used to test one or two of the display groups by performing the appropriate parts of the procedure.

1. Select BIT/DISPLAYS/DDI/MPCD/HUD
 - a. DDI, MPCD/AMPCD, and HUD displays go blank momentarily, flash IN TEST, and then display a test pattern.
 - b. Check DDI test patterns are steady and in focus.
 - c. HUD and MPCD/AMPCD test patterns flicker but remain on.
2. DDI, MPCD/AMPCD, and HUD displays - CHECK
 - a. Display commonality
 - b. Display concentricity
 - c. Proper Intensity
 - d. Check right DDI pushbuttons starting with the top left button on the horizontal row. Circle is displayed next to each pushbutton after it is pressed.
 - e. Check MPCD/AMPCD pushbuttons as in step d. Press STOP button last.
 - f. Check BIT status messages for GO on the BIT displays. F/A-18D lists front and rear indicator results separately.

2.20.3.10.2 IFEI Initiated BIT. IFEI test pattern is initiated by performing IFEI BIT using pushbutton sequence BIT/DISPLAYS/IFEI and observing the test pattern displays following the completion of IFEI BIT. The IFEI test pattern may be observed using the following procedure.

1. Select BIT/DISPLAYS/IFEI
2. IFEI - observe test display.
3. Select STOP to terminate test pattern
4. Engine monitor Indicator - CHECK
 - a. RPM- 50 %
 - b. EGT - 555°C
 - c. FF - 5,200 PPH
 - d. NOZ POS - 40 %
 - e. OIL - 150 PSI

UFC Test - UFC test patterns are performed by selecting BIT/DISPLAYS/UFC and observing the test displays and performing the UFC switch functional tests. The UFC test pattern is obtained using the following procedure.

5. Select BIT/DISPLAYS/UFC

6. Upfront control - CHECK

- a. All outer segments of alphanumeric displays, all segments of the numeric displays, and all option cues illuminate for the next 5 seconds.
- b. All inner segments of alphanumeric displays, all segments of the numeric displays, and all option cues illuminate for the next 5 seconds.

2.20.3.10.3 Stop Button. The STOP button allows the pilot to stop initiated BIT at any time. The same effect is also achieved by pressing MENU, although MENU is not available with the DSPL/EPI (IFEI)/UFC BIT test pattern displayed. When the STOP (or MENU) button is pressed, any test in progress stops and the equipment returns to normal operation. Exceptions to this are the radar and SMS power-on BIT and the COM 1/2, D/L, and tacan BIT. The radar and SMS power-on BIT cannot be terminated and, as such, indicates SF TEST when the MC detects the system is in BIT without having been commanded to do so. The same is true of the COM 1/2, D/L, and tacan equipment which performs a canned non-interruptable BIT sequence. The mission computer terminates initiated BIT for any equipment that it determined has taken too long to complete the test. For F/A-18 A/B, when DSPL/EPI (IFEI)/UFC initiated BIT is selected, the EPI (IFEI) display must be allowed to complete its display cycling before STOP is pressed or a UFC BIT failure is indicated.

2.20.3.11 BIT Logic Inspection (BLIN) Codes. BLIN codes are octal readouts identifying FCS failures and can be read from the FCS status display. The following procedures may be used to display and record BLIN codes. Channel 1 BLIN codes are displayed. Pressing BLIN button displays the next channel (1, 2, 3 and 4) BLIN codes.

1. On DDI - PRESS MENU/FCS/BLIN
2. DDI BLIN codes - RECORD BY CHANNEL
3. Press BLIN button to view next channel BLIN codes.

2.20.4 Non-Avionic BIT. NABIT is implemented within selected hydro-mechanical subsystems primarily for the purpose of displaying subsystem status in the cockpit (cautions and advisories) and/or providing fault detection and fault isolation information for maintenance personnel. This status data is provided to the status monitoring displays by the maintenance signal data recording set which interfaces with the following hydromechanical areas:

1. Engine/secondary power
2. Electrical
3. Hydraulics and landing/arresting gear
4. Fuel
5. Environmental control system and radar liquid cooling system
6. Controls/mechanisms/miscellaneous

The hydraulic system pressure cautions are interfaced directly by both mission computers providing redundancy for safety of flight.

2.20.4.1 Equipment Status Displays. NABIT cautions and advisories are displayed in the same manner as avionic cautions and advisories.

2.20.5 Status Monitoring Backup. MC2 provides backup status monitoring if MC1 fails. It provides an MC1 caution on the DDI indicating that MC1 has failed. It also provides HYD cautions.

NOTE

If MC1 fails, all DDI cautions and advisories are lost except MC1, HYD 1A, HYD 1B, HYD 2A, and HYD 2B. With MC OFP 13C AND UP, TAC MENU loses SA option and SUPT MENU displays only the HSI option.

2.20.6 Non-BIT Status. Equipment status derived by means other than BIT include DDI configuration display ID numbers and INS terminal data.

2.20.6.1 DDI Configuration Display Country ID Code. The country identifier code USN is displayed underneath the CONFIG legend.

2.20.6.2 DDI Configuration Display OFP ID Numbers. The ID numbers of the current operational flight program (OFP) loads for the radar, stores management system, INS, mission computers, communication system control, flight control computer, FLIR, SDC (F/A-18C/D), MU (F/A-18A after AFC 253 or 292 and F/A-18C/D), LST, and DMS and NFLR (LOT 12 and up) can be determined by selecting the configuration display on the left or right DDI (see figure 2-49). With MC OFP 19C, DCS and GPS ID numbers are also displayed. The configuration display is selected by the following procedure:

If MC OFP 10A AND UP -

1. Select BIT display from MENU
2. Select MAINT from BIT display
3. Select CONFIG from MAINT

If MC OFP 13C AND UP -

1. Select BIT from the SUPT MENU
2. Select CONFIG

With the configuration display selected, the current ID numbers are displayed to the right of the above equipment. Refer to figure 2-49 for an example.

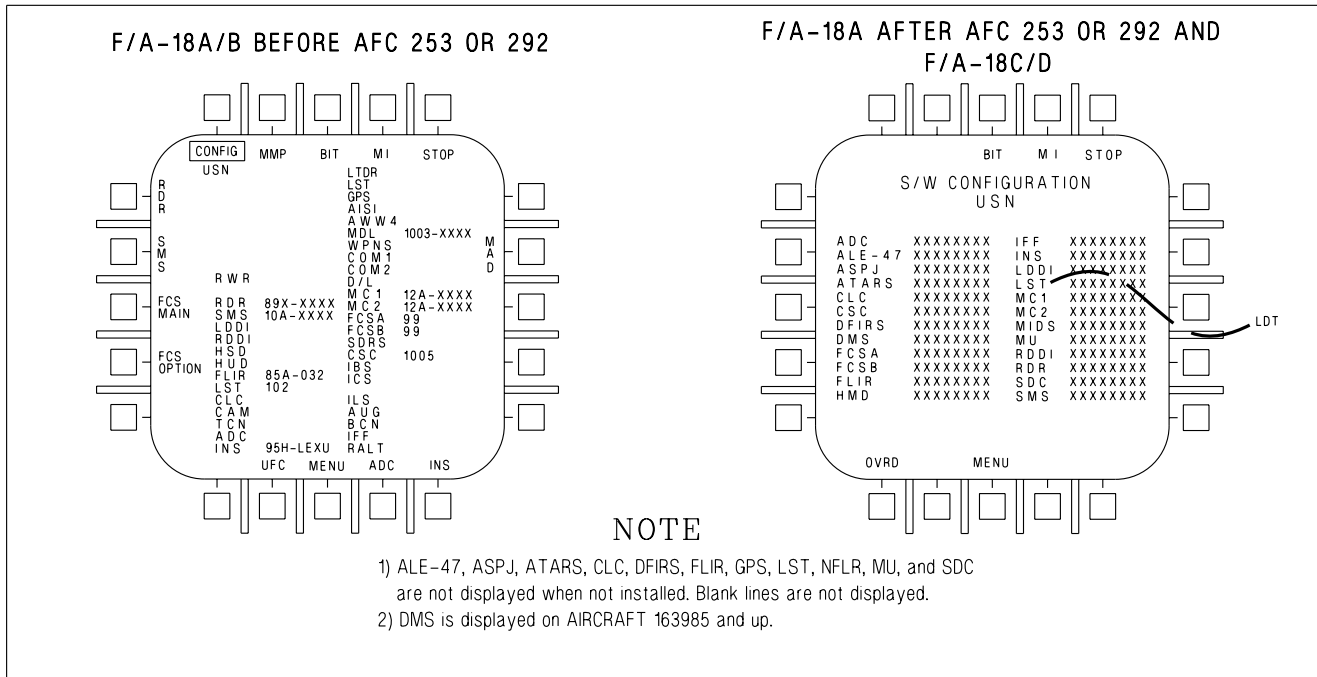

Figure 2-49. Configuration Display (Sample)

ADA520-343-1-056

2.20.6.2.1 MC CONFIG Caution Display. An MC CONFIG caution display indicates MC1 and MC2 OFP loads are found to be incompatible.

2.20.6.2.2 S/W CONFIG Caution Display. A S/W CONFIG caution display indicates MC1 and MC2 OFP loads are found not to be concurrent release (incompatible); MC1, MC2, RADAR, SMS, SDC (F/A-18C/D), MU (F/A-18A after AFC 253 or 292 and F/A-18C/D), INS OFPs or CSC (F/A-18C/D) are incompatible with MC OFPs; DMS/DMC (aircraft 163427 AND UP after AFC 270) not compatible with MC OFPs; FCSA and FCSB are not mutually compatible or are incompatible with the throttle modification. The incompatible OFP(s) are indicated by a line drawn thru the OFP ident. If the MC OFPs are incompatible a line is drawn thru both MC OFP idents.

2.20.6.2.3 OVRD Button. The override option allows the pilot to override the software configuration logic when the software country ID codes do not agree with the aircraft country ID codes.

2.20.6.3 INS Terminal Data. INS terminal data can be obtained if an update has been performed after flight with the parking brake on. With MC OFP 10A AND UP, INS terminal data is displayed by pressing the following pushbuttons in sequence: MENU, BIT, MAINT, INS, and POST. With MC OFP 13C AND UP, INS terminal data is displayed by pressing the following pushbuttons in sequence: MENU (SUPT), BIT, NAV, INS MAINT, and POST. Note the PER (position error rate) and navigation time on the FLIGHT 1, POST 1 display (see figure 2-50). Press the POST pushbutton again and note the velocity on the FLIGHT 1, POST 2 display. Turn the INS mode selector knob to OFF, then wait at least 10 seconds before turning off aircraft power. On aircraft with GPS, if the aircraft is flown with IFA selected, the position error rate does not include the time flown in the AINS mode. When an EGI is installed, the INS MAINT option provides detailed information for both the INS and GPS. The EGI also provides additional INS information that is not available from the ASN-130 or ASN-139.

POS= INS POSITION
 ALN TIME= TIME IN SECONDS
 AQ= ALIGN QUALITY
 AC= STATE COUNTER
 FOR ALIGN MODE
 NAV TIME= TIME IN SECONDS
 PER= INS PERFORMANCE (EQUALS RADIAL
 POSITION ERROR IN NAUTICAL MILES/HR)

 TO CHECK INS PERFORMANCE, DO AN UPDATE,
 OVFLY, TO WAYPOINT 0.

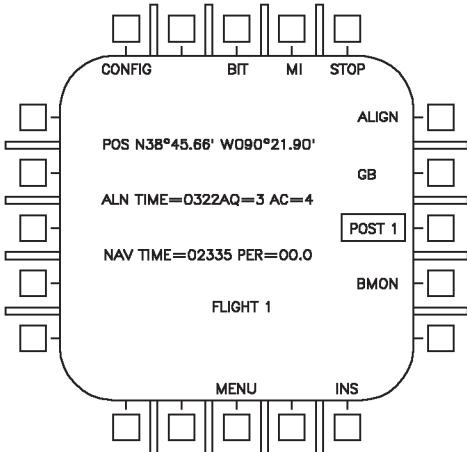

FLIGHT 1 THRU 5 (FLIGHT 1 SHOWN) – POST 1 DISPLAY

ERROR= IN N/S OR E/W, THE UPDATES
 ARE ADDED ALGEBRAICALLY
 CUM= ABSOLUTE VALUE OF UPDATES
 VEL= VELOCITY IN N/S OR E/W DIRECTION
 UPDATES= NUMBER OF UPDATES

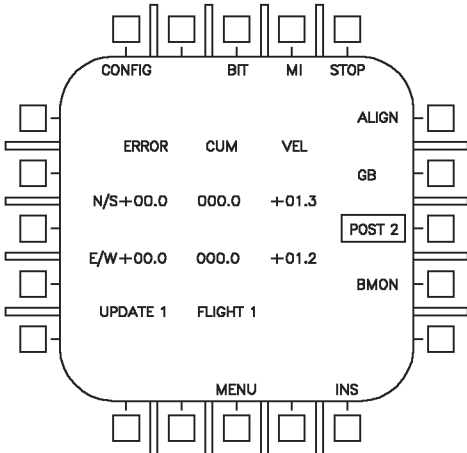

FLIGHT 1 THRU 5 (FLIGHT 1 SHOWN) – POST 2 DISPLAY

Figure 2-50. INS Post Flight Data Displays

2.21 JOINT HELMET MOUNTED CUEING SYSTEM (JHMCS)

The JHMCS allows the aircrew to target and employ existing short range missiles SRMs and High Off-Boresight (HOBS) weapons, such as the AIM-9X, and cue the radar, FLIR, and other sensors. When using JHMCS to employ HOBS weapons, the aircrew can slave/acquire and shoot targets beyond the gimbal limits of the aircraft radar and designate ground targets. The main display provides a monocular 20° field of view that is visible in front of the pilot's right eye.

The main components of the JHMCS include the helmet mounted displays, electronics unit, HMD/AHMD off/brightness knobs, aft cockpit Boresight Reference Unit (BRU), cockpit units, magnetic transmitter units, and seat position sensors in each cockpit. The JHMCS aircraft-integrated components can be flown with or without the helmet system.

WARNING

Increased weight and forward CG of the helmet will increase neck strain during high or sustained g flight maneuvers.

NOTE

All aircrew shall receive simulator or dedicated ground training on JHMCS helmet controls and displays prior to flight with JHMCS.

2.21.1 Helmet Mounted Display (HMD)/Aft Helmet Mounted Display (AHMD). Each HMD consists of the helmet, Helmet Display Unit (HDU), Helmet-Vehicle Interface (HVI), and a universal connector which connects the HDU to the helmet.

2.21.1.1 Helmet Display Unit (HDU). The HDU includes a CRT, Magnetic Receiver Unit (MRU), camera, auto-brightness circuitry, uplook reticles, and visor. Aircrew can remove the HDU and configure the helmet to accommodate the AN/AVS-9 night vision goggle system.

Ensure the HMD/AHMD OFF/BRT knob(s) are OFF before removing the HDU, and store the HDU in the JHMCS stowage bag on the right bulkhead.

CAUTION

- To keep water out of the HDU on aircrew helmets and prevent the possibility of electric shock, ensure the HDU cover is installed on the helmet.
- To prevent damage to the HDU, do not expose the HDU to a temperature exceeding 50°C (122°F) operationally or in storage.

2.21.1.2 Helmet-Vehicle Interface (HVI) Connectors. The HDU is connected to the aircraft by the HVI, which consists of 3 connectors. These connectors are the Quick Disconnect Connector (QDC), In-Line Release Connector (IRC), and Helmet Release Connector (HRC). The Upper HVI is the portion of the HVI from the helmet to the QDC. The lower HVI is the portion of the HVI below the QDC that is installed in the aircraft.

The Upper HVI is routed under the survival vest (if worn) through the JHMCS bundle flue on the torso harness. The QDC is seated in a Quick Mounting Bracket (QMB) attached to the lower left hand leg strap of the torso harness. See figure 2-51.

WARNING

The JHMCS upper HVI (UHVI) must be properly routed through the JHMCS bundle flue under the survival vest and the QDC secured in the QMB to ensure that no entanglement exists with the oxygen hose. Misrouting of the JHMCS UHVI may allow the QDC to rub against the oxygen hose disconnect causing unintentional oxygen/communications disconnect in-flight.

The QDC is the primary disconnect for ejection, and both normal and emergency ground egress. The QDC can be manually disconnected for normal egress by pushing a button on top of the QDC and separating the top half. During an ejection or emergency egress the QDC is disconnected via an aircraft mounted lanyard when a force of 15 to 25 pounds is applied. When the QDC is not connected, the aircraft QDC should be properly stowed in its receptacle. When the QDC is not properly connected and the system is on, an HMD/AHMD advisory is generated.

WARNING

The JHMCS QDC must be properly attached to the aircrew torso harness quick mounting bracket to avoid possible death or severe injury during ejection.

CAUTION

- Low voltage is present on the exposed QDC pins when the HMD/AHMD OFF/BRT knob(s) are not in OFF. To prevent a minor electrical shock from contact with exposed pins, ensure the HMD/AHMD OFF/BRT knobs are OFF whenever the QDC is disconnected and connected.
- To prevent damage to the QDC and aircraft components, ensure the aircraft QDC is properly stowed in its receptacle when not mated to the aircrews QDC.

NOTE

Ambient cockpit temperatures at or below 0°C (32°F) may cause inadvertent HMD/AHMD advisories during preflight. Warming of the QDC and quick mount bracket should remove the failure indication if temperature is the cause.

The IRC is a back up disconnect which functions in the event of QDC failure. The IRC is attached to the left aft console and requires a force of 80 to 120 pounds to disconnect.

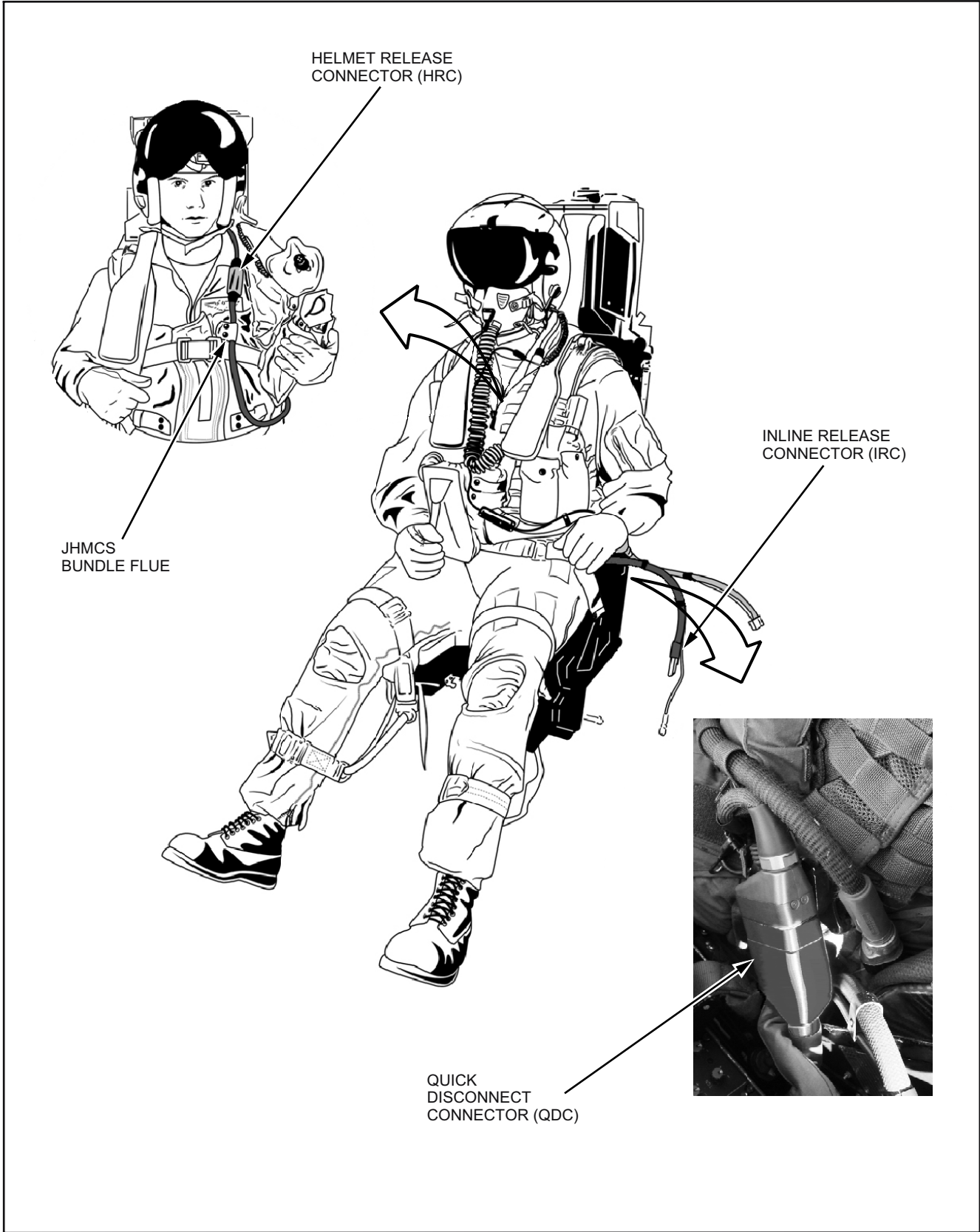

ADA520-366-1-058

Figure 2-51. JHMCS Upper HVI Routing

The HRC allows the cable to disconnect should the helmet be lost during ejection. The HRC connects to the left shoulder harness and requires a force of 80 to 120 pounds to disconnect.

2.21.2 Electronics Unit (EU). The EU contains the main system CPU, LOS module, graphics processor/display drive (one for each HMD), and low voltage power supply. The CPU controls system bus interfacing, display list generation, BIT, and other system functions. The LOS module calculates helmet LOS while the graphics processor/display drive processes the display list and generates the helmet display. The MC interfaces with the EU via the MUX bus. It is located in the rear cockpit.

2.21.3 Cockpit Unit (CU). The CU contains the system high voltage power supply for helmet displays. Both CUs are located in the aft crew station.

2.21.4 Magnetic Transmitter Unit (MTU). The MTU is used to generate a magnetic field used to determine HMD/AHMD position/orientation by the HMD MRU receiving the magnetic field and then sending the received signal to the EU. One MTU per cockpit is mounted on the canopy frame aft of the pilot/WSO's left shoulder.

The MTU is energized when the HMD/AHMD is turned on. Warm-up time for the MTU is 15 to 20 minutes. System accuracy may drift up to 0.5° if the HMD/AHMD is aligned before MTU warm-up is completed. An additional 5 to 10 minutes should be added to the MTU warm-up time if operating in extremely cold temperatures (e.g., -40°C).

NOTE

To maintain system accuracy, run initial HMD/AHMD alignment, or an additional HMD/AHMD alignment, after system is warmed-up.

2.21.5 Seat Position Sensor (SPS). The SPS is a linear potentiometer which indicates ejection seat height to the JHMCS. It is mounted to the aft right side of the ejection seat. There is one SPS for each ejection seat. This seat position information allows the JHMCS to compensate for disruption of the magnetic field in the cockpit as the metal in the seat changes position when the seat is raised or lowered.

2.21.6 HMD/AHMD OFF/BRT Knobs. The front cockpit HMD OFF/BRT knob is located on the spin recovery panel. This knob removes and applies power to the HMD, and adjusts HMD display brightness.

A BRU/HMD OFF/BRT stacked knob, located on the aft cockpit INTR LT control panel, removes and applies power to the BRU/AHMD, and adjusts BRU/AHMD display brightness. See figure 2-52.

2.21.7 Boresight Reference Unit (BRU). The BRU is located on top of the rear cockpit instrument blast shield and dust cover. An alignment cross is provided inside the BRU to permit coarse and fine alignment of the AHMD to the aircraft reference. See Figure 2-53.

2.21.8 HMD Video Recording. VTR selector switches located on the forward and aft CVRS Control panels allow selection of HMD video recording.

2.21.9 Cautions/Advisories. When the BuNo in the Magnetic Compensation Data file does not match the BuNo in the MC, or if the MC fails to download the initialization file to the EU, the MC sets the SW CONFIG caution and displays a line through the HMD S/W configuration line on the configuration display. An HMD/AHMD advisory is reported if the QDC is not properly secured to

FORWARD COCKPIT

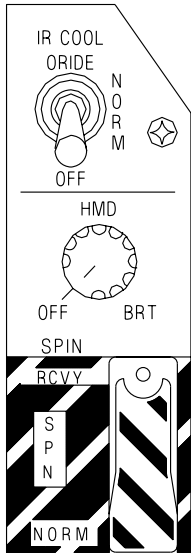

MAP GAIN/SPIN RECOVERY PANEL

REAR COCKPIT

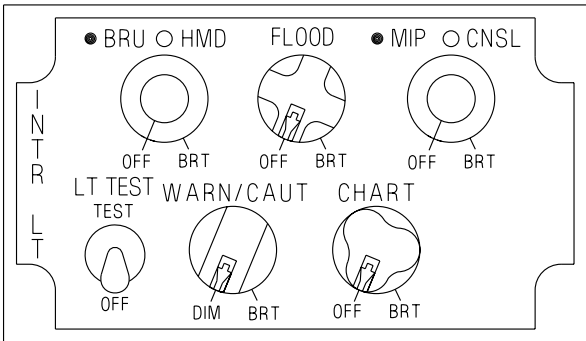

INTERIOR LIGHTS CONTROL PANEL

Figure 2-52. HMD Controls
I-2-189

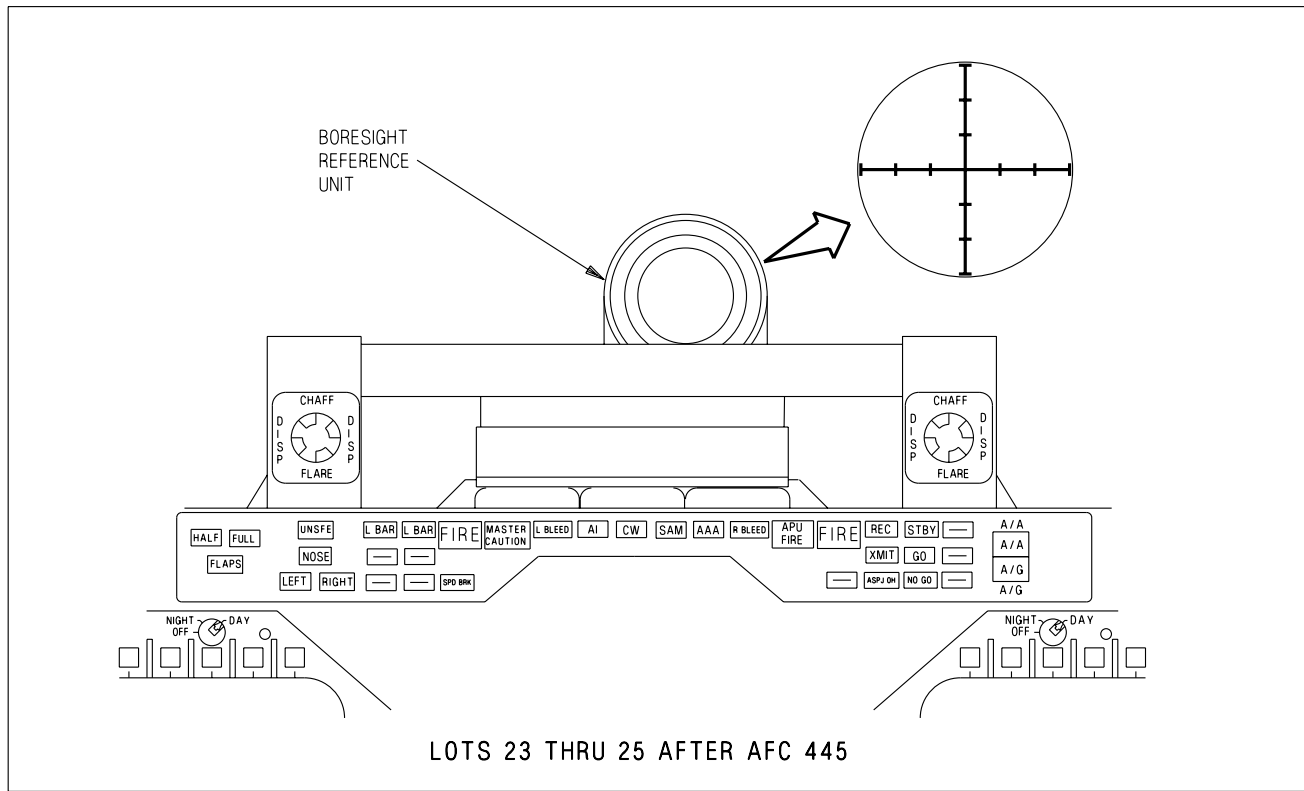

Figure 2-53. Boresight Reference Unit

ADA520-375-1-058

Quick Mounting Bracket (QMB) or is disconnected, the HDU is not properly connected, or the coarse alignment is invalid or has not been performed.

2.21.10 Configuration Check. When the JHMCS system is turned on, the MC provides the EU with the aircraft make, model, and tail number.

2.21.11 Built-In Test (BIT). The JHMCS BIT system includes automated start-up BIT (SBIT) and initiated BIT (IBIT), and displays a BIT status message. See figure 2-54 for the DISPLAYS BIT sublevel display.

2.21.11.1 Start-up BIT (SBIT). When the HMD system is turned on, SBIT starts automatically and the internal software is loaded in the EU. SBIT cannot be stopped until it is completed. PBIT GO or DEGD, as appropriate, is displayed when SBIT is completed.

2.21.11.2 Initiated BIT (IBIT). IBIT is performed when the HMD (PB 11) option is selected in either cockpit on the DISPLAYS BIT sublevel display. ENTERING IBIT flashes on both HMDs, and an initiated BIT is performed on both helmets. When IBIT is complete, a series of four test patterns, which are automatically changed each second, are displayed on the HMD/AHMD. See figure 2-55. The test patterns are displayed until the STOP (PB 10) option is selected. If the ALL (PB 6) option is selected, IBIT and HMD test patterns are performed.

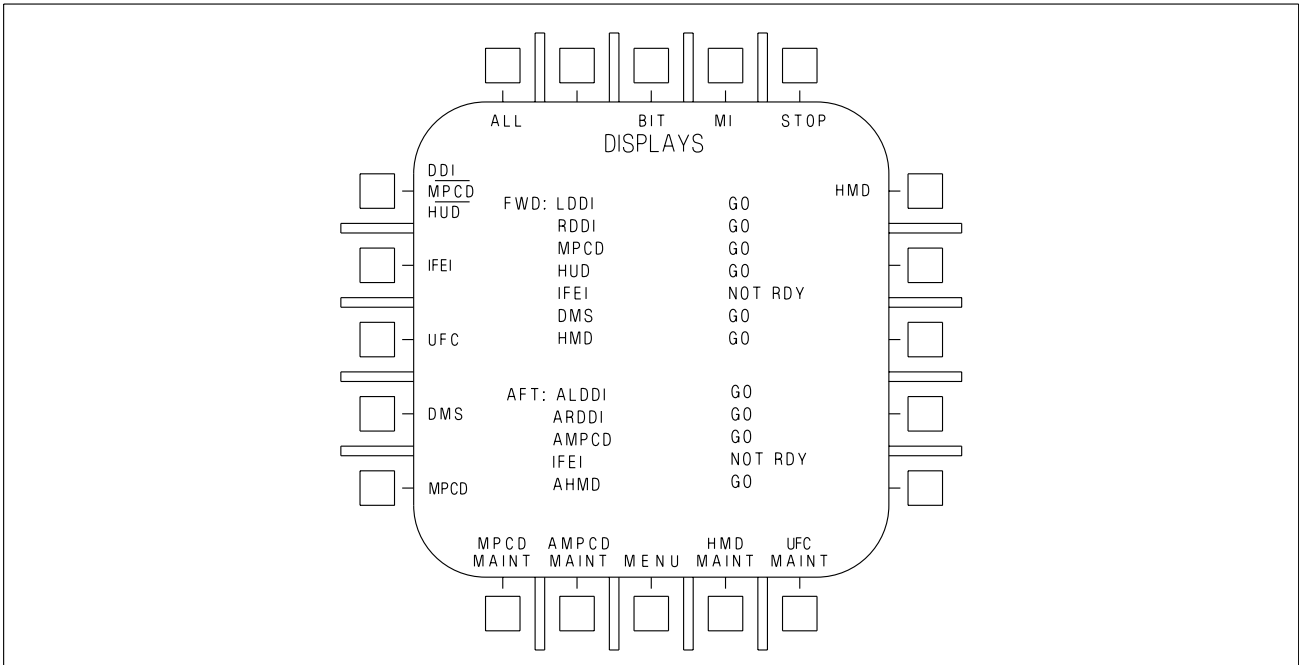

ADA520-370-1-058

Figure 2-54. Displays BIT Sublevel

2.21.11.3 Status Messages. Refer to the following for status messages and associated descriptions:

STATUS	MESSAGE DESCRIPTION
MUX FAIL	Equipment ready discrete is high but the EU is not communicating on either MUX bus to the MC
NOT RDY	Equipment ready discrete is low and the EU is not communicating on either MUX bus to the MC
IN TEST	Initiated BIT in progress
RESTRT	Re-initiate BIT, EU did not respond to the IBIT command or IBIT did not complete within 30 seconds
DEGD	EU has detected a failure which degrades system performance
OVRHT	EU has reported a component as overheated
DEGD+OVRHT	EU has detected a failure and EU has reported a component as overheated

STATUS	MESSAGE DESCRIPTION
GO	EU responded with no failures.
OP GO	EU has detected a failure which does not degrade system performance
PBIT GO	EU responded with no failures prior to performing IBIT

2.21.11.4 BIT Recording On The Memory Unit. The MC records any failure or degrade reported by the EU to the memory unit for fault reporting and isolation.

2.21.11.5 Overheat Condition. The system has the capability to detect an equipment overheat condition. When an overheat condition is detected the system is automatically shut down to prevent equipment damage.

2.21.12 JHMCS Alignment. The JHMCS must be boresighted (aligned) with the aircraft prior to every flight. Selecting the ALIGN (PB 20) option on the HMD format boxes ALIGN, selects coarse alignment mode, and displays the FINE (PB 1) alignment option after the coarse align function is complete. See figure 2-56.

The forward and aft helmets are aligned independently. The ALIGN option on the HMD format at PB 20, when selected from the aft cockpit, initiates aft HMD align. When in aft coarse or fine align mode the MC assigns the right AFT hand controller Designator Control (DC) switch to the HMD format. Both forward and aft HMD alignments function the same with the exception that the aft helmet is aligned to the BRU mounted on the aft main instrument panel.

2.21.12.1 Coarse Alignment. An alignment cross is displayed on the HUD/BRU and on the HMD/AHMD. See figure 2-56. The pilot moves the HMD to superimpose the alignment cross on the HMD over the alignment cross on the HUD. Once aligned, the cage/uncage switch is pressed and held until ALIGN OK is displayed on the HMD. When coarse alignment is complete, fine alignment is automatically selected. Fine alignment (PB 1) can also be manually selected.

The WSO moves the HMD to superimpose the alignment cross on the HMD over the alignment cross on the BRU, figure 2-56, sheet 2. Once aligned, the undesignate switch on the right hand controller is pressed and held until ALIGN OK is displayed on the HMD. When coarse alignment is complete, fine alignment is automatically selected. Fine alignment (PB 1) can also be manually selected.

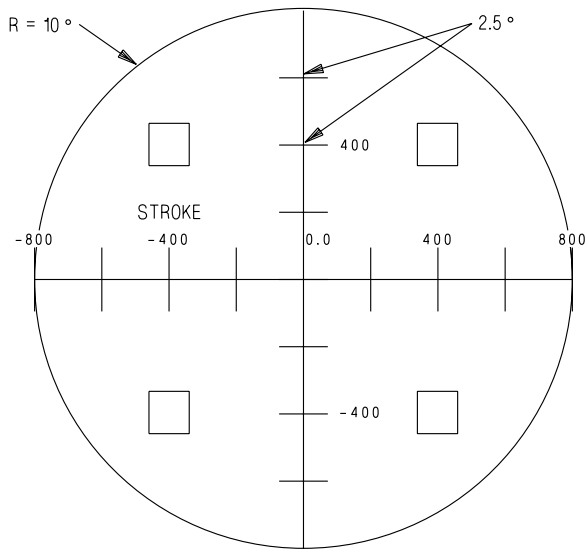

PATTERN 1

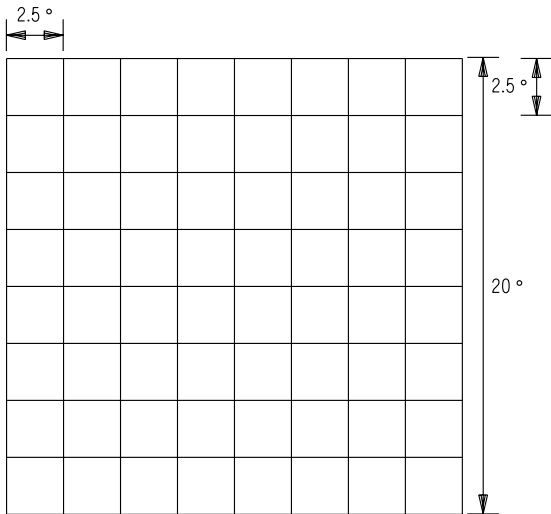

PATTERN 2

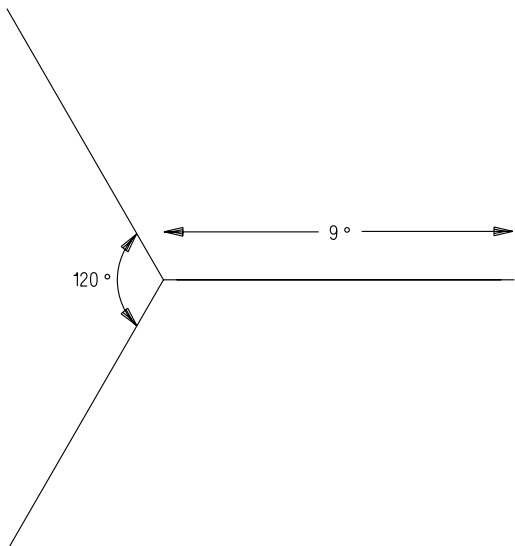

PATTERN 3

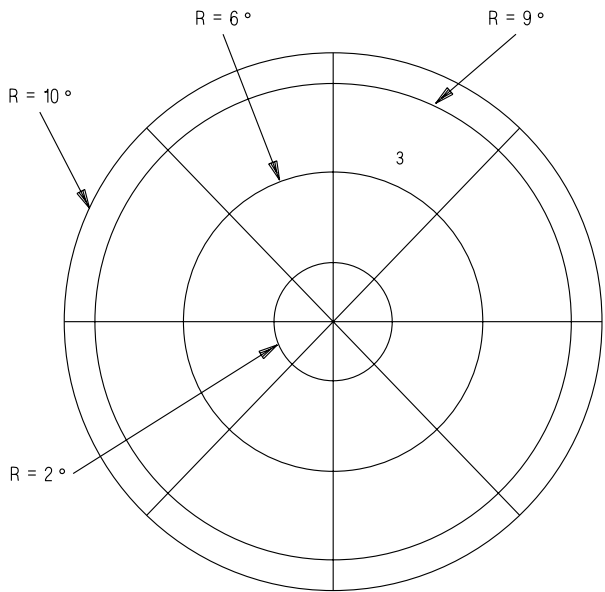

PATTERN 4

ADA520-368-1-056

Figure 2-55. HMD/AHMD Test Patterns

HMD COARSE ALIGNMENT

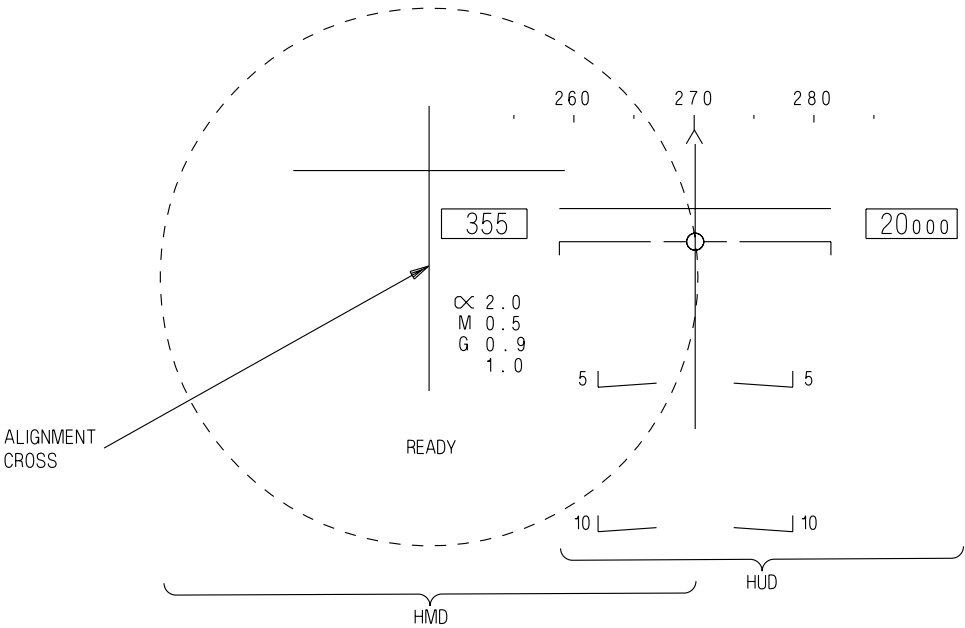
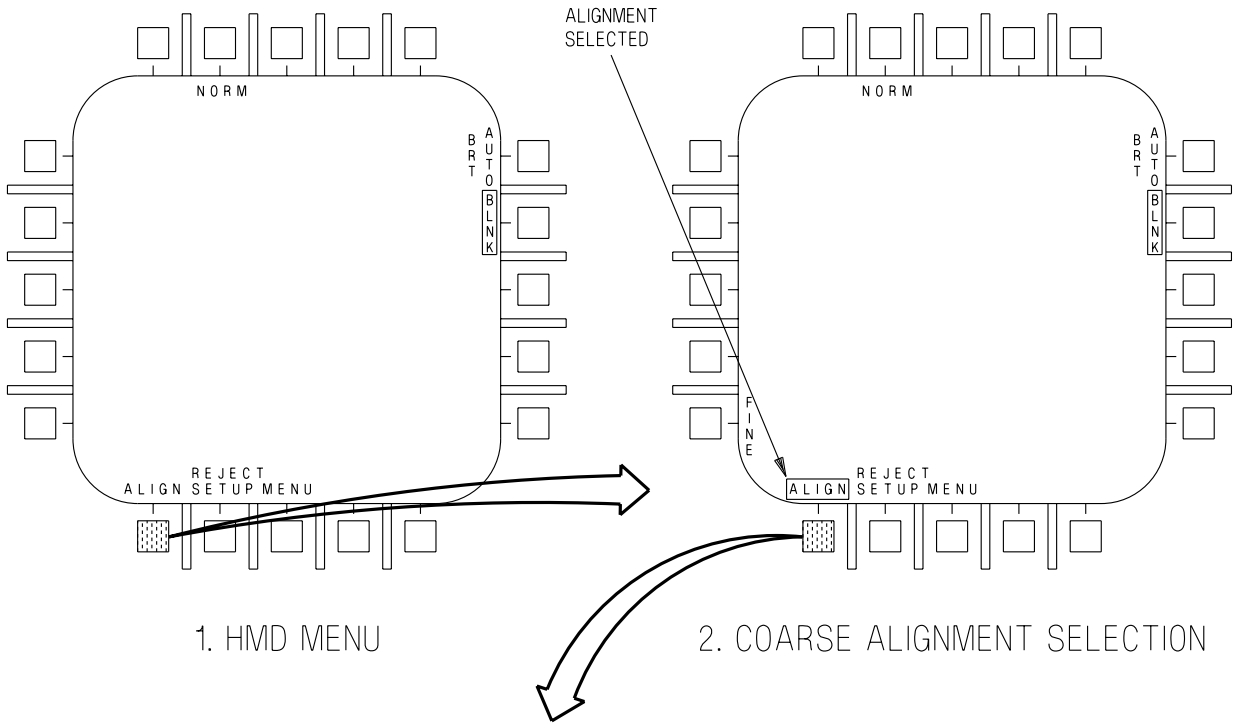

3. HUD AND HMD DISPLAYS

Figure 2-56. Coarse Alignment (Sheet 1 of 2)

AHMD COARSE ALIGNMENT

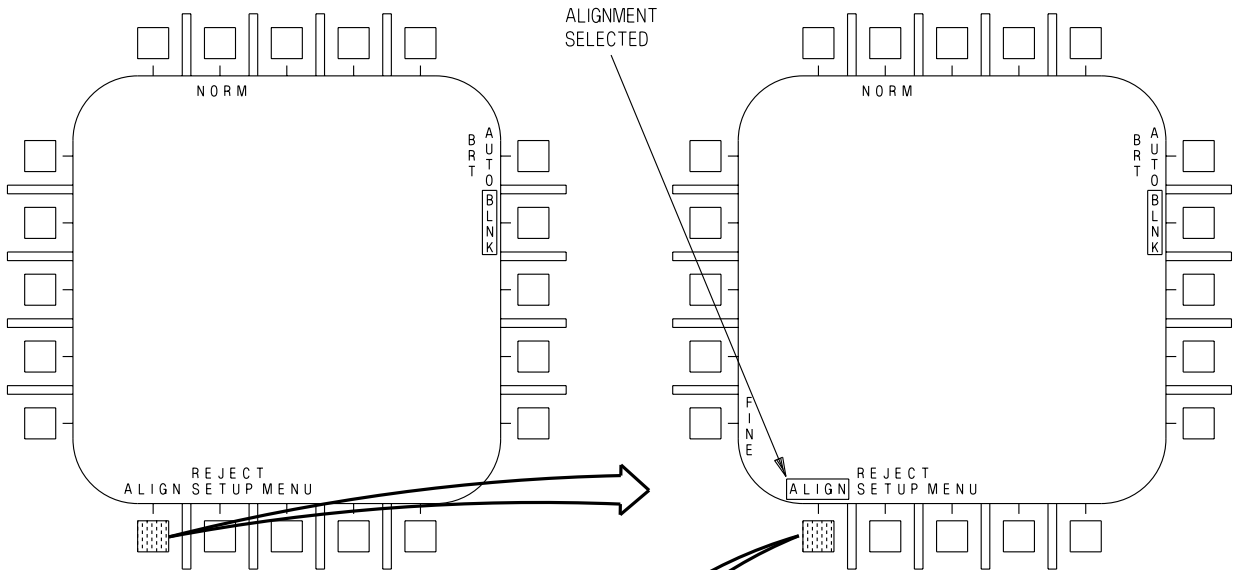

1. AHMD MENU

2. COARSE ALIGNMENT SELECTION

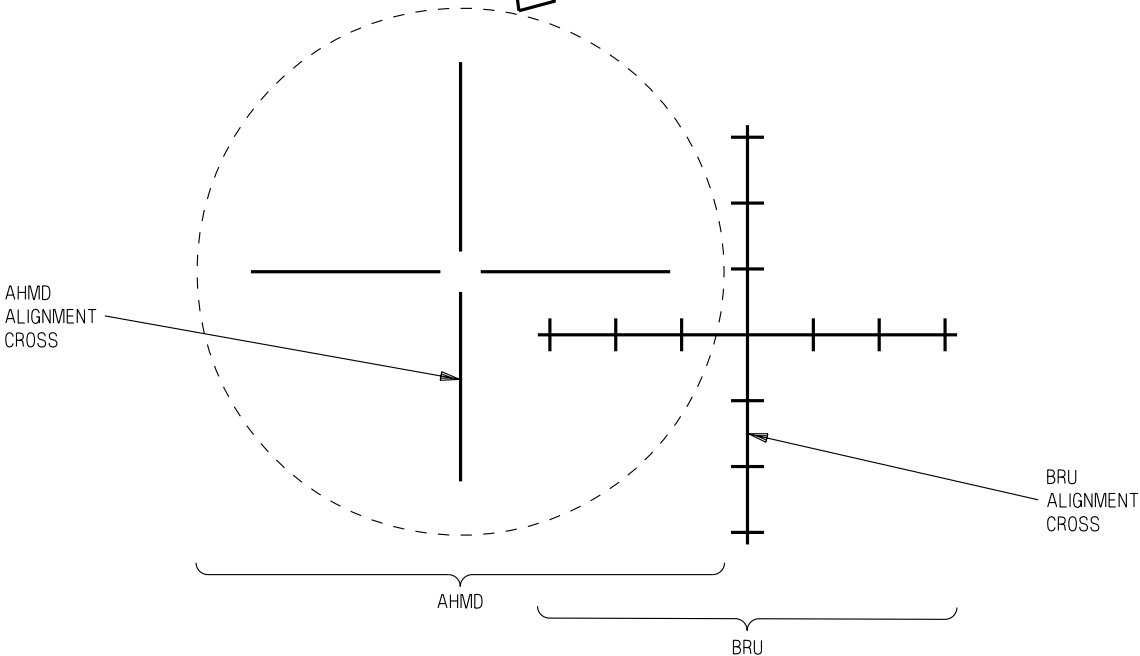

3. BRU AND AHMD DISPLAYS

Figure 2-56. Coarse Alignment (Sheet 2 of 2)

2.21.12.2 FINE Alignment. When the FINE (PB 1) option is boxed an alignment cross is displayed in the HUD and two alignment crosses are displayed on the HMD in the vicinity of the HUD alignment is indicated (FA DXDY), the pilot moves the TDC either left or right to align in azimuth, up or down to align in elevation. The pilot presses and releases the cage/uncage switch when satisfied with the quality of the azimuth and elevation alignment. This causes the display to toggle to roll alignment mode. With the roll axis indicated (FA DROLL), TDC inputs to the left or right are used to rotate the HMD alignment symbols to align with the HUD alignment cross. The pilot presses and releases the cage/uncage switch when satisfied with the quality of the roll alignment. Pressing and releasing the cage/uncage switch continues to toggle between these two modes until the pilot deselects FINE to return to coarse alignment or exits alignment.

Upon entering fine alignment, automatically, or if commanded by the WSO selecting the FINE option, the EU indicates which axis is being aligned. If the azimuth and elevation axis is indicated, the WSO uses the DC to move the crosses up/down and left/right to align with the cross displayed on the BRU, figure 2-57, sheet 2. When satisfied with the alignment, the WSO presses and releases the undesignate switch on right hand controller at which time the EU automatically switches to roll alignment. The WSO uses the DC to rotate the cross so that it aligns with the cross displayed on the BRU. When satisfied with the quality of the alignment the WSO presses and releases undesignate switch on right hand controller.

2.21.12.3 Alignment Exit. Alignment is exited whenever ALIGN is deselected (unboxed), an A/A weapon is selected, MENU is selected, TDC priority is reassigned, ACM mode is selected, or the master mode is changed. This removes the alignment cross from the HUD, removes the FINE option, unboxes ALIGN, and returns the cage/uncage function to the previously assigned system.

HMD FINE ALIGNMENT

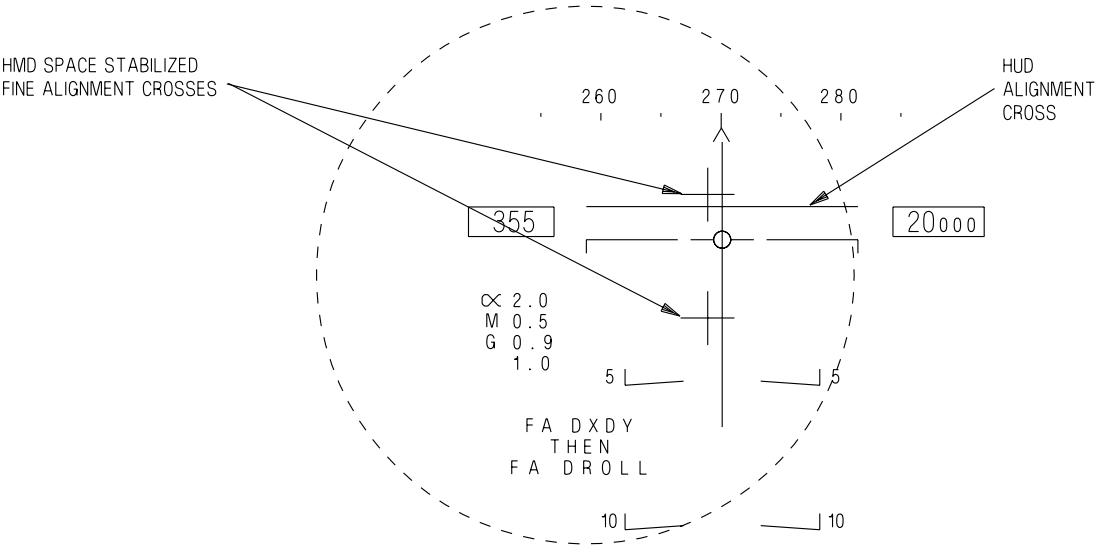
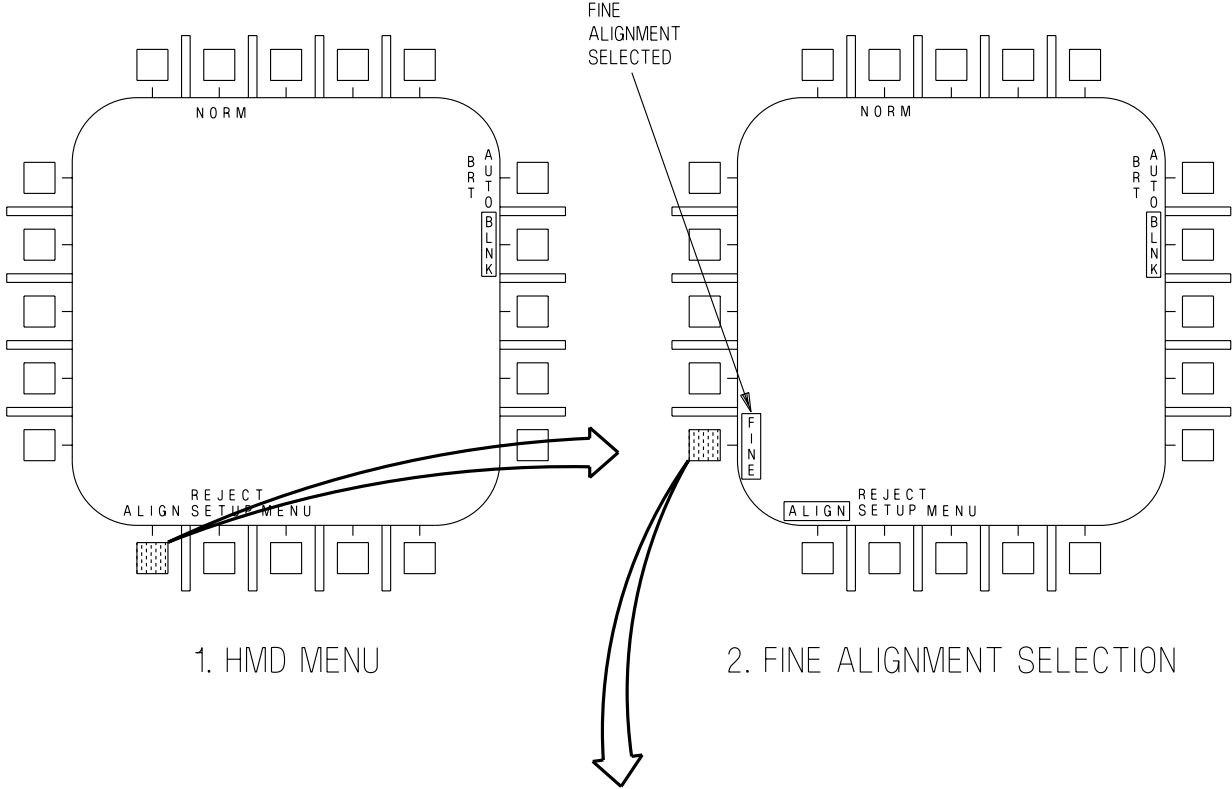

3. HUD AND HMD DISPLAYS

Figure 2-57. Fine Alignment (Sheet 1 of 2)

AHMD FINE ALIGNMENT

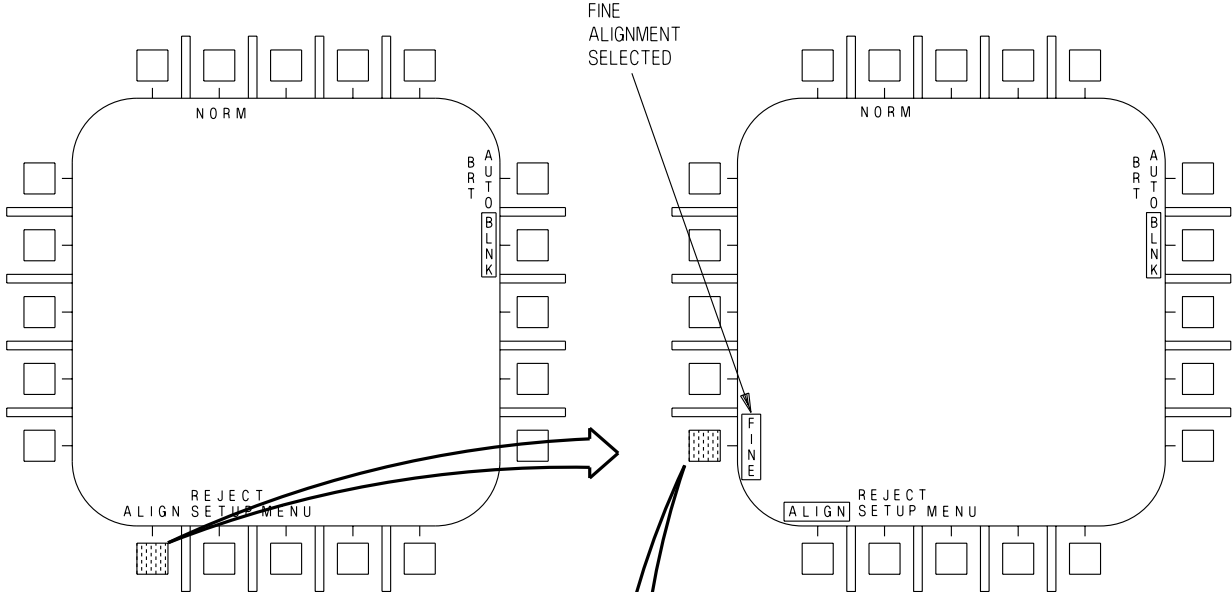

1. AHMD MENU

2. FINE ALIGNMENT SELECTION

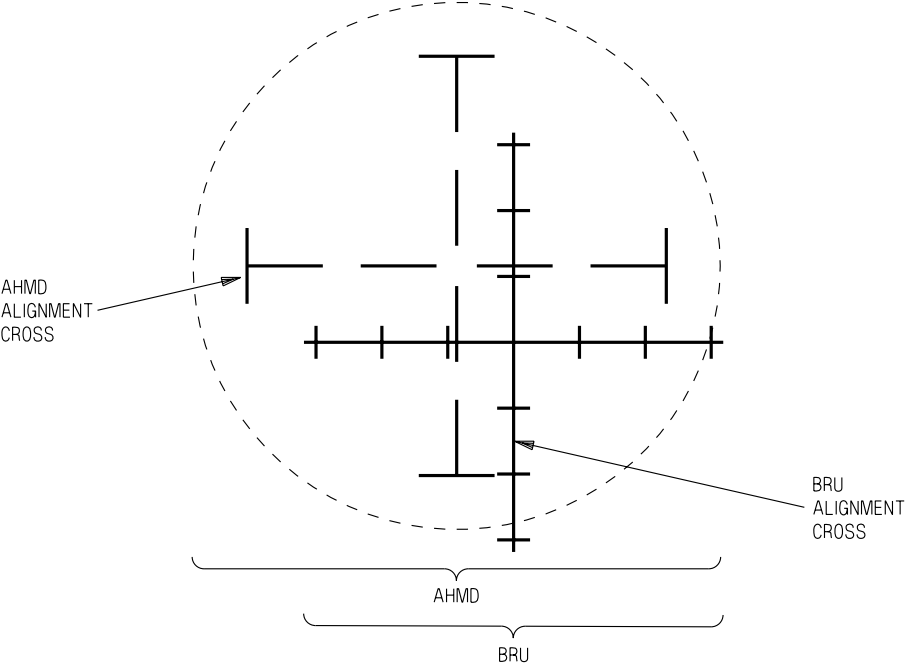

3. BRU AND AHMD DISPLAYS

Figure 2-57. Fine Alignment (Sheet 2 of 2)

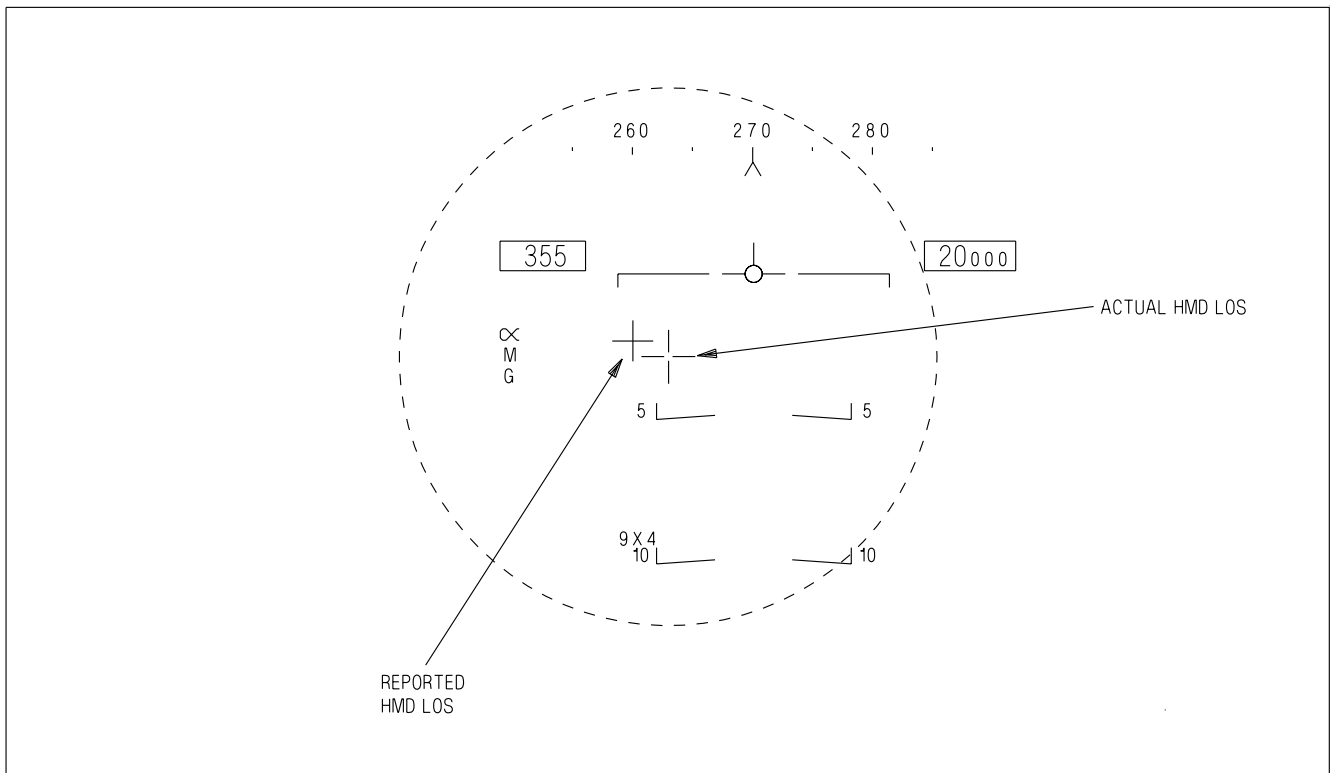

ADA520-373-1-056

Figure 2-58. Alignment Verification

2.21.12.4 Alignment Verification. When the HMD is in normal mode a cross is displayed on the HUD at the reported HMD LOS. See figure 2-58. If the reported HMD LOS is outside the HUD FOV, the cross flashes at the HUD FOV limit.

2.21.13 HMD/AHMD Symbology

2.21.13.1 HUD Symbology Replicated on the HMD. The HMD layout essentially replicates the HUD layout. Window locations, format, and occlusion level on the HMD are as identical to the HUD locations, format, and occlusion level as practical.

2.21.13.2 HUD Symbology Not Replicated on the HMD. Some of the symbology on the HUD is either not required on the HMD or would be disorienting if the information was presented. The following paragraphs describe the items on the HUD which are not replicated on the HMD.

2.21.13.3 Aircraft Attitude Data. Some HUD data only provides the pilot usable information when presented along the aircraft boresight. HMD data is not always presented along the aircraft boresight. For this reason, the aircraft pitch ladder, horizon bar, water line indicator, and velocity vector are not displayed on the HMD/AHMD.

WARNING

The HMD/AHMD does not provide adequate attitude information and should not be used as a primary flight instrument.

2.21.13.4 Ground Proximity Warning System. In addition to aircraft attitude data, the HMD/AHMD does not replicate the Ground Proximity Warning System (GPWS) arrow. However, when the GPWS is activated, ALTITUDE is displayed in the HARM window of the HMD/AHMD.

2.21.14 Navigation Master Mode. If present, the MC displays the A/A L&S with the TD box and its associated TLL, or the A/G designation with the TD diamond and its associated TLL. However, if both the A/A L&S and the A/G designation are present, only the A/A L&S TLL is displayed.

2.21.14.1 NAV Master Mode TDC Priority. When in NAV master mode, the TDC/DC can be assigned priority to the HMD/AHMD by pressing the castle switch or DCA forward. This is indicated by the display of an open aiming cross with a dot in the center. If TDC/DC priority is removed from the HMD/AHMD, the dot is removed from the center of the aiming cross.

2.21.15 Mission Computer Failure. In the event of an MC1 failure, MC2 provides back-up symbology for the HMD. MC2, at a minimum, provides airspeed, altitude, selected A/A weapon and count, and the L&S and AIM-9 LOS. MC2 continues to slave the radar to the HMD LOS when in HACQ mode. MC2 also continues to slave the AIM-9 to the HMD LOS when the AIM-9 is selected. Activation of the uplook reticles are also maintained during back-up.

In the event of an MC2 failure, MC1 provides back-up symbology for the HMD. MC1, at a minimum, provides airspeed, altitude, selected A/A weapon and count. Slaving of the radar and AIM-9 is suspended.

2.21.16 Electronic Unit Failure. In the event of an EU failure which does not allow any symbology to be displayed on the HMD, the MC provides the radar boresight symbol and AIM-9 FOV symbol on the HUD. If the LOS is still valid, the MC continues to slave the radar or AIM-9 to the HMD LOS. If the LOS is invalid, the MC reverts to the current no-helmet mechanization for slaving weapons, sensors, and HOTAS.

2.21.17 Helmet Tracker Failure. If the EU reports that the helmet tracker is failed, or the helmet LOS is no longer valid, the MC discontinues slaving sensors and weapons to the HMD LOS. The MC replaces aircraft boresight for the helmet LOS to the radar and AIM-9. Additionally, the MC removes any item from the HMD which is tied to the HMD LOS. The radar boresight and AIM-9 FOV symbol are restored to the HUD. The MC also restores VACQ mode and the HOTAS function to access the VACQ function. The MC continues to display information on the HMD which is not tied to the HMD LOS.

2.21.18 Helmet Not Installed. When the MC determines that the HMD is not on, or the EU is not responding to the MC via the mux bus, the MC reverts to the current no-helmet mechanization for slaving weapons, sensors, HOTAS, and HUD display.

2.22 FIGHTER/ATTACK/TRAINER/RECCE (F/A-18B/D)

2.22.1 F/A-18B/D Aircraft 161354 THRU 163778. These aircraft are tandem configured (see figure 2-59) for performing the secondary role of a trainer without compromising the primary role of Fighter/Attack. Using the front cockpit controls, the F/A-18B/D avionics provide equivalent navigation and weapon system capabilities as those available in the single-place F/A-18A/C. The rear cockpit controls duplicate most front cockpit controls for navigation and weapon system control. However, weapons cannot be launched/released/fired from the rear cockpit. The rear cockpit and the differences relative to the single-seat version are discussed in the following paragraphs.

2.22.2 F/A-18D Aircraft 163986 AND UP.

2.22.2.1 Night Attack Configuration. These aircraft are tandem configured with a primary role of performing the night attack mission. The rear cockpits of these aircraft have the stick and throttles removed. The rudder pedals are fixed and disconnected from the rudder, brakes, and nosewheel steering. Two hand controllers have been added and the rear cockpit controls and displays operate independent of the front cockpit. Instruments and lighting are NVG compatible.

2.22.2.2 Training Configuration. Night attack aircraft may be reconfigured to a trainer aircraft by removing the two hand controllers, adding throttles, stick, and connecting the rudder pedals. Rear cockpit controls and displays remain independent of the front cockpit.

2.22.2.3 RECCE Configuration. The F/A-18D aircraft, when retrofitted with the reconnaissance equipment, is designated as the F/A-18D(RC) (Reconnaissance Capable). It provides high resolution, long range standoff and overflight reconnaissance capabilities, for day or night, for all weather and under the weather missions. Electro-optical (EO), infrared (IR), and synthetic aperture radar (SAR) sensors gather image data. Image data is recorded onto two onboard recorders and is available for downlink to ground stations for subsequent dissemination and exploitation. The aircraft is converted by installing the Advanced Tactical Reconnaissance System (ATARS) sensor suite into the nose bay in place of the 20 mm gun. A data link pod can be loaded on the centerline to allow for the downlink of imagery data. Refer to NTRP 3-22.2-FA18A-D NATIP for ATARS description and operating procedures.

2.22.3 Aircraft Dimensions. The approximate dimensions of the aircraft are as follows:

Span (Wings Spread) with missiles	40 feet 5 inches
Span (Wings Spread) without missiles	37 feet 6 inches
Span (Wings Folded)	27 feet 6 inches
Length	56 feet
Height (To Top of Fins)	15 feet 3 inches
Height (To Top of Closed Canopy)	11 feet 3 inches

2.22.4 Aircraft Gross Weight. Basic aircraft gross weight varies from 24,000 to 25,000 pounds. Refer to applicable DD 365F for accurate aircraft weight.

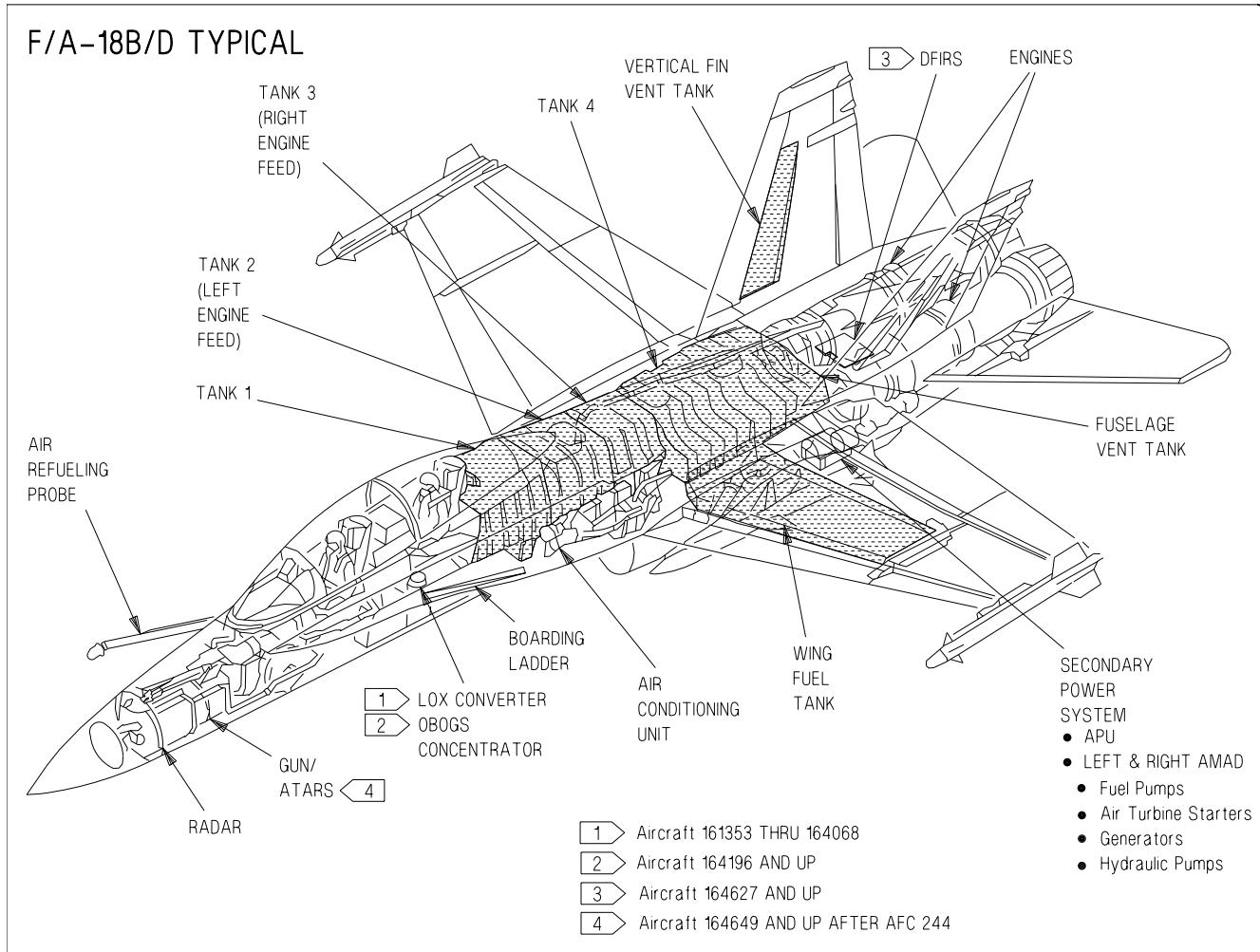

Figure 2-59. General Arrangement (F/A-18B/D)

2.22.5 Fuel Quantity. To make room for the rear cockpit, the fuel capacity in tank 1 is reduced to 316 gallons (2,150 pounds JP-5 or 2,050 pounds JP-4). See figure 2-60.

2.22.6 Canopy System. The canopy system is similar to the F/A-18A/C aircraft except that an additional internal canopy jettison handle is installed in the rear cockpit. Note that the rear cockpit does not have an internal canopy switch or an internal manual canopy handcrank, and therefore, the canopy must be opened from the forward cockpit (or externally) unless it is jettisoned. To manually open the canopy using the internal manual handcrank, 224 counterclockwise manual crank turns are required. To manually open the canopy externally using a drivesocket, 112 counterclockwise manual crank turns are required.

2.22.7 Ejection Seat System. Ejection seats are installed in both cockpits. In addition, a sequencing system is installed to allow dual ejection initiated from either cockpit or single (aft) seat ejection initiated from the rear cockpit. A command selector valve is installed in the rear cockpit to control whether ejection from the rear cockpit is dual or single.

TANK	USABLE FUEL			
	GALLONS		POUNDS	
		JP-5	JP-4	
Number 1	316		2,150	2,050
Number 2 Left Engine Feed	263		1,790	1,710
Number 3 Right Engine Feed	206		1,400	1,340
Number 4	532		3,620	3,460
Total Fuselage	1,317		8,960	8,560
Left and Right Internal Wings	85	85	580	580
	170		1,160	1,100
Total Internal	1,487		10,110	9,670

EXTERNAL TANK(S)

Elliptical Wing or Centerline Tank	314	2,140	2,040
Cylindrical Wing or Centerline Tank	330	2,240	2,150

NOTES

- The fuel quantities, in pounds, are rounded off to the nearest 10 pounds. Therefore, the actual gallons times 6.8 or 6.5 will not necessarily agree with the pounds column.
- Fuel weights are based on JP-5 or JP-4 at 6.8 or 6.5 pounds per gallon and a temperature of 15°C(59°F).

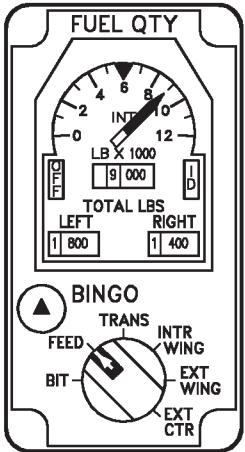

F/A-18B

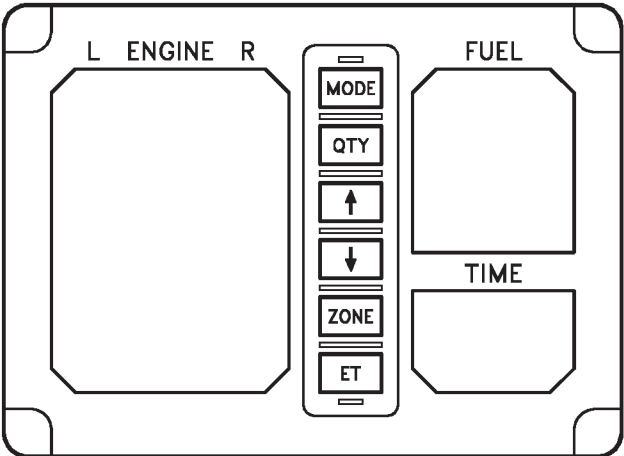

F/A-18D

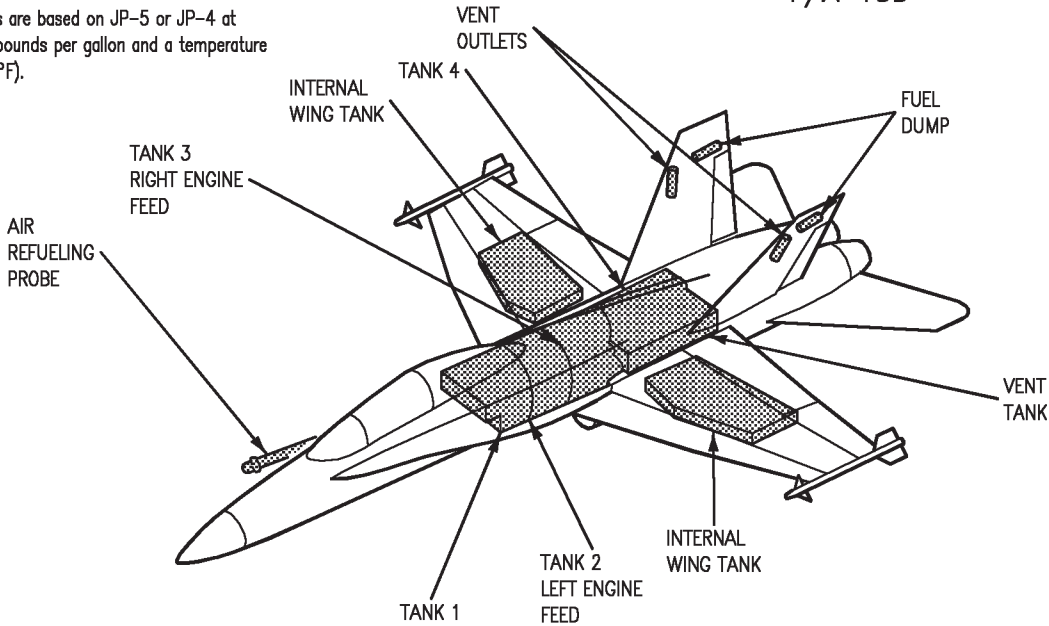

Figure 2-60. Fuel Quantity (F/A-18B/D)

2.22.7.1 CK SEAT Caution (F/A-18D). The CK SEAT caution light is located on the caution light panel, and repeats the DDI CHECK SEAT caution display. The caution is displayed when the right throttle is at MIL or above, weight is on wheels, and the front cockpit ejection seat is not armed with the rear cockpit NORM/SOLO switch set to SOLO or either ejection seat is not armed with the NORM/SOLO switch set to NORM.

2.22.8 Intercom Controls. Intercom controls consist of two cockpit volume control knobs and an intercom function selector switch.

2.22.8.1 Volume Control Knobs. The volume control knob on the intercommunication panel in the front cockpit is labeled ICS. This knob varies the audio volume to the pilot's headset. The volume control knob in the rear cockpit is on the volume control panel on the left console. This knob is labeled ICS and varies the audio volume to the rear cockpit headset.

2.22.8.2 Intercom Function Selector Switch. A three-position toggle switch, with positions marked RADIO ORIDE (override), HOT MIC, and COLD MIC is on the antenna selector panel in the front cockpit and on the volume control panel in the rear cockpit. The functions of the switch positions are as follows:

RADIO ORIDE	Allows intercom audio to be louder than radio audio in the cockpit where selected.
HOT MIC	Enables cockpit microphone for intercom transmission in the cockpit where selected.
COLD MIC	Disables cockpit microphone for intercom transmission in the cockpit where selected.

2.22.9 Rear Cockpit. The rear cockpit contains the equipment differences as described in the following paragraphs. Refer to Rear Cockpit, Foldout section for rear cockpit arrangements.

2.22.9.1 Fire Warning Lights. The left and right engine and APU fire warning lights are advisory only. They do not arm or discharge the extinguishing system or shut down the engines or APU.

2.22.9.2 Fuel Quantity Indicator (F/A-18B). The fuel quantity indicator has two counters. One indicates total fuel quantity and the other indicates internal fuel only.

2.22.9.3 Command Selector Valve. A command selector valve is provided on the right vertical panel to select the desired ejection sequence to be initiated from the rear cockpit, or provide for single ejection for solo flight. Positioning is accomplished by pulling out while turning to the desired position. Solo position requires use of a collar. To release from aft initiate, pull then turn clockwise.

NORM (vertical)	Single rear seat ejection when initiated from the rear cockpit. Dual ejection (rear seat first) when initiated from the front cockpit.
AFT INITIATE (horizontal)	Dual ejection (rear seat first) when initiated from either seat.
SOLO 45° CCW	Front seat ejection only when initiated from front seat. Front seat ejection is immediate. Rear seat ejection only when initiated from the rear seat. Rear seat ejection is immediate.

WARNING

- SOLO mode shall NOT be selected when both seats are occupied. If SOLO mode is selected when both seats are occupied, simultaneous ejection initiation may result in a collision between seats.
- SOLO mode shall be selected when the aircraft is being flown solo. Alternate selection when flying solo results in ejection of unoccupied seat and possible collision with occupied seat.
- Ejection system component failure can disable the command ejection function in an F/A-18B/D. With either AFT INITIATE or NORM selected, each crewmember should initiate ejection independently.

CAUTION

When selecting NORM or SOLO from AFT INITIATE, the handle must be pulled before rotation or damage to valve may result.

2.22.9.4 Seat Caution Mode Switch (F/A-18D). The seat caution mode switch is located in the rear cockpit above the command selector valve. The switch position changes the operation of the CK SEAT caution for solo or dual flight.

NORM	CK SEAT caution is activated by either seat remaining safed. Switch is spring loaded to this position.
SOLO	CK SEAT caution is activated only by the front seat remaining safed. Switch must be pinned to remain in this position.

2.22.9.5 Internal Canopy Jettison Handle. A black and yellow striped canopy jettison handle is under the left canopy sill just aft of the volume control panel. Pressing an unlock button on the forward edge of the handle and then pulling the handle up fires the canopy jettison system.

2.22.9.6 Interior Lighting. Except for the utility floodlight, all controls for the interior lights are on the interior lights panel on the right console. There is no flood switch in the rear cockpit. The switch logic for dimming and brightening the warning/caution lights is the same as the front cockpit but without the flood switch.

2.22.9.7 Lights Test Switch. A lights test switch, labeled LT TEST, is provided to test the warning/caution/ advisory lights and is independent of the front cockpit. The switch only operates with ac power on the aircraft.

TEST Serviceable warning/caution/advisory lights come on.

OFF The switch is spring loaded off.

2.22.9.8 Equipment Status Displays. In the aft cockpit, BIT, cautions and advisories are normally displayed on the left DDI. If the left DDI is unavailable, they are displayed on the right DDI.

On aircraft 163986 AND UP, if both rear cockpit DDIs are unavailable, the aft MPCD/AMPCD is used to display cautions and advisories. Cautions and advisories are displayed at the bottom of the display of the MPCD/AMPCD.

2.22.9.9 Master Caution Light. A yellow MASTER CAUTION light, on the upper instrument panel comes on whenever the MASTER CAUTION light in the forward cockpit comes on. The aft MASTER CAUTION light goes out whenever the front cockpit MASTER CAUTION is reset.

2.22.9.10 Landing Gear UNSFE Light. The red UNSFE light illuminates to indicate the landing gear is in transit and will also stay on if the gear does not match the handle position. The light does not indicate planing link failure, provide wheel warning, or air data computer failure indication.

2.22.9.11 Landing Gear Position Lights. There are three green landing gear position lights marked NOSE, LEFT, and RIGHT above the landing gear control handle. The lights come on when their respective gear is down and locked. The LEFT and RIGHT lights flash when their respective gear is down and locked but a related planing link is not locked.

2.22.9.12 Emergency Brake Handle. The emergency brake handle, on the left vertical panel, only provides emergency brakes. It has no parking brake function. To actuate the emergency brake system in either trainer or night attack aircraft configuration, pull out on the handle until it locks in the detent. The handle must be fully stowed to ensure anti-skid is available in either configuration.

2.22.9.13 Emergency Landing Gear Handle. The emergency landing gear handle, on the left vertical panel, provides emergency landing gear extension from the rear cockpit. Emergency extension is accomplished by pulling out on the handle until it locks in the detent. There are no provisions for normal landing gear extension.

2.22.9.14 Digital Display Indicators. On aircraft 161354 THRU 163778 the corresponding left and right DDI in each cockpit presents the same information. The center DDI displays the same information as the HI, except for the moving map display. Systems and presentations controlled by DDI/HI pushbuttons respond to the last action taken in either cockpit.

On aircraft 163986 AND UP the rear cockpit left and right DDI are independent of the front cockpit DDIs. However, the operation of both DDIs is identical to that of the front cockpit DDIs.

2.22.9.15 MPCD/AMPCD (AIRCRAFT 163986 AND UP). The rear cockpit also contains an MPCD/AMPCD located between the left and right DDIs and is independent of the front cockpit MPCD/AMPCD. However, MPCD/AMPCD operation is identical to that of the front cockpit MPCD/AMPCD.

2.22.9.16 Head-Up Display. The rear cockpit does not contain a HUD, but HUD symbology can be selected for display from the MENU on either the left or right DDI (F/A-18B/D aircraft 161354 THRU 163778). This also selects HUD symbology on the same DDI in the front cockpit. On F/A-18D aircraft 163986 AND UP, HUD symbology can appear on either DDI independent of the front cockpit. On F/A-18D aircraft 163986 AND UP, the HUD display is the only display not replaced by the SPIN recovery display when the SPIN recovery switch is actuated.

2.22.9.17 Display Select Control (AIRCRAFT 161704 THRU 163778). This control is a toggle switch with positions of HUD and NORM. Placing the switch to HUD causes the HUD display to appear on the left DDI and removes and/or prevents caution and advisory displays on the left DDI. With the switch set to NORM, the DDI operates normally by using the pushbuttons.

2.22.9.18 Upfront Control. The upfront control in each cockpit presents the same information. The associated UFC systems respond to the last selection made in either cockpit.

2.22.9.19 Attitude Reference Indicator. The attitude reference indicator (ARI) in the rear cockpit does not display azimuth and elevation steering during ILS operations.

2.22.9.20 Master Mode Buttons. The associated systems controlled by the A/A and A/G master mode buttons respond to the last selection made in either cockpit.

2.22.9.21 Control Stick (AIRCRAFT 161354 THRU 163778 and trainer configured 163986 AND UP). The control stick switches respond to the last crew member action taken from either cockpit. The trigger switch and the weapon release button are non-functional.

2.22.9.21.1 A/A Weapon Select Switch. The rear cockpit weapon select switch is active only in the A/A master mode. In the rear cockpit, the A/A master mode must be selected with A/A master mode button.

2.22.9.22 Throttles (AIRCRAFT 161354 THRU 163778 and trainer configured 163986 AND UP). The throttles provide engine control from IDLE through MAX. The throttles cannot be placed in OFF from the rear seat. Systems controlled by throttle switches respond to the last crewmember action taken from either cockpit. The ATC engage/disengage switch is non-functional, the flare/chaff switch is not installed, and the speedbrake switch is momentary action.

2.22.9.23 Hand Controllers (F/A-18D night attack configured AIRCRAFT 163986 AND UP). The right and left hand controllers (figure 2-61) located on the forward inboard section of the right and left rear cockpit consoles, are used to provide sensor/display control.

2.22.9.23.1 Designator Control Assignment (DCA)/Sensor Control. Assignment switches are used to assign Designator Control to the DDI/MPCD/AMPCD. In the aft cockpit, Designator Control (DC) assignment to the MPCD/AMPCD forces the opposite DC to be assigned to its corresponding DDI. The DCA switches function independent of the aircraft master mode. In RECCE configured aircraft, the sensor control switch (Aft position) commands manual record, opens/closes manual event marks, opens /closes review marks in video review mode, and freezes/scrolls imagery in video review mode.

INDEPENDENT REAR COCKPIT

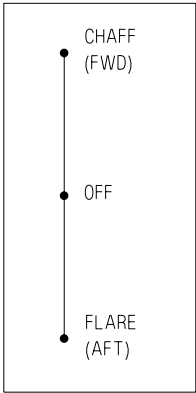
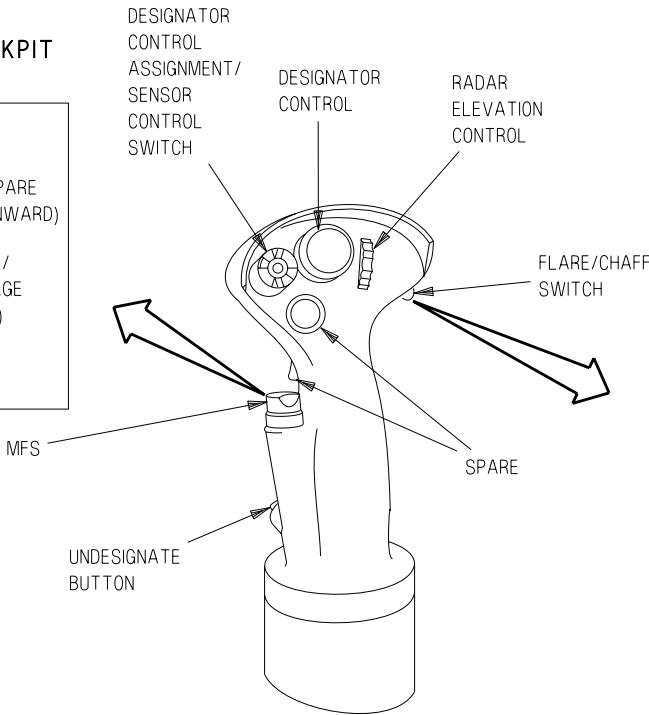
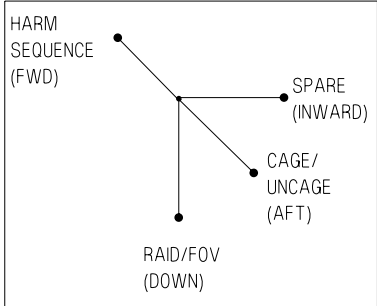

RIGHT HAND CONTROLLER

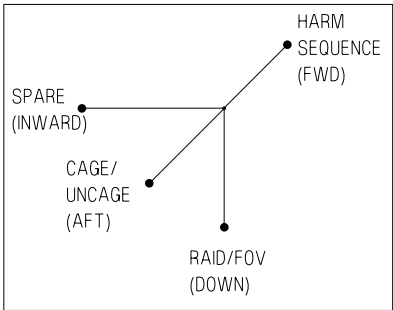
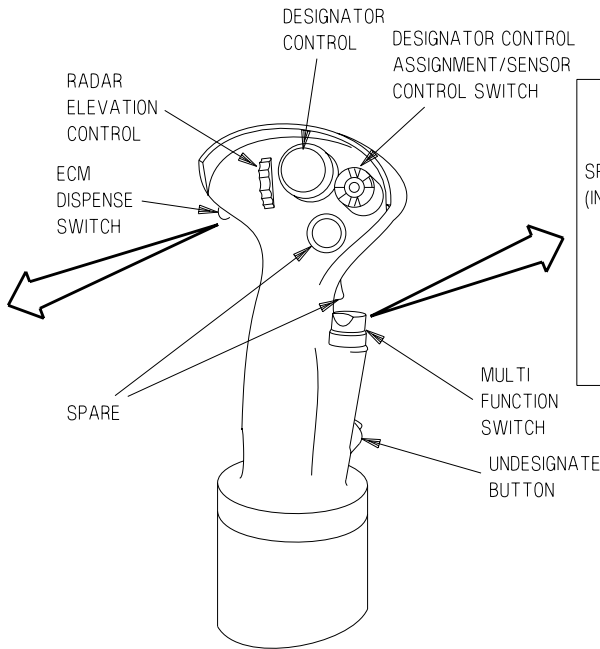
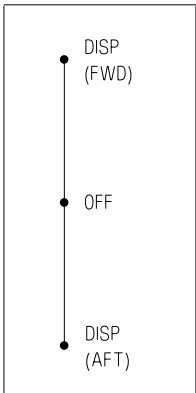

LEFT HAND CONTROLLER

ADA520-131-1-039

Figure 2-61. Hand Controllers (F/A-18D Aircraft 163986 AND UP)

2.22.9.23.2 Multifunction Switch (MFS). The switch is used for HARM sequence (forward), cage/uncage (aft), and raid/FOV (down). Refer to NTRP 3-22.4-FA18A-D and NTRP 3-22.2-FA18A-D for detailed operation.

2.22.9.23.3 TDC/DC Switch. In the aft cockpit, Designator Control (DC) priority is assigned to the DDI/MPCD/AMPCD. The MC initially assigns hand controller DC priority to left and right DDIs. The left DC (left hand controller) provides control of the format selected on either the left DDI or the MPCD/AMPCD. The right DC controller provides control of the format selected on either the right DDI or the MPCD/AMPCD. Right or left designator control of a format is based on the DC being assigned to the DDI/MPCD/AMPCD displaying a DC-compatible format, plus other logic as appropriate. MC inhibits right/left hand controller DC of the HUD format in the night attack aft cockpit.

Only one hand controller DC may be used to designate at a time, however both may be used simultaneously. TDC/DCs may be assigned to the same format in the front and rear cockpits; however, only one TDC/DC is processed at a time. When forward and aft TDC/DCs are assigned to the same format, both TDC/DCs must be within the deadband before a TDC/DC can become active. If a second TDC/DC is pressed out of deadband while the other TDC/DC is active, the second TDC/DC input is ignored. This also applies to the slew function.

The DC assignment diamond is flashed in the upper right corner of a format when a TDC/DC is assigned to the same format in both the forward and aft cockpits, and the MC is inhibiting one or both of the TDC/DCs from acting on the format because both TDC/DCs are pressed concurrently. SLEW is flashed if the above conditions are met for forward and aft DCs assigned to the same slew function.

In RECCE configured aircraft, the DC slews the MAG marker and roam magnified/unmagnified imagery, and expands/unexpands imagery.

2.22.9.23.4 Radar Elevation Control. The Radar Elevation Control (REC) switch is read by the DDI, provided to the MC, and passed to the radar as a radar elevation rate command. The radar processes the command and moves the radar antenna accordingly. The MC processes the hand controller RECs identically to the REC on the throttle in the forward cockpit. The MC processes only one REC at a time. All RECs must be within deadband before a REC can become active. If a second REC is selected while another REC is active, the second input is ignored.

2.22.9.23.5 Undesignate Button. The undesignate button is read by a DDI and passed to the MC. The front cockpit undesignate button is read by the FCS and passed to the MC. The switches function identically except for HI-NWS situation with WOW. Since the front undesignate button is read and processed directly by the FCS, special case MC processing is not required.

2.22.9.23.6 Chaff/Flare/ECM Switch. The chaff/flare switch is wired directly to the ALE-39/ALE-47 chaff/flare set. Moving the right handcontroller chaff/flare switch forward causes a single chaff bundle to be dispensed. Moving the switch aft dispenses a single flare. Moving the left handcontroller ECM switch performs the countermeasures program dispense function in parallel with the dispense switches on the grab handle and the canopy sill DISP switch.

2.22.9.23.7 Push-to-Talk Foot Pedal Switches (F/A-18D night attack configured AIRCRAFT 163986 AND UP). Comm 1 transmission is initiated by pressing the left foot pedal switch, Comm 2 transmission is initiated by pressing the right foot pedal switch. With AFC 270, the left foot pedal switch controls Comm 1 and MIDS A, and the right foot pedal switch controls Comm 2 and MIDS B.

2.22.9.24 RECCE Control Panel. ATARS power is controlled via the ATARS ON/OFF switch. Power for the data link pod is controlled by the Center-Line Pod (CLP) rotary knob which has the following three positions:

- OFF The DL portion of the pod is not powered.
- STBY Power is applied to the pod. DL transmissions are attenuated.
- OPR Power is applied to pod. Full DL transmission is available.

2.22.9.25 Canopy Sill DISP Switch. On Aircraft 163986 AND UP, two additional chaff/flare switches are located on either side of the grab handle. Each is a three-position momentary switch spring loaded to the center position and is designed to be thumb actuated while grasping the hand hold and looking aft. Each upward actuation of either switch commands a single chaff bundle to be dispensed. Each downward actuation of either switch commands a single flare to be dispensed.

2.22.9.26 ALE-39 Programmer. The ALE-39 programmer is installed on the rear cockpit left console. The programmer controls are normally preset by the ground crew. Refer to AN/ALE-39/ALE-47 Countermeasures Dispensing Set in NTRP 3-22.2-FA18A-D for description of the programmer control functions.

2.22.9.27 PTT Comm Select Panel. On MIDS equipped night attack aircraft, the PTT COMM select panel is on the left console forward of the volume control panel. Three comm options are available: two Comm channels, two MIDS channels, or one Comm and one MIDS channel. The switch position determines push-to-talk foot pedal switch comm or MIDS operation.

2.22.9.28 Volume Control Panel. The volume controls (TCN, ICS, ECM, WPN, RWR, and after AFC 270 , VOX, MIDS A and B), on the volume control panel, provide the same functions for the rear cockpit headset as the corresponding volume controls on the front cockpit intercommunication panel provide for the front cockpit headset. The VOX control incorporates the hot and cold microphone switch functions that enables/disables cockpit microphone for intercom transmission in the cockpit where selected. The SAM volume control on aircraft 161354 THRU 161357 AND 161360 or the AUX volume control on aircraft 161704 AND UP are not used at the present time.

2.22.9.29 Azimuth Indicator. The azimuth indicator presents the same information as the front cockpit azimuth indicator.

2.22.9.30 Emergency Jettison Button. The emergency jettison button is at the top of the instrument panel outboard of the left FIRE light. The BIT advisory and an SMS BIT status of DGD is the only enunciated indication of a stuck emergency jettison button.

2.22.9.31 Nuclear Consent Control Panel (Aircraft 163986 THRU 164738). The nuclear consent control panel is located on the right console forward of the right hand controller. The panel contains the PREAMM CONSENT switch and the RELEASE CONSENT switch. See A1-F18AC-TAC-series or A1-F18AE-TAC series for switch function description.

CHAPTER 3

Service and Handling

3.1 SERVICING

Refer to A1-F18AC-NFM-600.

CHAPTER 4

Operating Limitations

4.1 AIRCRAFT

4.1.1 Engine Limitations.

4.1.1.1 RPM.

Compressor (N_2)

- The maximum rpm is 102 %.
- Ground idle is:

F404-GE-400	F404-GE-402
61 to 72 %	63 to 70 %
- Flight idle is 68 to 73 %.
- Maximum fluctuation at stabilized power is ± 1 %.

Fan (N_1)

- The maximum rpm is:

F404-GE-400	F404-GE-402
106 %	108 %
- Maximum fluctuation at stabilized power is ± 0.5 %.

4.1.1.2 EGT.

- Maximum steady-state is:

	F404-GE-400	F404-GE-402
MIL	830 °C	880 °C
MAX	830 °C	920 °C
- Maximum transient is:

	F404-GE-400	F404-GE-402
Start	815 °C	815 °C
MIL	852 °C	902 °C
MAX	852 °C	942 °C

- Maximum fluctuation at stabilized power is ± 8 °C.

4.1.1.3 Nozzles.

Maximum fluctuation is ± 3 %.

4.1.1.4 Oil Pressure.**NOTE**

For fuel temperatures in excess of 38°C, the lower oil pressure limit can decrease as much as 10 psi.

Ground

1. For ambient temperatures above -18°C (0°F), oil pressure must peak below 180 psi and start to decrease within 30 seconds after reaching idle rpm and continue to decrease to steady state limits.
2. For ambient temperatures below -18°C (0°F), maximum oil pressure 2.5 minutes after start is 180 psi.
3. Steady state ground idle oil pressure (warm oil) limit is 45 to 110 psi.

Inflight

During steady state flight, oil pressure limits are as follows:

IDLE	55 to 110 psi
MIL	95 to 180 psi

4.1.2 Airspeed Limitations. The approximate maximum permissible airspeeds in smooth or moderately turbulent air with the arresting hook and landing gear retracted, flaps in AUTO, and any combination of air-to-air missiles are shown in figure 4-1. For exact airspeed limitations, refer to the NTRP 3-22.4-FA18A-D NATIP, Store Carriage and Release Limitations Chapter. Refer to Systems Limitations, figure 4-2, for additional airspeed limitations.

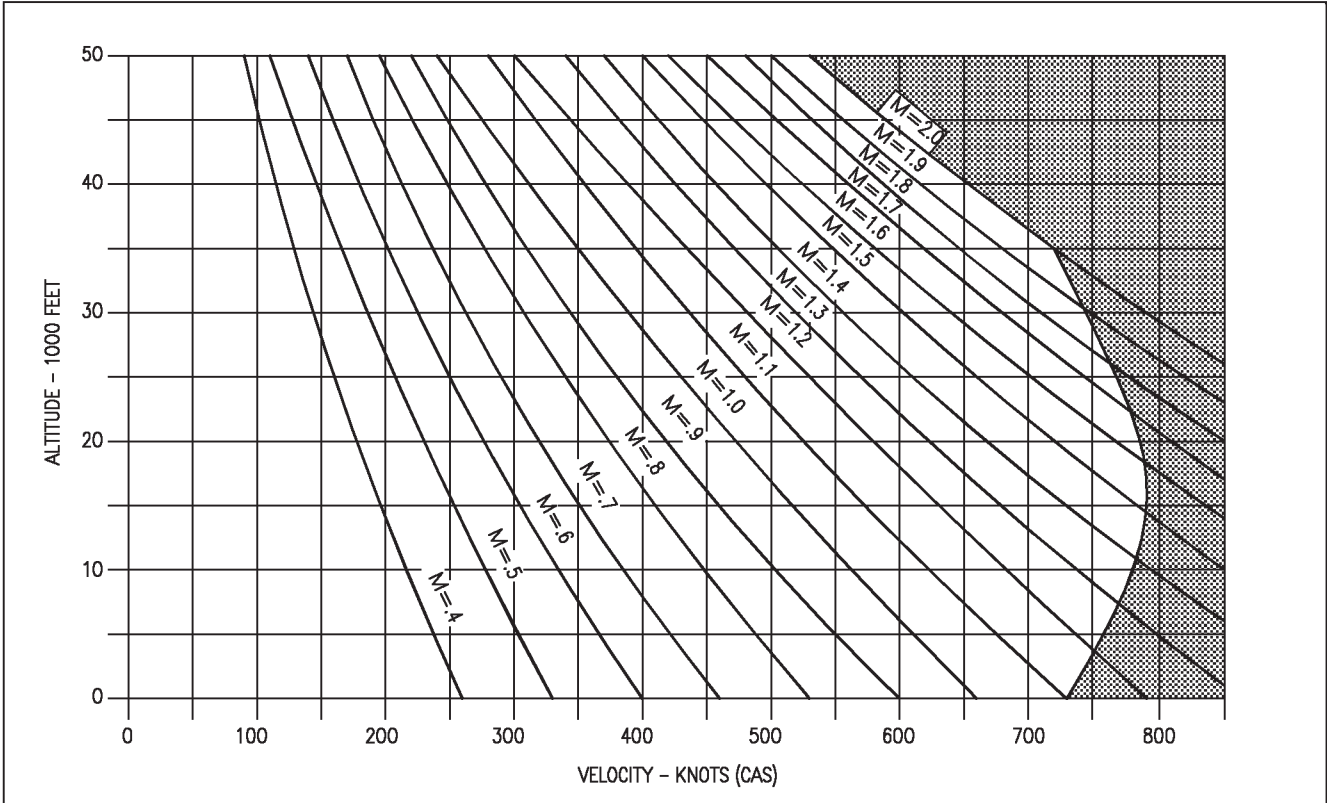

18AC-NFM-00-(39-1)31-CATI

Figure 4-1. Airspeed Limitations

Subsystem	Position/Action	Airspeed/Groundspeed
REFUELING PROBE	Extension/Retraction	300 Knots
	Extended	400 Knots
LANDING GEAR	Extension/Retraction/Extended	250 Knots
TIRES	Nose Gear	190 Knots groundspeed
	Main gear	210 Knots groundspeed
TRAILING EDGE FLAPS	HALF/FULL	250 Knots
CANOPY	Open	60 Knots

Figure 4-2. System Limitations

4.1.3 Prohibited Maneuvers.

4.1.3.1 General.

- 1. Takeoff with any CAS axis failed.

2. Zero airspeed tailslide.
3. Intentional departures/spins.
4. Flight in lightning or thunderstorms.
5. Flight with yaw rate warning tone.
- 6. Full or partial lateral stick and/or rudder pedal input over 360° yaw/roll.
7. Dive over 45° with less than 1,900 pounds fuel.
8. Zero g except transient.
9. Negative g for more than 5 seconds for aircraft 161353 THRU 161924 BEFORE AFC 053 (10 seconds for other aircraft).
10. Negative g
 - a. Roll maneuvers over 180° bank angle change.
 - b. Over 1/2 lateral stick above 635 KCAS below 20,000 feet MSL.
11. For aircraft 161353 THRU 161924 BEFORE AFC 018 and 053, less than 1 minute between negative g maneuvers (10 seconds for all other aircraft).
12. For aircraft 161353 THRU 161924, afterburner operation at less than +0.1 g.
13. Pulling any FCS circuit breaker in flight except as directed in NATOPS.
14. Selection of GAIN ORIDE above 350 knots/Mach 1.0 or above 10° AOA.
15. Inflight selection of RCVY on the spin recovery switch except for actual spin recovery or as directed in NATOPS.
16. Flight without LAU-7A wing tip launcher rails (with power supply and nitrogen bottle installed).
17. Takeoff or flared landing with 90° crosswind component over 30 knots. Normal or section landing with 90° crosswind component over 15 knots.
18. Section takeoff with any of the following conditions:
 - a. Crosswind over 15 knots.
 - b. Asymmetric load over 9,000 foot-pounds not including missiles or pods on stations 1 or 9.
 - c. Dissimilar loading except VERS, MERS, TERS, pylons, FLIR, LDT, fuselage AIM-7s/ AIM-120s or wing tip mounted stores.
19. Landing with autopilot engaged except for Mode 1 ACL.
20. Use of RALT hold below 500 feet AGL.

21. Negative 1g above 700 KCAS and below 10,000 feet MSL.
22. Supersonic flight
 - a. At or above Mach 1.4
 - (1) Roll maneuvers exceeding
 - (a) 2 g load factor, or
 - (b) 1/2 lateral stick, or
 - (c) 180° bank angle
 - (2) Throttles during dive pull
 - (a) not over MIL
 - b. Single seat
 - (1) Above Mach 1.8 with a centerline tank and no external wing tanks
 - (2) Above Mach 1.6/635 KCAS with an external wing tank
 - c. Two seat
 - (1) Above Mach 1.8 without external tanks
 - (2) Above Mach 1.6 with a centerline tank and no external tanks
 - (3) Above Mach 1.6/635 KCAS with an external wing tank
23. External fuel tank CV operations
 - a. Catapults with partially full external fuel tanks between 100 pounds and 1,900 pounds.
 - b. Landing at CV with greater than 500 pounds in centerline tank.

4.1.3.2 Flaps Half or Full.

1. Bank angle -
 - a. Fighter Escort (FE) configuration - over 90°
 - b. FE configuration with centerline tank/stores - over 60°
 - c. All other configurations - over 45°
2. Cross control inputs above 150 knots with flaps FULL.

4.1.4 CG Limitations.

1. The forward CG limit is 17 % MAC.

NOTE

Maximum thrust field takeoffs are permissible at CG location forward to 16 % subject to air density restrictions.

2. Aft CG limit -
 - a. FE configuration: 28 % MAC
 - b. All other configurations: 27-28 % MAC (Refer to AOA limitations)

4.1.5 Lateral Weight Asymmetry Limitations.

1. For field takeoff, the maximum asymmetric load is 22,000 ft-lbs.
2. For catapult launches, with a weight board of 36,000 lbs and below, the maximum asymmetric load is 6,000 ft-lbs. For catapult launches, with a weight board of 37,000 lbs and above, the maximum asymmetric load is 22,000 ft-lbs. Pilots are responsible for ensuring that asymmetry is within allowable limits for their aircraft gross weight.
3. For inflight conditions, the maximum authorized asymmetric load is 26,000 ft-lbs.

WARNING

Asymmetric release or jettison from stations 2 or 8 of stores weighing in excess of 2,320 lbs can exceed the lateral weight asymmetry limit without either deviation from the normal SMS release sequence or loading of other wing stations to counterbalance the moment generated by the first release. Exceeding lateral weight asymmetry limits can lead to a departure from controlled flight which may be unrecoverable or have an extended recovery period.

4. For FCLP or carrier landings, the maximum asymmetric load (including wingtip AIM-9 and wing fuel) is 17,000 ft-lbs for gross weights of 33,000 lbs or less.

For carrier landings, the maximum asymmetric load (including wingtip AIM-9 and wing fuel) is 14,500 ft-lbs for gross weights greater than 33,000 lbs.

5. For field landing (flared), with sink rate at touchdown up to 500 fpm, the maximum asymmetric load is 26,000 ft-lbs.

NOTE

For landing only, due to the landing gear structural limitations, internal wing fuel and tip missile lateral asymmetry must be used to calculate total lateral weight asymmetry.

4.1.6 Angle-of-Attack (AOA) Limitations.

4.1.6.1 Flaps Auto. With flaps AUTO, AOA limits depend upon aircraft store configuration, CG, lateral asymmetry and Mach number. A lateral asymmetry of 0 to 6,000 foot-pounds (excluding weight of asymmetric tip missile and/or asymmetric internal wing fuel) is considered a symmetric configuration. From 6,001 ft-lbs to 8,000 ft-lbs lateral weight asymmetry, the aircraft is considered symmetric below 0.8 IMN and with restrictions on full deflection control inputs (see Lateral Weight Asymmetry AOA Limitations below). In any case where more than one symmetric or asymmetric limit may be considered applicable, or if any AOA limit is conflicting, the most restrictive limit shall be used.

For all aircraft not otherwise restricted, the following tables are the symmetric AOA limits for aircraft in the Fighter Escort (FE) configuration (F/A-18 with/without: missiles/pods on store stations 1 and/or 9, missiles on store station 4 and/or 6, and FLIR, LDT, or for empty suspension equipment such as pylons and racks on stations 2, 3, 5, 7, and 8). Stores AOA limits are based on carriage of Air-to-Air stores (live or captive air-to-air missiles, or any store cleared for carriage on stations 1 and/or 9) or Air-to-Ground stores (all other stores cleared for carriage not encompassed by the Air-to-Air stores list or external tanks on stations 3, 5, or 7). For carriage of mixed stores, the most restrictive limit shall be used.

CONFIGURATION	CG (% MAC)	AOA LIMIT (°)
FE with or without Air-to-Air stores:	17 % to 25 % >25 % to 28 %	Unrestricted -6° to +25°
a) with or without external fuel tanks in any combination on stations 3, 5, and 7;		
b) with any stores on station 5		
FE plus Air-to-Ground stores on stations 3 and/or 7 (without station 5 stores)	17 % to 24 % >24 % to 27.5 %	-6° to +35° -6° to +25°
FE plus Air-to-Ground stores on stations 2, 3, 7, and/or 8:		
a) with or without external fuel tanks in any combination on stations 3, 5, and 7;		
b) with any stores on station 5		
External fuel tanks on stations 2 and/or 8 (empty)	17 % to 27 %	-6° to +20°

4.1.6.1.1 Lateral Weight Asymmetry AOA Limitations. For all aircraft, the weight of an asymmetric tip missile and/or internal wing fuel asymmetry should not be used in calculating total weight asymmetry except for landing. Due to the landing gear structural limitations, internal wing fuel and/or tip missile lateral asymmetry must be used to calculate total weight asymmetry.

Asymmetry (ft-lbs) ¹	AOA Limit
0 to <6,000	Symmetric limits
6,000 to <8,000 ≤ 0.8 IMN ²	Symmetric limits
6,000 to <8,000 > 0.8 IMN ²	-6° to 20°
8,000 to <12,000 ²	-6° to 20°
12,000 to 26,000 ^{2,3}	-6° to 12°
For F/A-18B/D >0.9 IMN	
6,000 to 26,000 ^{2,3}	-6° to 12°

Notes:

- (1) The weight of an asymmetric tip missile and/or internal wing fuel asymmetry should not be used in calculating total weight asymmetry except for landing.
- (2) Full lateral stick inputs shall be centered prior to abrupt, full aft stick inputs.
- (3) For lateral weight asymmetry of 22K to 26K ft-lb:
 - (a) Abrupt lateral stick inputs are prohibited.
 - (b) Smooth inputs up to 1/2 stick for rolling maneuvers up to a maximum of 180° bank angle change are authorized.
 - (c) Rudder pedal inputs are authorized only as required to maintain balanced flight (Slip indicator ball centered).

4.1.6.2 Flaps Half or Full. The AOA limit is 0° to +15°.



During single engine operations at MIL or MAX, loss of lateral and directional control may occur above the following AOAs:

- Flaps FULL - 10° AOA
- Flaps HALF - 12° AOA

4.1.7 Weight Limitations. The maximum allowable gross weights are:

Location	Pounds
Field	
Takeoff	51,900
Landing (Flared)	39,000
FCLP/Touch-and-go/Barricade	
Before AFC 029	30,700
After AFC 029	33,000
Carrier	
Catapult	51,900
Landing	
Unrestricted	33,000
Restricted	34,000

Arrestments above 33,000 pounds are subject to the following restrictions:

- (1) Glideslope - 3.5° Maximum
- (2) Recovery head wind (RHW) -
 - (a) 40 knots minimum - Half flaps allowed
 - (b) Less than 40 knots - Full flaps only
- (3) Lateral weight asymmetry - 14,500 foot-pound maximum (external pylon stores, AIM-9 wing tips, and wing fuel)
- (4) No MOVLAS recovery

NOTE

The combination of arresting gear, glide slope, RHW, and the asymmetry limits listed above ensure landing stresses remain within tested landing gear strength safety margins.

4.1.8 Acceleration Limitations.

1. The permissible accelerations during landing gear extension or retraction and/or with the flaps HALF or FULL are +0.5 g to +2.0 g symmetrical, +0.5 g to +1.5 g unsymmetrical.
2. The maximum permissible accelerations in smooth air with the flaps AUTO are shown in figure 4-3. Avoid buffet at limit g when possible. In moderate turbulence, reduce deliberate accelerations 2.0 g below that shown in figure 4-3. Additional acceleration limits when carrying external stores are shown in the External Stores Limitation chart, figure 4-4, and in NTRP 3-22.4-FA18A-D NATIP, Store Carriage and Release Limitations Chapter.

4.2 EXTERNAL STORES

4.2.1 Limitations. Only the external stores shown in the External Stores Limitations chart, figure 4-4, and the Store Information table in the NTRP 3-22.4-FA18A-D NATIP, Store Carriage and Release Limitations Chapter, may be carried and released.

4.2.2 Banner Towing Limitations.

Airspeed	220 knots maximum
Maximum bank angle	40°
Use of speedbrake	No restrictions

4.2.3 Tow Banner Adapter Limitations.

Airspeed	400 knots maximum
Acceleration	4 g maximum

AIRCRAFT THRU 161924

BASIC AIRCRAFT WITH OR WITHOUT AIM-7 AND/OR AIM-9

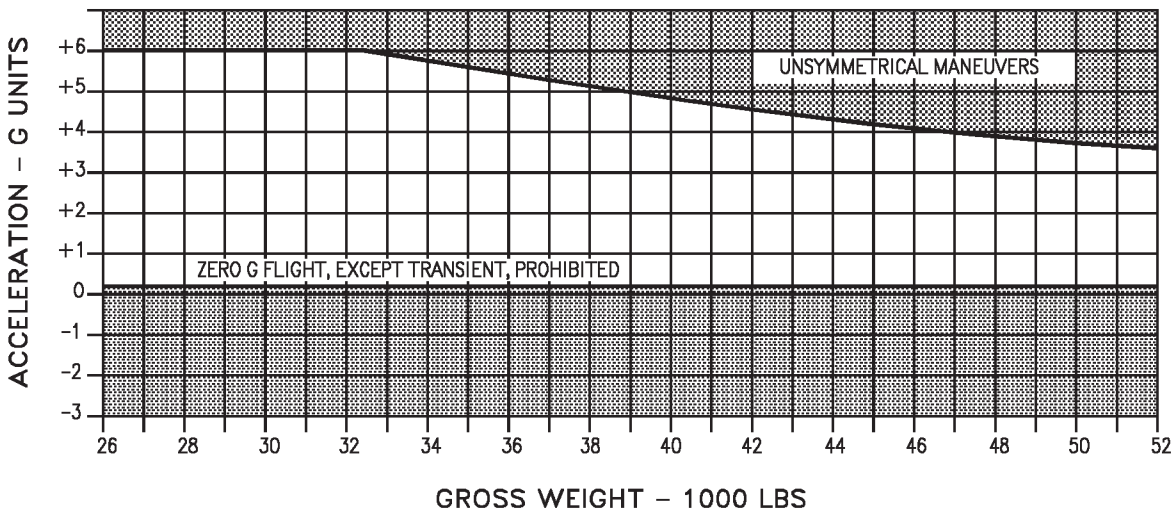
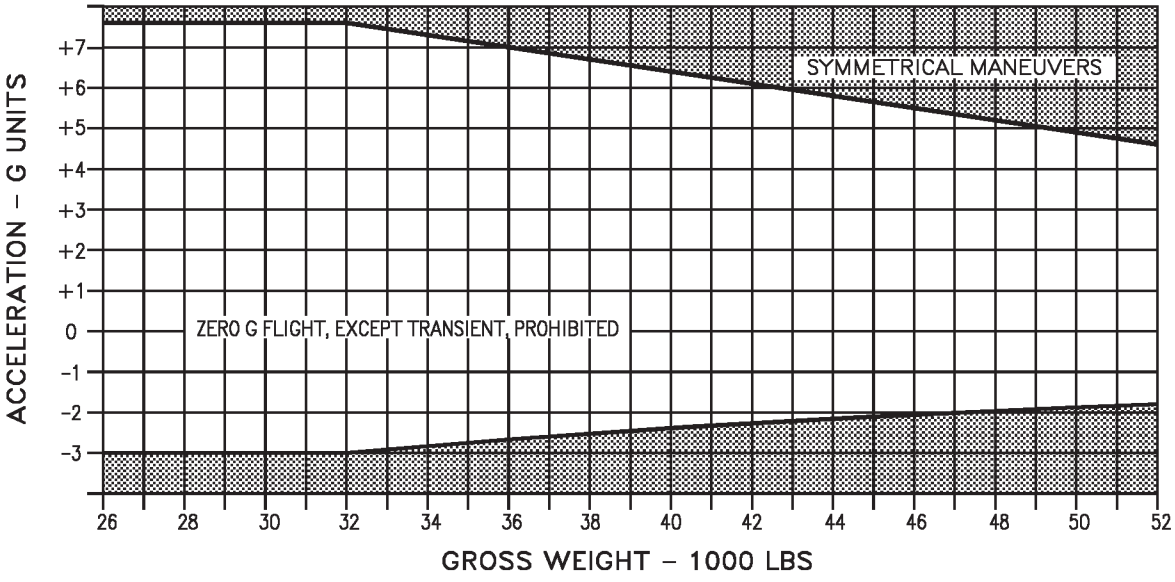

NOTES

- See External Stores limitations for additional G limitations
- With the G limiter operating normally (no G-LIM 7.5 G caution) the unsymmetrical maneuvers limit shown here is valid only for full lateral stick displacement.
- For aircraft with G limiter, G limiter overshoots up to 8.0 G (permitted by G limiter) do not constitute an overstress. Overstress inspection is not required unless MMP code 811 is set.

Figure 4-3. Acceleration Limitations (Sheet 1 of 2)

AIRCRAFT 161925 AND UP
BASIC AIRCRAFT WITH OR WITHOUT AIM-7 AND/OR AIM-9

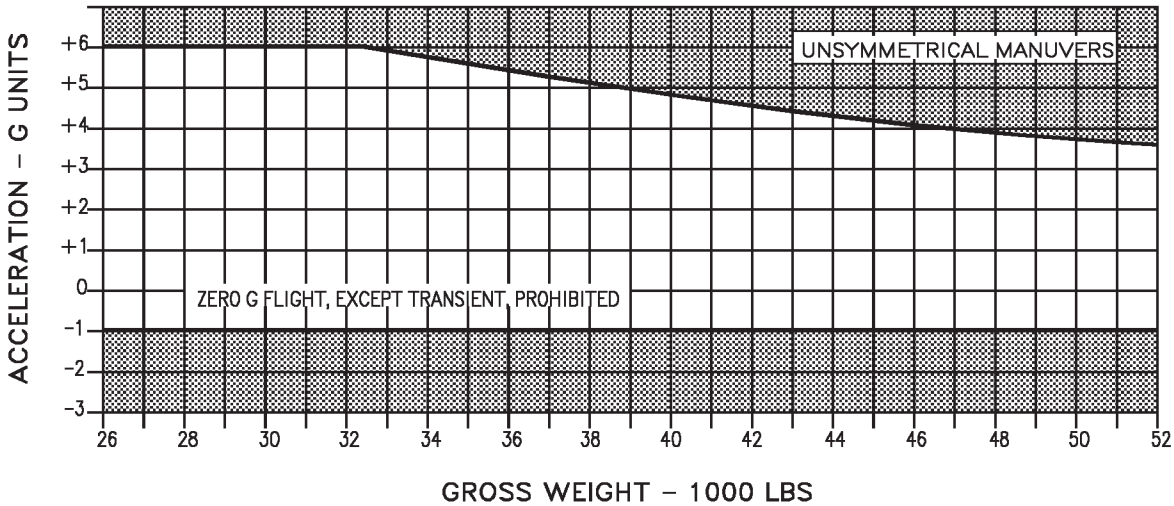
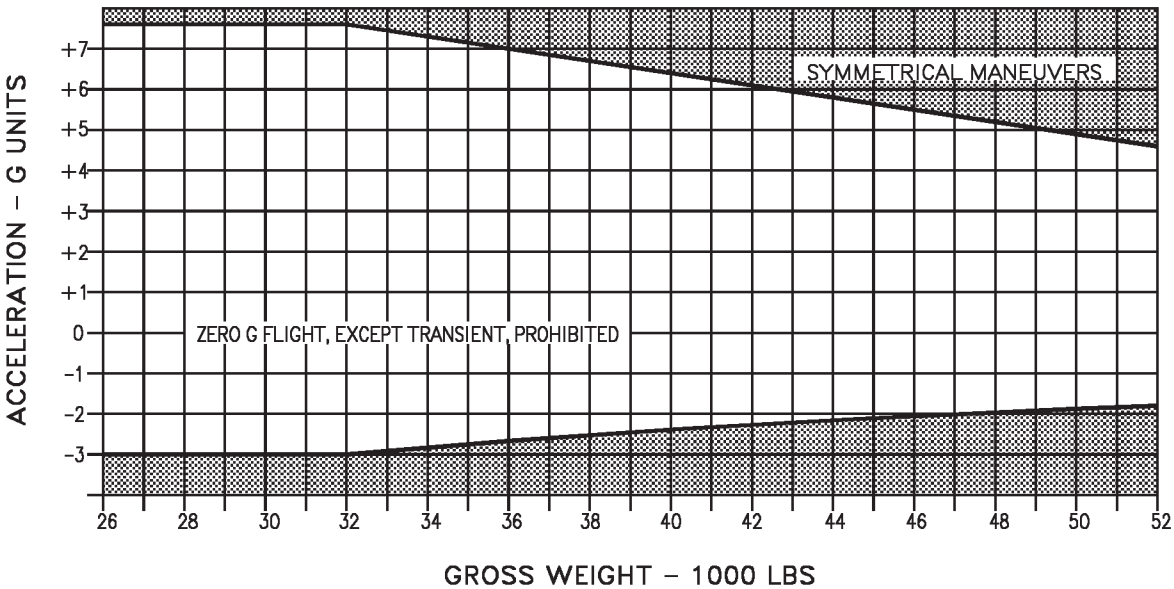

NOTES

- See External Stores Limitatons for additional G limitations.
- With the G limiter operating normally (no G-LIM 7.5 G caution), the unsymmetrical maneuvers limit shown here is valid only for full lateral stick displacement.
- For aircraft with G limiter, G limiter overshoots up to 8.0 G (permitted by G limiter) do not constitute an overstress. Overstress inspection is not required unless MMP code 811 is set.

Figure 4-3. Acceleration Limitations (Sheet 2 of 2)

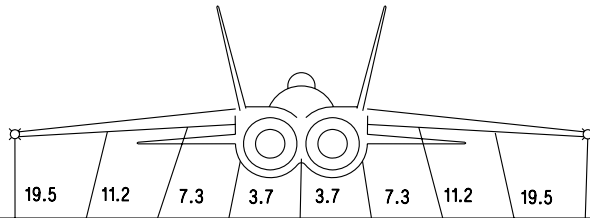

LBA - LIMIT BASIC AIRCRAFT

STORE	LINE NUMBER	DISTANCE FROM AIRCRAFT CENTERLINE-FT.									MAXIMUM KCAS OR IMN WHICHEVER IS LESS			ACCELERATION - G				ANGLE OF ATTACK LIMITS	CG LIMITS	CONFIGURATION WEIGHTS (LBS)	APPLICABLE NOTES	
		STATION LOADING AND SUSPENSION									CARRIAGE	JETTISON		CARRIAGE		JETTISON						
		1	2	3	4	5	6	7	8	9		EJECTED	AUX RELEASE	SYM	UNSYM	EJECTED	AUX RELEASE					
315/330 Gal. Fuel Tank	1										1.6	575/0.95	575/0.95	LBA	LBA	+1.0 TO +2.0	1.0 LEVEL	-6°/+25°	>25/28	E454/429 F2596/2673	1,2,5,6	
																		UNRES-TRICTED	17/25			
	2										635/1.6							-6°/+25°	25/28	E1194/1144 F5478/5632	3,4,6	
																			UNRES-TRICTED	17/25		
	3																		-6°/+25°	25/28	E1648/1573 F8074/8305	1,2,3,4,6
																			UNRES-TRICTED	17/25		

NOTES

- Carrier landing with more than 500 pounds in the centerline fuel tank is prohibited.
- Carriage of cylindrical tank on the centerline station is prohibited aboard carrier with non-flush deck catapults.
- For takeoff and landing with asymmetric loading refer to paragraph 4.1.5 Lateral Weight Asymmetry Limitations.
- Carrier landing is authorized with full or partially full external wing tanks. For landing with asymmetric loading refer to paragraph 4.1.5 Lateral Weight Asymmetry Limitations.
- Single seat aircraft carriage limit with a centerline tank and no external wing tanks is 1.8 Mach.
- Do not catapult with partially full external fuel tank(s) between 100 lbs and 1900 lbs of fuel.

Figure 4-4. External Stores Limitations

I-4-12

ORIGINAL

ADA520-42-1-058

A1-F18AC-NFM-000

PART II

INDOCTRINATION

Chapter 5 - Indoctrination

CHAPTER 5

Indoctrination

5.1 GROUND TRAINING SYLLABUS

5.1.1 Minimum Ground Training Syllabus. Initial ground training shall be conducted in accordance with the CNO approved syllabus. Follow-on ground training for each activity varies according to local conditions, field facilities, requirements from higher authority, and the immediate Unit Commander's estimate of squadron readiness.

5.2 FLIGHT TRAINING SYLLABUS TRAINING PHASES

Initial flight training, up to and including first solo, shall be conducted in accordance with the CNO approved syllabus. Follow-on flight training should include aircraft and weapon systems instruction, normal and emergency procedures, simulators (if available), open and closed book NATOPS tests, and evaluation of pilot performance. Local command requirements, squadron mission, and other factors influence the actual flight training syllabus and the sequence in which it is completed.

5.3 PERSONAL FLYING EQUIPMENT

5.3.1 Minimum Requirements. Refer to OPNAVINST 3710.7, for all standard flying equipment to be worn on every flight. All survival equipment must be secured in such a manner that it is easily accessible and will not be lost during ejection or landing. This equipment shall be the latest available as authorized by Aircrew Personal Protective Equipment Manual (NAVAIR 13-1-6).

5.4 QUALIFICATIONS AND CURRENCY REQUIREMENTS

5.4.1 Minimum Flight Qualifications. Minimum flight hour requirements to maintain qualification or reestablish qualification after initial qualification in each specific phase shall be established by the Unit Commanding Officer. Aircrew currently qualified in E-F series can gain initial A-D qualification with 5 hours and two takeoffs/landings in A-D series within the last 90 days. Pilots who have more than 45 hours in model are considered current subject to the following criteria:

1. Must have a NATOPS evaluation check with the grade of Conditionally Qualified, or better, within the past 12 months and must have flown 5 hours in model and made two takeoffs and landings within the last 90 days.
2. Must have satisfactorily completed the ground phase of the NATOPS evaluation check, including COT/WST emergency procedures check (if available), and be considered qualified by the Commanding Officer of the unit having custody of the aircraft.

5.4.2 Requirements For Various Flight Phases.

5.4.2.1 Solo. Not less than 5 hours first pilot time in model.

5.4.2.2 Initial NATOPS Qualification. Not less than 10 hours in model.

5.4.2.3 Night. Not less than 10 hours in model.

5.4.2.4 Cross Country.

1. Have a minimum of 15 hours in model.
2. Have a valid instrument card.
3. Have completed at least one night familiarization flight.

5.4.2.5 Carrier Qualification. Have a minimum of 50 hours in A-D series (15 hours in A-D series with a current NATOPS in Type/Model, and FA-18 CAT1 or CAT2 transition syllabus complete), and meet the requirements set forth in the LSO NATOPS manual.

5.4.3 Ceiling/Visibility Requirements. Prior to the pilot becoming instrument qualified in the aircraft, field ceiling/visibility and operating area weather must be adequate for the entire flight to be conducted in a clear air mass according to Visual Flight Rules. After the pilot becomes instrument qualified, the following weather criteria apply:

TIME IN MODEL (HR)	CEILING (Ft)/VISIBILITY (Mi)
10 to 20	800/2; 900/1-1/2; 1000/1
20 to 45	500/3; 600/2; 700/1
Over 45	Field minimums or 200/1/2 whichever is higher

Where adherence to these minimums unduly hampers pilot training, Commanding Officers may waive time-in-model requirements for actual instrument flight, provided pilots meet the following criteria:

1. Have a minimum of 10 hours in model
2. Completed two simulated instrument sorties
3. Completed two satisfactory tacan penetrations.

Weather minimums for a replacement pilot (RP) with an instructor pilot (IP) in the rear seat of an F/A-18B/D aircraft are 300 feet/1 mile for takeoff and landing. If the RP has over 45 hours in model, field minimums or 200 feet/ 1/2 mile, whichever is higher, will apply.

5.4.4 Ferry Squadrons. Training requirements, check-out procedures, evaluation procedures, and weather minima for ferry squadrons are governed by the provisions contained in OPNAVINST 3710.6.

5.5 WAIVERS

5.5.1 Unit Commanders Authority. Unit commanders are authorized to waive, in writing, minimum flight and/or training requirements in accordance with OPNAVINST 3710.7 (Series).

PART III

NORMAL PROCEDURES

Chapter 6 - Flight Preparation

Chapter 7 - Shore-Based Procedures

Chapter 8 - Carrier-Based Procedures

Chapter 9 - Special Procedures

Chapter 10 - Functional Checkflight Procedures

CHAPTER 6

Flight Preparation

6.1 MISSION PLANNING

6.1.1 General. The pilot shall be responsible for the preparation of required charts, flight logs, navigation computations including fuel planning, checking weather and NOTAMS, and for filing required flight plans. Refer to Part XI, Performance Data, to determine fuel consumption, correct airspeed, power settings, and optimum altitude for the intended flight mission. Planned minimum on deck fuel should not be less than 1,500 lbs. Planning data for specialized missions is contained in the NTRP 3-22.4-FA18A-D and NTRP 3-22.2-FA18A-D NATIP.

6.1.2 Flight Codes. The proper kind of flight classification and codes to be assigned individual flights are established by OPNAVINST 3710.7.

6.2 BRIEFING/DEBRIEFING

6.2.1 Briefing. The flight leader is responsible for briefing all flight members on all aspects of the mission to be flown. A briefing guide or syllabus card, as appropriate, is to be used in conducting the briefing. Each flight member shall maintain a kneepad and record all flight numbers, call signs, and all other data necessary to assume the lead and complete the assignment. However, this does not relieve the flight leader of the responsibility for briefing all flight members in the operation and conduct of the flight. The briefing guide includes the following:

6.2.1.1 General Mission Briefing Guide.

Assignments

- Aircraft assigned, call sign, and deck spot when appropriate
- Engine start, taxi, and takeoff times
- Visual signals and rendezvous instructions

Mission

- Primary
- Secondary
- Operating area
- Control agency
- Time on station or over target

Weapons

- Loading
- Safety
- Arming, dearming
- Duds
- Special routes with ordnance aboard
- Minimum pull-out altitude

Jettison area

Communications

Frequencies
Radio procedure and discipline
Navigational aids
Identification and ADIZ procedures

Weather

Local area
Local area and destination forecast
Weather at alternate
High altitude weather for the jet stream, temperature, and contrail band width

Navigation and Flight Planning

Takeoff speed
Takeoff distance
Abort distance
Crosswind effects
Climb out
Mission route, including ground controlling agencies
Fuel/oxygen management
Marshal
Penetration
GCA or CCA
Recovery

Emergencies

Aborts
Divert fields
Bingo and low state fuel
Waveoff pattern
Ready deck
Radio failure
Loss of visual contact with flight
Ejection
SAR procedures
System failures
Air Intelligence and Special Instructions
Friendly and enemy force disposition
Current situation
Targets
Safety precautions
ECM and ECCM

6.2.1.2 Operating Area Briefings. Prior to air operations in and around a new area, it is mandatory that a comprehensive area briefing be given including, but not limited to, the following:

Bingo Fields

- Instrument approach facilities
- Runway length and arresting gear
- Terrain and obstructions

Emergency Fields

- Fields suitable for landing but without required support equipment
- Include information under Bingo fields

SAR Facilities

- Type
- Frequencies
- Locations

6.2.2 Debriefing. Postflight debriefing is an integral part of every flight. The flight leader should review the entire flight from takeoff to landing, including not only errors and poor techniques, but also the methods of correcting them. Also, the flight leader shall cover any deviations from standard operating procedures.

CHAPTER 7

Shore-Based Procedures

7.1 PREFLIGHT CHECK

7.1.1 Line Operations. The yellow sheet must be checked for flight status, configuration, armament loading, and servicing prior to manning the aircraft. At least the 10 previous B sections should be reviewed for discrepancies and corrective action. Weight and Balance clearance is the responsibility of the maintenance department.

7.1.2 Exterior Inspection. The exterior inspection is divided into 24 areas. The inspection begins at the left fuselage and continues around the aircraft in a clockwise direction. Check doors secure and be alert for loose fasteners, cracks, dents, leaks, and other general discrepancies.

1. Nose landing gear
 - a. Drag brace/fairing - CHECK CONDITION
 - b. Drag brace ground safety pin - REMOVED
 - c. Holdback fitting - CHECK CONDITION
 - d. Tires and wheels - CHECK CONDITION
 - e. Tire pressure - 150 psi (ashore) 375 psi (afloat) (gauges on some aircraft)
 - f. Ensure key washer not in direct contact with wheel hub.
 - g. Strut piston chrome exposed - 3 TO 4 INCHES
 - h. Launch bar - CHECK CONDITION
 - i. Nosewheel steering assembly - CHECK CONDITION
 - j. Tiedown rings (2) - CHECK FOLDED AGAINST STRUT
 - k. Taxi and approach lights - CHECK CONDITION
 - l. Strut pressure gauges (2) - CHECK vs. Strut Servicing Plate
 - m. Retract actuator - CHECK CONDITION
 - n. Strut - CHECK CONDITION
2. Nose wheelwell - CHECK
 - a. Emergency brake accumulator pressure - CHECK (2,600 psi minimum)
 - b. Digital display indicator - NO FLAGS

- c. APU emergency shutdown switch - NORMAL
 - d. Doors and linkages - CONDITION
 - e. BRCU - CYCLE (if applicable)
3. Nose section (left side) - CHECK
- a. Gun - PREFLIGHT
 - b. U BATT/E BATT circuit breakers - CHECK
 - c. Pitot static probe - CONDITION
 - d. Pitot static drains (5) - CLOSED
 - e. AOA probe - CHECK CONDITION
 - (1) Smooth, concentric rotation through the full range of travel to include while gently pulling and pushing the AOA probe.
 - (2) No bends, dents, dings, or other surface discrepancies.
 - f. Forward UHF antenna - CONDITION
 - g. Radome - SECURE (2 points)
4. Nose section (top) - CHECK
- a. Gun blast diffuser and gun port - CLEAR
5. Nose section (right side) - CHECK
- a. Radome - SECURE (2 points)
 - b. AOA probe - CHECK CONDITION
 - (1) Smooth, concentric rotation through the full range of travel to include while gently pulling and pushing the AOA probe.
 - (2) No bends, dents, dings, or other surface discrepancies.
 - c. Pitot static probe - CONDITION
 - d. Refueling receptacle cover - INSTALLED (Door 8R)
6. Right fuselage - CHECK
- a. SMS processor/SMUG - CHECK codes, Door 14R closed/secure
 - b. Aft UHF antenna - CONDITION
 - c. Engine intake duct - CLEAR

- d. ECS intake - CLEAR
 - e. Chaff/flare dispenser - PREFLIGHT
(Dispenser module (chaff/flare bucket) or access cover shall be installed.)
7. External fuel tank - PREFLIGHT
- a. Refuel cap - DOWN, LOCKED, ARROW FORWARD
 - b. Precheck valve - DOWN, FLUSH, ARROW UP
8. AIM-7, AIM-120, LDT/SCAM, or NAVFLIR - PREFLIGHT
9. Fuel air heat exchanger intake - CLEAR AND CONDITION
10. Right main wheelwell - CHECK
- a. Doors and linkages - CONDITION
 - b. APU accumulator - PRESSURE, TEMPERATURE, PISTON POSITION
 - c. Landing gear downlock and retract actuators - CONDITION
 - d. Downlock pin - REMOVED
 - e. Hydraulic filter indicators - NOT POPPED
 - f. APU accumulator pump handle - CONDITION, SECURITY, PIN
 - g. Main fuel line clamps secure and safety wires attached.
11. Right main landing gear - CHECK
- a. Tire - TREAD WEAR, PRESSURE 250 psi (ashore) 350 psi (afloat) (gauges on some aircraft)
 - b. Brake wear indicator - CHECK
 - c. Shrink links and planing links - CONDITION
 - d. Shock strut pressure - CHECK
 - e. Tiedown rings and springs - CONDITION
12. Right wing - CHECK
- a. Leading edge flap - CHECK CONDITION
 - b. Pylons and external stores -
 - (1) Breech caps tight
 - (2) If applicable, cartridge installed indicator present (protruding from breech cap w/ext stores loaded)

- (3) Retainer clip in place and horizontal to the deck
 - (4) Auxiliary cap tight
 - c. Navigation lights - CONDITION
 - d. Wingfold area - CONDITION
 - e. Wingfold lugs - CONDITION
 - f. LAU-7 - Ensure doors secure, power supply installed, and either nitrogen bottle or HiPPAG installed.
 - g. AIM-9 - PREFLIGHT
 - h. Aileron - CONDITION, FAIRED WITH WINGS FOLDED
 - i. Trailing edge flap - CHECK CONDITION
13. Right aft fuselage - CHECK
- a. Hydraulic reservoir gauge - CHECK
 - b. Vertical stabilizer and rudder - CONDITION
 - (1) Navigation, formation, and strobe lights - CONDITION
 - (2) Fuel vent port and dump mast - CLEAR
 - c. Stabilator - CONDITION
 - d. Exhaust nozzle, afterburner section, turbine blades - CONDITION
14. Arresting hook area - CHECK
- a. Arresting hook - CONDITION (pin removed)
15. Left aft fuselage - CHECK
- a. Exhaust nozzle, afterburner section, turbine blades - CONDITION
 - b. Stabilator - CONDITION
 - c. Vertical stabilizer and rudder - CONDITION
 - (1) Fuel vent port and dump mast - CLEAR
 - (2) Formation and strobe lights - CONDITION
 - d. Hydraulic reservoir gauge - CHECK
16. Aft fuselage underside - CHECK

- a. APU intake and exhaust - CLEAR
 - b. ATS exhaust - CLEAR
17. Left wing - CHECK
- a. Trailing edge flap - CHECK CONDITION
 - b. Aileron - CONDITION, FAIRED WITH WINGS FOLDED
 - c. AIM-9 - PREFLIGHT
 - d. LAU-7 - Ensure doors secure, power supply installed, and either nitrogen bottle or HiPPAG installed.
 - e. Wingfold area - CONDITION
 - f. Wingfold lugs - CONDITION
 - g. Navigation lights - CONDITION
 - h. Pylons and external stores -
 - (1) Breech caps tight
 - (2) If applicable, cartridge installed indicator present (protruding from breech cap w/ext stores loaded)
 - (3) Retainer clip in place and horizontal to the deck
 - (4) Auxiliary cap tight
 - i. Leading edge flap - CHECK CONDITION
18. Left main landing gear - CHECK
- a. Tire - TREAD WEAR, PRESSURE 250 psi (ashore) 350 psi (afloat) (gauges on some aircraft)
 - b. Brake wear indicator - CHECK
 - c. Shrink links and planing links - CONDITION
 - d. Shock strut pressure - CHECK
 - e. Tiedown rings and springs - CONDITION
19. Left main wheelwell - CHECK
- a. Doors and linkages - CONDITION
 - b. Landing gear downlock and retract actuators - CONDITION
 - c. Downlock pin - REMOVED

- d. Hydraulic filter indicators - NOT POPPED
 - e. Main fuel line clamps secure and safety wires attached.
20. Fuel air heat exchanger intake - CLEAR AND CONDITION
21. Station 4 - PREFLIGHT
22. Chaff/flare dispenser - PREFLIGHT
(Dispenser module (chaff/flare bucket) or access cover shall be installed.)
23. Forward fuselage underside - CHECK
- a. Loose fasteners and fluid leaks - CHECK
 - b. Centerline station/store - PREFLIGHT
 - c. Fuselage fuel cavity drains - CHECK
24. Left fuselage - CHECK
- a. Engine intake duct - CLEAR
 - b. ECS intake - CLEAR
 - c. Total temperature probe - CONDITION
 - d. RLCS door - CHECK

7.1.3 Before Entering Cockpit

1. Boarding ladder - SECURE (2 points)
2. Aircraft upper surfaces - CONDITION
3. Windshield - SECURE
Push up on windshield bow to make sure the windshield is secure.
4. Canopy jettison rocket motors - Nozzles down (F/A-18A/C)
5. Ejection seat safe/arm handle - SAFE & LOCKED
6. Ejection seat - PREFLIGHT

SJU-5/6

- a. Ejection seat manual override handle - Check handle full down and manual override initiator maintenance pin removed from seat.
- b. Time release mechanism trip rod - Check time release mechanism trip rod secured to bulkhead and engaged in time release mechanism. Check red color band on trip rod not visible. Check maintenance pin removed from seat.

- c. Right trombone assembly - Hoses connected and retaining pin installed.
- d. Ballistic gas disconnect - Check engaged and red band not visible.
- e. Survival kit release handle - Check full down.
- f. Leg restraint lines - Check lines secured to cockpit floor, lines not twisted, and line pins locked into front of ejection seat.
- g. Ejection seat firing initiators - Check firing linkage connected to sears.
- h. Survival kit emergency oxygen - Check pressure gauge, emergency oxygen green ring stowed inboard of left thigh cushion, and automatic emergency oxygen operating cable lanyard connected to cockpit floor.
- i. Rocket motor initiator - Check initiator cable lanyard connected to drogue gun trip rod without excessive cable hanging from initiator housing. Initiator sear installed with cable lever assembly link inserted, maintenance pin removed from sear. Left trombone assembly connected with quick release pin inserted.
- j. Drogue gun trip rod - Check drogue gun trip rod secured to bulkhead and engaged in drogue gun with maintenance pin removed from sear. Check that red color band on trip rod is not visible.
- k. Top latch mechanism - Check that top latch plunger and locking indicator is flush with the end of the top latch mechanism housing and the main beam.

WARNING

If the top latch mechanism check does not meet the outlined requirements, the seat could come loose on the mounting rails.

- l. Catapult manifold assembly - Check hoses and manifold connected, and retaining pin installed.
- m. Scissor shackle tie-down - Check drogue withdrawal line connected to the drogue slug. Check forward flap on top of all other flaps and shackle tie routed through eyelet in top flap and routed through both drogue shackle and extender strap. Check scissor mechanism tied securely to top of parachute container. Check drogue shackle engaged in scissors, and scissors release plunger extended against moveable scissor arm with plunger pin visible on top of scissors plunger.
- n. Parachute risers - Check risers routed down forward face of the parachute container and routed behind retaining strap sensing-release secure and ease of operation, and seawater activated release system for proper installation.
- o. Radio beacon lanyard - Check lanyard secured to seat bucket.

- p. Check lap belts secure. Pull up strongly on each belt to make sure bolt fittings are engaged in seat. Check front end of survival kit secured to seat. Pull up on front end of kit to test security.



If any portion of the survival kit cushion is moved to gain access to components underneath, unsnap cushion retaining snaps by a forward/up motion (not back/aft) and resnap by an aft/down motion.

SJU-17 AND SJU-17A

- a. Ejection seat manual override handle - full down and locked.
- b. Right pitot - stowed.
- c. Ballistic gas quick-disconnect - connected indicator dowel flush or slightly protruding.
- d. Top latch plunger - Check that locking indicator is flush with the end of the top latch plunger.



If the top latch plunger check does not meet the outlined requirements, the seat could come loose on the mounting rails.

- e. Catapult manifold valve - Check hoses and manifold connected, and retaining pin installed.
- f. Parachute withdrawal line - connected, secure.
- g. Parachute container lid - secure.
- h. Left pitot - stowed.
- i. Electronic sequencer - expended unit indicator (EUI) not activated. (Black sequencer - OK, White - CHECK THERMAL BATTERIES NOT ACTIVATED).
- j. Thermal batteries - expended unit indicator (EUI) not activated. (White or pink - OK, Black or purple - expended)
- k. Oxy/comm lines - connected secured.
- l. Survival kit -
 - (1) Oxy/comm lines - connected, secure.
 - (2) Emergency oxygen gauge - black area.
 - (3) Radio beacon - secured.
- m. Radio beacon lanyard - Check lanyard secured to cockpit floor.
- n. Ensure that the lanyard and quick release connector are positioned forward of the underseat rocket motor tubes.

- o. Check lap belts secure. Pull up strongly on each belt to make sure bolt fittings are engaged in seat. Check front end of survival kit secured to seat. Pull up on front end of kit to test security.
- p. Negative g-strap - secure in seat bucket (SJU-17(V)1/A, 2/A, 9/A).
- q. Leg restraint lines - Check lines secured to cockpit floor, lines not twisted, and line pins locked into front of ejection seat.
- r. Ejection seat firing initiators - Check firing linkage connected to sears.
- s. Parachute risers - Check risers routed down forward face of the parachute container and routed behind retaining strap, sensing-release secure and ease of operation, and SEAWARS for proper installation.
- t. Backpad adjustment handle - Set to desired position (SJU-17A(V)1/A, 2/A, 9/A).

For solo flight in F/A-18B/D -

7. Rear cockpit - SECURED

- a. Check ejection seat SAFE/ARM handle in SAFE. █
- b. Ensure ejection seat handle pin is removed.
- c. Ensure CANOPY JETT handle - OUTBOARD AND DOWN/PIN REMOVED █
- d. Secure all loose items, including harnessing and JHMCS QDC. █
- e. Standby attitude reference indicator - CAGE/LOCK
- f. EMERG BRK handle - IN █

WARNING

Anti-skid is not available with the rear cockpit EMERG BRK handle in the emergency position.

8. SEAT CAUT MODE switch - SOLO/PIN INSTALLED █

7.1.4 Interior Check

CAUTION

Do not place any item on the glare shield, as scratching the windshield is probable.

1. Harness and rudder pedals - SECURE/ADJUST

Fasten and secure leg restraint garters and lines. One garter is worn on the thigh approximately 3 inches above the knee and one garter is worn on the lower leg just above the boot top. Check leg garters buckled and properly adjusted with hardware on inboard side of the legs. Check that lines are

secured to seat and floor and not twisted. Check that leg restraint lines are routed first through the thigh garter ring, then through the lower garter ring, and then routed outboard of the thigh garter ring before the lock pins are inserted into the seat just outboard of the snubber boxes. Connect oxygen, g suit, QDC (if applicable) and communications leads. Check routing of JHMCS UHVI does not interfere with oxygen hose. Check QDC is securely connected or stowed if not in use. Fasten and secure leg restraint garters and lines. Check leg garters buckled and properly adjusted with hardware on inboard side of the legs. Connect and adjust lap belt straps. Attach parachute Koch fittings to harness buckles. Check operation of shoulder harness locking mechanism.

WARNING

- The leg restraint lines must be buckled at all times during flight to ensure that the legs are pulled back upon ejection. This enhances seat stability and prevents leg injury by keeping the legs from flailing following ejection.
- Failure to route the restraint lines properly through the garters and properly position leg restraints could cause serious injury during ejection/emergency egress.
- The JHMCS UHVI must be properly routed through the torso bundle flue under the survival vest and the QDC secured in the QMB to ensure that no entanglement exists with the oxygen hose. Misrouting of the JHMCS UHVI may allow the QDC to rub against the oxygen hose disconnect causing unintentional oxygen/communications disconnect in flight.

2. Ejection control handle - CLEAR

Left console -

1. Circuit breakers (4) - IN
2. Manual canopy handle - STOWED
3. Nuclear weapon consent switch - AS DESIRED
4. MC and HYD ISOL switches - NORM

LOX Aircraft -

5. OXYGEN supply lever - OFF

OBOGS Aircraft -

5. OBOGS control switch - OFF
 - a. OXY FLOW knob - OFF

- b. OBOGS monitor pneumatic BIT plunger - VERIFY UNLOCKED AND FULLY EXTENDED

WARNING

Inadvertent rotation of the OBOGS monitor pneumatic BIT plunger while pressed can result in the locking of the plunger in a maintenance position and intermittent OBOGS DEGD cautions and lead to hypoxia. Rotation of the BIT plunger disengages the locking slot allowing the plunger to extend and move freely when pushed.

All Aircraft -

6. COMM 1/IFF ANT SEL switches - AUTO/BOTH
7. COMM panel - SET
 - a. Relay, cipher, squelch and guard - OFF
 - b. ILS - SET FREQUENCY/UFC
 - c. Master, mode 4, and crypto switches - NORM/OFF/NORM
8. VOL panel - SET AS DESIRED
9. GEN TIE CONTROL switch - NORM (guard down, aircraft 162394 AND UP)
10. FCS GAIN switch - NORM
11. PROBE switch - RETRACT
12. EXT TANKS switches - NORM
13. DUMP switch - OFF
14. INTR WING switch - NORM
15. EXT LT panel - SET
16. Throttles - OFF
17. PARK BRK handle - SET
18. LDG/TAXI LIGHT switch - OFF
19. ANTI SKID switch - ON
20. FLAP switch - FULL
21. SELECT JETT knob - SAFE
22. LDG GEAR handle - DN

23. Landing gear handle mechanical stop - FULLY ENGAGED

24. CANOPY JETT handle - FORWARD

Instrument panel -

1. MASTER ARM switch - SAFE

2. FIRE and APU FIRE warning lights - NOT PRESSED IN

If the light(s) is/are pressed, approximately 1/8 inch of yellow and black stripes are visible around the outer edges of the light(s).

3. L(R) DDI, HI/MPCD, and HUD knobs - OFF

4. Altitude source - SELECT

5. ATT switch - AUTO

6. COMM 1 and 2 knobs - OFF

7. ADF switch - OFF

8. ECM mode - OFF

9. Dispenser select knob/dispenser switch - OFF

10. AUX REL switch - NORM

11. Clock - CHECK AND SET

12. Standby attitude reference indicator - CAGE/LOCK

13. IR COOL switch - OFF

14. SPIN switch - GUARD DOWN/OFF

Right console -

1. Circuit breakers (4) - IN

2. HOOK handle - UP

3. WING FOLD handle - SAME AS WING POSITION

4. AV COOL or FCS COOL switch - NORM

5. Radar altimeter - OFF

6. GEN switches - NORM

7. BATT switch - OFF

8. ECS panel - SET

- a. MODE switch - AUTO
 - b. CABIN TEMP knob - 10 O'CLOCK
 - c. CABIN PRESS switch - NORM
 - d. BLEED AIR knob - NORM and DOWN
 - e. ENG ANTI ICE switch - OFF
 - f. PITOT ANTI ICE switch - AUTO
9. DEFOG handle - MID RANGE
 10. WINDSHIELD switch - OFF
 11. INTR LT panel - AS DESIRED
 12. Sensors - OFF
 13. KY-58 panel - SET
 14. AN/AWB-3(V) monitor control - SET
 15. NVG container - SECURE/NVG STOW (if required)

7.1.5 Engine Start. With an external power start, all electrical systems except those on external power switch 3 are operative. With a battery start, power is available to operate the APU and engine fire warning systems, the intercom system between the pilot and the ground, the cockpit utility light and EMI/IFEI.



For external air start, ensure that bleed air knob is OFF to avoid ATS damage.

When the engine crank switch is moved to L or R, the air turbine starter control valve (ATSCV) opens and the air turbine starter (ATS) rotates the engine thru the AMAD. Engine rotation is apparent almost immediately and can be seen on the tachometer. During operation below flight idle, the nozzles may go closed or oscillate. After the engine lights-off and accelerates to approximately 60 % rpm, the engine crank switch returns to OFF. After both generators are on the line, the APU runs for 1 minute, and then shuts down.

The right engine is normally started first to provide normal hydraulics to the brakes. Rapid stick movement with only the right engine running may cause the priority valve to cut off brake pressure.



- To prevent engine damage during start, if an engine was not idled for 5 minutes prior to shutdown and a restart must be made between 15

minutes and 4 hours after shutdown, the engine must be motored for 1 minute at 24 % N_2 .

- A flashing IFEI panel during engine start is indicative of a failing SDC or batteries that might not provide adequate power to the flight control computers in the event of dual generator failure. Further troubleshooting is required. Do not apply external power.

NOTE

To perform a valid battery status check, the check must be accomplished without ground power applied or either generator on line.

Aircraft 161353 THRU 161528 -

1. Battery operation - CHECK
 - a. Battery switch - ORIDE
 - b. BATT SW caution - CHECK DISPLAYED
 - c. Battery switch - ON (caution removed)

Aircraft 161702 AND UP -

1. Battery status - CHECK
 - a. Battery switch - ORIDE
 - b. E BATT voltage - CHECK
After battery switch in ORIDE for minimum of 5 seconds, check for minimum voltage of 23.5 volts.
 - c. Battery switch - ON
 - d. U BATT voltage - CHECK
After battery switch in ON for minimum of 5 seconds, check for minimum voltage of 23.5 volts.
With cold weather temperatures down to -18°C a minimum of 20.5 volts on the UBATT is acceptable.

With external electrical power -

1. EXT PWR switch - RESET
2. GND PWR switches 1, 2, and 4 - B ON (hold for 3 seconds)
3. L(R) DDI, HI/MPCD, and HUD - ON
4. COMM 1, 2, and ADF - AS DESIRED
5. Warning and caution lights - TEST
6. Inertial navigation system - ENTER WAYPOINTS DESIRED

All starts -

1. BATT switch - ON (if not previously ON)
2. FIRE warning test - PERFORM
 - a. FIRE test switch - TEST A (hold until all lights and aural warnings indicate test has been successfully passed)
 - b. FIRE test switch - NORM (pause 7 seconds or cycle BATT switch for system reset)
 - c. FIRE test switch - TEST B (hold until all lights and aural warnings indicate test has been successfully passed)

NOTE

- During a successful FIRE warning test, **ALL** of the following lights should illuminate in each TEST position: both FIRE lights (all 4 bulbs), the APU FIRE light (all 4 bulbs), and both L and R BLEED warning lights. Additionally, the following voice aural warnings should be heard in order: "Engine fire left, engine fire right, APU fire, bleed air left, bleed air right" (each repeated twice).
- A complete FIRE warning test is performed in each TEST position because it is difficult to recognize a single unlit bulb in a FIRE light. Since an aural warning does not annunciate if any of the FIRE or BALD loops are bad, lack of an aural warning is the best cue to the aircrew of a test failure.

If APU start -

3. APU ACC caution light - OFF
 - a. APU switch - ON (READY light within 30 seconds)
If fire or overheat condition is detected, the APU shuts down.



- To prevent running engagements during APU coast-down and to prevent APU exhaust torching, a minimum of 2 minutes must elapse between APU shutdown and another APU start.
- To preclude APU/ATS damage on aircraft 161353 THRU 163175 BEFORE IAYC 853, ensure generator switches are ON and bleed air aug is OFF.

If external air start -

3. BLEED AIR knob - OFF

All starts -

- 4. ENG CRANK switch - R

WARNING

Uncommanded stick motion during engine start is abnormal and aircraft shall not be flown prior to maintenance action.

CAUTION

Holding the engine crank switch in L or R may cause ATS damage. Shut down the APU only when engine crank switch is OFF. On aircraft 161353 THRU 163175 BEFORE IAYC 853, shutting down the APU while cranking the engine with the opposite engine running can cause APU surge.

- 5. Right throttle - IDLE (15 % rpm minimum)
Maximum EGT during start is 815°C.

NOTE

On aircraft 161353 THRU 162889, setting any ground power switches to ON with an engine driven generator on line activates a false MMP code 884 (ground power circuit fail).

- 6. GPWS Voice Alerts - CHECK (OFP 15C AND UP: "ROLL LEFT, ROLL LEFT") (OFP 13C: "ROLL OUT, ROLL OUT")

NOTE

In aircraft with MC OFP 13C AND UP, MC1 does an ACI configuration check after the generator comes online during a cold start power-up. Successful completion of the check is indicated by system initiation of a "ROLL OUT" (for OFP 13C) or "ROLL LEFT" (for 15C) voice alert. If no voice alert is heard, GPWS is disabled and the GPWS option on the MENU/HSI/DATA/AC sublevel display will not be present. If an incorrect voice alert is heard on startup or the GPWS option is not present, notify maintenance and commence troubleshooting the GPWS, ACI, and CSC system components and wiring.

All aircraft -

- 7. L(R) DDI, HI/MPCD, HUD, and UFC avionics, and radar altimeter - ON

WARNING

If the DDI or HI/MPCD do not come on, they may not be properly secured to the instrument panel. Do not launch with an improperly secured DDI or HI/MPCD.

CAUTION

If ATS caution is on when the DDI comes on, shut down engine to avoid starter damage.

8. HMD switch (if applicable) - ON
9. EMI/IFEI - CHECK
 - a. After engine start, it may be necessary to advance power above IDLE to get the ECS turbine started.

Ground idle -

	F404-GE-400	F404-GE-402
N ₂	61 to 72 %	63 to 70 %
EGT	190° to 590°C	190° to 590°C
Fuel flow	420 to 700 pph	420 to 900 pph
Nozzle	73 to 84 %	73 to 84 %
Oil pressure (warm oil)	45 to 110 psi	45 to 110 psi

NOTE

For fuel temperatures in excess of 38°, the lower oil pressure can vary as much as 10 psi.

If APU or crossbleed start -

10. BLEED AIR knob - CYCLE THRU OFF TO NORM

The bleed air shutoff valves close during the fire warning test and the BLEED AIR knob must be cycled thru OFF to NORM with ac power on to reset the valves.

11. Warning and caution lights - TEST

For a crossbleed start, ensure APU switch is OFF and a minimum of 80 % rpm and 1,900 pph fuel flow.

12. ENG CRANK switch - L
13. Left throttle - IDLE (15 % rpm minimum)
14. ENG CRANK switch - CHECK OFF

If external air start -

15. BLEED AIR knob - RETURN TO NORM

All starts -

16. EMI/IFEI - CHECK
17. External electrical power - DISCONNECT (if required)

7.1.6 Before Taxi

1. Waypoint zero and magnetic variation - CHECK

NOTE

To achieve the best align quality and align complete in the minimum time, waypoint zero should be the true position within 0.01 nautical miles (60 feet or 0.6 seconds.)

2. INS knob - CV, GND (parking brake set) or IFA (functioning GPS)
3. RADAR knob - OPR
4. WING FOLD - SPREAD AND LOCK

CAUTION

- Wait 5 seconds after wings are fully spread before placing the WING FOLD handle to LOCK. Placing the WING FOLD handle to LOCK before the wings are fully spread removes the WING UNLK caution even though the wings are not fully spread and could cause severe damage to the wing fold transmission.
 - The wingfold control handle should smoothly go into the LOCK position. Forcing the handle could cause damage to the wingfold system.
5. FCS RESET button - PUSH
If the wings are folded, verify aileron Xs are present.

CAUTION

To avoid damaging the flaps, ensure ailerons are not faired inboard prior to raising the flaps, conducting IBIT, or running FCS exerciser. Proper aileron position can be determined either visually or by verifying an aileron position of 0 or down arrow on the FCS page.

NOTE

Xs appear in CH 1/3 of the PROC row on the FCS page with INS ATT caution set and/or the ATT switch is placed to STBY.

If no reset -

- a. T/O trim button - PUSH (note TRIM advisory)

- b. FCS exerciser mode - INITIATE
Lift FCS BIT consent switch and push FCS RESET button simultaneously.

If still no reset -

- c. FCS circuit breakers - PULL 4 CHANNELS
 - d. Wait 10 seconds.
 - e. FCS circuit breakers - RESET
 - f. FCS RESET button - PUSH
6. FLAP switch - AUTO
 7. FCS RESET button and paddle switch - ACTUATE SIMULTANEOUSLY
 8. FLAP switch - HALF
 9. FCS INITIATED BIT - PERFORM
 - a. AOA warning tone - VERIFY ANNUNCIATION AT FCS IBIT COMPLETION

WARNING

Flight with any PBIT BLIN other than 51, 124, 322 and 336, or IBIT BLIN 4124, 4263, 4322, 4336, 4522, 4526, 4527, 4773, 4774, and 70261 can result in a flight control system failure and aircraft loss. If IBIT detects any failure other than those indicated by the IBIT BLINs listed above, IBIT must be performed again, following an FCS reset, to ensure the detected failure no longer exists. Pressing the FCS reset button, simultaneously with the paddle switch, does not correct BIT detected flight control system failures; it simply clears the BLIN code(s) from the display. If the second IBIT is not successful, the aircraft requires corrective maintenance action to address the failure(s).

CAUTION

- If wings are folded, check both ailerons Xd out. Even with wings folded there are aileron functions tested that may reveal problems via valid BLIN codes.
- Auto throttle system performance is degraded if IBIT results in BLIN code 124, 322, 336, 4124, 4322, 4336, 4522, 4526, 4527, 4773, or 4774. These BLIN codes require no maintenance action to be taken prior to flight, but use of the auto throttle system is prohibited.
- If BLIN 51 does not reset after airborne, wing-fold function may not be available after landing.

- 10. Trim - CHECK
Check pitch, roll, and yaw trim for proper movement and then set for takeoff.

NOTE

Actuation of roll trim within 20 seconds of FCS IBIT with wings folded inhibits roll trim. Roll trim is reactivated by pressing the T/O Trim button with WOW.

- 11. T/O TRIM button - PRESS UNTIL TRIM ADVISORY DISPLAYED
If a trim advisory does not appear, abort. If takeoff trim is not set, full NU stabilator movement may not be available and takeoff distance will increase. T/O TRIM button sets 12° NU.
- 12. FLAP switch - AUTO
- 13. Controls - CHECK
Tolerance for rudder and stabilator position is $\pm 1^\circ$.
 - a. Control stick - CYCLE
Full aft: 24 NU stabilator
Full fwd: 3 NU
R/L Aileron: CHECK 20 units differential stabilator.
CHECK differential trailing edge flaps
 - b. FLAP switch - HALF
 - c. Rudder pedals - CYCLE 30° left and right
- 14. Trim - SET FOR TAKEOFF
If takeoff trim is not set, full leading edge down stabilator movement may not be available and takeoff distance will increase.
- 15. PROBE, speedbrake, LAUNCH BAR switches, HOOK handle and pitot heat - CYCLE (LAUNCH BAR optional for shore based operations.)
- 16. Air scoop - CHECK
 - a. AV COOL or FCS COOL switch - EMERG
FCS ram air scoop deploys (thumbs up from plane captain).
 - b. Plane captain manually restows scoop.
- 17. APU - VERIFY OFF
- 18. Fuel - BIT/SET BINGO
- 19. Altimeter - SET
- 20. GPWS/TAWS - BOXED
- 21. Mission data - ENTER

- 22. BIT - NOTE DEGD/FAIL
- 23. Weapons/sensors - AS REQUIRED
- 24. STORES page - VERIFY PROPER STORE INVENTORY AND STATION STATUS
- 25. HMD - ALIGN (both cockpits)

NOTE

Canopy must be down and locked to align HMD/AHMD.

(CVRS record HMD if desired)

- a. SUPT/HMD/ALIGN page - SELECT
- b. Superimpose the HMD alignment cross on the HUD/BRU alignment cross.
- c. Cage/Uncage button - PRESS and HOLD until ALIGNING turns to ALIGN OK or ALIGN FAIL

If ALIGN FAIL -

- d. Repeat steps b and c.

If ALIGN OK and HMD alignment crosses are not coincident with HUD/BRU alignment cross -

- d. Perform FINE ALIGN.
 - (1) With FA DXDY displayed, use TDC to align azimuth and elevation HMD alignment crosses with the HUD/BRU alignment cross.
 - (2) Cage/Uncage button - PRESS and RELEASE
 - (3) With FA DROLL displayed, use TDC to align the roll axis HMD alignment crosses with the HUD/BRU alignment cross.
 - (4) Cage/Uncage button - PRESS and RELEASE

If satisfied with alignment -

- e. ALIGN - UNBOX
- 26. Standby attitude reference indicator - UNCAGE
- 27. ATT switch - STBY
Verify INS attitude data is replaced by standby attitude data on HUD. Check agreement of standby and INS data. Verify Xs appear in CH 1/3 of the PROC row on the FCS page.
- 28. ATT switch - AUTO

LOX Aircraft -

- 29. Oxygen system - CHECK

- a. OXYGEN supply lever - ON/MASK ON
- b. Oxygen flow - CHECK
- c. OXYGEN supply lever - OFF/MASK OFF

WARNING

If OXYGEN supply lever is ON and the mask is not properly donned, the flow control valve could freeze in the open position and cryogenic burns could result.

OBOGS Aircraft -

29. OBOGS system - CHECK
 - a. OBOGS control switch - ON
 - b. OXY FLOW knob - ON/MASK ON (both cockpits)
 - c. OBOGS flow - CHECK
 - d. OBOGS monitor electronic BIT pushbutton - PRESS AND RELEASE
 - e. Verify OBOGS DEGD caution set and removed within 15 seconds.
 - f. OXY FLOW knob - OFF/MASK OFF (both cockpits)

WARNING

Continued operation and use of the OBOGS system with an OBOGS DEGD caution may result in hypoxia.

All aircraft -

30. ID - Enter three digit Julian date and event number via UFC
31. Canopy either full up or full down during taxi.

CAUTION

Taxiing with canopy at an intermediate position can result in canopy attach point damage and failure. Do not open or close the canopy with the aircraft in motion.

7.1.7 Taxi. As aircraft starts to roll, apply brakes to check operation. When clear, check nosewheel steering in both directions in the high mode to ensure proper operation. At high gross weight, make all turns at minimum practicable speed and maximum practicable radius.

1. Normal brakes - CHECK
2. Nosewheel steering - CHECK
 When using brakes, apply firm, steady brake pedal pressures. Use nosewheel steering whenever possible, minimizing differential braking. Avoid dragging brakes or light brake applications except as necessary for drying wet brakes. Wet brakes can have as much as 50 % reduced braking capacity. Hard momentary braking with wet brakes during taxi can reduce drying time.

7.2 TAKEOFF

7.2.1 Before Takeoff

1. Canopy - CLOSED
2. OXY FLOW knob or OXYGEN supply lever - ON/MASK ON



It is possible to place the OXY FLOW knob in an intermediate position between the ON and OFF detents, which may result in a reduced flow of oxygen. The OXY FLOW knob should always be fully rotated to the ON or OFF detent position.

3. IFF - ON
4. Inertial navigation system - CHECK
 On aircraft without GPS, after alignment is complete, NAV may be selected. On aircraft with GPS or EGI, after alignment is complete, select NAV or IFA.

NOTE

On GPS equipped aircraft, selecting IFA without an OK results in transition to IFA RDR.

5. PARK BRK handle - FULLY STOWED
6. MENU checklist - COMPLETE (figure 7-1)
7. Engines - MIL CHECK (if desired)

	F404-GE-400	F404-GE-402
N ₂ % RPM	92 to 102	90 to 102
EGT °C	715 to 830	715 to 880
FF pph	6,000 to 9,000	6,000 to 12,500
NOZ %	0 to 57	0 to 48
OIL psi (warm oil)	95 to 180	95 to 180
AB	Check if desired	Check if desired

7.2.2 Normal Takeoff. Set takeoff trim to 12° and ensure the speedbrake is retracted. The aircraft should be aligned with the centerline of the runway for individual takeoffs. When in position, roll forward slightly to center the nose wheel and select low gain nosewheel steering. As the takeoff roll is

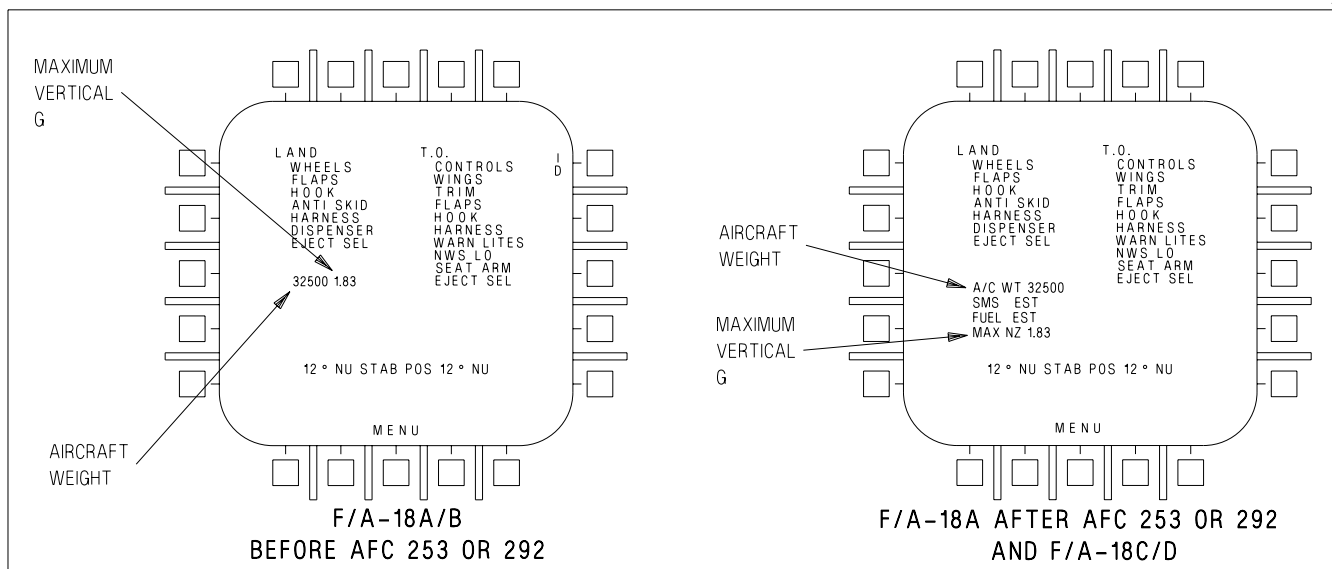
**NOTE**

ADA520-43-1-053

- The STAB POS values represent degrees are followed by NU (nose up) or ND (nose down). The values may range from 24 NU to 10 ND. Takeoff trim is set to 12° NU STAB POS.
- EJECT SEL is displayed on F/A-18B/D aircraft only.
- Maximum vertical g - Maximum vertical acceleration experienced during the most recent landing, rounded to the nearest .01 g.
- Aircraft weight - The aircraft gross weight rounded to the nearest 100 lbs, or with MC OFP 13C AND UP, the aircraft gross weight rounded to the nearest pound. If aircraft weight is invalid the weight symbology stops being updated and flashes. When either the SDC or SMS detects a fault, the aircraft weight flashes and FUEL INV, FUEL EST, SMS INV, or SMS EST is displayed. The MC continues to update the total aircraft weight unless both the SDC and SMS indicate invalid, then the weight stops being updated.
- In the CV environment it is recommended that the takeoff checklist be completed from bottom to top.

Figure 7-1. Checklist Display

begun, advance throttles to MIL power and check EGT and RPM. If an afterburner takeoff is desired, afterburner is selected by moving both throttles into the afterburner range and advancing smoothly to MAX power. If one afterburner fails to light or blows out during takeoff, the resulting power loss is significant. Sufficient directional control is available with the rudder and nosewheel steering to continue the takeoff with asymmetric power. The decision to abort or continue the takeoff depends on existing circumstances: external stores configuration, runway remaining, and the characteristics of the afterburner failure since it may indicate problems with the basic engine. Nosewheel steering is used to maintain directional control throughout the takeoff roll. Differential braking alone may not be adequate to maintain directional control on takeoff. Also, the drag of the brakes increases the length of the takeoff roll.

The location of the main landing gear well aft of the CG does not allow the aircraft to be rotated early in the takeoff roll. The normal rotation technique is to position the stick aft of neutral approaching nosewheel lift-off speed. Nosewheel lift-off speed depends on weight and CG, however, hold the aft stick until 6° to 8° nose high attitude (waterline symbol) is reached. Main gear lift-off follows shortly, and a forward adjustment of stick is necessary to maintain the desired attitude.

For a minimum run takeoff, use full afterburner power. Approaching nosewheel lift-off speed, apply full aft stick until the aircraft begins to rotate. Adjust the stick to maintain a 10° to 12° nose high attitude (waterline symbol). Once a positive climb rate is established, ensure the gear handle light is out and retract the gear. Accelerate to the appropriate climb speed.

WARNING

- Improper trim setting (e.g., 10° nose down vice 10° nose up) can reduce stabilator authority to a level below that required for takeoff.
- Full stabilator (with 12° nose up trim) is not available at airspeeds greater than approximately 180 knots.

CAUTION

- Takeoff with significant standing water on runway has caused water ingestion which in extreme cases can cause engine stalls, flameouts, A/B blowouts, and/or engine FOD. Avoid standing water in excess of 0.25 inch.
- Ensure computed nosewheel liftoff speed does not exceed nose tire speed limitation (190 knots groundspeed) during takeoffs under certain combinations of the following conditions: high gross weight, high pressure altitude, high temperature, or forward CG. See NATOPS performance charts.
- Analysis has shown that an improperly serviced nose strut can increase nosewheel liftoff speed by as much as 10 knots.
- Premature aft stick input below nose wheel liftoff speed will increase takeoff roll.

7.2.3 Crosswind Takeoff. The initial portion of the crosswind takeoff technique is the same as the normal takeoff. Aft stick pressure should not be applied until approaching liftoff speed.

Do not assume an immediate wing low attitude in order to counteract for wind drift; the pilot cannot properly judge the wing tip ground clearance on a swept wing aircraft.

7.2.4 Formation Takeoff. Refer to Formation Flight, Chapter 9.

7.2.5 After Takeoff

When definitely airborne -

1. LDG GEAR handle - UP
2. FLAP switch - AUTO

7.2.6 Climb. For visibility over the nose, maintain 350 knots to 10,000 feet. For optimum climb performance, refer to Part XI.

7.2.7 10,000 Feet

1. Cockpit altimeter - CHECK
2. Fuel transfer - CHECK

3. Radar altimeter low altitude warning system - CHECK/SET

7.2.8 Cruise. Optimum cruise and maximum endurance should be found in the Performance Data, Part XI, and is attained by flying the correct Mach number for configuration and altitude. Maximum range cruise is approximated by establishing 4.2°, but no faster than Mach 0.85. Maximum endurance is approximated by establishing 5.6° AOA.



When using JP-4 fuel and ambient temperature at takeoff exceeds 85° F, idle power decelerations between Mach 1.23 and Mach 0.9 may result in engine flameout.

7.2.8.1 Cruise Check.

1. Cabin pressurization/temperature - MONITOR

During cruise, check cabin pressurization/temperature control. Pressurization shall remain at 8,000 feet up to 23,000 - 24,000 feet altitude. Above 23,000 to 24,000 feet altitude, cockpit pressurization shall follow schedule in figure 2-37.

AIRCRAFT ALTITUDE

30,000 feet
40,000 feet

CABIN ALTITUDE

10,000 to 12,000 feet
15,000 to 17,000 feet

WARNING

A slowly increasing cabin pressure altimeter may be the first or only warning of a gradual loss of cabin pressurization.

7.3 LANDING

7.3.1 Descent/Penetration. Before descent, preheat the windshield by increasing defog air flow (DEFOG-HIGH) and, if necessary windshield anti-ice/rain air flow (WINDSHIELD ANTI-ICE/RAIN). Since rapid descents cannot always be anticipated, the maximum comfortable cockpit interior temperature should be maintained to aid in defrosting the windshield. Normal instrument penetration is 250 knots and 4,000 to 6,000 feet per minute descent. Refer to Part XI, for optimum descent profiles. Before starting descent, perform the following:

1. ENG ANTI ICE switch - AS DESIRED
2. PITOT ANTI ICE switch - AUTO
3. DEFOG handle - HIGH
4. WINDSHIELD switch - AS DESIRED
5. Altimeter setting - CHECK
6. Radar altimeter - SET AND CHECK

7. HUD - SELECT NAV MASTER MODE, COMPARE WITH STANDBY FLIGHT INSTRUMENTS AND STANDBY COMPASS
8. Navaids - CROSSCHECK
9. ARA-63 (ILS) - ON AND CHANNEL SET
10. IFF - AS DIRECTED
11. Weapons/sensors - AS REQUIRED

7.3.2 Approach. See figure 7-2. Enter the pattern as prescribed by local course rules. At the break, reduce thrust and extend the speedbrake (if required). As the airspeed decreases through 250 knots, lower the landing gear and place the FLAP switch to FULL and ensure that speedbrake is retracted. Retract speedbrake, if extended. Decelerate to on-speed, and compare airspeed and angle of attack. Complete the landing checklist. Roll into the base leg and establish a rate of descent, maintaining on-speed AOA. On-speed without external stores and 2,000 pounds of internal fuel is about 125 knots. Add about 2.5 knots for each 1,000 pounds increase in fuel and stores. Rate of descent can be established using the velocity vector on the HUD to set the glide-slope. Avoid overcontrolling the throttles as thrust response is immediate. Compensate for crosswind by crabbing the aircraft into the wind on final approach.

1. LAND checklist - COMPLETE

7.3.3 Touchdown.

Maintain approach attitude and thrust setting to touchdown using the lens or make a firm touchdown at least 500 feet past the runway threshold. At touchdown, place the throttles to IDLE. The aircraft tends to align itself with the runway. Small rudder corrections (NWS) may be required to keep the aircraft tracking straight. Using a flared minimum descent rate landing, the WOW switch may not actuate immediately. In this case, the throttles cannot be reduced to ground idle and may be inadvertently left in the flight idle position, thereby reducing the deceleration rate and extending the length of the landing rollout. Track down the runway centerline using rudder pedals to steer the aircraft. Aerodynamic braking is not recommended. Getting the nosewheel on the ground and use of aft stick (programmed in by light braking and slowly pulling the stick aft after touchdown so only the minimum required distance to command full aft stabilator deflection by 100 knots) provides faster deceleration from the stabilators and more directional control with use of the NWS.

WARNING

Commanding full aft stick deflection with the ejection seat within 1.75 inches of the top limit can cause the lower ejection handle to snag on the air-to-air weapon select switch and result in inadvertent ejection. In particular, during stabilator braking after a full stop landing the control stick should be pulled back only the minimum required distance to command full stabilator authority. Inadvertent ejections have occurred after stabilator braking when the pilot has released full aft stick.

7.3.4 Nosewheel Steering. The nosewheel steering (NWS) is the most effective means of directionally controlling the aircraft during landing rollout. Aerodynamic control surface inputs become

ineffective below an airspeed of 75-85 knots. Differential braking requires special attention and technique to control the aircraft below this speed. NWS is activated automatically in the low mode (16° limit) by weight on the nose and at least one main gear. NWS inputs are commanded through force sensors behind the minimum displacement rudder pedals allowing for precise directional control. The NWS does not receive commands through the rolling surface to rudder interconnect (RSRI).

NOTE

Rudder and vertical tail effectiveness is significantly reduced if the speedbrake is extended during the landing rollout and degrades directional control during crosswind landings. Aircraft directional stability is further reduced on a wet runway.

The aircraft can be safely landed with the nosewheel steering failed (castering) in crosswinds up to 25 knots. The aircraft tends to drift more to the downwind side of the runway and corrections are more difficult. With the anti-skid on, directional control with differential brakes require pumping of the upwind brake or releasing pressure from the downwind brake. To reduce the risk of blowing the tires, landing without anti-skid on when heavy braking is anticipated is not recommended.



Engaging the high gain mode of NWS while maintaining a rudder pedal input causes a large nosewheel transient and may cause loss of directional control.

NOTE

Using the high gain mode of nosewheel steering (NWS HI) during the landing rollout is not recommended and may lead to directional pilot induced oscillations due to the increased sensitivity of the NWS to rudder pedal inputs.

7.3.5 Landing Rollout. Track down the runway centerline using rudder pedals to steer the aircraft directionally. Aerodynamic braking is not recommended. Use wheel braking only after the aircraft main wheels are firmly on the runway.

7.3.6 Braking Technique. Under normal circumstances, the best results are attained by applying moderate to heavy braking with one smooth application of increasing braking pressure as airspeed decelerates towards taxi speed. Anti-skid is effective down to approximately 40 KGS. Below 40 KGS, heavy brake pedal pressure should be relaxed to prevent tire skid. Below 35 KGS, steady but firm brake pedal pressure should be applied. Steady, light brake applications should be avoided, as they increase brake heating, do not significantly contribute to deceleration, and ultimately reduce braking effectiveness. If desired, selecting aft stick (up to full) below 100 KCAS will increase TEU stabilator

deflection and aid in deceleration. Full aft stick increases down force on the main landing gear, as well as significantly increasing drag due to large stabilator size.

A rectangular icon with a scalloped border containing the word "CAUTION" in bold, uppercase letters.

Recommended braking speeds are based on tests conducted at sea level. Ground speed may be significantly higher than calibrated airspeed at airfields above sea level. Aircrew should consider available runway length and field elevation to evaluate wheel brake usage and landing rollout distance to avoid excessive brake heat build-up and subsequent tire deflation or wheel assembly fire when landing at airfields above sea level.

Maximum braking performance is attained by applying full brake pedal pressure (approximately 125 lb) immediately after touchdown. Anti-skid must be on to attain maximum braking performance and to reduce the risk of a blown tire. Longitudinal pulsing may be felt as the anti-skid cycles. Approaching 40 KCAS, full brake pedal pressure should be relaxed to prevent tire skid.

7.3.7 Crosswind Landing. The optimum technique for crosswind landing is to fly a crabbed approach, taking out half the crab just before touchdown. For landing in a crosswind greater than 15 knots on a dry runway, the touchdown should be slightly cushioned in order to reduce landing gear trunion loads. The wing-down top-rudder technique is ineffective in crosswinds greater than 20 knots, creates excessive pilot workload, and should not be used. Touchdown in a full crab or with all the crab taken out may cause large directional oscillations which can lead to excessive pilot inputs and subsequent PIO. Taking out half the crab provides the correct amount of pedal force and resultant NWS command to start the aircraft tracking down the runway.

A rectangular icon with a scalloped border containing the word "CAUTION" in bold, uppercase letters.

When calculating crosswind components for takeoff or landing, use the full value of any reported gusts in your calculations.

NOTE

Pilot control inputs are not required to counter slightly objectionable directional oscillations which may occur at and immediately following touchdown. Minimize stick and rudder pedal inputs until nose movement is stable. If oscillations continue, execute a go-around.

Subsequent runway centerline tracking requires only small rudder inputs to initiate directional corrections. Although lateral stick is not generally required during the landing roll, judicious inputs may be made to counter the upwind wing rocking up. Landing rollouts in crosswinds up to 30 knots have been accomplished with hands off the control stick with little or no objectionable roll (less than 5°) induced by crosswind or asymmetric stores.

7.3.8 Wet Runway Landing. The aircraft exhibits satisfactory handling characteristics during landing rollouts on wet runways. However, experience indicates that landing in crosswind conditions may increase the pilot tendency to directionally overcontrol the aircraft during the landing rollout. Wet runways can induce hydroplaning throughout the landing rollout. As a result, the aircraft may respond sluggishly to NWS commands and encourage the pilot to use excessively large control inputs. Rudder

pedal commands should be kept small, especially if hydroplaning is suspected. Minimum total hydroplaning speed of the main landing gear tires inflated to 250 psi is 140 knots groundspeed and, for nose gear tires inflated to 150 psi, is 110 knots. However, some hydroplaning can occur at much lower speed, depending upon runway conditions. For wet (standing water) runway landings, reduce gross weight to minimum practical. Concentrate on landing ON SPEED or slightly slow with power coming off at touchdown. Maintain a constant attitude and sink rate to touchdown. Ensure the throttles are in ground idle. When comfortable with directional control, use maximum anti-skid braking to minimize landing distance. Go around if a directional control problem occurs and make an arrested landing. Delaying the decision to abort the landing and go around can put the pilot in a situation in which he cannot remain on the runway during the takeoff attempt.



Landing with significant standing water on runway has caused water ingestion which in extreme cases can cause engine stalls, flameouts, A/B blowouts, and/or engine FOD. Avoid standing water in excess of 0.25 inch.

7.3.9 Asymmetric Stores Landing. Landing with asymmetric external stores up to 12,000 foot-pounds of lateral asymmetry requires no special considerations. Above 12,000 foot-pounds of lateral asymmetry, AOA must be kept below 12° to prevent uncommanded sideslip.

The inboard station is 7.3 feet from the aircraft centerline and the outboard station is 11.2 feet from the aircraft centerline. A lateral asymmetry of 12,000 foot-pounds occurs with 1,636 pounds of asymmetry on an inboard station or 1,070 pounds of asymmetry on an outboard station.

Due to landing gear structural limitations, the weight of an asymmetric tip missile and/or internal wing fuel asymmetry must be used in calculating total aircraft asymmetry. Asymmetry due to internal wing fuel imbalance is calculated by multiplying the difference of fuel weight between left hand and right hand wing by 8.0 feet. Fuel weight differences of less than 100 pounds are considered negligible. Wingtip missile asymmetries can be calculated by multiplying missile weight by 19.5 feet (the distance of the wingtip station from aircraft centerline.)

If lateral asymmetry exceeds 12,000 foot-pounds, do not exceed 12° AOA. Recommend fly straight-in approach at optimum approach speed. Do not apply cross controls and make only smooth, coordinated rudder and lateral stick inputs. In a crosswind, fly a crabbed approach to touchdown.



Field landings (flared) with asymmetries between 17,000 and 26,000 foot-pounds are authorized only at touchdown sink rates up to 500 fpm due to structural limitations of the landing gear.

7.3.10 Waveoff. Do not delay the decision to take a waveoff to the point that control of the landing or rollout is in jeopardy. Takeoff distances at MIL or MAX power are short provided the aircraft has not decelerated to slow speed. Advance the throttles to MIL or MAX as required to either stop the sink rate or takeoff and maintain angle of attack. Raise the landing gear and flaps only after a safe climb has been established.

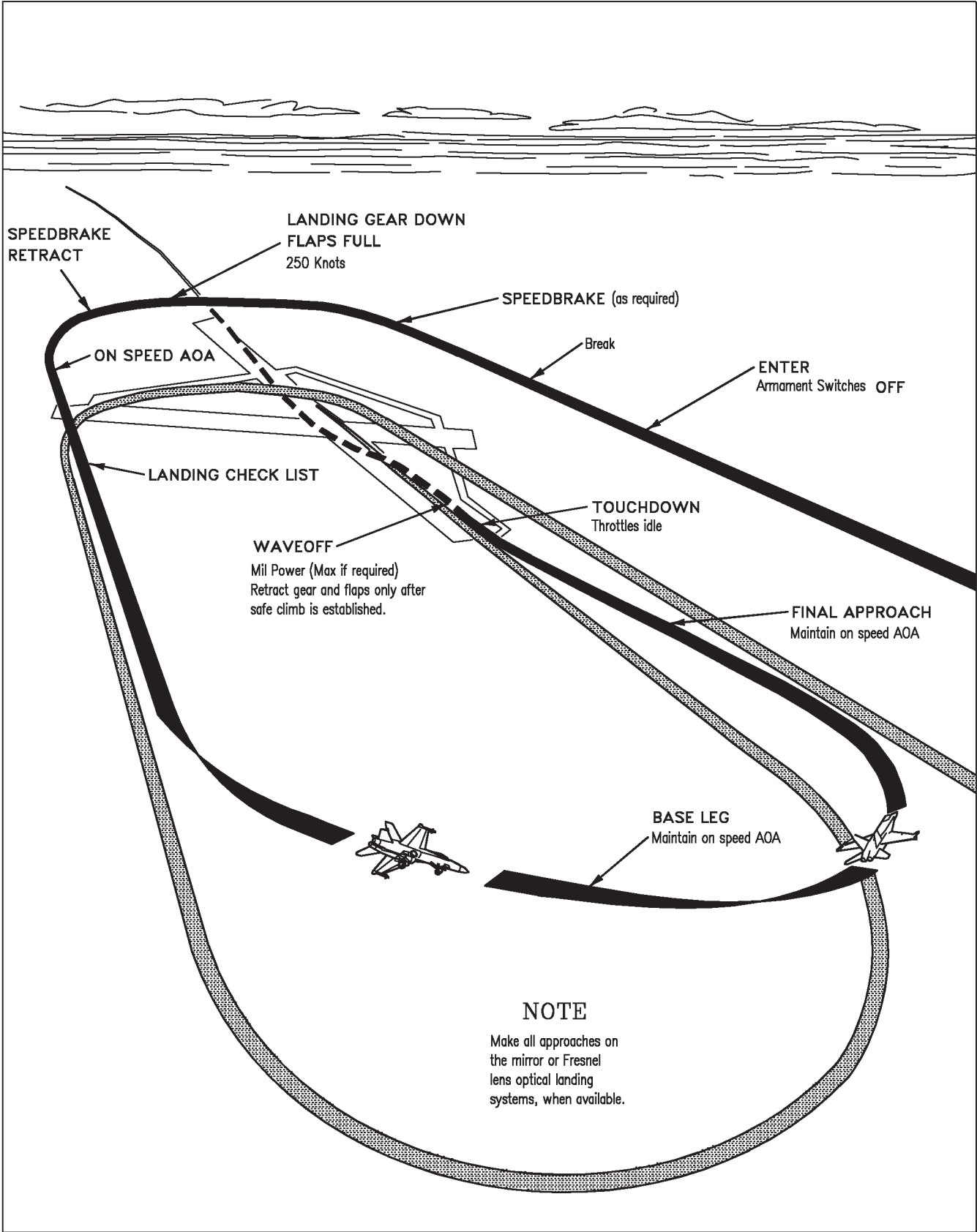

18AC-NFM-00-(44-1)31-CATI

Figure 7-2. Field Landing Pattern Typical

7.4 POSTFLIGHT

7.4.1 After Landing. Do not taxi with the right engine shut down. With the right engine shut down, only the accumulators provide hydraulic power for nosewheel steering and brakes.

NOTE

To prevent damage to the moving map servos, keep the HI brightness selector knob in NIGHT or DAY and at least one DDI on whenever the aircraft is in motion.

When clear of active runway -

1. Ejection seat - SAFE

WARNING

Ensure that the SAFE/ARM handle is locked in the detent in the safe position and that the word **SAFE** is completely visible on the inboard side of the SAFE/ARM handle. If the SAFE/ARM handle does not lock in the detent or the word **SAFE** is not completely visible, check to ensure that the ejection handle is fully pushed down into its detent and attempt to resafe the seat with the SAFE/ARM handle. Instruct line personnel to remain clear of the cockpit until this downing discrepancy is properly checked by qualified ejection seat maintenance personnel.

2. Landing gear handle mechanical stop - FULLY ENGAGED
3. FLAP switch - AUTO
4. T/O TRIM button - PUSH (note TRIM advisory)
5. Mask - OFF

LOX Aircraft -

6. OXYGEN supply lever - OFF

OBOGS Aircraft -

6. OXY FLOW knob - OFF

All Aircraft -

7. Canopy either full up or full down.



Taxiing with canopy at an intermediate position can result in canopy attach point damage and failure.

NOTE

Adjusting seat height after Koch fittings are removed may result in trombone fairing damage.

7.4.2 Hot Refueling. When refueling external tanks, the tanks refuel slowly until the internal tanks are full. Do not hot refuel with the right engine shut down. With the right engine shut down, only the accumulators provide hydraulic power for nosewheel steering and brakes.

The fuel quantity indicator must stabilize within 45 seconds after initiating pre-check and must not increase more than 100 pounds in the following 60 seconds. The pre-check system may require as long as 45 seconds to close the refueling pilot valves. Closing of the valves is indicated by a rapid decrease in the refueling rate. An increase of more than 100 pounds fuel quantity after allowing time for the valves to close (45 seconds maximum) indicates failure of one or more valves to close.



A failed or leaking refueling pilot valve causes rapid overfilling of the fuel overflow/vent tank, fuel spillage from the vent mast(s), and possible fire if fuel spills on hot engine components.

Before taxi, the plane captain/final checker shall signal confirmation that the fuel cap is properly installed and door 8 right is closed. The signal is a cupped open hand rotated counterclockwise then clockwise followed by a thumbs up.

7.4.3 Before Engine Shutdown.

1. PARK BRK handle - SET
2. BIT display - RECORD DEGD
3. BLIN codes - RECORD
4. Radar maintenance codes - NOTE IF PRESENT
5. INS - PERFORM POST FLIGHT UPDATE
6. INS knob - OFF (10 seconds before engine shutdown)
7. Standby attitude reference indicator - CAGE/LOCK

8. Sensors, radar, avionics and VTRS - OFF

NOTE

To prevent tapes from jamming, wait a minimum of 20 seconds after VTRS/CVRS shutdown before removing aircraft power.

9. COMM 1 and 2 - OFF
10. EXT and INT LT knobs - OFF

WARNING

For aircraft 163985 AND UP, a high voltage (100,000 volt) static electrical charge may build up in flight and be stored in the windscreen and canopy. To prevent electrical shock ensure that the static electricity has been discharged.

11. CRYPTO switch - AS REQUIRED

NOTE

Ensure the MIDS terminal is ON, by ensuring L16 or TACAN is ON, prior to any attempt to zeroize IFF Mode 4 Crypto Keys via the CRYPTO switch.

12. Canopy - OPEN
13. QDC - DISCONNECTED AND STOWED

CAUTION

Failure to disconnect QDC prior to pilot egress will damage the lower IRC connection.

7.4.4 Engine Shutdown

1. Brake gauge - 3,000 psi
2. Nosewheel steering - DISENGAGE
3. FLAP switch - FULL
4. Throttle - OFF (alternate side)

NOTE

Before engine shutdown, engine should be operated at flight or ground idle for 5 minutes to allow engine temperatures to stabilize.

5. Monitor HYD pressure. As pressure decreases below 1,500 psi, gently pump the stick approximately ± 1 inch fore and aft at approximately two cycles per second, decreasing hydraulic pressure on shutdown engine below 800 psi. Ensure system pressure on operating engine remains above 1,500 psi.

NOTE

Pressure must remain below 800 psi on shutdown engine for valid test.

6. Continue gently pumping the stick while monitoring FCS page for FCS Xs and/or BLIN codes for 12 seconds after system pressure on shutdown engine drops below 800 psi. Record if present.

NOTE

- BLIN code 63 and/or rudder Xs indicate a malfunctioning rudder switching valve and further maintenance action is required.
- BLIN code 66 and/or aileron Xs indicate a malfunctioning aileron switching valve and further maintenance action is required.
- BLIN code 67 and/or LEF Xs indicate a malfunctioning LEF switching valve and further maintenance action is required.

7. L(R) DDI, HI/MPCD, and HUD - OFF

8. Throttle - OFF

When amber FLAPS light illuminates -

9. BATT switch - OFF

WARNING

Turning battery switch off before the amber FLAPS light illuminates could result in severe uncommanded flight control movement. The only cockpit indication that hydraulics have been removed from the flight controls, and that they are no longer powered, is the amber FLAPS light.

NOTE

If engines are not idled for 5 minutes prior to shutdown, a restart should be avoided between 15 minutes and 4 hours after shutdown.

7.5 REAR COCKPIT PROCEDURES (F/A-18B/D)

WARNING

Flight in the rear seat is limited to crewmembers with buttock-leg length less than 48 inches and buttock-knee length less than 26.5 inches.

7.5.1 Before Entering Cockpit

1. Ejection seat safe/arm handle - SAFE & LOCKED
2. Ejection seat - PREFLIGHT PER FRONT COCKPIT CHECKLIST

7.5.2 Interior Check

1. Harness and rudder pedals - SECURE/ADJUST
Fasten and secure leg restraint garters and lines. Check leg garters buckled and properly adjusted with hardware on inboard side of the legs. Check that lines are secured to seat and floor and not twisted. Check that leg restraint lines are routed first through the thigh garter ring, then through the lower garter ring, and then routed outboard of the thigh garter ring before the lock pins are inserted into the seat just outboard of the snubber boxes. Attach parachute risers to harness buckles. Connect and adjust lap belt straps. Connect oxygen, g suit, and communications leads. Check operation of shoulder harness locking mechanism.

WARNING

- The leg restraint lines must be buckled at all times during flight to ensure that the legs are pulled back upon ejection. This enhances seat stability and prevents leg injury by keeping the legs from flailing following ejection.
- Failure to route the restraint lines properly through the garters could cause serious injury during ejection/emergency egress.

2. EMERG BRK handle - IN

WARNING

Anti skid is not available with the rear cockpit emergency brake handle in the emergency position.

3. Ejection control handle - CLEAR

Left console -

LOX Aircraft -

1. OXYGEN supply lever - OFF

OBOGS Aircraft

1. OXY FLOW knob - OFF

All Aircraft -

2. CANOPY JETT handle - OUTBOARD AND DOWN
3. VOL panel - SET
4. Throttles (on rear stick and throttle equipped F/A-18D) - OFF

Instrument panel -

1. EMERG LDG GEAR handle - IN
2. EMERG BRK handle - IN
3. L(R) DDI/MPCD knobs - OFF
4. COMM 1 and 2 knobs - OFF
5. Clock - CHECK AND SET
6. Standby attitude reference indicator - CAGE/LOCK

Right console -

7. INTR LT panel - AS DESIRED
8. NVG container - SECURE/NVG STOW (if required)

7.5.3 Before Taxi

1. L(R) DDI/MPCD - ON
2. Fuel quantity gauge - CHECK QUANTITY
3. Altimeter - SET
4. Flight controls (on rear stick and throttle equipped F/A-18D) - CYCLE
After FCS reset in the front cockpit, cycle the flight controls.
5. Standby attitude reference indicator - UNCAGE

LOX Aircraft -

6. Oxygen system - CHECK
 - a. OXYGEN supply lever - ON/MASK ON
 - b. Oxygen flow - CHECK

- c. OXYGEN supply lever - OFF/MASK OFF

WARNING

If OXYGEN supply lever is ON and the mask is not properly donned, the flow control valve could freeze in the open position and cryogenic burns could result.

OBOGS Aircraft -

- 6. OBOGS system - CHECK
 - a. OXY FLOW knob - ON/MASK ON
 - b. OBOGS flow - CHECK
 - c. OXY FLOW knob - OFF/MASK OFF

7.5.4 Before Takeoff

- 1. T.O. checklist - CONFIRM COMPLETE
- 2. OXY FLOW knob or OXYGEN supply lever - ON/MASK ON

WARNING

It is possible to place the OXY FLOW knob in an intermediate position between the ON and OFF detents, which may result in a reduced flow of oxygen. The OXY FLOW knob should always be fully rotated to the ON or OFF detent position.

7.5.5 Descent/Penetration

- 1. Altimeter setting - CHECK
- 2. Standby instruments - CHECK

7.5.6 Approach

- 1. LAND checklist - CONFIRM COMPLETE

7.5.7 After Landing

When clear of active runway -

- 1. Ejection seat - SAFE
- 2. Mask - OFF
- 3. OXY FLOW knob or OXYGEN supply lever - OFF

7.5.8 Before Engine Shutdown.

1. L(R) DDI/MPCD - OFF
2. COMM 1 and 2 - OFF
3. Interior lights - OFF
4. Standby attitude reference indicator - CAGE/LOCK

7.6 NIGHT FLYING

7.6.1 External Light Management. During night operations, the external lights should be set as follows:

1. On the line - Position and formation lights BRT, strobe light ON
2. When ready to taxi - Taxi light - AS DESIRED
3. In flight - AS REQUIRED
 - a. Single aircraft - BRT (or as weather conditions dictate)
 - b. Formations - AS REQUIRED BY WINGMAN
The last aircraft in formation should have external lights on BRT unless tactical situation demands otherwise (actual penetrations).

CHAPTER 8

Carrier-Based Procedures

8.1 GENERAL

The CV and LSO NATOPS Manuals are the governing publications for the carrier-based operations and procedures. All flight crewmembers shall be familiar with CV NATOPS procedures and Aircraft Launch/Recovery Bulletins prior to carrier operations.

8.1.1 Carrier Electromagnetic Environment. Tests conducted in a carrier deck electromagnetic environment (EME) have documented numerous electronic interference problems that affect aircraft systems, displays and weapons. These electromagnetic interference problems do not occur all the time as they are a function of operating shipboard emitters and aircraft location. The electromagnetic interference problems are especially apparent if avionics bay doors are open on the flight deck.



With avionics bay doors open when operating in or near the carrier electromagnetic environment a NOGO may be displayed next to MC 1 or MC 2 on the BIT display. Checks of the computers have confirmed that some memory alteration has occurred and the NOGO indication is valid and should not be ignored.

NOTE

Operating in or near the carrier electromagnetic environment may cause the following temporary effects on the aircraft systems:

DDI - streaking and strobos on display, loss of BIT status, vibration indicator on ENG page may show a significant increase in engine vibration, unusable video picture on Walleye display, and inoperable Walleye cage/uncage button.

HUD - altitude display to flash on/off.

TACAN - loss of range and bearing.

UHF - blanking of communications, communications relay may be unusable.

RAD/ALT - low altitude warning light flashing.

IFF - failure to reply when lower antenna is selected.

ICS - excessive background noise.

VTR - distortion during playback.

Engine Monitor Indicator - uncommanded switching of numbers.

Warning/Caution Lights - intermittent illumination of arresting hook and landing gear warning light.

F/A-18D -

FIRE Warning Light - illumination of aft cockpit fire warning light.

DDI - loss of symbology alongside buttons of left DDI in both cockpits.

AOA - intermittent illumination of AOA indexer lights.

8.1.2 Carrier INS Environment. The CV alignment is dependent on the Ship Inertial Navigation System (SINS). Align times are longer to achieve QUALs typical on land. Ship turns and sea-state also affect the CV alignment. Postflight updates (closeout) cannot be performed on carriers.

NOTE

It is recommended that a waypoint zero position (SINS, PIM, etc.) be input to reduce GPS satellite acquisition time.

8.2 DAY OPERATIONS

8.2.1 Preflight. When directed to man the aircraft, conduct a normal preflight inspection with particular attention given to the landing gear, struts, tires, arresting hook, and underside of the fuselage for possible arresting cable damage. Ensure sufficient clearance exists for cycling ALL control surfaces. Interior checks are the same as shore based except anti-skid OFF. Note the relationship of the APU exhaust port and the arresting hook to the deck edge. Do not start the APU if there is a possibility of damage from the APU exhaust. Do not lower the hook during post start checks unless the hook point will drop on the flight deck.



The maximum wind allowed for canopy opening is 60 knots. Attempting canopy opening in headwinds of more than 60 knots or in gusty or variable wind conditions may result in damage to or loss of the canopy.

8.2.2 Engine Start. When directed, start engines. APU starts should be made whenever possible. Crossbleed starts must be approved by the Air Boss due to the relatively high power setting required, and the potential for injury from the jet blast.

Perform the before taxi checks and be ready to taxi when directed.

8.2.3 Taxi.



- Ensure anti-skid switch is OFF for all carrier operations.
- Wait 5 seconds after wings are fully spread before placing the WING FOLD handle to LOCK. Placing the WING FOLD handle to LOCK before the wings are fully spread removes the WING UNLK caution even through the wings are not fully spread and cause severe damage to the wing fold transmission.



The wingfold control handle should smoothly go into the LOCK position. Forcing the handle could cause damage to the wingfold system.

CAUTION

Due to the high wind over the deck, it is possible for the aileron locking pin to shear at any time. This will allow the aileron to fair away from the neutral position. Pay special attention to the aileron position with the wings folded on the carrier deck. To avoid damaging the flaps, ensure ailerons are not faired inboard prior to raising the flaps, conducting IBIT, or running FCS exerciser. Proper aileron position can be determined either visually or by verifying an aileron position of 0 or down arrow on the FCS page.

Taxiing aboard ship is much the same as ashore, but increased awareness of jet exhaust and aircraft directors are mandatory.

Nosewheel steering is excellent for directional control aboard ship. Taxi speed should be kept under control at all times, especially on wet decks, in the landing area, and approaching the catapult. The canopy should be down, oxygen mask on, and the ejection seat armed during taxi. Be prepared to use the emergency brake should normal braking fail. In the event of loss of brakes, inform the tower and lower the tailhook immediately to indicate brake loss to the deck personnel.

8.2.4 Hangar Deck Operation. Occasionally the aircraft is manned on the hangar deck. Follow the same procedures as those concerning flight deck operation.

Tiedowns shall not be removed from the aircraft unless emergency brake accumulator pressure gauge indicates at least 2,600 psi. The emergency brake shall be used for stopping the aircraft anytime it is being moved while the engines are not running. If the aircraft is not already on the elevator, it will be towed or pushed (with the pilot in the cockpit) into position to be raised to the flight deck. Close the canopy, ensure tiedowns are in place, and put the parking brake on anytime the aircraft is on the elevator.

The signal to stop an aircraft that is being towed is either a hand signal or a whistle blast. The whistle signifies an immediate or emergency stop. Leave the canopy open and helmet off to ensure hearing the whistle; keep the plane director in sight at all times. If unable to see the plane director, or if in doubt of safe aircraft movement, stop the aircraft immediately.

8.2.5 Before Catapult Hook-Up. Before taxi onto the catapult, complete the takeoff checklist, set the standby attitude reference indicator for use if the HUD fails during the launch. With flaps HALF or FULL, the takeoff trim button should be pressed until the TRIM advisory appears and then the horizontal stabilator trim should be manually positioned for CG location, excess end airspeed and power setting for launch. The takeoff trim button need not be pressed between successive launches in a single flight. With an asymmetric load, trim stabilator for normal position then trim differential stabilator unloaded wing down. The trim settings in figure 8-1 are applicable for HALF flaps only, all air-to-air stores, air-to-ground stores, clean aircraft, external fuel tanks, gross weights and launch CG between 17.0 and 27.5 % MAC. For normal operation, 15 knots excess end airspeed above minimum is recommended.

Correct stabilator trim is critical to aircraft hands off fly-away performance. Stabilator trim affects initial pitch rate and determines AOA capture. A low trim setting both lowers the initial pitch rate below optimum and causes the aircraft to fly away in a flatter attitude due to a lower than optimum AOA capture. This results in degraded climb performance after launch. A higher than recommended trim setting can cause excessive AOA overshoots which can lead to loss of lateral directional control when loaded with asymmetric stores, or in a single engine emergency.

WARNING

Use of catapult 4 is restricted with certain stores loaded on station 2. Refer to applicable launch bulletin.

The following trim settings are recommended:

Symmetrical loading -

- a. Directional trim - 0°
- b. Lateral trim - 0°
- c. Longitudinal trim - See figure 8-1

Asymmetrical loading -

- a. Directional trim - 0°
- b. Longitudinal trim (first) - See figure 8-1
- c. Lateral trim - See figure 8-1

WARNING

Failure to input differential stabilator trim for catapult launches with asymmetric stores can aggravate aircraft controllability.

8.2.6 Catapult Hook-Up. Before taxiing past the shuttle, aircraft gross weight should be verified, takeoff checklist complete, and arming completed by the ordnance crew if required. Check external fuel quantity. Approach the catapult track slowly, lightly riding the brakes, with nosewheel steering on. Use minimum power required to keep the aircraft rolling. Close attention to the plane director's signals is required to align the aircraft with the catapult track entry wye. When aligned, the plane director signals the pilot to lower the launch bar. Place the launch bar switch to EXTEND. The green LAUNCH BAR advisory light comes on and nosewheel steering disengages. Nosewheel steering low mode may be engaged while the launch bar is down by pressing and holding the nosewheel steering button. This should only be done on signal from the director since catapult personnel may be in close proximity to the launch bar. Do not use nosewheel steering once the launch bar enters the track. The catapult crew installs the holdback bar and the aircraft may taxi forward slowly, following the signals of the plane director. When the launch bar drops over the shuttle spreader, the aircraft will be stopped by the holdback bar engaging the catapult buffer. On aircraft 161353 THRU 161715, upon receipt of the "Release Brakes" signal, advance throttles to 85 % to 90 % rpm. Do not advance throttles to MIL at this time since this could retract the launch bar before it is trapped by the tensioned shuttle spreader. On aircraft 161716 AND UP, upon receipt of the "Release Brakes" signal, advance throttles to MIL.

WARNING

Check AOA when aligned on catapult. With MC OFP 13C AND UP, check AOA on the FCS page to ensure both values are less than +10°. With MC OFP 10A AND UP, ensure HUD AOA is less than 10°.

CATAPULT LONGITUDINAL TRIM

WEIGHT BOARD	NOSE UP TRIM
44,000 LBS AND BELOW	16 °
45,000 - 48,000 LBS	17 °
49,000 LBS AND ABOVE	19 °

NOTE

AIRCRAFT BEING LAUNCHED AT GROSS WEIGHTS OF 43,000 LBS AND ABOVE SHOULD TRIM BY 3 ° NOSE UP IF ADVISED TO EXPECT 10 KNOTS OR LESS EXCESS ENDSPEED.

HALF - FLAP - MIL/MAX POWER
CATAPULT LAUNCH LATERAL TRIM REQUIREMENTS
ASYMMETRIC EXTERNAL STORES

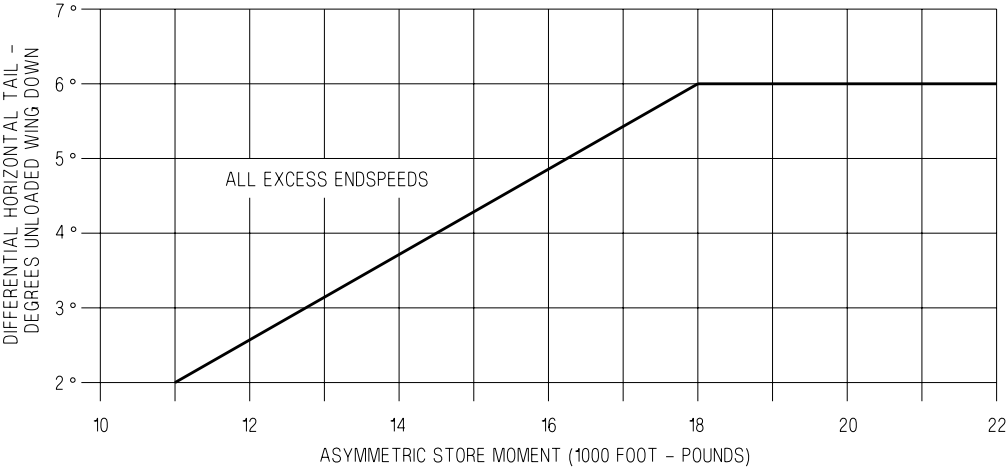

WARNING

FAILURE TO INPUT DIFFERENTIAL STABILATOR TRIM FOR CATAPULT LAUNCHES WITH ASYMMETRIC STORES CAN AGGRAVATE AIRCRAFT CONTROLLABILITY.

NOTE

REDUCE DIFFERENTIAL TRIM BY 2 ° IF CARRYING A SINGLE GBU-24.

Figure 8-1. Launch Trim

8.2.7 Catapult Afterburner Operation. Permissible catapult launch power settings depend on aircraft gross weight. At gross weights of 45,000 lbs and above, afterburner catapult shots are required. At gross weights of 44,000 lbs and below, three options are provided, allowing pilots to tailor the power settings to their needs. Military power launches minimize the impact of sustained afterburner operation on the ship's jet blast deflectors (JBDs) and reduce fuel consumption. Afterburner catapults improve aircraft sink-off-bow performance and single engine flyaway performance in case of an emergency. Stabilizing in military power while in catapult tension and selecting afterburner (MIL/MAX setting) at holdback release provides a compromise between single engine climb capability, fuel consumption and JBD compatibility. Performing a MIL to MAX afterburner transient results in only a small reduction of engine stall margin. If afterburner thrust is to be selected during the catapult stroke, advance throttles to MAX immediately following catapult holdback release. This maximizes the available time for the engines to stabilize prior to the end of the catapult stroke. The catapult settings for a MIL/MAX shot are identical to a MIL power shot, so there is no need for pilots to communicate their intention to exercise the MIL/MAX option to the catapult crew.

CATAPULT THROTTLE SETTINGS	
Weight Board	Engine Power
44,000 lbs and below	MIL MIL/MAX MAX
45,000 lbs and above	MAX

NOTE

- MIL/MAX power setting is defined as stabilizing in military power while in catapult tension, and selecting maximum afterburner at holdback release.
- Any engine experiencing self-clearing pop stalls due to steam ingestion during the catapult launch indicates the engine is operating at near the limits of available stall margin. Aircraft experiencing any pop stalls shall be launched at a stabilized power setting (MIL or MAX) and afterburner shall not be selected during a catapult launch, except in an emergency.
- In certain weather conditions with high humidity and cool temperature, with heavy steam coming out the catapult track there exists the possibility of fireballs coming out the exhaust at the end of the catapult shot. A possible cause of the fireball is momentary fan stall that recovers quickly and may not be detrimental to the engine. Ensure proper engine operation.

8.2.8 Catapult Launch.

WARNING

Do not catapult with partially full external fuel tank(s) less than 1,900 pounds.

When the “Final Turnup” signal is received from the catapult officer, advance throttles to MIL or MAX. On aircraft 161353 THRU 161715, the launch bar switch automatically returns to RETRACT and the green LAUNCH BAR advisory light goes out. On aircraft 161716 AND UP, place the launch bar switch to RETRACT. Cycle the flight controls, wait 4 seconds then ensure all warning and caution lights are out. If afterburners are to be used, select them on signal from the catapult officer. Check engine instruments. When satisfied that the aircraft is ready for launch, hold throttles firmly against the detent, place the head against the head-rest, and salute the catapult officer with the right hand.

WARNING

- The close proximity of the flap and launch bar switches may result in inadvertent selection of FLAPS UP vice launch bar up.
- Movement of the launch bar switch to RETRACT prior to the aircraft being fully tensioned may result in a mispositioned launch bar and subsequent launch bar/shuttle separation during catapult launch.

NOTE

Failure to place launch bar switch to retract may result in hydraulic seal failure.

Throttle friction may be used to help prevent inadvertent retraction of the throttles during the catapult stroke. If required, it can be overridden if afterburner is needed due to aircraft/catapult malfunction. Immediately after the end of the catapult stroke the aircraft will rotate to capture the trimmed AOA without control stick inputs. PIO can occur immediately after launch if the control stick is restrained during the launch or control inputs are made immediately after launch. The pilot should closely monitor the catapult sequence and be prepared to make corrections if required. Clearing turns should not be made until sufficient flying speed is attained. Retract the gear and flaps when a positive rate of climb is established.

NOTE

Engaging the ATC with throttle friction on may cause the system to disengage.

The longitudinal flight control system is designed to rotate the aircraft to a reference or capture AOA following catapult launch. Trim settings between 10° and 18° nose up correspond linearly to reference AOAs between 4° and 12°. Twelve degrees AOA is the highest AOA that can be commanded hands-off and setting trim above 18° nose up increases the initial pitch movement without changing the reference AOA. The single engine minimum control airspeed increases as AOA increases. The

recommended trim settings of paragraph 8.2.5 are designed to minimize aircraft sink-off-bow while maintaining AOA low enough so that lateral directional controllability is sufficient in the event of an engine failure. Normal catapult launches are characterized by an initial rotation as high as 13° AOA before AOA and pitch rate feedbacks reduce the AOA to the reference value. A range of 10 to 12° AOA is the optimum compromise between minimizing sink-off-bow and ensuring controllability in the event of an engine failure.

F/A-18 catapult launch endspeeds are determined by one of two limiting factors, single engine minimum control airspeed and sink-off-bow. At gross weights of 45,000 lbs and above, the minimum launch endspeed ensures that the aircraft will not sink excessively during the catapult flyaway. With normal endspeed (11 to 20 knots above minimum) and deck conditions, 4 to 6 feet of settle can be expected. The pilot perceives the catapult shot to be level, as the rotation of the aircraft keeps the pilot's eye approximately level, even though the aircraft center-of-gravity sinks. With zero excess endspeed, up to 20 feet of settle can be expected. For heavy weight shots which are planned with 10 knots or less excess endspeed, trim settings are increased 3° to help minimize the settle that will occur. This higher trim setting comes at the cost of reducing the margin of controllability should an engine fail. Therefore, the higher trim settings should only be used when advised by the ship that the shot will definitely have 10 knots or less excess endspeed. The higher trim settings bias the compromise between aircraft controllability and minimizing settle to favor minimizing settle, because in the case of a planned reduced endspeed shot, excessive settle is definitely going to occur, while the chance of an engine failure is no different than any other shot.

At gross weights of 44,000 lbs and below, the minimum launch endspeed is determined by the single engine minimum control airspeed. This endspeed is greater than the speed required to minimize sink-off-bow for that weight range. Therefore, catapult shots in this regime are characterized by greater climb rates than catapult shots at weights of 45,000 lbs and above. Little to no sink should be observed for nominal endspeed and deck conditions when launched at 44,000 lbs and below.

The single engine minimum control airspeed increases as asymmetry increases. Minimum launch endspeeds for weight boards of 37,000 lbs and above ensure sufficient airspeed to maintain aircraft control for asymmetric loadings up to and including 22,000 ft-lbs. For weight boards of 36,000 lbs and below, airspeed is only sufficient to guarantee controllability for up to 6,000 ft-lbs of asymmetry. Aircraft being launched at these weights must not exceed the 6,000 ft-lb asymmetry limit.

8.2.9 Catapult Suspend. To stop the launch while tensioned on the catapult, signal by shaking the head negatively and transmitting SUSPEND, SUSPEND on land/launch frequency. Do not use a thumbs down signal or any hand signal that might be mistaken for a salute. The catapult officer replies with a SUSPEND signal followed by an UNTENSION AIRPLANE ON CATAPULT signal. The shuttle spreader is moved aft and the launch bar automatically raises clear of the shuttle spreader. Maintain power at MIL/MAX until the catapult officer steps in front of the aircraft and signals THROTTLE BACK. The same signals are used when a catapult malfunction exists.

8.2.10 Landing Pattern. Refer to Chapter 4, for carrier operating limitations.



Carrier landing with more than 500 pounds in the centerline fuel tank is prohibited.

While maneuvering to enter the traffic pattern, attempt to determine the sea state. This information will be of value in predicting problems that may be encountered during the approach and landing.

Enter the carrier landing pattern (figure 8-2) with the hook down. Make a level break from a course parallel to the Base Recovery Course (BRC), close aboard to the starboard of the ship. Below 250 knots lower the gear and flaps. Descend to 600 feet when established downwind and prior to the 180° position. Complete the landing checklist and crosscheck angle-of-attack and proper airspeed. Pitch trim is set to 8.1° AOA when autopilot is disengaged while in the PA configuration if AOA is greater than 6.0°.

With a 30-knot wind over the deck begin the 180° turn to the final approach when approximately abeam the LSO platform. When the meatball is acquired, transmit “Call sign, Hornet, Ball or CLARA, fuel state (nearest 100 pounds) and auto” (if using ATC for approach). Refer to figure 8-3 for a typical Carrier Controlled Approach.

8.2.11 ATC Approach Mode Technique. The ATC approach mode should be engaged with the aircraft near on-speed. If fast when ATC is engaged, additional time may be required for on-speed capture. The technique required for an ATC approach mode differs from a manual approach in that all glideslope corrections are made by changing aircraft attitude. Since this technique violates the basic rule that altitude/glideslope is primarily controlled by the throttle, practice is required to use ATC. For the ATC to perform satisfactorily, smooth attitude control is essential. Large attitude changes result in divergent glideslope oscillations or overcontrolling power response. Close-in corrections are very critical. If large attitude correction for a high-in-close situation develops, the recommended procedure is to stop ball motion and do not attempt to recenter it. A low-in-close condition is difficult to correct with ATC and usually results in an over-the-top bolter. It may be necessary to manually override ATC in order to safely recover from a low-in-close condition. The force required to manually disengage ATC is significant and may prevent salvaging the pass. Throughout the approach the pilot should keep his hand on the throttles in the event it is necessary to manually disconnect/override the ATC.

8.2.12 Glideslope. The technique for flying the glideslope is basically the same as FCLP except that more power may be required to maintain glideslope, and line-up will be much harder to maintain. With rough seas and a pitching deck some erratic ball movement may be encountered. If this is the case, listen to the LSO's calls and average out the balls movement to maintain a safe controlled approach.

8.2.13 Waveoff. When the waveoff signal is received, immediately apply military/afterburner power and effect a slight nose rotation to stop the rate of descent. During an in-close waveoff, excessive rotation by the pilot will cause a cocked-up or over-rotated attitude which can result in an inflight engagement and possible aircraft damage.

Selecting afterburner during an “in close” or a technique waveoff, produces limited performance gains. FULL flap approach airspeed is essentially the same as the single engine afterburner minimum controllable airspeed. The asymmetric thrust from an asymmetric afterburner light-off of either the -400 or -402 engines during a “high coming down” or a “slow” approach may result in unacceptable yaw control and significant lineup deviations. Unintentional arrestment may result in damage to the aircraft and arresting gear.

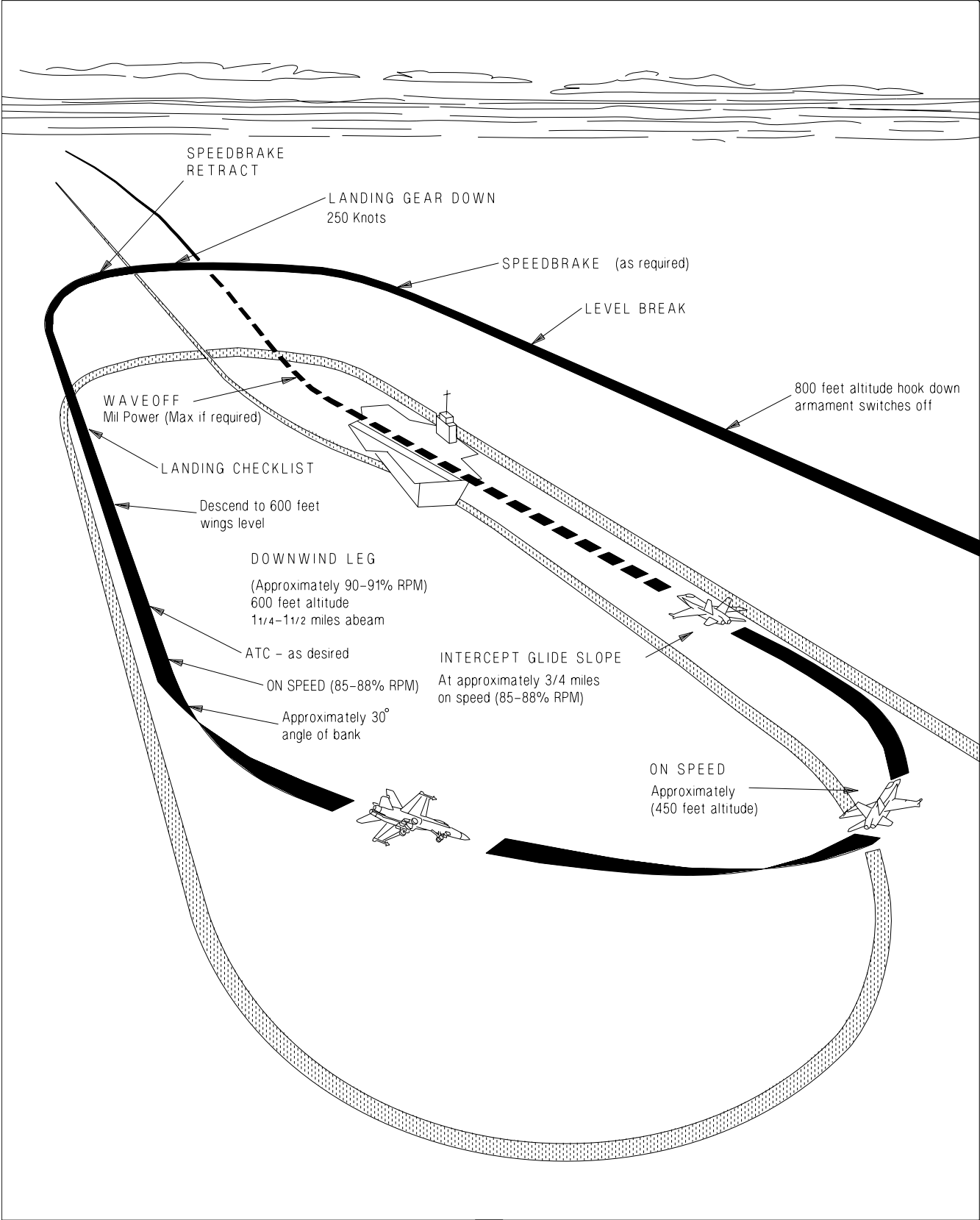

ADA520-46-1-045

Figure 8-2. Carrier Landing Pattern

VOICE REPORTS

- Entering holding
- Departing marshal
- 5,000 feet - SIDE NUMBER, PLATFORM
- 10 miles - SIDE NUMBER, 10 MILES
- Acquisition - SIDE NUMBER, HORNET, BALL OR CLARA
FUEL STATE, AUTO (only if ATC)
- * Non-precision (ASR) approach only. For precision (PAR) approach, maintain 1200 feet until directed to commence descent.

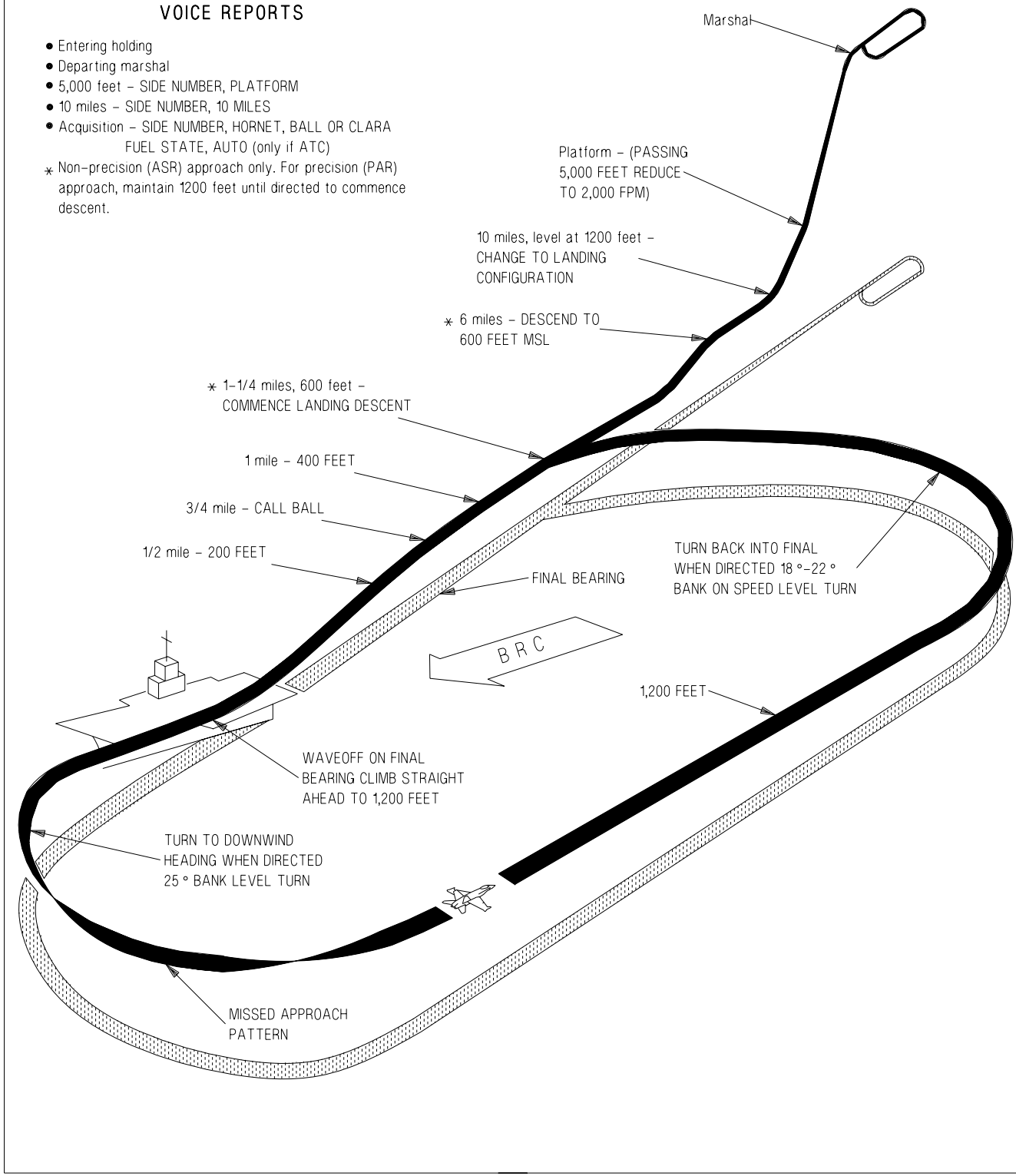

ADA520-47-1-045

Figure 8-3. Carrier Controlled Approach (CCA)

WARNING

An afterburner waveoff should be performed only during an extremely low approach or when in danger of a rampstrike.

8.2.14 ACL Mode 1 and 1A Approaches. A typical Mode 1 and 1A approach is shown in figure 8-4. The Mode 1/1A approach does not require automatic throttle control but it should be used, if available. The following procedure is for a typical Mode 1 and 1A approach from marshal to touchdown or 0.5 mile.

1. Horizontal indicator (HI/MPCD) - PRESS ACL
The Link 4 display appears on the left DDI and ACL mode automatically starts its self test. At this time, the ILS, data link, and radar beacon are automatically turned on (if not previously on); IBIT is run on the data link and radar beacon systems. Also, the uplinked universal test message is monitored for valid receipt.
2. On board ACL capability - CHECK ACL 1
ACL 1 must be displayed on the Link 4 display to accomplish a Mode 1 or 1A approach.

WARNING

A degraded augments may lead to a significant lineup error, most often right-of-centerline. ACL coupling with an augments DEGD is not inhibited.

3. Report departing marshal.
4. Normal CCA - PERFORM
Descend at 4,000 feet per minute and 250 knots to 5,000 feet, (platform) then reduce rate of descent to 2,000 feet per minute. When passing through approximately 5,000 feet, ILS steering is automatically displayed on the HUD and must be manually deselected, if not desired.
 - a. At 5,000 feet, report - SIDE NUMBER, PLATFORM
 - b. Continue descent to 1,200 feet MSL.
 - c. At 10 miles, report - SIDE NUMBER, 10 MILES
5. Landing checklist - COMPLETE AT 10 MILES
 - a. Slow to approach speed at 6 miles.
6. Automatic throttle control - ENGAGE
7. Radar altitude hold - ENGAGE (if desired)
ACL acquisition occurs at approximately 3.5 to 5 miles and is indicated by ACL RDY on the DDI and the data link steering (TADPOLE) on the HUD. It is desired, but not required, to have ACL coupled at least 30 seconds before tipover. T/C is replaced by MODE 1 on the link 4 display.

After ACL Acquisition -

8. On the upfront control, CPL button - PRESS TWICE
Traffic control must be decoupled by pressing CPL and then CPL must be pressed a second time to couple ACL. When the aircraft is not coupled, ACL RDY is displayed on the HUD. ACL couple is indicated by CMD CNT and MODE 1 on the DDI and CPLD P/R on the HUD. At this time, the uplinked command displays of heading, airspeed, altitude, and rate of descent are removed from the DDI and HUD.
9. When coupled, report - SIDE NUMBER, COUPLED
10. When aircraft responds to automatic commands, report - SIDE NUMBER, COMMAND CONTROL

Mode 1A Approach -

11. At 0.5 mile, the controller or pilot may downgrade the approach to Mode 2. Continue manually with the approach and make a visual landing.
 - a. Uncouple, report - SIDE NUMBER, HORNET, BALL or CLARA, FUEL STATE.



The paddle switch should be activated to ensure reversion to CAS operation. Extreme pitch-axis PIO will result if the approach is continued with autopilot inadvertently engaged.

Mode 1 Approach -

12. At 0.5 mile controller advises the pilot to call the ball. Report - SIDE NUMBER, HORNET, COUPLED, BALL or CLARA, FUEL STATE.
13. At approximately 12.5 seconds before touchdown, the uplinked 10 SEC is displayed on the DDI and HUD.
14. After touchdown, ACL and automatic throttles are disengaged.

NOTE

After Mode 1 or 1A downgrade or touch-and-go, actuate the paddle switch to ensure complete autopilot disengagement.

8.2.15 ACL Mode 2 Approach. A typical ACL Mode 2 approach is shown in figure 8-5. For a Mode 2 approach, the HUD data link steering is used to fly a manual approach.

1. Horizontal indicator (HI) - PRESS ACL
The link 4 display appears on the left DDI and the ACL mode starts its self test. At this time, the ILS, data link, and radar beacon are turned on (if not previously on); IBIT is run on the data link and radar beacon systems. Also, the autopilot mode is engaged and the unlinked universal test message is monitored for valid receipt.

2. Onboard ACL capability - CHECK ACL OR ACL 2
Either ACL 1 OR ACL 2 may be displayed for Mode 2 approach.
3. Normal CCA - PERFORM
Descend at 4,000 feet per minute and 250 knots to 5,000 feet, then reduce rate of descent to 2,000 feet per minute. When passing through approximately 5,000 feet, ILS steering is displayed on the HUD and must be manually deselected, if not desired.
 - a. At 5,000 feet, report - SIDE NUMBER, PLATFORM
 - b. Continue descent to 1,200 feet MSL.
 - c. At 10 miles, report - SIDE NUMBER, 10 MILES
4. Landing checklist - COMPLETE AT 10 MILES
 - a. Slow to approach speed at 6 miles.
5. Automatic throttles - ENGAGE (if desired)
6. Radar altitude hold - ENGAGE (if desired) ACL
Acquisition occurs at approximately 3.5 to 5 miles and is indicated by ACL RDY on the DDI and data link steering (TADPOLE) on the HUD

After acquisition -

7. Report - SIDE NUMBER, NEEDLES
8. Link 4 display - CHECK MODE 1 OR MODE 2
9. At 0.75 mile, report - SIDE NUMBER, HORNET, BALL or CLARA, FUEL STATE.

8.2.16 Arrested Landing and Exit From the Landing Area. Fly the aircraft on the glideslope and ON-SPEED all the way to touchdown. Advance the throttles to MIL as the aircraft touches down. When forward motion has ceased reduce power to IDLE and allow the aircraft to roll aft. Apply brakes on signal. Raise the hook when directed. If the wire does not drop free, drop the hook when directed, and allow the aircraft to be pulled aft. Raise the hook again on signal.

When the come ahead signal is received add power, release brakes, and exit the landing area cautiously and expeditiously. Fold the wings unless directed otherwise.

If one or both brakes fail, use the emergency brakes, advise the tower and drop the arresting hook. Taxi the aircraft as directed. Do not use excessive power. Once spotted, keep the engines running until the CUT signal is given by the plane director and the minimum required number of chocks or tiedown chains are installed.

8.3 NIGHT OPERATIONS

8.3.1 General. Night carrier operations have a much slower tempo than daylight operations and it is the pilot's responsibility to maintain this tempo. Standard daytime hand signals from deck crew to pilot are executed with light wands. The procedures outlined here are different from, or in addition to, normal day carrier operations.

VOICE REPORTS

- Entering holding
- Departing marshal
- 5,000 feet - SIDE NUMBER, PLATFORM
- 10 miles - SIDE NUMBER, 10 MILES
- Data link steering - NEEDLES
- With CMD CNT - SIDE NUMBER, COUPLED
- Aircraft responding - SIDE NUMBER, COMMAND CONTROL
- 200 feet, 1/2 mile - SIDE NUMBER, HORNET, BALL OR CLARA, FUEL STATE, COUPLED (if Mode 1)

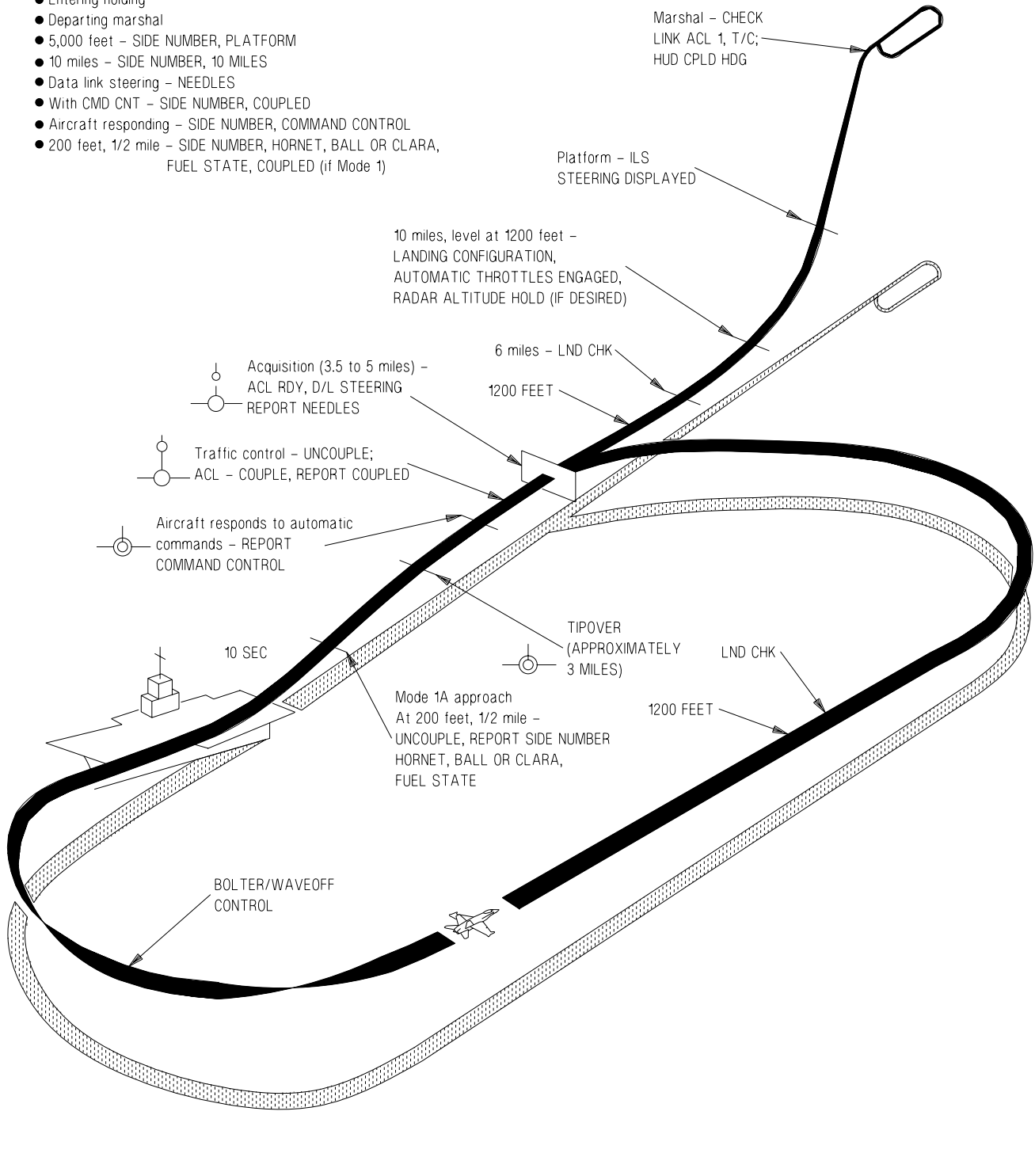

ADA520-48-1-044

Figure 8-4. ACL Mode 1 and 1A Approaches

VOICE REPORTS

- Entering holding
- Departing marshal
- 5,000 feet - SIDE NUMBER, PLATFORM
- 10 miles - SIDE NUMBER, 10 MILES
- Data link steering - SIDE NUMBER, NEEDLES
- 3/4 miles - SIDE NUMBER, HORNET, BALL OR CLARA, FUEL STATE, AUTO (only if ATC)

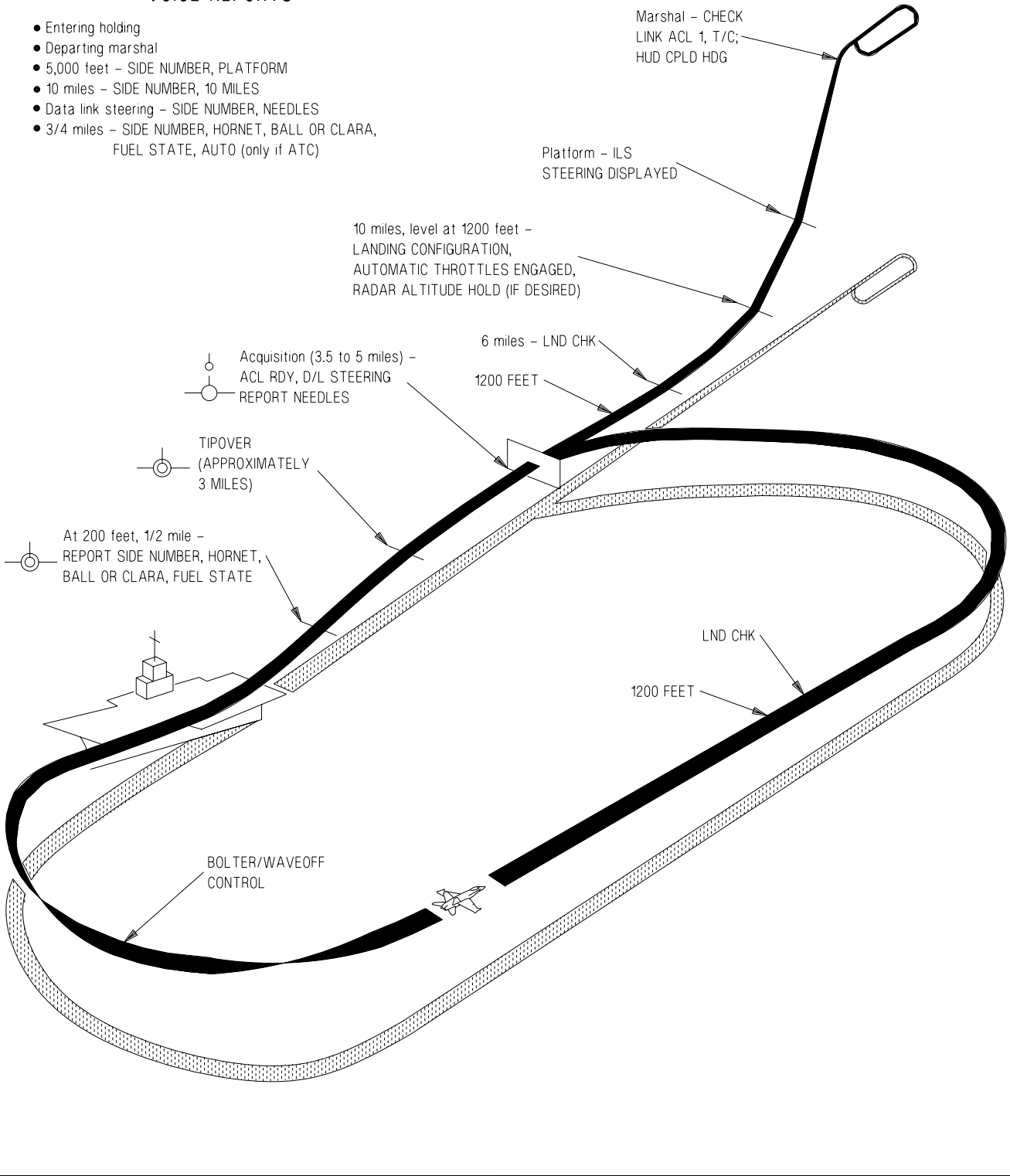

ADA520-49-1-044

Figure 8-5. ACL Mode 2 Approach

8.3.2 Preflight. Conduct the exterior preflight using a white lensed flashlight. Ensure that the exterior lights are properly positioned for launch and the external lights master switch OFF before engine start. Ensure that instrument and console light rheostats are on. This reduces brilliance of the warning and advisory lights when the generators come on.

8.3.3 Before Taxi. Adjust cockpit lighting as desired and perform before taxi checks.

8.3.4 Taxi. Slow and careful handling by aircraft directors and pilots is mandatory. If any doubt exists as to the plane director's signals, stop the aircraft. At night it is very difficult to determine speed or motion over the deck; rely on the plane director's signals and follow them closely.

8.3.5 Catapult Hook-Up. Maneuvering the aircraft for catapult hook-up at night is identical to that used in day operations; however, it is difficult to determine speed or degree of motion over the deck.

8.3.6 Catapult Launch. On turn-up signal from the catapult officer, ensure throttles are in MIL or MAX and check all instruments. Ensure that launch bar switch is in the retract position. When ready for launch, place external lights master switch ON.

All lights should be on bright with the strobes on. If expecting to encounter instrument meteorological conditions shortly after launch, the strobes may be left off at the discretion of the pilot.

After launch, monitor rotation of the aircraft to 12° nose up crosschecking all instruments to ensure a positive rate of climb. When comfortably climbing, retract the landing gear and flaps and proceed on the departure in accordance with ship's procedures. The standby attitude reference indicator should be used in the event of a HUD failure.

8.3.7 Aircraft or Catapult Malfunction. If a no-go situation arises, do not turn on the exterior lights and transmit SUSPEND, SUSPEND. Maintain MIL/MAX power until the catapult officer walks in front of the wing and gives the throttle-back signal. If the external lights master switch has been placed on prior to ascertaining that the aircraft is down, transmit SUSPEND, SUSPEND and turn off the exterior lights and leave the throttles at MIL until signaled to reduce power.

8.3.8 Landing Pattern. Night and instrument recoveries normally are made using case III procedures in accordance with the CV NATOPS Manual.

8.3.9 Arrestment and Exit From the Landing Area. During the approach all exterior lights should be on with the exception of taxi/landing light. Following arrestment, immediately turn the external lights master switch off. Taxi clear of the landing area following the plane director's signals.

8.4 SECTION CCA

A section CCA may be necessary in the event a failure occurs affecting navigation aids, communications equipment, or other aircraft systems.

Normally, the aircraft experiencing the difficulty flies the starboard wing position during the approach. The section leader detaches the wingman when the meatball is sighted and continues straight ahead, offsetting as necessary to the left to determine if the wingman lands successfully. Lead shall continue descending to not lower than 300 feet and turn on all lights to bright and strobes on. This provides the wingman with a visual reference in the event of a bolter or waveoff. The wingman should not detach until the meatball is in sight. If the wingman fails to arrest, the leader begins a climb to 1,200 feet or remains VFR at 150 knots during the rendezvous, but in no case should a rendezvous be attempted below non-precision minimums. The rendezvous should be completed before any turns are

made to begin another approach. If the weather is below non-precision minimums, the wingman should expect to climb to VFR-on-top, heading for the nearest divert field. The leader joins the wingman as vectored by CATCC. Necessary lighting signals between aircraft are contained in Chapter 26.

NOTE

A section penetration should not be made to the ship with less than non-precision minimums.

CHAPTER 9

Special Procedures

9.1 FORMATION FLIGHT

9.1.1 Formation Taxi/Takeoff. During section taxi, ensure adequate clearance between flight lead's stabilator and wingman's wing/missile rail is maintained. For formation takeoff, all aspects of the takeoff must be prebriefed by the flight leader. This should include flap settings, use of nosewheel steering, power changes, power settings, and signals for actuation of landing gear, flaps, and afterburner. The leader takes position on the downwind side of the runway with other aircraft in tactical order, maintaining normal parade bearing. See figure 9-1. For three-aircraft formations, line up with the lead on the downwind side, number 2 on the centerline, and number 3 on the upwind side. Wingtip/launch rail overlap should not be required but is permitted if necessary. For four-plane formations, line up with the lead's section on the downwind half of the runway and other section on the upwind half. After Before Takeoff checks are completed and the flight is in position, each pilot looks over the next aircraft to ensure the speedbrake is retracted, the flaps are set for takeoff, all panels are closed, no fluids are leaking, safety pins are removed, rudders are toed-in, nosewheel is straight and the launch bar is up. Beginning with the last aircraft in the flight, a "thumbs up" is passed toward the lead to indicate "ready for takeoff".

9.1.1.1 Section Takeoff. Engines are run up to approximately 80%, instruments checked, and nosewheel steering low gain ensured. On signal from the leader, brakes are released, throttles are advanced to military power minus 2% rpm. If afterburner is desired, the leader may go into mid range burner immediately without stopping at military power. Normal takeoff techniques should be used by the leader, with the wingman striving to match the lead aircraft attitude as well as maintain a position in parade bearing with wingtip separation. The gear and flaps are retracted on signal. Turns into the wingman are not to be made at altitudes less than 500 feet above ground level. When both sections begin takeoff roll from the same point on the runway, the second section must delay takeoff roll until 10 seconds after the first section starts the takeoff roll. When 2,000 feet of runway separation exists at the beginning of takeoff roll, use a 5-second delay instead of 10 seconds.

9.1.2 Aborted Takeoff. In the event of an aborted takeoff, the aircraft aborting must immediately notify the other aircraft. The aircraft not aborting should add max power and accelerate ahead and out of the way of the aborting aircraft. This allows the aborting aircraft to steer to the center of the runway and engage the arresting gear, if required.

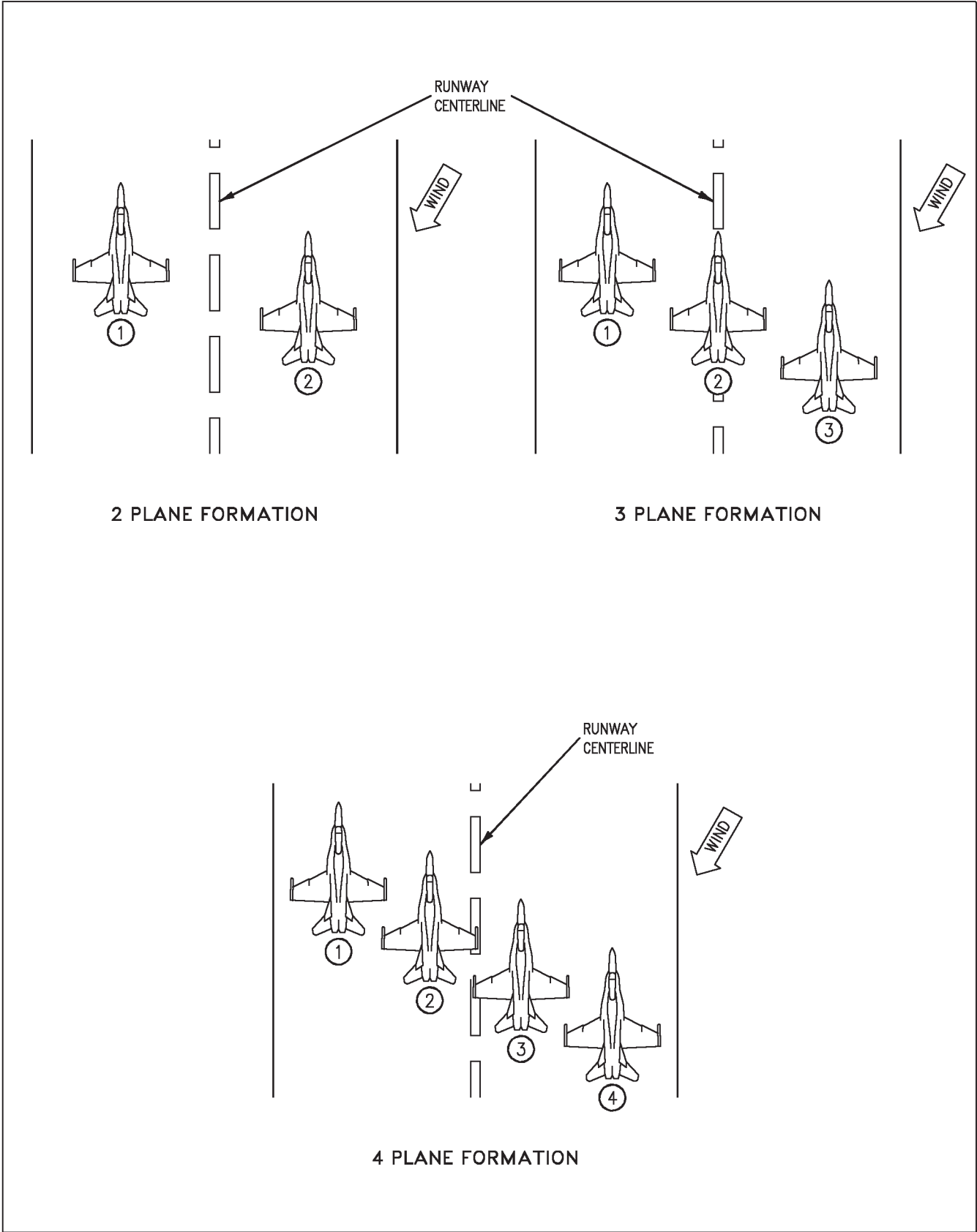

18AC-NFM-00-(50-1)31-CAT1

Figure 9-1. Formation Takeoff Runway Alignments

9.1.3 Parade. The parade position is established by aligning the bottom wingtip light (located about in the middle of the missile rail) with the light on the LEX. Superimposing the two establishes a bearing line and step down. Proper wingtip clearance is set by reference to the exhaust nozzles. When the left and right nozzles are aligned so that there is no detectable curve to the nozzles, the reference line is correct. The intersection of the reference line with the bearing line is the proper parade position. See figure 9-2.

Parade turns are either standard (VFR) or instrument turns. During day VFR conditions, turns away from the wingman are standard turns. To execute, when lead turns away, the wingmen roll the aircraft about its own axis and increase power slightly to maintain rate of turn with the leader. Lateral separation is maintained by increasing g. Proper step down is maintained by keeping the leads fuselage on the horizon.

Turns into the wingmen and all IFR or night turns in a parade formation are instrument turns. During instrument turns maintain a parade position relative to the lead throughout the turn.

After initially joining up in echelon, three and four-plane formations normally use balanced parade formation. In balanced parade, number 3 steps out until the exhaust nozzles on number 2 are flush. This leaves enough space between number 3 and lead for number 2 to cross under into echelon.

When it is necessary to enter IFR conditions with a three or four-plane formation, the lead directs the flight to assume fingertip formation. In this formation number 3 moves up into close parade on the lead. All turns are instrument turns.

9.1.4 Cruise Formation. The cruise position is a looser formation which allows the wingmen more time for visual lookout. Cruise provides the wingmen with a cone of maneuver behind the leader which allows the wingman to make turns by pulling inside the leader and requires little throttle change.

The cruise position is defined by a line from the lead pilot's head, through the trailing edge of the wingtip missile rail, with 10 feet of nose to tail separation. The wingmen are free to maneuver within the 70° cone established by that bearing line on either wing. In a division formation, number 3 should fly the bearing line, but always leave adequate room for number 2 and lead. Number 4 flies cruise about number 3.

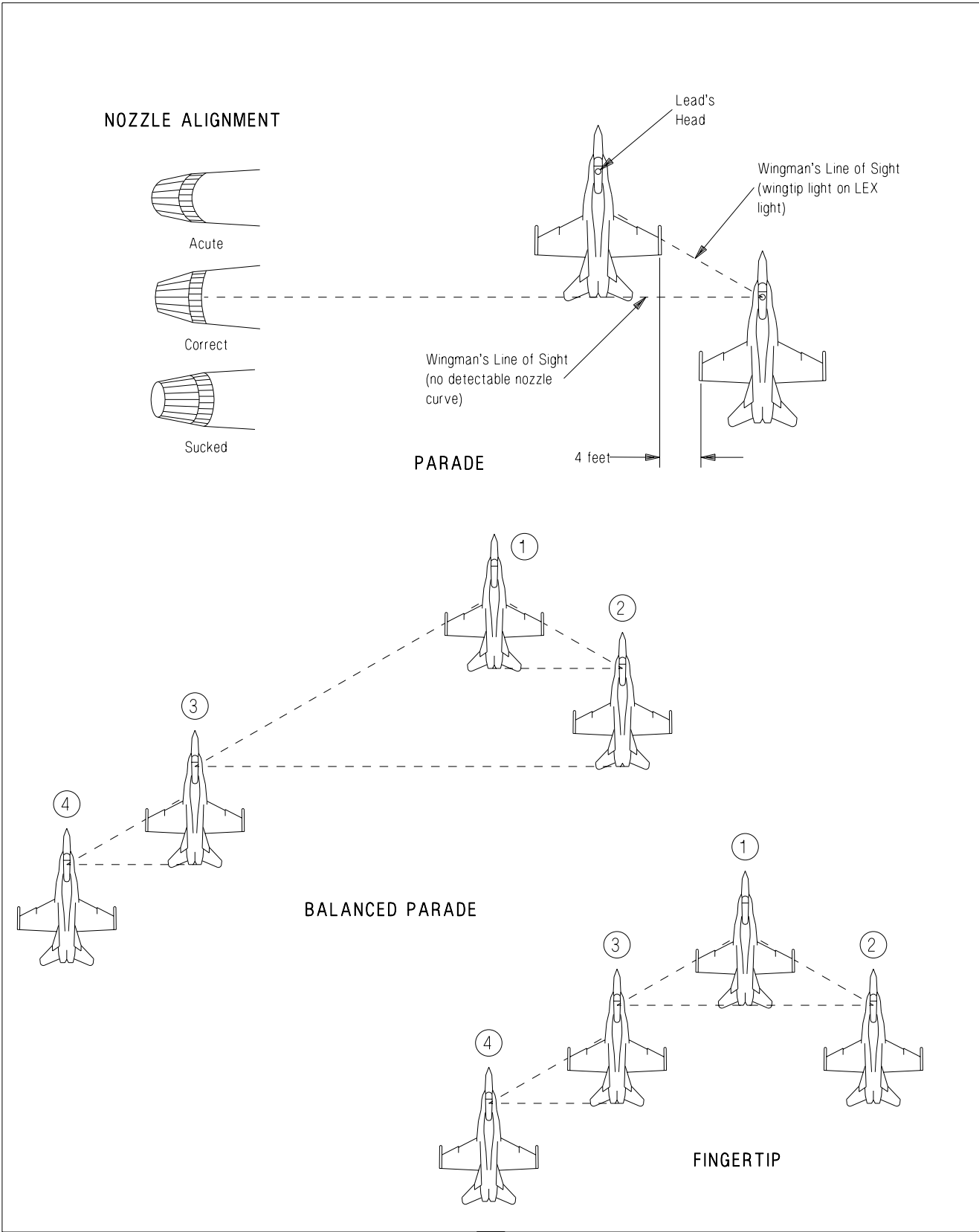

ADA520-51-1-045

Figure 9-2. Formations (Sheet 1 of 2)

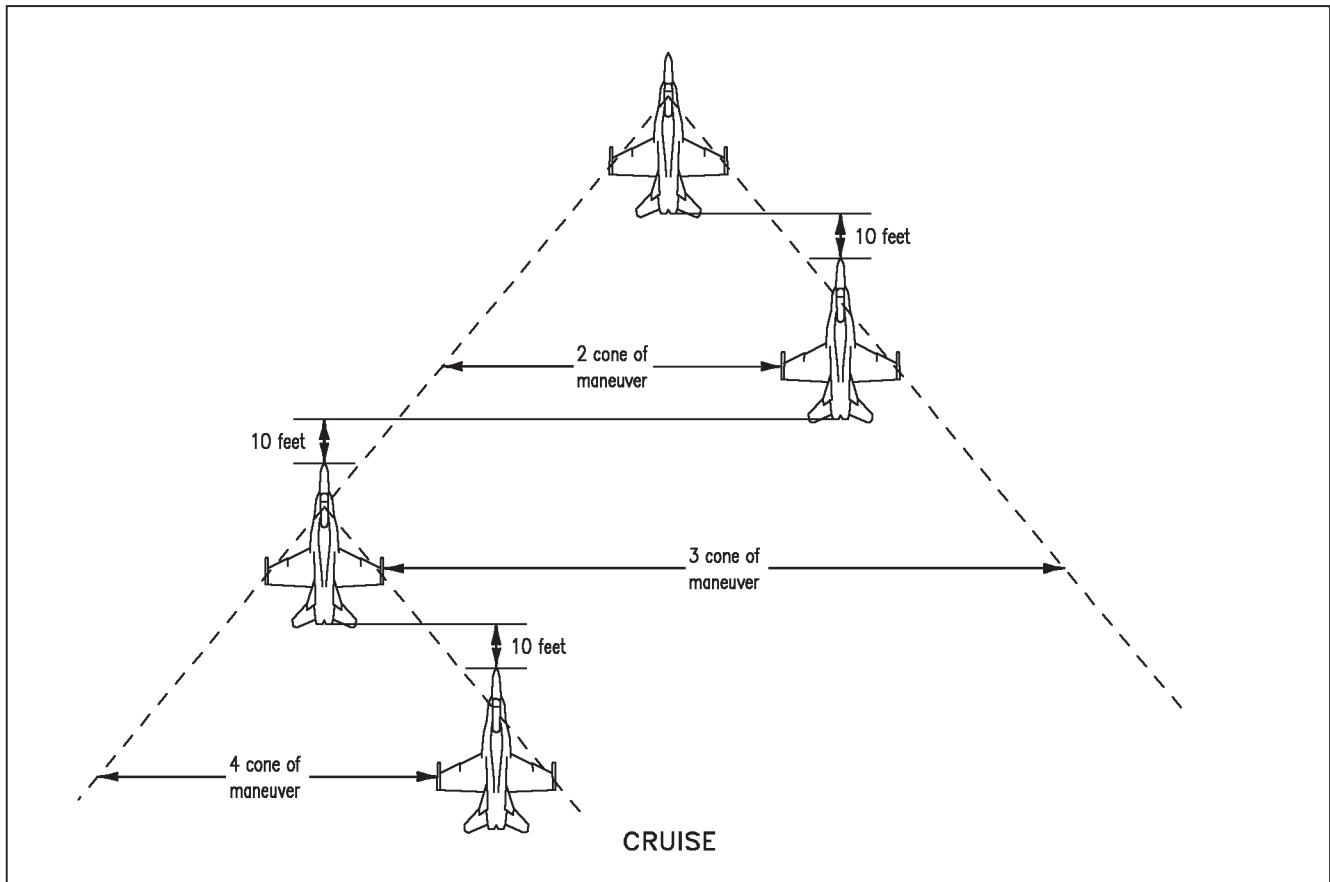

18AC-NFM-00-(51-2)31-CAT1

Figure 9-2. Formations (Sheet 2 of 2)

9.1.5 Section Approaches/Landing. The aircraft is comfortable to fly in formation, even at the low airspeeds associated with an approach and landing. The rapid power response enhances position keeping ability. The formation strip lighting provides a ready visual reference at night and the dual radios generally ensure that intra-flight comm is available.

During section approaches all turns are instrument turns about the leader. When a penetration is commenced the leader retards power to 75 % rpm and descends at 250 knots. If a greater descent rate is required the speedbrake may be used. Approximately 5 miles from the final approach fix or GCA pickup the lead gives the signal for landing gear.

9.1.5.1 Section Landing. If a section landing is to be made, lead continues to maintain ON-SPEED for the heavier aircraft and flies a ball pass to touchdown on the center of one side of the runway. Wingman flies the normal parade position taking care not to be stepped up.

When "in-close", wingman adds the runway to his scan and takes a small cut away from the lead to land on the center of the opposite side of the runway while maintaining parade bearing. Use care to ensure that drift away from the lead does not become excessive for the runway width. Remember, flying a pure parade position still allows 4 feet of wingtip clearance.

The wingman touches down first and decelerates on his half of the runway as an individual. Do not attempt to brake in section. If lead must cross the wingman's nose to clear the duty, the wingman calls "clear" on comm 2 when at taxi speed and with at least 800 feet between aircraft. The lead stops after clearing the runway and waits for the wingman to join for section taxi.

9.2 AIR REFUELING

Air refueling shall be conducted in accordance with NATO publication ATP-56, Air-To-Air Refueling Procedures.

NOTE

The KC-10, KC-130, KC-135, F/A-18E/F, and S-3 with D-704 or 31-300 buddy stores are authorized tankers for air refueling. Maximum refueling pressure is 55 psi.

9.2.1 Before Plug-in. Complete the air refueling checklist before plug in.

1. Radar - STBY/SILENT/EMCON
2. MASTER ARM switch - SAFE
3. Internal wing fuel switch - AS DESIRED

4. External tanks - AS DESIRED

If engine feed tank fuel level is critical, external wing and centerline transfer should be in STOP or ORIDE to ensure the fastest transfer of fuel to the engine feed tanks.

5. Air refuel PROBE switch - EXTEND
6. Visor - RECOMMENDED DOWN

For night air refueling -

7. Exterior lights - STEADY BRIGHT
8. Tanker lights - AS DESIRED

9.2.2 Refueling Technique.

NOTE

The following procedures, as applied to tanker operation, refer to single drogue refuelers.

Refueling altitudes and airspeeds are dictated by receiver and/or tanker characteristics and operational needs, consistent with the tanker's performance and refueling capabilities. This, generally, covers a practical spectrum from the deck to 40,000 feet and 175 to 300 knots while engaged.

NOTE

For KC-135 aircraft, the following parameters are recommended:

Airspeed - 200-275 knots/Mach 0.8, whichever is less
Closure rate - 2 knots or less

9.2.2.1 Approach.



Be careful to avoid damaging the right AOA probe by contact with basket or hose. If the probe is damaged, it will cause a 4 channel AOA failure.

Once cleared to commence an approach, refueling checklists completed, assume a position 10 to 15 feet in trail of the drogue with the refueling probe in line in both the horizontal and vertical reference planes. Trim the aircraft in this stabilized approach position and ensure that the tanker's (amber) ready light is on before attempting an approach. Select a reference point on the tanker as a primary alignment guide during the approach phase; secondarily, rely on peripheral vision of the drogue and hose. Increase power to establish minimum closure rate on the drogue not to exceed 5 knots. An excessive closure rate causes a violent hose whip following contact and/or increase the danger of structural damage to the aircraft in the event of misalignment; whereas, too slow a closure rate results in the pilot fencing with the drogue as it oscillates in close proximity to the aircraft nose. During the final phase of the approach, the drogue has a tendency to move slightly upward and to the right as it passes the nose of the receiver aircraft due to the aircraft-drogue airstream interaction. Small corrections in the approach phase are acceptable; however, if alignment is off in the final phase, it is best to immediately retire to the initial approach position and commence another approach, compensating for previous misalignment by adjusting the reference point selected on the tanker. Make small lateral corrections with the rudder, and vertical corrections with the stabilator. Avoid any corrections about the longitudinal axis since they cause probe displacement in both the lateral and vertical reference planes.

9.2.2.2 Missed Approach. If the receiver probe passes forward of the drogue basket without making contact, initiate a missed approach immediately. If the probe impinges on the rim of the basket and tips it, initiate a missed approach. A missed approach is executed by reducing power and backing to the rear at a 3 to 5 knot opening rate. By continuing an approach past the basket, a pilot might hook the probe over the hose and/or permit the drogue to contact the receiver aircraft fuselage. Either of these hazards require more skill to calmly unravel the hose and drogue without causing further damage than to make another approach. If the initial approach position is well in line with the drogue, the chance of hooking the hose is diminished when last minute corrections are kept to a minimum. After executing a missed approach, analyze previous misalignment problems and apply positive corrections to avoid a hazardous tendency to blindly stab at the drogue.

9.2.2.3 Contact. When the receiver probe engages the basket, it seats itself into the drogue coupling and a slight ripple is evident in the refueling hose. The drogue and hose must be pushed forward 3 to 5 feet by the receiver probe before fuel transfer can be effected. This position is evident by the tanker's (amber) ready light going out and the (green) fuel transfer light coming on. While plugged-in, fly a close tail chase formation on the tanker. Although this tucked-in condition restricts the tanker's maneuverability, gradual changes involving heading, altitude and/or airspeed may be made. A sharp lookout doctrine must be maintained due to the precise flying imposed on both the tanker and receiver pilots. In this respect, the tanker can be assisted by other aircraft in the formation.

9.2.2.4 Disengagement. Disengagement from a successful contact is accomplished by reducing power and backing out at a 3 to 5 knot separation rate. Maintain the same relative alignment on the tanker as upon engagement. The receiver probe separates from the drogue coupling when the hose reaches full extension. When clear of the drogue, place the refueling probe switch in the RETRACT

position. Ensure that the PROBE UNLK caution display is out before resuming normal flight operations.

9.3 BANNER TOWING SYSTEM

9.3.1 Banner Towed Target Equipment. The aerial banner tow target equipment consists of a tow adapter, a standard TDU-32/B 8.5 X 40 foot aerial banner target and approximately 1,500 feet of 11/64-inch armored cable towline, fitted at both ends with a MK-8 tow ring for military takeoffs. Afterburner operations require a 75-foot leader of 3/8 inch diameter steel cable attached to the tow cable.

The tow adapter is installed on the hinge point assembly of the tail hook by ground crew personnel. Pilot action is not required for banner hookup. The banner is released in flight or on deck by lowering the tail hook.

9.3.2 Ground Procedures. The following procedures are provided for guidance. Local course rules may dictate modifications of these steps.

1. When tower clearance onto the duty runway is received, the tow aircraft taxis to a position as directed by the tow hookup crew. The tow pilot holds the position until released by the tow hookup crew. The escort pilot maintains position on the taxiway at the approach end of the runway.
2. When signaled to do so by the tow hookup crew, the tow pilot proceeds to taxi down the runway.
3. Upon receipt of a visual taxi signal from the tow hookup crew to "slow down", the escort pilot relays this signal to the tow pilot via UHF radio.
4. Upon receipt of a visual taxi signal from the tow hookup crew to "stop", the escort pilot relays this signal to the tow pilot via his UHF radio.
5. Upon receipt of a signal from the tow hookup crew that the "tow hookup is complete", the escort pilot requests the tow pilot to "take up slack".
6. The tow pilot proceeds to taxi down the runway.
7. When the banner moves forward onto the runway, the escort pilot transmits "tow aircraft hold-good banner" and taxis onto the runway abeam the banner for takeoff.
8. When ready, the tow pilot transmits "Tower, Lizard 616 for banner takeoff, escort follow on a good banner".
9. After the banner becomes airborne, the escort pilot commences takeoff roll.

9.3.3 Flight Procedures. Flight tests have demonstrated no significant degradation of performance and handling characteristics when towing a banner.

NOTE

Angle of bank should be limited to 40°.

9.3.3.1 Takeoff. Normal MIL power takeoff procedures, including rotation speeds and techniques, are suitable when towing the banner, and are recommended except when operating in high ambient temperatures or at high density altitude airfields. When the steel cable leader is added to the tow cable, takeoff can be made at MAX power.



- Takeoff ground roll with banner can be estimated by adding a factor of 10 % to basic aircraft takeoff performance. If aircraft lift-off does not occur prior to crossing the long field arresting gear, the gear must be removed to preclude the banner being torn off.
- When using afterburner, the aircraft nose should be held on deck until 10 knots past flying speed to minimize cable time in the afterburner plume. If the crosswind component exceeds 10 knots, the takeoff roll should be made on the upwind side of the runway centerline to prevent the banner from drifting close to the runway edge lights on the downwind side of the runway.

NOTE

If takeoff is aborted, basic emergency procedures are applicable. The tow cable releases when the tailhook is lowered.

After lift-off, the initial climb attitude to 1,200 feet AGL varies with existing weather conditions. However, an initial pitch attitude of 15 to 20° is a good starting point. Afterburner operation requires a 5 to 10° higher pitch attitude. Do not exceed 25° of pitch attitude. Select landing gear UP and flaps AUTO when definitely airborne. Climb out at 200 to 220 knots.

NOTE

Tow airspeeds in excess of 220 knots result in excessive banner fraying.

9.3.3.2 Cruise/Pattern. No special pilot techniques are required when towing a banner. Enroute cruising speed of 180 to 220 knots provides adequate energy for mild maneuvering while minimizing banner fray. ATC is effective for airspeed control. The tow aircraft must call all turns to allow the chase to position on the outside of the turn.

A rectangular icon with a thick black border containing the word "WARNING" in bold, uppercase letters.

WARNING

Without the banner, any remaining cable flails unpredictably and could damage the aircraft. The chase should approach the tow aircraft from abeam to verify cable failure, avoiding a cone-shaped area defined by the tow's 4 to 8 o'clock positions. The tow aircraft should then lower the tail hook as soon as practical.

9.3.3.3 Descent. Descend at 160 to 220 knots. Use speedbrake as desired to increase the rate of descent.

9.3.3.4 Banner Drop. Banner drop speed should be accomplished at a comfortable airspeed below 200 knots. Drop the banner in wings level flight at a minimum of 500 feet AGL. The chase should ensure adequate clearance exists between the banner and ground obstacles during approach to the drop zone and provide calls to assist in line-up. Release is normally called by the tower when the banner is over the center of the drop zone. Release is accomplished by lowering the tailhook. Because of the low release altitude, crosswind has no appreciable effect on the banner impact point (i.e., the banner hits down range of the release point). Following banner release, raise the tailhook.

9.3.3.5 Banner Release Failure. If the arresting hook fails to extend, the banner cannot be released. In this case, the following procedure is recommended:

1. Select full afterburner while increasing AOA in an attempt to burn through the cable.

If cable remains -

2. In the gunnery range (or other cleared area), descend to lower altitude and slow to a comfortable airspeed below 200 knots maximum and 100 to 200 feet AGL. This drags the banner off on the ground (or water). Have the escort pilot confirm that the banner breaks off on ground collision and determine the length of the remaining tow cable.

WARNING

The escort pilot must remain well clear of the remaining cable. The last 25 % of the remaining cable flails unpredictably.

3. If 100 feet or greater remaining tow cable length is confirmed by the escort pilot, plan to touchdown 1,000 to 1,500 feet long, runway length permitting.

CAUTION

Every effort must be made by the tow pilot not to drag the remaining tow cable across lines, fences, etc., due to property damage that will result.

NOTE

The long touchdown should be carefully planned because arrestment is impossible.

9.3.4 Target Chase Procedures.

9.3.4.1 Primary Chase Responsibilities

1. Advise tow pilot of conditions of banner and tow line.
2. Provide additional visual lookout.
3. Provide additional warning to other aircraft by positioning his aircraft near the banner.
4. Provide line-up calls to tow pilot during banner drop.

9.3.4.2 Chase Position

1. Approximately 100 to 200 feet abeam the banner at an altitude equal to or greater than the banner.
2. The chase remains on the outside of all turns to ensure clearance from the banner and prevent loss of airspeed during turns.
3. If IMC is encountered, the chase should move forward and fly wing on tow until VMC.

9.4 NIGHT VISION DEVICE (NVD) OPERATIONS

9.4.1 Effects on Vision. Flight techniques and visual cues used during unaided night flying also apply to flying with NVDs. The advantage of NVD is improved ground reference provided through image intensifier systems (NVG/NAVFLIR). Dark adaptation is unnecessary for the effective viewing through night vision goggles (NVG). In fact, viewing through the NVG for a short period of time shortens the normal dark adaptation period. After using NVG, it takes the average individual 1 to 3 minutes to reach the 30 minute dark adaptation level. Color discrimination is absent when viewing the NVG image. The image is seen in a monochromatic green hue and is less distinct than normal vision. Prolonged usage may result in visual illusions upon removal of the NVG. These illusions include complement or green after-images when viewing contrasting objects. Illusions from NVG are temporary and normal physiological phenomena and the length of time the effects last vary with the individual.

WARNING

- Ejection wearing night vision goggles is not recommended. Severe neck injury may result.
- Aircrew are strongly cautioned against maneuvering above 3 g with the AN/AVS-9 in the up-locked (not in use but on helmet) position because the NVD bracket cannot retain AN/AVS-9 under elevated g loads.

9.4.2 Effects of Light. Any non-NVG compatible light source in the cockpit degrades the ability to see with NVG. In aircraft 163985 AND UP, filters are used to prevent stray or scattered light from reaching the NVG intensifiers, which would cause the automatic gain control to reduce the NVG image intensification. Head down displays (DDI, MPCD) are filtered to allow non-electrical-optical viewing of the display. Viewing areas illuminated by artificial light sources with NVG (runway/landing lights, flares, or aircraft position lights) limit the ability to see objects outside of the area.

NOTE

Bright ground lights may cause loss of ground references during landing. Avoid looking directly at bright light sources to prevent degrading NVG vision.

The NAVFLIR however, is not affected by light sources and therefore complements NVG use.

9.4.3 Weather Conditions. NAVFLIR and NVG provide a limited capability to see through visibility restrictions such as fog, rain, haze, and certain types of smoke. As the density of the visibility

restrictions increases, a gradual reduction in light occurs. Use of an offset scanning technique helps to alert the pilot to severe weather conditions.

NOTE

Visibility restrictions produce a “halo” effect around artificial lights.

9.4.4 Object/Target Detection. Detection ranges are largely a function of the existing atmosphere and environmental conditions. Moving targets with contrasting backgrounds or targets with a reflected or generated light or heat sources can be identified at greater ranges when using NVD.

9.4.5 Flight Preparation. Flights with NVD require unique planning considerations that include weather, moon phase/angle, illumination, ground terrain and shadowing effects. Tactical consideration and procedures can be found in Volume IV of the Tactical manual.

9.5 SHORT AIRFIELD FOR TACTICAL SUPPORT (SATS) PROCEDURES

9.5.1 Landing Pattern. Approach the break point either individually or in echelon, parade formation, at 250 knots. A 17 to 20-second break interval provides a 35 to 40-second touchdown interval. Have the landing checklist completed, be at on-speed AOA/approach speed by the 180° position.

9.5.2 Approach. Plan for and execute an on-speed approach. Pay particular attention to maintaining the proper airspeed and correct lineup.

9.5.3 Waveoff. To execute a waveoff, immediately add full power and maintain optimum attitude. Make all waveoffs straight ahead until clear of the landing area.

9.5.4 Arrested Landing. The aircraft should be on runway centerline at touchdown. Aircraft alignment should be straight down the runway with no drift. Upon touchdown, maintain the throttle at the approach position. When arrestment is assured, retard the throttle to idle. Allow the aircraft to roll back to permit the hook to disengage from the pendant. When directed by the taxi director, apply both brakes to stop the rollback and raise the hook. If further rollback is directed, release brakes and allow the aircraft to be pulled back until a brake signal is given. Then apply brakes judiciously to prevent the aircraft from tipping or rocking back.



Use extreme caution when taxiing on a wet SATS runway.

9.5.5 Bolter. Bolters are easily accomplished. Simultaneously apply full power and retract the arresting gear hook. Smoothly rotate the aircraft to a lift-off attitude and fly away.



Bolters in GAIN ORIDE require more aft stick input for rotation due to fixed AOA feedback and zero rudder toe-in deflections. Half-aft stick is recommended for rotation from bolters in GAIN ORIDE to reduce aircraft settle.

WARNING

If landing on a runway with a SATS catapult installed, care must be taken to prevent engagement of the dolly arrester ropes with the aircraft tailhook. Structural damage to the aircraft and catapult will result.

9.5.6 Hot Seat Procedure.

1. Parking brake - ON
2. Nosewheel steering - OFF
3. Left throttle - OFF
4. Throttle friction - MAX
5. Avionics - AS DESIRED

9.5.7 Alert Scramble Launch Procedures.

9.5.7.1 Setting the Alert.

1. The alert/scramble aircraft shall be preflighted in accordance with NATOPS normal procedures, this part, every 4 hours or as local directives dictate.
2. The pre-alert turn shall consist of full Plane Captain checks and full systems checks. Minimum requirements are:
 - a. Radar - GO
 - b. AIM-7 - TUNED (if loaded)
 - c. INS - OK
 - d. Comm 1 and 2 - SET TO LAUNCH FREQUENCY
 - e. Launch trim - SET IN ACCORDANCE WITH FIGURE 8-1
3. Before engine shutdown -
 - a. INS - OFF (10 seconds before engine shutdown)

NOTE

Do not switch INS to NAV during pre-alert turn so that STD HDG option will be available for next alignment.

- b. Crypto switch - HOLD THEN NORM
- c. Sensors, weapon systems, and UFC avionics - ON
- d. Comm 1 and 2 - ON

- e. EMCON - AS DESIRED
- f. Exterior and interior lights - SET
- g. DDIs, HI/MPCD, and HUD - ON

Aircraft 161353 THRU 164068

- h. Oxygen switch - OFF

Aircraft 164196 AND UP

- h. OBOGS control switch and OXY flow knob - OFF

All aircraft-

- i. Landing gear pins - REMOVED AND STOWED
4. After engine shutdown -
- a. External power - CONNECTED (if applicable)
 - b. External power switch - RESET THEN NORM
 - c. Ground power switches 1, 2, 3, and 4 - OFF
 - d. Battery switch - CHECK OFF
 - e. SINS cable - CONNECTED (if required)

9.5.7.2 Alert Five Launch

If on external power -

- 1. Ground power switches 1B, 2B, 3B, and 4B - ON (hold 3 seconds)
- 2. INS - CV/GND
- 3. INS - STD HDG (if available)
- 4. BATT switch - ON
- 5. APU - START (READY light within 30 seconds)
- 6. R engine - START
- 7. L engine - START
- 8. FCS - RESET

Aircraft 161353 thru 164068 -

- 9. OXYGEN switch - ON

Aircraft 164196 AND UP -

9. OBOGS control switch and OXY flow knob - ON

All aircraft-

10. External power - DISCONNECTED (if applicable)
11. SINS cable - DISCONNECTED (if applicable)
12. INS - NAV or GYRO or IFA (EGI)
13. Takeoff checklist - COMPLETE
14. After launch, INS - IFA (if applicable)

9.6 AIRBORNE HMD ACCURACY CHECKS

The procedures below shall be performed to verify JHMCS accuracy at any time system accuracy is in question, including verifying the accuracy of the cockpit magnetic map. These procedures require an airborne target.

If performing these procedures to determine if cockpit re-mapping is needed following maintenance, only 9.6.2 Airborne HMD Accuracy Check with Radar is required. Cockpit re-mapping is not required if 9.6.2 Airborne HMD Accuracy Check with Radar is successful.

9.6.3 Airborne HMD Accuracy Check with CATM/AIM-9X can be performed at the aircrew's discretion to verify accuracy in the high off-boresight field of regard.

NOTE

If preflight HMD Alignment occurred less than 15 minutes after system powered on, repeat 9.6.1 HMD Alignment prior to any airborne checks.

9.6.1 HMD Alignment.**(CVRS record HMD if desired)**

1. SUPT/HMD/ALIGN page - SELECT
2. Superimpose the HMD alignment cross on the HUD/BRU alignment cross.
3. Cage/Uncage button - PRESS and HOLD until ALIGNING turns to ALIGN OK or ALIGN FAIL

If ALIGN FAIL -

4. Repeat steps 2 and 3.

If ALIGN OK and HMD alignment crosses are not coincident with HUD/BRU alignment cross -

4. Perform FINE ALIGN.

- a. With FA DXDY displayed, use TDC to align azimuth and elevation HMD alignment crosses with the HUD/BRU alignment cross.
- b. Cage/Uncage button - PRESS and RELEASE
- c. With FA DROLL displayed, use TDC to align the roll axis HMD alignment crosses with the HUD/BRU alignment cross.
- d. Cage/Uncage button - PRESS and RELEASE

If satisfied with alignment -

5. ALIGN - UNBOX

9.6.2 Airborne HMD Accuracy Check with Radar.

1. Select STT while in trail of an airborne target.
2. Compare HMD TD Box to HUD TD Box and target's actual position (when in HUD FOV) and compare HMD TD Box and target's actual position (when NOT in HUD FOV) at various azimuth/elevation angles (up to 45° laterally left and right and 45° in elevation).

If HMD and HUD TD Boxes are not nearly coincident or portion of target is not located within HMD and HUD TD Boxes -

3. Perform 9.6.1 HMD Alignment procedures.
4. Repeat steps 1 and 2.

If HMD Alignment does not correct -

5. Consider re-mapping the cockpit.

9.6.3 Airborne HMD Accuracy Check with CATM/AIM-9X.

1. No L&S track selected.
2. Select AIM-9X (manual mode).
 - Verify AIM-9X symbology on HMD and AUTO not displayed below 9X at bottom of display.
 - Verify AIM-9X slaved to HMD.
3. Perform the following steps at various azimuth/elevation angles throughout the AIM-9X field of regard and outside the radar field of regard until aircrew are confident that the HMD and AIM-9X are pointing properly:
 - a. Place aiming cross on the target.
 - b. Cage/Uncage button - PRESS to command AIM-9X to enter track
 - Verify AIM-9X enters track on the target.
 - Verify in-track seeker circle is within one 9X circle size of touching the target.

- c. Cage/Uncage button - PRESS to slave AIM-9X to HMD
- d. Set up next azimuth/elevation angle and repeat steps a through c.

If the in-track seeker circle is not within one 9X circle size of touching the target -

- 4. Perform 9.6.1 HMD Alignment procedures.
- 5. Repeat steps 1 through 3.

If HMD Alignment does not correct -

- 6. Consider re-mapping the cockpit.

CHAPTER 10

Functional Checkflight Procedures

10.1 GENERAL

The information contained herein describes in detail the procedures to be followed during a functional checkflight. The checks are presented in consecutive order simulating a recommended checkflight profile. The profile itself may be altered as required, however, the sequential steps listed for a system/component evaluation are mandatory. Because of restricted operating areas, pilot technique or other limiting factors, a full checkflight profile may require more than one flight. Therefore, it is permissible to divide the recommended checkflight profile, as required, to compensate for these conditions. If a checkflight is divided, it is permissible for another pilot to complete the checklist, provided there is a thorough passdown, either verbal or written, between the pilots.

Requirements for functional checkflights are listed in COMNAVAIRFORINST 4790.2 Series with the following exceptions specific to the F/A-18. An FCF is not required for the installation or reinstallation of a known good engine provided satisfactory ground checks have been completed, unless both engines are being installed or reinstalled. A “known good engine” is defined as an engine removed and reinstalled in the same aircraft to facilitate other maintenance, or an engine in operational use cannibalized from another aircraft. An FCF is not required for the reinstallation of a known good movable flight control surface provided satisfactory completion of BIT checks on deck. A “known good movable flight control surface” is defined as a flap, aileron, horizontal stab, or rudder surface only (not servocylinder). FCF checks are required under the following circumstances:

PRO A - Full Aircraft check

- Acceptance
- Down time in excess of 30 days
- If no FCF As within past year (12 months)
- Anytime requested by the Commanding Officer

PRO B - Engines

- Dual engine removal (reinstallation/replacement)
- Dual ECA change
- Dual main fuel control change
- Installation of any unknown engine
- Anytime requested by the Commanding Officer

PRO C - Flight Controls

- Anytime a flight control surface is re-rigged
- Installation of any flight control servo-cylinder or hydraulic drive unit
- Anytime requested by the Commanding Officer

PRO D - Rear Cockpit (Trainer Configuration only)

- Acceptance of a newly assigned aircraft or upon receipt of an aircraft returned from SDLM.
- Reconfigured from missionized to trainer configuration.

NOTE

Aft crewmember is required.

Functional checkflights are performed using the applicable Functional Checkflight Checklist. Checkflight personnel must familiarize themselves with these requirements prior to the flight. FCF requirements do not replace normal procedures. NATOPS procedures apply during the entire checkflight. Only those pilots designated in writing by the Squadron Commanding Officer shall perform squadron checkflights. Checkflight procedures are in accordance with the current edition of COMNAVAIRFORINST 4790.2. Items contained in the Functional Checkflight Requirements are coded. This coding is intended to assist the FCF pilot in determining which items pertain to the various conditions requiring checkflights. Items coded (B) pertain to engine/fuel control maintenance as outlined in COMNAVAIRFORINST 4790.2. Items coded (C) pertain to flight control/rigging maintenance as outlined in COMNAVAIRFORINST 4790.2. Items coded (L) pertain to LEF system maintenance as outlined in COMNAVAIRFORINST 4790.2. Items coded (D) pertain to an F/A-18D reconfigured rear cockpit with stick and throttle. Items coded (A) constitute a complete Functional Checkflight; requirements are outlined in COMNAVAIRFORINST 4790.2. Coding shall appear adjacent to a step.

10.2 FCF CHECKLIST - PROFILE A (Includes combined profiles B and C)**10.2.1 F/A-18A/C (F/A-18B/D Front Cockpit)****10.2.1.1 Preflight**

1. (ABC) Exterior Inspection - Perform IAW Chapter 7
 - No loose or improperly installed panels.
2. (ABC) Interior Checks - Perform IAW Chapter 7
3. (A) External electrical power - APPLY
4. (A) EXT PWR switch - RESET
5. (A) GND PWR switches 1, 2, 3, and 4 - B ON (hold for 3 seconds)
 - Audibly verify avionics cooling fans are on.
6. (A) Intercom - ESTABLISH
7. (A) Fuel quantity BIT - PERFORM (F/A-18A/B)

With the fuel quantity indicator OFF flag out of view, note internal and feed tank fuel quantities. Set the BINGO bug above 6,200 pounds and then place and hold the fuel quantity selector switch in BIT and check the following:

 - a. Internal (pointer) and total (counter) indicates 6,000 \pm 200 pounds.
 - b. LEFT and RIGHT (counters) indicate 600 \pm 50 pounds.

- c. After pointer and counters reach the above values (must occur within 15 seconds), ensure the ID flag is not in view.
 - d. A FUEL advisory display appears on the DDI if any of the following cautions do not appear within 15 seconds after initiating BIT with the fuel quantity selector switch: FUEL LO, BINGO, CG (Aircraft 161520 AND UP), or G-LIM 7.5.
 - e. Release the fuel quantity selector switch.
 - f. Ensure pointer and counters return to previous values, the FUEL LO, BINGO, CG and G-LIM 7.5 caution displays are removed, the MASTER CAUTION light goes out and, after 1 minute, the FUEL LO caution light goes out.
 - g. Reset BINGO bug to desired fuel quantity.
8. (A) AIR SCOOP - CHECK
 - a. AV COOL or FCS COOL switch - EMERG
 - FCS ram air scoop deploys (thumbs up from plane captain)
 - b. Plane captain manually restows scoop.
 9. (A) Warning and caution lights - TEST
 - All warning and caution lights properly illuminate.
 10. (A) Fire detection system - CHECK AND TEST
After FIRE TEST A and B, rotate the BLEED AIR knob to OFF then back to NORM.
 11. (A) EXT and INTR lights - Check for proper operation to extent possible for ambient conditions.
 12. (A) Seat adjustment - CHECK
 - Smooth through full range of travel.
 - Do not hold switch against stops (no limit switches).
 - Adjust rudder pedals as desired.
 13. (A) DDIs and HI/MPCD - ON

10.2.1.2 Engine Start

1. (AC) FLAP switch - AUTO
2. (ABC) BATT switch - ON (if not previously on)
3. (ABC) READY (Fire extgh)/DISCH light - OUT
4. (AC) Control stick - CYCLE
5. (ABC) APU - START
6. (AC) ENG CRANK switch - R
Leave throttle in cutoff.
7. (AC) Mechanical linkage - CHECK

After both stabilators fair to the neutral position -

- a. Move stick slowly forward or aft and release.
 - Both stabilators shall move smoothly and symmetrically with stick input and return to neutral when stick is released.
 - b. Move the stick left and right.
 - Ensure the corresponding stabilator trailing edge deflects up differentially higher than the opposite stabilator trailing edge.
 - c. Hold the stick full aft and move the FLAP switch to HALF or FULL.
 - Visually, or using the FCS status display, verify that both stabilators move to a higher trailing edge up position.
8. (ABC) Right engine - START
Perform engine start IAW Chapter 7.
 9. (A) External power - DISCONNECT
 10. (ABC) BLEED AIR knob - ROTATE THROUGH OFF TO NORM
 11. (ABC) Left engine - START
Perform engine start IAW Chapter 7.
 12. (AC) On DDI FCS display - VERIFY STAB Xs (FAILED) IN CHANNELS 1 AND 2
 13. (ABC) FCS - RESET
 14. (ABC) FLAP switch - AUTO
 15. (ABC) BLEED AIR system - CHECK
 - a. Throttles - IDLE
 - b. BLEED AIR knob - CHECK EACH POSITION INDIVIDUALLY
 - (1) R OFF
 - R BLD OFF caution displayed.
 - MASTER CAUTION light on and tone sounds.
 - Left engine TEMP increases 5° to 90°C.
 - (2) MASTER CAUTION light - RESET
 - (3) Pause 5 seconds to allow Master Caution tone to reset.
 - (4) OFF
 - L and R BLD OFF cautions displayed.
 - MASTER CAUTION light on and tone sounds.
 - Cabin airflow stops.

- (5) L OFF
 - R BLD OFF caution removed.
 - Right engine TEMP increases 5° to 90°C.
 - Cabin airflow resumes.

 - c. BLEED AIR knob - NORM
 - L BLD OFF caution removed.
 - MASTER CAUTION light out.

 - d. FIRE test switch - TEST A (for at least 2 seconds)
 - L and R BLEED warning lights on while switch held.
 - Voice alert sequence initiated.
 - L and R BLD OFF cautions displayed.
 - Cabin airflow stops.

 - e. BLEED AIR knob - CYCLE THRU OFF TO NORM
 - L and R BLD OFF cautions removed.
 - Cabin airflow resumes.

 - f. Repeat steps d and e for the TEST B position.
16. (ABC) Engine FIRE light shutdown - PERFORM
- a. Left throttle - IDLE (For 2 minutes)

 - b. Left FIRE light - PUSH
 - FIRE EXTGHD READY light on
 - L BOOST LO caution on
 - MASTER CAUTION light on
 - Master Caution tone sounds

When rpm is less than 60% -

- L FLAMEOUT caution on
- "Engine Left/Right" voice warning sounds
- With engine at IDLE, it may take as long as 60 seconds before the engine shuts down.

When rpm is less than 10% -

- c. Left throttle - OFF

 - d. Left FIRE light - RESET
 - FIRE EXTGHD READY light off
17. (ABC) Verify proper switching valve operation.

- a. Monitor HYD pressure. As pressure decreases below 1,500 psi, gently pump the stick approximately ± 1 inch fore and aft at approximately two cycles per second, decreasing hydraulic pressure on shutdown engine below 800 psi. Ensure system pressure on operating engine remains above 1,500 psi.
 - b. Continue gently pumping the stick while monitoring FCS page for FCS Xs and/or BLIN codes for 12 seconds after system pressure on shutdown engine drops below 800 psi. Record if present.
 - c. Monitor FCS page for FCS Xs or BLIN codes. Record if present.
18. (A) BATT switch - OFF
 - L GEN, and BATT SW caution lights on
 - GEN TIE caution light on (Aircraft 162394 AND UP and 161353 THRU 161987 AFTER AFC 048)
 19. (A) BATT switch - ON
 - GEN TIE and BATT SW caution lights off.
 20. (ABC) APU - OFF
 21. (ABC) Left engine - CROSSBLEED START
 22. (ABC) Repeat steps 16 and 17 for the right engine.
 23. (A) BATT switch - OFF
 - R GEN and BATT SW caution lights on.
 - GEN TIE caution light on (Aircraft 162394 AND UP and 161353 THRU 161987 AFTER AFC 048)
 24. (A) BATT switch - ON
 - GEN TIE and BATT SW caution lights off.
 25. (ABC) Right engine - CROSSBLEED START
 26. (ABC) Hydraulic pressure - CHECK
 - Check that HYD1 and HYD2 pressures are 2,850 to 3,250 psi.
 27. (AB) Generators - CHECK
 - a. R GEN switch - OFF
 - RDDI operative
 - b. L GEN switch - OFF
 - BATT SW caution on
 - Leave both generators off for at least 10 seconds.
 - c. BATT switch - ORIDE
 - BATT SW caution on
 - ARI OFF flag out of view
 - GEN TIE caution light out

- d. R GEN switch - NORM
 - GEN TIE caution light on
- e. BATT switch - ON
 - BATT SW caution off
 - GEN TIE caution off
 - LDDI operative
- f. L GEN switch - NORM
- g. FCS - CHECK DDI DISPLAY AND RESET IF REQUIRED

Aircraft 161353 THRU 164068

- 28. (A) OXYGEN - ON AND CHECK

A minimum of 4 liters (8 liters for F/A-18B/D) is required.

 - a. Press and hold the oxygen test button
 - OXY LOW caution is displayed within 2 seconds of the oxygen gauge needle reaching 1 liter.
 - b. Release button
 - Oxygen gauge needle returns to original quantity and OXY LOW display is removed.

Aircraft 164196 AND UP

- 28. (A) OBOGS system - CHECK
 - a. OBOGS control switch - ON
 - b. OXY FLOW knob - ON/MASK(S) (both cockpits)
 - System provides oxygen on demand.
 - No excessive backpressure.
 - c. OBOGS monitor pneumatic BIT plunger - PRESS AND HOLD (do not rotate)
 - OBOGS DEGD caution displayed within 65 seconds.
 - Release plunger.
 - Caution removed within 30 seconds.

WARNING

Inadvertent rotation of the OBOGS monitor pneumatic BIT plunger while pressed can result in the locking of the plunger in a maintenance position and may result in intermittent OBOGS DEGD cautions and lead to hypoxia. Rotation of the BIT plunger disengages the locking slot allowing the plunger to extend and move freely when pushed.

- d. OBOGS electronic BIT button - PRESS AND RELEASE
 - OBOGS DEGD caution displayed and removed within 15 seconds.
- e. OXY FLOW knob(s) - OFF (both cockpits)
 - OBOGS flow stops.

10.2.1.3 Before Taxi

1. (ABC) Before taxi procedures - PERFORM
Perform before taxi procedures IAW Chapter 7.
2. (A) INS - CHECK
 - a. Check waypoint 0 and magnetic variation.
 - QUAL should be OK within 6 minutes.
 - b. Cycle the parking brake
 - Alignment time flashes then stops flashing when parking brake is set to ON.
 - On EGI equipped aircraft the alignment time does not flash when the parking brake is released unless the aircraft moves.
3. (A) Radar - CHECK
 - a. RADAR knob - OPR
 - For the first 30 seconds, NOT RDY is displayed.
 - After 30 seconds, TEST is displayed.
 - After 3-minute time-out, transmitter radiates into the dummy load and AIM-7 missile tuning horns for 5 seconds, then automatically shuts down.
4. (A) Fuel system checks - PERFORM (F/A-18C/D)

On the RDDI -

- a. SDC/sensor operation - CHECK
 - (1) SUPT/BIT/STATUS MONITOR page - SELECT
 - (2) SDC BIT option - SELECT
 - SDC BIT status indicates GO.
 - (3) FXFR page - SELECT
 - Do not take off with flashing parameters.
 - (4) FQTY page - SELECT
 - Do not take off with flashing parameters.

On the LDDI -

- b. Fuel quantity/cautions/advisories - CHECK
 - (1) SUPT/FUEL page - SELECT
 - No fuel cautions or advisories displayed.
 - No CG DEGD, EST, INV, INVALID, or INVALID TIMER.
 - BINGO, TOTAL, and INTERNAL fuel quantities agree with IFEI.
 - (2) FLBIT option - SELECT
 - On RDDI, TK2FL indicates GO within 2 seconds.
 - On RDDI, TK3FL indicates GO within 13 seconds.
 - FUEL LO caution and voice alert activated within 13 seconds.
 - FUEL LO caution removed 60 seconds after it is displayed.

- (3) SDC RESET option - SELECT
 - CAUT DEGD caution displayed then removed after 7 seconds.

On the IFEI -

- c. BINGO caution - CHECK
 - (1) BINGO - SET 200 lb above INTERNAL fuel
 - BINGO caution and voice alert activated.
 - (2) BINGO - SET 200 lb below INTERNAL fuel
 - BINGO caution removed.
 - (3) BINGO - SET AS DESIRED
- 5. (AC) Flight controls - CHECK/BIT
 - a. If wings folded verify both ailerons Xd out.
 - b. Flaps - HALF
 - c. FCS IBIT - INITIATE

WARNING

Flight with any PBIT BLIN other than 51, 124, 322 and 336, or IBIT BLIN 4124, 4263, 4322, 4336, 4522, 4526, 4527, 4773, 4774, and 70261 can result in a flight control system failure and aircraft loss. If IBIT detects any failure other than those indicated by the IBIT BLINs listed above, IBIT must be performed again, following an FCS reset, to ensure the detected failure no longer exists. Pressing the FCS reset button, simultaneously with the paddle switch, does not correct BIT detected flight control system failures; it simply clears the BLIN code(s) from the display. If the second IBIT is not successful, the aircraft requires corrective maintenance action to address the failure(s).

NOTE

If BLIN 51 does not reset after airborne, wing-fold function may not be available after landing.

- d. AOA warning tone - VERIFY ANNUNCIATION AT FCS IBIT COMPLETION
- 6. (AC)FCC keep-alive circuitry - CHECK
 - a. FCC circuit breakers - Pull in sequence 1, 2, 3, and 4
 - b. Immediately reset in sequence 1, 2, 3, 4
 - Complete within 7 seconds for valid test.
 - No FCC channel completely Xd out.

7. (AC) GAIN override switch - ORIDE
 - a. Check LAND advisory displayed
 - b. GAIN override switch - NORM
8. (AC) SPIN recovery mode - CHECK
 - a. Flaps - AUTO
 - b. Select FCS display on MPCD (aircraft 163985 AND UP)
 - c. SPIN recovery switch - RCVY
 - d. Check both DDIs - SPIN MODE ENGAGED
 - e. Flaps - CHECK LEF DOWN $33^{\circ} \pm 1^{\circ}$ down, TEF UP $0^{\circ} (\pm 1^{\circ})$.
 - f. SPIN recovery switch - NORM
9. (A) CHECK TRIM, PARK BRAKE, CK FLAPS and CHECK SEAT cautions - CHECK
 - a. Stabilator trim - less than 12° NU
 - b. Throttles - Advance forward momentarily. Do not allow engine rpm to exceed 75 %.
 - CK FLAPS caution on
 - PARK BRAKE caution on
 - CHECK TRIM caution on
 - CHECK SEAT caution (F/A-18C/D) on
10. (ABC) Full stabilator travel verification -
Set stab trim to 4° NU and verify that:
 - Flaps - FULL
 - AFT: 24 NU
 - FWD: 10 ND
 - Wings spread - R/L AILERON: 16 differential stabilator
 - (Wings folded - R/L AILERON: 20 differential stabilator)
11. (ABC) Flaps - FULL
While at full flaps, cycle stick in small circular motions (1 to 2 inches diameter) at a rate slower than one cycle per second. Stick motion should be smooth and continuous. If stick provides uncommanded movement, horizontal stabilator servocylinder and mechanical linkage troubleshooting is required prior to flight.
12. (ABC) Flaps - HALF
13. (AC) Trim - CHECK
 - a. Trim - FULL LEFT and UP
 - b. T/O TRIM button - PRESS UNTIL TRIM ADVISORY DISPLAYED
 - Check that ailerons and rudders return to neutral, stabilator returns to 12° NU.

14. (A) Standby altimeter - SET AND CHECK
 - a. Set reported barometric pressure in window.
 - Verify barometric set value on HUD.
 - Verify HUD display reads within ± 30 feet and altimeter reads within ± 60 feet of ramp elevation.
15. (A) Attitude reference indicator - CHECK
 - Check that attitude reference indicator levels.
16. (A) WINDSHIELD ANTI ICE/RAIN removal - CHECK
 - a. WINDSHIELD switch - ANTI ICE
 - Verify airflow along the canopy bow.
 - b. WINDSHIELD switch - RAIN
 - Verify reduced airflow along the canopy bow.
 - c. WINDSHIELD switch - OFF
 - Verify airflow is secured.
17. (A) ECS system checks - PERFORM
 - a. DEFOG - CHECK
 - (1) DEFOG handle - LOW
 - Minimum defog airflow and maximum cabin airflow.
 - (2) DEFOG handle - HIGH
 - Progressively decreasing cabin airflow and increasing defog flow.
 - b. ECS modes - CHECK
 - Signal: Punch open palm with fist.
 - (1) ECS MODE switch - OFF/RAM
 - Cabin airflow stops.
 - Cabin ram air scoop opens (thumbs up from PC).
 - (2) ECS MODE switch - AUTO
 - Cabin airflow resumes.
 - Cabin ram air scoop closes (thumbs up from PC).
- c. CABIN TEMP knob - ROTATE BETWEEN COLD AND HOT
 - Air temperature changes to agree with setting.
- d. Cabin Pressurization - CHECK
 - (1) CABIN PRESS switch - DUMP
 - Cabin depressurizes.
 - Cabin airflow remains.

- (2) CABIN PRESS switch - RAM/DUMP
 - Cabin remains depressurized.
 - Cabin airflow stops.
 - Cabin ram air scoop opens (thumbs up from PC).

 - (3) CABIN PRESS switch - NORM
 - Cabin pressurizes.
 - Cabin airflow resumes.
 - Cabin ram air scoop closes (thumbs up from PC).
18. (A) Canopy operation - CHECK
- a. CANOPY switch - CLOSE (half way) THEN RELEASE
 - Canopy stops when switch is released.

 - b. CANOPY switch - OPEN
 - Canopy moves to full open position.
 - Switch returns to HOLD position.

 - c. CANOPY switch - CLOSE
 - Canopy closes and locks
 - CANOPY caution off

 - d. Cockpit pressurization - Select NORM
19. (A) ENG ANTI ICE system - CHECK
- a. ENG ANTI ICE switch - ON (after eng start)
 - Verify L HEAT and R HEAT advisories present.
 - If not present, reattempt check at 70 % RPM.

 - b. ENG ANTI ICE switch - TEST
 - Verify INLET ICE caution present.
20. (A) HUD - CHECK
- a. Aircraft 161353 THRU 163782, with the HUD selector switch in AUTO, rotate the HUD symbology brightness control knob from OFF to the desired brightness. Aircraft 163985 AND UP, with the HUD symbology brightness selector switch in DAY, rotate the HUD symbology brightness control knob from OFF to the desired brightness. Set the BLACK level control to 12:00 o'clock position.

 - b. Place HUD symbology reject switch to REJ 2 and check that heading scale, command heading, heading caret, nav range (if displayed), bank angle scale and bank angle pointer, ZTOD timer (if displayed), Mach number, aircraft g, airspeed and altitude boxes deleted from the HUD. Place the switch to NORM and check that all symbols return.

 - c. Vary the symbology brightness in both the NIGHT and DAY mode.

 - d. Place the altitude switch to RDR and check that the HUD is displaying radar altitude (if radar altimeter is on). Return the switch to BARO and check that barometric altitude is displayed.

- e. Place the attitude selector switch to STBY, check that the velocity vector disappears and pitch ladder is referenced to waterline symbol (\overline{W}). Verify INS ATT caution is displayed. Check that standby attitude reference indicator is erect and HUD pitch ladder appears. Verify Xs appear in CH 1/3 of the PROC row on the FCS page. Return the switch to AUTO.
 - f. Turn right DDI off and verify HUD symbology.
21. (A) Inflight refueling probe - CYCLE
 - The refueling probe extends or retracts in 6 seconds.
 - Have plane captain check that the probe light is on with the probe extended.
 22. (A) Speedbrake - CYCLE
 - Speedbrake extends or retracts in 3 seconds maximum.
 - The SPD BRK light is on any time speedbrake is not fully retracted.
 23. (A) Launch bar - FUNCTIONAL CHECK
 24. (A) TRIM advisory - CHECK
 - Perform while launch bar extended.
 - a. Stabilator trim - 13° NOSE UP
 - b. Both throttles - CYCLE
Momentarily advance throttles forward. Do not allow engine rpm to increase above 75 %.
 - c. CHECK TRIM caution - ON
 25. (A) HOOK - CYCLE
 - Hook extends in 3 seconds maximum and retracts in 6 seconds maximum.
 - Ensure the HOOK light remains ON if the hook is in contact with the deck and is prevented from contacting the hook down proximity switch.
 26. (A) Mission computer operation - CHECK
 - a. MC switch - 1 OFF
 - MC1 caution on
 - BIT, CHKLST, ENG, and ADI options removed from SUPT MENU
 - ACL option appears on HSI.
 - b. MC switch - NORM
 - MC1 caution off
 - SUPT MENU options return.
 - c. MC switch - 2 OFF
 - MC2 caution on
 - STORES option removed from TAC MENU.
 - d. MC switch - NORM
 - MC2 caution off
 - STORES option returns

10.2.1.4 Taxi

1. (A) Brakes - TEST
 - a. ANTI SKID switch - OFF
 - SKID advisory on
 - Check brakes when leaving the chocks
 - b. ANTI SKID switch - ON
 - SKID advisory off
 - c. Normal brakes - CHECK
 - Check brakes during taxi
2. (A) Nosewheel steering - CHECK
 - NWS responds appropriately in LO and HI gain modes.
 - NWS disengages when paddle switch held
3. (AC) Emergency brakes - CHECK
 - No appreciable change in performance should be observed compared to the normal system.

NOTE

Anti-skid system is inoperative during emergency brake system operation.

10.2.1.5 Shipboard Taxi/Takeoff Checks

1. (AB) Canopy - CHECK CLEAR/CLOSED (CANOPY caution removed)
2. (AB) OXY FLOW knob(s) - ON/MASK(S) ON prior to tie down removal
3. (AB) PARK BRK handle - FULLY STOWED on catapult
4. (AB) T.O. checklist - COMPLETE from bottom to top

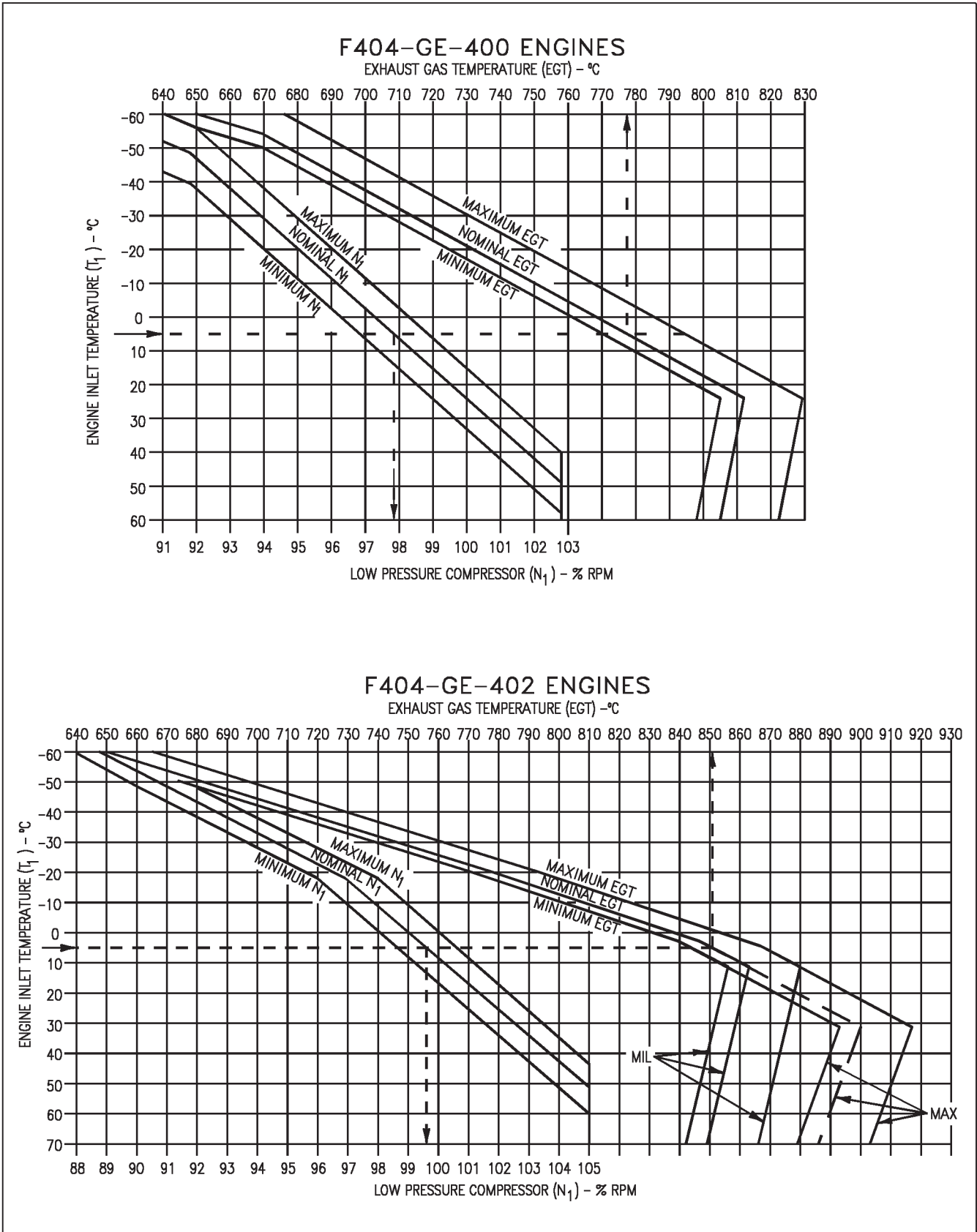

18AC-NFM-00-(52-1)31-CAT1

Figure 10-1. EGT and N_1 Limits

5. (AB) IFF - SQUAWK MODES/CODES as appropriate
6. (AB) Heading checks –
 - HSI heading matches BRC within $\pm 3^\circ$
 - STBY magnetic compass within limits of compass card

At catapult tension signal -

7. (AB) Engine run-ups – PERFORM (together)
 - a. Throttles both engines - IDLE to MIL
 - Low pressure compressor (N_1) rpm and EGT are scheduled as a function of engine inlet temperature (T_1) see figure 10-1.
 - High pressure compressor (N_2) rpm varies with N_1 and EGT and should not be used to reject an engine when N_1 and EGT are within limits unless N_2 is above maximum rpm (102 %).
 - b. ENG page - CHECK ENGINES AT MIL

If F404-GE-400 Engine -

- N_1 rpm - 94 to 103 %
- N_2 rpm - 92 to 102 %
- EGT - 715° to 830°C (852°C MAX TRANSIENT)
- FF - 6,000 to 9,000 pounds per hour
- NOZ POS - 0 to 57 %
- OIL PRESS - 95 to 180 psi
- VIB - Display not valid
- FUEL TEMP - 78°C maximum

If F404-GE-402 Engine -

- N_1 rpm - 94 to 105 %
- N_2 rpm - 90 to 102 %
- EGT - 715° to 880°C (902°C MAX TRANSIENT)
- FF - 6,000 to 12,500 pounds per hour
- NOZ POS - 0 to 48 %
- OIL PRESS - 95 to 180 psi
- VIB - Display not valid

- FUEL TEMP - 78°C maximum
- 8. (AB) Afterburners - SELECT
 - Both nozzles open correctly.
 - Feed tanks remain full during takeoff, climb, and immediately following climb.

10.2.1.6 Shorebased Takeoff Checks

1. (AB) Canopy - CHECK CLEAR/CLOSED (CANOPY caution removed)
2. (AB) OXY FLOW knob(s) - ON/MASK(S) ON
3. (AB) T.O. Checklist - COMPLETE
4. (AB) PARK BRK handle - FULLY STOWED in position and hold
5. (AB) IFF - SQUAWK MODES/CODES as appropriate
6. (AB) HEADING CHECKS -
 - HSI heading within $\pm 3^\circ$ of known runway heading.
 - STBY magnetic compass within limits of compass card.
7. (AB) Engine run-ups - PERFORM (individually)
 - a. Throttle affected engine - IDLE to MIL
 - Low pressure compressor (N_1) rpm and EGT are scheduled as a function of engine inlet temperature (T_1) see figure 10-1.
 - High pressure compressor (N_2) rpm varies with N_1 and EGT and should not be used to reject an engine when N_1 and EGT are within limits unless N_2 is above maximum rpm (102%).
 - b. ENG page - CHECK ENGINES AT MIL

If F404-GE-400 engine -

- N_1 rpm - 94 to 103 %
- N_2 rpm - 92 to 102 %
- EGT - 715° to 830°C (852°C MAX TRANSIENT)
- FF - 6,000 to 9,000 pounds per hour
- NOZ POS - 0 to 57 %
- OIL PRESS - 95 to 180 psi
- VIB - Display not valid
- FUEL TEMP - 78°C maximum

If F404-GE-402 engine -

- N_1 rpm - 94 to 105 %
- N_2 rpm - 90 to 102 %

- EGT - 715° to 880°C (902°C MAX TRANSIENT)
- FF - 6,000 to 12,500 pounds per hour
- NOZ POS - 0 to 48 %
- OIL PRESS - 95 to 180 psi
- VIB - Display not valid
- FUEL TEMP - 78°C maximum
 - c. Throttle affected engine – MIL to IDLE, pause 1 second, IDLE to MIL
 - Engine responds with normal acceleration characteristics.
 - No stall or stagnation.
 - d. Throttle affected engine – IDLE
 - e. Repeat steps a thru d for opposite engine.

When cleared for takeoff -

- 8. (AB) Afterburner takeoff – PERFORM IAW chapter 7.
 - Both nozzles open correctly.
 - Feed tanks stay full during takeoff, climb, and immediately following climb.

10.2.1.7 Takeoff

NOTE

Autopilot modes can be used.

- 1. (AB) Afterburner takeoff - PERFORM IAW Chapter 7
 - Ensure nozzles open and feed tanks stay full during and immediately following the climb.
- 2. (A) Landing gear - RETRACT
 - The landing gear should retract in 7 seconds maximum.
- 3. (A) Radar altimeter - CHECK
 - Check HUD and radar altimeter indications during climb to 5,000 feet.
 - Above 5,000 feet, HUD R changes to a flashing B and the radar altimeter OFF flag is in view.
- 4. (AC) FCS RIG Check - 10,000 Feet
 - Only perform if -**
 - Aircraft symmetrically loaded (external/internal wing tank fuel asymmetry less than 300 lb).
 - a. Autopilot mode - Disengage in 1g flight
 - b. Check memory inspect unit 14, address 5016. If first and third lines are not between 177200 and 177777 or between 000000 and 000600, re-trim laterally until within this range.
 - c. Stabilize at each incremental airspeed and trim rudder, if required, to center ball prior to roll-off check. Release controls from wings-level and record the direction of roll-off and angle-of-bank (AOB) at the end of 6 seconds.

- d. 200 KCAS
- e. 300 KCAS
- f. 400 KCAS
- g. 500 KCAS
- h. 550 KCAS

- The 550 KCAS check should not be performed if a pod is loaded on station 4 or 6.

NOTE

RIG Check fails if any AOB $> 30^\circ$ ($> 5^\circ$ per second); however, for diagnostics purposes, complete all applicable roll-off checks.

5. (AB) Throttle transients - CHECK (one at a time)
 - At 10,000 feet and Mach 0.75 perform the following throttle transients.
 - a. Throttle affected engine - IDLE to MAX
 - Afterburner lights within 10 seconds.
 - b. Throttle affected engine - MAX to IDLE, pause 3 seconds, IDLE to MAX
 - Afterburner lights within 10 seconds.
 - Engine responds smoothly with no stall, stagnation, or flameout.
 - c. Repeat steps a and b for opposite engine

10.2.1.8 Medium Altitude (15,000 Feet)

NOTE

Altitude blocks are suggested ONLY to provide a logical sequence for the FCF procedures. Deviations from these block altitudes are acceptable unless specified.

1. (A) Fuel dump - CHECK
 - Perform functional check of fuel dump.
2. (A) Automatic dump shutoff - CHECK
 - Set BINGO at internal fuel remaining level.
 - Check that automatic shutoff occurs within ± 400 pounds of setting.
3. (A) COMM - CHECK
 - Comm switches function normally.
 - Both radios operative in transmit and receive.
 - UHF and VHF preset, manual and guard frequency selection operative.
4. (AC) Flight control damping - CHECK
 - a. Airspeed - Maintain 300 to 350 KCAS

- b. Make small, abrupt pitch, roll, and yaw inputs.
 - Aircraft response is appropriate.
 - No oscillation tendencies noted.
 - 5. (A) Fuel transfer - MONITOR
 - Periodically monitor fuel quantity during flight ensuring normal fuel transfer occurs.
 - 6. (A) IFF operation - CHECK
 - ATC reports valid mode 3 and C.
- If/when possible -**
- a. IFF MASTER switch - EMERG
 - ATC reports valid emergency squawk (7700).
 - 7. (A) Cabin pressure - CHECK
 - Check cabin pressure is 8,000 ±1,000 feet.
 - 8. (AC) AFCS - CHECK
 - a. A/P - At 350 knots, 15,000 feet with bank angle $\leq 5^\circ$, engage A/P switch.
 - Check that aircraft maintains heading.
 - b. Attitude hold -
 - (1) Bank aircraft 45° left using CSS.
 - Check that aircraft maintains attitude.
 - (2) Bank aircraft 45° right using CSS.
 - Check that aircraft maintains attitude.
 - (3) Input $\pm 10^\circ$ pitch commands using CSS.
 - Check that aircraft maintains heading and attitude.
 - c. Heading select -
 - (1) Select 30° left heading change with the HDG set switch. Select HSEL option.
 - Check that heading hold is reestablished after selected heading is captured.
 - (2) Repeat with 30° right heading change.
 - d. Barometric altitude hold -
 - (1) Select BALT option during a 4,000 feet/minute climb.
 - Check that altitude is captured and maintained.
 - (2) Repeat during 4,000 feet/minute dive.
 - (3) Perform 45° bank turn.
 - Check that altitude is maintained within ± 100 feet.
 - 9. (AB) ATC cruise mode - CHECK
 - Engage ATC cruise mode between 300 and 350 knots.
 - Ensure system maintains engaged airspeed in level flight and banked turns.

10. (ABC) Perform negative G check for FOD.

10.2.1.9 High Altitude (Above 30,000 Feet)

1. (A) Cabin pressurization/temperature - MONITOR
 - During climb, check cabin pressurization/temperature control.
 - Pressurization shall remain at 8,000 feet up to 23,000 - 24,000 feet altitude.
 - Above 23,000 to 24,000 feet altitude refer to figure 2-37.

AIRCRAFT ALTITUDE	CABIN ALTITUDE
30,000 feet	10,000 to 12,000 feet
40,000 feet	15,000 to 17,000 feet

2. (AB) Throttle transients - CHECK (one at a time)
 - At 35,000 feet and 200 to 220 knots, perform the following throttle transients.
 - a. Throttle affected engine - IDLE to MAX
 - Afterburner lights within 15 seconds.
 - b. Throttle affected engine - MAX to IDLE, pause 3 seconds, IDLE to MAX
 - Afterburner lights within 15 seconds.
 - Engine responds smoothly with no stall, stagnation, or flameout.
 - c. Repeat steps a and b for opposite engine.
3. (AB) Speed run/rpm lock up - PERFORM
 - Above Mach 1.23, retard the throttles to flight IDLE (one at a time).
 - The rpm shall not drop more than 10 % below MIL rpm with throttles at flight IDLE.
4. (A) Tank 1 and 4 transfer - CHECK

Aircraft 161353 THRU 161519 BEFORE AFC 039 -

- Tank 4 depletes faster than tank 1 at low power settings.
- Tanks 1 and 4 deplete together at high power settings.
- Tank 4 quantity not more than 1,300 pounds (2,000 pounds for F/A-18B) greater than tank 1 quantity.

Aircraft 161353 THRU 161519 AFTER AFC 039 and 161520 AND UP -

- Tanks 1 and 4 fuel quantities fall within allowable limits.
- CG/FUEL XFER caution off.
- No more than 1,700 pounds (F/A-18A/C) 1,100 pounds (F/A-18B) remaining in tank 1 when tank 4 reaches 150 pounds.
- On F/A-18D, tank 4 quantity should be between 0 and 600 pounds when tank 1 empties.

All aircraft -

5. (A) Perform Static Radome Check - Above 30,000 feet

- a. Verify configuration for unlimited AOA and CG not aft of 23.5 % MAC.
- b. Laterally and directionally trim to neutral - centered ball/ no rates.
- c. Check altitude greater than 30,000 feet AGL.
- d. Slow to 30-35° AOA unaccelerated flight and stabilize wings level.
- e. Note initial heading
- f. Continue deceleration by smoothly applying full aft stick, keeping neutral pedal and lateral stick (approximately 2 sec from 35° AOA to full aft stick).
- g. Hold full aft stick for 5 sec; do not counter roll and yaw.

WARNING

If a sustained yaw rate develops in the 50 to 55° AOA region, inadvertent departure from controlled flight and display of spin arrows may result. If a yaw rate develops in the 50 to 55° AOA region, easing control stick forward off the aft stop should immediately reduce the AOA below 50° and terminate the yawing motion.

- h. Observe yaw/roll rates, observe final heading.
 - (1) Recovery
 - (a) Minimum altitude for recovery initiation 25,000 feet AGL
 - (b) Reduce AOA with forward stick
 - (c) Re-establish level flight
 - (2) Failure criteria/Abort criteria
 - (a) Greater than 60° heading change in 5 seconds
 - (b) Rapid yaw acceleration
 - (c) Departure
 - (d) Spin arrows

NOTE

If aircraft fails radome check, the only maintenance action required is to place a card in the ADB stating the aircraft is limited to 45° AOA.

10.2.1.10 18,000 TO 10,000 Feet

1. (A) Radar - FUNCTIONAL CHECK

- a. A/A master mode - CHECK
 - b. A/G master mode - CHECK
2. (A) INS - CHECK
- Check present position error using tacan position update.
 - Record and reject update.
 - Functionally check designate and overfly.
3. (A) HUD symbology - CHECK (both cockpits)

In NAV master mode with WYPT or TCN boxed -

- The following indications are present - heading, airspeed, altitude, barometric setting (for 5 seconds after set), AOA, Mach number, aircraft g, bank angle scale, velocity vector, flight path/pitch ladder, steering arrow (TCN), and distance to WYPT or TCN.
 - WYPT # displayed to right of distance when WYPT boxed.
 - Three-letter identifier displayed to right of distance when TCN boxed.
 - HUD and HI/MPCD distance agree.
 - HUD format available on either DDI
 - Check the VTR/HUD camera
4. (A) Standby flight instruments - CHECK
- a. Standby rate of climb indicator
 - Indicates ± 100 fpm or less during level 1g flight.
 - Pointer movement smooth during climbs/descents.
 - b. Standby attitude reference indicator
 - (1) Perform a 360° roll right and left
 - No gyro tumble
 - Gyro indications are smooth thru bullseye.
 - (2) Perform a loop.
 - During loop check that the HUD flight path/pitch ladder pitch lines are angled toward the horizon.
 - After completion of the loop, errors in pitch and roll may be present, particularly if the loop is conducted in a wings level attitude. This is normal and the errors should be removed by caging the indicator while the aircraft is in normal straight and level attitude.
 - c. Standby airspeed indicator
 - Agrees with HUD.
 - Pointer movement is smooth during airspeed changes.
 - d. Standby altimeter

- Agrees with barometric altitude on HUD
- Pointer and drum movement is smooth and does not hang up during thousand-foot changes.

NOTE

The HUD airspeed and altitude values are corrected by the ADC and the standby instruments are not. Therefore, under certain flight conditions the standby instruments may not agree with the HUD.

5. (A) HI/MPCD - CHECK
 - a. HDG/TK set switch - SLEW
 - Heading bug moves in correct direction.
 - Digital display and bug setting agree.
 - b. CRS set switch - SLEW
 - Steering arrow rotates in correct direction.
 - Digital display and steering arrow agree.
 - c. Perform a course intercept using both WYPT and TCN steering.
 - Steering arrow shall correspond to the steering arrow on the HUD.
 - All display movement shall be smooth.
 - d. TCN bearing and range - CHECK
 - Symbol displayed at appropriate position when compared to a waypoint or known landmark.
 - Digital display and symbol agree.
6. (A) Data link - CHECK (if possible)
7. (AC) LEF System - CHECK
 - a. G-WARM - Perform
 - b. Stabilize at 450 knots/10,000 feet MSL. Commence a MIL power loop with a firm initial pull to 4.5-5g. Monitor LEF position on the FCS page. Discontinue check if left-to-right split is greater than 5°. Any left-to-right split in flap position greater than 5° shall be recorded, and follow-up maintenance action is required. Do not exceed 20° AOA with a split between left and right LEF. If an HDU is weak the split should be seen during the first 90° of the loop. Greater than 5° of left or right LEF split will likely result in uncommanded yaw/roll during maneuvering flight.
8. (C) FCF Profile - COMPLETE

10.2.1.11 10,000 Feet to Landing

1. (A) Fuel transfer - MONITOR
 - a. Wing tanks deplete to 0 to 200 pounds before tank 1 or 4 falls below 200 pounds and wing tanks empty following FUEL LO caution.
 - b. Feed tanks remain full until tanks 1 and 4 fall below 200 pounds in non-afterburner operation.

2. (A) ADF receivers - CHECK
Check accuracy of ADF 1 and ADF 2.
 - Bearing accuracy is as follows:
 - a. Off the nose (0° relative bearing) $\pm 5^\circ$.
 - b. Off the wing tip (90° and 270° relative bearing) $\pm 20^\circ$.
 - c. Off the tail (180° relative bearing) no specified accuracy.
3. (A) Automatic speedbrake retract - CHECK
Extend the speedbrake then extend flaps.
 - Ensure speedbrake retracts.
4. (A) Landing gear warning light/warning tone - CHECK
Below 7,500 feet with the landing gear handle UP, reduce airspeed below 175 knots and establish a rate of descent greater than 250 feet per minute.
 - Check that the gear handle warning light flashes and the warning tone comes on.
5. (AB) Emergency landing gear system - CHECK
 - a. Flaps - HALF
 - b. Slow to 160 knots if practical.
 - c. Pull landing gear circuit breaker.

NOTE

The rear cockpit landing gear UNSAFE lamp illuminates with the circuit breaker pulled and the condition is normal.

- d. Set gear handle to DN.
- e. Rotate 90° and pull to detent.
 - Gear should extend within 30 seconds.
- f. Hold the HYD ISO SW in ORIDE for 10 seconds or until the APU ACCUM caution is removed and the emergency brake accumulator is recharged.
 - Gauge reads 2,750 to 3,250 psi and the needle stops moving.
- g. Push handle in, rotate gear handle 90° COUNTERCLOCKWISE.
- h. Reset circuit breaker.



To prevent damage to the main landing gear, the landing gear handle must be outboard (down position) before resetting the handle from emergency to normal. Wait 5 seconds following the circuit breaker or handle reset before placing the landing gear handle up.

6. (A) AOA tone - CHECK
With flaps HALF or FULL, increase AOA to 15° and check that AOA tone comes on at 12°±0.5° with FULL flaps or 15°±0.5° with HALF flaps.
7. (A) Landing gear - RETRACT
8. (A) Flaps auto retract - CHECK
 - a. Increase airspeed.
 - Flaps should retract to AUTO at 250 ±10 knots (amber flap light).
 - b. FLAPS - AUTO
9. (A) ILS/ACLS - FUNCTIONAL CHECK (if facility available)
 - Perform a functional check of the instrument landing system and the ACLS.
10. (A) AOA indexer brightness - CHECK AND SET
 - With landing gear down check brightness from DIM thru BRT then set to the desired brightness.
11. (A) Radar altitude hold - CHECK
12. (AB) ATC approach mode - FUNCTIONAL CHECK
 - Perform a functional check of the ATC mode.
13. (B) FCF Profile - COMPLETE

10.2.1.12 After Landing

1. (A) Anti-skid - CHECK
Above 75 knots apply full brake pressure.
 - Check that anti-skid action is smooth and exhibits no left or right pulling tendencies.
2. (A) Nosewheel steering high mode - CHECK
At reduced taxi speed, unlock the wing fold and press and release the nosewheel steering button.
 - Ensure nosewheel steering goes to high gain and stays in high gain.
3. (A) Emergency HI gain NWS - CHECK
Pull FCS CHAN 2 circuit breaker, wait for the FCS channel to shut down (column of X's on the FCS page), unlock the wings, and press NWS button. Emergency HI gain NWS should be available. Reset FCS CHAN 2. Repeat for FCS CHAN 4 circuit breaker.
 - When the emergency HI gain NWS mode is entered, NWS indication may not be displayed on the HUD.
4. (A) Wingfold - CHECK
5. (A) Parking brake - SET
6. (A) INS terminal error - RECORD
Maximum error for a gyro compass alignment is 1.5 nm per hour of operating time.
 - GPS assisted INS terminal error should be almost zero.
7. (A) BIT/BLIN - CHECK

8. (A) FCF Profile - COMPLETE

10.2.2 Checkflight Requirements (Rear Cockpit). This Rear Cockpit section outlines only the additional checks to establish acceptance standards for the systems peculiar to the F/A-18B/D aircraft. The checks and success criteria specified in the Front Cockpit section also apply to the F/A-18B/D aircraft. Instrument and indicator reading, warning lights, and radar and navigation displays in the rear cockpit are to be compared throughout the flight with corresponding information available from the front cockpit. An aft crewmember is required for D profile FCFs. For A, B, or C profiles, if an aft crewmember is available, the following checks should be made.

10.2.2.1 Before Taxi. Perform the before taxi procedures IAW Chapter 7.

1. (A) Fuel quantity gauge - CHECK (F/A-18B)
 - During front cockpit BIT, make sure the TOTAL and INTERNAL counters agree with front cockpit indications ± 200 pounds.
2. (A) IFEI - CHECK (F/A-18D)
 - During front cockpit BIT, make sure the TOTAL and INTERNAL displays agree with front cockpit displays.
3. (AC) Speedbrake - CYCLE
 - On aft stick and throttle equipped F/A-18D check operation of the speedbrake from the rear cockpit.
4. (A) Attitude reference indicator - CHECK
 - Check that attitude reference indicator is adjustable. Minimum adjustment is $\pm 5^\circ$.
5. (A) Standby altimeter - SET AND CHECK

Set reported barometric pressure in window.

 - Check that altimeter reads within ± 60 feet of ramp elevation.
6. (A) Warning/caution lights - TEST
 - Check for proper operation of the warning/caution lights.
7. (A) DDIs - ON AND SET
 - Set the brightness or contrast as desired.

Aircraft 164196 AND UP -

8. (A) OXY FLOW knob - ON
 - Check flow

10.2.2.2 Taxi

1. (A) Brakes - TEST
 - a. ANTI SKID switch - OFF
 - SKID advisory on
 - Check brakes when leaving the chocks
 - b. ANTI SKID switch - ON
 - SKID advisory off

- c. Normal brakes - CHECK
 - Check brakes during taxi
- 2. (A) Nosewheel steering - CHECK
 - NWS responds appropriately in LO and HI gain modes.
 - NWS disengages when paddle switch held
- 3. (AC) Emergency brakes - CHECK

NOTE

Anti-skid system is inoperative during emergency brake system operation.

10.2.2.3 Medium Altitude (15,000 Feet)

NOTE

Altitude blocks are suggested ONLY to provide a logical sequence for the FCF procedures. Deviations from these block altitudes are acceptable unless specified.

- 1. (A) Comm - CHECK
 - Comm switches function normally.
 - Both radios operative in transmit and receive.
 - UHF and VHF preset, manual and guard frequency selection operative.

10.2.2.4 High Altitude (Above 30,000 Feet)

- 1. (A) Cabin pressurization/temperature - MONITOR

During climb, check cabin pressurization/temperature control. Pressurization shall remain at 8,000 feet up to 23,000 - 24,000 feet altitude. Above 23,000 to 24,000 feet altitude refer to figure 2-37.

AIRCRAFT ALTITUDE	CABIN ALTITUDE
30,000 feet	10,000 to 12,000 feet
40,000 feet	15,000 to 17,000 feet

10.2.2.5 18,000 TO 10,000 Feet

- 1. (A) Standby flight instruments - CHECK
 - a. Standby rate of climb indicator
 - Indicates ± 100 fpm or less during level 1g flight.
 - Pointer movement smooth during climbs/descents.
 - b. Standby attitude reference indicator
 - During the 360° roll right and left, no gyro tumble is permitted.

- After completion of the loop, errors in pitch and roll may be present, particularly if the loop is conducted in a wings level attitude. This is normal and the errors should be removed by caging the indicator while the aircraft is in normal straight and level attitude.
- c. Standby airspeed indicator
 - Agrees with HUD.
 - Pointer movement is smooth during airspeed changes.
 - d. Standby altimeter
 - Agrees with barometric altitude on HUD
 - Pointer and drum movement is smooth and does not hang up during thousand-foot changes.

NOTE

The HUD airspeed and altitude values are corrected by the ADC and the standby instruments are not. Therefore, under certain flight conditions the standby instruments may not agree with the HUD.

10.2.2.6 10,000 Feet to Landing

1. (AC) Flight controls and throttles - FUNCTIONALLY CHECK
2. (AC) Hand controllers - CHECK
 - Verify operation of hand controllers. Selection of displays in rear cockpit shall not affect display selection in forward cockpit.
3. (C) FCF Profile - COMPLETE
4. (A) Emergency landing gear system - CHECK
 - a. Flaps - HALF
 - b. Slow to 160 knots if practical.
 - c. Pull the EMERG LDG GEAR handle until it locks in the detent. (This is to be accomplished without any activation of the front cockpit emergency extension system.)
 - d. Check that gear indicates down within 30 seconds.
 - e. Front crewmember set the landing gear handle to DN and hold the HYD ISO switch in ORIDE for 10 seconds or until the APU ACCUM caution is removed and the emergency brake accumulator is recharged (gauge reads 2,750 to 3,250 psi and the needle stops moving).



To prevent damage to the main landing gear, the landing gear handle must be outboard (down position) before resetting the handle from emergency to normal. Wait 5 seconds following the circuit breaker or handle reset before placing the landing gear handle up.

- f. Reset the rear EMERG LDG GEAR handle, then have front crewmember raise the landing gear.

10.2.2.7 After Landing

1. (A) BIT - CHECK DISPLAY
2. (A) FCF Profile - COMPLETE

10.3 FCF CHECKLIST - PROFILE B**10.3.1 F/A-18A/C (F/A-18B/D Front Cockpit)****10.3.1.1 Preflight**

1. (B) Exterior Inspection - Perform IAW Chapter 7
 - No loose or improperly installed panels.
2. (B) Interior Checks - Perform IAW Chapter 7

10.3.1.2 Engine Start

1. (B) BATT switch - ON (if not previously on)
2. (B) READY (Fire extg)/DISCH light - OUT
3. (B) APU - START
4. (B) Right engine - START
Perform engine start IAW Chapter 7.
5. (B) BLEED AIR knob - ROTATE THROUGH OFF TO NORM
6. (B) Left engine - START
Perform engine start IAW Chapter 7.
7. (B) FCS - RESET
8. (B) FLAP switch - AUTO
9. (B) BLEED AIR system - CHECK
 - a. Throttles - IDLE
 - b. BLEED AIR knob - CHECK EACH POSITION INDIVIDUALLY
 - (1) R OFF
 - R BLD OFF caution displayed.
 - MASTER CAUTION light on and tone sounds.
 - Left engine TEMP increases 5° to 90°C.
 - (2) MASTER CAUTION light - RESET
 - (3) Pause 5 seconds to allow Master Caution tone to reset.

- (4) OFF
 - L and R BLD OFF cautions displayed.
 - MASTER CAUTION light on and tone sounds.
 - Cabin airflow stops.
 - (5) L OFF
 - R BLD OFF caution removed.
 - Right engine TEMP increases 5° to 90°C.
 - Cabin airflow resumes.
 - c. BLEED AIR knob - NORM
 - L BLD OFF caution removed.
 - MASTER CAUTION light out.
 - d. FIRE test switch - TEST A (for at least 2 seconds)
 - L and R BLEED warning lights on while switch held.
 - Voice alert sequence initiated.
 - L and R BLD OFF cautions displayed.
 - Cabin airflow stops.
 - e. BLEED AIR knob - CYCLE THRU OFF TO NORM
 - L and R BLD OFF cautions removed.
 - Cabin airflow resumes.
 - f. Repeat steps d and e for the TEST B position.
10. (B) Engine FIRE light shutdown - PERFORM
- a. Left throttle - IDLE (For 2 minutes)
 - b. Left FIRE light - PUSH
 - FIRE EXTGH READY light on
 - L BOOST LO caution on
 - MASTER CAUTION light on
 - Master Caution tone sounds

When rpm is less than 60% -

- L FLAMEOUT caution on
- "Engine Left/Right" voice warning sounds
- With engine at IDLE, it may take as long as 60 seconds before the engine shuts down

When rpm is less than 10% -

- c. Left throttle - OFF
 - d. Left FIRE light - RESET
 - FIRE EXTGH READY light off
11. (B) Verify proper switching valve operation.

- a. Monitor HYD pressure. As pressure decreases below 1,500 psi, gently pump the stick approximately ± 1 inch fore and aft at approximately two cycles per second, decreasing hydraulic pressure on shutdown engine below 800 psi. Ensure system pressure on operating engine remains above 1,500 psi.
 - b. Continue gently pumping the stick while monitoring FCS page for FCS Xs and/or BLIN codes for 12 seconds after system pressure on shutdown engine drops below 800 psi. Record if present.
 - c. Monitor FCS page for FCS Xs or BLIN codes. Record if present.
12. (B) APU - OFF
 13. (B) Left engine - CROSSBLEED START
 14. (B) Repeat steps 9 and 10 for the right engine.
 15. (B) Right engine - CROSSBLEED START
 16. (B) Hydraulic pressure - CHECK
 - Check that HYD1 and HYD2 pressures are 2,850 to 3,250 psi.
 17. (B) Generators - CHECK
 - a. R GEN switch - OFF
 - RDDI operative
 - b. L GEN switch - OFF
 - BATT SW caution on
 - Leave both generators off for at least 10 seconds.
 - c. BATT switch - ORIDE
 - BATT SW caution on
 - ARI OFF flag out of view
 - GEN TIE caution light out
 - d. R GEN switch - NORM
 - GEN TIE caution light on
 - e. BATT switch - ON
 - BATT SW caution off
 - GEN TIE caution off
 - LDDI operative
 - f. L GEN switch - NORM
 - g. FCS - CHECK DDI DISPLAY AND RESET IF REQUIRED

10.3.1.3 Before Taxi

1. (B) Before taxi procedures - PERFORM
Perform before taxi procedures IAW Chapter 7.

2. (B) Full stabilator travel verification -
Set stab trim to 4° NU and verify that:

Flaps - FULL

AFT: 24 NU

FWD: 10 ND

Wings spread - R/L AILERON: 16 differential stabilator

Wings folded - R/L AILERON: 20 differential stabilator

3. (B) Flaps - FULL

While at full flaps, cycle stick in small circular motions (1 to 2 inches diameter) at a rate slower than one cycle per second. Stick motion should be smooth and continuous. If stick provides uncommanded movement, horizontal stabilator servocylinder and mechanical linkage troubleshooting is required prior to flight.

4. (B) Flaps - HALF

10.3.1.4 Shipboard Taxi/Takeoff Checks

1. (B) Canopy - CHECK CLEAR/CLOSED (CANOPY caution removed)
2. (B) OXY FLOW knob(s) - ON/MASK(S) ON prior to tie down removal
3. (B) PARK BRK handle - FULLY STOWED on catapult
4. (B) T.O. checklist - COMPLETE from bottom to top
5. (B) IFF - SQUAWK MODES/CODES as appropriate
6. (B) Heading checks -
 - HSI heading matches BRC within $\pm 3^\circ$
 - STBY magnetic compass within limits of compass card

At catapult tension signal -

7. (B) Engine run-ups - PERFORM (together)
 - a. Throttles both engines - IDLE to MIL
 - Low pressure compressor (N_1) rpm and EGT are scheduled as a function of engine inlet temperature (T_1) see figure 10-1.
 - High pressure compressor (N_2) rpm varies with N_1 and EGT and should not be used to reject an engine when N_1 and EGT are within limits unless N_2 is above maximum rpm (102%).
 - b. ENG page - CHECK ENGINES AT MIL

If F404-GE-400 Engine -

- N_1 rpm - 94 to 103 %
- N_2 rpm - 92 to 102 %
- EGT - 715° to 830°C (852°C MAX TRANSIENT)

- FF - 6,000 to 9,000 pounds per hour
- NOZ POS - 0 to 57 %
- OIL PRESS - 95 to 180 psi
- VIB - Display not valid
- FUEL TEMP - 78°C maximum

If F404-GE-402 Engine -

- N₁ rpm - 94 to 105 %
- N₂ rpm - 90 to 102 %
- EGT - 715° to 880°C (902°C MAX TRANSIENT)
- FF - 6,000 to 12,500 pounds per hour
- NOZ POS - 0 to 48 %
- OIL PRESS - 95 to 180 psi
- VIB - Display not valid
- FUEL TEMP - 78°C maximum

8. (B) Afterburners – SELECT

- Both nozzles open correctly.
- Feed tanks remain full during takeoff, climb, and immediately following climb.

10.3.1.5 Shorebased Takeoff Checks

1. (B) Canopy - CHECK CLEAR/CLOSED (CANOPY caution removed)
2. (B) OXY FLOW knob(s) - ON/MASK(S) ON
3. (B) T.O. Checklist - COMPLETE
4. (B) PARK BRK handle - FULLY STOWED in position and hold
5. (B) IFF - SQUAWK MODES/CODES as appropriate
6. (B) Heading checks -
 - HSI heading within $\pm 3^\circ$ of known runway heading.
 - STBY magnetic compass within limits of compass card.
7. (B) Engine run-ups - PERFORM (individually)
 - a. Throttle affected engine – IDLE to MIL
 - Low pressure compressor (N₁) rpm and EGT are scheduled as a function of engine inlet

temperature (T_1) see figure 10–1.

- High pressure compressor (N_2) rpm varies with N_1 and EGT and should not be used to reject an engine when N_1 and EGT are within limits unless N_2 is above maximum rpm (102 %).

b. ENG page - CHECK ENGINES AT MIL

If F404-GE-400 Engine -

- N_1 rpm - 94 to 103 %
- N_2 rpm - 92 to 102 %
- EGT - 715° to 830° C (852° C MAX TRANSIENT)
- FF - 6,000 to 9,000 pounds per hour
- NOZ POS - 0 to 57 %
- OIL PRESS - 95 to 180 psi
- VIB - Display not valid
- FUEL TEMP - 78° C maximum

If F404-GE-402 Engine -

- N_1 rpm - 94 to 105 %
- N_2 rpm - 90 to 102 %
- EGT - 715° to 880° C (902° C MAX TRANSIENT)
- FF - 6,000 to 12,500 pounds per hour
- NOZ POS - 0 to 48 %
- OIL PRESS - 95 to 180 psi
- VIB - Display not valid
- FUEL TEMP - 78° C maximum

- c. Throttle affected engine – MIL to IDLE, pause 1 second, IDLE to MIL
 - Engine responds with normal acceleration characteristics.
 - No stall or stagnation.

d. Throttle affected engine – IDLE

e. Repeat steps a thru d for opposite engine.

8. (B) Afterburners – PERFORM IAW Chapter 7.

- Both nozzles open correctly.
- Feed tanks remain full during takeoff, climb, and immediately following climb.

10.3.1.6 Takeoff**NOTE**

Autopilot modes can be used.

1. (B) Afterburner takeoff - PERFORM IAW Chapter 7
 - Ensure nozzles open and feed tanks stay full during and immediately following the climb.
2. (B) Throttle transients - CHECK (one at a time)
 - At 10,000 feet and Mach 0.75 perform the following throttle transients.
 - a. Throttle affected engine - IDLE to MAX
 - Afterburner lights within 10 seconds.
 - b. Throttle affected engine - MAX to IDLE, pause 3 seconds, IDLE to MAX
 - Afterburner lights within 10 seconds.
 - Engine responds smoothly with no stall, stagnation, or flameout.
 - c. Repeat steps a and b for opposite engine

10.3.1.7 Medium Altitude (15,000 Feet)**NOTE**

Altitude blocks are suggested ONLY to provide a logical sequence for the FCF procedures. Deviations from these block altitudes are acceptable unless specified.

1. (B) ATC cruise mode - CHECK

Engage ATC cruise mode between 300 and 350 knots.

 - Ensure system maintains engaged airspeed in level flight and banked turns.
2. (B) Perform negative G check for FOD.

10.3.1.8 High Altitude (Above 30,000 Feet)

1. (B) Throttle transients - CHECK (one at a time)
 - At 35,000 feet and 200 to 220 knots, perform the following throttle transients.
 - a. Throttle affected engine - IDLE to MAX
 - Afterburner lights within 15 seconds.
 - b. Throttle affected engine - MAX to IDLE, pause 3 seconds, IDLE to MAX
 - Afterburner lights within 15 seconds.
 - Engine responds smoothly with no stall, stagnation, or flameout.
 - c. Repeat steps a and b for opposite engine.
2. (B) Speed run/rpm lock up - PERFORM
 - Above Mach 1.23, retard the throttles to flight IDLE (one at a time).
 - The rpm shall not drop more than 10 % below MIL rpm with throttles at flight IDLE.

10.3.1.9 10,000 Feet to Landing

1. (B) Emergency landing gear system - CHECK
 - a. Flaps - HALF
 - b. Slow to 160 knots if practical.
 - c. Pull landing gear circuit breaker.

NOTE

The rear cockpit landing gear UNSAFE lamp illuminates with the circuit breaker pulled and the condition is normal.

- d. Set gear handle to DN.
- e. Rotate 90° and pull to detent.
 - Gear should extend within 30 seconds.
- f. Hold the HYD ISO SW in ORIDE for 10 seconds or until the APU ACCUM caution is removed and the emergency brake accumulator is recharged.
 - Gauge reads 2,750 to 3,250 psi and the needle stops moving.
- g. Push handle in, rotate gear handle 90° COUNTERCLOCKWISE.
- h. Reset circuit breaker.



To prevent damage to the main landing gear, the landing gear handle must be outboard (down position) before resetting the handle from emergency to normal. Wait 5 seconds following the circuit breaker or handle reset before placing the landing gear handle up.

2. (B) ATC approach mode - FUNCTIONAL CHECK
 - Perform a functional check of the ATC mode.

10.3.1.10 After Landing

1. (B) FCF Profile - COMPLETE

10.4 FCF CHECKLIST - PROFILE C**10.4.1 F/A-18A/C (F/A-18B/D Front Cockpit)****10.4.1.1 Preflight**

1. (C) Exterior Inspection - Perform IAW Chapter 7
 - No loose or improperly installed panels.

2. (C) Interior Checks - Perform IAW Chapter 7

10.4.1.2 Engine Start

1. (C) FLAP switch - AUTO
2. (C) BATT switch - ON (if not previously on)
3. (C) READY (Fire extggh)/DISCH light - OUT
4. (C) Control stick - CYCLE
5. (C) APU - START
6. (C) ENG CRANK switch - R
Leave throttle in cutoff.
7. (C) Mechanical linkage - CHECK

After both stabilators fair to the neutral position -

- a. Move stick slowly forward or aft and release.
 - Both stabilators shall move smoothly and symmetrically with stick input and return to neutral when stick is released.
- b. Move the stick left and right.
 - Ensure the corresponding stabilator trailing edge deflects up differentially higher than the opposite stabilator trailing edge.
- c. Hold the stick full aft and move the FLAP switch to HALF or FULL.
 - Visually, or using the FCS status display, verify that both stabilators move to a higher trailing edge up position.
8. (C) Right engine - START
Perform engine start IAW Chapter 7.
9. (C) BLEED AIR knob - ROTATE THROUGH OFF TO NORM
10. (C) Left engine - START
Perform engine start IAW Chapter 7.
11. (C) On DDI FCS display - VERIFY STAB Xs (FAILED) IN CHANNELS 1 AND 2
12. (C) FCS - RESET
13. (C) FLAP switch - AUTO
14. (C) BLEED AIR system - CHECK
 - a. Throttles - IDLE
 - b. BLEED AIR knob - CHECK EACH POSITION INDIVIDUALLY

- (1) R OFF
 - R BLD OFF caution displayed.
 - MASTER CAUTION light on and tone sounds.
 - Left engine TEMP increases 5° to 90°C.
 - (2) MASTER CAUTION light - RESET
 - (3) Pause 5 seconds to allow Master Caution tone to reset.
 - (4) OFF
 - L and R BLD OFF cautions displayed.
 - MASTER CAUTION light on and tone sounds.
 - Cabin airflow stops.
 - (5) L OFF
 - R BLD OFF caution removed.
 - Right engine TEMP increases 5° to 90°C.
 - Cabin airflow resumes.
 - c. BLEED AIR knob - NORM
 - L BLD OFF caution removed.
 - MASTER CAUTION light out.
 - d. FIRE test switch - TEST A (for at least 2 seconds)
 - L and R BLEED warning lights on while switch held.
 - Voice alert sequence initiated.
 - L and R BLD OFF cautions displayed.
 - Cabin airflow stops.
 - e. BLEED AIR knob - CYCLE THRU OFF TO NORM
 - L and R BLD OFF cautions removed.
 - Cabin airflow resumes.
 - f. Repeat steps d and e for the TEST B position.
15. (C) Engine FIRE light shutdown - PERFORM
- a. Left throttle - IDLE (For 2 minutes)
 - b. Left FIRE light - PUSH
 - FIRE EXTGH READY light on
 - L BOOST LO caution on
 - MASTER CAUTION light on
 - Master Caution tone sounds

When rpm is less than 60% -

- L FLAMEOUT caution on
- "Engine Left/Right" voice warning sounds
- With engine at IDLE, it may take as long as 60 seconds before the engine shuts down.

When rpm is less than 10% -

- c. Left throttle - OFF
 - d. Left FIRE light - RESET
 - FIRE EXTGH READY light off
16. (C) Verify proper switching valve operation.
- a. Monitor HYD pressure. As pressure decreases below 1,500 psi, gently pump the stick approximately ± 1 inch fore and aft at approximately two cycles per second, decreasing hydraulic pressure on shutdown engine below 800 psi. Ensure system pressure on operating engine remains above 1,500 psi.
 - b. Continue gently pumping the stick while monitoring FCS page for FCS Xs and/or BLIN codes for 12 seconds after system pressure on shutdown engine drops below 800 psi. record if present.
 - c. Monitor FCS page for FCS Xs or BLIN codes. Record if present.
17. (C) APU - OFF
18. (C) Left engine - CROSSBLEED START
19. (C) Repeat steps 14 and 15 for the right engine.
20. (C) Right engine - CROSSBLEED START
21. (C) Hydraulic pressure - CHECK
 - Check that HYD1 and HYD2 pressures are 2,850 to 3,250 psi.

10.4.1.3 Before Taxi

- 1. (C) Before taxi procedures - PERFORM
 - Perform before taxi procedures IAW Chapter 7.
- 2. (C) Flight controls - CHECK/BIT
 - a. If wings folded verify both ailerons Xd out.
 - b. Flaps - HALF
 - c. FCS IBIT - INITIATE

WARNING

Flight with any PBIT BLIN other than 51, 124, 322 and 336, or IBIT BLIN 4124, 4263, 4322, 4336, 4522, 4526, 4527, 4773, 4774, and 70261 can result in a flight control system failure and aircraft loss. If IBIT detects any failure other than those indicated by the IBIT BLINs listed above, IBIT must be performed again, following an FCS reset, to ensure the detected failure no longer exists. Pressing the FCS reset button, simultaneously with the paddle switch, does not correct BIT detected flight control system failures; it simply clears the BLIN code(s) from the display. If the second IBIT is not successful, the aircraft requires corrective maintenance action to address the failure(s).

NOTE

If BLIN 51 does not reset after airborne, wing-fold function may not be available after landing.

- d. AOA warning tone - VERIFY ANNUNCIATION AT FCS IBIT COMPLETION
3. (C) FCC keep-alive circuitry - CHECK
 - a. FCC circuit breakers - Pull in sequence 1, 2, 3, and 4
 - b. Immediately reset in sequence 1, 2, 3, 4
 - Complete within 7 seconds for valid test.
 - No FCC channel completely Xd out.
4. (C) GAIN override switch - ORIDE
 - a. Check LAND advisory displayed.
 - b. GAIN override switch - NORM
5. (C) SPIN recovery mode - CHECK
 - a. Flaps - AUTO
 - b. Select FCS display on MPCD (aircraft 163985 AND UP).
 - c. SPIN recovery switch - RCVY
 - d. Check both DDIs - SPIN MODE ENGAGED
 - e. Flaps - CHECK LEF DOWN $33^{\circ} \pm 1^{\circ}$ down, TEF UP $0^{\circ} (\pm 1^{\circ})$.
 - f. SPIN recovery switch - NORM
6. (C) Full stabilator travel verification -
Set stab trim to 4° NU and verify that:

Flaps - FULL

AFT: 24 NU

FWD: 10 ND

Wings spread - R/L AILERON: 16 differential stabilator

(Wings folded - R/L AILERON: 20 differential stabilator)

7. (C) Flaps - FULL

While at full flaps, cycle stick in small circular motions (1 to 2 inches diameter) at a rate slower than one cycle per second. Stick motion should be smooth and continuous. If stick provides uncommanded movement, horizontal stabilator servocylinder and mechanical linkage troubleshooting is required prior to flight.

8. (C) Flaps - HALF

9. (C) Trim - CHECK

a. Trim - FULL LEFT and UP

b. T/O TRIM button - PRESS UNTIL TRIM ADVISORY DISPLAYED

- Check that ailerons and rudders return to neutral, stabilator returns to 12° NU.

10.4.1.4 Taxi

1. (C) Emergency brakes - CHECK

- No appreciable change in performance should be observed compared to the normal system.

NOTE

Anti-skid system is inoperative during emergency brake system operation.

10.4.1.5 Before Takeoff

1. (C) Before takeoff procedures - PERFORM

- Perform the before takeoff procedures IAW Chapter 7.

10.4.1.6 Takeoff

1. (C) FCS RIG Check - 10,000 Feet

Only perform if -

- Aircraft symmetrically loaded (external/internal wing tank fuel asymmetry less than 300 lb).
- Autopilot mode - Disengage in 1g flight
 - Check memory inspect unit 14, address 5016. If first and third lines are not between 177200 and 177777 or between 000000 and 000600, re-trim laterally until within this range.
 - Stabilize at each incremental airspeed and trim rudder, if required, to center ball prior to roll-off check. Release controls from wings-level and record the direction of roll-off and angle-of-bank (AOB) at the end of 6 seconds.

- d. 200 KCAS
- e. 300 KCAS
- f. 400 KCAS
- g. 500 KCAS
- h. 550 KCAS

- The 550 KCAS check should not be performed if a pod is loaded on station 4 or 6.

NOTE

RIG Check fails if any AOB $> 30^\circ$ ($> 5^\circ$ per second); however, for diagnostics purposes, complete all applicable roll-off checks.

10.4.1.7 Medium Altitude (15,000 Feet)

NOTE

Altitude blocks are suggested ONLY to provide a logical sequence for the FCF procedures. Deviations from these block altitudes are acceptable unless specified.

1. (C) Flight control damping - CHECK
 - a. Airspeed - Maintain 300 to 350 KCAS
 - b. Make small, abrupt pitch, roll, and yaw inputs.
 - Aircraft response is appropriate.
 - No oscillation tendencies noted.
2. (C) AFCS - CHECK
 - a. A/P - At 350 knots, 15,000 feet with bank angle $\leq 5^\circ$, engage A/P switch.
 - Check that aircraft maintains heading.
 - b. Attitude hold -
 - (1) Bank aircraft 45° left using CSS.
 - Check that aircraft maintains attitude.
 - (2) Bank aircraft 45° right using CSS.
 - Check that aircraft maintains attitude.
 - (3) Input $\pm 10^\circ$ pitch commands using CSS.
 - Check that aircraft maintains heading and attitude.
 - c. Heading select -
 - (1) Select 30° left heading change with the HDG set switch. Select HSEL option.
 - Check that heading hold is reestablished after selected heading is captured.

(2) Repeat with 30° right heading change.

d. Barometric altitude hold -

(1) Select BALT option during a 4,000 feet/minute climb.
 • Check that altitude is captured and maintained.

(2) Repeat during 4,000 feet/minute dive.

(3) Perform 45° bank turn.
 • Check that altitude is maintained within ±100 feet.

3. (C) Perform negative G check for FOD.

10.4.1.8 18,000 TO 10,000 Feet

1. (C) LEF System - CHECK

a. G-WARM - Perform

b. Stabilize at 450 knots/10,000 feet MSL. Commence a MIL power loop with a firm initial pull to 4.5-5g. Monitor LEF position on the FCS page. Discontinue check if left-to-right split is greater than 5°. Any left-to-right split in flap position greater than 5° shall be recorded, and follow-up maintenance action is required. Do not exceed 20° AOA with a split between left and right LEF. If an HDU is weak the split should be seen during the first 90° of the loop. Greater than 5° of left or right LEF split will likely result in uncommanded yaw/roll during maneuvering flight.

2. (C) FCF Profile - COMPLETE

10.4.2 Checkflight Requirements (Rear Cockpit). This Rear Cockpit section outlines only the additional checks to establish acceptance standards for the systems peculiar to the F/A-18B/D aircraft. The checks and success criteria specified in the Front Cockpit section also apply to the F/A-18B/D aircraft. Instrument and indicator reading, warning lights, and radar and navigation displays in the rear cockpit are to be compared throughout the flight with corresponding information available from the front cockpit. An aft crewmember is required for D profile FCFs. For A, B, or C profiles, if an aft crewmember is available, the following checks should be made.

10.4.2.1 Before Taxi. Perform the before taxi procedures IAW Chapter 7.

1. (C) Speedbrake - CYCLE

• On aft stick and throttle equipped F/A-18D check operation of the speedbrake from the rear cockpit.

10.4.2.2 Taxi

1. (C) Emergency brakes - CHECK

NOTE

Anti-skid system is inoperative during emergency brake system operation.

10.4.2.3 10,000 Feet to Landing

1. (C) Flight controls and throttles - FUNCTIONALLY CHECK
2. (C) Hand controllers - CHECK
 - Verify operation of hand controllers. Selection of displays in rear cockpit shall not affect display selection in forward cockpit.
3. (C) FCF Profile - COMPLETE

10.5 FCF CHECKLIST - PROFILE D

10.5.1 Checkflight Requirements (Rear Cockpit). This Rear Cockpit section outlines only the additional checks to establish acceptance standards for the systems peculiar to the F/A-18B/D aircraft. The checks and success criteria specified in the Front Cockpit section also apply to the F/A-18B/D aircraft. Instrument and indicator reading, warning lights, and radar and navigation displays in the rear cockpit are to be compared throughout the flight with corresponding information available from the front cockpit. An aft crewmember is required for D profile FCFs. For A, B, or C profiles, if an aft crewmember is available, the following checks should be made.

10.5.1.1 Before Taxi. Perform the before taxi procedures IAW Chapter 7.

1. (D) IFEI - CHECK (F/A-18D)
 - During front cockpit BIT, make sure the TOTAL and INTERNAL displays agree with front cockpit displays.
2. (D) Speedbrake - CYCLE
 - On aft stick and throttle equipped F/A-18D check operation of the speedbrake from the rear cockpit.
3. (D) Attitude reference indicator - CHECK
 - Check that attitude reference indicator is adjustable. Minimum adjustment is $\pm 5^\circ$.
4. (D) Standby altimeter - SET AND CHECK
Set reported barometric pressure in window.
 - Check that altimeter reads within ± 60 feet of ramp elevation.
5. (D) Warning/caution lights - TEST
 - Check for proper operation of the warning/caution lights.
6. (D) DDI's - ON AND SET
 - Set the brightness or contrast as desired.

Aircraft 164196 AND UP -

7. (D) OXY FLOW knob - ON
 - Check flow
8. (D) Trim - CHECK
Trim ail full left/right and stab full nose up/down.

10.5.1.2 Taxi

1. (D) Brakes - TEST
 - a. ANTI SKID switch - OFF
 - SKID advisory on
 - Check brakes when leaving the chocks.
 - b. ANTI SKID switch - ON
 - SKID advisory off
 - c. Normal brakes - CHECK
 - Check brakes during taxi.
2. (D) Nosewheel steering - CHECK
 - NWS responds appropriately in LO and HI gain modes.
 - NWS disengages when paddle switch held.
3. (D) Emergency brakes - CHECK

NOTE

Anti-skid system is inoperative during emergency brake system operation.

10.5.1.3 Before Takeoff

1. (D) Throttles - CHECK
 - Check smooth operation:
 - If F404-GE-400 Engine** - from idle (61 to 72 % N_2) to MIL (102 % N_2 max)
 - If F404-GE-402 Engine** - from idle (63 to 70 % N_2) to MIL (102 % N_2 max)

10.5.1.4 Medium Altitude (15,000 Feet)**NOTE**

Altitude blocks are suggested ONLY to provide a logical sequence for the FCF procedures. Deviations from these block altitudes are acceptable unless specified.

1. (D) COMM - CHECK
 - Comm switches function normally.
 - Both radios operative in transmit and receive.
 - UHF and VHF preset, manual and guard frequency selection operative.
2. (D) Flight control damping - CHECK
 - a. Airspeed - Maintain 300 to 350 KCAS

- b. Make small, abrupt pitch, roll, and yaw inputs.
 - Aircraft response is appropriate.
 - No oscillation tendencies noted.
- 3. (D) A/P engaged, paddle switch - PRESS
 - Check A/P disengages.

10.5.1.5 High Altitude (Above 30,000 Feet)

- 1. (D) Cabin pressurization/temperature - MONITOR
 During climb, check cabin pressurization/temperature control. Pressurization shall remain at 8,000 feet up to 23,000 - 24,000 feet altitude. Above 23,000 to 24,000 feet altitude refer to figure 2-37.

AIRCRAFT ALTITUDE	CABIN ALTITUDE
30,000 feet	10,000 to 12,000 feet
40,000 feet	15,000 to 17,000 feet

10.5.1.6 18,000 TO 10,000 Feet

- 1. (D) Standby flight instruments - CHECK
 - a. Standby rate of climb indicator
 - Indicates ±100 fpm or less during level 1g flight.
 - Pointer movement smooth during climbs/descents.
 - b. Standby attitude reference indicator
 - During the 360° roll right and left, no gyro tumble is permitted.
 - After completion of the loop, errors in pitch and roll may be present, particularly if the loop is conducted in a wings level attitude. This is normal and the errors should be removed by caging the indicator while the aircraft is in normal straight and level attitude.
 - c. Standby airspeed indicator
 - Agrees with HUD.
 - Pointer movement is smooth during airspeed changes.
 - d. Standby altimeter
 - Agrees with barometric altitude on HUD.
 - Pointer and drum movement is smooth and does not hang up during thousand-foot changes.

NOTE

The HUD airspeed and altitude values are corrected by the ADC and the standby instruments are not. Therefore, under certain flight conditions the standby instruments may not agree with the HUD.

- 2. (D) HOTAS - CHECK
 - Check TDC all displays, RAID, A/A weapon select.

10.5.1.7 10,000 Feet to Landing

1. (D) Flight controls and throttles - FUNCTIONALLY CHECK
2. (D) Emergency landing gear system - CHECK
 - a. Flaps - HALF
 - b. Slow to 160 knots if practical.
 - c. Pull the EMERG LDG GEAR handle until it locks in the detent. (This is to be accomplished without any activation of the front cockpit emergency extension system.)
 - d. Check that gear indicates down within 30 seconds.
 - e. Front crewmember set the landing gear handle to DN and hold the HYD ISO switch in ORIDE for 10 seconds or until the APU ACCUM caution is removed and the emergency brake accumulator is recharged (gauge reads 2,750 to 3,250 psi and the needle stops moving).



To prevent damage to the main landing gear, the landing gear handle must be outboard (down position) before resetting the handle from emergency to normal. Wait 5 seconds following the circuit breaker or handle reset before placing the landing gear handle up.

- f. Reset the rear EMERG LDG GEAR handle, then have front crewmember raise the landing gear.

10.5.1.8 After Landing

1. (D) BIT - CHECK DISPLAY
2. (D) FCF Profile - COMPLETE

PART IV

FLIGHT CHARACTERISTICS

Chapter 11 - Flight Characteristics

CHAPTER 11

Flight Characteristics

11.1 HANDLING QUALITIES

The flight control system (FCS) is designed to provide both stability and controllability. Stability, the measure of the aircraft's resistance to external disturbing forces, provides a predictable and steady platform for accomplishing various weapons delivery tasks. Controllability, the measure of ease of changing the aircraft's speed, direction and acceleration provides the means for flying the aircraft aggressively. The flight control system achieves both stability and controllability by monitoring aircraft motion and pilot input, applying preprogrammed control laws, and then commanding control surface movement to provide the responsiveness and maneuverability of an agile fighter and the steady platform of a good attack aircraft.

11.1.1 Flight Control Modes. Handling qualities are dependent on the mode in which the FCS is operating. The mode is determined by the FLAP switch position (AUTO or HALF/FULL). However, if airspeed exceeds approximately 240 KCAS the flight controls automatically switch to the AUTO mode regardless of the FLAP switch position. The FCS control laws are designed to minimize transients when transitioning between modes.

11.1.2 HALF or FULL Flap Configuration. The FCS incorporates full-time AOA feedback in the flaps HALF or FULL mode. For this reason, longitudinal trim is required when changing AOA and/or airspeed. When the aircraft is trimmed to an AOA, it tends to maintain that AOA and some longitudinal stick force or trim is required to fly at another AOA. The aircraft is very responsive in pitch. Precise aircraft response is generally best achieved using small control inputs. Rapid longitudinal control inputs can saturate the stabilator actuator resulting in a PIO. PIOs have occurred during both field and carrier approaches, especially when using ATC. During the final portion of approaches using ATC, try to make small pitch control inputs. Although lateral response is characterized by slight adverse yaw, heading control is good.

11.1.2.1 Stalls in HALF or FULL Flaps. With flaps HALF one g stalls exhibit somewhat better lateral directional flying qualities than with flaps FULL. Wing rock and sideslip excursions occur in the 20° AOA region. Warning cues occur at 12° (increasing stick force gradient) and 15° (departure warning tone). With flaps FULL, as AOA increases to 12°, buffet and the departure warning tone provide good stall warning cues of impending high AOA. At 12° AOA, an increase in the stick force/AOA gradient can also be felt. This provides additional stall warning. Onset of wing rock occurs in the 15° AOA region. As AOA is further increased, aft stick requirements increase. Wing rock increases in amplitude and is accompanied by sideslip oscillations as the aft stick stop is reached. For either flap setting, maximum attainable AOA is about 25°. Large rates of descent may occur above the AOA limit in HALF or FULL flaps. Immediate stall recovery is obtained by neutralizing longitudinal stick which rapidly reduces AOA and allows the aircraft to attain the current trim value.

11.1.2.2 Takeoff and Landing Characteristics. During takeoff, stick aft of neutral should be commanded at the computed Nose Wheel Lift Off (NWLO) speed (see Chapter 7). Commanding aft stick too early can result in longer takeoff rolls due to the added drag of the stabilators. While the aircraft has WOW, the flight control logic has been optimized for catapult takeoff and is designed to anticipate flight by programming in some functions during the takeoff roll. However, during the landing rollout, some of these functions make the aircraft sensitive to control inputs and could cause

the pilot to overcontrol directional and lateral inputs if proper landing technique is not used. This is particularly true during wet runway or crosswind landing. Gross misapplication of the control stick or rudder pedals can cause lateral and directional control problems regardless of runway condition. Two separate WOW functions control the FCS logic after touchdown. The first occurs when the aircraft weight is on any two landing gear. When this occurs, the FCS no longer attempts to maintain trim AOA. Stabilator position is a function of stick position and trim setting. The speedbrake can also be extended and remain extended without having to hold the speedbrake switch aft. Additionally, the rudder pedal to roll CAS interconnect is faded to zero. The second function occurs after aircraft weight is on two wheels and airspeed is below 100 knots. At this time, the rolling surface to rudder interconnect (RSRI) is faded to zero. Thus, during normal landing rollout, the RSRI is active until 100 knots. As a result, above 100 knots a lateral stick input also commands the rudder in the same direction in anticipation of adverse yaw that would normally occur in flight. Use of lateral stick should be minimized during the landing roll.

11.1.2.3 Takeoff, Landing, and Catapult Launch with High Lateral Weight Asymmetries.

Acceleration during field takeoff will result in yaw in the direction of the asymmetry that is easily controlled with appropriate NWS inputs. After field takeoff, expect a controllable roll into the heavy wing. Setting the appropriate lateral trim minimizes roll rate after catapult launch. During dual engine operation and at normal takeoff and landing angles of attack, sufficient lateral directional control power is available with flaps HALF or FULL and lateral weight asymmetries up to 26,000 ft–lbs. At asymmetries below 20,000 ft–lbs, lateral directional control does not degrade until about 18° AOA, where the lateral directional control power becomes insufficient to counter yaw/roll rates. At asymmetries above 20,000 ft–lbs, lateral directional control power does not degrade until about 15° AOA, where the directional control power becomes insufficient to counter yaw rates. During single engine operation, lateral weight asymmetry significantly increases minimum control airspeed. At high asymmetries, exceeding 12° AOA with flaps HALF and 10° AOA with flaps FULL may generate yaw rates that cannot be arrested with rudder unless AOA is reduced. Additionally, large lateral stick inputs (over ½ stick deflection) during single engine, high asymmetry operation can result in adverse yaw and compound directional controllability. As a result, countering yaw/roll in the landing or catapult launch configuration requires aggressive rudder inputs combined with proper AOA control, timely stores jettison, and judicious use of lateral stick (less than ½ stick deflection).

NOTE

When raising the flaps from HALF to AUTO while accelerating during missed approach with high lateral asymmetry, large sideslip excursions will be experienced. These excursions result in full scale deflections of the slip indicator (SI) ball and damp out after a few seconds. Avoid chasing the ball with rudders as that will tend to aggravate the condition. Maintain previous rudder input until oscillations have damped out, then use rudders as necessary to maintain balanced flight.

When landing in a crosswind, land with the heavy wing upwind if possible. Landing with the heavy wing upwind increases lateral control power and improves lateral directional handling characteristics. On touchdown, the light wing will rise 3 to 5°, depending on the lateral asymmetry. The greater the asymmetry, the greater the wing rise. This wing rise is comparable to landing in a 15 knot crosswind, and can be countered by judicious lateral stick input. The aircraft is easily controlled. Aggressive

braking will result in yaw away from the asymmetry that can be countered with appropriate NWS inputs.

NOTE

Due to the landing gear structural limitations, internal wing fuel and wingtip missile lateral asymmetry must be used to calculate total lateral weight asymmetry for landing.

11.1.3 Auto Flap Configuration. The FCS control laws create slightly different handling qualities than those of most aircraft. The most apparent characteristic is the excellent hands-off stability. Damping about all axes is high. Static longitudinal stability is neutral since the FCS attempts to keep the aircraft in 1 g, zero pitch rate flight. Longitudinal trim is used to bias (adjust) the reference load factor or pitch rate as the pilot desires. Longitudinal trimming is not required as the aircraft accelerates or decelerates through most of the flight envelope. Once an attitude is set, the aircraft tends to hold that attitude without further stick inputs, even through the transonic speed regime. This characteristic reduces stick forces with changing airspeed, lowering pilot workload for most tasks. However, some flight tasks are made more difficult because the FCS attempts to maintain 1 g flight. For example, during a dive or steep zoom climb, a small but constant forward stick force is required to maintain a constant attitude. Airspeed changes cannot be sensed through changing stick forces and difficulty may be encountered when trying to maintain a desired airspeed during high workload tasks such as instrument penetration/approach. The FCS incorporates AOA feedback above 22° AOA. To increase AOA above the feedback AOA of 22°, aft stick must be applied. The AOA for the highest lift available (CLmax) is approximately 35° AOA. The maximum steady state AOA with full aft stick (35 pounds stick force) is 50 to 55°. AOA control is good up through max AOA. If the aft stick is released, the FCS commands nose down pitch until the AOA is reduced below the feedback AOA of 22°. At this time, the AOA feedback is removed and the FCS again seeks to maintain 1 g flight.

A constant departure warning tone is activated above 35° and below -7° AOA. With inboard tanks and stores on outboard stations the tone is activated at 25° AOA. The warning tone provides information that: (1) the pilot may have placed the aircraft in a departure prone region of the flight envelope; or (2) the aircraft is near the AOA for maximum lift (CLmax). However, the departure warning tone logic has not been updated to reflect the expanded AOA envelope provided by FCC PROM 10.7.

11.1.4 Pitch Stability. The FCS provides artificial pitch stability in CAS that prevents significant handling qualities variation with CG movement due to fuel transfer or stores release/delivery. Longitudinal control effectiveness and pitch damping are satisfactory up to the AOA/CG limits listed in Chapter 4. These limits are based on aircraft pitch stability margins and prevent the aircraft from entering an AOA hang-up condition. During flight in a degraded FCS mode (MECH or pitch DEL) aircraft stability is seriously degraded aft of the CG limit and controllability is significantly reduced.

11.1.5 Stick Force. In maneuvering flight, there is a light but constant stick force per g (about 3.5 to 4.5 pounds/g). Unlike many other aircraft, maneuvering stick forces do not vary significantly over the entire operating envelope as long as the AOA is less than AOA feedback of 22°. Where AOA feedback is active, maneuvering stick forces are increased significantly.

WARNING

Rapid aft stick movement, with or without g limit override, commands a very high g onset rate. This high g onset rate can cause immediate loss of consciousness without the usual symptoms of tunnel vision, greyout, and blackout. Consciousness may not return for more than 20 seconds after the g level is reduced to near 1 g.

11.1.6 Pitch Up. A pitch bobble occurs during speedbrake extension/retraction especially during high speed flight. There is a slight tendency to over control pitch during speedbrake operation in tight formation at high speed (over 400 knots). The aircraft exhibits a moderate transonic pitch up when decelerating rapidly through the Mach 1.0 to 0.95 while maintaining a high load factor. This pitch up seldom is more than a 1½ g increment in load factor. This transonic pitch up is not noticeable during 1 g deceleration or slow deceleration at high load factors.

11.1.7 G-Limiter. The g-limiter function in the FCS limits commanded load factor under most flight conditions to the symmetric load limit (NzREF) based on gross weight below 44,000 pounds gross weight (maximum NzREF limit of 7.5 g). Above 44,000 pounds, NzREF is held constant at 5.5 g. The negative load factor limit command is fixed at negative 3 g's for all gross weights. At weights greater than 32,357 pounds the g-limiter does not provide adequate negative g protection and aircraft overstress is possible.

During rolling maneuvers, the g-limiter reduces commanded load factor up to 80 % NzREF. The additional reduction begins with 0.75 inch lateral stick up to 80 % at full lateral stick input of 3 inches. Very abrupt stick commands can exceed the capabilities of the system and result in an overstress. The g-limiter can be disengaged during emergency situations by pressing the paddle switch to allow 33 % more load factor capability, but overstress is much more likely in this condition. During decelerations through transonic flight conditions (0.88M - 1.04M) NzREF is decremented to account for dynamic pitch-up transients. This FCS function, called the G-bucket, automatically unloads the aircraft to prevent exceeding the design load limit.

11.1.8 Aircraft Stability and Dynamic Response. The aircraft roll rate is good throughout the flight envelope. The roll response is essentially constant through 15° AOA. Rolls conducted at 15 to 20° AOA are prone to slight residual left/right motion upon termination. Above 20° AOA, sideslip and sideslip rate feedbacks become active to damp out sideslip oscillations and minimize left/right residual motion. From 25 to 35° AOA, roll performance gradually decreases with increasing AOA. Above 25° AOA, pedal and lateral stick inputs provide similar responses. Above 35° AOA and at low airspeed the roll performance is essentially constant. If the AOA is over 35°, the yaw rate warning tone is replaced by the departure warning tone and yaw rate warning is not available. From 35 to 55° AOA, combined lateral stick and pedal inputs produce enhanced roll performance compared to individual control inputs. AOA excursions into the 60s are possible with this input, which can have the consequence of blanking the air data system and indicating 48 KCAS in the HUD. Above 40° AOA small sideforce oscillations may occur. Full aft stick results in maximum sustained AOA's between 50 and 55°. At these AOA's, high rates of descent (18,000 fpm) occur and the aircraft exhibits small, stable pitch oscillations. Above 50° AOA, undesirable yaw rates can develop, particularly with imperfections on the radome. Rates can be noticeably higher than minor yaw rate tendencies. Loud airframe and vortex rumbling noises are heard in the cockpit in the 50 to 55° AOA region. If a yaw rate develops in the 50 to 55° AOA region, easing the control stick forward off the aft stop should immediately reduce the AOA below 50° and terminate the yawing motion.

WARNING

If AOA is not immediately reduced, sustained yaw rate in the 50 to 55° AOA region can lead to the display of spin recovery command arrows and inadvertent departure from controlled flight.

At Mach numbers greater than 0.8 at AOA greater than 20°, roll control power available to the pilot is automatically reduced by the FCS in order to prevent nose slice departures.

Rolling at less than 1 g can cause large roll coupling tendencies and can lead to a departure. The further the g level decreases below 1 g, the larger the coupling tendencies become and the tendency toward departure increases. If the pilot feels the roll is starting to diverge, through lateral looseness or rapid uncommanded pitch excursion, he should immediately neutralize controls and terminate the roll.

The flight characteristics described above combine to provide a very agile fighter throughout the envelope. Excellent pitch pointing capabilities beyond 35° AOA and precise lift vector placement allow rapid acquisition and fine tracking of air-to-air targets. Above 25° AOA, rudder pedal and lateral stick inputs command very similar deflection of control surfaces and thus, similar aircraft performance for bank angle and lift vector control. For symmetrically loaded aircraft, the excellent departure resistance provides the capability to aggressively reposition the aircraft lift vector with stick and rudder inputs, even while maintaining high AOA.

11.1.8.1 High AOA Flying Qualities. Use caution during low-speed overhead maneuvers as the aircraft tends to enter a tailslide if airspeed is insufficient to complete the maneuver. Aft stick must be increased near the top of a slow speed loop. If the controls are released or aft stick is not increased, AOA feedback commands enough nose down stabilator (full nose down if necessary) to reduce the AOA below feedback AOA (22°) that can result in a relatively steady, nose-high attitude. Apply sufficient aft stick while enough airspeed is still available to establish and maintain a positive pitch rate to keep the aircraft nose tracking through the horizon. Use maximum allowable AOA based on stores loading and center of gravity. Maintain aft stick until the nose is below the horizon and airspeed is increasing. Neutralizing or releasing the controls near the top of a low-speed overhead maneuver is not a good practice because the nose does not tend to fall through due to the AOA feedback driving full nose down stabilator, resulting in a nose high, inverted condition as described above. PROM 10.7 increases departure resistance and improves recoverability from out-of-control flight, but it does not prevent departures due to insufficient airspeed. If the aircraft ceases to respond to control inputs, an out of control situation exists.

WARNING

Starting overhead maneuvers with insufficient airspeed may lead to nose high, ballistic conditions and departure. The aircraft responds to control inputs at low airspeed with few cues to impending loss of control. Recovery from post departure gyrations and developed out of control motion can require considerable altitude. Entry into such a departure at low altitudes will likely preclude recovery prior to ground impact.

The excellent controllability and maneuverability at high AOA provided by the FCS control laws result in superior nose pointing and gun tracking at low airspeeds. Aircraft response to stick and rudder pedal inputs is crisp and easy to manage, making lift vector control easy up to 35° AOA. Above 20°

AOA, sideslip and sideslip rate feedback (beta and betadot feedback) provide rapid aircraft maneuverability with aggressive control inputs without sacrificing departure resistance. Enhanced departure resistance allows the pilot to safely command yaw rates up to the yaw rate tone (40°/sec). Above 25° AOA, lateral stick or rudder command the same, well controlled, aircraft rolling response. If opposite stick and pedal are commanded the inputs will essentially cancel each other out and little to no roll response will result.

The FCS incorporates pirouette logic to produce abrupt heading reversals at high AOA (>25°) and low airspeed (<210 KCAS). Pirouette logic can be engaged above 25° AOA and below 210 KCAS by applying full lateral stick and pedal in the same direction. When the criteria are met, the FCS recognizes the pilot's desire to rapidly reverse aircraft heading and displaces control surfaces appropriately, resulting in a well controlled maneuver. Spin display logic is modified during a commanded pirouette to prevent nuisance spin indications. Aircraft motion can be stopped at the desired heading by applying full lateral stick and pedal in the direction opposite that which initiated the maneuver.

11.1.8.2 High Speed Asymmetric FLIR Pod Handling Qualities (TFLIR, ATFLIR, NAVFLIR). Flight of a clean aircraft with a single TFLIR/ATFLIR pod (with or without pylons) will result in a roll-off in the direction of the pod of up to 12°/second at transonic (0.90–1.05 IMN) Mach numbers. Above 1.05 IMN, the roll-off begins to decrease, and eventually reverses direction above 1.15 IMN. Although not individually flight tested, the NAVFLIR is considered to be aerodynamically equivalent to the TFLIR/ATFLIR and is expected to produce similar roll-off characteristics. Above 0.90 IMN, slight variations in Mach require large variations in both lateral and directional trim settings to reduce roll-off and large side forces and maintain "hands off" balanced flight. The magnitude of the roll-off at peak conditions (0.95 IMN) can be trimmed out. Additionally, lateral inputs are required under elevated load factor to maintain the same roll attitude. This additional pilot workload should be considered during low altitude flight where mission crosscheck time is critical.

Although an asymmetric FLIR pod produces only 1,500 ft-lb of lateral weight asymmetry, it can result in a significant amount of lateral aerodynamic asymmetry during flight above 0.90 IMN. The roll-off phenomenon is dominated by this aerodynamic asymmetry, not the lateral weight asymmetry. During flight simulation, level bomb deliveries using the FLIR for target identification and refinement were flown in a night environment with no outside visual reference. Uncommanded roll-off appeared as a rotating FLIR image similar to what is displayed during over-flight of the designated target. It is possible that uncommanded aircraft bank changes, seen as a rotating FLIR image through the sensor, may be confused with the rotating image that results from target over-flight.

WARNING

Uncommanded roll-off due to single FLIR pod carriage during heads-down sensor operation may result in an unusual aircraft attitude, disorientation, altitude loss, and possible CFIT.

11.1.9 Flying Qualities with Lateral Weight Asymmetries. The aircraft demonstrates good flying qualities with lateral weight asymmetries up to 26,000 ft-lb. With low lateral weight asymmetries (less than 8,000 ft-lb), flying qualities are excellent. The heavy wing tends to drop under positive g, and rise during negative g. The greater the load factor, the greater the lateral stick deflection required to maintain wings level. As load factor is increased, lateral stick opposite the heavy wing is required to maintain wings level up to approximately 25° AOA, above which lateral stick into the heavy wing is required to maintain wings level or minimize roll rate. Maneuvering flight need not be avoided;

although, special attention to AOA and sideslip control is recommended. During aggressive aft stick maneuvers with lateral asymmetries between 6000 and 8000 ft-lbs (no positive AOA limit for air-to-air loadings), sideslip into the heavy wing builds notably as the aircraft rolls towards the heavy wing. The tendency to roll into the heavy wing can be countered with either combined full lateral stick and rudder pedal inputs or by relaxing the aft stick input to reduce AOA. Full lateral stick inputs followed by full aft stick inputs without first centering the lateral stick (as in guns defense maneuvering) will result in rapid sideslip buildup and a nose-slice departure. Recovery from this departure occurs quickly by neutralizing controls.

NOTE

Sideslip buildup into the heavy wing is typical as AOA exceeds 25° with asymmetries near 6,000 ft-lbs, and may result in a nose slice departure. Departure susceptibility increases above Mach 0.6, and is most severe at Mach 0.9. Additionally, full lateral stick inputs towards the heavy wing may increase departure susceptibility. Yaw (sideslip buildup) can be countered with lateral stick or pedal, or by reducing AOA.

During maneuvering flight with high lateral asymmetries (12,000 to 26,000 ft-lb), lateral control is sufficient up to the 12° AOA limit. As 10° AOA is approached, moderate airframe buffet and vortex rumble occur. During flight with high lateral asymmetries, sideslip must be kept to a minimum to avoid departure. More attention than normal is required to keep the slip indicator (SI) ball centered, especially during maneuvering flight. Maneuvering flight with high lateral asymmetries should be kept to a minimum.

WARNING

Exceeding the lateral asymmetry AOA limits may result in departure from controlled flight and spin entry.

11.2 OUT-OF-CONTROL FLIGHT (OCF)

11.2.1 Departure Resistance. The FCS incorporates a number of features that augment the aircraft's natural departure and spin resistance. In CAS mode, very aggressive maneuvering is possible. The F/A-18 is very stable and controllable throughout most of the operational flight envelope. However it is departure prone in some flight regimes which pilots must be aware of to avoid inadvertent departures. Factors that directly affect entry and recovery from OCF are external store loading, aft CG, lateral asymmetry, and flight control degradations. Misapplied controls and/or overaggressive maneuvering in departure prone regions of the flight envelope cause nose-slice departures. Application of excessive coordinated inputs, cross control inputs or aggressive forward stick significantly increases risk of departure. As Mach increases, this risk further increases. Asymmetric thrust, including Max/Idle or Max/Flameout splits does not, by itself, cause a departure. However, large thrust asymmetry combined with aggravated pilot control inputs may cause a nose-slice departure under otherwise benign conditions. Lower altitudes aggravate asymmetric thrust effects due to the larger thrust differential.

Yaw stability augmentation significantly reduces the likelihood of departure throughout the envelope. Addition of sideslip and sideslip rate feedback as well as differential stabilator for yaw rate generation, an improved inertial coupling limiter and rudder deflection limits in the low AOA region,

all increase the departure resistance of the aircraft. Single axis maneuvering is extremely departure resistant. Roll or yaw inputs combined with aft stick movement are also very resistant to departure. The aircraft is most susceptible to departure when roll or yaw inputs are combined with forward inputs, particularly from high AOA and greater than Mach 0.6. Cross control inputs are also very departure prone above Mach 0.6 and low AOA. Directional stability can be weakened due to carriage of stores or lateral weight asymmetries, particularly at high g and high calibrated airspeed above 20 to 25° AOA.

Pilot awareness of NATOPS flight limitations/procedures with regard to these factors is fundamental for prevention of and recovery from OCF situations. It is also imperative that the pilot realize how to identify a departure. The aircraft has departed when it is not properly responding to control inputs. Continued control inputs may aggravate the departure, resulting in a prolonged out of control situation. Releasing the controls, feet off rudders, and retracting the speedbrake recovers the aircraft from most departures.

11.2.2 Departure Characteristics. Typical F/A-18 departures occur as a yaw divergence (nose-slice) followed by an uncommanded roll in the same direction. The yaw rate warning tone may not provide sufficient departure warning. Vortex rumble which occurs when sideslip is excessive or during abrupt lateral acceleration is a good departure warning cue. However, vortex rumble may not be noticed during aggressive maneuvering. Side force build-up is also a good indicator of an impending departure. The initial phase of the departure is not particularly violent or disorienting unless it occurs at high airspeed/Mach, where large cross control inputs cause rapid unloading, abrupt nose down pitch rate and violent departure.



At AOAs below 5° and Mach 0.8 or greater, 3/4 to full cross control application results in violent departure and possible airframe damage.

The aircraft is significantly more departure prone with large lateral asymmetry. Departures at high airspeed with large lateral asymmetry are violent and yaw and roll away from the heavy wing. NATOPS AOA limitations must be honored to avoid departure. Excessive sideslip, which builds with AOA, increases departure susceptibility. Keep the slip indicator (SI) ball centered to minimize sideslip and consider coordinating rudder pedal input to during roll maneuvers into the heavy wing. Maximum AOA limits are significantly reduced as lateral asymmetry increases.

NOTE

Avoid aggressive roll maneuvers below 225 knots with any asymmetric external load.

Releasing the controls, feet off rudders, and retracting the speedbrake should recover the aircraft from most departures. If post departure oscillations continue, retard the throttles to idle to minimize engine stall. Consider locking the harness and grasping the left and/or right canopy bow handles to help stabilize the body. Do not use feet on rudder pedals as unintentional rudder can aggravate an out-of-control condition. Check altitude, AOA, airspeed and yaw rate for indications of recovery or development of a stabilized out-of-control mode. Post departure gyrations are characterized by large, uncontrollable changes in angle of attack and indicated airspeed, accompanied by sideforces and interchanging AOA and yaw rate tones. Post departure gyrations include uncommanded rolling and yawing motions in the same direction. Sideforce, felt in the cockpit as a sideways push, is a reliable

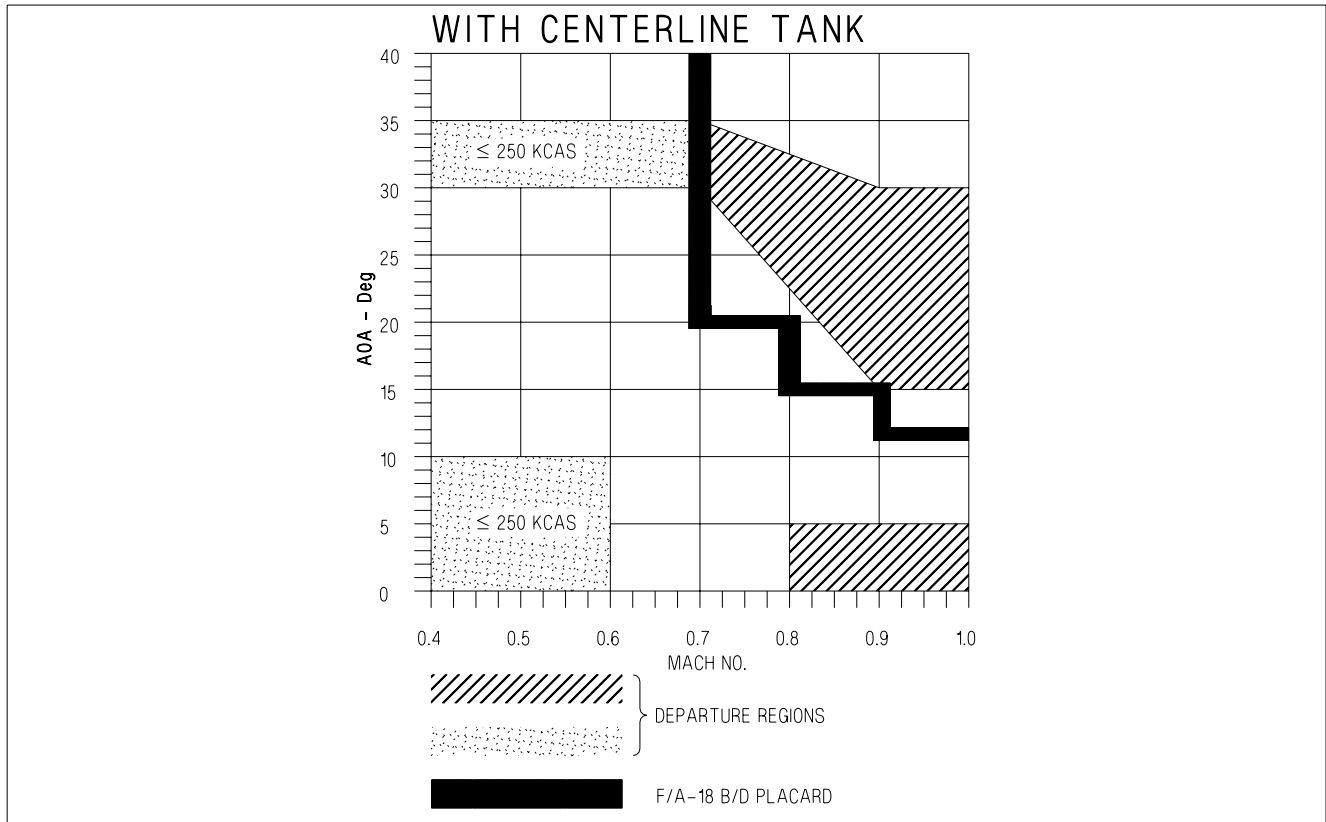

ADA520-319-1-045

Figure 11-1. F/A-18B/D Departure Regions

indicator of continued departure and is accompanied by a vortex rumble sound as air passes sideways over the canopy. The effects of time compression in conjunction with the rolling and yawing motions, and the appearance of transient spin arrows often lead to a premature perception of a spin. Pilot application of control inputs during post departure gyrations may delay recovery. Controls should remain released until all three indications of recovery are recognized, or a spin is positively confirmed. Indications of recovery from post departure gyrations are:

1. AOA and yaw rate tones removed.
2. Side forces subsided.
3. Airspeed accelerating above 180 knots.

The F/A-18 exhibits two Falling Leaf modes (upright and inverted), and four spin modes (three upright and one inverted.) The most common out of control flight mode encountered is the Falling Leaf. These modes are described in detail and summarized in the chart at the end of the section.

11.2.2.1 F/A-18 Departure Prone Flight Regions. PROM 10.7 improved recoverability from OCF significantly over earlier software versions. Departure regions previously attributed to the two-seat canopy are now mitigated for a symmetrically loaded aircraft. Departures have been eliminated in the low AOA/low airspeed region. With this in mind, the improvements do not make the Hornet a departure free aircraft. The following maneuvers and conditions may result in a departure:

Stick Forward while applying lateral stick at high AOA above Mach 0.6 - Large amounts of sideslip can be generated, resulting in several uncommanded residual left/right oscillations upon termination. The departure is aggravated when combined with pedal in the same direction.

Aggressive Maneuvering with 6,000 to 8,000 ft-lbs Lateral Weight Asymmetry - Full lateral stick inputs followed by full aft stick inputs without first centering the lateral stick (as in guns defense maneuvering) will result in rapid sideslip buildup and a nose-slice departure. The worst-case for this departure tendency is at 340 KCAS and 15,000 ft. Recovery from this departure occurs quickly by neutralizing controls.

Extremely Low Airspeed Flight Conditions - Residual oscillations can occur following the recovery from low airspeed conditions (less than 50 KCAS, typically nose-high). A low rate spin can sustain if the aircraft enters inverted flight, but will recover immediately as the aircraft enters a high AOA condition. Left/right oscillations are greater if the aircraft enters the low speed condition with one wing pointed towards the ground.

High Subsonic Mach and Low AOA - At high subsonic Mach and below 5° AOA, violent nose-slice departures occur if controls are misapplied (abrupt full coordinated control inputs combined with forward longitudinal stick) during rolling maneuvers at less than 1g. Initial departure motion is extremely rapid with no warning to the pilot. The departure is extremely violent and may result in overstress or airframe damage.

High Subsonic Mach and High AOA - With lateral weight asymmetries near 6,000 foot-pounds the F/A-18B/D has increased departure susceptibility at high subsonic Mach numbers (greater than Mach 0.7). Yaw away from the heavy wing can occur above 25° AOA and above Mach 0.7, becoming more severe at higher Mach numbers and may be difficult to counter with opposite pedal. Aggressive roll maneuvers into the heavy wing at greater than Mach 0.8 and greater than 25° AOA can produce yaw/roll motion away from the heavy wing that cannot be countered with full lateral stick or pedal inputs. The basic airframe directional stability is low in this region and aggressive high AOA maneuvering can lead to violent departures from controlled flight. Maneuvering should be terminated and controls neutralized immediately if yaw rate accelerates significantly or at onset of the yaw rate warning tone to avoid departure.

11.2.3 OCF Recovery. Post departure dive recovery must be initiated at no less than 6,000 feet AGL to assure safe ground clearance. If passing 6,000 feet AGL and dive recovery has not been initiated, eject. There is no buffer associated with the 6,000 foot mandatory ejection altitude. The 6,000 foot altitude addresses only altimeter errors, aircraft maximum recovery capability, and ejection seat capability. Delaying the ejection decision below 6,000 feet AGL while departed may result in unsuccessful ejection. Safe recovery may not be possible with flight control system failures. If safe post departure dive recovery is in doubt, eject. All indications of recovery must be present (AOA and yaw rate tones removed, all side forces subsided, and airspeed accelerating above 180 knots) before rolling upright to recover. For post departure dive recovery, minimum altitude loss is achieved by advancing throttles to MAX and maintaining 25 to 35° AOA until a positive rate of climb is established. If the store loading configuration prescribes an AOA limit below 35°, that lower limit should be used for recovery. If altitude loss is not critical, use less AOA and MIL power to reduce the chance of a follow-on departure because of potential asymmetric thrust, FCS failure and/or lateral asymmetric loading.

WARNING

- Post departure dive recovery initiated below 6,000 feet AGL is not assured. Delaying the ejection decision below 6,000 feet AGL while departed may result in unsuccessful ejection.
- Positive rate of climb requires wings level pitch attitude (waterline) greater than indicated AOA.

11.2.4 Falling Leaf Mode PROM 10.7 improved departure resistance and the Falling Leaf has not been encountered during extensive high AOA flight test. The new software improved recovery from OCF, making recovery from vertical slow speed departures benign in the two-seat centerline tank configured aircraft. The Falling Leaf mode is characterized by repeated cycles of large, uncommanded roll-yaw motions which reverse direction every few seconds. At each reversal the crew will sense high sideforce accompanied by near zero g. Entry into a sustained inverted Falling Leaf (predominately negative AOA) mode is highly unlikely.

The F/A-18 has a weak nose-down pitching moment capability in the 45 to 55° AOA region, and this capability is further reduced with an aft CG and/or external store loading. However, Falling Leafs have occurred at both forward and aft CGs. Susceptibility to entering the Falling Leaf mode is also increased with centerline tank loadings because of increased tendency for roll-yaw oscillations, which drive the large amplitude AOA oscillations exhibited in the Falling Leaf mode. This mode may be encountered after post departure gyrations during the final stages of spin recovery, or near zero airspeed (vertical) maneuvers.

Flight controls should remain released until recovery from a Falling Leaf is indicated. Extraordinary patience is required since the amount of nose-down pitch control power available for recovery is low due to the strong nose-up inertial pitch coupling generated in this mode. The upright/positive AOA Falling Leaf mode is the most common Falling Leaf mode. Large altitude loss may occur because of the high rate of descent which can exceed 20,000 ft/min. Positive indications that the aircraft is recovering are an increasing nose low attitude and an increasing peak airspeed. Recovery is normally preceded by the presence of a strong side-force coupled with an unload in a very nose low or slightly inverted attitude. During the Falling Leaf mode, transient spin arrows may be present. Do not chase the transient arrows as recovery may be delayed.

WARNING

Chasing transient spin recovery arrows delays recovery. Do not chase the spin arrows.

Conditions which indicate recovery from the Falling Leaf mode are:

1. AOA and yaw rate tones removed.
2. Side forces subsided.
3. Airspeed accelerating above 180 knots.

11.2.5 Spins. The F/A-18A/B/C/D exhibits four spin modes: low yaw rate, intermediate yaw rate, high yaw rate and inverted.

NOTE

A clean or symmetrically loaded aircraft is very reluctant to enter any spin mode with the FCS in CAS, but becomes extremely susceptible to departure or autorotative spin with with asymmetric store loadings when AOA limits are exceeded.

11.2.5.1 Low Yaw Rate Spin. The low yaw rate spin mode is characterized by AOA in the 50 to 60° range and a very low oscillatory yaw rate (0 to 40°/second). AOA excursions below 50° AOA may sometimes occur. This mode can be very smooth, although some mild pitch, roll and yaw oscillations are normally experienced. The low rate spin is not typically violent or disorienting. Low cockpit forces and a low yaw rate make this mode difficult to recognize as a spin. An oscillatory low yaw rate spin may be confused with a Falling Leaf. PROM 10.7 incorporated automatic anti-spin commands to protect against low yaw rate spins.

WARNING

In a low yaw rate spin, yaw rate may be too low/oscillatory for automatic engagement of the spin recovery mode (display of spin command arrows). Manual selection of the SRM mode (SRM switch to RCVY) may be required for recovery.

Rate of descent for an established low yaw rate spin is approximately 20,000 feet/minute with as much as 5,000 feet lost per turn. Entry to the spin typically occurs at AOA between 50 and 60°. Recovery from low yaw rate spins is very benign, predictable and repeatable with a gradual reduction in yaw rate followed by rapid break of AOA with a nose-low, accelerating recovery.

Asymmetric thrust and/or asymmetric store loading significantly increases the aircraft's susceptibility to the low yaw rate spin. Beyond the AOA limits for lateral asymmetries, there is increased susceptibility to entering a low yaw rate spin. Recovery characteristics are essentially the same as for symmetrically loaded aircraft. Prompt application of full antispin lateral stick will generate spin recovery in approximately one turn. Spins will be autorotative with the lateral asymmetries of approximately 10,000 ft-lbs or more. If recovery controls are not promptly applied, higher yaw rates generated by greater lateral asymmetry may result in rapid progression into the intermediate yaw rate spin mode.

11.2.5.2 Intermediate Yaw Rate Spin. Entry into an intermediate yaw rate spin is unlikely in clean or symmetric store loadings. Entry into this spin mode is more likely with large lateral asymmetry. Spin motion is characterized by higher average yaw rates (20 to 80°/second). In some cases, yaw rate may repeatedly oscillate through zero as spin rotation continues in one direction.

WARNING

In a highly oscillatory intermediate yaw rate spin, automatic engagement of the spin recovery mode may be delayed or inhibited if yaw rate repeatedly oscillates through zero. Manual selection of the spin recovery mode (SRM switch to RCVY) may be required if the SRM does not engage automatically.

The intermediate yaw rate spin is also very oscillatory in pitch and roll. AOA typically varies between 40 and 80° with bank angle excursions of $\pm 60^\circ$ or more. Bank angle variations may increase to the point where the aircraft executes one or more 360° rolls while continuing to spin. Rate of descent may be as high as 21,000 feet/minute with altitude loss of approximately 1,500 feet per turn. Cockpit side force may be as high as 1 g. While spinning, the aircraft will unload (negative g) during the 360° rolls. Due to the highly oscillatory motions and rapid variations in cockpit forces, this spin mode may be very disorienting, particularly if aircrew are not securely strapped in. Asymmetric store loading intermediate yaw rate spin characteristics are essentially the same as that of a symmetrically loaded aircraft. However, spins into the light wing are autorotative at asymmetries greater than 10,000 ft–lbs.

11.2.5.3 High Yaw Rate Spin. The high yaw rate spin mode is characterized by yaw rates in the 100 to 140°/second range and AOAs up to 80 to 90°. This mode is best described as a smooth flat spin. Small oscillations in pitch and roll occur but are not generally perceived by the pilot. Longitudinal forces in the cockpit can be as high as -3.5 g (eyeballs out). Consequently the pilot will be significantly hindered in recovery unless the shoulder harness is manually locked. In the high yaw rate spin mode, identification of the mode and turn direction is not difficult. Rate of descent for an established high yaw rate spin averages 18,000 feet/minute (1,000–1,500 foot/turn). Entry into this mode is possible only with sustained (more than 15 seconds) full pro–spin lateral stick with the spin recovery switch in RCVY or with very large lateral asymmetry.

With a centerline tank, the high yaw rate spin may be much more oscillatory. Oscillations may be as much as $\pm 50^\circ$ pitch and $\pm 125^\circ$ roll at $100 \pm 30^\circ$ /second yaw rate. Due to the large roll rate and yaw rate oscillations, recovery may be delayed by entry into a Falling Leaf during the final stages of spin recovery. It is extremely important that yaw rate be reduced to near zero in order to promptly recover from the Falling Leaf.

High yaw rate spin characteristics for symmetric and asymmetric store loadings are similar with a few noteworthy exceptions. With lateral asymmetry of 18,000 ft–lbs or more, entry into this spin mode may occur if AOA limits are exceeded. The spin is autorotative, but even with a 18,000 ft–lbs spin, recovery can be obtained in less than two turns. Altitude loss is approximately 1,500 feet per turn. Spin recovery characteristics and capability above 18,000 ft–lbs lateral asymmetry are unknown.

11.2.5.4 Inverted Spin. The F/A–18 is extremely resistant to inverted spin entry. In symmetric store loadings, short duration SRM arrows (approximately 1 spin turn) have been encountered following inadvertent departures, typically from slow speed vertical flight. A steady state inverted spin is highly unlikely and requires full pro–spin controls. However, if a steady state inverted spin is encountered, it exhibits a yaw rate of approximately 30°/second, negative 50° AOA, rate of descent of 21,000 feet/minute, and altitude loss of 3,500 feet/turn. Spin recovery requires approximately one spin turn following application of antispin controls, stick in direction of spin recovery arrow (away from the spin).

11.2.5.5 Spin Recovery. Full lateral stick in the direction of the spin recovery arrow must be applied until spin rotation rate is at or very near zero to minimize inertial pitch coupling and provide maximum nose-down pitching moment for rapid recovery. Spin recovery lateral stick should be smoothly neutralized when spin arrows are removed. Spin rotation should be completely stopped for rapid recovery and to preclude redeparture.

Conditions which indicate recovery from any of the spin modes are:

1. AOA and Yaw rate tones removed.
2. Side forces subsided.
3. Airspeed accelerating above 180 knots.

11.2.5.5.1 Spin Recovery Mode (SRM). Flight characteristics in SRM differ significantly from those of the normal CAS mode. All FCS feedbacks, interconnects, and gain schedules are removed, leaving the FCS in essentially a three axes DEL mode. Because the artificial yaw stability features of CAS are not available in SRM, the directional stability is weak and the nose tends to wander. Because the lateral control surfaces are not washed out with increasing AOA as they are in CAS, lateral stick can generate excessive yaw. The aircraft is very susceptible to nose-slice departure with even small stick deflection. Maintaining AOA less than 20° will significantly reduce the departure potential. An aft CG increases the possibility of entering into a Falling Leaf if departure occurs. However, holding antispin input after yaw rate ceases may result in a redeparture.



To prevent entering a Falling Leaf, do not intentionally operate in the spin recovery mode if the CG is aft of 25 % MAC.

Recovery from any of the upright spin modes with the FCS in CAS is likely due to low yaw rate spin protection logic. This logic feeds antispin commands to the rolling surfaces in response to uncommanded yaw rate. With the FCS in SRM, spin recovery characteristics may be more rapid. The command arrow on the DDI indicates the correct stick position for recovery from either an upright or inverted spin. Antispin controls are as follows: for upright spins, the command arrow directs the pilot to apply full lateral stick with the spin direction (i.e., right upright spin, right lateral stick); for inverted spins, the command arrow directs the pilot to apply full lateral stick opposite the spin direction (i.e., inverted left spin, use right lateral stick). In SRM, application of lateral stick in the direction of the command arrow causes a rapid reduction of yaw rate. After the yaw rate is stopped, forward stick may be required to reduce the AOA below stall.

With the spin recovery switch in NORM, the SRM disengages when the command arrow is removed. The CAS automatically drives the stabilators to full trailing edge down during the final stages of spin recovery. However, it may not be possible to reduce AOA before yaw rate is completely stopped because of inertial pitch coupling, especially with an aft CG. Recovery from the high yaw rate spin mode requires approximately 2½ turns. Intermediate and low yaw rate spin modes require a correspondingly lesser number of turns for recovery. Approximately 12,000 to 14,000 feet may be required for recovery from a fully developed spin (from application of recovery controls to bottom of dive pullout).

11.2.5.5.2 Manual SRM. If the spin switch is used for spin recovery (spin recovery switch to RCVY) the SRM does not automatically disengage with command arrow removal. The switch must be placed

to NORM when yaw rate ceases and before beginning the dive recovery to prevent redeparture. If the switch not returned to NORM, a tendency to overcontrol laterally may be present until airspeed increases above approximately 245 KCAS when the FCS reverts to CAS.

WARNING

With the spin switch in RCVY (SRM engaged), departure susceptibility is greatly increased. A departure during the dive recovery is likely if the spin recovery switch is not returned to NORM. Both the manual and automatic SRM provide spin recovery in less than 1½ turns (full antispin controls) for lateral asymmetry up to 10,000 ft–lbs. However, with lateral asymmetry of 11,500 ft–lbs or more, spin recovery becomes more difficult. At this asymmetry, premature neutralization of controls causes the spin to reestablish itself in the original direction. Antispin controls should be maintained until the yaw rate ceases.

11.2.5.5.3 Spin Recovery Command Arrows. During highly oscillatory post–stall gyrations, spins, or spin recovery, the spin recovery command arrows may temporarily appear. The pilot should not attempt to chase these transient command arrows as this may cause inadvertent application of pro–spin controls and delay recovery. Under these conditions, the controls should be left released until the command arrow is verified steady. If/when the direction of the command arrow becomes steady and the pilot has visually confirmed spin type (upright or inverted) and spin direction, prompt application of full anti–spin lateral stick should then be applied.

MODE	LIKELY ENTRY CONDITION	MODE RECOGNITION	RECOVERY
Falling Leaf	High AOA maneuvering Inverted/nose high Ballistic Aggravated by external stores	In-phase yaw/roll motions which reverse direction every few seconds. Repeated sensations of high side-force accompanied by near zero g alternating on both sides of the cockpit. Reversals in heading and uncommanded AOA excursions from -10° to $+70^{\circ}$.	Maintain controls released.
Low Yaw Rate Spin	Large sustained control inputs at high AOA Maneuvering above AOA limits for lateral weight asymmetries $> 6,000$ ft-lbs	Lack of response to forward stick with AOA maintaining 50° to 60° and low yaw rates (0 to $40^{\circ}/\text{sec}$). This mode is not violent or disorienting.	Stick full with steady arrow, hold until yaw rate ceases.
Intermediate Yaw Rate Spin	Maneuvering above AOA limits for lateral weight asymmetries	Oscillatory in pitch and roll with AOA from 40° to 80° and yaw rates from 20° to $80^{\circ}/\text{sec}$. Cockpit side-forces may reach 1g and motion can be disorienting. May roll while spinning.	Stick full with steady arrow, hold until yaw rate ceases.
High Yaw Rate Spin	Maneuvering above AOA limits for lateral weight asymmetries $> 18,000$ ft-lb	Smooth flat spin motion with AOA from 80° to 90° and yaw rates greater than $100^{\circ}/\text{sec}$. Longitudinal force (eyeballs out) up to 3.5g. May be more oscillatory with external stores.	Stick full with steady arrow, hold until yaw rate ceases.
Inverted Spin	Sustained full pro-spin controls	AOA approximately -50° and yaw rates of approximately $30^{\circ}/\text{sec}$.	Stick full with arrow (away from the spin) hold until yaw rate ceases.

11.3 DEGRADED MODE HANDLING QUALITIES

The reliability of the FCS is very high and when failures do occur, they usually occur singularly. No single electrical failure effects flying qualities and multiple FCS failures are required to degrade flying qualities. Depending on which combination of failures has occurred, flying qualities may be considerably degraded. Degraded flying qualities associated with some of the more serious or more common FCS failures are described here.

11.3.1 Single Engine Operation.

11.3.1.1 AUTO Flaps. Engine failure or shutdown with flaps AUTO results in no degradation in handling qualities under most circumstances at low AOA. A small amount of yaw trim may be required to counter asymmetric thrust effects. At high AOA, engine failure results in a yaw toward the failed engine that is controllable by quickly reducing the AOA and countering the yaw with rudder.

11.3.1.2 HALF or FULL Flap Configuration. Single Engine Minimum Control Speed (V_{mc}) is the airspeed required to maintain controlled flight with only one operating engine. Because the engines are not located on the centerline of the aircraft, if only one engine is operating, the unbalanced force of that engine causes the aircraft to yaw. The rudders are the primary flight control surface that can be used to counter the yaw caused by the operating engine. However, if the aircraft's airspeed becomes too slow, the rudders cannot generate enough control power to oppose the yaw caused by the operating engine. The slowest airspeed at which the rudders can provide enough control power to counter the yaw produced by the operating engine is the single engine minimum control airspeed. As AOA and lateral weight asymmetry increase, the minimum airspeed required to ensure aircraft single engine control also increases. In other words, for a given airspeed and configuration, lateral directional control is ensured if AOA is maintained below a critical level. With flaps HALF, maintaining AOA at or below 12° provides sufficient control in almost all circumstances. In flaps FULL, control can be lost above 10° AOA at light gross weights and large lateral weight asymmetries. In both cases, exceeding the critical AOA results in large bank angle/sideslip excursions and/or inability to arrest yaw/roll rates. A slight reduction in AOA, however, quickly restores controllability with little or no loss of altitude.

11.3.1.3 Single Engine Waveoff. During single engine waveoffs (MIL or MAX) up to full rudder may be required to counter sideslip. Lateral stick may be required to maintain wings level flight, but inputs should be kept under half stick deflection to avoid inducing adverse yaw. Pilots must be careful not to over rotate and reach angles of attack where lateral directional control power is reduced. Loss of lateral and directional control may occur above 12° AOA with flaps HALF and above 10° AOA with flaps FULL.

11.3.2 FCS Degraded Modes (DEL/MECH). The full authority control augmentation system is automatically backed up by the direct electrical link (DEL) flight control mode with a digital system and an analog mode for backup aileron and rudder control. DEL operation results from the lack of reliable feedback data or operation within the FCS. DEL operation will usually only occur in one axis (pitch, roll, or yaw), however yaw DEL will initiate roll DEL. If DEL fails, the mechanical link (MECH) automatically provides roll and pitch control through a direct input from control stick to the stabilator actuators, bypassing the flight control computers and stabilator actuator servo valves. Detailed descriptions of the causes of FCS DEL/MECH modes is contained in Chapter 15.

In digital DEL the trim rates are noticeably slower than in CAS, but should allow neutral trimmed flight throughout the airspeed envelope. Damping of aircraft motion occurs only as a result of natural aircraft stability so the tendency to enter PIOs is increased, especially at high speeds. Rapid control inputs (stick, rudder and throttle) should be avoided as they may aggravate aircraft oscillations. Normal formation flight and refueling operations are possible as long as caution is exercised with in-close corrections to prevent oscillations from developing. In pitch DEL, use of speedbrake should be avoided to prevent moderate longitudinal oscillations, unless required in extreme situations for g control. In roll and yaw DEL the use of rudder is not recommended due to control sensitivity and dutch roll excitation.

WARNING

In pitch DEL there is very little stabilator authority available. Therefore, the g available is extremely limited.

CAUTION

Roll rates are significantly reduced at airspeeds above Mach 0.94 in roll or roll plus yaw DEL and may be as low as 65°/second.

For landing, flying qualities in DEL will be degraded. Consideration should be given to lowering the landing gear and flaps (HALF) with sufficient time to evaluate approach flying qualities. During approach in roll DEL the aircraft is easily excited in roll, resulting in a constant 2 or 3° roll oscillation. There is also no roll limiting, so lateral inputs will produce a noticeable increase in roll rates and roll response that could lead to a lateral PIO if large rapid inputs are used. No more than half lateral stick or rudder pedal is recommended due to excessive sideslip and dutch roll buildup. Excessive sideslip can be generated with maneuvering above on-speed AOA. After a bolter in pitch DEL a large pitch up will occur which can be countered with forward stick.

Mechanical operation (MECH ON) can be the result of FCS failure, complete electrical failure, or as a result of pulling FCC channels 1 and 2 circuit breakers. MECH ON is possible with or without ailerons and rudders operative. If no surface hardover failures occur, reversions into MECH ON are normally characterized by a rapidly increasing aft stick force, stabilized at 3 to 5 pounds for flaps AUTO, and 15 to 25 pounds in the landing configuration, and an increased control sensitivity in the pitch axis. Aft stick force can be trimmed out, but expect stick to move and in the landing configuration very little aft stick authority will remain. The stick force per g gradient is higher than a normal CAS aircraft, but will allow adequate maneuvering performance. Speedbrake use can lead to severe longitudinal PIO. Rapid power changes resulting in trim changes will aggravate the PIO tendency. Lateral stick inputs will couple into the pitch axis as a nose up rotation that can be countered with forward stick. For landing HALF flaps will provide better flying qualities. After a bolter in pitch MECH a large pitch up occurs which can be countered with forward stick. Landing without aileron or rudder operative, approach speeds are much higher than normal at on-speed AOA and nosewheel steering is inoperative.

WARNING

- Reversion to MECH ON has often resulted in large pitch-up or pitch-down transients.
- Resetting the FCS while in MECH may result in large pitch-up or pitch-down transients.

11.3.3 Loss of INS data to FCCs. If INS pitch and roll angles are not available due to INS or MUX bus failures, or if the FCS detects a problem with the INS data, the sideslip rate calculation defaults to a backup that only uses roll and yaw rates. The sideslip calculation defaults to a backup that only uses lateral acceleration. This degraded condition is indicated by the presence of PROC Xs in channels 1 and 3 on the FCS status display. However, in this degraded condition there is no significant

degradation in departure resistance, high AOA flying qualities, or roll performance. Recoveries from spins and zero airspeed departures are similar to recoveries in the non-degraded condition.

11.3.4 Leading Edge Flap Failures. Leading edge flap (LEF) asymmetries can occur when one of the LEF hydraulic drive units (HDU) stalls/fails or the mechanical interconnect between the inboard and outboard LEF surfaces fails. The most common LEF asymmetry results from a weak LEF HDU that stalls (stops moving due to aerodynamic loading) during abrupt longitudinal maneuvers at high airspeed and low altitude. When this happens, a roll-off away from the failing HDU as AOA or g is increased followed by an abrupt roll-off in the opposite direction is typical. Failure detection logic in the v10.7 FCS software is designed to provide advanced warning of a LEF asymmetry; however, during extremely abrupt maneuvers, an HDU stall may not be detected in time to allow the pilot to abandon the maneuver and avoid a large roll transient.

During landing approach, maintaining on-speed or slightly fast approach AOA results in the best flying qualities for any off-schedule symmetric or asymmetric LEF configuration. With a LEF failure and flaps in AUTO, the LEF and TEF symmetric commands will freeze and the differential LEF and TEF commands will continue to be commanded. With the FLAP switch set to HALF or FULL, the failed LEF will remain frozen while the functioning LEF, the TEF and the aileron droop commands will schedule normally. Due to increased buffet levels with flaps FULL, HALF flap landings are recommended with LEF failures. When transitioning from flaps AUTO to HALF, yaw/roll motion may be encountered that can be countered with small lateral stick inputs. Roll-off may also be encountered during AOA/pitch attitude changes.

11.3.5 Trailing Edge Flap Failures. For a trailing edge flap (TEF) failure the TEF surfaces are hydraulically commanded to zero degrees. Dynamic pitch characteristics will be more sensitive due to loss of flap scheduling and roll performance will be degraded. For landing, approach characteristics will be severely degraded. Aileron droop and aileron to stabilator interconnect will not function. For shipboard operations, a divert to field landing may be required due to excessive approach speeds.

11.3.6 Gain Override. While not a failure mode, GAIN ORIDE is prescribed for certain AOA or pitot-static sensor failures to provide better or more predictable handling qualities. With flaps AUTO, selecting GAIN ORIDE results in fixed gains that correspond to Mach 0.70, 35,000 feet and 2° AOA. Longitudinal and lateral response is slightly more sluggish as airspeed is reduced below these values and is slightly more sensitive as airspeed is increased above these values. Regardless, handling qualities remain very good within the 10° AOA and 350 KCAS NATOPS limits for GAIN ORIDE operation. If the airspeed limit is exceeded, self-sustaining pitch oscillations will start and aircraft will become uncontrollable if airspeed is allowed to continue to increase. If the AOA limit is exceeded, departures are likely since the fixed values of the air data and AOA severely reduce departure resistance. Additionally, the aircraft will stall at a higher than normal airspeed due to the fixed position of the LEFs. Be aware that in GAIN ORIDE, no departure warning tone is initiated at either 15° AOA with FLAPS HALF or 12° AOA with FLAPS FULL.

Transition to or from the landing configuration should be done in level flight at 200 KCAS. Transition should not be made while in a bank angle due to the higher than normal aft stick forces required to maintain flight path angle. Sideslip excursions may also occur if flap transition is made in a turn.

With the flaps HALF, GAIN ORIDE results in fixed gains that correspond to 8.1° AOA. Handling qualities are best at these conditions and degrade slightly away from on-speed AOA. Small deviations from 8.1° cause slight handling characteristics degradation, as the aircraft will be less sensitive to

longitudinal inputs. Flight is not recommended above 200 KCAS with flaps HALF due to these characteristics. LEF are fixed at 17° and will not vary with airspeed and AOA. TEFs and aileron droop are fixed at 30°. Aircraft should remain below 15° AOA to avoid unintentional departures.

With the FLAP switch in FULL, aircraft should remain below 160 KCAS and 12° AOA. Do not exceed 15° AOA. Flight at 8.1° AOA results in the best control characteristics. Small deviations from 8.1° cause slight handling characteristics degradation, as the aircraft is less sensitive to longitudinal inputs. LEFs are fixed at 17°, TEFs at 43° to 45° and aileron droop at 42° and will not vary with airspeed or AOA. With the wings unlocked, aileron droop is set to 0°.

WARNING

Bolters in GAIN ORIDE require more aft stick input for rotation due to fixed AOA feedback and zero rudder toe-in deflection. Half aft stick is recommended for rotation from bolters in GAIN ORIDE to reduce aircraft settle.

NOTE

- Alpha tone is disabled in GAIN ORIDE with FLAP switch HALF or FULL.
- Aircraft must be trimmed longitudinally on-speed for approaches with GAIN switch in ORIDE. Without significant aft stick after touchdown, bolters in ORIDE with longitudinal trim set below on-speed AOA will result in settle off the bow.

11.4 CENTER OF GRAVITY (CG)

11.4.1 CG Determination. The aircraft CG in percent mean aerodynamic chord (MAC) is based on aircraft model, external stores, and fuel quantity. Each aircraft has its own unique CG for a clean configuration, i.e., LG down, full internal fuel, engines, crew, empty gun, and avionics including EW equipment when installed (found on Weight and Balance form, DD 365-4). Each lot of aircraft has a Reference CG based on sample aircraft within the lot (figure 11-2). CG Corrections for Configuration/Stores/Ordnance are listed in figure 11-3.

LOT	MODEL	BUNO	CG (% MAC)
4-9	A	161353 THRU 163175	22.0
4-9	B	161354 THRU 163123	21.8
10 -14	C	163427 THRU 164691	21.3
15 & UP	C	164693 & UP	22.3
10 -14	D	163434 THRU 164692	20.9
15 & UP	D	164694 & UP	21.4

Figure 11-2. Reference CG

STORES	CG CHANGE % MAC				
GEAR UP	0.3				
AMMO	LOADED		SPENT		
400 RDS	-1.4		-0.6		
570 RDS	-2.0		-0.9		
AIM-9	(STA 1 or 9) 0.2 EACH				
AIM-7	(STA 4 or 6) 0.5 EACH				
AIM-120	(STA 4 or 6) 0.3 EACH				
TFLIR	0.1				
NFLIR	0.05				
LST/SCAM	0.0				
	STA 2	STA 3	STA 5	STA 7	STA 8
PYLON	0.1	0.1	-0.2	0.1	0.1
MER-7	-0.05	-0.05	-0.2	-0.05	-0.05
VER	-0.05	-0.05	-0.2	-0.05	-0.05
FUEL TANK (EMPTY)	N/A	-0.0	-0.3	-0.0	N/A
1,000 POUNDS (Fuel or	-0.05	-0.1	-1.2	-0.1	-0.05
2,000 POUNDS Stores)	-0.1	-0.2	-2.4	-0.2	-0.1

Figure 11-3. CG Correction For Configuration/Stores/Ordnance

11.4.1.1 CG Worksheet. To determine the Total CG Correction (using figure 11-4 worksheet), subtract the Reference CG (figure 11-2) from the Aircraft Unique CG (DD 365-4), and add the CG correction (figure 11-3); then add the Total CG Correction to the CG point determined by fuel state (figures 11-7 thru 11-13). See figures 11-5 and 11-6 as sample problems. Figures 11-7 thru 11-13 show CG movement relative to a normal fuel burn reference line. Figures 11-14 thru 11-19 are tabular presentations of figures 11-7 thru 11-13.

Aircraft Unique CG (DD 365-4)	_____ % MAC
Reference CG (figure 11-2)	minus _____ % MAC
CG Stores Correction (figure 11-3)	plus _____ % MAC
CG At Fuel State (figures 11-7 thru 11-13, or 11-14 thru 11-19)	plus _____ % MAC
Approximate CG	_____ % MAC

Figure 11-4. CG Worksheet



Failure to utilize “Total CG Correction” as determined in figure 11-4 will result in incorrect CG calculations. Time to recover from a departure is significantly increased when CG is in the aft range where AOA limitations are imposed by configuration.



- The CG or FUEL XFER caution does not indicate when aircraft CG is out of limits.
- The CG or FUEL XFER caution only indicates a failure of the tank 1 and 4 fuel distribution system.

11.4.1.2 Sample Problem CG for F/A-18C Gear Down.

Conditions:

- F/A-18C (Lot 14) on the ground (gear down)
- 10,700 lbs internal fuel
- fuel tank, station 5
- 2,000 lbs fuel, station 5
- AIM-9s on stations 1 and 9
- AIM-7s on stations 4 and 6
- pylons on stations 2, 3, 5, 7, & 8

a. Aircraft DD 365-4 CG		<u>21.5</u> % MAC
b. Reference CG		
C Model		minus <u>21.3</u> % MAC
(Lot 10-14)	= 21.3	
(Lot 15 and UP)	= 22.3	
D Model		
(Lot 10-14)	= 20.9	
(Lot 15 and UP)	= 21.4	
c. CG Correction for Configuration/ Stores/Ordnance		
fuel tank sta 5	-0.3	
2,000 lbs fuel sta 5	-2.4	
AIM-9 sta 1	0.2	
AIM-9 sta 9	0.2	
AIM-7 sta 4	0.5	
AIM-7 sta 6	0.5	
pylon sta 2	0.1	
pylon sta 3	0.1	
pylon sta 5	-0.2	
pylon sta 7	0.1	
pylon sta 8	0.1	
		plus <u>-1.1</u> % MAC
d. Fuel State CG		
10,700 lbs		plus <u>21.5</u> % MAC
e. Current CG (a-b+c+d)		<u>20.6</u> % MAC

Figure 11-5. Sample Problem, CG for a F/A-18C Model, Lot 14 Aircraft, Gear Down

11.4.1.3 Sample Problem CG for F/A-18 C Gear Up.

Conditions:

- F/A-18C (Lot 14) in-flight (gear up)
- 3,000 lbs internal fuel
- fuel tank, station 5
- AIM-9s on stations 1 and 9
- AIM-7s on stations 4 and 6
- pylons on stations 2, 3, 5 , 7, & 8

a. Aircraft DD 365-4 CG		21.5 % MAC
b. Reference CG		
C Model		minus 21.3 % MAC
(Lot 10-14)	= 21.3	
(Lot 15 and UP)	= 22.3	
D Model		
(Lot 10-14)	= 20.9	
(Lot 15 and UP)	= 21.4	
c. CG Correction for Configuration/ Stores/Ordnance		
gear up	0.3	
fuel tank sta 5	-0.3	
AIM-9 sta 1	0.2	
AIM-9 sta 9	0.2	
AIM-7 sta 4	0.5	
AIM-7 sta 6	0.5	
pylon sta 2	0.1	
pylon sta 3	0.1	
pylon sta 5	-0.2	
pylon sta 7	0.1	
pylon sta 8	0.1	
		plus 1.6 % MAC
d. Fuel State CG		
3,000 lbs		plus 24.2 % MAC
e. Current CG (a-b+c+d)		26.0 % MAC

Figure 11-6. Sample Problem, CG for a F/A-18C Model, Lot 14 Aircraft, Gear Up

F/A-18A 161353 THRU 163175 WITH CG CONTROL SYSTEM

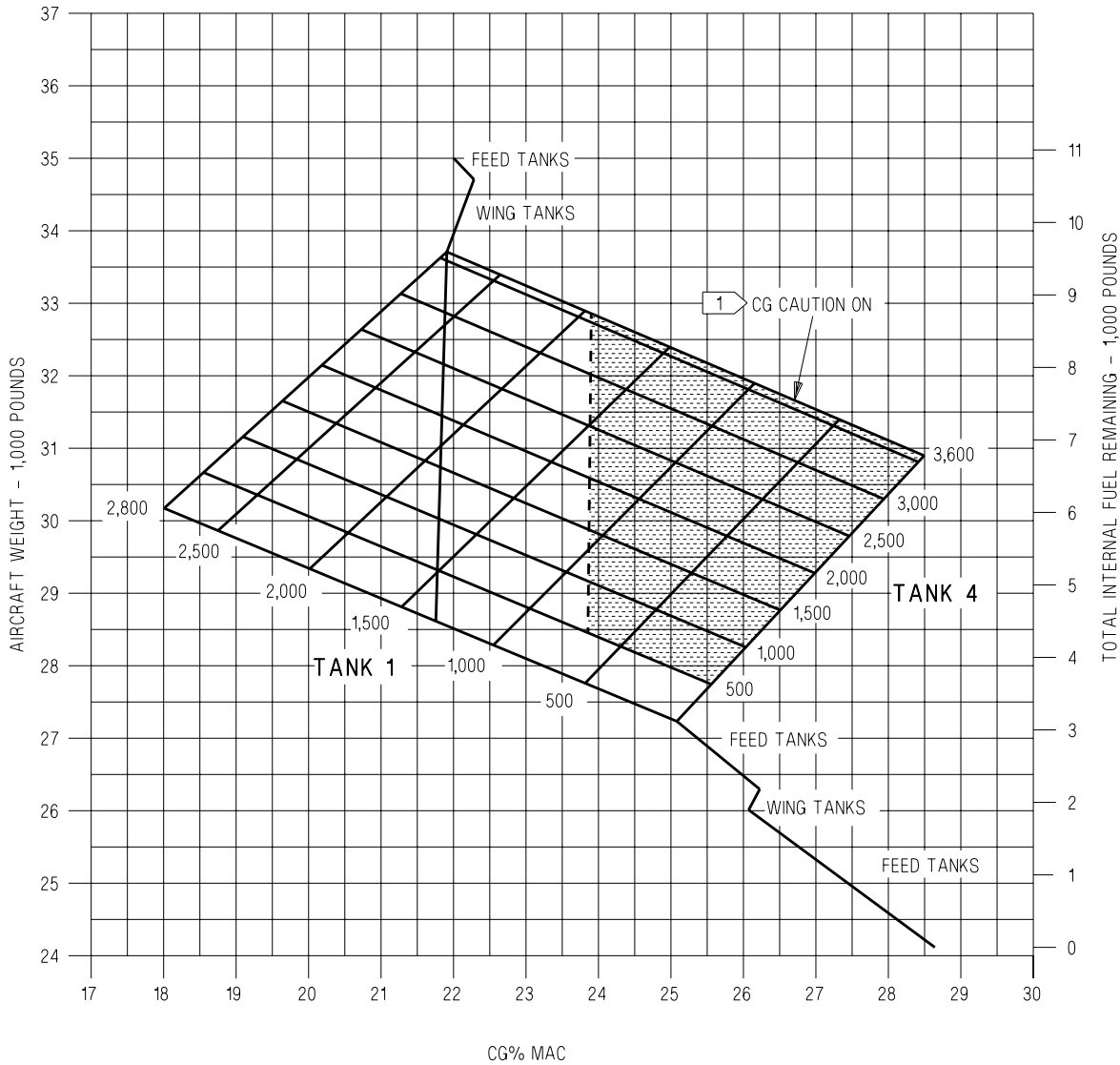

WARNING

FAILURE TO UTILIZE "TOTAL CG CORRECTION" AS DETERMINED IN FIGURE 11-4 WILL RESULT IN INCORRECT CG CALCULATIONS. TIME TO RECOVER FROM A DEPARTURE IS SIGNIFICANTLY INCREASED WHEN CG IS IN THE AFT RANGE WHERE AOA LIMITATIONS ARE IMPOSED BY CONFIGURATION.

NOTES

- GEAR DOWN
- NO STORES
- NO AMMO
- NO EW EQUIPMENT
- ① WITH MC OFF 15C FUEL XFER CAUTION ON

Figure 11-7. CG Travel Due To Fuel Consumption - F/A-18A 161353 THRU 163175 With CG Control System IV-11-25

F/A-18B 161354 THRU 161360 WITHOUT CG CONTROL SYSTEM

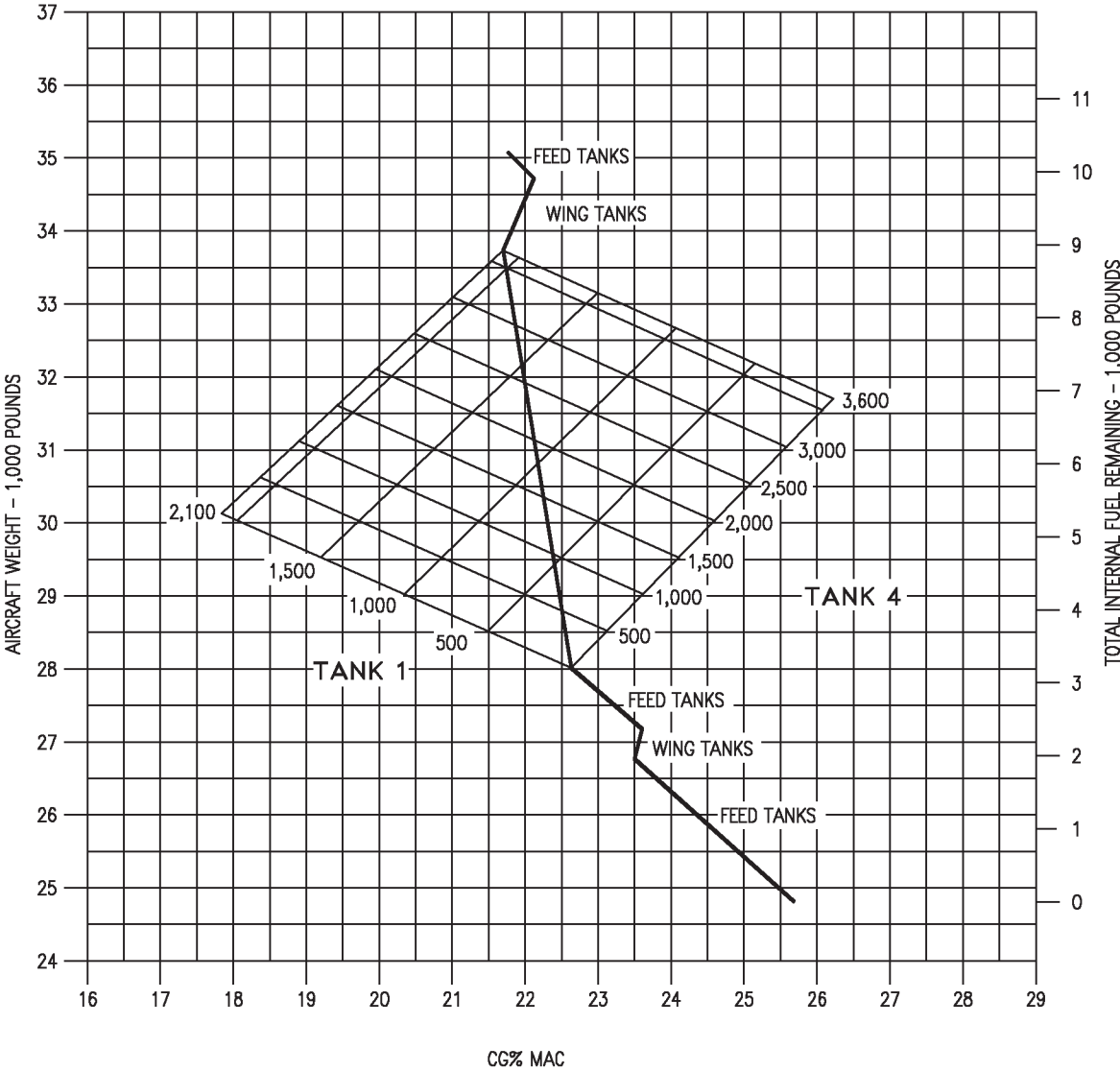

WARNING

FAILURE TO UTILIZE "TOTAL CG CORRECTION" AS DETERMINED IN FIGURE 11-4 WILL RESULT IN INCORRECT CG CALCULATIONS. TIME TO RECOVER FROM A DEPARTURE IS SIGNIFICANTLY INCREASED WHEN CG IS IN THE AFT RANGE WHERE AOA LIMITATIONS ARE IMPOSED BY CONFIGURATION.

NOTE

- GEAR DOWN
- NO STORES
- NO AMMO
- NO EW EQUIPMENT

Figure 11-8. CG Travel Due To Fuel Consumption - F/A-18B 161354 THRU 161360 Without CG Control System

F/A-18B 161704 THRU 163123 WITH CG CONTROL SYSTEM

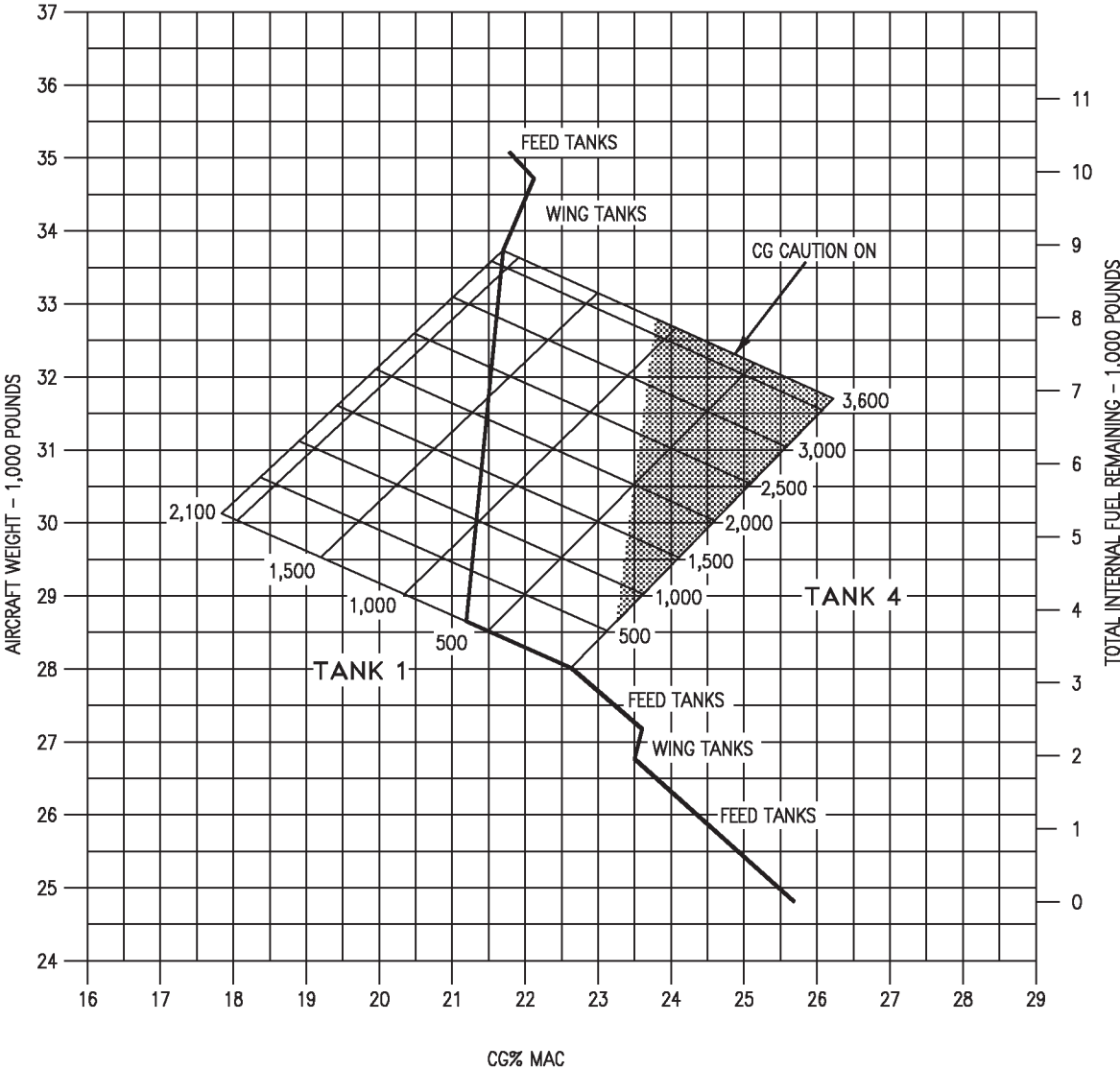

WARNING

FAILURE TO UTILIZE "TOTAL CG CORRECTION" AS DETERMINED IN FIGURE 11-4 WILL RESULT IN INCORRECT CG CALCULATIONS. TIME TO RECOVER FROM A DEPARTURE IS SIGNIFICANTLY INCREASED WHEN CG IS IN THE AFT RANGE WHERE AOA LIMITATIONS ARE IMPOSED BY CONFIGURATION.

NOTE

- GEAR DOWN
- NO STORES
- NO AMMO
- NO EW EQUIPMENT

18AC-NFM-00-(56-1)32-CAT1

Figure 11-9. CG Travel Due To Fuel Consumption - F/A-18B 161704 THRU 163123 With CG Control System

F/A-18C 163427 THRU 164691 (LOTS 10-14)

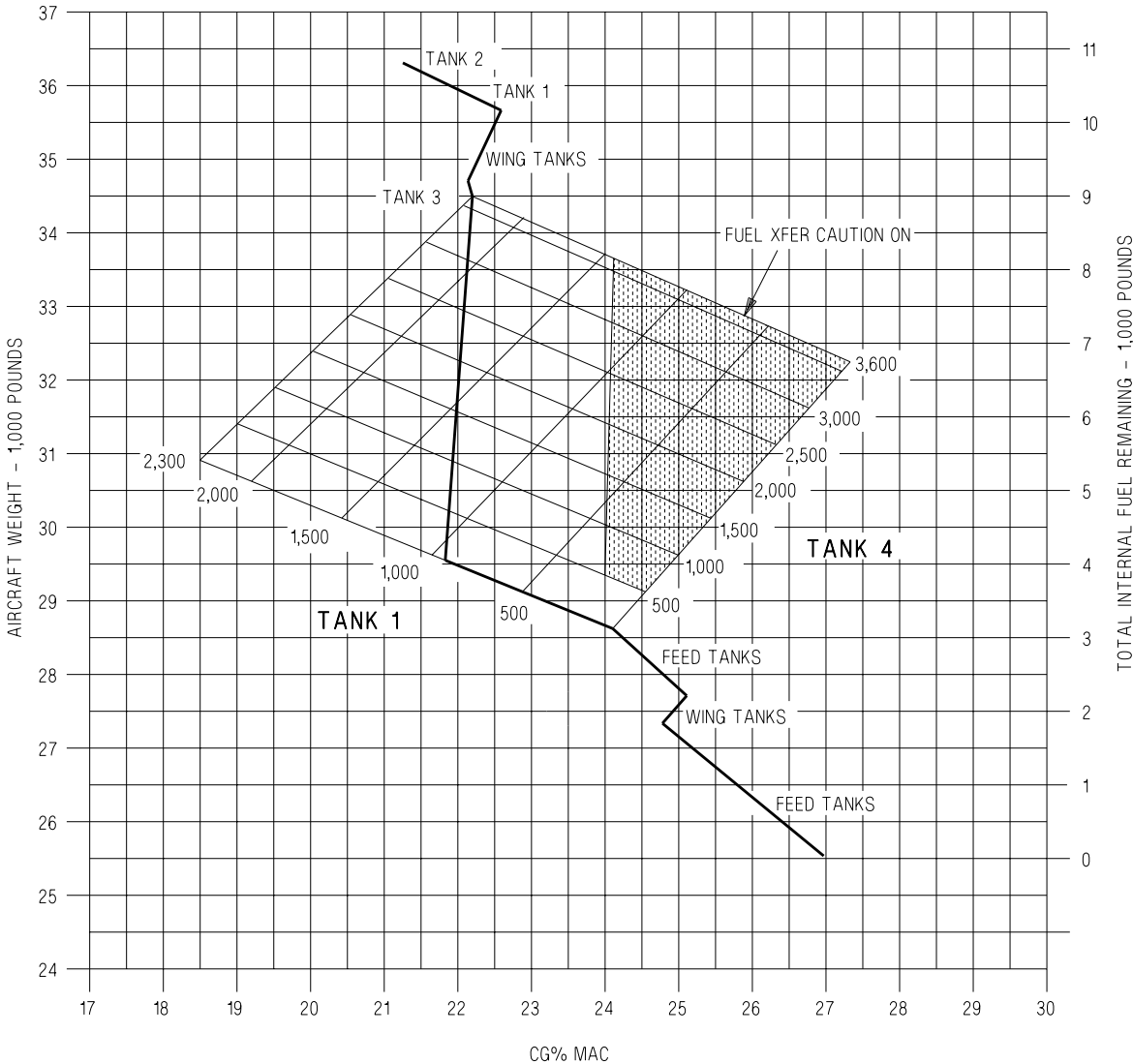

WARNING

FAILURE TO UTILIZE "TOTAL CG CORRECTION" AS DETERMINED IN FIGURE 11-4 WILL RESULT IN INCORRECT CG CALCULATION TIME TO RECOVER FROM A DEPARTURE IS SIGNIFICANTLY INCREASED WHEN CG IS IN THE AFT RANGE WHERE AOA LIMITATIONS ARE IMPOSED BY CONFIGURATION.

NOTES

- GEAR DOWN
- NO STORES
- NO AMMO
- NO EW EQUIPMENT

ADA520-320-1-047

Figure 11-10. CG Travel Due To Fuel Consumption - F/A-18C 163427 THRU 164691

F/A-18C 164693 & UP (LOTS 15 & UP)

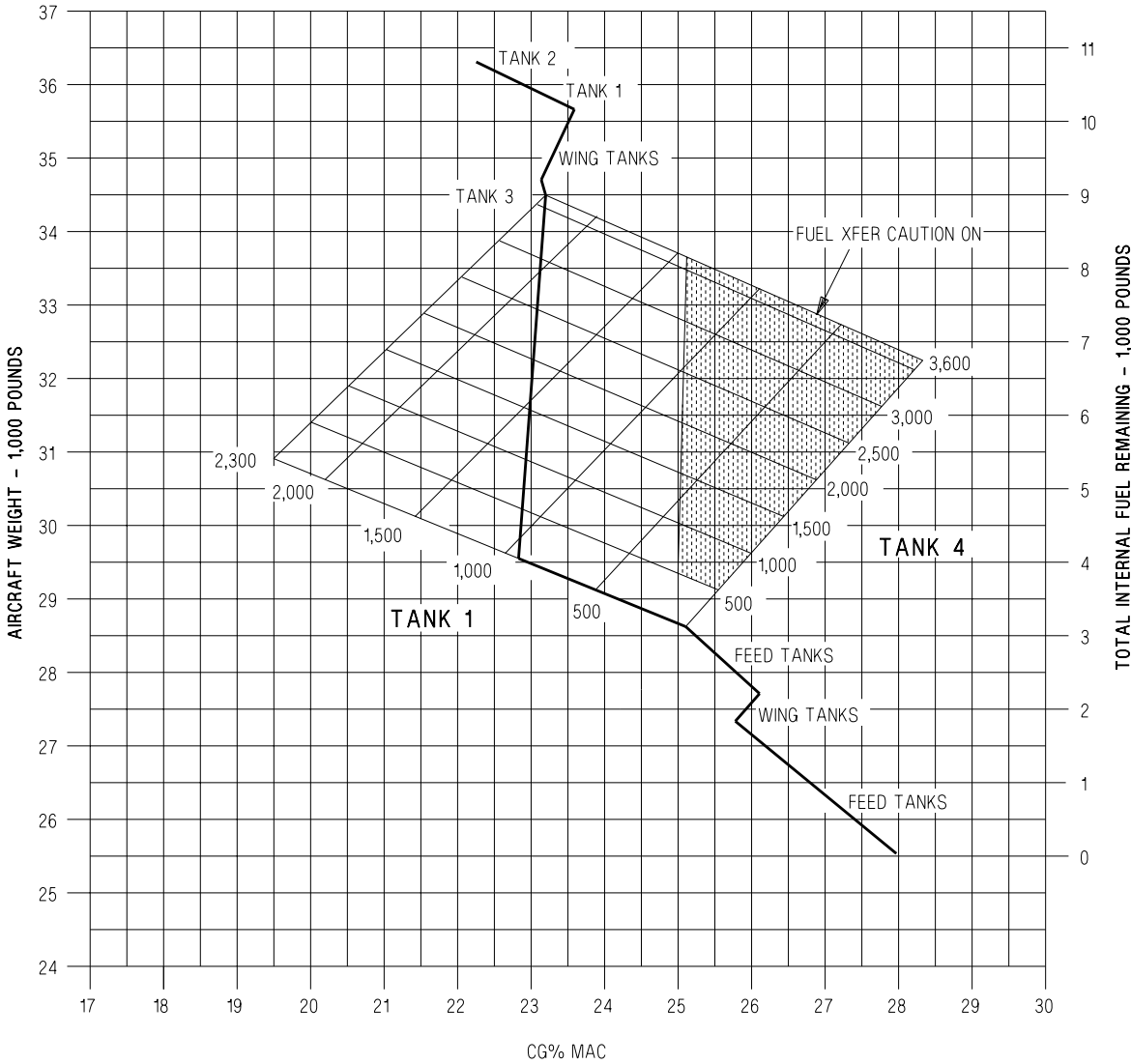

WARNING

FAILURE TO UTILIZE "TOTAL CG CORRECTION" AS DETERMINED IN FIGURE 11-4 WILL RESULT IN INCORRECT CG CALCULATION. TIME TO RECOVER FROM A DEPARTURE IS SIGNIFICANTLY INCREASED WHEN CG IS IN THE AFT RANGE WHERE AOA LIMITATIONS ARE IMPOSED BY CONFIGURATION.

NOTES

- GEAR DOWN
- NO STORES
- NO AMMO
- NO EW EQUIPMENT

ADA520-327-1-047

Figure 11-11. CG Travel Due To Fuel Consumption - F/A-18C 164693 AND UP

F/A-18D 163434 THRU 164692 (LOTS 10-14)

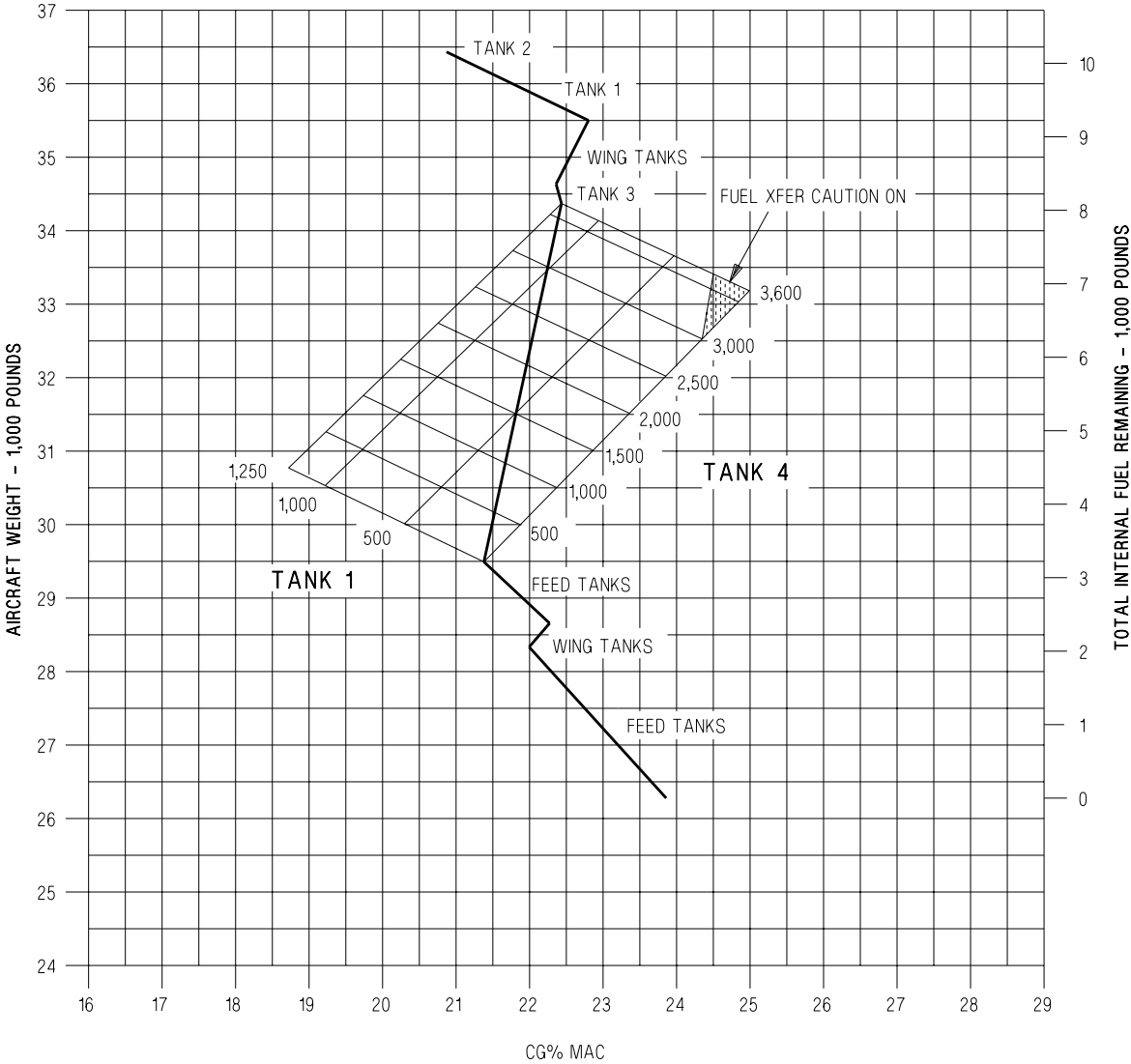

WARNING

FAILURE TO UTILIZE "TOTAL CG CORRECTION" AS DETERMINED IN FIGURE 11-4 WILL RESULT IN INCORRECT CG CALCULATION. TIME TO RECOVER FROM A DEPARTURE IS SIGNIFICANTLY INCREASED WHEN CG IS IN THE AFT RANGE WHERE AOA LIMITATIONS ARE IMPOSED BY CONFIGURATION.

NOTES

- GEAR DOWN
- NO STORES
- NO AMMO
- NO EW EQUIPMENT

ADA520-321-1-047

Figure 11-12. CG Travel Due To Fuel Consumption - F/A-18D 163434 THRU 164692

F/A-18D 164694 AND UP (LOTS 15 & UP)

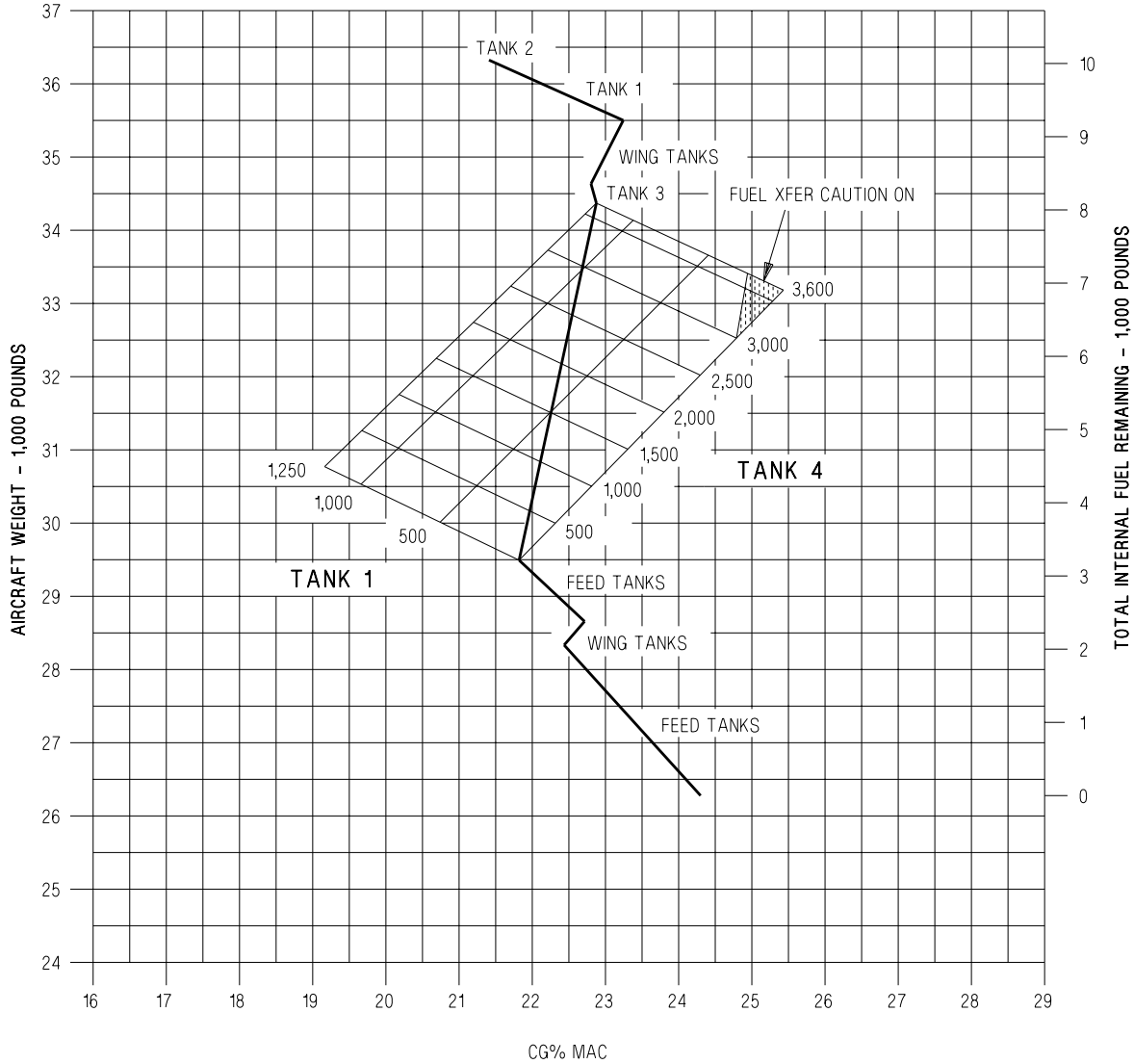

WARNING

FAILURE TO UTILIZE "TOTAL CG CORRECTION" AS DETERMINED IN FIGURE 11-4 WILL RESULT IN INCORRECT CG CALCULATION. TIME TO RECOVER FROM A DEPARTURE IS SIGNIFICANTLY INCREASED WHEN CG IS IN THE AFT RANGE WHERE AOA LIMITATIONS ARE IMPOSED BY CONFIGURATION.

NOTES

- GEAR DOWN
- NO STORES
- NO AMMO
- NO EW EQUIPMENT

ADA520-326-1-047

Figure 11-13. CG Travel Due To Fuel Consumption - F/A-18D 164694 AND UP

F/A-18A									
TANK 1	2,800	18.0	18.5	19.1	19.6	20.2	20.7	21.3	21.9
	2,500	18.7	19.3	19.8	20.3	20.9	21.5	22.0	22.6
	2,000	20.0	20.5	21.1	21.6	21.9	22.7	23.2	23.8
	1,500	21.3	21.8	22.3	22.8	23.3	23.9	24.4	25.0
	1,000	22.6	23.1	23.6	24.1	24.6	25.1	25.6	26.2
	500	23.8	24.3	24.8	25.3	25.6	26.3	26.8	27.2
	0	25.1	25.6	26.1	26.5	27.0	27.5	28.0	28.5
		0	500	1,000	1,500	2,000	2,500	3,000	3,500
TANK 4 (BOLD: 1 CG CAUTION ON)									

1 FUEL XFER CAUTION ON with MC OFP 15C

Figure 11-14. CG vs Tanks 1 & 4 Fuel - F/A-18A

F/A-18B									
TANK 1	2,100	17.8	18.4	19.0	19.5	20.0	20.5	21.1	21.7
	1,500	19.2	19.7	20.2	20.5	21.2	21.8	22.3	23.0
	1,000	20.3	20.8	21.3	21.9	22.4	22.9	23.4	24.0
	500	21.5	22.0	22.5	23.0	23.5	24.0	24.5	25.1
	0	22.6	21.3	23.6	24.1	24.6	25.1	25.6	26.2
		0	500	1,000	1,500	2,000	2,500	3,000	3,500
TANK 4 (BOLD: CG CAUTION ON)									

Figure 11-15. CG vs Tanks 1 & 4 Fuel - F/A-18B

F/A-18C 163427 THRU 164691 (Lots 10-14)										
TANK 1	2,800	Tank 4 Full								21.5
	2,500									22.1
	2,300*									22.5
	2,300	18.5	19.0	19.5	20.0	20.5	21.1	21.6	22.1	22.2
	2,000	19.2	19.7	20.2	20.7	21.2	21.7	22.3	22.8	22.9
	1,500	20.5	20.9	21.4	22.0	22.4	22.9	23.4	23.9	24.0
	1,000	21.6	22.1	22.6	23.0	23.5	24.0	24.5	25.0	25.1
	500	22.9	23.4	23.8	24.2	24.7	25.2	25.6	26.1	26.2
	0	24.1	24.5	25.0	25.4	25.8	26.3	26.7	27.2	27.3
* Internal wing tanks full	0	500	1,000	1,500	2,000	2,500	3,000	3,500	3,600	
TANK 4 (BOLD: FUEL XFER CAUTION ON)										

Figure 11-16. CG vs Tanks 1 & 4 Fuel - F/A-18C 163427 THRU 164691

F/A-18C 164693 AND UP (Lots 15 & UP)										
TANK 1	2,800	Tank 4 Full								22.5
	2,500	Tank 4 Full								23.1
	2,300*	Tank 4 Full								23.5
	2,300	19.5	20.0	20.5	21.0	21.5	22.1	22.6	23.1	23.2
	2,000	20.2	20.7	21.2	21.7	22.2	22.7	23.3	23.8	23.9
	1,500	21.5	21.9	22.4	23.0	23.4	23.9	24.4	24.9	25.0
	1,000	22.6	23.1	23.6	24.0	24.5	25.0	25.5	26.0	26.1
	500	23.9	24.3	24.8	25.2	25.7	26.2	26.6	27.1	27.2
	0	25.1	25.5	26.0	26.4	26.8	27.3	27.7	28.2	28.3
* Internal wing tanks full	0	500	1,000	1,500	2,000	2,500	3,000	3,500	3,600	
TANK 4 (BOLD: FUEL XFER CAUTION ON)										

Figure 11-17. CG vs Tanks 1 & 4 Fuel - F/A-18C 164693 AND UP

F/A-18D 163434 THRU 164692 (Lots 10-14)										
TANK 1	2,100	Tank 4 Full								21.2
	2,000	Tank 4 Full								21.4
	1,500	Tank 4 Full								22.4
	1,254*	Tank 4 Full								22.8
	1,254	18.7	19.2	19.8	20.3	20.8	21.3	21.9	22.4	22.5
	1,000	19.2	19.8	20.3	20.8	21.3	21.8	22.4	22.9	23.0
	500	20.3	20.8	21.3	21.8	22.3	22.9	23.4	23.9	24.0
	0	21.3	21.8	22.3	22.9	23.4	23.9	24.4	24.9	25.0
* Internal wing tanks full	0	500	1,000	1,500	2,000	2,500	3,000	3,500	3,600	
TANK 4 (BOLD: FUEL XFER CAUTION ON)										

Figure 11-18. CG vs Tanks 1 & 4 Fuel - F/A-18D 163434 THRU 164692

F/A-18D 164694 AND UP (Lots 15 & UP)										
TANK 1	2,100	Tank 4 Full								21.7
	2,000	Tank 4 Full								21.9
	1,500	Tank 4 Full								22.9
	1,254*	Tank 4 Full								23.3
	1,254	19.2	19.7	20.3	20.8	21.3	21.8	22.4	22.9	23.0
	1,000	19.7	20.3	20.8	21.3	21.8	22.3	22.9	23.4	23.5
	500	20.8	21.3	21.8	22.3	22.8	23.4	23.9	24.4	24.5
	0	21.8	22.3	22.8	23.4	23.9	24.4	24.9	25.4	25.5
* Internal wing tanks full	0	500	1,000	1,500	2,000	2,500	3,000	3,500	3,600	
TANK 4 (BOLD: FUEL XFER CAUTION ON)										

Figure 11-19. CG vs Tanks 1 & 4 Fuel - F/A-18D 164694 AND UP

PART V

EMERGENCY PROCEDURES

Chapter 12 - General Emergencies

Chapter 13 - Ground Emergencies

Chapter 14 - Takeoff Emergencies

Chapter 15 - Inflight Emergencies

Chapter 16 - Landing Emergencies

Chapter 17 - Ejection

Chapter 18 - Immediate Action

EMERGENCY INDEX

Conference X-ray telephone number (Inflight emergencies only)
314-232-9999 and 866-543-5444

CHAPTERS 12 THRU 17

	Page No.
Abort.....	V-14-2
ADC Failure Effects	V-15-34
Advisory Displays	V-12-50
Afterburner Failure	V-15-1
Aileron Failure/AIL OFF Caution.....	V-15-60
AMAD Caution.....	V-15-26
AMAD PR Caution.....	V-15-26
AOA Probe Damage	V-15-45
APU Restart Envelope.....	V-15-8
Asymmetric Thrust Effects	V-15-4
Auto Flap Landing	V-16-15
Barricade Arrestment.....	V-16-17
Brake Failure/Emergency Brakes	V-13-4
Cockpit Smoke, Fumes, or Fire	V-15-30
Cockpit Temperature High	V-15-29
Controllability Check.....	V-15-63
Crossbleed Restart Envelope	V-15-8
CSC MUX Failure	V-15-19
CV Recovery Matrix	V-16-21
Damaged AOA Probe Procedure	V-15-47
DEL ON Caution	V-15-49
Display Malfunction	V-15-32
Ditching.....	V-17-39
Double Generator Failure	V-15-19
Double Transformer-Rectifier Failure.....	V-15-19
Egress.....	V-13-3
Ejection Sink Rate Effect	V-17-6
Ejection	V-17-1
Emergency Brakes.....	V-13-4
Emergency Catapult Flyaway	V-14-1
Emergency Power Distribution	V-15-22
Emergency Tanker Disengagement	V-15-19
Engine Fails To Respond	V-15-2
Engine Fails To Start/Hung Start	V-13-1
Engine Failure.....	V-15-3
Engine Fire in Flight	V-15-1
Engine Stall.....	V-15-4

Engine Stuck at MIL	V-15-1
External Stores Jettison	V-15-32
External Tank Transfer Failure.....	V-15-17
FCS Failure	V-15-45
FCS Failure Indications and Effects	V-15-34
Feed Tank Transfer Failure	V-15-17
Field Arresting Gear	V-16-16
Field Arrestment	V-16-16
Field Arrestment Gear Data	V-16-17
FLAPS OFF Caution	V-15-57
FLAP SCHED Caution.....	V-15-59
Flight Control Effects Due to Hydraulic Failures	V-15-13
Forced Landing.....	V-16-6
Fuel Transfer Failures	V-15-16
Fuselage Fuel Leak.....	V-15-15
Go Around	V-14-3
Ground Fire	V-13-1
High Altitude Ejection.....	V-17-4
Hook Fails To Extend	V-16-15
Hot Brakes/Brake Fire	V-13-2
Hot Start.....	V-13-1
Hydraulic Failure.....	V-15-9
Hydraulic Flow Diagram.....	V-15-11
Hydraulic Subsystem Malfunction Guide	V-15-12
Hypoxia/Low Mask Flow/No Mask Flow	V-15-27
Immediate Action Items	V-12-1
Inlet Ice Caution	V-12-20
Jammed Controls.....	V-15-60
Landing Gear Emergency Extension	V-16-9
Landing Gear Emergency Flow Chart.....	V-16-12
Landing Gear Fails To Retract	V-14-5
Landing Gear Malfunction-Landing Guide	V-16-13
Landing Gear Unsafe/Fails To Extend.....	V-16-8
Landing With Aft CG	V-16-15
LEF Failed (With Inboard Position Failed Up Beyond 4° Over-Travel Stop)	V-15-58
LEF Failed (With Inboard Position Less Than 4° UP) OR TEF Failed	V-15-59
Loss of Cabin Pressurization.....	V-15-31
Loss of DC Essential Bus.....	V-15-21
Loss of Directional Control During Takeoff or Landing (Blown Tire, NWS Failure)	V-14-3
Loss of Thrust on Takeoff.....	V-14-4
Low Altitude Ejection	V-17-3
MECH ON Caution	V-15-56
MECH ON with AIL and RUD Operative	V-15-56
MECH ON with AIL and RUD Off	V-15-57
Minimum Ejection Altitude	V-17-9
NWS Caution	V-15-60

OBOGS DEGD/Failure	V-15-28
OCF Flight	V-15-60
OCF Recovery	V-15-62
Oxygen Leak	V-15-26
Pitot Static Probe Damage	V-15-48
Planing Link Failure	V-16-6
Power Transmission Shaft Failure	V-15-9
Restart	V-15-5
Seawater Entry	V-17-5
Short Field Arrestment	V-16-16
Single Engine Failure in Landing Configuration	V-16-1
Single Engine Approach and Landing	V-16-2
Single Engine Waveoff/Bolter	V-16-2
Spooldown Restart Envelope	V-15-7
Stuck Throttle/Engine Fails to Respond	V-15-2
Uncommanded Fuel Dump	V-15-18
Uncommanded Pitch and Roll Excursions	V-15-51
Uncommanded Roll Excursion with Aileron Surface Missing/Damaged	V-15-52
Unresponsive Engine	V-15-1
Windmill Restart Envelope	V-15-7
WOW System Failure	V-14-7

WARN/CAUT/FCS/HYD/ADVIS

Warn/Caut/FCS/Hyd/Advis	Page No	Warn/Caut/FCS/Hyd/Advis	Page No
AHMD	V-12-50	GUN GAS	V-12-19
AIL OFF	V-12-27	HIAOA	V-12-52
AIR DATA	V-12-7	HMD	V-12-52
ALGN Xd	V-12-50	HOME FUEL.....	V-12-19
AMAD L/R	V-12-7	HOOK	V-12-5
AMAD & PR L/R	V-12-7	HYD 1A	V-12-34
ANTI SKID	V-12-8	HYD 1B	V-12-34
AOA DEGD	V-12-8	HYD 2A	V-12-35
APU ACCUM	V-12-8	HYD 2B	V-12-36
APU FIRE	V-12-3	HYD 1A/1B	V-12-36
ASPJ DEGD	V-12-8	HYD 1A/2A	V-12-37
ATARS OVRHT.....	V-12-9	HYD 1A/2B	V-12-38
ATS L/R	V-12-9	HYD 1B/2A	V-12-39
AUTO PILOT	V-12-10	HYD 1B/2B	V-12-40
AV AIR DGD	V-12-10	HYD 2A/2B	V-12-41
AV AIR HOT	V-12-10	HYD 1A/1B/2A	V-12-42
BATT LO (E&U).....	V-12-10	HYD 1A/1B/2B	V-12-44
BATT SW	V-12-10	HYD 1A/2A/2B	V-12-46
BINGO	V-12-11	HYD 1B/2A/2B	V-12-48
BIT	V-12-50	IFF OVRHT	V-12-19
BLD OFF L/R	V-12-11	INLET ICE	V-12-20
BLEED Dual	V-12-3	IN TEMP L/R	V-12-19
BLEED Single	V-12-4	INS ATT	V-12-21
BOOST LO L/R	V-12-12	INS DEGD	V-12-21
BRK ACCUM	V-12-12	INS VEL	V-12-21
CABIN	V-12-12	L BAR	V-12-6
CANOPY	V-12-13	L DEGD	V-12-53
CAUT DEGD	V-12-13	LADDER	V-12-21
CG	V-12-13	LEFT	V-12-53
CHECK SEAT	V-12-13	LOADX	V-12-53
CHECK TRIM	V-12-13	MC 1	V-12-21
CK ECS	V-12-13	MC 2	V-12-21
CK FLAPS	V-12-13	MC CONFIG	V-12-21
CNI	V-12-13	MECH ON	V-12-31
DECM	V-12-51	MIDS	V-12-53
DEL ON	V-12-27	MNTCD	V-12-53
DFIRS GONE.....	V-12-13	MSNCD	V-12-53
DISCH	V-12-51	MU LOAD	V-12-22
DL OVRHT	V-12-14	NAV FAIL	V-12-22
DTR 1/2 COLD	V-12-14	NAV HVEL	V-12-22
DTR 1/2 SHTDN	V-12-14	NAV VVEL	V-12-22
DUCT DR L/R.....	V-12-14	NFLR OVRHT.....	V-12-22
DUMP OPEN	V-12-14	NWS	V-12-32
EGT HIGH L/R	V-12-15	OBOGS DEGD	V-12-23
ENG MATCH.....	V-12-15	OCS	V-12-23
EXT TANK	V-12-15	OIL PR L/R.....	V-12-23
EXT XFER	V-12-16	OVRSPD L/R	V-12-23
FC AIR DATA	V-12-28	OXY LOW	V-12-23
FCES	V-12-29	PARK BRAKE	V-12-24
FCS.....	V-12-29	PITOT HT L/R	V-12-24
FCS HOT	V-12-29	POS/ADC	V-12-24
FIRE	V-12-4	PROBE UNLK	V-12-24
FLAMEOUT L/R	V-12-16	RACK UNCPL	V-12-24
FLAP SCHED	V-12-31	RADAR ALT LOW	V-12-6
FLAPS OFF	V-12-30	RC DL	V-12-54
FLIR OVRHT	V-12-17	RIGHT	V-12-54
F-QTY	V-12-51	R-LIM OFF	V-12-24
FUEL	V-12-51	RUD OFF	V-12-33
FUEL HOT L/R	V-12-17	S/W CONFIG	V-12-24
FUEL LO	V-12-17	STALL L/R	V-12-25
FUEL XFER	V-12-17	TANK PRES	V-12-25
GEAR HANDLE	V-12-5	TK PRES LO/HI	V-12-25
GEN L/R	V-12-17	VOICE/AUR	V-12-25
GEN TIE	V-12-18	WDSHLD HOT	V-12-26
G-LIM 7.5	V-12-18	WING UNLK	V-12-26
G-LIM OVRD	V-12-18	Y CODE	V-12-54

CHAPTER 12

General Emergencies

12.1 GENERAL

Part V contains procedures to correct an abnormal or emergency condition. While these procedures provide guidance in dealing with an emergency; they should be modified, as required, in case of multiple/combined emergencies, adverse weather, or other peculiar factors. Use common sense and sound judgment to determine the correct course of action.

Unless specifically stated in NATOPS, BLIN or MSP codes shall not be used for in-flight decision making.

Apply the following rules to all emergencies:

1. Aviate: first and foremost, maintain aircraft control.
2. Analyze the situation and take proper action. Perform immediate action procedures without delay; however, initially do only those steps required to manage the problem. When operating a control, be prepared to immediately return the control to its former setting if an undesirable response occurs.
3. Navigate: land as soon as practical, unless the situation dictates otherwise.
4. Communicate: As soon as possible, notify the flight lead, ship, ATC (air traffic control), or tower of the emergency, aircraft position, and intended course of action. Relay emergency indications, actions taken, flight conditions, power setting, etc., as time permits.

12.1.1 Immediate Action Items. Procedural steps preceded by an asterisk (*) are considered immediate action items. Pilots shall be able to accomplish these steps without reference to the Pocket Checklist (PCL).

12.1.2 Warnings, Cautions, and Advisories. Warnings, cautions, and advisories are displayed in the cockpit on the LDDI, on the upper warning/caution/advisory lights panels, or on the lower right caution lights panel. Certain cautions provide two indications: one on the LDDI and one on the lower right caution lights panel.

Warnings, cautions, and advisories are categorized and are listed alphabetically by category in figure 12-1 together with cause, remarks, and corrective action. Potential cause(s) for the associated warning/caution/advisory is indicated by a bullet (•) under the Cause/Remarks column. The categories are as follows:

- a. Warning Lights.
- b. DDI Cautions and Caution Lights not associated with FCES or HYD cautions.
- c. Flight Control Electronic System (FCES) Cautions.
- d. Hydraulic System (HYD) Cautions.
- e. DDI Advisories.
- f. Advisory Lights.
- g. CFIT Voice Warnings

DDI cautions and advisories are listed in CAPS. Warning, caution, and advisory lights are distinguished by a box around the legend (e.g.,).

Where appropriate, voice aural warnings are listed in quotation marks with their respective warning or caution. If a DDI caution or caution light starts with a single letter (for example L, R, P, or Y) that letter is not used to place the caution alphabetically.

*Immediate action item
 ☆ Discussion in part V

Warning Lights

INDICATOR	CAUSE/REMARKS	CORRECTIVE ACTION
<p>APU FIRE</p> <p>Warning Light</p> <p>“APU Fire, APU Fire”</p>	<ul style="list-style-type: none"> • Fire/overheat condition detected in the APU bay. <p>APU FIRE extinguishing system operates automatically with WonW and must be manually activated with WoffW. System activation secures fuel to the APU, arms the fire bottle, and discharges the bottle after a 10 second delay. Discharge is delayed to allow the APU time to spool down before extinguishing agent is introduced.</p> <p style="text-align: center;">WARNING</p> <p>Since the fire extinguishing system requires 28 vdc essential bus power, the fire bottle may not be discharged if the BATT switch is turned OFF during the 10 second delay time.</p>	<p>IN FLIGHT or ON GROUND</p> <ul style="list-style-type: none"> *1. APU FIRE light - PUSH *2. FIRE EXTGH READY light - PUSH <p>GROUND</p> <ul style="list-style-type: none"> *3. Throttles - OFF 4. Egress.
<p>DUAL</p> <p>L BLEED</p> <p>and</p> <p>R BLEED</p> <p>Warning Lights (of any duration)</p> <p>“Bleed Air Left (Right), Bleed Air Left (Right)”</p>	<ul style="list-style-type: none"> • Bleed air leak or fire detected in common ducting AND the overheat condition still exists (e.g., automatic BALD shutdown did not secure the leak). <p>Bleed air leak MSP code: 831</p> <p>BLD OFF cautions indicate that the corresponding primary bleed air shutoff valve has been commanded closed and are not an indication of actual valve position. Valve(s) could still be open allowing bleed air to leak.</p> <p>If both BLEED warning lights remain on, the potential for fire exists. Consider a HALF flap approach in preparation for a possible single engine landing if practical.</p> <p>If hook release cable is damaged by a bleed air leak or fire, it may be impossible to lower the hook.</p> <p style="text-align: center;">WARNING</p> <ul style="list-style-type: none"> • Under less than optimal conditions (low altitude, heavy breathing, loose fitting mask, etc.), as few as 3 minutes of emergency oxygen may be available. • If both bleeds secured - <ul style="list-style-type: none"> - No OBOGS - No ECS or cabin pressurization - No anti-g protection - No external fuel transfer - No crossbleed start - No throttle boost - No windshield anti-ice/rain removal - May get AV AIR HOT during approach - To prevent canopy fogging, select OFF/RAM or RAM/DUMP and move the DEFOG handle to HIGH 	<p>GROUND</p> <ul style="list-style-type: none"> 1. Throttles - OFF <p>IN FLIGHT</p> <ul style="list-style-type: none"> *1. Throttles - Minimum practical <p>OBOGS Aircraft -</p> <ul style="list-style-type: none"> *2. Emergency oxygen green ring(s) - PULL <p>All Aircraft -</p> <ul style="list-style-type: none"> *3. BLEED AIR knob - OFF (DO NOT CYCLE) *4. Initiate rapid descent to below 10,000 feet cabin altitude. <p>If dual BLEED warning lights go out, execute DUAL BLD OFF caution procedure.</p> <p>If lights remain on -</p> <ul style="list-style-type: none"> 5. Land as soon as possible. 6. Airspeed - Maintain below 325 KCAS (300 to 325 KCAS optimum) 7. ECS MODE switch - OFF/RAM 8. AV COOL switch - EMERG 9. CABIN PRESS switch - RAM/DUMP 10. HOOK handle - DOWN 11. EXT TANKS switch(es) - STOP <p>OBOGS Aircraft -</p> <ul style="list-style-type: none"> 12. OXY FLOW knob(s) - OFF 13. OBOGS control switch - OFF 14. Maintain altitude below 10,000 feet MSL prior to emergency oxygen depletion (10 to 20 minutes). 15. Consider removing mask and resetting emergency oxygen system once below 10,000 feet MSL. <p>If AV AIR HOT caution appears -</p> <ul style="list-style-type: none"> 16. Non-essential avionics equipment - OFF (e.g., RADAR, UFC controlled avionics, ECM, sensors, MC2)

Figure 12-1. Warning/Caution/Advisory Displays (Sheet 1 of 52)

*Immediate action item
 ☆ Discussion in part V

Warning Lights

INDICATOR	CAUSE/REMARKS	CORRECTIVE ACTION
<p>SINGLE</p> <p>L BLEED</p> <p>or</p> <p>R BLEED</p> <p>Warning Light (of any duration)</p> <p>"Bleed Air Left (Right), Bleed Air Left (Right)"</p>	<p>• Bleed air leak or fire detected on designated side AND the overheat condition still exists (e.g., automatic BALD shutdown did not secure the leak).</p> <p>Bleed air leak MSP code: 831</p> <p>BLD OFF cautions indicate that the corresponding primary bleed air shutoff valve has been commanded closed and are not an indication of actual valve position. Valve(s) could still be open allowing bleed air to leak.</p> <p style="text-align: center;">WARNING</p> <p>• Under less than optimal conditions (low altitude, heavy breathing, loose fitting mask, etc.), as few as 3 minutes of emergency oxygen may be available.</p> <p>• If both bleeds secured -</p> <ul style="list-style-type: none"> - No OBOGS - No ECS or cabin pressurization - No anti-g protection - No external fuel transfer - No crossbleed start - No throttle boost - No windshield anti-ice/rain removal - May get AV AIR HOT during approach - To prevent canopy fogging, select OFF/RAM or RAM/DUMP and move the DEFOG handle to HIGH 	<p>GROUND</p> <p>1. Throttles - OFF</p> <p>IN FLIGHT</p> <p>*1. Throttle affected engine - IDLE *2. BLEED AIR knob - L OFF or R OFF (DO NOT CYCLE)</p> <p>If light goes out, execute SINGLE BLD OFF caution procedure.</p> <p>If light still on, do the following in order until light goes out -</p> <p>*3. Throttle affected engine - OFF</p> <p>OBOGS Aircraft -</p> <p>*4. Emergency oxygen green ring(s) - PULL</p> <p>All Aircraft -</p> <p>*5. BLEED AIR knob - OFF (DO NOT CYCLE) *6. Initiate rapid descent to below 10,000 feet cabin altitude. 7. Land as soon as possible.</p> <p>If both bleeds secured -</p> <ol style="list-style-type: none"> 1. Airspeed - Maintain below 325 KCAS (300 to 325 KCAS optimum) 2. ECS MODE switch - OFF/RAM 3. AV COOL switch - EMERG 4. CABIN PRESS switch - RAM/DUMP 5. EXT TANKS switch(es) - STOP <p>OBOGS Aircraft -</p> <ol style="list-style-type: none"> 6. OXY FLOW knob(s) - OFF 7. OBOGS control switch - OFF 8. Maintain altitude below 10,000 feet MSL prior to emergency oxygen depletion (10 to 20 minutes). Consider removing mask and resetting emergency oxygen system once below 10,000 feet MSL. <p>If AV AIR HOT caution appears -</p> <ol style="list-style-type: none"> 10. Non-essential avionics equipment - OFF (e.g., RADAR, UFC controlled avionics, ECM, sensors, MC2)
<p>FIRE</p> <p>Warning Light</p> <p>"Engine Fire Left (Right), Engine Fire Left (Right)"</p>	<p>• Fire/overheat condition detected in corresponding engine/AMAD bay.</p> <p>☆ Refer to Engine Fire On Ground or Engine Fire In Flight.</p> <p style="text-align: center;">WARNING</p> <p>The probability of extinguishing a fire and preventing relights is greatly increased by immediately discharging the fire extinguisher.</p>	<p>GROUND</p> <p>*1. Throttles - OFF *2. FIRE light affected engine - PUSH *3. FIRE EXTGH READY light - PUSH 4. BATT switch - OFF 5. Egress.</p> <p>IN FLIGHT</p> <p>Dual FIRE lights -</p> <p>*1. Throttles - Minimum practical</p> <p>Single FIRE light or Dual when side confirmed -</p> <p>*2. Throttle affected engine - OFF *3. FIRE light affected engine - PUSH *4. FIRE EXTGH READY light - PUSH *5. HOOK handle - DOWN 6. Land as soon as possible.</p> <p>If F/A-18A/B and if external fuel transfer desired -</p> <ol style="list-style-type: none"> 7. HOOK circuit breaker - PULL 8. HOOK handle - UP

Figure 12-1. Warning/Caution/Advisory Displays (Sheet 2)

*Immediate action item
 ☆ Discussion in part V

Warning Lights

INDICATOR	CAUSE/REMARKS	CORRECTIVE ACTION
<p style="text-align: center;">HOOK</p> <p>Warning Light</p>	<ul style="list-style-type: none"> • Arresting hook position does not agree with HOOK handle position. • Hook not fully extended with the HOOK handle down in flight. • Hook down with WonW. <p>If the mechanical hook uplatch mechanism fails, the hook cannot be released and an arrested landing is not possible. If the hook is unlocked (HOOK handle down) but fails to leave the up position, an arresting hook system failure may be applying HYD 2B pressure to hold the hook up. For this reason, pulling the HOOK circuit breaker deenergizes the hook selector valve and ensures HYD 2B pressure is removed.</p> <p>If the arresting hook snubber is not properly charged, the arresting hook may not fully extend due to airloads and HYD 2B back-pressure. In this case, if reducing airspeed does not extinguish the HOOK light, shutting down the right engine reduces HYD 2B back-pressure and should increase arresting hook extension. After engine restart, the hook may retract at a maximum rate of 2° minute. If the HOOK light remains on after this procedure and a visual inspection confirms that the hook is partially extended, a successful arrestment is possible due to g-loads at landing.</p>	<p>IN FLIGHT</p> <ol style="list-style-type: none"> 1. Reduce airspeed. <p>If HOOK light remains on -</p> <ol style="list-style-type: none"> 2. Get a visual inspection (if practical). <p>If the hook is in the up position -</p> <ol style="list-style-type: none"> 2. HOOK circuit breaker - PULL <p>If the HOOK light remains and the hook is partially extended -</p> <ol style="list-style-type: none"> 3. Throttle right engine - IDLE for one minute then OFF 4. Reduce airspeed to drop HYD2 pressure to zero (if practical). 5. Restart for landing. <p>If hook still fails to extend (CV landing) -</p> <ol style="list-style-type: none"> 6. Divert. <p>If the hook is partially extended -</p> <ol style="list-style-type: none"> 7. Attempt a normal carrier landing.
<p>Landing Gear Warning Light</p> <p>(Light in LDG GEAR Handle)</p>	<p>STEADY</p> <ul style="list-style-type: none"> • Landing gear in transit. • Landing gear unsafe. • Planing link failure. <p>-----</p> <p>FLASHING</p> <ul style="list-style-type: none"> • Wheels warning (less than 7,500 feet, less than 175 KCAS, and over 250 fpm descent rate). • Loss of air data. 	<p>STEADY</p> <ol style="list-style-type: none"> 1. Check gear down indications. 2. Refer to appropriate emergency procedures. <ul style="list-style-type: none"> • LDG Gear Fails to Retract • LDG Gear Unsafe/ Fails to Extend • Planing Link Failure <p>-----</p> <p>FLASHING (Wheels Warning)</p> <ol style="list-style-type: none"> 1. LDG GEAR handle - DN or increase airspeed and/or altitude.

Figure 12-1. Warning/Caution/Advisory Displays (Sheet 3)

*Immediate action item
 ☆ Discussion in part V

Warning Lights

INDICATOR	CAUSE/REMARKS	CORRECTIVE ACTION
<p>RED L BAR Warning Light</p>	<p>ON DECK</p> <ul style="list-style-type: none"> Launch bar control system malfunction (proximity switch failure). If launch bar is down, NWS will disengage. <p>IN FLIGHT</p> <ul style="list-style-type: none"> Launch bar failed to retract after catapult launch (Launch bar not up and locked AND weight off the left main gear). Launch bar control system malfunction (proximity switch failure). With the launch bar down, to engage NWS low gain, push and hold NWS button. <p>If the red L BAR light remains on, assume that the launch bar is NOT up and locked and that it may drop to the deck during landing. The nose landing gear cannot be retracted. Placing the LDG GEAR handle UP raises the main landing gear and leaves the nose landing gear extended.</p>	<p>ON DECK</p> <ol style="list-style-type: none"> Suspend catapult launch. LAUNCH BAR switch - RETRACT <p>If launch bar fails to retract -</p> <ol style="list-style-type: none"> LB circuit breaker - PULL <p>IN FLIGHT</p> <ol style="list-style-type: none"> LDG GEAR handle - LEAVE DN (if practical) LAUNCH BAR switch - VERIFY RETRACT LB circuit breaker - PULL <p>Carrier -</p> <ol style="list-style-type: none"> Divert or remove cross deck pendants 1 and 4 (1 and 3 as appropriate) and make a normal landing. Refer to Landing Gear Malfunction Landing Guide. <p>Ashore -</p> <ol style="list-style-type: none"> Remove arresting wires and make a normal landing. Refer to Landing Gear Malfunction Landing Guide.
<p>RADAR ALT LOW LIGHT</p>	<ul style="list-style-type: none"> Aircraft is below the primary low altitude warning (LAW) setting. 	<ol style="list-style-type: none"> Climb above primary RALT setting or reset LAW setting to a lower altitude.
<p>THREAT WARNINGS</p>	<p>Refer to NTRP 3-22.2-FA18A-D (classified NATIP volume).</p>	
<p>UNSAFE (rear cockpit)</p>	<ul style="list-style-type: none"> Landing gear in transit. 	<p>Information</p>

Figure 12-1. Warning/Caution/Advisory Displays (Sheet 4)

* Immediate action item
 ☆ Discussion in part V

DDI Cautions and Caution Lights

INDICATOR	CAUSE/REMARKS	CORRECTIVE ACTION
AIR DATA	<ul style="list-style-type: none"> MC cannot determine which source error correction (SEC) to command or ADC SEC disagrees with MC commanded SEC. 	<p>GROUND</p> <ol style="list-style-type: none"> Do not takeoff. <p>IN FLIGHT</p> <ol style="list-style-type: none"> Maintain subsonic airspeed. Land as soon as practical.
L AMAD R AMAD	<ul style="list-style-type: none"> Designated AMAD oil temperature high. May indicate a fuselage fuel leak. May be caused by an over-serviced AMAD, AMAD heat exchange failure, hot fuel recirculation system failure or motive flow system failure. Low altitude flight on a hot day with less than 4,000 pounds fuel may cause an AMAD caution. A climb to cooler air may reduce AMAD oil temperature. An empty feed tank or BOOST LO caution will cause loss of AMAD cooling. Continued operation with an AMAD caution may cause loss of the associated generator. <p>During ground operation after flight, an AMAD caution may occur due to the lack of ram air cooling and low fuel state. Below 1,000 pounds fuel remaining and above 30°C, an AMAD caution will appear almost immediately. Above 3,000 pounds of fuel remaining and below 30°C, an AMAD caution should not occur. Between these conditions, the time before an AMAD caution will appear is a function of fuel state and ambient temperature (15 minutes at 24°C and 2,000 pounds fuel). Lower fuel quantities and higher ambient temperatures will reduce the time before an AMAD caution will appear. Shutting down an engine (left engine shutdown preferred) will extend the ground operating time. If the AMAD caution appears, shut down the associated engine.</p> <div style="text-align: center; border: 2px solid black; padding: 5px; width: fit-content; margin: 10px auto;">WARNING</div> <p>Prolonged operation of a hot AMAD may result in an engine/AMAD bay fire.</p>	<p>IN FLIGHT</p> <ol style="list-style-type: none"> Throttle affected engine - IDLE INTR WING switch - NORM <p>If accompanied by BOOST LO caution or GEN caution and more than 5 minutes to landing -</p> <ol style="list-style-type: none"> Throttle affected engine - OFF <p>If more than 5 minutes to landing and no accompanied cautions -</p> <ol style="list-style-type: none"> Throttle affected engine - OFF (if practical) <p>In both cases -</p> <ol style="list-style-type: none"> Restart for landing (if required). Land as soon as practical. <p>GROUND</p> <ol style="list-style-type: none"> Throttle affected engine - OFF (when practical)
L AMAD PR R AMAD PR	<ul style="list-style-type: none"> Loss of designated AMAD oil pressure. <p>Securing the GEN (ac output) greatly reduces the heat load imparted to the AMAD oil and may prevent heat-related damage to the generator.</p> <div style="text-align: center; border: 2px solid black; padding: 5px; width: fit-content; margin: 10px auto;">WARNING</div> <p>A L/R AMAD PR caution could be an indication of an AMAD oil leak which may result in an engine /AMAD bay fire.</p>	<ol style="list-style-type: none"> GEN switch affected engine - OFF <p>If more than 5 minutes to landing -</p> <ol style="list-style-type: none"> Throttle affected engine - OFF Consider restart for landing. Land as soon as practical. <p>If restarting affected engine for landing -</p> <ol style="list-style-type: none"> GEN switch affected engine - ON Affected engine - Restart <p>After engine restarted -</p> <ol style="list-style-type: none"> GEN switch affected engine - OFF

Figure 12-1. Warning/Caution/Advisory Displays (Sheet 5)

* Immediate action item
 ☆ Discussion in part V

DDI Cautions and Caution Lights

INDICATOR	CAUSE/REMARKS	CORRECTIVE ACTION
ANTI SKID	<ul style="list-style-type: none"> • Anti-skid system failed BIT. Anti-skid protection not available for use with normal braking. <div style="text-align: center; border: 1px solid black; padding: 5px; width: fit-content; margin: 10px auto;">WARNING</div> <ul style="list-style-type: none"> • Use of brakes without anti-skid at high speed can result in blown tires resulting in loss of directional control. If practical, rollout speed should be as slow as possible before applying brake pedal pressure. • Do not cycle the ANTI SKID switch in response to an ANTISKID caution immediately prior to landing for the following: <ol style="list-style-type: none"> a. The ANTISKID caution is removed for up to 13.5 seconds as the system performs IBIT even though the anti-skid system may still be failed. b. If the system is not failed, wheel motion at touchdown or during landing rollout may cause a false BIT failure and a dump of normal brake pressure when brakes are applied. • If the ANTI SKID switch is not placed to OFF with an ANTISKID caution displayed, normal braking capability may be lost completely. 	<p>GROUND</p> <ol style="list-style-type: none"> 1. ANTI SKID switch - OFF <p>IN FLIGHT</p> <p>If more than 30 seconds to landing -</p> <ol style="list-style-type: none"> 1. ANTI SKID switch - CYCLE ONCE <p>If caution reappears or if less than 30 seconds to landing -</p> <ol style="list-style-type: none"> 2. ANTI SKID switch - OFF (DO NOT CYCLE.) 3. Consider short field arrestment. 4. If arresting gear not available or not desired, regulate brake pedal force to prevent wheel skid.
AOA DEGD	<ul style="list-style-type: none"> • A single AOA probe is selected. AOA indexers may be inaccurate. 	<p>Carrier -</p> <ol style="list-style-type: none"> 1. Notify LSO approach light indications may be inaccurate.
APU ACCUM <div style="border: 1px solid black; padding: 2px; display: inline-block;">APU ACC</div> Caution Light	<ul style="list-style-type: none"> • APU accumulator pressure low • Possible leak in isolated HYD 2B system <p>The APU ACCUM caution can be expected after APU start or after emergency gear/probe extension in flight. With WonW, the APU accumulator recharges automatically. With WoffW, the HYD ISOL switch may need to be held for up to 10 seconds following emergency gear/probe extension to remove the APU ACCUM caution and 20 seconds to provide a full charge (up to 40 seconds following in flight APU start).</p> <div style="text-align: center; border: 1px solid black; padding: 5px; width: fit-content; margin: 10px auto;">CAUTION</div> <p>If the APU ACCUM caution appears in flight and is not related to emergency gear/probe extension or APU start, it may indicate a possible leak in the isolated HYD 2B system.</p>	<p>If APU ACCUM caution appeared following emergency gear or probe extension -</p> <ol style="list-style-type: none"> 1. HYD ISOL switch - ORIDE (until 10 seconds after APU ACCUM caution removed - approximately 20 seconds) <p>Otherwise, if required or desired -</p> <ol style="list-style-type: none"> 1. HYD ISOL switch - ORIDE (10 seconds maximum) <p>If caution remains or returns -</p> <ol style="list-style-type: none"> 2. Do not select HYD ISOL ORIDE. (To inhibit leaking out HYD 2B.) 3. Extend landing gear as soon as practical.
ASPJ AMP	<ul style="list-style-type: none"> • BIT detected failure in Receiver RF-preamplifier 	Information
ASPJ DEGD	<ul style="list-style-type: none"> • Continuous BIT failure detected 	<ol style="list-style-type: none"> 1. Run ASPJ IBIT.
ASPJ HI B	<ul style="list-style-type: none"> • BIT detected failure in ASPJ HI-band 	Information
ASPJ LO B	<ul style="list-style-type: none"> • BIT detected failure in ASPJ LO-band 	Information

Figure 12-1. Warning/Caution/Advisory Displays (Sheet 6)

* Immediate action item
 ☆ Discussion in part V

DDI Cautions and Caution Lights



INDICATOR	CAUSE/REMARKS	CORRECTIVE ACTION
ASPJ OVRHT 	<ul style="list-style-type: none"> • Non safety-of-flight overheat in ASPJ. 	Information
ASPJ RPTF	<ul style="list-style-type: none"> • BIT detected failure in ASPJ RF tunable filter. 	Information
ATARS OVRHT	<ul style="list-style-type: none"> • ATARS subsystem is overheated. Does not include data link pod overtemp. No data link overheat reporting is provided with ATARS switch OFF. Electrical power is available to both RADAR and ATARS during ground operation on aircraft power, however cooling is only provided to RADAR if both systems are powered on.	<p>GROUND</p> <ol style="list-style-type: none"> 1. RADAR switch - OFF <p>IN FLIGHT</p> <ol style="list-style-type: none"> 1. ATARS switch - OFF 2. CLP power knob - OFF
L ATS R ATS	<ul style="list-style-type: none"> • Designated air turbine starter rpm too high (e.g., both sources of ATS overspeed cutout protection have failed). • ECS valve failures are routing engine bleed air to rotate the corresponding ATS. <div style="text-align: center;">  </div> <ul style="list-style-type: none"> • Under less than optimal conditions (low altitude, heavy breathing, loose fitting mask, etc.), as few as 3 minutes of emergency oxygen may be available. • If both bleeds secured - <ul style="list-style-type: none"> - No OBOGS - No ECS or cabin pressurization - No anti-g protection - No external fuel transfer - No crossbleed start - No throttle boost - No windshield anti-ice/rain removal - May get AV AIR HOT during approach - To prevent canopy fogging, select OFF/RAM or RAM/DUMP and move the DEFOG handle to HIGH <div style="text-align: center;">  </div> <p>Regardless of the engine start air source utilized, the corresponding GEN switch should be ON, as the generator provides primary overspeed cutout protection for the ATS.</p>	<p>GROUND</p> <p>After engine start (other than momentary) -</p> <ol style="list-style-type: none"> 1. APU switch - OFF 2. BLEED AIR knob - OFF 3. Throttle affected engine - OFF 4. ENG CRANK switch - VERIFY OFF <p>IN FLIGHT (other than momentary)</p> <p>*1. Throttles - Minimum practical</p> <p>OBOGS aircraft -</p> <p>*2. Emergency oxygen green ring(s) - PULL</p> <p>All aircraft -</p> <p>*3. BLEED AIR knob - OFF (DO NOT CYCLE.)</p> <p>*4. Initiate rapid descent to below 10,000 feet cabin altitude.</p> <p>If caution remains -</p> <ol style="list-style-type: none"> 5. Throttle affected engine - IDLE <p>With both bleeds secured -</p> <ol style="list-style-type: none"> 6. Maintain airspeed below 325 KCAS (300 to 325 KCAS optimum). 7. ECS MODE switch - OFF/RAM 8. AV COOL switch - EMERG 9. CABIN PRESS switch - RAM/DUMP 10. EXT TANKS switch(es) - STOP 11. Land as soon as practical. <p>OBOGS aircraft -</p> <ol style="list-style-type: none"> 12. OXY FLOW knob(s) - OFF 13. OBOGS control switch - OFF 14. Maintain altitude below 10,000 feet MSL prior to emergency oxygen depletion (10 to 20 minutes). 15. Consider removing mask and resetting emergency oxygen system once below 10,000 feet MSL. <p>If AV AIR HOT caution appears -</p> <ol style="list-style-type: none"> 16. Non-essential avionics equipment - OFF (e.g., RADAR, UFC controlled avionics, ECM, sensors, MC2) 17. Land as soon as possible.

Figure 12-1. Warning/Caution/Advisory Displays (Sheet 7)

* Immediate action item
 ☆ Discussion in part V

DDI Cautions and Caution Lights



INDICATOR	CAUSE/REMARKS	CORRECTIVE ACTION
AUTO PILOT	<ul style="list-style-type: none"> • Uncommanded autopilot disengage. 	1. Paddle switch - PRESS
AV AIR DGD	<ul style="list-style-type: none"> • Low avionics cooling air pressure or cabin air exit regulator controller failed. 	If ECM suite is ON or needed - 1. ECS mode switch - MANUAL
AV AIR HOT	<ul style="list-style-type: none"> • Avionics cooling air hot or low flow. <p>Prolonged caution may result in loss of MC 1, MC 2, INS, HUD, DDI, etc.</p> <p>If bleed air off, see remarks under L BLEED OFF/R BLEED OFF.</p> <p>Monitor cabin pressure. Loss of airflow to the avionics may indicate a loss of airflow to the cockpit pressurization system.</p> <div style="text-align: center;">  </div> <p>On Aircraft 161353 thru 163175 BEFORE IAYC 853, to minimize potential of APU damage due to surging, use bleed air aug only when absolutely necessary to maintain cooling.</p>	<p>GROUND</p> <ol style="list-style-type: none"> 1. ECS MODE switch - VERIFY AUTO or MAN 2. BLEED AIR knob - CYCLE 3. ECS MODE switch - MANUAL <p>If conditions permit -</p> <ol style="list-style-type: none"> 4. Either throttle - ADVANCE ABOVE 74 % rpm <p>If conditions do not permit engine runup -</p> <ol style="list-style-type: none"> 5. APU switch - ON 6. BLEED AIR knob - AUG PULL <p>If caution on after 3 minutes -</p> <ol style="list-style-type: none"> 7. Do not takeoff. <p>If caution removed prior to 3 minutes -</p> <ol style="list-style-type: none"> 8. BLEED AIR knob - Push down to normal position 9. APU switch - OFF prior to takeoff <p>IN FLIGHT</p> <ol style="list-style-type: none"> 1. Throttles - Maintain above IDLE <p>If caution on after 1 minute -</p> <ol style="list-style-type: none"> 2. Maintain altitude below 25,000 feet (20,000 to 25,000 feet optimum for cooling). 3. Maintain airspeed below 325 KCAS (300 to 325 KCAS optimum for cooling). 4. ECS MODE switch - OFF/RAM 5. AV COOL switch - EMERG 6. CABIN TEMP knob - FULL COLD (cabin pressure altitude will slowly increase) <p>If caution off -</p> <ol style="list-style-type: none"> 7. Land as soon as practical. <p>If caution remains -</p> <ol style="list-style-type: none"> 7. Non-essential avionics equip - OFF (e.g., RADAR, UFCD controlled avionics, ECM, sensors, MC2) 8. Land as soon as possible.
E BATT LO U BATT LO	<ul style="list-style-type: none"> • Emergency battery and/ or utility battery charge low. 	<p>IN FLIGHT</p> <ol style="list-style-type: none"> 1. Avoid high speed. 2. Battery switch - OFF / ON FOR LANDING
BATT SW  Caution Light	<ul style="list-style-type: none"> • BATT switch ON without ac power on aircraft. • BATT switch OFF with ac power on aircraft. <p>Prolonged ground operation with caution on may damage battery and dc electrical system.</p>	<p>If ac power on & BATT switch OFF or ORIDE -</p> <ol style="list-style-type: none"> 1. BATT switch - ON <p>If no internal dc power & BATT switch ON or ORIDE -</p> <ol style="list-style-type: none"> 2. Refer to Double Generator Or Double Transformer - Rectifier Failure.

Figure 12-1. Warning/Caution/Advisory Displays (Sheet 8)

* Immediate action item
 ☆ Discussion in part V

DDI Cautions and Caution Lights

INDICATOR	CAUSE/REMARKS	CORRECTIVE ACTION
BINGO "Bingo, Bingo"	<ul style="list-style-type: none"> Internal fuel level below BINGO setting. 	1. Adjust BINGO setting or execute BINGO profile.
L BLD OFF and/or R BLD OFF (Both BLEED warning lights out)	<ul style="list-style-type: none"> The corresponding primary bleed air shutoff valve has been commanded closed. <ol style="list-style-type: none"> BALD system detected a leak in one or both bleed air systems and the overheat condition no longer exists (L, R, or both cautions). Over pressurization detected in one or both systems (both cautions). BLEED AIR knob in L OFF, R OFF, or OFF (L, R, or both cautions). ENG CRANK switch in L or R (L or R caution, respectively). FIRE test switch in TEST A or TEST B (both cautions). <p>BLD OFF cautions are not an indication of actual valve position. Valve(s) could still be open allowing bleed air to leak.</p> <p>Bleed air leak MSP code: 831 Over pressurization MSP code: 833</p> <div style="border: 2px solid black; padding: 5px; text-align: center; width: fit-content; margin: 10px auto;">WARNING</div> <ul style="list-style-type: none"> Automatic functioning of the BALD system may extinguish the red BLEED warning light(s) prior to aircrew recognition and may not trigger the appropriate voice alerts or the voice alerts may be the only indication of a bleed air system leak. In this case, cycling the BLEED AIR knob to remove the BLD OFF caution(s) reintroduces hot bleed air to the leaking duct. If the sensing element was damaged by the leak, automatic shutdown and isolation capability may be lost. Extensive damage or fire may result. Under less than optimal conditions (low altitude, heavy breathing, loose fitting mask, etc.), as few as 3 minutes of emergency oxygen may be available. If both bleeds secured - <ul style="list-style-type: none"> No OBOGS No ECS or cabin pressurization No anti-g protection No external fuel transfer No crossbleed start No throttle boost No windshield anti-ice/rain removal May get AV AIR HOT during approach To prevent canopy fogging, select OFF/RAM or RAM/DUMP and move the DEFOG handle to HIGH 	1. Adjust BINGO setting or execute BINGO profile.

Figure 12-1. Warning/Caution/Advisory Displays (Sheet 9)

SEE IC # 91

* Immediate action item
 ☆ Discussion in part V

DDI Cautions and Caution Lights

INDICATOR	CAUSE/REMARKS	CORRECTIVE ACTION
L BOOST LO R BOOST LO	<ul style="list-style-type: none"> Loss of fuel boost pressure to designated engine. May indicate fuselage fuel leak. May indicate fuel transfer failure. If associated with GEN, and both HYD circuit cautions, may be a PTS failure. May result from prolonged transitions through zero g (greater than 2 seconds). Afterburner may not operate above 30,000 feet. The crossfeed valves open automatically.	<ol style="list-style-type: none"> Limit corresponding afterburner usage above 30,000 feet. Check for indications of fuselage fuel leak. Monitor fuel transfer. Land as soon as practical.
BRK ACCUM	<ul style="list-style-type: none"> Brake accumulator pressure low (below 1,750 psi) Emergency brakes may not be available. <div style="text-align: center; border: 2px solid black; padding: 5px; width: fit-content; margin: 10px auto;"> CAUTION </div> A BRK ACCUM caution in flight is not normal and may indicate a possible leak in the isolated HYD 2B system. If the caution appears in flight, do not attempt to recharge the accumulator as this may result in additional loss of HYD 2B fluid.	<ol style="list-style-type: none"> Extend landing gear as soon as practical.
<div style="border: 1px solid black; padding: 2px; display: inline-block;"> CABIN </div> Caution Light	<ul style="list-style-type: none"> Cabin pressure altitude above 21,000 ± 1,100 feet. Cabin light may not extinguish until cabin pressure altitude is below 16,500 feet. <div style="text-align: center; border: 2px solid black; padding: 5px; width: fit-content; margin: 10px auto;"> WARNING </div> <ul style="list-style-type: none"> CABIN light may appear with normal cabin pressurization when aircraft altitude is above 47,000 feet MSL. If altitude is maintained, aircrew should continuously monitor physiological condition. DCS may be experienced when operating with cabin pressure altitude above 25,000 feet even with a working oxygen system. Symptoms of DCS include pain in joints, tingling sensations, dizziness, paralysis, choking, and/or loss of consciousness. 	<p>BELOW 47,000 FEET MSL OBOGS Aircraft -</p> <ul style="list-style-type: none"> *1. Emergency oxygen green ring(s) - PULL *2. OXY FLOW knob(s) - OFF <p>All Aircraft -</p> <ul style="list-style-type: none"> *3. Initiate rapid descent to below 10,000 feet cabin altitude. 4. CABIN PRESS switch - CHECK NORM 5. ECS MODE switch - CHECK AUTO or MAN <p>If DCS or hypoxia symptoms present -</p> <ul style="list-style-type: none"> 6. Maintain altitude below 10,000 feet MSL. 7. Land as soon as possible. <p>If DCS or hypoxia symptoms not present -</p> <p>OBOGS Aircraft -</p> <ul style="list-style-type: none"> 6. Reset emergency oxygen system and resume normal OBOGS operation. <p>All Aircraft -</p> <ul style="list-style-type: none"> 7. Maintain altitude below 25,000 feet MSL. 8. Land as soon as practical. <p>ABOVE 47,000 FEET MSL</p> <ol style="list-style-type: none"> Continuously monitor physiological conditions and cabin pressure altimeter.

Figure 12-1. Warning/Caution/Advisory Displays (Sheet 10)

V-12-12

* Immediate action item
 ☆ Discussion in part V

DDI Cautions and Caution Lights

INDICATOR	CAUSE/REMARKS	CORRECTIVE ACTION
■ CANOPY	<ul style="list-style-type: none"> • Canopy not down and locked. <p>In the F/A-18B/D, rear seat occupant should lower seat and lean as far forward as possible, in case the canopy departs the aircraft.</p>	<p>IN FLIGHT</p> <ol style="list-style-type: none"> 1. CANOPY switch - CONFIRM DOWN 2. Slow below 300 KCAS (200 KCAS in F/A-18B/D) if practical. 3. Maintain altitude below 25,000 feet. 4. CABIN PRESS switch - RAM/DUMP 5. CANOPY switch - DOWN 6. CABIN PRESS switch - NORM <p>If light stays on -</p> <ol style="list-style-type: none"> 7. Land as soon as practical.
■ CAUT DEGD	<ul style="list-style-type: none"> • Capability to display cautions degraded. <p>Cycling MC1 with an SDC failure zeroizes all fuel indications on the FUEL page.</p> <p>Cautions may be false or erratic.</p>	<ol style="list-style-type: none"> 1. F/A-18C/D only: FUEL page/SDC - RESET 2. MC 1 - CYCLE to 1 OFF then NORM <ul style="list-style-type: none"> • Fuel quantity indications on FUEL page will be zeroized. <p>If caution remains or reappears -</p> <ol style="list-style-type: none"> 3. Land as soon as practical.
■ CG	<ul style="list-style-type: none"> • Tanks 1 and 4 fuel distribution out of balance. 	<ol style="list-style-type: none"> 1. Stop maneuvering. 2. Check transfer tanks 1 & 4. 3. Calculate CG. <p>If CG aft of limit -</p> <ol style="list-style-type: none"> 4. Refer to Landing With Aft CG.
■ CK FLAPS	<ul style="list-style-type: none"> • FLAP switch in AUTO position at takeoff. 	<ol style="list-style-type: none"> 1. Place FLAP switch in correct position for takeoff.
CHECK SEAT ■ CK SEAT Caution Light	<p>One or both ejection seats not armed with WonW and throttles advanced.</p>	<ol style="list-style-type: none"> 1. Ejection seat SAFE/ARMED handle(s) - CHECK ARMED <p>If caution remains -</p> <ol style="list-style-type: none"> 2. Do not takeoff.
CHECK TRIM	<ul style="list-style-type: none"> • Trim incorrect for takeoff. 	<ol style="list-style-type: none"> 1. T/O TRIM button - PRESS UNTIL TRIM ADVISORY DISPLAYED <p>If carrier based -</p> <ol style="list-style-type: none"> 2. TRIM - SET FOR CATAPULT LAUNCH
■ CK ECS Caution Light	<ul style="list-style-type: none"> • ECS MODE switch - OFF/RAM • CABIN PRESS switch - DUMP or RAM/DUMP • BLEED AIR knob - OFF 	<ol style="list-style-type: none"> 1. ECS MODE/CABIN PRESS switches/ BLEED AIR knob - CHECK POSITION
CNI	<ul style="list-style-type: none"> • CNI interface failure. <p>UFC may not operate in some or all modes.</p>	<ol style="list-style-type: none"> 1. Check BIT page. <p>If CSC MUX fail -</p> <ol style="list-style-type: none"> 2. Refer to CSC MUX FAILURE.
DFIR OVRHT	<ul style="list-style-type: none"> • DFIRS reporting an overtemperature condition. 	Information
■ DFIRS GONE	<ul style="list-style-type: none"> • DFIRS inadvertently deployed. 	<p>Unless visually confirmed intact -</p> <ol style="list-style-type: none"> 1. Land as soon as practical.

Figure 12-1. Warning/Caution/Advisory Displays (Sheet 11)

* Immediate action item
 ☆ Discussion in part V

DDI Cautions and Caution Lights

INDICATOR	CAUSE/REMARKS	CORRECTIVE ACTION
DL OVRHT	ATARS data link pod subsystem overheated.	1. CLP power knob - OFF
DTR1 COLD DTR2 COLD	<ul style="list-style-type: none"> • ATARS tape deck is cold. Usually occurs at startup. Warmup takes less than 5 minutes at 32°F. Up to 45 min warmup may be required at -40°F. Ground - Recce mode not available until both decks are warmed up. In flight - Recce mode is available with one deck warmed up.	1. ATARS switch - ON 2. ATARS preflight checks - DISCONTINUE When caution is removed - 3. ATARS preflight checks - CONTINUE
DTR1 SHTDN DTR2 SHTDN	<ul style="list-style-type: none"> • ATARS tapedeck shutdown caused by cold, overtemp or condensation. Record capability is disabled. Additional information is displayed on the BIT-ATARS-MAINT page, and a condensation cue advisory is displayed on RECCE video.	1. ATARS switch - ON If caution remains after 20 min - 2. ATARS switch - OFF 3. CLP power knob - OFF
L DUCT DR R DUCT DR	<ul style="list-style-type: none"> • Designated duct door closed above Mach 1.33 or open below Mach 1.23. Drag is increased with door open. At airspeeds above Mach 1.33 with door failed closed, engine inlet pressure oscillations, "inlet buzz", will gradually increase with increasing Mach, and possibly culminate in engine stall.	1. Reduce speed below Mach 1.33.
DUMP OPEN	<ul style="list-style-type: none"> • Fuel dump valve open with DUMP switch in OFF. If the dump valve cannot be closed, fuel continues to dump until tanks 1 and 4 are empty. Selecting WING INHBIT diverts recirculation fuel from the wings to the feed tanks. Stopping external transfer may make this fuel available if the dump valve is subsequently closed. Delaying landing until the transfer tanks are empty (3,100 pounds of fuel remaining) will prevent fuel from dumping onto hot exhaust nozzles and fouling of the landing area.	1. DUMP switch - CYCLE 2. BINGO setting - Set above internal fuel state. If dump continues (caution remains) - 3. F/A-18A/B only: INTR WING switch - INHIBIT If external fuel also remains - 4. EXT TANKS switches - STOP 5. Land as soon as possible. When capacity available in feed tanks - 6. EXT TANKS switches - NORM If fuel continues to dump on deck - 7. Turn aircraft into the wind. 8. Throttles - OFF If/when dump stops (caution removed) - 3. EXT TANKS switches - CHECK NORM

Figure 12-1. Warning/Caution/Advisory Displays (Sheet 12)

* Immediate action item
 ☆ Discussion in part V

DDI Cautions and Caution Lights

INDICATOR	CAUSE/REMARKS	CORRECTIVE ACTION
■ L EGT HIGH R EGT HIGH "Engine Left (Right), Engine Left (Right)"	<ul style="list-style-type: none"> • Designated exhaust gas temperature out of limits 	*1. Throttle affected engine - IDLE If caution remains at IDLE or engine response is abnormal - 2. Throttle affected engine - OFF 3. Refer to Single Engine Approach and Landing procedure. If caution clears - 2. Land as soon as practical. 3. Consider HALF flap approach for landing.
■ ENG MATCH	<ul style="list-style-type: none"> • One engine is F404-GE-400 and other engine is F404-GE-402. 	1. Abort
ERASE FAIL	<ul style="list-style-type: none"> • A component which contains classified information has reported a critical failure which may prevent successful erasure of stored classified data. 	Information
■ EXT TANK	<ul style="list-style-type: none"> • External tanks pressurized on ground or tanks have overpressurized. <p style="text-align: center;">NOTE</p> <p>Carrier launch prohibited with less than 1900 pounds in external drop tank.</p>	<p>GROUND</p> 1. EXT TANKS switch(es) - VERIFY NORM If caution remains - 2. Do not catapult. <p>IN FLIGHT</p> 1. EXT TANKS switch(es) - STOP (when external transfer complete)

Figure 12-1. Warning/Caution/Advisory Displays (Sheet 13)

* Immediate action item
 ☆ Discussion in part V

DDI Cautions and Caution Lights

INDICATOR	CAUSE/REMARKS	CORRECTIVE ACTION
<p>EXT XFER</p>	<ul style="list-style-type: none"> • One or more external tanks failed/slow to transfer when commanded. <p>Icing may occur in the external fuel tank pressurization system inhibiting external tank transfer and refueling. Descending and accelerating may reduce the effects of icing.</p> <p>External fuel available but not transferring.</p> <p>On F/A-18C/D aircraft, selecting ORIDE on both EXT TANKS fuel control switches may inhibit centerline tank transfer.</p>	<ol style="list-style-type: none"> 1. F/A-18A/B only: HOOK handle - CONFIRM UP 2. FUEL page/Fuel Quantity indicator/IFEI - IDENTIFY EXT TANK WITH TRAPPED FUEL <p>Perform the following steps while monitoring fuel transfer, tank quantities, and lateral asymmetry -</p> <ol style="list-style-type: none"> 3. EXT TANKS switch(es) - ORIDE 4. EXT TANKS switch(es) - CYCLE to STOP and back to ORIDE 5. EXT TANKS switch(es) - NORM 6. PROBE switch - CYCLE 7. Apply positive and negative g. 8. F/A-18C/D only: FUEL page/SDC - RESET <p>If practical -</p> <ol style="list-style-type: none"> 9. Descend below freezing level and repeat steps 3 thru 8. 10. If below 10,000 feet MSL, BLEED AIR knob - CYCLE THRU OFF TO NORM 11. LDG GEAR and HOOK handles - DOWN 12. LDG GEAR and HOOK handles - UP 13. Perform in-flight refueling. <p>If/when transfer complete but prior to landing -</p> <ol style="list-style-type: none"> 14. EXT TANKS switch(es) - NORM <p>If external wing tank fuel trapped -</p> <ol style="list-style-type: none"> 15. Ensure lateral asymmetry within limits for landing. <p>FOR CARRIER LANDING If centerline tank is still over 500 pounds -</p> <ol style="list-style-type: none"> 16. Divert or SELECT JETT tank.
<p>L FLAMEOUT R FLAMEOUT</p> <p>“Engine Left (Right), Engine Left (Right)”</p>	<ul style="list-style-type: none"> • Designated engine flamed out. <div style="text-align: center;">  </div> <p>Attempting to restart an engine that has flamed out for no apparent reason may result in an engine bay fuel leak/fire.</p> <p>Restarting an engine that flamed out for no apparent reason may result in an engine bay fuel leak/fire.</p> <p>If an engine fails, the corresponding generator and HYD system will be lost. Either generator supplies sufficient power to operate all electrical items. A windmilling engine can cause repeated flight control transients as the hydraulic switching valves operate. Various FCS cautions will come on intermittently. After the rpm has decreased to near zero, the transients will cease, the FCS cautions will go off, and FCS operation will be normal. To prevent repeated switching valve cycling, avoid stabilized flight where engine windmilling rpm produces hydraulic pressure fluctuations between 800 to 1,600 psi. If control of a surface is lost due to a frozen or sticking switching valve, attempt to unstick the valve by gently cycling the flight controls, and reset the FCS.</p>	<p>SINGLE ENGINE FLAMEOUT</p> <ol style="list-style-type: none"> *1. Throttle affected engine - IDLE <p>If rpm continues to decrease with increasing EGT (failed auto-restart) -</p> <ol style="list-style-type: none"> 2. Throttle affected engine - OFF 3. Refer to Single Engine Approach and Landing procedure. <p>If engine auto-restarts -</p> <ol style="list-style-type: none"> 4. Check engine response at a safe altitude. 5. Land as soon as practical. 6. Consider HALF flap approach for landing.

Figure 12-1. Warning/Caution/Advisory Displays (Sheet 14)

* Immediate action item
 ☆ Discussion in part V

DDI Cautions and Caution Lights

INDICATOR	CAUSE/REMARKS	CORRECTIVE ACTION
■ FLIR OVRHT	<ul style="list-style-type: none"> Targeting FLIR internal overheat detected. 	1. FLIR switch - OFF (if practical)
■ L FUEL HOT R FUEL HOT	<ul style="list-style-type: none"> Designated engine fuel feed temperature too high. Fuel temperature greater than 79°C may cause AMAD to overheat with associated cautions.	<p>PRE-FLIGHT</p> 1. Throttle affected engine - OFF
■ FUEL LO FUEL LO "Fuel low, Fuel low"	<ul style="list-style-type: none"> At least one feed tank below 800 pounds. May indicate fuselage fuel leak. Sideslip may be required to transfer wing fuel.	1. Throttles - Reduce fuel flow (if practical) 2. Land as soon as possible. 3. Check for fuel transfer failure indications. If trapped fuel indicated - 4. EXT TANK switches - CHECK 5. Avoid negative g maneuvering.
■ FUEL XFER	<ul style="list-style-type: none"> Tanks 1 and 4 fuel distribution out of balance. 	1. Stop maneuvering. 2. Check transfer tanks 1 & 4. 3. Calculate CG. If CG aft of limit - 4. Refer to Landing With Aft CG.
■ L GEN R GEN L GEN R GEN Caution Lights	<ul style="list-style-type: none"> Designated generator off line. Either generator can support the total aircraft electrical load. With both generators offline refer to Double Generator/ Double Transformer Rectifier failure. With both generators offline - No OBOGS If associated with BOOST LO and both HYD circuit cautions, may be a PTS failure.	<p>SINGLE GEN FAILURE</p> 1. Generator switch - CYCLE If generator still failed - 2. Generator switch - OFF 3. Land as soon as practical.

Figure 12-1. Warning/Caution/Advisory Displays (Sheet 15)

* Immediate action item
 ☆ Discussion in part V

DDI Cautions and Caution Lights

INDICATOR	CAUSE/REMARKS	CORRECTIVE ACTION												
<p>GEN TIE Caution Light</p>	<ul style="list-style-type: none"> • Left and right 115 vac buses are isolated (bus tie open). • May be caused by initial engine start with the PARK BRK released or by electrical fault protection circuitry. <p style="text-align: center;">CAUTION</p> <p>If the left and right buses are isolated because of a detected fault, cycling the GEN TIE CONTROL switch reenergizes the faulty bus/equipment and may cause further damage or loss of the remaining generator.</p>	<p>GROUND If PARK BRK released during first engine start - Battery Start</p> <ol style="list-style-type: none"> 1. PARK BRK handle - SET 2. Operating GEN switch - CYCLE 3. Start second engine. <p>External Power Start</p> <ol style="list-style-type: none"> 1. PARK BRK handle - SET 2. GEN TIE CONTROL switch - CYCLE 3. Start second engine. <p>IN FLIGHT</p> <ol style="list-style-type: none"> 1. GEN TIE CONTROL switch - NORM (DO NOT CYCLE.) <p>If both GENs operating -</p> <ol style="list-style-type: none"> 1. Do not attempt to reset GEN TIE. 2. Continue mission with GEN TIE on. <p>With L or R GEN caution light -</p> <ol style="list-style-type: none"> 2. GEN switch affected side - CYCLE <p>If GEN restored -</p> <ol style="list-style-type: none"> 3. Do not attempt to reset GEN TIE. 4. Continue mission with GEN TIE on. <p>If GEN still failed -</p> <ol style="list-style-type: none"> 3. GEN switch affected side - OFF 4. Land as soon as practical. 5. Refer to Emergency Power Distribution chart. 												
<p>G-LIM 7.5 G "Flight Controls, Flight Controls"</p>	<ul style="list-style-type: none"> • Nz REF set to 7.5g regardless of gross weight. <p>G-limiter will not prevent an aircraft overstress at gross weights above 32,357 lb. Above 32,357 lb gross weight, pilot must limit g to prevent overstress.</p> <p>The presence of the G-LIM 7.5 caution may be an indication that the FCC has declared MUX data failed. If this is the cause for the G-LIM 7.5 G caution, Xs will appear in CH 1/3 of the PROC row on the FCS page, as the FCS will stop using INS provided data across the MUX. There is no significant degradation to flying qualities, departure resistance or roll performance with these failure indications.</p>	<ol style="list-style-type: none"> 1. Limit intentional accelerations to the following: <table border="1" style="margin-left: 40px;"> <thead> <tr> <th>GW (lb)</th> <th>Acceleration (g)</th> </tr> </thead> <tbody> <tr> <td>≤32,357</td> <td>-3.0 to +7.5</td> </tr> <tr> <td>34,000</td> <td>-2.9 to +7.1</td> </tr> <tr> <td>38,000</td> <td>-2.6 to +6.4</td> </tr> <tr> <td>42,000</td> <td>-2.3 to +5.8</td> </tr> <tr> <td>50,000</td> <td>-1.9 to +4.8</td> </tr> </tbody> </table>	GW (lb)	Acceleration (g)	≤32,357	-3.0 to +7.5	34,000	-2.9 to +7.1	38,000	-2.6 to +6.4	42,000	-2.3 to +5.8	50,000	-1.9 to +4.8
GW (lb)	Acceleration (g)													
≤32,357	-3.0 to +7.5													
34,000	-2.9 to +7.1													
38,000	-2.6 to +6.4													
42,000	-2.3 to +5.8													
50,000	-1.9 to +4.8													
<p>G-LIM OVRD</p>	<ul style="list-style-type: none"> • G-limiter overridden. <p>Selected by momentarily pressing the paddle switch when the stick is near the full aft limit. Maximum allowed g-limit increased by 33% (allows a 10g command at 7.5g Nz REF). Unless g-limiter override is desired, control maximum g-level. If the paddle switch has failed electrically, NWS and the autopilot may be commanded off without pilot action or notification.</p>	<ol style="list-style-type: none"> 1. Stick - Return to near neutral to disengage override 												
<p>GPS DEGD</p>	<ul style="list-style-type: none"> • GPS approach flight phase and HERR exceeds 108 feet for 10 seconds. 	<p>Information</p>												

Figure 12-1. Warning/Caution/Advisory Displays (Sheet 16)

* Immediate action item
 ☆ Discussion in part V

DDI Cautions and Caution Lights

INDICATOR	CAUSE/REMARKS	CORRECTIVE ACTION
■ GUN GAS	<ul style="list-style-type: none"> • Gun purge air pressure low. <div style="border: 2px solid black; padding: 5px; display: inline-block; margin: 10px 0;">WARNING</div> <p>Failure to purge cartridge combustion gases may result in a gun bay explosion and significant aircraft damage.</p>	<ol style="list-style-type: none"> 1. Do not fire gun, even if caution clears.
HAND CNTRL	<ul style="list-style-type: none"> • One hand controller inoperative. 	Information
■ HOME FUEL	<ul style="list-style-type: none"> • Fuel remaining sufficient to fly to HOME waypoint with 2,000 lbs reserve or less. <p>HOME FUEL caution logic is disabled with WonW, the refueling probe extended, the landing gear cycled down then up, or within 5 seconds after a HOME waypoint change.</p>	<ol style="list-style-type: none"> 1. Change HOME waypoint (if appropriate) or analyze configuration, fuel flow, and profile for BINGO.
IFF 4 "Mode 4 reply, Mode 4 reply"	<ul style="list-style-type: none"> • Transponder failed to respond to a valid mode 4 interrogation (failure or mode 4 not enabled). • Failure in the KIT 1C. • Mode 4 codes zeroized, or KIT 1C installed but not keyed with crypto. <p>The IFF 4 caution and voice alert are disabled with the IFF MODE 4 switch in the OFF position.</p>	Information
IFFAI	Some interrogator operations may not function.	Information
■ IFF OVRHT	<ul style="list-style-type: none"> • IFF overheat detected. 	<ol style="list-style-type: none"> 1. IFF - OFF (if practical)
■ L IN TEMP R IN TEMP "Engine Left (Right), Engine Left (Right)"	<ul style="list-style-type: none"> • Designated engine inlet temperature out of limits. 	<ol style="list-style-type: none"> *1. Throttle affected engine - IDLE 2. Land as soon as practical. 3. Consider HALF flap approach for landing.

Figure 12-1. Warning/Caution/Advisory Displays (Sheet 17)

* Immediate action item
 ☆ Discussion in part V

DDI Cautions and Caution Lights

INDICATOR	CAUSE/REMARKS	CORRECTIVE ACTION .
<p>INLET ICE</p>	<p>• Engine inlet icing conditions detected.</p> <p>The INLET ICE caution is designed to come on when 0.025 inch of ice has accumulated on the inlet ice detector, located in the left inlet. Any delay in activating the engine anti-ice system can result in ice accumulating rapidly on the IGVs and shedding into the engine when the system is turned on. Ice accumulation on LEFs is similar to the inlet lip and can serve as an indication of how much ice may be on the inlet. As little as 0.5 inch of ice ingested by the engine from the inlet lip can result in compressor stalls and major FOD.</p> <p>With ice clearly visible on the LEFs, reducing throttle settings below 80% N₂ rpm while descending below the freezing level should generate sufficient inlet spillage to shed inlet ice outside the inlet and not into the engine. Similarly, avoiding throttle transients above 90% N₂ rpm, abrupt maneuvers, and bank angles over 20° should help prevent ice from detaching from the inlet lip and being ingested by the engines.</p> <p>With no ice visible on the aircraft, an INLET TEMP of at least +5°C should provide sufficient aerodynamic heating to prevent ice accumulation on the LEFs and inlet lips.</p>	<ol style="list-style-type: none"> 1. ENG ANTI ICE switch - ON 2. PITOT ANTI ICE switch - ON <p>NO ICE VISIBLE ON LEFS -</p> <ol style="list-style-type: none"> 3. Airspeed - Increase until INLET TEMP is at least +5°C (10° preferred) on ENG format (if possible). 4. AOA - Maintain less than 6° (if possible) to prevent ice accumulation on underside of LEX 5. Climb or descend out of icing danger zone. (>25,000 feet, or below freezing level) <p>When clear of icing conditions and caution removed -</p> <ol style="list-style-type: none"> 6. ENG ANTI ICE switch - OFF <p>ICE VISIBLE ON LEFS -</p> <ol style="list-style-type: none"> 3. Throttles - Reduce below 80% N₂ (if possible). Avoid throttle transients above 90% N₂ 4. Airspeed - Maintain above 250 knots 5. AOA - Maintain less than 6° (if possible) to prevent ice accumulation on underside of LEX. 6. Avoid abrupt maneuvers and bank angles over 20°. 7. Descend below the freezing level. <p>For landing in icing conditions -</p> <ol style="list-style-type: none"> 8. WINDSHIELD switch - ANTI ICE or RAIN (as required) 9. Reduce airspeed and lower the landing gear at the last possible moment (minimizes ice accumulation on the gear). <p>If a missed approach is necessary -</p> <ol style="list-style-type: none"> 10. Slowly advance throttles to the minimum power required for a safe waveoff. 11. Raise landing gear and flaps as soon as possible.

Figure 12-1. Warning/Caution/Advisory Displays (Sheet 18)

* Immediate action item
 ☆ Discussion in part V

DDI Cautions and Caution Lights

INDICATOR	CAUSE/REMARKS	CORRECTIVE ACTION
INS ATT	<p>HUD attitude supplied by the standby attitude reference indicator.</p> <p>W replaces  on the HUD.</p> <p>GPS or EGI GPS function still operates.</p> <p>MSP codes 02F or 061 indicate that NAV data is frozen and NAV data provided to the HUD is not reliable. IFA is no longer possible.</p> <p>If an INS ATT caution is set or the ATT Switch is placed to STBY, Xs will appear in CH 1/3 of the PROC row of the FCS Page indicating FCCs will no longer use INS data. There is no significant degradation to flying qualities, departure resistance or roll performance with these failure indications.</p>	<ol style="list-style-type: none"> ATT/ATTD switch - STBY Verify HUD pitch ladder coincides with standby attitude reference indicator. Attempt an in-flight alignment.
INS DEGD	<ul style="list-style-type: none"> Failure detected during periodic INS BIT. 	<p>GROUND</p> <ol style="list-style-type: none"> Secure and realign INS. <p>IN FLIGHT if INS information is incorrect -</p> <ol style="list-style-type: none"> ATTD/ATT Switch - STBY Position keeping source - ADC Perform in-flight alignment.
INS VEL	<ul style="list-style-type: none"> INS and ADC vertical velocities do not agree. 	<ol style="list-style-type: none"> Crosscheck HUD velocity vector, HUD digital vertical velocity readout and standby rate of climb indicator.
LADDER	<ul style="list-style-type: none"> Boarding ladder unlocked. <p>May FOD left engine.</p>	<p>IN FLIGHT</p> <ol style="list-style-type: none"> Reduce airspeed to the minimum practical. Get a visual inspection (if practical). Consider shutting off left engine to prevent engine FOD. Land as soon as practical.
MC 1	<ul style="list-style-type: none"> Mission computer 1 failed. <p>Only cautions available are AUTO PILOT, MC 1, HYD 1A, HYD 1B, HYD 2A, HYD 2B.</p> <p>GPS or EGI GPS function inoperable.</p> <p>G-limiter and Roll-limiter functions disabled.</p> <p>The presence of the MC 1 caution also indicates that the FCS will stop using INS provided data across the MUX. There is no significant degradation to flying qualities, departure resistance or roll performance with these failure indications.</p>	<ol style="list-style-type: none"> MC switch - CYCLE to 1 OFF then NORM <p>If caution remains or reappears -</p> <ol style="list-style-type: none"> Use no more than 1/2 lateral stick with tanks or A/G stores on the wings. Reduce acceleration below 7.5 g above 32,357 pounds gross weight or if unsymmetrical (rolling). Land as soon as practical.
MC 2	<ul style="list-style-type: none"> Mission computer 2 failed. <p>Most weapon functionality lost.</p>	<ol style="list-style-type: none"> MC switch - CYCLE to 2 OFF then NORM
MC CONFIG	<ul style="list-style-type: none"> ONP loaded into either MC is incorrect. 	<ol style="list-style-type: none"> Do not takeoff.
MDL LOAD	<ul style="list-style-type: none"> MDL to MC loading failure. 	Information
MIDS OVRHT	<ul style="list-style-type: none"> MIDS overheat condition. 	Information

Figure 12-1. Warning/Caution/Advisory Displays (Sheet 19)

* Immediate action item
 ☆ Discussion in part V

DDI Cautions and Caution Lights

INDICATOR	CAUSE/REMARKS	CORRECTIVE ACTION
MU LOAD	<ul style="list-style-type: none"> • MU not communicating on AVMUX. 	<p>For MU Aircraft - 1. Verify MU is installed and seated properly. If caution remains - 2. Do not takeoff. For AMU Aircraft - 1. Verify mission/maintenance cards installed in proper AMU slot and AMU door is closed. 2. If accompanied by a MNTCD or MSNCD advisory, refer to MNTCD or MSNCD advisory.</p>
NAV FAIL	<ul style="list-style-type: none"> • Indicates functional failures of the INS, GPS, and air data functions. 	<p>GROUND 1. INS knob - OFF then realign (GND, CV, or IFA)</p> <p>IN FLIGHT 1. Use standby instruments for altitude/airspeed/vertical velocity. 2. Refer to In-flight Alignment.</p>
NAV HVEL	<p>GPS not operating -</p> <ul style="list-style-type: none"> • INS and ADC velocities disagree. • Can be caused by high wind velocity. <p>GPS operating -</p> <ul style="list-style-type: none"> • INS and GPS, ADC and GPS, or INS and ADC horizontal velocities do not agree. 	<ol style="list-style-type: none"> 1. Crosscheck velocity vector. 2. Crosscheck horizontal velocities on HSI/DATA/NAVCK sublevel.
NAV VVEL	<p>GPS operating -</p> <ul style="list-style-type: none"> • INS and GPS vertical velocities disagree. <p>GPS failed or inoperative -</p> <ul style="list-style-type: none"> • INS and air data function vertical velocities disagree. 	<ol style="list-style-type: none"> 1. Crosscheck HUD velocity vector, HUD digital vertical velocity, and standby rate-of-climb indicator. 2. If vertical velocities disagree, consider using standby attitude for landing.
NFLR OVRHT	<ul style="list-style-type: none"> • NAVFLIR overheat detected. 	<ol style="list-style-type: none"> 1. LST/NFLR switch - OFF (if practical)

Figure 12-1. Warning/Caution/Advisory Displays (Sheet 20)

* Immediate action item
 ☆ Discussion in part V

DDI Cautions and Caution Lights

INDICATOR	CAUSE/REMARKS	CORRECTIVE ACTION
<p>OBOGS DEGD</p> <p>(cautions of any duration)</p>	<div style="border: 2px solid black; padding: 5px; width: fit-content; margin: 0 auto;"> <p>WARNING</p> </div> <ul style="list-style-type: none"> Oxygen concentration is below acceptable limits. Disconnected oxygen hose. Removing oxygen mask without placing the OXY FLOW knob to OFF. System gas leak (broken integrity). <p>Good flow does not equate to good oxygen concentration. An OBOGS DEGD caution indicates that the oxygen concentration is inadequate and hypoxia may result.</p> <p>Under less than optimum conditions (low altitude, heavy breathing, loose-fitting mask, etc.), as few as 3 minutes of emergency oxygen may be available.</p>	<p>GROUND</p> <p>1. Check oxygen system integrity:</p> <ul style="list-style-type: none"> Mask integrity Hose connections OBOGS monitor pneumatic BIT plunger unlocked and fully extended. <p>IN FLIGHT</p> <p>*1. Emergency oxygen green ring(s) - PULL *2. OXY FLOW knob(s) - OFF *3. Initiate rapid descent to below 10,000 feet cabin altitude.</p> <p>4. Check oxygen system integrity:</p> <ul style="list-style-type: none"> Mask integrity Hose connections OBOGS monitor pneumatic BIT plunger unlocked and fully extended. <p>If system integrity not compromised -</p> <p>5. Maintain cabin altitude below 10,000 feet. 6. OBOGS control switch - OFF</p> <p>Once below 10,000 feet cabin altitude and no hypoxic symptoms present -</p> <p>7. Consider removing mask and resetting emergency oxygen system or resuming normal OBOGS operation if flow appears normal and donning of mask is desired. 8. Land as soon as practical.</p> <p>If system integrity restored -</p> <p>5. Resume normal OBOGS operation. 6. Reset emergency oxygen system.</p>
<p>OCS</p>	<ul style="list-style-type: none"> MC or SMS overlay halted due to run time. <p>Stores that require overlay may not be available.</p>	<p>1. Attempt to reload overlay.</p>
<p>L OIL PR R OIL PR</p> <p>"Engine left (right), Engine left (right)"</p>	<ul style="list-style-type: none"> Designated engine oil pressure out of limits. 	<p>*1. Throttle affected engine - IDLE</p> <p>If caution remains after 15 seconds -</p> <p>2. Throttle affected engine - OFF 3. Refer to Single Engine Approach and Landing procedure.</p> <p>If caution clears -</p> <p>2. Land as soon as practical. 3. Consider HALF flap approach for landing.</p>
<p>L OVRSPD R OVRSPD</p> <p>"Engine left (right), Engine left (right)"</p>	<ul style="list-style-type: none"> Designated fan or compressor rpm high. 	<p>*1. Throttle affected engine - IDLE</p> <p>If caution remains at IDLE or engine response is abnormal -</p> <p>2. Throttle affected engine - OFF 3. Refer to Single Engine Approach and Landing procedure.</p> <p>If caution clears -</p> <p>2. Land as soon as practical. 3. Consider HALF flap approach for landing.</p>
<p>OXY LOW</p>	<ul style="list-style-type: none"> Oxygen quantity indication below 1 liter. 	<p>1. Oxygen quantity - CHECK</p> <p>If under 1 liter -</p> <p>2. Maintain cabin altitude below 10,000 feet.</p>

Figure 12-1. Warning/Caution/Advisory Displays (Sheet 21)

* Immediate action item
 ☆ Discussion in part V

DDI Cautions and Caution Lights

INDICATOR	CAUSE/REMARKS	CORRECTIVE ACTION
PARK BRAKE	<ul style="list-style-type: none"> • Parking brake still set when throttles are advanced over 80% with the INS on. <div style="text-align: center;">  </div> <p>Even if PARK BRAKE caution is extinguished in flight, the possibility exists that the parking brake may still be engaged.</p>	<p>GROUND</p> <ol style="list-style-type: none"> 1. PARK BRK handle - RELEASE <p>IN FLIGHT</p> <ol style="list-style-type: none"> 1. PARK BRK handle - CYCLE AND CHECK FULLY STOWED <p>Whether or not the caution clears -</p> <ol style="list-style-type: none"> 2. Make a fly-in arrested landing with LSO assistance (if available).
L PITOT HT R PITOT HT	<ul style="list-style-type: none"> • Designated pitot heater malfunction. 	<ol style="list-style-type: none"> 1. PITOT ANTI ICE switch - ON <p>After landing -</p> <ol style="list-style-type: none"> 2. PITOT ANTI ICE switch - AUTO
POS/ADC	<ul style="list-style-type: none"> • EGI, GPS and INS velocity or GPS and INS unreliable. <p>Position keeping function supplied by ADC, however the position keeping function is unreliable. POS/ADC is not as reliable a position keeping source as the INS or GPS.</p>	<ol style="list-style-type: none"> 1. Verify selected TCN information is loaded in TCN Data Table on HSI/DATA/TCN page. 2. Position keeping - SELECT POS/TCN
PROBE UNLK	<ul style="list-style-type: none"> • Air refueling probe not fully retracted with PROBE switch in RETRACT. 	<ol style="list-style-type: none"> 1. Airspeed - Maintain below 300 knots 2. PROBE switch - CYCLE
RACK UNCPL	<ul style="list-style-type: none"> • BRU-32 rack(s) failed to lock or unlock during rack test. <p>Store may not be jettisonable.</p>	<p>GROUND</p> <ol style="list-style-type: none"> 1. Do not takeoff.
R-LIM OFF	<ul style="list-style-type: none"> • Roll rate limiting failed. 	<ol style="list-style-type: none"> 1. Use no more than 1/2 lateral stick with tanks or A/G stores on the wings.
FIRE EXTGH <div style="border: 1px solid black; padding: 2px; display: inline-block;">READY</div> Light	<ul style="list-style-type: none"> • Fire extinguisher bottle armed. (FIRE light or APU FIRE light depressed.) 	<p>If FIRE light unintentionally pressed -</p> <ol style="list-style-type: none"> 1. Identify affected light. 2. FIRE light - RESET
S/W CONFIG	<ul style="list-style-type: none"> • Software incompatible. <p>Incompatible software is lined-out on the BIT/CONFIG page.</p>	<ol style="list-style-type: none"> 1. BIT/CONFIG page - Identify lined out system. 2. Turn on affected system if not already on. 3. IBIT affected system. <p>If caution remains -</p> <ol style="list-style-type: none"> 4. Do not takeoff.

Figure 12-1. Warning/Caution/Advisory Displays (Sheet 22)

* Immediate action item
 ☆ Discussion in part V

DDI Cautions and Caution Lights

INDICATOR	CAUSE/REMARKS	CORRECTIVE ACTION
■ L STALL R STALL "Engine left (right), Engine left (right)"	<ul style="list-style-type: none"> • Engine stall detected on designated side. Engine stalls result from conditions which exceed the stall margin of the engine (high AOA, steam or exhaust ingestion, etc.). Engine stalls are often indicated by an audible bang, airframe vibration, and visible flames out the exhaust and/or inlet. Pop or surge stalls do not result in L or R STALL caution and usually self-recover. Multiple pop or surge stalls indicate the engine may not self-recover and are usually the result of engine or aircraft damage. Hung stalls result in a L or R STALL caution and are indicated by a lack of throttle response, increasing EGT, and steady or decreasing rpm. If engine rpm continues to fall, the L or R FLAMEOUT caution may also be set.	<ul style="list-style-type: none"> * 1. Throttle affected engine - IDLE If stall does not clear - <ol style="list-style-type: none"> 2. Throttle affected engine - OFF 3. Refer to Single Engine Approach and Landing procedure. If stall clears - <ol style="list-style-type: none"> 2. Check engine response at a safe altitude. 3. Land as soon as practical.
■ TANK PRESS	GROUND <ul style="list-style-type: none"> • Internal fuel tank pressure high. Catapult may cause structural damage. IN FLIGHT <ul style="list-style-type: none"> • Internal fuel tank pressure low above 20,000 feet Possible fuel pump cavitation above 40,000 feet High rates of descent may damage fuel cells.	GROUND <ol style="list-style-type: none"> 1. Bleed air knob - OFF 2. Do not takeoff. IN FLIGHT <ol style="list-style-type: none"> 1. Bleed air knob - CYCLE If caution remains or reappears - <ol style="list-style-type: none"> 2. Do not exceed Mach 0.9 in dive.
■ TK PRES LO	IN FLIGHT <ul style="list-style-type: none"> • Internal fuel tank pressure low above 20,000 feet. Possible fuel pump cavitation above 40,000 feet High rates of descent may damage fuel cells	IN FLIGHT <ol style="list-style-type: none"> 1. BLEED AIR knob - CYCLE THRU OFF TO NORM If caution remains or reappears - <ol style="list-style-type: none"> 2. Do not exceed Mach 0.9 in dive. 3. Altitude - Maintain below 40,000 feet (if practical).
TK PRES HI	GROUND <ul style="list-style-type: none"> • Internal fuel tank pressurized. Catapult may cause structural damage. IN FLIGHT <ul style="list-style-type: none"> • Internal fuel tank pressure high. Possible exceedance of tank structural limits.	GROUND <ol style="list-style-type: none"> 1. BLEED AIR knob - OFF 2. Do not takeoff. IN FLIGHT <ol style="list-style-type: none"> 1. BLEED AIR knob - CYCLE THRU OFF TO NORM If caution remains or reappears - <ol style="list-style-type: none"> 2. Maintain 0 to + 2.5g.
VEL	<ul style="list-style-type: none"> • INS velocity degraded or high wind velocity. 	Information
■ VOICE/AUR	<ul style="list-style-type: none"> • Voice alert or master caution aural tone inoperative. EADI is unavailable if the cause is CSC failure.	<ol style="list-style-type: none"> 1. BIT page - CHECK CSC BIT status If CSC MUX fail - <ol style="list-style-type: none"> 2. Refer to CSC MUX FAILURE.

Figure 12-1. Warning/Caution/Advisory Displays (Sheet 23)

* Immediate action item
 ☆ Discussion in part V

DDI Cautions and Caution Lights



INDICATOR	CAUSE/REMARKS	CORRECTIVE ACTION
<p>WDSHLD HOT</p>	<ul style="list-style-type: none"> • Windshield temperature high or sensor failed. <p>If caution remains with the switch in OFF, an ECS valve failure may be directing hot air to the windshield. In this case, securing the ECS may be the only means to stop windshield airflow.</p> <div style="text-align: center;">  <p>WARNING</p> </div> <p>Under less than optimal conditions (low altitude, heavy breathing, loose fitting mask, etc.), as few as 3 minutes of emergency oxygen may be available.</p> <div style="text-align: center;">  <p>CAUTION</p> </div> <p>Do not operate the windshield anti-ice/rain removal system on a dry windshield. If a WDSHLD HOT caution appears, place the WINDSHIELD switch to OFF immediately to prevent heat damage to the windshield.</p>	<p>If visible moisture not present -</p> <ol style="list-style-type: none"> 1. WINDSHIELD switch -OFF <p>If visible moisture present (ice/rain) -</p> <ol style="list-style-type: none"> 1. WINDSHIELD switch - ANTI ICE or RAIN (use the windshield anti-ice for a maximum of 5 minutes) <p>If caution remains and switch OFF -</p> <ol style="list-style-type: none"> 2. Throttles - Minimum practical 3. Land as soon as practical. <p>Consider -</p> <p>In OBOGS equipped aircraft -</p> <ol style="list-style-type: none"> 3. Emergency oxygen green ring(s) - PULL 4. OXY FLOW knob(s) - OFF <p>All aircraft -</p> <ol style="list-style-type: none"> 5. Maintain altitude below 25,000 feet. 6. BLEED AIR knob - OFF (DO NOT CYCLE.) 7. Maintain airspeed below 325 KCAS (300 to 325 KCAS optimum). 8. ECS MODE switch - OFF/RAM 9. AV COOL switch - EMERG 10. EXT TANKS switch(es) - STOP <p>In OBOGS equipped aircraft -</p> <ol style="list-style-type: none"> 11. Maintain altitude below 10,000 ft prior to emergency oxygen depletion (10-20 minutes). <p>Once below 10,000 feet -</p> <ol style="list-style-type: none"> 12. Consider removing mask and resetting emergency oxygen. 13. CABIN PRESS switch - RAM/DUMP 14. OBOGS control switch - OFF <p>All aircraft -</p> <p>If AV AIR HOT caution appears -</p> <ol style="list-style-type: none"> 15. Non-essential avionics equipment - OFF (e.g., RADAR, UFC controlled avionics, ECM, sensors, MC2) 16. Land as soon as possible.
<p>WING UNLK</p>	<ul style="list-style-type: none"> • Either wingfold unlocked. 	<p>If caution appears while in flight -</p> <ol style="list-style-type: none"> 1. Wingfold handle - Push in to confirm fully seated. 2. Wingfold unlock flag (Beer Cans) - CHECK DOWN 3. Land as soon as practical. <p>FOR LANDING</p> <p>If both beer cans down -</p> <ol style="list-style-type: none"> 4. Make a normal landing. <p>If beer can(s) are up -</p> <ol style="list-style-type: none"> 5. Make an arrested landing (if practical).

Figure 12-1. Warning/Caution/Advisory Displays (Sheet 24)

* Immediate action item
 ☆ Discussion in part V

FCS Cautions

INDICATOR	CAUSE/REMARKS	CORRECTIVE ACTION
<p>AIL OFF</p> <p>FCS</p> <p>FCES</p> <p>Caution Light</p> <p>"Flight Controls, Flight Controls"</p>	<ul style="list-style-type: none"> • Aileron failures may be caused by an actuator failure (mechanical or two channel failure) or by a switching valve failing to switch to the backup circuit following a HYD circuit failure. <p>When an aileron fails, the surface is driven to the faired position by air loads and is damped to prevent oscillations. If the ailerons were drooped, the functional aileron is driven to the undrooped position. With both ailerons undrooped, approach speed will increase about 8 knots in flaps FULL, and 16 knots in flaps HALF. The functional aileron continues to assist in providing control. Roll damping is noticeably less. Use care to prevent overcontrol and resulting lateral PIO, especially when approaching touchdown.</p>	<p>1. Execute Controllability Check procedure.</p> <p>FOR LANDING</p> <ol style="list-style-type: none"> 2. FLAP switch - HALF or FULL 3. Fly a straight-in approach (if practical). 4. Fly on-speed AOA to touchdown.
<p>DEL ON</p> <p>FCS</p> <p>FCES</p> <p>Caution Light</p> <p>"Flight Controls, Flight Controls"</p>	<ul style="list-style-type: none"> • Any axis in DEL. <p>☆ Refer to DEL ON Caution.</p>	<ol style="list-style-type: none"> *1. Speedbrake - CHECK IN *2. Decelerate slowly to below 400 knots/Mach 0.8. 3. If flaps full - RAISE TO HALF 4. Do not exceed +15° AOA (+12° AOA with asymmetric wing stores). 5. MENU FCS - IDENTIFY FAILURE <p>If reset to CAS desired -</p> <ol style="list-style-type: none"> 6. Climb to a safe altitude. 7. Airspeed: 160-180 KNOTS - flaps HALF 200-300 KNOTS - flaps AUTO 8. FCS - RESET <p>If RESET unsuccessful/not desired -</p> <ol style="list-style-type: none"> 9. Execute Controllability Check procedure. (Do not exceed Flaps-HALF.) <p>If pitch axis in DEL -</p> <ol style="list-style-type: none"> 6. Do not extend speedbrake (unless required). 7. Flaps - HALF FOR LANDING 8. Fly ON-SPEED AOA. 9. Reduce sink rate for field landings. <p>If yaw and/or roll axis in DEL -</p> <ol style="list-style-type: none"> 6. External stores - JETTISON ASYMMETRIC WING STORES 7. Rudder - MINIMIZE INPUTS, IF REQUIRED USE SLOW INPUTS 8. Do not use more than 1/2 rudder pedal or lateral stick in flight. 9. Flaps - HALF FOR LANDING 10. Fly ON-SPEED AOA. 11. Reduce sink rate for landing.

Figure 12-1. Warning/Caution/Advisory Displays (Sheet 25)

* Immediate action item
 ☆ Discussion in part V

FCS Cautions

INDICATOR	CAUSE/REMARKS	CORRECTIVE ACTION																				
FC AIR DAT	<ul style="list-style-type: none"> • L & R pitot static probes disagree. • Both air data sensor inputs are within an acceptable range, but differ excessively. <div style="text-align: center; border: 2px solid black; padding: 5px; width: fit-content; margin: 10px auto;"> WARNING </div> <p>Bolters in GAIN ORIDE require more aft stick input for rotation. Half aft stick is recommended for rotation from bolters in GAIN ORIDE to reduce aircraft settle.</p> <div style="text-align: center; border: 2px solid black; padding: 5px; width: fit-content; margin: 10px auto;"> CAUTION </div> <p>Depending on the failure, the displayed airspeed in the HUD or the standby instruments may be unreliable. An airspeed crosscheck with AOA or with a wingman will be your best guide.</p> <p style="text-align: center;">NOTE</p> <p>Alpha tone is disabled in GAIN ORIDE with FLAP switch HALF or FULL and amber FLAPS light will be lit.</p> <p>With GAIN ORIDE selected, longitudinal response is more sluggish as airspeed is reduced below the set value and is more sensitive as airspeed is increased above the set value. In the landing configuration the gains are set to values which permit landing with flaps HALF or FULL (137 KCAS and 7.6° AOA). Remain below 200 knots and 15° AOA in HALF and below 160 knots and 12° AOA in FULL. At lower airspeed, aircraft response is sluggish and takes longer to stabilize.</p> <table border="1" style="width: 100%; border-collapse: collapse; margin-top: 10px;"> <thead> <tr> <th>Flaps</th> <th>Mach</th> <th>KCAS</th> <th>Feet</th> <th>° AOA</th> </tr> </thead> <tbody> <tr> <td>AUTO</td> <td>0.72</td> <td>n/a</td> <td>35,000</td> <td>2.0</td> </tr> <tr> <td>HALF</td> <td>n/a</td> <td>137</td> <td>sea level</td> <td>7.6</td> </tr> <tr> <td>FULL</td> <td>n/a</td> <td>137</td> <td>sea level</td> <td>7.6</td> </tr> </tbody> </table>	Flaps	Mach	KCAS	Feet	° AOA	AUTO	0.72	n/a	35,000	2.0	HALF	n/a	137	sea level	7.6	FULL	n/a	137	sea level	7.6	<p style="text-align: center;">HUD OR STBY AIRSPEED MAY BE UNRELIABLE</p> <ol style="list-style-type: none"> 1. Maintain below 350 knots, minimum sideslips, AOA <10°, maximum 2g. 2. GAIN switch - ORIDE <p>FOR LANDING</p> <ol style="list-style-type: none"> 3. Slow to 200 KCAS. <p>In straight and level flight (if possible) -</p> <ol style="list-style-type: none"> 4. LDG GEAR handle - DN 5. FLAP switch - HALF OR FULL 6. Fly a straight-in approach (if practical). 7. Fly on-speed AOA to touchdown. (ATC is not available.)
Flaps	Mach	KCAS	Feet	° AOA																		
AUTO	0.72	n/a	35,000	2.0																		
HALF	n/a	137	sea level	7.6																		
FULL	n/a	137	sea level	7.6																		

Figure 12-1. Warning/Caution/Advisory Displays (Sheet 26)

* Immediate action item
 ☆ Discussion in part V

FCS Cautions

INDICATOR	CAUSE/REMARKS	CORRECTIVE ACTION
<p>FCES Caution Light With MC1 inoperative</p>	<p>• If MC1 is inoperative, the FCES caution light is the only indication of a FCES failure. The FCS page is not available.</p> <p>If the FCES light remains on after an FCS RESET attempt, an actuator is still failed or one of the following cautions did not reset: FLAP SCHED, FLAPS OFF, AIL OFF, RUD OFF, MECH ON, or DEL ON.</p> <p style="text-align: center;">WARNING</p> <p>Exceeding GAIN ORIDE airspeed limitations of 350 KCAS (flaps AUTO), 200 KCAS (flaps HALF), or 190 KCAS (flaps FULL) may result in an uncontrollable aircraft.</p> <p style="text-align: center;">NOTE</p> <p>The FCES light illuminates whenever an FCS, FLAP SCHED, AIL OFF, RUD OFF, FLAPS OFF, MECH ON, or DEL ON caution is set.</p> <p>☆ Refer to FCS Failure.</p>	<ol style="list-style-type: none"> Speedbrake - CHECK IN Airspeed: 250-300 knots Maintain a safe altitude in VMC - <ul style="list-style-type: none"> - At or Above 5,000 ft AGL (if practical) - 15,000 ft AGL recommended Do not exceed +10° AOA. Attempt to identify the FCS failure. <p>If failure identified -</p> <ol style="list-style-type: none"> Execute the appropriate procedure. <p>If failure not identified and DDI warnings and FCS cautions still inoperative -</p> <ol style="list-style-type: none"> GAIN switch - ORIDE Slow below 180 KCAS at a safe altitude. LDG GEAR handle - DN FLAP switch - HALF Fly a straight-in approach (if practical). Fly on-speed AOA to touchdown. (ATC is not available in GAIN ORIDE.) Make a precautionary short field arrestment (if required).
<p>FCS FCES Caution Light "Flight Controls, Flight Controls"</p>	<p>• One or more failures in flight controls.</p> <p>"Like" failures for STAB and TEF are defined as Xs in 2 or more channels of the same row for the same surface.</p> <p>"Like" failure for any other item on the FCS page is defined as an X in the same row.</p> <p>• May be a result of AOA failures.</p> <p>If Xs are present in CH 1/3 of the PROC row the FCC has declared INS data invalid. There is no significant degradation to flying qualities, departure resistance or roll performance with these failure indications.</p> <p>☆ Refer to FCS Failure Indicators and Effects. ☆ Refer to FCS Failure. ☆ Refer to Uncommanded Pitch and Roll Excursions.</p>	<ol style="list-style-type: none"> MENU FCS - IDENTIFY FAILURE FCS - RESET <p>If no reset and only second "like" failure is PROC Xs in CH 1/3 -</p> <ol style="list-style-type: none"> No action required. <p>If no reset and second "like" failure exists -</p> <ol style="list-style-type: none"> Maintain 200-300 knots, minimum sideslip, AOA <10°, 2g maximum. FCS circuit breakers - CHECK If CG aft of 24% or lateral asymmetry over 12,000 foot-pounds, jettison external stores as soon as practical. Execute Controllability Check procedure. Land as soon as practical. If 4-channel AOA failure - execute the FLAPS SCHED procedure.
<p>FCS HOT FCS HOT Caution Light "Flight Computer Hot, Flight Computer Hot"</p>	<p>• Flight control computer A or right transformer-rectifier overtemperature.</p> <p>FCS airspeed cannot be closed in flight.</p>	<ol style="list-style-type: none"> Airspeed - SUBSONIC AV/FCS cool switch - EMERG

Figure 12-1. Warning/Caution/Advisory Displays (Sheet 27)

* Immediate action item
 ☆ Discussion in part V

FCS Cautions

INDICATOR	CAUSE/REMARKS	CORRECTIVE ACTION
<p>FLAPS OFF</p> <p>FCES</p> <p>Caution Light</p> <p>FLAPS</p> <p>Amber</p> <p>"Flight Controls, Flight Controls"</p>	<ul style="list-style-type: none"> Leading and/or trailing edge flaps inoperative. <p>When a LEF is shutdown, the opposite LEF and both TEF surfaces are held frozen with Flaps-AUTO.</p> <p>When a TEF is shutdown, the failed actuator will be hydraulic driven to 0°.</p> <p style="text-align: center;">WARNING</p> <ul style="list-style-type: none"> Leading-edge up deflections of the inboard LEF beyond the 4° over-travel stop may result in an uncontrollable configuration below 250 KCAS. Selecting GAIN ORIDE with flaps AUTO may provide controllability at slower airspeeds. There may be little warning of impending departure as airspeed decreases. Immediate ejection may be required. Departure will be unrecoverable. Exceeding GAIN ORIDE airspeed limitations of 350 KCAS (flaps AUTO), 200 KCAS (flaps HALF), or 190 KCAS (flaps FULL) may result in an uncontrollable aircraft. <p style="text-align: center;">CAUTION</p> <p>If a HYD 1B and the left leading edge flap fail or a HYD 2A and the right leading edge flap fail together, do not press the FCS RESET button. Resetting the FCS with one of the above combinations may result in a second hydraulic circuit failure.</p> <p>Pressing FCS RESET with failed leading edge flaps may aggravate a split LEF condition.</p> <p>Selecting GAIN ORIDE will drive non-failed flaps to their respective Gain Oride positions: - In AUTO: LEFs 3°, TEFs 3° - In HALF: LEFs 17°, TEFs 30° - In FULL: LEFs 17°, TEFs 45°</p> <p>Depending on the position of the failed LEF, selecting GAIN ORIDE may aggravate or reduce a LEF left/right split condition.</p>	<p>LEF procedures are dictated by LEF INBOARD position only (irrespective of outboard position).</p> <ul style="list-style-type: none"> *1. Maintain airspeed above 300 KCAS and wings level. 2. Visually check LEF deflections. <p>If inboard LEF deflection extreme leading edge up or appear nearly vertical (beyond 4° up over-travel stop) -</p> <ul style="list-style-type: none"> 3. Flaps - maintain AUTO 4. Maintain below 350 KCAS, minimize sideslip, AOA < 10°, maximum 2g. 5. GAIN switch - ORIDE 6. Execute Controllability Check procedure at safe altitude, maintaining flaps AUTO and GAIN ORIDE for remainder of flight. 7. Minimize gross weight to the maximum extent possible. <p>If inboard LEFs deflected less than 4° up -</p> <ul style="list-style-type: none"> 3. Do not exceed 10° AOA with flaps AUTO. 4. Execute Controllability Check procedure. (Do not exceed flaps - HALF) 5. Flaps - HALF FOR LANDING 6. If LEF extension less than 10° down, do not exceed 7° AOA for landing. <p>If hydraulic failure or leak suspected -</p> <ul style="list-style-type: none"> 7. Do not press FCS reset button if HYD 1B or HYD 2A caution is displayed. <p>If trailing edge flaps failed -</p> <ul style="list-style-type: none"> 3. Execute Controllability Check procedure at safe altitude. 4. Flaps - FULL or HALF FOR LANDING 5. Use 10° - 11° AOA for landing, if required.

Figure 12-1. Warning/Caution/Advisory Displays (Sheet 28)

* Immediate action item
 ☆ Discussion in part V

FCS Cautions

INDICATOR	CAUSE/REMARKS	CORRECTIVE ACTION
<p>FLAP SCHED</p> <p>FCES</p> <p>Caution Light</p> <p>FLAPS</p> <p>Amber</p> <p>"Flight Controls, Flight Controls"</p>	<ul style="list-style-type: none"> Flaps frozen and not scheduling properly (air data) or leading edge flap at least 10° off schedule and AOA over 12°. <p style="text-align: center;">WARNING</p> <ul style="list-style-type: none"> Bolters in GAIN ORIDE require more aft stick input for rotation due to fixed AOA feedback and zero rudder toe-in deflections. Half-aft stick is recommended for rotation from bolters in GAIN ORIDE to reduce aircraft settle. Exceeding GAIN ORIDE airspeed limitations of 350 KCAS (flaps AUTO), 200 KCAS (flaps HALF), or 190 KCAS (flaps FULL) may result in an uncontrollable aircraft. <p style="text-align: center;">NOTE</p> <p>Alpha tone is disabled in GAIN ORIDE with FLAP switch HALF or FULL.</p>	<ol style="list-style-type: none"> Maintain below 350 KCAS, minimum sideslips, AOA <10°, maximum 2g. GAIN switch - ORIDE <p>If 4-channel AOA failure -</p> <ol style="list-style-type: none"> Identify and select valid AOA probe on FCS page, using center (INS) AOA value as guide. <p>For landing -</p> <ol style="list-style-type: none"> Slow to 200 KCAS. <p>In straight and level flight (if possible) -</p> <ol style="list-style-type: none"> LDG GEAR handle - DN FLAP switch - HALF or FULL Fly a straight-in approach (if practical). Fly on-speed AOA to touchdown. (ATC is not available.)
<p>MECH ON</p> <p>FCES</p> <p>Caution Light</p> <p>"Flight Controls, Flight Controls"</p>	<ul style="list-style-type: none"> Stabilator has reverted to mechanical control. <p>If aircraft experiences recurrences of MECH reversions, do not continue to reset the FCS. ☆ Refer to MECH ON Caution.</p> <p style="text-align: center;">WARNING</p> <p>Resetting the FCS while in MECH may result in large pitch-up or pitch-down transients.</p>	<ol style="list-style-type: none"> Speedbrake - CHECK IN Decelerate slowly to below 400 knots/Mach 0.8. If flaps full - RAISE TO HALF Do not exceed 250 knots with flaps HALF. Do not exceed +15° AOA (+12° AOA with asymmetric wing stores). MENU FCS - IDENTIFY FAILURE <p>If reset to CAS is desired -</p> <ol style="list-style-type: none"> Climb to a safe altitude. Airspeed: 160-180 knots - flaps HALF 200-300 knots - flaps AUTO FCS - RESET Takeoff trim - PUSH (recenters stick) <p>If RESET unsuccessful/not desired -</p> <ol style="list-style-type: none"> Fly ON-SPEED AOA. Execute Controllability Check procedure. (Do not exceed flaps - HALF.) Short field arrestment recommended. Reduce sink rate for field landing. <p>If RESET unsuccessful/not desired and AIL/RUD OFF -</p> <ol style="list-style-type: none"> Wing stores - JETTISON Execute Controllability Check procedure. (Do not exceed flaps HALF.) If controllability permits landing - Short Field Arrestment recommended Reduce sink rate for field landings.

Figure 12-1. Warning/Caution/Advisory Displays (Sheet 29)

* Immediate action item
 ☆ Discussion in part V

FCS Cautions

INDICATOR	CAUSE/REMARKS	CORRECTIVE ACTION
NWS	<ul style="list-style-type: none"> • Steady (on DDI) - Nosewheel steering inoperative. <p>Emergency high gain nosewheel steering is available after an FCS channel 2 or 4 failure. The NWS remains engaged in the high gain mode after the NWS button is released. The emergency mode can be disengaged by pressing the paddle switch. The emergency mode should be engaged only for low speed taxi. Emergency HI gain operation prevents detection of NWS command failures so be alert for uncommanded steering. Press the paddle switch immediately upon detection of uncommanded steering.</p> <p style="text-align: center;">NOTE</p> <p>If pressing the NWS button results in an FCS caution and single X in the powered channel, emergency HI gain steering is not available.</p>	<p>GROUND</p> <p>If required, emergency HI gain nosewheel steering available on aircraft LOT 5 AND UP with failed channel (2 or 4) -</p> <ol style="list-style-type: none"> 1. Failed channel circuit breaker - PULL 2. Wings - CHECK UNLOCKED 3. NWS button - PRESS <p>If pressing the NWS button results in an FCS caution and single X in the powered channel, emergency HI gain steering is not available.</p> <p>IN FLIGHT</p> <ol style="list-style-type: none"> 1. Consider a precautionary arrested landing (if available).

Figure 12-1. Warning/Caution/Advisory Displays (Sheet 30)

* Immediate action item
 ☆ Discussion in part V

FCS Cautions

INDICATOR	CAUSE/REMARKS	CORRECTIVE ACTION
<p>RUD OFF</p> <p>FCES</p> <p>Caution Light</p> <p>“Flight Controls, Flight Controls”</p>	<ul style="list-style-type: none"> • One or both rudders inoperative. <p>Rudder failures may be caused by an actuator failure (mechanical or two channel failure) or by a switching valve failing to switch to the backup circuit following a HYD circuit failure. (The autopilot, and rudder toe/flare are inoperative.)</p> <p>Following a rudder actuator failure, the surface is driven to a faired position by air loads and is damped to prevent oscillations. With one rudder failed, the rolling surface to rudder interconnect (RSRI) may not have sufficient rudder authority to coordinate lateral stick inputs. Countering a rolloff with lateral stick alone increases adverse yaw and aggravates the rolloff. The only way to ensure balanced flight is to minimize sideslip by the early and proper use of the operating rudder.</p> <p>If a dual channel rudder actuator failure is reset, the failure could be triggered again and reappear with severe yaw, roll and pitch transients during critical flight phase(s). Transients occurring close to the ground could be unrecoverable. During the takeoff and landing phases, any ejection decision should be made early.</p> <p>Once configured for landing, maintain on-speed and balanced flight.</p> <p>Failure to maintain AOA below 10° and balanced flight may result in a departure in yaw and roll that is unrecoverable, even with full opposite rudder and stick. Because of the rate at which AOA and sideslip buildup can occur in this configuration, the safe ejection envelope can be rapidly exceeded during the takeoff and landing phases.</p> <p>If single engine, departure is probable with the use of afterburner.</p> <p>Lineup control is degraded with left or right rudder failed. Ensure all lineup corrections are performed slowly and smoothly.</p> <p>Minimize large, rapid throttle inputs. If single engine, large throttle transients will cause significant yaw and roll, making heading control difficult.</p> <p>Rudder toe-in or out will not be available for takeoff or landing. Due to a lack of rudder toe-in, bolter performance may be degraded. The autopilot will be inoperative.</p>	<ol style="list-style-type: none"> 1. Execute Controllability Check procedure. (Do not exceed flaps - HALF.) 2. DO NOT RESET if flying qualities are acceptable for a safe recovery. <p>FOR LANDING</p> <ol style="list-style-type: none"> 3. FLAP switch - HALF 4. Perform a straight-in approach (if practical). 5. Fly on-speed AOA to touchdown. (DO NOT EXCEED ON-SPEED AOA.)

Figure 12-1. Warning/Caution/Advisory Displays (Sheet 31)

* Immediate action item
 ☆ Discussion in part V

HYD Cautions

INDICATOR	CAUSE/REMARKS	CORRECTIVE ACTION
HYD 1A	<ul style="list-style-type: none"> • HYD circuit 1A pressure low (<1,500 psi). <p>HYD 1A is the first circuit turned off during RLS operation. If caution remains without HYD 1B, the leak was successfully isolated in HYD 1A.</p> <p>Right AIL Xs will occur if switching valve is slow/fails to switch.</p> <ul style="list-style-type: none"> • Aileron automatically recovers when hydraulic pressure restored. 	<ol style="list-style-type: none"> 1. Airspeed - Maintain below 350 KCAS 2. Land as soon as practical. <p>If right AIL Xs -</p> <ol style="list-style-type: none"> 3. Read remarks for AIL Xs. 4. Execute Controllability Check procedure. <ul style="list-style-type: none"> • Flaps HALF or FULL • DO NOT EXCEED ON-SPEED AOA. <p>If no Xs -</p> <ol style="list-style-type: none"> 3. Fly a straight-in approach.
HYD 1B	<ul style="list-style-type: none"> • HYD circuit 1B pressure low (<1,500 psi). <p>HYD 1B is the second circuit turned off during RLS operation. If caution remains without HYD 1A, the leak was successfully isolated in HYD 1B.</p> <p>Right RUD and/or left LEF Xs will occur if switching valve is slow/fails to switch.</p> <ul style="list-style-type: none"> • With left LEF Xs, DO NOT RESET FCS. If flaps are reset, a HYD 2A failure may result. • Rudder automatically recovers when hydraulic pressure restored. <p>If practical, maintain right engine at or above 85 % rpm to preclude MECH reversion.</p>	<p>If LEF Xs -</p> <ol style="list-style-type: none"> 1. DO NOT RESET FCS. <p>In all cases -</p> <ol style="list-style-type: none"> 2. Airspeed - Maintain below 350 KCAS 3. Land as soon as practical. <p>If right RUD and/or left LEF Xs -</p> <ol style="list-style-type: none"> 4. Read remarks for RUD and/or LEF Xs. 5. Execute Controllability Check procedure. <ul style="list-style-type: none"> • Flaps HALF • DO NOT EXCEED ON-SPEED AOA, or 7° AOA if LEF extension less than 10°. <p>If no Xs -</p> <ol style="list-style-type: none"> 4. Fly a straight-in approach.

Figure 12-1. Warning/Caution/Advisory Displays (Sheet 32)

* Immediate action item
 ☆ Discussion in part V

HYD Cautions

INDICATOR	CAUSE/REMARKS	CORRECTIVE ACTION
<p>HYD 2A</p>	<ul style="list-style-type: none"> • HYD circuit 2A pressure low (<1,500 psi). <p>HYD 2A is the first circuit turned off during RLS operation. If caution remains without HYD 2B, the leak was successfully isolated in HYD 2A.</p> <p>With HYD 2A failed:</p> <ul style="list-style-type: none"> • No landing gear retraction/normal extension • No normal NWS (flashing NWS in HUD) • No normal braking • No anti-skid • No probe retraction/normal extension • No launch bar extension • No gun • No hook retraction • No speedbrake <p>Right LEF Xs will occur if switching valve is slow/fails to switch.</p> <ul style="list-style-type: none"> • With right LEF Xs, DO NOT RESET FCS. If flaps are reset, a HYD 1B failure may result. 	<p>If LEF Xs -</p> <ol style="list-style-type: none"> 1. DO NOT RESET FCS. <p>In all cases -</p> <ol style="list-style-type: none"> 2. Airspeed - Maintain below 350 KCAS 3. Land as soon as practical. 4. PROBE switch - EMERG EXTND (if required) <p>If right LEF Xs -</p> <ol style="list-style-type: none"> 5. Read remarks for LEF Xs. 6. Execute Controllability Check procedure. <ul style="list-style-type: none"> • Flaps HALF • DO NOT EXCEED ON-SPEED AOA, or 7° AOA if LEF extension less than 10°. <p>If no Xs -</p> <ol style="list-style-type: none"> 5. Consider Select Jettison unwanted stores prior to gear extension. 6. Execute Landing Gear Emergency Extension procedure. <p>FOR LANDING</p> <ol style="list-style-type: none"> 1. Fly a straight-in approach. 2. Make an arrested landing (if practical). <p>If arrested landing not practical -</p> <ol style="list-style-type: none"> 3. Use emergency brakes with steady brake pressure (DO NOT PUMP). Anti-skid is not available. 4. Consider paddle switch - PRESS after touch-down to preserve APU ACCUM pressure for slow speed NWS. <p>Once stopped on runway -</p> <ol style="list-style-type: none"> 5. Do not taxi (even if HYD 2A caution is removed).

Figure 12-1. Warning/Caution/Advisory Displays (Sheet 33)

* Immediate action item
 ☆ Discussion in part V

HYD Cautions

INDICATOR	CAUSE/REMARKS	CORRECTIVE ACTION
HYD 2B	<ul style="list-style-type: none"> • HYD circuit 2B pressure low (<1,500 psi). <p>HYD 2B is the second circuit turned off during RLS operation. If caution remains without HYD 2A, the leak was successfully isolated in HYD 2B.</p> <p>Left AIL and/or left RUD Xs will occur if switching valve is slow/fails to switch.</p> <ul style="list-style-type: none"> • Aileron and rudder automatically recover when hydraulic pressure restored. <p>If practical, maintain left engine at or above 85 % rpm to preclude MECH reversion.</p>	<ol style="list-style-type: none"> 1. Airspeed - Maintain below 350 KCAS 2. Land as soon as practical. <p>If left AIL and/or left RUD Xs -</p> <ol style="list-style-type: none"> 3. Read remarks for AIL and/or RUD Xs. 4. Execute Controllability Check procedure. <ul style="list-style-type: none"> • Flaps HALF (Flaps FULL check acceptable if no RUD Xs) • DO NOT EXCEED ON-SPEED AOA. <p>If no Xs -</p> <ol style="list-style-type: none"> 3. Fly a straight-in approach.
HYD 1A HYD 1B	<ul style="list-style-type: none"> • Dual left HYD circuit failure (<1,500 psi). (a) Left HYD pump internal failure (needle NOT stabilized at zero). (b) HYD 1 leak which could not be isolated by RLS (preceded by RLS circuit caution sequencing). (c) Left HYD pump shaft shear (needle stabilized at zero). (d) Left power transmission shaft failure (accompanied by L GEN, L BOOST LO cautions). <p>Right AIL, right RUD, and/or left LEF Xs will occur if switching valve is slow/fails to switch.</p> <ul style="list-style-type: none"> • With left LEF Xs, DO NOT RESET FCS. If flaps are reset, a HYD 2A failure may result. • Aileron and rudder automatically recover when hydraulic pressure restored. <p>If practical, maintain right engine at or above 85 % rpm to preclude MECH reversion.</p> <div style="text-align: center;">  </div> <ul style="list-style-type: none"> • Prolonged use of a failed hydraulic pump without the pump shaft shearing as indicated by the needle not stabilized at zero will generate considerable heat and may result in an AMAD bay fire. Consider restarting the engine prior to landing. • Prolonged use of a hydraulic pump without hydraulic fluid as indicated by RLS circuit caution sequencing will generate considerable heat and may result in an AMAD bay fire. Consider restarting the engine prior to landing. • Failure of the PTS will result in the display of the associated GEN, BOOST LO and both HYD circuit cautions. If the shaft does not fail at the design shear point, it could be flailing. A flailing PTS could damage flammable fluid components in the engine bay which could result in an engine bay fire. Consideration should be given to shutting down the associated engine to minimize the risk of an engine bay fire. 	<ol style="list-style-type: none"> 1. Throttle LEFT engine - IDLE <p>If LEF Xs -</p> <ol style="list-style-type: none"> 2. DO NOT RESET FCS. <p>In all cases -</p> <ol style="list-style-type: none"> 3. Airspeed - Maintain below 350 KCAS 4. Land as soon as practical. <p>If HYD 1 needle NOT stabilized at zero OR</p> <p>If failure was preceded by RLS circuit caution sequencing -</p> <ol style="list-style-type: none"> 5. Throttle LEFT engine - OFF 6. Consider restart for landing (if required). <p>If right AIL, right RUD, and/or left LEF Xs -</p> <ol style="list-style-type: none"> 7. Read remarks for AIL, RUD and/or LEF Xs. 8. Execute Controllability Check procedure. <ul style="list-style-type: none"> • Flaps HALF (Flaps FULL check acceptable if no RUD or LEF Xs) • DO NOT EXCEED ON-SPEED AOA, or 7° AOA if LEF extension less than 10°. <p>FOR LANDING</p> <p>If single engine -</p> <ol style="list-style-type: none"> 1. Execute Single Engine Approach and Landing procedure. <p>If both engines running -</p> <ol style="list-style-type: none"> 1. FLAP switch - HALF (Flaps FULL acceptable if no RUD or LEF Xs) 2. Fly a straight-in approach.

Figure 12-1. Warning/Caution/Advisory Displays (Sheet 34)

HYD Cautions

INDICATOR	• CAUSE / REMARKS	CORRECTIVE ACTION
<p>HYD 1A HYD 2A</p>	<ul style="list-style-type: none"> • Dual HYD circuit failure (<1,500 psi). <p>Flight control surface affected:</p> <ul style="list-style-type: none"> • Right aileron lost (faired and damped) <p>With HYD 2A failed:</p> <ul style="list-style-type: none"> • No landing gear retraction/normal extension • No normal NWS (flashing NWS in HUD) • No normal braking • No anti-skid • No probe retraction/normal extension • No launch bar extension • No gun • No hook retraction • No speedbrake <p>Right LEF Xs will occur if switching valve is slow/fails to switch.</p> <ul style="list-style-type: none"> • With right LEF Xs, DO NOT RESET FCS. If flaps are re-set, a HYD 1B failure may result. <p>Remarks for any surface off:</p> <ul style="list-style-type: none"> • General Limits: <ul style="list-style-type: none"> • 10° AOA for flaps AUTO • On-speed AOA for flaps HALF/FULL • 2g max • Minimize sideslip • Half lateral stick • Loss of autopilot <p>Remarks for AIL Xs:</p> <ul style="list-style-type: none"> • Expect slightly higher approach speeds. For flaps FULL, approach speed will be increased by about 8 knots. Flaps HALF, 16 knots. • Avoid over-controlling lateral stick inputs as it can cause lateral PIO especially when approaching touchdown. 	<p>If LEF Xs -</p> <ol style="list-style-type: none"> 1. DO NOT RESET FCS. <p>In all cases -</p> <ol style="list-style-type: none"> 2. Airspeed - Maintain below 350 KCAS 3. Land as soon as practical. 4. PROBE switch - EMERG EXTD (if required) <p>If right LEF Xs -</p> <ol style="list-style-type: none"> 5. Read adjacent remarks for AIL Xs and remarks for LEF Xs. 6. Execute Controllability Check procedure. <ul style="list-style-type: none"> • Flaps HALF • DO NOT EXCEED ON-SPEED AOA, or 7° AOA if LEF extension less than 10°. <p>If only right AIL Xs -</p> <ol style="list-style-type: none"> 5. Read adjacent remarks for AIL Xs. 6. Execute Controllability Check procedure. <ul style="list-style-type: none"> • Flaps HALF or FULL • DO NOT EXCEED ON-SPEED AOA. <p>FOR LANDING</p> <ol style="list-style-type: none"> 1. Fly a straight-in approach. 2. Make an arrested landing (if practical). <p>If arrested landing not practical -</p> <ol style="list-style-type: none"> 3. Avoid longitudinal stick inputs during landing rollout (e.g., aerobraking). 4. Use emergency brakes with steady brake pressure (DO NOT PUMP). Anti-skid is not available. 5. Consider paddle switch - PRESS after touchdown to preserve APU ACCUM pressure for slow-speed NWS. <p>Once stopped on runway -</p> <ol style="list-style-type: none"> 6. Do not taxi (even if HYD 2A caution is removed).

Figure 12-1. Warning/Caution/Advisory Displays (Sheet 35)

HYD Cautions

INDICATOR	• CAUSE / REMARKS	CORRECTIVE ACTION
<p>HYD 1A HYD 2B</p>	<ul style="list-style-type: none"> Dual HYD circuit failure (<1,500 psi). <p>Flight control surfaces affected:</p> <ul style="list-style-type: none"> Both TEFs lost Left rudder lost (faired and damped) <p>Left and/or right AIL Xs will occur if switching valve is slow/fails to switch.</p> <ul style="list-style-type: none"> Aileron automatically recovers when hydraulic pressure restored. <p>If practical, maintain left engine at or above 85 % rpm to preclude MECH reversion.</p> <p>Remarks for any surface off:</p> <ul style="list-style-type: none"> General Limits: <ul style="list-style-type: none"> 10° AOA for flaps AUTO On-speed AOA for flaps HALF/FULL 2g max Minimize sideslip Half lateral stick Loss of autopilot <p>Remarks for TEF Xs:</p> <div style="border: 2px solid black; padding: 5px; text-align: center; width: fit-content; margin: 10px auto;">WARNING</div> <p>Slower engine response to throttle changes may result in excessive sink rates under high WOD conditions. The recovery WOD should be kept as close as possible to the Aircraft Recovery Bulletin recommendations.</p> <ul style="list-style-type: none"> TEF driven to 0°. Approach speeds are significantly higher and on-speed power settings are near idle. Expect slower engine response. Aircraft response to power corrections is sluggish and small in magnitude. Power corrections will translate into an air-speed change before a rate of descent change is noted. Expect larger, longer, and more anticipatory power corrections to be required in order to effect a glideslope change. Aggressive, well-timed, and anticipatory throttle inputs are key to glideslope control. There is a tendency to over-control power due to the low approach power setting and the longer time required to effect a change. Time to achieve positive rate of climb is longer during a bolter/waveoff due to sluggish throttle response. Climb-out attitude will appear flatter than normal. <p>Remarks for RUD Xs:</p> <div style="border: 2px solid black; padding: 5px; text-align: center; width: fit-content; margin: 10px auto;">WARNING</div> <ul style="list-style-type: none"> Full opposing rudder may not be sufficient to prevent a departure when single engine if MAX power selected. Large single engine throttle transients can cause significant yaw and roll. Failure to maintain AOA below 10° and balanced flight can result in a departure in yaw and roll that is unrecoverable. Rudder toe-in is removed. Bolter performance degraded. Counter any roll-off with rudder. Countering roll-off with lateral stick alone increases adverse yaw and aggravates roll-off. Line-up control is degraded. Make slow and smooth line-up corrections (especially if single engine). 	<p>High approach speeds will likely preclude CV landing. Divert if able.</p> <ol style="list-style-type: none"> Airspeed - Maintain below 300 KCAS AOA - MAINTAIN BELOW 10° Land as soon as practical. If AIL Xs, read remarks for AIL Xs. Read adjacent remarks for TEF and RUD Xs. Execute Controllability Check procedure. <ul style="list-style-type: none"> Flaps HALF DO NOT EXCEED ON-SPEED AOA. Adjust gross weight to the minimum practical. <p>FOR LANDING</p> <ol style="list-style-type: none"> FLAP switch - HALF Fly a straight-in approach. Make an arrested landing (if practical). <p>If arrested landing not practical -</p> <ol style="list-style-type: none"> Avoid longitudinal stick inputs during landing rollout (e.g., aerobraking).

Figure 12-1. Warning/Caution/Advisory Displays (Sheet 36)

HYD Cautions



INDICATOR	• CAUSE / REMARKS	CORRECTIVE ACTION
<p>HYD 1B HYD 2A</p>	<ul style="list-style-type: none"> • Dual HYD circuit failure (<1,500 psi). <p>Flight control surfaces affected:</p> <ul style="list-style-type: none"> • Both LEFs frozen • Right rudder lost (faired and damped) • TEFs held frozen in flaps AUTO <p>With HYD 2A failed:</p> <ul style="list-style-type: none"> • No landing gear retraction/normal extension • No normal NWS (flashing NWS in HUD) • No normal braking • No anti-skid • No probe retraction/normal extension • No launch bar extension • No gun • No hook retraction • No speedbrake <p>If practical, maintain right engine at or above 85% rpm to preclude MECH reversion.</p> <p>Remarks for any surface off:</p> <ul style="list-style-type: none"> • General Limits: <ul style="list-style-type: none"> • 10° AOA for flaps AUTO • On-speed AOA for flaps HALF/FULL • 2g max • Minimize sideslip • Half lateral stick • Loss of autopilot <p>Remarks for LEF Xs -</p> <div style="text-align: center;">  <p>CAUTION</p> </div> <p>Do not exceed 7° AOA if LEF extension less than 10°.</p> <ul style="list-style-type: none"> • Opposite LEF held frozen. TEFs held frozen in flaps AUTO. • Stall margin reduced for LEF locked above 5° LED. • Buffet likely with LEF near 0° at lower AOA. • Expect slight roll-off as airspeed changes during a waveoff or bolter that is easily controllable. • Glideslope control degradations may be more pronounced depending on frozen LEF position. Wing stores will further degrade glideslope control. • Power corrections will translate into an airspeed change before a rate of descent change is noticed. This may lead to a tendency to over-control glideslope. Anticipatory throttle inputs are key to glideslope control. • Bolter/waveoff performance is degraded and climb-out attitude will appear flatter than normal. • If AUTO is selected after being in flaps HALF or FULL, the TEFs will not retract except for loads alleviation (no higher than 17°). While in AUTO, momentary selection of GAIN ORIDE will command the TEFs to retract to 3° TED. However, the operating LEF will also be commanded to move to 3° LED. This may drive a controllable but undesirable left versus right LEF split if the failed LEF is not near 3° LED. Therefore, only select GAIN ORIDE if TEF retraction is essential for range or fuel considerations. <p>Remarks for RUD Xs -</p> <div style="text-align: center;">  <p>WARNING</p> </div> <ul style="list-style-type: none"> • Full opposing rudder may not be sufficient to prevent a departure when single engine if MAX power selected. Large single engine throttle transients can cause significant yaw and roll. • Failure to maintain AOA below 10° and balanced flight can result in a departure in yaw and roll that is unrecoverable. • Rudder toe-in is removed. Bolter performance degraded. • Counter any roll-off with rudder. Countering roll-off with lateral stick alone increases adverse yaw and aggravates roll-off. • Line-up control is degraded. Make slow and smooth line-up corrections (especially if single engine). 	<p>1. Airspeed - Maintain below 300 KCAS</p> <p>2. AOA - MAINTAIN BELOW 10°</p> <p>3. Land as soon as practical.</p> <p>4. PROBE switch - EMERG EXTND (if required)</p> <p>5. Read adjacent remarks for LEF and RUD Xs.</p> <p>6. Execute Controllability Check procedure.</p> <ul style="list-style-type: none"> • Flaps HALF • DO NOT EXCEED ON-SPEED AOA, or 7° AOA if LEF extension less than 10°. <p>FOR LANDING</p> <ol style="list-style-type: none"> 1. Fly a straight-in approach. 2. Make an arrested landing (if practical). <p>If arrested landing not practical -</p> <ol style="list-style-type: none"> 3. Avoid longitudinal stick inputs during landing rollout (e.g., aerobraking). 4. Use emergency brakes with steady brake pressure (DO NOT PUMP). Anti-skid is not available. 5. Consider paddle switch - PRESS after touch-down to preserve APU ACCUM pressure for slow speed NWS. <p>Once stopped on runway -</p> <ol style="list-style-type: none"> 6. Do not taxi (even if HYD 2A caution is removed).

Figure 12-1. Warning/Caution/Advisory Displays (Sheet 37)

HYD Cautions

INDICATOR	• CAUSE / REMARKS	CORRECTIVE ACTION
<p>HYD 1B HYD 2B</p>	<ul style="list-style-type: none"> • Dual HYD circuit failure (<1,500 psi). <p>Flight control surface affected:</p> <ul style="list-style-type: none"> • Left aileron lost (faired and damped) <p>Left LEF, left RUD/STAB (MECH reversion), and/or right RUD/STAB (MECH reversion) Xs will occur if switching valve is slow/fails to switch.</p> <ul style="list-style-type: none"> • With left LEF Xs, DO NOT RESET FCS. If flaps are reset, a HYD 2A failure may result. • Rudder automatically recovers when hydraulic pressure re-stored. <p>Remarks for any surface off:</p> <ul style="list-style-type: none"> • General Limits: <ul style="list-style-type: none"> • 10° AOA for flaps AUTO • On-speed AOA for flaps HALF/FULL • 2g max • Minimize sideslip • Half lateral stick • Loss of autopilot <p>Remarks for AIL Xs:</p> <ul style="list-style-type: none"> • Expect slightly higher approach speeds. For flaps FULL, approach speed will be increased by about 8 knots. Flaps HALF, 16 knots. • Avoid over-controlling lateral stick inputs as it can cause lateral PIO especially when approaching touchdown. 	<p>If LEF Xs -</p> <ol style="list-style-type: none"> 1. DO NOT RESET FCS. <p>In all cases -</p> <ol style="list-style-type: none"> 2. Airspeed - Maintain below 350 KCAS 3. Land as soon as practical. <p>If any RUD and/or LEF Xs -</p> <ol style="list-style-type: none"> 4. Read remarks for AIL and RUD and/or LEF Xs. 5. Execute Controllability Check procedure. <ul style="list-style-type: none"> • Flaps HALF • DO NOT EXCEED ON-SPEED AOA, or 7° AOA if LEF extension less than 10°. <p>If only left AIL Xs -</p> <ol style="list-style-type: none"> 4. Read adjacent remarks for AIL Xs. 5. Execute Controllability Check procedure. <ul style="list-style-type: none"> • Flaps HALF or FULL • DO NOT EXCEED ON-SPEED AOA. <p>FOR LANDING</p> <ol style="list-style-type: none"> 1. Fly a straight-in approach.

Figure 12-1. Warning/Caution/Advisory Displays (Sheet 38)

HYD Cautions

INDICATOR	• CAUSE / REMARKS	CORRECTIVE ACTION
<p>HYD 2A HYD 2B</p>	<ul style="list-style-type: none"> Dual right HYD circuit failure (<1,500 psi). <ul style="list-style-type: none"> (a) Right HYD pump internal failure (needle NOT stabilized at zero). (b) HYD 2 leak which could not be isolated by RLS (preceded by RLS circuit caution sequencing). (c) Right HYD pump shaft shear (needle stabilized at zero). (d) Right power transmission shaft failure (accompanied by R GEN, R BOOST LO cautions). <p>With HYD 2A failed:</p> <ul style="list-style-type: none"> No landing gear retraction/normal extension No normal NWS (flashing NWS in HUD) No normal braking No anti-skid No probe retraction/normal extension No launch bar extension No gun No hook retraction No speedbrake <p>Left AIL, left RUD, and/or right LEF Xs will occur if switching valve is slow/fails to switch.</p> <ul style="list-style-type: none"> With right LEF Xs, DO NOT RESET FCS. If flaps are reset, a HYD 1B failure may result. Aileron and rudder automatically recover when hydraulic pressure restored. <p>If practical, maintain left engine at or above 85 % rpm to preclude MECH reversion.</p> <div style="text-align: center;">  <p>CAUTION</p> </div> <ul style="list-style-type: none"> Prolonged use of a failed hydraulic pump without the pump shaft shearing as indicated by the needle not stabilized at zero will generate considerable heat and may result in an AMAD bay fire. Consider restarting the engine prior to landing. Prolonged use of a hydraulic pump without hydraulic fluid as indicated by RLS circuit caution sequencing will generate considerable heat and may result in an AMAD bay fire. Consider restarting the engine prior to landing. Failure of the PTS will result in the display of the associated GEN, BOOST LO and both HYD circuit cautions. If the shaft does not fail at the design shear point, it could be flailing. A flailing PTS could damage flammable fluid components in the engine bay which could result in an engine bay fire. Consideration should be given to shutting down the associated engine to minimize the risk of an engine bay fire. 	<ol style="list-style-type: none"> Throttle RIGHT engine - IDLE <p>If LEF Xs -</p> <ol style="list-style-type: none"> DO NOT RESET FCS. <p>In all cases -</p> <ol style="list-style-type: none"> Airspeed - Maintain below 350 KCAS Land as soon as practical. PROBE switch - EMERG EXT D (if required) <p>If HYD 2 needle NOT stabilized at zero OR</p> <p>If failure was preceded by RLS circuit caution sequencing -</p> <ol style="list-style-type: none"> Throttle RIGHT engine - OFF Consider restart for landing (if required). <p>If left AIL, left RUD, and/or right LEF Xs -</p> <ol style="list-style-type: none"> Read remarks for AIL, RUD, and/or LEF Xs. Execute Controllability Check procedure. <ul style="list-style-type: none"> Flaps HALF (Flaps FULL check acceptable if no RUD or LEF Xs) DO NOT EXCEED ON-SPEED AOA, or 7° AOA if LEF extension less than 10°. <p>If no Xs -</p> <ol style="list-style-type: none"> Consider Select Jettison unwanted stores prior to gear extension (if single engine, consider desired max gross landing weight). Execute Landing Gear Emergency Extension procedure. <ul style="list-style-type: none"> Flaps HALF if single engine <p>FOR LANDING</p> <p>If single engine -</p> <ol style="list-style-type: none"> Execute Single Engine Approach and Landing procedure. <p>If both engines running -</p> <ol style="list-style-type: none"> FLAP switch - HALF (Flaps FULL acceptable if no RUD or LEF Xs) Fly a straight-in approach. Make an arrested landing (if practical). <p>If arrested landing not practical -</p> <ol style="list-style-type: none"> Use emergency brakes with steady brake pressure (DO NOT PUMP). Anti-skid is not available. Consider paddle switch - PRESS after touch-down to preserve APU ACCUM pressure for slow speed NWS. <p>Once stopped on runway -</p> <ol style="list-style-type: none"> Do not taxi (even if HYD 2A caution is removed).

Figure 12-1. Warning/Caution/Advisory Displays (Sheet 39)

HYD Cautions

INDICATOR	• CAUSE / REMARKS	CORRECTIVE ACTION
<p>HYD 1A HYD 1B HYD 2A</p>	<ul style="list-style-type: none"> • Triple HYD circuit failure (<1,500 psi). <p>Flight control surfaces affected:</p> <ul style="list-style-type: none"> • Both LEFs frozen • Right aileron lost (faired and damped) • Right rudder lost (faired and damped) • TEFs held frozen in flaps AUTO <p>With HYD 2A failed:</p> <ul style="list-style-type: none"> • No landing gear retraction/normal extension • No normal NWS (flashing NWS in HUD) • No normal braking • No anti-skid • No probe retraction/normal extension • No launch bar extension • No gun • No hook retraction • No speedbrake <p>If practical, maintain right engine at or above 85 % rpm to preclude MECH reversion.</p> <p>Remarks for any surface off:</p> <ul style="list-style-type: none"> • General Limits: <ul style="list-style-type: none"> • 10° AOA for flaps AUTO • On-speed AOA for flaps HALF/FULL • 2g max • Minimize sideslip • Half lateral stick • Loss of autopilot <p>Remarks for LEF Xs:</p> <div style="text-align: center;">  <p>CAUTION</p> </div> <p>Do not exceed 7° AOA if LEF extension less than 10°.</p> <ul style="list-style-type: none"> • Opposite LEF held frozen. TEFs held frozen in flaps AUTO. • Stall margin reduced for LEF locked above 5° LED. • Buffet likely with LEF near 0° at lower AOA. • Expect slight roll-off as airspeed changes during a waveoff or bolter that is easily controllable. • Glideslope control degradations may be more pronounced depending on frozen LEF position. Wing stores will further degrade glideslope control. • Power corrections will translate into an airspeed change before a rate of descent change is noticed. This may lead to a tendency to over-control glideslope. Anticipatory throttle inputs are key to glideslope control. • Bolter/waveoff performance is degraded and climb-out attitude will appear flatter than normal. • If AUTO is selected after being in flaps HALF or FULL, the TEFs will not retract except for loads alleviation (no higher than 17°). While in AUTO, momentary selection of GAIN ORIDE will command the TEFs to retract to 3° TED. However, the operating LEF will also be commanded to move to 3° LED. This may drive a controllable but undesirable left versus right LEF split if the failed LEF is not near 3° LED. Therefore, only select GAIN ORIDE if TEF retraction is essential for range or fuel considerations. <p>Remarks for ALL Xs:</p> <ul style="list-style-type: none"> • Expect slightly higher approach speeds. For flaps FULL, approach speed will be increased by about 8 knots. Flaps HALF, 16 knots. • Avoid over-controlling lateral stick inputs as it can cause lateral PIO especially when approaching touchdown. <p style="text-align: center;">CONTINUED</p>	<ol style="list-style-type: none"> 1. Throttle LEFT engine - IDLE 2. Airspeed - Maintain below 300 KCAS 3. AOA - MAINTAIN BELOW 10° 4. Land as soon as possible. 5. PROBE switch - EMERG EXTND (if required) <p>If HYD 1 needle stabilized at zero OR</p> <p>If failure was NOT preceded by RLS circuit caution sequencing -</p> <ol style="list-style-type: none"> 6. DO NOT secure left engine. <p>If HYD 1 needle NOT stabilized at zero OR</p> <p>If failure was preceded by RLS circuit caution sequencing -</p> <ol style="list-style-type: none"> 6. Consider securing LEFT engine. <ul style="list-style-type: none"> • DEPARTURE IS PROBABLE IF LEFT ENGINE IS SECURED. • IF SINGLE ENGINE, DEPARTURE IS LIKELY WITH THE USE OF AFTER-BURNER . <ol style="list-style-type: none"> 7. Read adjacent remarks for LEF/AIL/RUD Xs. 8. Execute Controllability Check procedure. <ul style="list-style-type: none"> • Flaps HALF • DO NOT EXCEED ON-SPEED AOA, or 7° AOA if LEF extension less than 10°. <p>FOR LANDING</p> <p>If single engine -</p> <ol style="list-style-type: none"> 1. Execute Single Engine Approach and Landing procedure. <p>If both engines running -</p> <ol style="list-style-type: none"> 1. Fly a straight-in approach. 2. Make an arrested landing (if practical). <p>If arrested landing not practical -</p> <ol style="list-style-type: none"> 3. Avoid longitudinal stick inputs during landing rollout (e.g., aerobraking). 4. Use emergency brakes with steady brake pressure (DO NOT PUMP). Anti-skid is not available. 5. Consider paddle switch - PRESS after touch-down to preserve APU ACCUM pressure for slow speed NWS. <p>Once stopped on runway -</p> <ol style="list-style-type: none"> 6. Do not taxi (even if HYD 2A caution is removed).

Figure 12-1. Warning/Caution/Advisory Displays (Sheet 40)

HYD Cautions

INDICATOR	• CAUSE / REMARKS (continued)	CORRECTIVE ACTION
HYD 1A HYD 1B HYD 2A (continued)	<p>Remarks for RUD Xs:</p> <div style="text-align: center; border: 2px solid black; padding: 5px; width: fit-content; margin: 10px auto;"> WARNING </div> <ul style="list-style-type: none"> • Full opposing rudder may not be sufficient to prevent a departure when single engine if MAX power selected. Large single engine throttle transients can cause significant yaw and roll. • Failure to maintain AOA below 10° and balanced flight can result in a departure in yaw and roll that is unrecoverable. • Rudder toe-in is removed. Bolter performance degraded. • Counter any roll-off with rudder. Countering roll-off with lateral stick alone increases adverse yaw and aggravates roll-off. • Line-up control is degraded. Make slow and smooth line-up corrections (especially if single engine). 	

Figure 12-1. Warning/Caution/Advisory Displays (Sheet 41)

HYD Cautions

INDICATOR	• CAUSE / REMARKS	CORRECTIVE ACTION
<p>HYD 1A HYD 1B HYD 2B</p>	<ul style="list-style-type: none"> • Triple HYD circuit failure (<1,500 psi). <p>Flight control surfaces affected:</p> <ul style="list-style-type: none"> • Both TEFs lost • Left aileron lost (faired and damped) • Left rudder lost (faired and damped) • Left stabilator lost (resulting in non-resettable MECH version) <div style="border: 1px solid black; padding: 2px; text-align: center; width: fit-content; margin: 10px auto;">WARNING</div> <p>Maintain FLAP switch in AUTO. Aircraft will likely become uncontrollable below 200 KCAS. Transition to flaps HALF will result in uncontrollable pitch-up, from which there is no recovery.</p> <p>Remarks for any surface off:</p> <ul style="list-style-type: none"> • General Limits: <ul style="list-style-type: none"> • 10° AOA for flaps AUTO • On-speed AOA for flaps HALF/FULL • 2g max • Minimize sideslip • Half lateral stick • Loss of autopilot <p>Remarks for AIL Xs:</p> <ul style="list-style-type: none"> • Expect slightly higher approach speeds. For flaps FULL, approach speed will be increased by about 8 knots. Flaps HALF, 16 knots. • Avoid over-controlling lateral stick inputs as it can cause lateral PIO especially when approaching touchdown. <p>Remarks for RUD Xs:</p> <div style="border: 1px solid black; padding: 2px; text-align: center; width: fit-content; margin: 10px auto;">WARNING</div> <ul style="list-style-type: none"> • Full opposing rudder may not be sufficient to prevent a departure when single engine if MAX power selected. Large single engine throttle transients can cause significant yaw and roll. • Failure to maintain AOA below 10° and balanced flight can result in a departure in yaw and roll that is unrecoverable. <ul style="list-style-type: none"> • Rudder toe-in is removed. Bolter performance degraded. • Counter any roll-off with rudder. Countering roll-off with lateral stick alone increases adverse yaw and aggravates roll-off. • Line-up control is degraded. Make slow and smooth line-up corrections (especially if single engine). <div style="text-align: center; font-size: 1.2em; font-weight: bold; margin-top: 20px;">CONTINUED</div>	<p>High approach speeds will likely preclude CV landing. Divert if able. Aircraft will likely become uncontrollable below 200 KCAS. Maintain flaps AUTO.</p> <ol style="list-style-type: none"> 1. Throttle LEFT engine - IDLE <p>If LEF Xs -</p> <ol style="list-style-type: none"> 2. DO NOT RESET FCS. <p>In all cases -</p> <ol style="list-style-type: none"> 3. Airspeed - Maintain between 200-300 KCAS 4. AOA - MAINTAIN BELOW 10° 5. Land as soon as possible. <p>If HYD 1 needle stabilized at zero OR</p> <p>If failure was NOT preceded by RLS circuit caution sequencing -</p> <ol style="list-style-type: none"> 6. DO NOT secure left engine. <p>If HYD 1 needle NOT stabilized at zero OR</p> <p>If failure was preceded by RLS circuit caution sequencing -</p> <ol style="list-style-type: none"> 6. Consider securing LEFT engine. <ul style="list-style-type: none"> • DEPARTURE IS PROBABLE IF LEFT ENGINE IS SECURED. • IF SINGLE ENGINE, DEPARTURE IS LIKELY WITH THE USE OF AFTER-BURNER . 7. Read adjacent remarks for AIL/RUD/ STAB/ TEF Xs. 8. Execute Controllability Check procedure. <ul style="list-style-type: none"> • Flaps AUTO • Maintain airspeed 220-230 KCAS until gear extended. • DO NOT EXCEED ON-SPEED AOA. • Adjust gross weight to the minimum practical. <p>FOR LANDING</p> <p>If single engine -</p> <ol style="list-style-type: none"> 1. Execute Single Engine Approach and Landing procedure. <ul style="list-style-type: none"> • Flaps AUTO <p>If both engines running -</p> <ol style="list-style-type: none"> 1. FLAP switch - AUTO 2. Fly a straight-in approach. 3. Make an arrested landing (if practical). <p>If arrested landing not practical -</p> <ol style="list-style-type: none"> 4. Avoid longitudinal stick inputs during landing rollout (e.g., aerobraking).

Figure 12-1. Warning/Caution/Advisory Displays (Sheet 42)

HYD Cautions



INDICATOR	• CAUSE / REMARKS (continued)	CORRECTIVE ACTION
HYD 1A HYD 1B HYD 2B (continued)	<p>Remarks for STAB Xs:</p> <div style="text-align: center;">  <p>CAUTION</p> </div> <p>Aircraft reverted to MECH due to stab having inadequate hydraulic power. This can be the result of excessive, simultaneous hydraulic system demands exceeding system capacity (e.g., landing gear activation, flap movement, and multiple flight control inputs) combined with HYD system failure. Can be reset if HYD pressure >1,500psi. If practical, maintain engine with operating HYD system at or above 85 % rpm.</p> <p>Remarks for TEF Xs:</p> <div style="text-align: center;">  <p>WARNING</p> </div> <p>Slower engine response to throttle changes may result in excessive sink rates under high WOD conditions. The recovery WOD should be kept as close as possible to the Aircraft Recovery Bulletin recommendations.</p> <ul style="list-style-type: none"> • TEF driven to 0°. • Approach speeds are significantly higher and on-speed power settings are near idle. • Expect slower engine response. • Aircraft response to power corrections is sluggish and small in magnitude. Power corrections will translate into an air-speed change before a rate of descent change is noted. Expect larger, longer, and more anticipatory power corrections to be required in order to effect a glideslope change. Aggressive, well-timed, and anticipatory throttle inputs are key to glideslope control. • There is a tendency to over-control power due to the low approach power setting and the longer time required to effect a change. • Time to achieve positive rate of climb is longer during a bolter/waveoff due to sluggish throttle response. Climb-out attitude will appear flatter than normal. 	

Figure 12-1. Warning/Caution/Advisory Displays (Sheet 43)

HYD Cautions

INDICATOR	• CAUSE / REMARKS	CORRECTIVE ACTION
<p>HYD 1A HYD 2A HYD 2B</p>	<ul style="list-style-type: none"> • Triple HYD circuit failure (<1,500 psi). <p>Flight control surfaces affected:</p> <ul style="list-style-type: none"> • Both TEFs lost • Right aileron lost (faired and damped) • Left rudder lost (faired and damped) <p>With HYD 2A failed:</p> <ul style="list-style-type: none"> • No landing gear retraction/normal extension • No normal NWS (flashing NWS in HUD) • No normal braking • No anti-skid • No probe retraction/normal extension • No launch bar extension • No gun • No hook retraction • No speedbrake <p>If practical, maintain left engine at or above 85 % rpm to preclude MECH reversion.</p> <p>Remarks for any surface off:</p> <ul style="list-style-type: none"> • General Limits: <ul style="list-style-type: none"> • 10° AOA for flaps AUTO • On-speed AOA for flaps HALF/FULL • 2g max • Minimize sideslip • Half lateral stick • Loss of autopilot <p>Remarks for AIL Xs:</p> <ul style="list-style-type: none"> • Expect slightly higher approach speeds. For flaps FULL, approach speed will be increased by about 8 knots. Flaps HALF, 16 knots. • Avoid over-controlling lateral stick inputs as it can cause lateral PIO especially when approaching touchdown. <p>Remarks for RUD Xs:</p> <div style="border: 1px solid black; padding: 2px; text-align: center; width: fit-content; margin: 10px auto;">WARNING</div> <ul style="list-style-type: none"> • Full opposing rudder may not be sufficient to prevent a departure when single engine if MAX power selected. Large single engine throttle transients can cause significant yaw and roll. • Failure to maintain AOA below 10° and balanced flight can result in a departure in yaw and roll that is unrecoverable. • Rudder toe-in is removed. Bolter performance degraded. • Counter any roll-off with rudder. Countering roll-off with lateral stick alone increases adverse yaw and aggravates roll-off. • Line-up control is degraded. Make slow and smooth line-up corrections (especially if single engine). <p>Remarks for TEF Xs:</p> <div style="border: 1px solid black; padding: 2px; text-align: center; width: fit-content; margin: 10px auto;">WARNING</div> <p>Slower engine response to throttle changes may result in excessive sink rates under high WOD conditions. The recovery WOD should be kept as close as possible to the Aircraft Recovery Bulletin recommendations.</p> <p style="text-align: center; font-size: 1.2em; font-weight: bold; margin-top: 20px;">CONTINUED</p>	<p>DO NOT EXCEED 10° AOA. High approach speeds will likely preclude CV landing. Divert if able.</p> <ol style="list-style-type: none"> 1. Throttle RIGHT engine - IDLE <p>If LEF Xs -</p> <ol style="list-style-type: none"> 2. DO NOT RESET FCS. <p>In all cases -</p> <ol style="list-style-type: none"> 3. Airspeed - Maintain below 300 KCAS 4. AOA - MAINTAIN BELOW 10° 5. Land as soon as possible. 6. PROBE switch - EMERG EXTND (if required) <p>If HYD 2 needle stabilized at zero OR</p> <p>If failure was NOT preceded by RLS circuit caution sequencing -</p> <ol style="list-style-type: none"> 7. DO NOT secure right engine. <p>If HYD 2 needle NOT stabilized at zero OR</p> <p>If failure was preceded by RLS circuit caution sequencing -</p> <ol style="list-style-type: none"> 7. Consider securing RIGHT engine. <ul style="list-style-type: none"> • DEPARTURE IS PROBABLE IF RIGHT ENGINE IS SECURED. • IF SINGLE ENGINE, DEPARTURE IS LIKELY WITH THE USE OF AFTER-BURNER . <ol style="list-style-type: none"> 8. Read adjacent remarks for AIL/RUD/TEF Xs. 9. Execute Controllability Check procedure. <ul style="list-style-type: none"> • Flaps HALF (Transition to flaps HALF will result in controllable nose-down pitching moment) • DO NOT EXCEED ON-SPEED AOA. • Adjust gross weight to the minimum practical. <p>FOR LANDING</p> <p>If single engine -</p> <ol style="list-style-type: none"> 1. Execute Single Engine Approach and Landing procedure. <p>If both engines running -</p> <ol style="list-style-type: none"> 1. Fly a straight-in approach. 2. Make an arrested landing (if practical). <p>If arrested landing not practical -</p> <ol style="list-style-type: none"> 3. Use emergency brakes with steady brake pressure (DO NOT PUMP). Anti-skid is not available. 4. Consider paddle switch - PRESS after touchdown to preserve APU ACCUM pressure for slow speed NWS. <p>Once stopped on runway -</p> <ol style="list-style-type: none"> 5. Do not taxi (even if HYD 2A caution is removed).

Figure 12-1. Warning/Caution/Advisory Displays (Sheet 44)

HYD Cautions

INDICATOR	• CAUSE / REMARKS (continued)	CORRECTIVE ACTION
HYD 1A HYD 2A HYD 2B (continued)	<ul style="list-style-type: none"> • TEF driven to 0°. • Approach speeds are significantly higher and on-speed power settings are near idle. • Expect slower engine response. • Aircraft response to power corrections is sluggish and small in magnitude. Power corrections will translate into an air-speed change before a rate of descent change is noted. Expect larger, longer, and more anticipatory power corrections to be required in order to effect a glideslope change. Aggressive, well-timed, and anticipatory throttle inputs are key to glideslope control. • There is a tendency to over-control power due to the low approach power setting and the longer time required to effect a change. • Time to achieve positive rate of climb is longer during a bolter/waveoff due to sluggish throttle response. Climb-out attitude will appear flatter than normal. 	

Figure 12-1. Warning/Caution/Advisory Displays (Sheet 45)

HYD Cautions

INDICATOR	• CAUSE / REMARKS	CORRECTIVE ACTION
<p>HYD 1B HYD 2A HYD 2B</p>	<ul style="list-style-type: none"> • Triple HYD circuit failure (<1,500 psi). <p>Flight control surfaces affected:</p> <ul style="list-style-type: none"> • Both LEFs frozen • Left aileron lost (faired and damped) • Right rudder lost (faired and damped) • Right stabilator lost (resulting in non-resettable MECH reversion) • TEFs held frozen in flaps AUTO <p>With HYD 2A failed:</p> <ul style="list-style-type: none"> • No landing gear retraction/normal extension • No normal NWS (flashing NWS in HUD) • No normal braking • No anti-skid • No probe retraction/normal extension • No launch bar extension • No gun • No hook retraction • No speedbrake <div style="border: 1px solid black; padding: 5px; text-align: center; width: fit-content; margin: 10px auto;">WARNING</div> <p>Handling qualities will be severely degraded. Abrupt aft stick and trim may be required to counter the nose-down pitching moments during failure transients. Afterwards, use trim and small stick adjustments when possible to maintain control.</p> <p>Remarks for any surface off:</p> <ul style="list-style-type: none"> • General Limits: <ul style="list-style-type: none"> • 10° AOA for flaps AUTO • On-speed AOA for flaps HALF/FULL • 2g max • Minimize sideslip • Half lateral stick • Loss of autopilot <p>Remarks for AIL Xs:</p> <ul style="list-style-type: none"> • Expect slightly higher approach speeds. For flaps FULL, approach speed will be increased by about 8 knots. Flaps HALF, 16 knots. • Avoid over-controlling lateral stick inputs as it can cause lateral PIO especially when approaching touchdown. <p>Remarks for RUD Xs:</p> <div style="border: 1px solid black; padding: 5px; text-align: center; width: fit-content; margin: 10px auto;">WARNING</div> <ul style="list-style-type: none"> • Full opposing rudder may not be sufficient to prevent a departure when single engine if MAX power selected. Large single engine throttle transients can cause significant yaw and roll. • Failure to maintain AOA below 10° and balanced flight can result in a departure in yaw and roll that is unrecoverable. <p style="text-align: center; font-size: 1.5em; font-weight: bold; margin-top: 20px;">CONTINUED</p>	<p>DO NOT EXCEED 10° AOA. High approach speeds will likely preclude CV landing. Divert if able.</p> <ol style="list-style-type: none"> 1. Throttle RIGHT engine - IDLE 2. Airspeed - Maintain below 300 KCAS 3. AOA - MAINTAIN BELOW 10° 4. Land as soon as possible. 5. PROBE switch - EMERG EXTD (if required) <p>If HYD 2 needle stabilized at zero OR</p> <p>If failure was NOT preceded by RLS circuit caution sequencing -</p> <ol style="list-style-type: none"> 6. DO NOT secure right engine. <p>If HYD 2 needle NOT stabilized at zero OR</p> <p>If failure was preceded by RLS circuit caution sequencing -</p> <ol style="list-style-type: none"> 6. Consider securing RIGHT engine. <ul style="list-style-type: none"> • DEPARTURE IS PROBABLE IF RIGHT ENGINE IS SECURED. • IF SINGLE ENGINE, DEPARTURE IS LIKELY WITH THE USE OF AFTER-BURNER . 7. Read adjacent remarks for AIL/RUD/STAB/LEF Xs. <p>Transition to flaps HALF will result in an abrupt initial pitch-up which can require full forward stick. Transition to flaps HALF at sufficient altitude to provide a safety margin for transients.</p> <ol style="list-style-type: none"> 8. Execute Controllability Check procedure. <ul style="list-style-type: none"> • Flaps HALF • DO NOT EXCEED ON-SPEED AOA, or 7° AOA if LEF extension less than 10°. <p>FOR LANDING</p> <p>If single engine -</p> <ol style="list-style-type: none"> 1. Execute Single Engine Approach and Landing procedure. <p>If both engines running -</p> <ol style="list-style-type: none"> 1. Fly a straight-in approach. 2. Make an arrested landing (if practical). <p>If arrested landing not practical -</p> <ol style="list-style-type: none"> 3. Use emergency brakes with steady brake pressure (DO NOT PUMP). Anti-skid is not available. 4. Consider paddle switch - PRESS after touchdown to preserve APU ACCUM pressure for slow speed NWS. <p>Once stopped on runway -</p> <ol style="list-style-type: none"> 5. Do not taxi (even if HYD 2A caution is removed).

Figure 12-1. Warning/Caution/Advisory Displays (Sheet 46)

HYD Cautions



INDICATOR	• CAUSE / REMARKS (continued)	CORRECTIVE ACTION
<p>HYD 1B HYD 2A HYD 2B (continued)</p>	<ul style="list-style-type: none"> • Rudder toe-in is removed. Bolter performance degraded. • Counter any roll-off with rudder. Countering roll-off with lateral stick alone increases adverse yaw and aggravates roll-off. • Line-up control is degraded. Make slow and smooth line-up corrections (especially if single engine). <p>Remarks for STAB Xs:</p> <div style="text-align: center;">  <p>CAUTION</p> </div> <p>Aircraft reverted to MECH due to stab having inadequate hydraulic power. This can be the result of excessive, simultaneous hydraulic system demands exceeding system capacity (e.g., landing gear activation, flap movement, and multiple flight control inputs) combined with HYD system failure. Can be reset if HYD pressure >1500psi. If practical, maintain engine with operating HYD system at or above 85 % rpm.</p> <p>Remarks for LEF Xs:</p> <div style="text-align: center;">  <p>CAUTION</p> </div> <p>Do not exceed 7° AOA if LEF extension less than 10°.</p> <ul style="list-style-type: none"> • Opposite LEF held frozen. TEFs held frozen in flaps AUTO. • Stall margin reduced for LEF locked above 5° LED. • Buffet likely with LEF near 0° at lower AOAs. • Expect slight roll-off as airspeed changes during a waveoff or bolter that is easily controllable. • Glideslope control degradations may be more pronounced depending on frozen LEF position. Wing stores will further degrade glideslope control. • Power corrections will translate into an airspeed change before a rate of descent change is noticed. This may lead to a tendency to over-control glideslope. Anticipatory throttle inputs are key to glideslope control. • Bolter/waveoff performance is degraded and climb-out attitude will appear flatter than normal. • If AUTO is selected after being in flaps HALF or FULL, the TEFs will not retract except for loads alleviation (no higher than 17°). While in AUTO, momentary selection of GAIN ORIDE will command the TEFs to retract to 3° TED. However, the operating LEF will also be commanded to move to 3° LED. This may drive a controllable but undesirable left versus right LEF split if the failed LEF is not near 3° LED. Therefore, only select GAIN ORIDE if TEF retraction is essential for range or fuel considerations. 	

Figure 12-1. Warning/ Caution/ Advisory Displays (Sheet 47)

* Immediate action item
 ☆ Discussion in part V

DDI Advisories

INDICATOR	CAUSE/REMARKS	CORRECTIVE ACTION
ACI	<ul style="list-style-type: none"> An ACI configuration that is incompatible with GPWS/TAWS is detected. CFIT voice warnings are replaced with the "Whoop...Whoop" warning tone. Visual CFIT warnings are still available.	Information
AHMD	<ul style="list-style-type: none"> Aft Quick Disconnect Connector (QDC) is not connected. Aft QDC is not properly secured to Quick Mounting Bracket (QMB). Aft coarse alignment is invalid or has not been performed. Aft Helmet Display Unit (HDU) is not connected to the helmet. 	1. Verify aft HMD properly connected. 2. Verify aft QDC is properly connected and mounted in the QMB. 3. Aft HMD - ALIGN 4. Verify aft HDU is properly connected to the helmet.
ALIGN	<ul style="list-style-type: none"> INS/EGI switched to NAV without a complete alignment. 	1. Complete alignment or switch to GYRO mode.
AM DL	<ul style="list-style-type: none"> Radar hardware needed to support AMRAAM data link not installed. 	Information
A/P	<ul style="list-style-type: none"> Autopilot mode selected. 	Information
ARMAMENT ADVISORIES	Refer to NTRP 3-22.2-FA18A-D (classified NATIP volume) or NTRP 3-22.4-FA18A-D (unclassified NATIP volume)	
ATTH	<ul style="list-style-type: none"> Autopilot attitude hold mode selected. 	Information
BALT	<ul style="list-style-type: none"> Autopilot barometric altitude hold mode selected. 	Information
BIT	<ul style="list-style-type: none"> Built-in test failure. ☆ Refer to ADC Failure.	1. MENU BIT - CHECK If ADC status - NOGO (A/B), MUX FAIL (C/D), or NOT RDY - 1. Confirm airspeed box blank. 2. Confirm altitude box blank or contains radar altitude (below 5,000 feet AGL). 3. During CV operations, recover early if practical. 4. ATT switch - STBY 5. Use AOA E bracket for AOA control. 6. Inform the LSO the indexers will be inoperative. 7. GPWS/TAWS - Unbox
COM1H COM2H	<ul style="list-style-type: none"> ARC 210 COM1 or COM2 not loaded with Have Quick time. 	Information
COM1L COM2L	<ul style="list-style-type: none"> ARC 210 COM1 or COM2 not loaded with presets and EP. 	Information

Figure 12-1. Warning/Caution/Advisory Displays (Sheet 48)

* Immediate action item
 ☆ Discussion in part V

DDI Advisories

INDICATOR	CAUSE/REMARKS	CORRECTIVE ACTION
COM1S COM2S	<ul style="list-style-type: none"> ARC 210 COM1 or COM2 not loaded with SINC-GARS time. 	Information
CDATA	<ul style="list-style-type: none"> Unit other than MU contains classified data. 	Information
CFIT	<ul style="list-style-type: none"> GPWS/TAWS has been deselected. Protection against CFIT is unavailable.	Information
CONFG	<ul style="list-style-type: none"> All systems have not been checked for configuration compatibility because one or more of the systems is not communicating. 	Information
CPLD	<ul style="list-style-type: none"> Autopilot coupled to WYPT, OAP, SEQ#, or TCN. 	Information
CRUIS	<ul style="list-style-type: none"> GAIN switch in ORIDE and FLAP switch AUTO. Leading and trailing edge flaps about 3°. Flaps optimized for 35,000 feet, Mach 0.7, and 2° AOA.	Information
D-BAD	<ul style="list-style-type: none"> ALE-47 indicates a misfire. 	Information
DCSCS	<ul style="list-style-type: none"> COMSEC failure detected. 	Information
DECM	<ul style="list-style-type: none"> Degrade detected with either the on-board jammer (either ALQ-126B or ALQ-165) or its interface with the RW. 	1. BIT/EW page - CHECK
DISCH (FIRE EXTGH)	<ul style="list-style-type: none"> FIRE EXTGH pushbutton pressed. 	GROUND 1. Do not takeoff.
D-LOW	<ul style="list-style-type: none"> ALE-47 indicates an expendable Bingo level reached. 	Information
F-QTY	<ul style="list-style-type: none"> Failure in fuel quantity gaging system that may affect fuel or CG display. 	1. Fuel DDI display - CHECK If all fuel quantities invalid - 2. Signal data computer - RESET 3. FUEL BIT - PERFORM
FLAPS (Amber)	<ul style="list-style-type: none"> Trailing edge flaps OFF, leading edge flaps OFF, SPIN mode ON, GAIN ORIDE selected, or FLAPS HALF/FULL over 250 knots. 	Information
FPAS	<ul style="list-style-type: none"> Flight Performance Advisory System is unable to calculate HOME FUEL caution. 	Information
FUEL	<ul style="list-style-type: none"> FUEL LO, BINGO, or CG caution BIT failure. 	1. Fuel BIT - INITIATE
FULL	<ul style="list-style-type: none"> FLAP switch FULL. 	Information

Figure 12-1. Warning/Caution/Advisory Displays (Sheet 49)

* Immediate action item
 ☆ Discussion in part V

DDI Advisories

INDICATOR	CAUSE/REMARKS	CORRECTIVE ACTION
GPS	<ul style="list-style-type: none"> GPS NORM flight phase mode selected and EHPE exceeds 1,092 feet. 	Information
GPSLD	<ul style="list-style-type: none"> GPS loading failure detected. 	Information
HALF	<ul style="list-style-type: none"> FLAP switch HALF. 	Information
L HEAT R HEAT	<ul style="list-style-type: none"> Designated engine anti-ice valve open. 	Information
HIAOA	<ul style="list-style-type: none"> INS attitude data is not being provided to the FCCs for sideslip and AOA estimation calculations. May be caused by an INS failure (INS ATT caution), by placing the ATT switch to STBY with good INS data, or by an FCC detected failure. <p>Autopilot inoperative.</p> <p>Above approximately 20° AOA in flaps AUTO, the FCCs use INS data for sideslip and sideslip rate feedback to provide roll coordination and departure resistance. When INS data is not available or invalid, the FCCs will no longer use INS data. There is no significant degradation to flying qualities, departure resistance or roll performance with this indication.</p>	<ol style="list-style-type: none"> FCS RESET button – PUSH <p>If advisory remains –</p> <ol style="list-style-type: none"> Monitor any sideslip excursions above 20° AOA in flaps AUTO.
HMD	<ul style="list-style-type: none"> Forward Quick Disconnect Connector (QDC) is not connected. Forward QDC is not properly secured to Quick Mounting Bracket (QMB). Forward coarse alignment is invalid or has not been performed. Forward Helmet Display Unit (HDU) is not connected to the helmet. 	<ol style="list-style-type: none"> Verify forward HMD properly connected. Verify forward QDC is properly connected and mounted in the QMB. Forward HMD - ALIGN Verify forward HDU is properly connected to the helmet.
HSEL	Autopilot heading hold mode selected.	Information
LAND	<ul style="list-style-type: none"> GAIN switch in ORIDE and FLAP switch HALF or FULL. <p>Leading edge flaps 17° Leading edge flaps optimized for 8.1° AOA Trailing edge flaps 30° or 45°</p>	Information
L BAR (Green)	<ul style="list-style-type: none"> Launch bar extended on the deck. 	Information

Figure 12-1. Warning/Caution/Advisory Displays (Sheet 50)

* Immediate action item
 ☆ Discussion in part V

DDI Advisories

INDICATOR	CAUSE/REMARKS	CORRECTIVE ACTION
L DEGD	<ul style="list-style-type: none"> LTD/R and/or marker degrade detected. Laser designation/ranging and/or marking will fire due to alignment errors. If ATFLIR installed- ALN DEGD - Neither LTD/R nor marker will fire due to alignment errors. PWR DEGD - LTD/R power could be deficient for ranging and/or designating. RNG DEGD - Laser ranging will be invalid but designating may still be possible. MRK DEGD - Marker will either not fire or fire at low power.	If ATFLIR installed- 1. TAC/FLIR/SETUP page - IDENTIFY FAILURE If either TFLIR or ATFLIR installed - 2. FLIR IBIT - PERFORM (SUPT/BIT/SENSORS/FLIR or /ATFLIR) If advisory remains - 3. FLIR switch - CYCLE
LEFT	STEADY <ul style="list-style-type: none"> Left gear down and locked. ----- FLASHING <ul style="list-style-type: none"> Left gear planing link failed. 	Information ----- 1. Refer to Planing Link Failure.
LOAD	<ul style="list-style-type: none"> Improper weapon load or codes or incompatible fuzing. Refer to NTRP 3-22.4-FA18A-D NATIP and NTRP 3-22.2-FA18A-D NATIP. 	1. Check SMS for proper configuration.
M2ID	<ul style="list-style-type: none"> ACL mode enabled and Mode 2 code differs from Link 4 value. 	Information
M4 OK	<ul style="list-style-type: none"> Mode 4 valid interrogation reply. 	Information
MIDS	<ul style="list-style-type: none"> MIDS function status change. 	1. Select MIDS from the SUPT menu.
MNTCD	<ul style="list-style-type: none"> AMU/maintenance card problem. Advisory is disabled in flight.	1. Verify maintenance card installed in proper AMU slot and AMU door is closed. 2. If advisory remains - Do not takeoff
MSNCD	<ul style="list-style-type: none"> AMU/mission card problem. Advisory is disabled in flight.	1. Verify mission card installed in proper AMU slot and AMU door is closed. 2. If advisory remains - Pilot discretion
MU FL	<ul style="list-style-type: none"> Memory unit memory full. Oldest stored data will be overwritten.	Information
NOSE	<ul style="list-style-type: none"> Nose gear down and locked. 	Information
NOSEC	<ul style="list-style-type: none"> GPS operating in non-secure mode. 	Information
PCODE	<ul style="list-style-type: none"> Keys are incorrect. Parity error detected. Keys not loaded. 	Information

Figure 12-1. Warning/Caution/Advisory Displays (Sheet 51)

* Immediate action item
 ☆ Discussion in part V

DDI Advisories

INDICATOR	CAUSE/REMARKS	CORRECTIVE ACTION
P/INS	<ul style="list-style-type: none"> Satellite communication lost. INS not being updated with GPS data. 	Information
RALT	<ul style="list-style-type: none"> Autopilot radar altitude hold mode selected. 	Information
RC DL	<ul style="list-style-type: none"> Data link pod installed and ATARS not powered. 	1. ATARS switch - ON If advisory remains - 2. ATARS power switch - OFF 3. CLP power knob - OFF
BCDR	<ul style="list-style-type: none"> MU turned off. 	Information
READY (APU)	<ul style="list-style-type: none"> APU on line and ready. 	Information
RSET	<ul style="list-style-type: none"> Reset cleared FCS failure. 	Information
RSET	<ul style="list-style-type: none"> Reset did not clear FCS failure. 	Information
RIGHT	<p>STEADY</p> <ul style="list-style-type: none"> Right gear down and locked. <p>-----</p> <p>FLASHING</p> <ul style="list-style-type: none"> Right gear planing link failed. 	<p>Information</p> <p>-----</p> <p>1. Refer to Planing Link Failure.</p>
SKID	<ul style="list-style-type: none"> Gear down and ANTI SKID switch - OFF 	Information
SPD BRK	<ul style="list-style-type: none"> Speedbrake not fully retracted. 	Information
TRIM	<ul style="list-style-type: none"> Control surfaces trimmed: roll and yaw neutral, stabilator 12° NU; MECH stick position zero. 	Information
VVEL	<ul style="list-style-type: none"> GPS not accurate enough to aid HUD velocity vector. 	Information
WPNS	<ul style="list-style-type: none"> Bulk data transfer error or JSOW overheat condition. 	Information
YCODE	<ul style="list-style-type: none"> GPS not tracking in secure mode. 	1. Select NOSEC GPS if required.

Figure 12-1. Warning/Caution/Advisory Displays (Sheet 52)

CHAPTER 13

Ground Emergencies

13.1 ENGINE FAILS TO START/HUNG START

If no EGT rise within 20 seconds after throttle advanced or rpm stabilizes below IDLE -

1. Throttle affected engine - OFF
2. Continue cranking for 3 minutes.
3. Throttle affected engine - IDLE

If still no start -

4. Throttle affected engine - OFF

After 3 minutes -

5. ENG CRANK switch - OFF
6. APU switch - OFF

13.2 HOT START

If EGT climbs rapidly thru 750°C -

- *1. Throttle affected engine - OFF
2. Engine - CRANK UNTIL EGT BELOW 200°C. If starter has cut out, reengage when rpm below 30 %.

If 815°C not exceeded -

3. Throttle affected engine - IDLE

If 815°C exceeded or second hot start -

3. Throttle affected engine - OFF
4. Engine - CRANK FOR 3 MINUTES
If starter has cut out, reengage when rpm below 30 %.
5. ENG CRANK switch - OFF
6. APU switch - OFF

13.3 GROUND FIRE

Several fire conditions exist that may be detected and signalled by ground crew without corresponding cockpit FIRE indications. These may include, for example, APU exhaust torching, ignition of fuel or other flammable liquids exposed to hot surfaces, or brake fires. Aircraft location and the nature of

the fire condition will determine the course of action. In most cases, if ground crew signal a fire condition, the aircraft should be stopped and shut down immediately. If a fire occurs during hot refueling, the pilot must decide whether to taxi clear or shut down immediately.

13.3.1 HOT BRAKES/BRAKE FIRE. Hot brakes and/or melted wheel assembly fuse plugs can be expected any time maximum effort braking is used at heavy gross weights with or without anti-skid, e.g., aborted takeoff or heavy weight landing with high taxi brake usage.

There are basically two types of fires related to the brake system: flash fires and fires due to continuous hydraulic fluid leakage onto hot brakes.

Brake flash fires are normally short in duration and self-extinguish. They can occur if excess grease or residual/leaking hydraulic fluid have built up in the wheel brake assembly or on the carbon discs. These materials may ignite at normal post-landing brake temperatures. Visible flames may extend from the wheel assembly while flammable material is being consumed and smoke may be visible for a short time after the fire goes out.

Continuous hydraulic fluid leakage coming into contact with hot brakes may result in a fire which will not immediately self-extinguish. Setting the parking brake increases the rate of heat transfer from the brakes to the wheel assembly which may lead to continuous hydraulic fluid leakage.



- Avoid setting the parking brake with hot brakes until the brake assembly has cooled to prevent damage by heat and/or fire to the brakes, wheel, tire, and landing gear components.
- If fire occurs with the parking brake set, the parking brake may become non-operational and the aircraft may need to be chocked.

If hot brakes are suspected -

1. Continue to taxi to cool brakes (if practical).
2. DO NOT set parking brake.
3. Chock nosewheel (do not chock main wheels).
4. Park into the wind (if practical).
5. Cool brake assembly with ground cooling fan (if available).

If brake fire occurs -

1. Shut down both engines.
2. Chock nosewheel or PARK BRK handle - SET
3. Egress.
4. Ensure unnecessary ground personnel remain well clear of the aircraft.

13.4 EGRESS

The canopy jettison system uses rocket thrusters to separate the canopy. These rockets produce considerable flame directed down over the fuselage and present a hazard to the ground crew in the immediate vicinity. The rocket flame provides an ignition source for spilled fuel or hydraulic fluid. The canopy control switch should be used to open the canopy unless there are overriding considerations. The jettison handle is the only means of opening the canopy from the F/A-18B/D rear cockpit.

1. Canopy - OPEN (CANOPY switch, CANOPY JETT handle, or canopy handcrank)

WARNING

CANOPY JETT rocket thrusters may ignite spilled fuel or hydraulic fluid and may injure ground crew in the immediate vicinity.

NOTE

- The CANOPY switch should be used to raise the canopy unless there are overriding circumstances. If weight is not on the left main gear (e.g., gear up landing), the CANOPY switch must be held to raise the canopy.
- If electrical power is not available, the canopy must be jettisoned or raised with the handcrank.

2. Harness and leg restraints - RELEASE

NOTE

Several options exist for releasing the harness and leg restraints. (1) All four harness buckles and all four leg restraints can be manually released. (2) The upper Koch fittings can be manually released and the manual override handle can be pulled to release the leg restraints and the survival kit. The survival kit will be retained and may hamper egress. (3) All four harness buckles can be manually released, and the manual override handle can be pulled to release the leg restraints.

3. Oxygen/comm lead - DISCONNECT
4. EXIT THE COCKPIT

NOTE

If the boarding ladder has not been lowered, aircrew have several alternatives, i.e., jump from the LEX (an approximately 8 ft drop), slide down an extended TEF, or step down from the wing to an installed wing tank/store.

13.5 BRAKE FAILURE/EMERGENCY BRAKES

The emergency brake system is powered by the brake accumulator or HYD 2B. Anti-skid protection is bypassed when emergency brakes are selected or when the ANTI SKID switch is OFF. Normally limited by the anti-skid system, 3,000 psi hydraulic brake pressure is available and regulated only by pilot brake pedal forces. When using emergency brakes at high speed, initially apply very light brake pedal pressure and gradually increase as required. There is a very small margin between effective emergency braking and blown tires. If practical, rollout speed should be as slow as possible before applying emergency brakes. The use of emergency brakes at high speeds should be considered a last resort.

If detected after touchdown and flyaway airspeed available -

- *1. Go Around.

If brake failure occurs at slow speed or flyaway airspeed not available -

- *1. Brakes - RELEASE
- *2. EMERG BRK handle - PULL TO DETENT
- *3. Brakes - APPLY gradually

CHAPTER 14

Takeoff Emergencies

14.1 EMERGENCY CATAPULT FLYAWAY

Off the catapult, several emergencies may cause the aircraft to settle and/or lose lateral directional control. Aircraft settle may be the result of insufficient catapult endspeed or loss of thrust by the engines. Lateral directional control may be degraded by FCS malfunctions or engine thrust asymmetry. Accordingly, a single engine malfunction may be characterized by settle and reduced controllability.

Priorities during emergency catapult flyaway are to establish control of aircraft, arrest settle, and accelerate for climbout. Establishing control of the aircraft is predicated on arresting roll and yaw rates. Full rudder pedal input opposite yaw/roll may be required to do so. Rudders are the only means of controlling yaw, and are effective in countering roll, therefore they should be used as the initial control input. If rudders are not sufficient to control roll, judicious lateral stick inputs can be used to supplement the rudders and will help control bank angle. However, large lateral stick inputs may produce adverse yaw and exacerbate controllability.

Angle of attack is critical to maintaining aircraft control and arresting settle. AOA must be high enough to minimize altitude loss, while low enough to ensure controllability. An AOA range of 10-12° provides the best compromise, although at the high endspeeds associated with launches at and above 49,000 lbs gross weight, momentary excursions of up to 13° do not endanger controllability. The recommended catapult stabilator trim settings correspond to reference AOAs between 10° and 12°. For catapult launches at or below 48,000 lbs gross weight, a "hands off" rotation will result in peak AOAs of about 12° followed by a reduction toward 10° to 11°. For catapult launches at and above 49,000 lbs gross weight, peak AOAs of about 13° will occur followed by a rapid reduction to 12°. Thus, the aircraft will seek a desirable flyaway AOA without pilot input. In most cases, proper AOA control is automatically provided by the flight control system, however several scenarios (mis-trimmed aircraft, AOA system failure, flight control malfunction) require the pilot to actively set the flyaway attitude. Pilot cues are insufficient to enable precise AOA control during flyaway, so pitch attitude becomes the primary means to prompt longitudinal inputs. Maintaining the waterline symbol 10° above the horizon results in acceptable AOA control. If lateral directional control effectiveness is lost at this nose attitude, a slight reduction in pitch of approximately one degree should result in immediate recovery of control effectiveness and restore aircraft control.

Stores jettison is crucial to emergency catapult flyaway. Timely emergency jettison minimizes altitude loss and improves controllability by reducing weight and lateral asymmetry in many configurations.

If flyaway airspeed available -

*1. Throttles - MAX

*2. Rudder pedal - FULL AGAINST YAW/ROLL

- *3. EMERG JETT button - PUSH
- *4. Maintain 10° pitch attitude with \overline{W} symbol.
 - Do not exceed half lateral stick.

WARNING

- Inputs in excess of ½ lateral stick deflection may result in adverse yaw departure.
- Exceeding 10° pitch attitude may result in rapid loss of lateral-directional control.
- Raising flaps will increase aircraft settle.

If unable to arrest yaw/roll or stop settle -

- *5. EJECT.

WARNING

Delay in determining controllability will likely place aircraft outside the ejection envelope.

14.2 ABORT

The decision to abort or continue takeoff depends on many items specific to the emergency. No rule can be made which fits every situation. Items to be considered include the following:

- Emergency condition
- Weight
- Speed
- Runway remaining
- Braking conditions
- Arresting gear availability
- Wind
- Weather

Normally, the abort is accomplished by placing the throttles to IDLE, extending the speedbrake, and applying the brakes. If speed is above the computed maximum abort speed from part XI and an arrestment must be done in order to stop, the seriousness of the emergency and good judgement will control whether to abort or continue the takeoff. The ejection seat provides safe escape at ground level. If a safe aborted takeoff cannot be made and takeoff is impossible, eject. Make an arrestment if there is any stopping problem. Lower the hook in time for it to extend fully (normally 1,000 feet before wire), tell the tower of the intention to arrest, and line up on runway centerline. At high speed, avoid large pitch control inputs.

- *1. Throttles - IDLE

- *2. Speedbrake - AS DESIRED
- *3. Brakes - APPLY
- *4. Stick - AFT below 100 knots (if required)
- *5. HOOK handle - DOWN (if required)

14.3 GO AROUND

Several procedures cover emergencies such as settle off the catapult and planing link failure. However it is impossible to write procedures to cover every possibility. The go around procedure provides a quick simple way to safely get airborne if a situation arises which requires immediate action and is not covered by another procedure. Use military or maximum power while considering the current configuration (asymmetry) and the time/distance available to get airborne. If large control inputs (rudder or aileron) are used prior to liftoff, be prepared to adjust them once airborne. Jettison of external stores may enhance single engine performance. Once airborne, follow on emergency procedures may be required.

1. Throttles - MIL or MAX
2. Maintain ON-SPEED AOA and balanced flight
3. EMERG JETT button - PUSH (if required)

14.4 LOSS of DIRECTIONAL CONTROL DURING TAKEOFF or LANDING (BLOWN TIRE, NWS FAILURE)

A directional control problem on takeoff or landing may be caused by a NWS, brake, landing gear component failure, planing link failure or a blown tire. Directional control problems may be compounded by wet or icy runways, crosswinds, hydroplaning, high lateral weight asymmetries, or single-engine operations. It may be difficult to identify the source of the problem, and time is usually critical. The decision whether to continue a takeoff or to abort, or on landing, to continue rollout depends on the speed at the time the directional control problem is detected, the stopping distance required, and the availability of arresting gear.

Loss of brakes may be caused by a brake or anti-skid system failure. A brake system failure may cause a locked brake and/or blown tire, resulting in ineffective braking and/or loss of directional control. A blown tire may cause engine FOD or flap and gear door damage. If decision to stop is made, the primary danger is loss of directional control. For Planing Link Failure procedures, refer to chapter 16.

WARNING

If the decision to takeoff is made, nose rotation and/or takeoff may be delayed by abnormal aircraft attitudes due to failures, increased drag, and lack of or reduced rudder toe due to rudder deflection to counter directional motion.

If detected after touchdown and flyaway airspeed available -

- *1. Go Around

If flyaway airspeed not available -

- *1. Select emergency brakes (if appropriate)
- *2. HOOK handle - DOWN (if required)

If NWS failure suspected -

- 3. Paddle switch - PRESS

If takeoff is continued and blown tire suspected -

- 2. LDG GEAR handle - DO NOT CYCLE
- 3. Engine instruments - MONITOR FOR FOD INDICATIONS
- 4. ANTI SKID switch - OFF
- 5. Make a short field arrestment.

If decision to stop is made and blown tire suspected -

- 3. Do not retract flaps.
- 4. Do not taxi once stopped.

14.5 LOSS OF THRUST ON TAKEOFF

A loss of thrust on takeoff requires consideration of several factors. If it occurs early enough to permit a safe abort, abort. If it occurs after committed to takeoff, consider:

- Single engine minimum control airspeed varies significantly with configuration and gross weight. To avoid the loss of directional control do not exceed the following AOAs:
Flaps FULL - 10° AOA
Flaps HALF - 12° AOA
- Best rate of climb during single-engine operation occurs at or near on-speed AOA regardless of configuration or gross weight. See figure 14-1.
- Jettison of external stores to reduce gross weight.

WARNING

Exceeding 12° AOA (half flaps) or 10° AOA (full flaps) with the good engine in MAX afterburner may lead to loss of lateral and directional control.

When airborne, raise the landing gear to improve acceleration and climb at a low angle of attack to a safe altitude/airspeed.

NOTE

With one engine failed, at heavy weight, hot day conditions, even the use of maximum A/B thrust on the operating engine may not provide sufficient rate of climb capability to safely continue the takeoff. Unless external stores can be safely jettisoned, takeoffs at these conditions, as determined from the adjacent charts, should be aborted.

14.6 LANDING GEAR FAILS TO RETRACT

If LDG GEAR handle cannot be moved from the DN position -

1. LDG GEAR handle - LEAVE DN (DO NOT USE OVERRIDE)

NOTE

May be an indication of a WOW system failure. Refer to WOW System Failure for additional system effects.

If landing gear warning light and warning tone on with the LDG GEAR handle UP -

1. LG circuit breaker - CHECK IN
2. LDG GEAR handle - DN (DO NOT CYCLE)

If three down and locked indications -

3. Land as soon as practical.
4. Consider an arrested landing (normal braking and NWS may not be available).

If any gear indicates unsafe -

3. Refer to Landing Gear Unsafe/ Fails to Extend procedure.

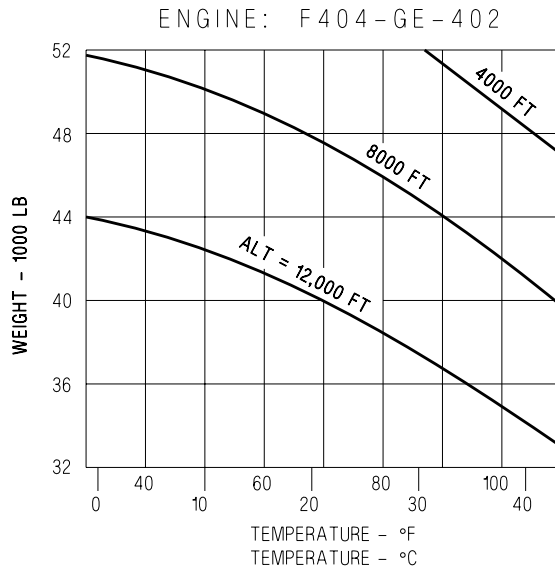
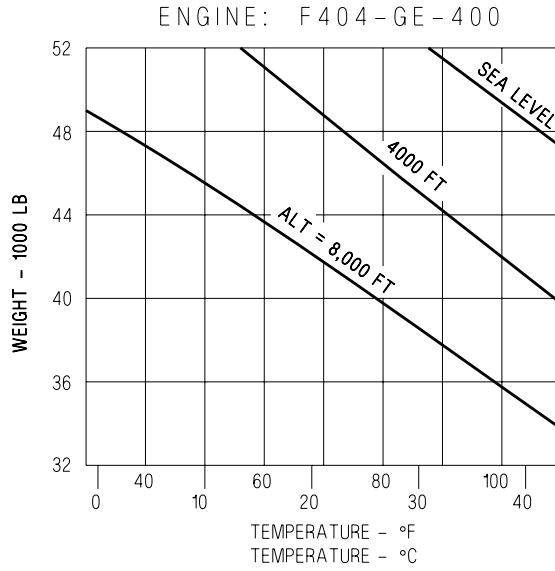

NOTE:
 AIRCRAFT CONFIGURATION
 - HALF FLAPS
 - LANDING GEAR DOWN
 - MAXIMUM A/B ON OPERATING ENGINE

ADA520-324-1-045

Figure 14-1. Maximum Weight for 100 FPM Single Engine Rate of Climb

14.7 WOW SYSTEM FAILURE



CAUTION

An uncommanded pitch up after takeoff may occur if a WOW system failure results in the aircraft sensing weight on wheels while inflight. Above 180 knots, full forward stick alone will not stop aircraft nose up rotation, so nose down trim will be required to regain control of the aircraft.

A WOW system failure resulting in the aircraft sensing weight on wheels while inflight may also result in the following conditions:

- Emergency and selective store jettison may be disabled.
- The FUEL DUMP switch may have to be manually held on to dump fuel.
- NWS may be active airborne. Ensure NWS is removed from HUD and deselect for landing.
- AOA indexer lights and approach lights may be disabled.
- Automatic throttle control may be disabled.
- The internal and external fuel tanks may be depressurized. External fuel transfer can be initiated by selecting ORIDE on the EXT TANKS switches.
- Autopilot may be disabled.
- The inflight idle throttle stop may be retracted, allowing the throttles to be moved to the ground idle position.
- The speedbrake may not automatically retract with flaps HALF or FULL.
- Pitot-static and AOA probe heating may be disabled unless PITOT ANTI ICE is selected ON.
- Total temperature probe heating may be disabled.

CHAPTER 15

Inflight Emergencies

15.1 ENGINE FIRE IN FLIGHT

See FIRE light in the Warning/Caution/Advisory Displays, figure 12-1. If an engine fire is indicated by a FIRE warning light, throttle affected engine OFF. A fire may be confirmed if the FIRE warning light stays on with the throttle OFF, or the light goes off and the system checks bad. For dual FIRE light cases where the pilot is unable to discern which FIRE light came on first, throttle left and right engine to as low as practical for flight and check engine instruments for engine condition. Once affected engine is determined, throttle affected engine OFF. Prior indications of high fuel flow, high EGT, rough running, or smoke and fumes may also confirm a fire. If engine stall is indicated, immediately place the throttle to OFF. Do not press the FIRE light again, as this will reopen the fuel shutoff valve. With an engine fire, lower hook as soon as possible. Excessive heat on hook release cable may make it impossible to lower the hook. On F/A-18A/B aircraft only, external transfer can be regained by pulling the HOOK circuit breaker and placing the HOOK handle UP. The hook will remain down and the HOOK light will be on.

15.2 AFTERBURNER FAILURE

Afterburner failure can be recognized by nozzle position. This may be the only symptom that is immediately recognizable. The afterburner has continuous ignition and attempts to light any time the throttle is above 50 % afterburner and the afterburner is not lit. If afterburner does not light after selection or blowout, reduce throttle to MIL and reselect afterburner when in a better environment.

15.3 UNRESPONSIVE ENGINE

A unresponsive engine may remain at high or low power or the power may vary randomly. There may be uncommanded throttle movement, the throttle may freeze, or throttle movement may have no effect. In the landing pattern, be prepared for an unexpected single-engine waveoff, landing, or bolter.

If the engine fails to MIL after deselecting afterburner, the MIL power lockup system may be the cause. Slowing to 250 knots and lowering the landing gear may allow normal engine operation.

If the cause of loss of engine control is a severed throttle cable, control may be gained via ATC. For ATC to engage, the PLA of each engine must match within 10 °, and both throttles must be less than MIL and greater than IDLE. Aircrew can approximate the parameters required by matching engine N₂ RPM.

If thrust is too high to permit landing, shut down the engine with the throttle. If the engine cannot be shut down with the throttle, press the FIRE light.

15.3.1 ENGINE STUCK AT MIL (AFTER DESELECTING AFTERBURNER)

RIGHT ENGINE

1. SLOW below 250 KCAS
2. LDG GEAR handle - DOWN

If normal engine operation is restored -

3. LDG GEAR handle - UP (if required)
4. Land as soon as practical.

If engine remains stuck at MIL -

3. Right throttle - OFF
4. Right FIRE light - PUSH
5. Refer to Single Engine Approach and Landing procedure.

LEFT ENGINE

1. LG circuit breaker - PULL

If normal engine operation is restored, for landing -

2. Slow below 250 KCAS.
3. LDG GEAR handle - DOWN
4. LG circuit breaker - RESET
5. Land as soon as practical.

If engine remains at MIL -

2. Left throttle - OFF
3. Left FIRE light - PUSH
4. Refer to Single Engine Approach and Landing procedure.

15.3.2 STUCK THROTTLE/ ENGINE FAILS TO RESPOND

Advancing throttle may cause engine to remain at high power with high fuel consumption rates.

1. Throttle affected engine - IDLE (if possible)

If throttle stuck at high power setting and continued operation not desired -

2. Throttle affected engine - OFF (if possible)
3. FIRE light affected engine - PUSH
4. Refer to Single Engine Approach and Landing procedure.

If continued engine operation is desired or required -

2. Consider use of ATC to attempt reduction of affected engine RPM.

NOTE

ATC will not engage with either RPM near MIL or IDLE.

- a. Adjust good engine throttle to match RPM.
- b. ATC - ENGAGE
- c. Initiate descent to reduce engine RPM via ATC.

Once affected engine RPM reduced to desirable level -

- d. ATC - DISENGAGE
3. Fly precautionary half-flap approach if practical.
4. Make arrested landing if practical. Refer to Arresting Gear Data Table.

If arresting gear not available or airspeed is difficult to control -

5. Consider shutting down affected engine.
 - a. Throttle affected engine - OFF (if possible)
 - b. FIRE light affected engine - PUSH
 - c. Refer to Single Engine Approach and Landing procedure.

15.4 ENGINE FAILURE

If an engine fails, the corresponding generator and HYD 1 (left engine) or HYD 2 (right engine) system will be lost. Either generator supplies sufficient power to operate all electrical items. A windmilling engine can cause repeated flight control transients as the hydraulic switching valves operate. Various FCS cautions will come on intermittently. After the rpm has decreased to near zero, the transients will cease, the FCS cautions will go off, and FCS operation will be normal. To prevent repeated switching valve cycling, avoid stabilized flight where engine windmilling rpm produces hydraulic pressure fluctuations between 800 to 1,600 psi. If control of a surface is lost due to a frozen or sticking switching valve, attempt to unstick the valve by gently cycling the flight controls, and reset the FCS. If the failed engine core is rotating freely and rpm is below 30 %, use the APU or engine crossbleed to retain both HYD systems. If the right engine is being rotated with crossbleed to provide normal systems operation and fuel flow on the left engine is reduced below 2,000 pph (as during landing), the right engine hydraulic pump may not provide sufficient flow for nosewheel steering and normal brakes. Refer to Hydraulic Failure, this chapter, for results of loss of a hydraulic system. During engine crossbleed, the feed tank of the failed engine may not gravity transfer to the operating engine feed tank. To prevent this, gravity transfer from the inoperative feed tank may be initiated by discontinuing crossbleed if the failed engine AMAD operation is not required or interrupting fuel feed to the failed engine system by pressing the failed engine FIRE button. Extended operation with the FIRE button pressed may result in a corresponding L or R AMAD caution.

If both engines fail, both generators will drop off line as rpm decays through 60%. Refer to Double Generator Failure, this chapter, for results and procedures. A minimum of 12% N_2 is required for ignition. At least 350 knots is required to maintain 12% rpm. If rpm has decayed below 12%, airspeeds significantly greater than 350 knots may be required to regain 12% rpm especially at lower altitudes. If conditions do not allow for a 350 knot descent, APU restart is the last alternative. Refer to Restart procedures, this chapter.

15.5 ASYMMETRIC THRUST EFFECTS

During single engine flight with external stores, consideration should be given to dump fuel and stores jettison to reduce gross weight, reduce drag and/or alleviate an aggravating asymmetrical loading. Close attention to airspeeds is required in all loadings to maintain airspeed at or above single engine maximum endurance speed (5.6 to 5.8° AOA). Maneuvering should be limited to that required to return to base using shallow bank angles and avoiding turns into the failed engine. In straight and level flight at zero bank angle, some amount of rudder deflection and/or trim will be required to offset the yawing moment from asymmetrical thrust. A slight (up to 5°) bank into the good engine should reduce this rudder requirement. A straight-in half-flap approach should be performed.

NOTE

- Failure of the variable exhaust nozzle in the full open position adversely affects single and dual engine performance. No cautions are available to the pilot except for VEN position indications on the EMI/IFEI.
- Single engine waveoffs and bolters with F404-GE-402 (EPE) engines installed may require full rudder and coordinated lateral stick to control aircraft yaw and roll produced by asymmetric thrust.

15.6 ENGINE STALL

An engine stall is a disruption of airflow that has resulted from mechanical damage to the engine or adverse flight conditions. Adverse flight conditions that can cause stalls include high altitude, low airspeeds, high sideslip or high angle of attack, usually in combination with throttle transients, especially, the throttle chop/re-advance combination. Stalls may occur in the engine fan or high pressure compressor and are one of two types: pop or surge stalls, and hung stalls.

Pop or surge stalls - The majority of stalls are pop or surge stalls. These are usually indicated by airframe vibration, engine surges, engine noises such as loud banging, or momentary exhaust fireballs. The engine almost always recovers on its own within 2 seconds without any pilot corrective action.

Hung stalls - Hung stalls occur infrequently. They may initiate from a pop stall and are detectable as a lack of response to throttle movement and/or rpm rollback and EGT increase. Without corrective action, engine rpm may eventually stabilize near or below idle rpm.



Due to inadequate turbine cooling during the stall, a prolonged hung stall (over 1 minute) can result in turbine overtemperature damage without indicating an EGT overtemperature.

Engine stalls may also be indicated by the “Engine Left (Right)” voice alert, L/R IN TEMP, L/R FLAMEOUT, and/or L/R STALL

CAUTION

Dual engine hung stalls have occurred requiring individual engine shut-down to regain normal engine operation. With both engines in a stalled condition, one or both generators may be inoperative. With one generator inoperative, shut down and restart the engine with the inoperative generator first.

If the stall does not clear itself, a prompt chop to IDLE may clear it. Checking for stall clearing at idle involves observing a drop in EGT with the NOZ position opening to the idle position, followed by normal response to the throttle. If the stall cleared at idle, the likelihood of engine damage is extremely remote, and the affected engine may be used for approach and landing as required.

- *1. Throttle affected engine - IDLE

If the stall does not clear -

- 2. Throttle affected engine - OFF
- 3. Refer to Single Engine Approach and Landing procedure.

If the stall clears -

- 2. Check engine response at a safe altitude.
- 3. Land as soon as practical.

15.7 RESTART

Ignition is on with throttle at IDLE or above and rpm between 12 % and 45 % with engine flamed out. At least 350 knots is required to maintain 12 % rpm. Continuing automatic restart attempts at high altitude or high AOA may cause the engine to overtemp. In this case, place the throttle OFF until in a better start environment. The optimum restart envelope is below 25,000 feet. If the engine is shut down from a high power setting and rpm decays to 0 %, temporary rotor binding may occur. In this case, engine rotation will not be regained until the engine cools evenly (about 10 to 15 minutes). If crossbleed is not used, airspeeds significantly greater than 350 knots may be required to regain 12 % rpm especially at lower altitudes. APU restart is the last alternative.

NOTE

Windmill restart attempts made after rpm has degraded to 0 % may require up to 450 knots to obtain 12 % rpm for ignition.

If APU restart is required, HYD ISOL ORIDE should first be selected for 10 seconds prior to APU start, assuming good HYD 2B. With the APU switch ON and the green READY light on, the engine crank switch may then be used to crank the engine for restart. The APU restart envelope is below 250 knots, below 10,000 feet. See figures 15-1 thru 15-4.

CAUTION

Attempting to restart an engine that has flamed out for no apparent reason may result in an engine bay fuel leak/fire.

If rpm above 30% -

1. Throttle affected engine - IDLE or above

If rpm below 30% -

1. Throttle good engine - 80% MINIMUM AND FUEL FLOW 1,900 PPH MINIMUM (Recommended above 85% to avoid MECH reversion)
2. ENG CRANK switch - L or R (affected side)
3. Throttle affected engine - IDLE or above
4. Monitor EGT during start (815°C maximum).

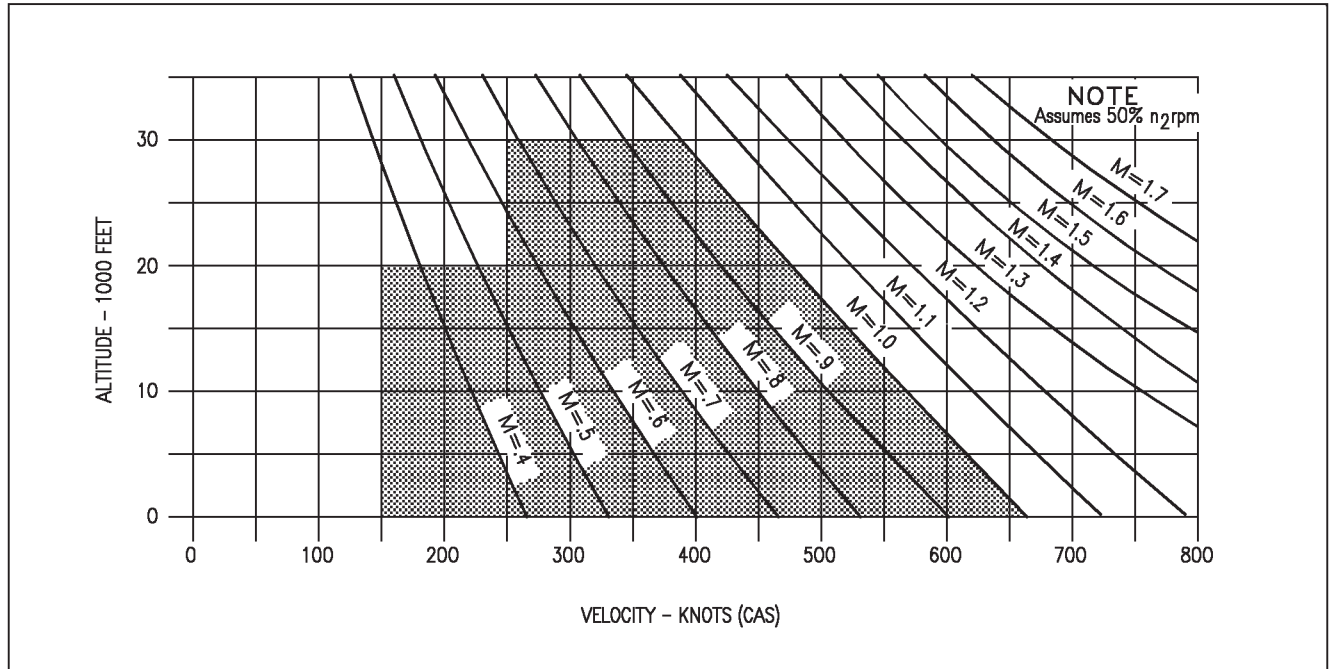

1BAC-NFM-00-(59-1)31-CATI

Figure 15-1. Spooldown Restart Envelope

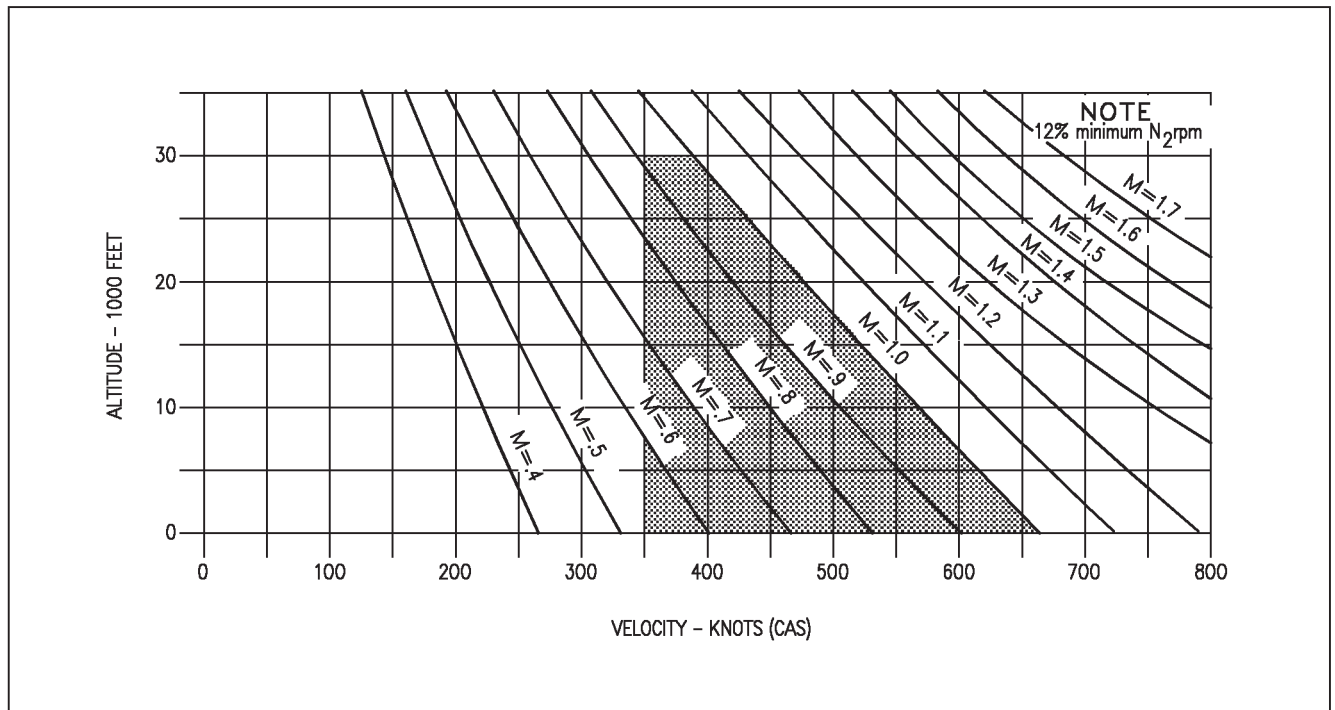

1BAC-NFM-00-(60-1)31-CATI

Figure 15-2. Windmill Restart Envelope

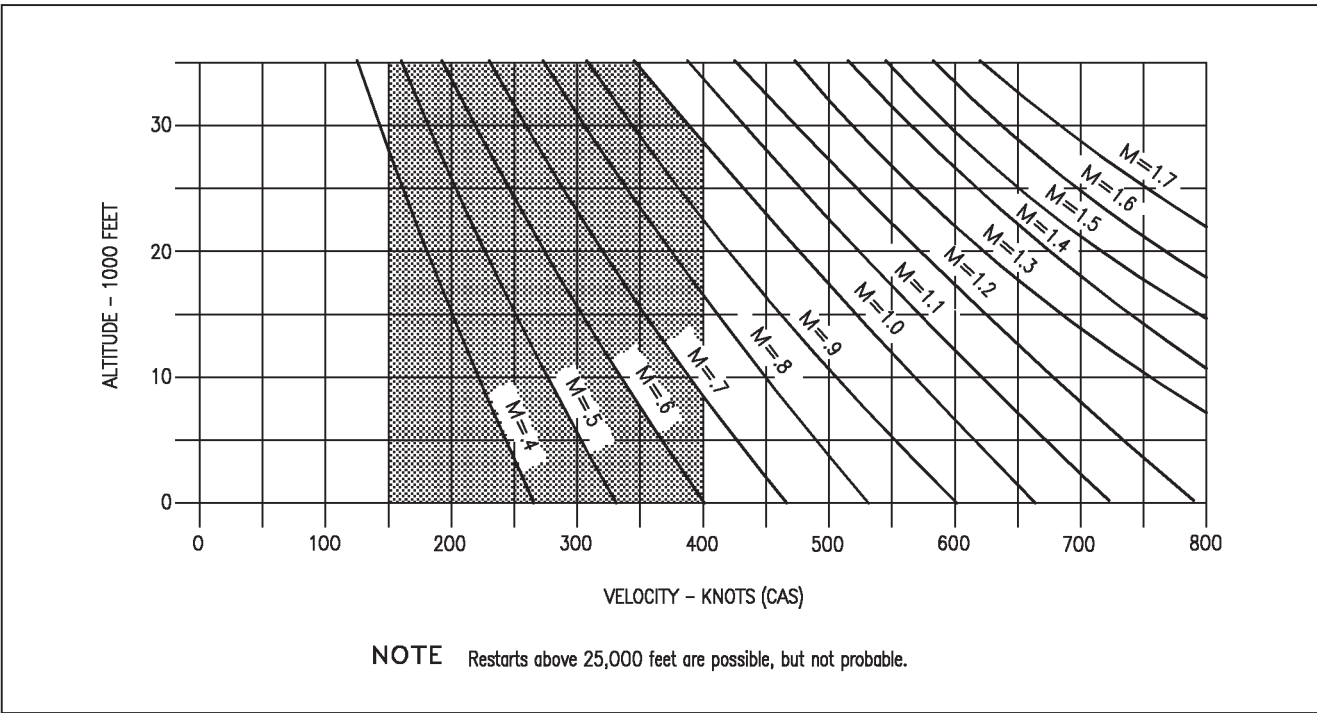

18AC-NFM-00-(61-1)31-CATI

Figure 15-3. Crossbleed Restart Envelope

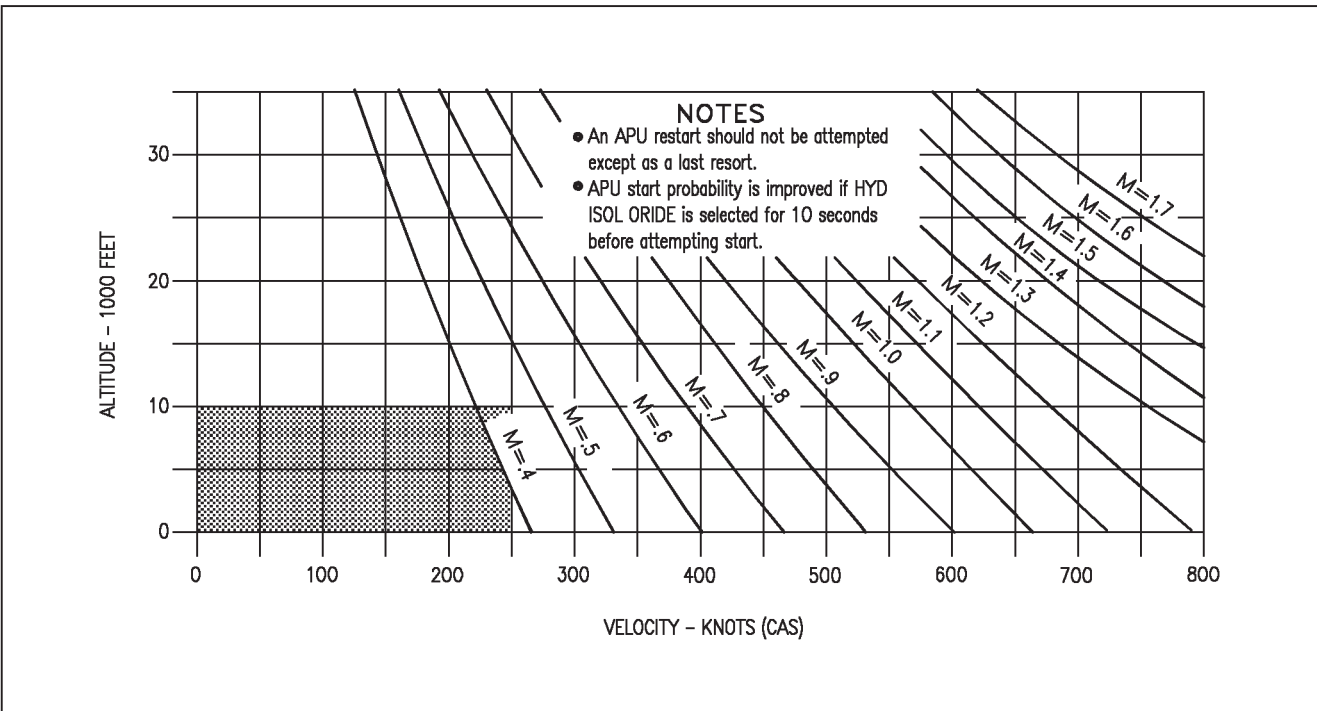

18AC-NFM-00-(62-1)31-CATI

Figure 15-4. APU Restart Envelope

15.8 POWER TRANSMISSION SHAFT (PTS) FAILURE

Failure of the PTS will result in the display of the associated GEN, BOOST LO and both HYD circuit cautions. If the shaft does not fail at the design shear point, it could be flailing. A flailing PTS could damage flammable fluid components in the engine bay which could result in an engine bay fire. Consideration should be given to shutting down the associated engine to minimize the risk of an engine bay fire.

15.9 HYDRAULIC FAILURE

Hydraulic failures are indicated by displaying HYD 1A, 1B, 2A, 2B circuit cautions either singly or in combinations. Failure effects can be analyzed by referring to figure 15-5, Hydraulic Flow Diagram, and figure 15-6, Hydraulic Subsystems Malfunction Guide. Failures which affect flight controls may also cause an FCS caution. Remarks regarding the flight control effects due to hydraulic failures are shown in figure 15-7.

Dual circuit cautions in the same system may indicate a pump failure or reservoir depletion. Refer to the hydraulic system pressure gage to determine if pressure fluctuations are present. If system pressure has decreased to zero with no fluctuations, the pump shaft has probably sheared from the AMAD and no further action is required.

Stabilized system pressure below 2,000 psi or fluctuations in system pressure is indicative of a failing hyd pump that has yet to shear. This may result in overheating the pump and a subsequent AMAD bay fire. Securing the associated engine will minimize the potential for pump overheat.

Dual circuit cautions in the same system preceded by circuit caution sequencing is probably an indication of a fluid leak in a part of the system not protected by reservoir level sensing (RLS). This leak can not be isolated and all the hydraulic fluid in that system will be lost. If this occurs, the circuit A caution comes on and, sometime later, goes off and the circuit B caution comes on. As the fluid continues to leak, the circuit B caution goes off and for a relatively short time (less than 7 % of the time since the circuit A caution first appeared), both circuits A and B operate and hydraulic pressure indicates normal since there is a small amount of fluid remaining in the reservoir. When pressure drops below approximately 1,500 psi, both circuit A and B cautions come on. To summarize, the sequence of indications during an unisolated hydraulic fluid leak is: (1) only HYD 1A (2A) on, (2) only HYD 1B (2B) on, (3) both off, and (4) HYD 1A (2A) and HYD 1B (2B) on. Prolonged flight following display of both cautions may result in overheating the pump and subsequent AMAD bay fire. Securing the associated engine if prolonged flight is anticipated minimizes the potential for pump overheat.

NOTE

When an engine is secured in flight, the corresponding HYD 1 (left engine) or HYD 2 (right engine) system is lost and the associated hydraulic cautions HYD 1A 1B (left engine) and HYD 2A 2B (right engine) appear as rpm decreases to near zero. If the hydraulic cautions were not present prior to securing the engine and a failure or leak in the associated hydraulic system is not suspected, the FCS may be reset to attempt to regain a failed control surface and unstick a frozen or sticking valve.

NOTE

- Hydraulic system capacity is dependent on respective engine rpm. Excessive simultaneous hydraulic system demands (i.e., landing gear activation, flap movement, and multiple flight control inputs, etc.) combined with HYD system failure may exceed system capacity or result in FCS reversion to MECH. If practical, maintain engine with operating HYD system at or above 85 % rpm.
- With a HYD 2A and HYD 2B failure, consider disengaging nosewheel steering (paddle switch) after touchdown to conserve APU accumulator pressure. This would reserve pressure for slower speeds (less than 30 knots) where differential braking is not as effective.
- With a hydraulic leak downstream from the brake valve, the HYD 2 cautions may only appear when brakes are applied. Once brakes are released, all cautions may disappear. If this occurs, do not taxi. Continual use of brakes or emergency brakes will lead to total loss of HYD 2 fluid.

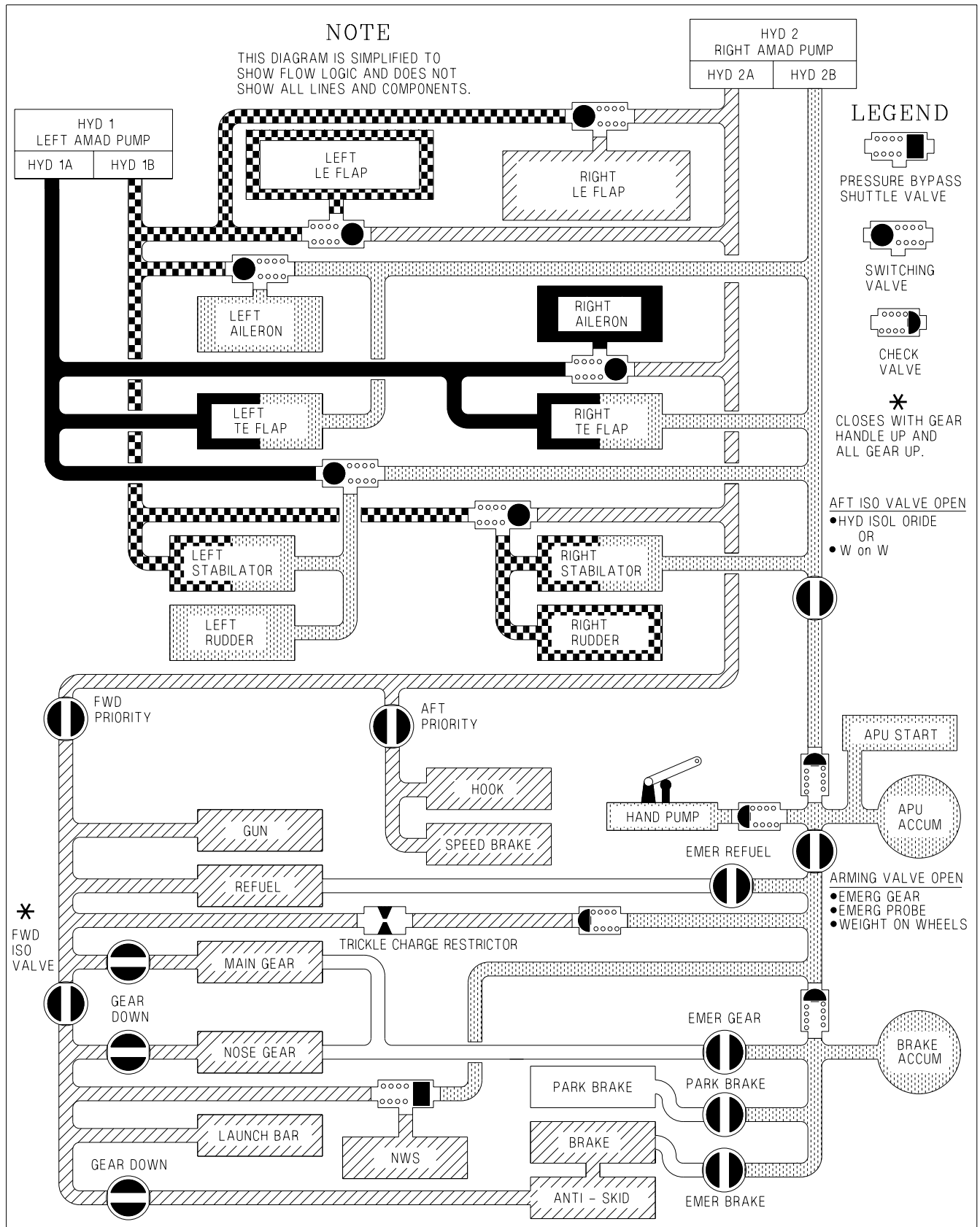

ADA520-63-1-045

Figure 15-5. Hydraulic Flow Diagram

HYD FAILURE DISPLAYS	FLIGHT CONTROLS LOST	SURFACES	FLIGHT CONTROLS LOST	HYD FAILURE DISPLAYS
		LEF AIL/TEF RUD STAB		
HYD 1B				HYD 1A
HYD 2B				HYD 2A
		LEF AIL/TEF RUD STAB		
HYD 1B				HYD 1A
HYD 2A				HYD 2B
		LEF AIL/TEF RUD STAB		
HYD 1A				HYD 1A
HYD 1B				HYD 2A
HYD 2A				HYD 2B
		LEF AIL/TEF RUD STAB		
HYD 1B				HYD 1A
HYD 2A				HYD 1B
HYD 2B				HYD 2B
	MAY BE UNCONTROLLABLE		MAY BE UNCONTROLLABLE	

■ = CONTROL SURFACE(S) INOPERATIVE

ADA520-139-1-058

Figure 15-6. Hydraulic Subsystems Malfunction Guide

FLIGHT CONTROL EFFECTS DUE TO HYDRAULIC FAILURES	
Flight Control Failure ¹	REMARKS
Any Surface Off	<ul style="list-style-type: none"> • General Limits: <ul style="list-style-type: none"> • 10° AOA for flaps AUTO • On-speed AOA for flaps HALF/FULL • 2g max • Minimize sideslip • Half lateral stick • Loss of autopilot
AIL Xs	<ul style="list-style-type: none"> • Expect slightly higher approach speeds. For flaps FULL, approach speed will increase by about 8 knots. Flaps HALF, 16 knots. • Avoid over-controlling lateral stick inputs as it can cause lateral PIO especially when approaching touchdown.
RUD Xs	<div style="text-align: center;">WARNING</div> <ul style="list-style-type: none"> • Full opposing rudder may not be sufficient to prevent a departure when single engine if MAX power selected. Large single engine throttle transients can cause significant yaw and roll. • Failure to maintain AOA below 10° and balanced flight can result in a departure in yaw and roll that is unrecoverable. • Rudder toe-in is removed. Bolter performance degraded. • Counter any roll-off with rudder. Countering roll-off with lateral stick alone increases adverse yaw and aggravates roll-off. • Line-up control is degraded. Make slow and smooth line-up corrections (especially if single engine).
LEF Xs	<div style="text-align: center;">CAUTION</div> <ul style="list-style-type: none"> • With any HYD 1B or HYD 2A failure, DO NOT RESET FCS. • Do not exceed 7° AOA if LEF extension less than 10°. • Opposite LEF held frozen. TEFs held frozen in flaps AUTO. • Stall margin reduced for LEF locked above 5° LED. • Buffet likely with LEF near 0° at lower AOA. • Expect slight roll-off as airspeed changes during a waveoff or bolter that is easily controllable. • Glideslope control degradations may be more pronounced depending on frozen LEF position. Wing stores will further degrade glideslope control. • Power corrections will translate into an airspeed change before a rate of descent change is noticed. This may lead to a tendency to over-control glideslope. Anticipatory throttle inputs are key to glideslope control. • Bolter/waveoff performance is degraded and climb-out attitude will appear flatter than normal. • If AUTO is selected after being in flaps HALF or FULL, the TEFs will not retract except for loads alleviation (no higher than 17°). While in AUTO, momentary selection of GAIN ORIDE will command the TEFs to retract to 3° TED. However, the operating LEF will also be commanded to move to 3° LED. This may drive a controllable but undesirable left versus right LEF split if the failed LEF is not near 3° LED. Therefore, only select GAIN ORIDE if TEF retraction is essential for range or fuel considerations.
Note: (1) Surface inoperative due to lack of hydraulic pressure.	

Figure 15-7. Flight Control Effects Due To Hydraulic Failure (Sheet 1 of 2)

FLIGHT CONTROL EFFECTS DUE TO HYDRAULIC FAILURES (CONT)	
Flight Control Failure ¹	REMARKS
STAB Xs	<p style="text-align: center;">CAUTION</p> <p>Aircraft reverted to MECH due to stab having inadequate hydraulic power. This can be the result of excessive, simultaneous hydraulic system demands exceeding system capacity (e.g., landing gear activation, flap movement, and multiple flight control inputs) combined with HYD system failure. Can be reset if HYD pressure >1,500psi. If practical, maintain engine with operating HYD system at or above 85 % rpm.</p>
TEF Xs	<p style="text-align: center;">WARNING</p> <p>Slower engine response to throttle changes may result in excessive sink rates under high WOD conditions. The recovery WOD should be kept as close as possible to the Aircraft Recovery Bulletin recommendations.</p> <ul style="list-style-type: none"> • TEF driven to 0°. • Approach speeds are significantly higher and on-speed power settings are near idle. • Expect slower engine response. • Aircraft response to power corrections is sluggish and small in magnitude. Power corrections will translate into an airspeed change before a rate of descent change is noted. Expect larger, longer, and more anticipatory power corrections to be required in order to effect a glideslope change. Aggressive, well-timed, and anticipatory throttle inputs are key to glideslope control. • There is a tendency to over-control power due to the low approach power setting and the longer time required to effect a change. • Time to achieve positive rate of climb is longer during a bolter/waveoff due to sluggish throttle response. Climb-out attitude will appear flatter than normal.
<p>Note: (1) Surface inoperative due to lack of hydraulic pressure.</p>	

Figure 15-7. Flight Control Effects Due To Hydraulic Failure (Sheet 2 of 2)

15.10 FUSELAGE FUEL LEAK

The possibility of fire is normally of prime concern with any fuel leak. However, with a massive leak, the fuel loss itself must be dealt with promptly and correctly to ensure that sufficient fuel remains to return to base. Fuel loss rates in excess of 1000 lbs/minute have been observed from failed main fuel lines. Since leaks may occur upstream of the throttle-operated fuel shutoff valve in the fuel control, shutting down the throttle may not correct the problem. Depressing a FIRE light closes the airframe-mounted fuel shutoff valve for that engine at the feed tank and stops fuel flow through the main fuel line. Depressing the good-side FIRE light may result in flameout of both engines.

The pilot may not be able to visually determine which side is leaking. Use a wingman, when available, and check for secondary indications to determine the side of the leak. Cockpit indications may include any or all of the following:

- L/R BOOST LO caution
- L/R AMAD caution
- FUEL LO caution
- Rapid decrease of fuel quantity in one feed tank
- Erratic engine operation at high power settings
- Abnormal fuel flow indications

Land as soon as possible. A normal landing with light braking is recommended to prevent hot brakes. Turn the aircraft into the wind and depress both FIRE lights before shutting down the throttles.

If a fuselage fuel leak is suspected/observed -

WARNING

Use of afterburner or APU may result in an engine bay fire.

1. Afterburners - DESELECT
2. Analyze Indications:
 - L/R BOOST LO caution
 - L/R AMAD caution
 - FEED tank fuel quantities
 - Engine instruments
3. FIRE light (suspect engine) - PUSH

CAUTION

Pressing the good engine FIRE light may result in flameout of both engines.

If leak continues -

4. FIRE light (suspect engine) - RESET

5. Restart dead engine.
6. FIRE light (other engine) - PUSH

If leak still continues -

7. FIRE light (other engine) - RESET
8. Restart dead engine.
9. Land as soon as possible.

WARNING

Hook sparks during an arrested landing may increase the probability of fire.

After landing -

10. Turn aircraft into the wind.
11. Secure both engines using FIRE lights.
12. Throttles - OFF

15.11 FUEL TRANSFER FAILURES

15.11.1 Aircraft 161353 THRU 161519 BEFORE AFC 039. Failure of fuel transfer from either tank 1 or 4 will result in the fuel quantity in the failed tank remaining higher than normal. Fuel from the good transfer tank will keep both engine feed tanks near full. This prevents gravity transfer from the failed transfer tank. When the good transfer tank empties, the failed transfer tank can gravity transfer to its feed tank. The engine on the good side is now supplied from only its feed tank while the engine on the bad side is supplied from both its feed tank and the associated transfer tank thru gravity transfer. This causes the feed tank on the good side to reach the FUEL LO level first unless the throttle on the good side is reduced. Since gravity transfer from tank 1 or 4 is less than engine demand at high power, it is possible to have as much as 700 pounds of unusable fuel for approach and landing after failed tank 1 transfer or 2,500 pounds after failed tank 4 transfer. With 2,500 pounds remaining in tank 4, the center of gravity may be aft of the aft limit. Since fuel dump from either tank 1 or tank 4 to correct this condition is not possible, asymmetric thrust must be used to balance fuel in the feed tanks.

1. Use higher power on engine whose feed tank has most fuel (tank 2 feeds left engine, tank 3 feeds right engine).

CAUTION

Depletion of either feed tank may result in AMAD overheat and loss of hydraulic and electrical power supplied from that engine.

15.11.2 Aircraft 161353 THRU 161519 AFTER AFC 039 AND 161520 AND UP. Failure of fuel transfer from either tank 1 or 4 will result in the fuel quantity in the failed tank remaining higher than normal. If tank 1 transfer fails, fuel from tank 4 will keep both engine feed tanks near full. This prevents gravity transfer from tank 1. When tank 4 empties, the right engine is supplied only from tank 3 while the left engine is supplied from both tank 2 and tank 1 through gravity transfer. This causes tank 3 to reach the FUEL LO level first unless the right throttle is reduced.

If tank 4 transfer fails, tank 1 will not transfer, due to CG control scheduling, until the FUEL LO warning comes on. This will initially appear to be a failure of both tank 1 and tank 4 fuel transfer. As the fuel level in tanks 2 and 3 drops, tanks 1 and 4 will gravity transfer to their respective feed tank. When either feed tank reaches the FUEL LO level, tank 1 will transfer cyclically to both feed tanks as the FUEL LO comes on and goes off. As tank 1 transfers, the CG moves aft rapidly. When tank 1 empties, tank 4 continues gravity transfer to tank 3 as the tank 3 fuel level drops.

Since gravity transfer from tank 1 or 4 is less than engine demand, it is possible to have as much as 700 pounds of unusable fuel for approach and landing after failed tank 1 transfer or 2,500 pounds after failed tank 4 transfer. With 2,500 pounds remaining in tank 4, the center of gravity may be aft of the aft limit. Refer to CG Travel Due To Fuel Consumption charts, Chapter 11.

If tank 1 transfer failed -

1. Right throttle - REDUCE

If tank 4 transfer failed -

2. Land as soon as practical.



Depletion of either feed tank may result in AMAD overheat and loss of hydraulic and electrical power supplied from that engine.

15.12 FEED TANK TRANSFER FAILURE

On aircraft without boost pump pressure switches installed, a feed tank imbalance may occur at low fuel state (feed tank fuel only). If a boost pump fails on these aircraft, an imbalance results and afterburner operation is not available. In this condition, one feed tank empties before the other tank begins to feed. An AMAD caution comes on when cooling fuel flow is lost to the respective heat exchanger. AMAD caution procedure should be followed.

15.13 EXTERNAL TANK TRANSFER FAILURE

1. F/A-18A/B only: HOOK handle - CONFIRM UP
2. FUEL page/Fuel Quantity indicator/IFEI - IDENTIFY EXT TANK WITH TRAPPED FUEL

Perform the following steps while monitoring fuel transfer, tank quantities, and lateral asymmetry -

3. EXT TANKS switch(es) - ORIDE
4. EXT TANKS switch(es) - CYCLE TO STOP AND BACK TO ORIDE

- 5. PROBE switch - CYCLE
- 6. BLEED AIR knob - CYCLE THRU OFF TO NORM
- 7. Apply positive and negative g.
- 8. F/A-18C/D ONLY: FUEL PAGE/SDC - RESET

If practical -

- 9. Descend below freezing level and repeat steps 4 thru 8.
- 10. LDG GEAR and HOOK handles - DOWN
- 11. LDG GEAR and HOOK handles - UP
- 12. Perform in-flight refueling.

If/when transfer complete but prior to landing -

- 13. EXT TANKS switch(es) - NORM

If external wing tank fuel trapped -

- 14. Ensure lateral asymmetry within limits for landing.

NOTE

On F/A-18C/D aircraft, selecting ORIDE on both EXT TANKS fuel control switches may inhibit centerline tank transfer.

FOR CARRIER LANDING -

If centerline tank is still over 500 pounds -

- 15. Divert or SELECT JETT tank.

15.14 UNCOMMANDED FUEL DUMP

Refer to DUMP OPEN caution.

15.15 EMERGENCY TANKER DISENGAGEMENT

Emergency disengagement may be required if difficulties occur in either the tanker or the receiver aircraft. Emergency breakaway signals are by radio transmission and/or turning on the lower anti-collision lights. If the situation allows, normal, but expeditious, disconnect procedures should be followed to minimize the possibility of aircraft damage.

CAUTION

The following procedures may result in damage to the tanker and/or receiver aircraft.

1. Throttles - IDLE
2. SPEEDBRAKE switch - AFT

15.16 CSC MUX FAILURE

The following equipment is inoperative with a CSC MUX failure:

- Radar altimeter/CFIT protection
- Voice alerts/warnings
- Radio control (channel control only thru UFC backup)
- Tacan
- Radar beacon
- SDC reset function
- IFF (and inherently M4, i.e., reply, caution, etc.)
- Lock/shoot lights
- TACTS functions
- ILS control degrade (ILS can only be selected by the ILS/DL switch on the left console.)
- EMCON control (will not be able to go into EMCON)

15.17 DOUBLE GENERATOR OR DOUBLE TRANSFORMER-RECTIFIER FAILURE

Failure of both generators or both transformer-rectifiers will cause the BATT SW caution light to come on if the battery switch is ON. Failure of both generators can be recognized by loss of all displays.

15.17.1 Double Generator Failure. Double generator failure may be caused by a fault within the radar. In this case, the generators will not reset until the radar is turned OFF. On aircraft 163119 AND UP, a double generator failure with WOW results in the battery switching off after 5 minutes. If a double generator failure occurs on a catapult shot or during field takeoff that is not aborted and if the battery switch remains ON, all electrical power is lost 5 minutes later and the flight controls revert to MECH ON. In this case it is advisable to switch to ORIDE until commencing final approach and then switch back to ON. The battery will then remain on for another 5 minutes. Should the battery switch off, power can be regained for another 5 minutes by switching to OFF or ORIDE and back to ON. Monitor the voltmeter for emergency and utility battery status.

15.17.2 Transformer-Rectifier Failure. Failure of both transformer-rectifiers can be recognized by the loss of the HUD, bleed air system, and FCS channels 3 and 4 with an FC AIR DAT caution on the DDIs. The loss of boosted throttles and cockpit air conditioning/pressurization provide an immediate indication of dual transformer-rectifier failure. If the BATT SW light does not come on when the

generators or transformer-rectifiers fail, the FCS will switch to MECH ON after 7 to 10 seconds unless the battery switch is placed to ORIDE. The utility and emergency batteries will provide limited dc power for about 20 minutes. On aircraft 161702 AND UP with double transformer-rectifier failure, time is not critical since the U battery and battery charging TRU will power the start and essential buses. If either battery charge is low or the battery switch is in ORIDE, time will be less. The time may be extended by reducing electrical load. Minimize trim actuation and UHF transmission. Consider turning battery operated equipment off where practical. Equipment requiring ac power only will remain operable with a double transformer-rectifier failure and need not be turned off to conserve battery power. After setting speed between 200 to 300 knots, the FCS CHAN 1 and FCS CHAN 2 circuit breakers may be pulled. This shuts down all electrical flight control after 7 to 10 seconds and the system reverts to MECH ON where all control is with the mechanical differential stabilators (ailerons/rudders inoperative). Ensure FCS CHAN 1 and CHAN 2 circuit breakers are both reset prior to landing. If system does not reset to CAS, attempt FCS reset. Higher than normal pitch attitudes and/or high fuel consumptions results in an extremely aft CG (possibly aft of the CG limit depending on the flight condition).

WARNING

Extreme caution should be used in MECH ON with ailerons/rudders inoperative. Flight in this configuration has not been flight tested; however, flying qualities are significantly different from the CAS aircraft.

On aircraft 161353 THRU 161528, remaining time may be estimated as the U BATT light comes on with about 75 % of the total time remaining and the E BATT light comes on with about 25 % of the total time remaining. On aircraft 161702 AND UP, battery status is indicated on the U/E voltmeter. External fuel does not transfer. External stores may be jettisoned. Reset FCS CHAN 1 and FCS CHAN 2 circuit breakers before landing. See Emergency Power Distribution, figure 15-8, for operative and inoperative equipment.

If BATT SW caution light not on -

- *1. BATT switch - ORIDE
2. RADAR knob - OFF
3. GEN switches - CYCLE (double generator failure)
4. Consider the following to conserve battery power:
 - Minimize trim use.
 - Minimize UHF transmissions (consider use of survival radio).
 - If Double GEN failure on all aircraft, pull FCS CH1 and 2 (will result in MECH ON).
 - If Double TR failure on aircraft 161701 and below, pull FCS CH1 and 2 (will result in MECH ON)
 - A+ aircraft - SUCURE INS
5. Land as soon as possible.

For landing -

6. If FCS CHAN 1 and 2 circuit breakers pulled - RESET CIRCUIT BREAKERS SIMULTANEOUSLY - WAIT 30 SECONDS - PRESS FCS RESET BUTTON.

7. Refer to Landing Gear Emergency Extension procedure.



After emergency extension of the landing gear with a good HYD 2A system, failure of the normal brakes should be anticipated.

8. Make a Short Field Arrested Landing (if available).

9. Use emergency brakes.

15.18 LOSS OF DC ESSENTIAL BUS

The DC essential BUS receives power through the utility battery contactor from the left 28 volt DC BUS. A defective utility battery contactor can cause loss of power to the DC essential BUS. A loss of the DC essential BUS is indicated by disassociated failures and warnings of the DC essential equipment without loss of other AC/DC equipment. This failure is characterized by the following indications:

- FCCA 1 and 2 Xd out
- Fire extinguisher READY light on
- L and R OIL PR cautions
- UHF 1 and 2 inoperative
- Fuel dump inoperative
- Landing gear position lights inoperative
- Hook position light inoperative
- NWS caution
- SPN RCYVY light on
- FC AIR DAT caution
- BINGO caution

If a loss of the DC essential BUS is suspected -

1. BATT switch - ORIDE (Battery remains charged)

If DC essential power not restored -

2. BATT switch - ON
3. Land as soon as practical.

NOTE

APU and crossbleed are not available.

BOTH GENERATORS INOPERATIVE BATTERIES IN HIGH STATE OF CHARGE

OPERATIVE EQUIPMENT

ENGINE

- ☆Afterburner ignition
- ☆Anti-icing
- APU ready light
- APU start
- Bleed air leak detectors
- ☆Engine ignition
- 9 Engine monitor indicator
- Engine start
- Fire detectors and extinguishers
- Fuel dump
- 10 IFEI (RPM EGT, and Fuel quantity with MODE button pushed)
- ☆Internal fuel transfer

FLIGHT CONTROLS

- DEL (direct electrical link)
 - CAS
 - FCS CH 1 & 2
 - Flaps
 - Flap position indicator
 - Manual flight control mode select actuator (ratio changer)
 - Pitch trim actuator
- ### FLIGHT INSTRUMENTS
- ☆Standby airspeed/Mach indicator(s)
 - ☆Standby altimeter(s)
 - Front cockpit Standby attitude reference indicator
 - ☆Standby rate-of-climb indicator(s)
 - Standby turn needle(s)

LIGHTING EQUIPMENT

- Caution lights panel (less GEN and fuel level low LTS)
- 1 Emergency instrument light
- Master caution light(s)
- 11 NVG floodlights
- Utility flood light(s)

NAVIGATION EQUIPMENT)

- 6 COMM 1 R/T
- IFF emergency

OTHER

- ☆Arresting hook extension
- Canopy
- Emergency air refueling
- Emergency jettison
- FCS ram air selection
- Intercom
- 2 ☆Landing gear (emergency system)
- Landing gear position indicator
- Voice alerts (APU fire, engine fire, bleed air)

INOPERATIVE EQUIPMENT

ENGINE

- Anti-ice control
- Bleed air system
- External fuel transfer
- FUEL LO warning light
- Fuel tank pressure light
- 9 Fuel quantity
- Inlet duct doors
- Inlet ice detector
- 10 Integrated Fuel Engine Indicator (all functions except RPM, EGT and Fuel quantity with MODE button pushed)
- Internal fuel tank pressurization
- Internal wing fuel inhibit
- N₄ lockup
- Throttle boost
- Wing diverter valves

LIGHTING EQUIPMENT

- Approach lights
- Caution/advisory displays
- CK ECS caution light is not fully functional
- 17 Console lights
- Flood lights
- Formation lights
- GEN caution lights
- Instrument lights
- Landing/taxi lights
- Lights test switch
- Position lights
- Strobe lights

OTHER

- Air refueling light and normal probe extension
- Anti-skid
- Arresting hook retraction
- ATARS
- Battery charger(s)
- Cabin ram air selection
- Cockpit DDI/HIs/MPCD
- CPVWS pressure sensing
- Data link
- Hook warning light
- Hydraulic pressure indicator
- JHMCS
- Landing gear (normal system)
- Landing gear warning tone
- Master caution tone
- Nosewheel steering
- OBOGS
- OBOGS monitor
- 13 Oxygen gauge
- 13 Radar
- 12
- 3 ALR-67 radar warning rcvr
- Selective jettison
- Voice alerts (altitude, bingo, check gear, engine, fuel low, flight computer hot, flight controls, mode 4 reply, power, pull up, roll out)
- 3 Video tape recorder
- Weapons fire/launch/release
- Windshield anti-ice/rain removal

FLIGHT CONTROLS

- Autopilot
- 11 FCS CH 3 & 4
- 16 Speedbrake
- 14 Speedbrake advisory light

NAVIGATION EQUIPMENT

- ADF
- 11 COMM 2 R/T
- 16 DMS
- EGI
- 14 RADAR altimeter
- GPS
- IFF
- ILS
- INS
- KY-58
- Radar beacon
- TACAN

FLIGHT INSTRUMENTS

- Aft cockpit Standby reference indicator
- AOA indexer lights
- HUD
- Left and right pitot heaters

☆Equipment still operative after batteries depleted.

- 1 F/A-18A and FWD CKPT of F/A-18B only
- 2 F/A-18B
- 3 Aircraft 161702 AND UP

- 6 Frequency selection lost. Will operate on last selected frequency. Guard transmit receive can be selected by COM G XMT switch.
- 9 Aircraft 161353 THRU 163175
- 10 Aircraft 163427 AND UP

- 11 Aircraft 163985 AND UP
- 12 Aircraft 161353 THRU 164068
- 13 Aircraft 164196 AND UP
- 14 Aircraft 165171 AND UP
- 16 Aircraft AFTER AFC 231 or AFC 232
- 17 Aircraft AFTER AFC 244

Figure 15-8. Emergency Power Distribution (Sheet 1 of 4)

**BOTH TRANSFORMER-RECTIFIERS INOPERATIVE
BOTH GENERATORS OPERATIVE
BATTERIES IN HIGH STATE OF CHARGE**

OPERATIVE EQUIPMENT

ENGINE

- ☆ Afterburner ignition
- ☆ Anti-icing
- ☆☆ APU ready light
- ☆☆ APU start
- ☆☆ Bleed air leak detectors
- ☆ Engine ignition
- 9 ☆☆☆ Engine monitor indicator
- ☆☆ Engine start
- ☆☆ Fire detectors and extinguishers
- ☆☆ Fuel dump
- 9 ☆☆☆ Fuel quantity
- 10 ☆☆☆ Integrated Fuel Engine
- ☆ Internal fuel transfer

FLIGHT CONTROLS

- ☆☆ CAS
- ☆☆ DEL (direct electrical link)
- ☆☆ CH 1 & 2
- ☆☆ Flaps
- ☆☆ Flap position indicator
- ☆☆ Manual flight control mode select actuator (ratio changer)
- ☆☆ Pitch trim actuator

FLIGHT INSTRUMENTS

- ☆ Left and right pitot heaters
- ☆ Standby airspeed/Mach indicator(s)
- ☆ Standby altimeter(s)
- ☆☆ Standby attitude reference indicator(s)
- ☆ Standby rate-of-climb indicator(s)
- ☆☆ Standby turn needle(s)

LIGHTING EQUIPMENT

- ☆ Caution/advisory displays
- ☆☆ Caution lights panel (less GEN and FUEL level LO lights)
- CABIN light may be on but is not accurate.
- CK ECS light is not fully functional.
- 1 ☆☆☆ Console lights
- ☆☆ Emergency instrument light
- ☆ Flood lights
- ☆☆ Instrument lights
- ☆☆ Master caution light(s) (and tone)
- 15 ☆☆☆ NVG Floodlights
- ☆☆ Utility floodlight(s)

NAVIGATION EQUIPMENT

- 5 ☆☆☆ COMM I R/T
- ☆☆ RADAR altimeter
- ☆☆ IFF (emergency) INS
- 14 ☆☆☆ GPS

OTHER

- 3 ☆ Arresting hook extension
- Battery charger
- ☆☆ Canopy
- ☆☆ Cockpit DDI/HI/MPCD
- ☆☆ Emergency air refueling
- ☆☆ Emergency jettison
- ☆☆ FCS ram air selection
- ☆☆ Hydraulic pressure indicator
- 2 ☆☆☆ Intercom
- JHMCS
- ☆☆ Landing gear (emergency system)
- ☆☆ Landing gear position indicator
- 12 ☆☆☆ Oxygen gauge
- ☆☆ Voice alerts (all)

INOPERATIVE EQUIPMENT

ENGINE

- Anti-ice control
- Bleed air system
- External fuel transfer
- FUEL LO warning light
- Fuel tank pressure light
- Inlet duct doors
- Inlet ice detector
- Internal fuel tank pressurization
- Internal wing fuel inhibit
- N_H lockup
- Throttle boost
- Wing diverter valves

FLIGHT CONTROLS

- Autopilot
- CH 3 & 4
- Speedbrake
- Speedbrake advisory light

FLIGHT INSTRUMENTS

- AOA indexer lights
- HUD

LIGHTING EQUIPMENT

- Approach lights
- CK ECS caution light is not fully functional
- Formation lights
- GEN caution lights
- Landing/taxi lights
- Lights test switch
- Position lights
- Strobe lights

NAVIGATION EQUIPMENT

- ADF
- 11 ☆☆☆ COMM 2 R/T
- 16 ☆☆☆ DMS
- EGI
- IFF
- ILS
- KY-58
- Radar beacon
- TACAN

OTHER

- Air refueling lights and normal probe extension
- Anti-skid
- Arresting hook retraction
- 17 ☆☆☆ ATARS
- 4 ☆☆☆ Battery charger (s)
- Cabin ram air selection
- CPWS pressure sensing
- Data link
- Hook warning light
- Landing gear (normal system)
- Landing gear warning tone
- Nosewheel steering
- 13 ☆☆☆ OBOGS
- 13 ☆☆☆ OBOGS monitor
- Radar
- 3 ☆☆☆ ALR-67 Radar warning rcvr
- Selective jettison
- Video tape recorder
- Weapons fire/launch/release
- Windshield anti-ice/rain removal

☆ Equipment still operative after batteries depleted.

☆☆ On 161353 THRU 161528 BEFORE AFC O49, equipment becomes inoperative with batteries depleted.

☆☆☆ On 161353 THRU 161528 AFTER AFC O49, and 161702 AND UP, equipment remains operative by action of battery charger (battery switch ON).

- | | | |
|--|--------------------------------|--|
| 1 F/A-18A and FWD CKPT of F/A-18B only | 5 Back-up mode operative only. | 14 Aircraft 165171 AND UP |
| 2 F/A-18B | 9 Aircraft 161353 THRU 163175 | 15 Aircraft 161702 THRU 163427 AFTER AFC 209 AND 163985 AND UP |
| 3 Aircraft 161702 AND UP | 10 Aircraft 163427 AND UP | 16 Aircraft AFTER AFC 231 |
| 4 Aircraft 161353 THRU 161528 | 11 Aircraft 163985 AND UP | 17 Aircraft AFTER AFC 244 |
| | 12 Aircraft 161353 THRU 164068 | |
| | 13 Aircraft 164196 AND UP | |

Figure 15-8. Emergency Power Distribution (Sheet 2)

LEFT GENERATOR INOPERATIVE - BUS TIE OPEN

Aircraft 162394 AND UP

OPERATIVE EQUIPMENT

ENGINE

- Afterburner ignition
- Anti-ice control
- Anti-icing
- APU ready light
- APU start
- Bleed air leak detectors
- Bleed air system
- Engine ignition
- 9 Engine monitor indicator
- Engine start
- External fuel transfer
- 9 Fuel quantity
- Fire detectors and extinguishers
- Fuel dump
- Fuel tank pressure light
- R inlet duct door
- Inlet ice detector
- 10 Integrated Fuel Engine Indicator
- Internal fuel tank pressurization
- Internal fuel transfer
- Internal wing fuel inhibit
- N_H lockup
- Throttle boost
- Wing diverter valves

FLIGHT INSTRUMENTS

- AOA indexer lights
- 1 HUD
- Standby airspeed/Mach indicators
- Standby altimeter(s)
- Standby attitude reference indicator(s)
- Standby rate-of-climb indicator(s)
- Standby turn needle(s)

FLIGHT CONTROLS

- Autopilot
- CAS
- DEL (direct electrical link)
- 17 Flaps
- Flap position indicator
- Manual flight control mode select actuator (ratio changer)
- Pitch trim actuator
- Speedbrake
- Speedbrake advisory light

NAVIGATION EQUIPMENT

- ADF
- 16 COMM 1 and 2 R/T
- EGI
- IFF (less Mode 4)
- IFF emergency
- KY-58
- RADAR altimeter
- Radar beacon
- TACAN
- 14 GPS

LIGHTING EQUIPMENT

- Approach lights
- Caution lights panel (less FUEL LO level LT)
- 1 Emergency instrument light
- Fwd console, flood and instrument lights
- Lights test switch
- Master caution light(s)
- 15 NVG floodlights
- Utility floodlight(s)

OTHER

- Anti-skid
- Arresting hook extension and retraction
- 17 ATARS
- Audio tones
- Cabin ram air selection
- Cockpit right DDI
- Canopy
- CPWS
- Data link
- ECS
- Emergency air refueling
- Emergency jettison
- FCS ram air selection
- Hook warning light
- Intercom
- JHMCS
- Landing gear (emergency system)
- Landing gear (normal system)
- Landing gear position indicator
- Landing gear warning tone
- Master caution tone
- Nosewheel steering
- 13 OBOGS monitor
- Selective jettison (stations 5 thru 8 only)
- Voice alerts (APU fire, engine fire bleed air)
- Video tape recorder
- Weapons launch/release (stations 5 thru 9 only)
- Windshield anti-ice/rain removal

INOPERATIVE EQUIPMENT

ENGINE

- L inlet duct door
- FUEL LO warning light

FLIGHT INSTRUMENTS

- Left AOA probe heater
- Left pitot heater
- Total temp probe heater

LIGHTING EQUIPMENT

- AFT console, flood and instrument lights
- Caution/advisory display
- Formation lights
- 13 Landing/taxi lights
- 12 Position lights
- 7 Strobe lights

NAVIGATION EQUIPMENT

- 11 DMS
- ILS
- INS

OTHER

- Air refueling light
- ALR-67 radar warning rcvr
- Cockpit left DDI/HI/MPCD
- OBOGS
- 12 Oxygen gauge
- Radar
- 7 Selective jettison (stations 2 thru 4)
- Voice alerts (altitude, bingo, check gear, engine, fuel low, flight computer hot, flight controls, mode 4 reply, power, pull up, roll out)
- 7 Weapons fire/launch; release (Gun and stations 1 thru 4 only)

- 1 F/A-18A and FWD CKPT of F/A-18B only
- 2 F/A-18B
- 7 Failure of stations 1 thru 4 will not be indicated on DDI until SMS attempts to communicate with failed stations.

- 9 Aircraft 161353 THRU 163175
- 10 Aircraft 163427 AND UP
- 11 Aircraft 163985 AND UP
- 12 Aircraft 161353 THRU 164068

- 13 Aircraft 164196 AND UP
- 14 Aircraft 163427 THRU 164912 AFTER AFC 175 PT2 and Aircraft 164945 AND UP
- 15 161702 THRU 163427 AFTER AFC 209 AND 163985 AND UP
- 16 Aircraft AFTER AFC 231
- 17 Aircraft AFTER AFC 244

Figure 15-8. Emergency Power Distribution (Sheet 3)

RIGHT GENERATOR INOPERATIVE - BUS TIE OPEN

Aircraft 162394 AND UP

OPERATIVE EQUIPMENT

ENGINE

- Afterburner ignition
- Anti-ice control
- Anti-icing
- APU ready light
- APU start
- Bleed air leak detectors
- Bleed air system
- Engine ignition

9 Engine monitor indicator

- Engine start
- External fuel transfer
- Fire detectors and extinguishers
- Fuel dump
- FUEL LO warning light
- Fuel tank pressure light
- L inlet duct door

10 Intergrated Fuel Engine Indicator

- Internal fuel tank pressurization
- Internal fuel transfer
- Internal wing fuel inhibit
- N₁ lockup
- Throttle boost
- Wing diverter valves

FLIGHT INSTRUMENTS

- Standby airspeed/Mach indicator(s)
- Standby altimeter(s)
- Standby attitude reference indicator(s)
- Standby rate-of-climb indicator(s)
- Standby turn needle(s)

FLIGHT CONTROLS

- Autopilot
- CAS
- DEL (direct electrical link)
- Flaps
- Flap position indicator
- Manual flight control mode select actuator (ratio changer)
- Pitch trim actuator
- Speedbrake
- Speedbrake advisory light

NAVIGATION EQUIPMENT

- 5 COMM 1 and 2 R/T
- 11 DMS
- 16 EGI
- IFF (less mode C)
- IFF emergency
- ILS
- INS
- KY-58
- Radar beacon

LIGHTING EQUIPMENT

- 15 Aft console, flood and instrument lights
- Caution lights panel
- Formation lights
- Landing/taxi lights
- Lights test switch
- Master Caution light(s)
- NVG floodlights
- Position lights
- Strobe lights
- Utility floodlight(s)

OTHER

- 2 Air refueling light and normal probe extension
- ALR-67 radar warning rcvr
- Anti-skid
- Arresting hook extension and retraction
- Audio tones (less Master Caution)
- Cabin ram air selection
- Canopy
- CPWS
- Cockpit left DDI/HI/MPCD
- Data link
- ECS (Cold cockpit, defog and suit vent air flow)
- Emergency air refueling
- Emergency jettison
- FCS ram air selection
- Hook warning light
- Intercom
- Landing gear (emergency system)
- Landing gear (normal system)
- Landing gear position indicator
- Landing gear warning tone
- Nosewheel steering
- OBOGS, OBOGS monitor
- Oxygen gauge
- 13 Radar
- 12 Radar coolant pump
- 8 Voice alerts (APU fire, engine fire, bleed air)
- Windshield anti-ice/rain removal

INOPERATIVE EQUIPMENT

ENGINE

9 Fuel quantity

- Inlet ice detector
- R inlet duct door

FLIGHT INSTRUMENTS

- AOA indexer lights
- HUD
- Right AOA heater
- Right pitot heater

LIGHTING EQUIPMENT

- Approach lights
- Fwd console, flood instruments lights

NAVIGATION EQUIPMENT

- 14 ADF
- GPS
- RADAR altimeter
- TACAN

OTHER

- 17 ATARS
- Battery charger(s)
- Cockpit right DDI
- CSC
- Interference blanker
- Hydraulic pressure indicator
- JHMCS
- Master Caution tone
- Selective jettison
- Video tape recorder
- Voice alerts (altitude, bingo, check gear, engine, fuel low, flight computer hot, flight controls, mode 4 reply, power, pull up, roll out)
- Weapon fire/launch/release

2 F/A-18B

5 Back-up mode operative only.

8 Radar cooling lost in high temp ram air flight.

9 Aircraft 161353 THRU 163175

10 Aircraft 163427 AND UP

11 Aircraft 163985 AND UP

12 Aircraft 161353 THRU 164068

13 Aircraft 164196 AND UP

14 Aircraft 163427 THRU 164912 AFTER AFC 175 PT2 and Aircraft 164945 AND UP

15 Aircraft 161702 THRU 163427 AFTER AFC 209 AND 163985 AND UP

16 Aircraft with AFC 231

17 Aircraft with AFC 244

Figure 15-8. Emergency Power Distribution (Sheet 4)

15.18 AMAD CAUTION

An L AMAD or R AMAD caution indicates that the left or right AMAD oil is too hot. Low altitude flight on a hot day with less than 4,000 pounds fuel may cause an AMAD caution. A climb to cooler air may reduce AMAD oil temperature. An over-serviced AMAD, AMAD heat exchanger failure, hot fuel recirculation system failure, or motive flow system failure will cause an AMAD caution. An empty feed tank or BOOST LO caution will cause loss of AMAD cooling.

WARNING

Prolonged operation of a hot AMAD may result in an engine bay fire.

Continued operation with an AMAD caution may cause loss of the associated generator. If an AMAD caution is accompanied by generator loss, land as soon as practical. If a landing cannot be made within 15 minutes after an AMAD and GEN caution, consider shutting down the associated engine. The engine may be restarted for landing, but should be shut down as soon as the aircraft is stopped. See Warning/Caution/Advisory Displays, figure 12-1.

During ground operation after flight, an AMAD caution may occur due to the lack of ram air cooling and low fuel state. Below 1,000 pounds fuel remaining and above 30°C, an AMAD caution will appear almost immediately. Above 3,000 pounds of fuel remaining and below 30°C, an AMAD caution should not occur. Between these conditions, the time before an AMAD caution will appear is a function of fuel state and ambient temperature (15 minutes at 24°C and 2,000 pounds fuel). Lower fuel quantities and higher ambient temperatures will reduce the time before an AMAD caution will appear. Shutting down an engine (left engine shutdown preferred) will extend the ground operating time. If the AMAD caution appears, shut down the associated engine.

15.19 AMAD PR CAUTION

An L AMAD PR or R AMAD PR caution indicates the left or right AMAD oil pressure is low. The AMAD can operate 30 minutes after loss of oil without a catastrophic failure but the generator will fail shortly after loss of oil. Although it is documented the AMAD can operate for 30 minutes after loss of oil without catastrophic failure, pilots may want to consider shutting down the affected engine even if within 30 minutes of landing. A L/R AMAD PR caution could be an indication of an AMAD oil leak which may result in an engine/AMAD bay fire. See Warning/Caution/Advisory Displays, figure 12-1.

15.20 OXYGEN LEAK (Aircraft 161353 THRU 164068)

An oxygen leak can cause liquid oxygen to flow through the heat exchanger and into the cockpit. The liquid oxygen may rapidly freeze the oxygen supply lever and prevent its use to stop the flow.

1. Emergency oxygen green ring(s) - PULL

NOTE

Emergency O₂ may not be delivered to the pilot if the leak is between the seat kit and the O₂ mask.

2. OXYGEN supply lever(s) - OFF

WARNING

Disconnecting the oxygen hose from the console may cause LOX to leak onto console electrical panels increasing the potential for a cockpit fire.

NOTE

If the OXYGEN supply lever does not stop flow of O₂ and/or LOX consider use of helmet bag or suitable device to shield pilot from flow.

3. Descend below 10,000 feet cabin altitude.

15.21 HYPOXIA/LOW MASK FLOW/NO MASK FLOW

- *1. Emergency oxygen green ring(s) - PULL
- *2. OXY FLOW knob(s) or OXYGEN supply lever(s) - OFF
- *3. Initiate rapid descent to below 10,000 feet cabin altitude.

WARNING

- Under less than optimal conditions (low altitude, heavy breathing, loose fitting mask, etc.) as few as 1.5 minutes (LOX Aircraft) or 3 minutes (OBOGS Aircraft) of emergency oxygen may be available.
- LOX Aircraft: Emergency oxygen cannot be turned off after being activated.

OBOGS Aircraft -

4. OBOGS control switch - OFF

All Aircraft -

5. Maintain cabin altitude below 10,000 feet prior to emergency oxygen depletion (10 to 20 minutes).

If hypoxia symptoms persist -

6. Remain on emergency oxygen as long as possible.
7. Land as soon as possible.

If hypoxia symptoms removed -

6. Land as soon as practical.

LOX Aircraft -

7. Remove mask when emergency oxygen depletes.

OBOGS Aircraft -

7. Consider removing mask and resetting emergency oxygen system or resuming normal OBOGS operation if flow appears normal and donning of mask is desired once below 10,000 feet cabin altitude.

15.22 OBOGS DEGRADE/FAILURE (Cautions of any duration)

An OBOGS DEGD caution indicates the oxygen concentration has fallen below acceptable levels. This condition may indicate a failure of the OBOGS system. It may be accompanied by reduced pressure and/or quantity of breathing gas and may result in hypoxia symptoms if corrective action is not taken. OBOGS system failure may result from a bleed air leak, failure of the heat exchanger, high pressure water separator, OBOGS concentrator, or electrical system interface. Any failure should be corrected with the following steps:

GROUND

1. Check oxygen system integrity:
 - Mask integrity
 - Hose connections
 - OBOGS monitor pneumatic BIT plunger unlocked and fully extended.

IN FLIGHT

- *1. Emergency oxygen green ring(s) - PULL
- *2. OXY FLOW knob(s) - OFF
- *3. Initiate rapid descent to below 10,000 feet cabin altitude.

WARNING

- Good flow does not equate to good oxygen concentration. An OBOGS DEGD caution indicates that the oxygen concentration is inadequate and hypoxia may result.
- Under less than optimal conditions (low altitude, heavy breathing, loose fitting mask, etc.), as few as 3 minutes of emergency oxygen may be available.

4. Check oxygen system integrity:
 - Mask integrity
 - Hose connections
 - OBOGS monitor pneumatic BIT plunger unlocked and fully extended.

If system integrity not compromised -

5. Maintain cabin altitude below 10,000 feet.
6. OBOGS control switch - OFF

Once below 10,000 feet cabin altitude and no hypoxic symptoms present -

7. Consider removing mask and resetting emergency oxygen system or resuming normal OBOGS operation if flow appears normal and donning of mask is desired.
8. Land as soon as practical.

If system integrity restored -

5. Resume normal OBOGS operation.
6. Reset emergency oxygen system.

15.23 COCKPIT TEMPERATURE HIGH

1. CABIN TEMP knob - FULL COLD
If the CABIN TEMP knob is full HOT with the ECS mode switch in MANUAL, cockpit temperature can reach 190° F.
2. ECS MODE switch - MAN

If temperature still high -

3. Maintain altitude below 25,000 feet.
4. CABIN PRESS switch - RAM/DUMP

If temperature not reduced -**For OBOGS equipped aircraft (and altitude above 10,000 feet MSL) -**

5. Emergency oxygen green ring(s) - PULL
6. OXY FLOW knob(s) - OFF
7. Descend below 10,000 feet MSL prior to emergency oxygen depletion.

WARNING

Under less than optimal conditions (low altitude, heavy breathing, loose fitting mask, etc.), as few as 3 minutes of emergency oxygen may be available.

For all aircraft, if temperature not reduced -

8. BLEED AIR knob - OFF
When bleed air secured, anticipate:
 - a. Loss of crossbleed start capability.
 - b. Loss of ECS and pressurization.

- c. Loss of external tank transfer. (EXT TANKS switch(es) - STOP)
 - d. Illumination of TANK PRESS and AV AIR HOT lights.
9. Land as soon as practical.

15.24 COCKPIT SMOKE, FUMES, OR FIRE

Consider all unidentified fumes in the cockpit as toxic. Do not confuse condensation from the ECS with smoke. The most probable source of visible smoke or fumes in the cockpit is from the engine bleed air or residual oil in the ECS ducts. This smoke is blue gray in color, has a characteristic pungent odor, and may cause the eyes to sting. Another source of smoke or fumes is an electrical malfunction or overheat of equipment located in the cockpit. In the event of an electrical short or overload condition, this equipment may generate electrical smoke (usually white or gray in color) but should not cause an open fire since cockpit equipment uses very little electrical current. Cockpit electrical wiring insulation may smolder and create smoke, but will not erupt into a seriously damaging fire.

OBOGS Aircraft -

- *1. Emergency oxygen green ring(s) - PULL
- *2. OXY FLOW knob(s) - OFF

All Aircraft -

- *3. Initiate rapid descent to below 10,000 feet cabin altitude.
- *4. CABIN PRESS switch - RAM/DUMP
- *5. CABIN TEMP knob - FULL COUNTERCLOCKWISE

WARNING

- DCS may be experienced when operating in an unpressurized cabin above 25,000 feet even with a working oxygen system. Symptoms of DCS include pain in joints, tingling sensations, dizziness, paralysis, choking, and/or loss of consciousness.
- OBOGS Aircraft: Under less than optimal conditions (low altitude, heavy breathing, loose fitting mask, etc.) as few as 3 minutes of emergency oxygen may be available.

6. Airspeed - Maintain 200 to 300 KCAS

LOX Aircraft -

If DCS or hypoxia symptoms not present -

7. Maintain altitude below 25,000 feet MSL.

OBOGS Aircraft -

7. OBOGS control switch - OFF
8. Maintain altitude below 10,000 MSL prior to emergency oxygen depletion (10 to 20 minutes).
9. Consider resetting emergency oxygen system once below 10,000 feet MSL.

All Aircraft -**If smoke and fumes still present -**

10. BLEED AIR knob - OFF (DO NOT CYCLE.)
11. AV COOL switch - EMERG
12. EXT TANK switch(es) - STOP

If smoke and fumes persist or fire present -

13. All electrical equipment - OFF
14. UFC controlled avionics - OFF (AC power is required.)
15. Required electrical equipment - ON
Restore power to equipment one at a time. If smoke/fire starts again, secure that equipment.

If still unable to clear smoke -

16. Slow and jettison canopy. Secure all loose articles and ensure helmet visor is down. In the FA-18B/D, the rear crewmember should lower the seat and lean as far forward as possible before jettisoning canopy.

15.25 LOSS OF CABIN PRESSURIZATION

Decompression sickness (DCS) becomes a physiological concern at exposures to cabin altitudes in excess of 18,000 feet. The potential for DCS increases at exposures above 25,000 feet or in the case of a rapid decompression. Aircrew exposed to these conditions should be alert for the symptoms of DCS. is down.

OBOGS Aircraft -

- *1. Emergency oxygen green ring(s) - PULL
- *2. OXY FLOW knob(s) - OFF

All Aircraft -

- *3. Initiate rapid descent to below 10,000 feet cabin altitude.
4. CABIN PRESS switch - CHECK NORM
5. ECS MODE switch - CHECK AUTO or MAN

WARNING

DCS may be experienced when operating in an unpressurized cabin above 25,000 feet even with a working oxygen system. Symptoms of DCS include pain in joints, tingling sensations, dizziness, paralysis, choking, and/or loss of consciousness.

If DCS or hypoxia symptoms present -

6. Maintain altitude below 10,000 feet MSL.
7. Land as soon as possible.

If DCS or hypoxia symptoms not present -**OBOGS Aircraft -**

6. Reset emergency oxygen system and resume normal OBOGS operation.

All Aircraft -

7. Maintain altitude below 25,000 feet MSL.
8. Land as soon as practical.

15.26 DISPLAY MALFUNCTION

Turn off malfunctioning displays as they may overheat and cause a fire if not functioning correctly. If all displays are flashing, turn MC1 and MC2 off alternately to see if the problem will clear. If one or more displays are frozen with an accompanying MC1 or MC2 caution, turn off the failed MC. If all displays then go blank, cycle the good MC, then back to OFF on the failed MC.

15.27 EXTERNAL STORES JETTISON

The emergency jettison button, labeled EMERG JETT, on the left edge of the instrument panel, jettisons stores from the parent bomb racks on external stores stations 2, 3, 5, 7 and 8. Pressing the button initiates jettison. Jettison is sequential by pairs starting with stations 2 and 8, then stations 3 and 7, and finally, station 5. The emergency jettison button is operational with either the weight off the right main landing gear or the landing gear handle in the UP position. Selective jettison is provided. On the F/A-18B/D, an emergency jettison button is installed in the rear cockpit on the upper edge of the instrument panel between the left DDI and the upfront control. Operation is identical to the button in the front cockpit. See External Stores Jettison Chart, figure 15-9, for jettison procedures.

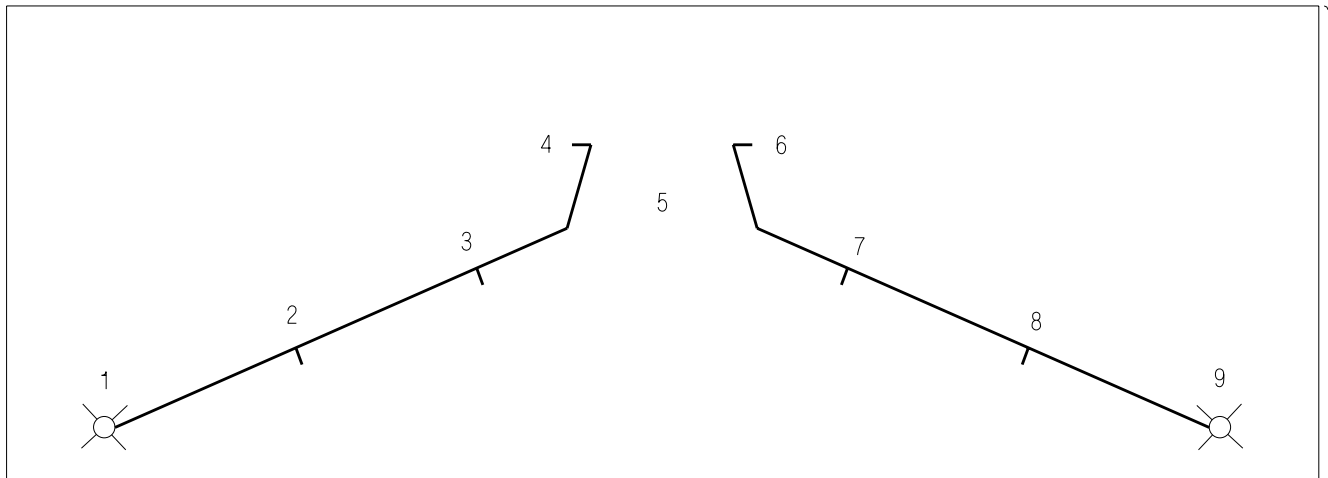

ADA520-64-1-043

JETTISON PROCEDURES

EMERGENCY JETTISON:

- HOW - 1. EMERG JETT BUTTON - PUSH
- REQUIREMENTS - WEIGHT OFF WHEELS OR GEAR HANDLE UP
- WHAT - - JETTISON ALL STORES/RACKS/LAUNCHERS FROM THE FIVE PYLON WEAPONS STATIONS RELEASED IN PAIRS 2&8, 3&7, AND 5.
- LOCATE BUTTON PRIOR TO EVERY TAKEOFF/CAT.

SELECTIVE JETTISON:

- HOW - 1. LT TEST SWITCH - TEST
- 2. SELECT JETT KNOB - ROTATE TO DESIRED POSITION
- 3. JETT STATION PUSHTILE(S) - SELECT
- 4. SIM - UNBOXED
- 5. MASTER SWITCH - ARM
- 6. SELECT JETT BUTTON - PUSH
- REQUIREMENTS - LANDING GEAR UP AND LOCKED
- WHAT - - STORES OR STORES AND RACKS/LAUNCHERS ARE EJECTED ACCORDING TO THE POSITION OF SELECT JETT KNOB AND PUSHTILES

AUXILIARY RELEASE:

- HOW - 1. LT TEST SWITCH - TEST
- 2. AUX REL SWITCH - ENABLE
- 3. SELECT JETT KNOB - ROTATE TO DESIRED POSITION
- 4. JETT STATION PUSHTILE(S) - SELECT
- 5. SIM - UNBOXED
- 6. MASTER SWITCH - ARM
- 7. SELECT JETT BUTTON - PUSH
- REQUIREMENTS - LANDING GEAR UP AND LOCKED
- WHAT - - HUNG STORES OR STORES AND RACKS/LAUNCHERS ARE GRAVITY RELEASED FROM STATION ACCORDING TO POSITION OF SEL JETT KNOB AND PUSHTILES

AFTER TAKEOFF:

- SELECT JETT KNOB - ROTATE OUT OF SAFE TO DESIRED POSITION
- JETT STATION PUSHTILES - SELECT

WITH AN ENGAGEMENT:

- MASTER ARM - ON
- PUSH SELECT JETT BUTTON

HARM ANTI-COMPROMISE:

- PERFORM LIGHTS TEST
- SELECT JETT KNOB - ROTATE TO STORES
- JETT STATION PUSHTILE(S) - SELECT
- SELECT JETT BUTTON - PUSH

LIMITATIONS:

	G	AIRSPEED
EMERG JETT	0.5 TO 5.0	SEE NATIP
SELECT JETT	SEE NATIP (TANKS: 1.0-2.0)	SEE NATIP (TANKS: 575/0.95)
AUX RELEASE	1.0 LEVEL	SEE NATIP

DEGRADED SYSTEMS : USING AUX REL, PILOT IS ABLE TO RELEASE AN ARMED HARPOON.

Figure 15-9. External Stores Jettison Chart

15.28 ADC FAILURE EFFECTS

An ADC failure is recognized by the BIT advisory and the BIT page indication of ADC-MUX FAIL (C/D), NO GO (A/B) or NOT RDY. The standby instruments indicate the correct altitude and airspeed. The HUD airspeed, barometric altitude, vertical velocity and mach information are lost. The landing gear warning light and aural tone are activated if the landing gear handle is up. To silence the tone push the warning tone silence button or slow below landing gear extension speed and extend the landing gear. E bracket data is automatically provided by the flight control computer and the ATC mode is functional. The AOA indexers will be inoperative. The INS velocity vector is adversely impacted by the loss of ADC data and may be inaccurate after approximately 10 minutes. See BIT advisory, figure 12-1.

15.29 FCS FAILURE INDICATIONS AND EFFECTS

FCS failures are indicated by BLIN codes and/or various cautions and when selected, the FCS status display on the DDI (figure 15-10). The FCS status display should be used to determine the precise failure immediately upon indication of an FCS malfunction. BLIN codes are not always accompanied by cautions or Xs.

15.29.1 Invalid FCS Status Display

With the failure of channels 1 and 3, the FCS status display will show the word INVALID in place of the G-LIM advisory. Subsequent FCS failures or resets will not be displayed. Diagnosis of failure state can be made using the following:

If INVALID on the FCS and flying quality has degraded -

Check if stick moves with longitudinal trim. If stick movement occurs the stabilator has reverted to mechanical control, and the ailerons and rudders are off. Refer to MECH ON caution. If FCES is illuminated on the annunciator panel, channel 2 or 4 is still functioning. Ratio changer HI GAIN only is available. If FCES is not illuminated on the annunciator panel, a four-channel or four-processor failure has occurred. Ratio changer LO GAIN only is available. In both cases the T/O trim button is inoperative.

The presence of the INVALID in place of the G-LIM advisory indicates that the FCS will stop using INS provided data across the MUX; for this failure there is no significant degradation to flying qualities, departure resistance or roll performance with these failure indications.

FCS status displays are shown in figure 15-10.

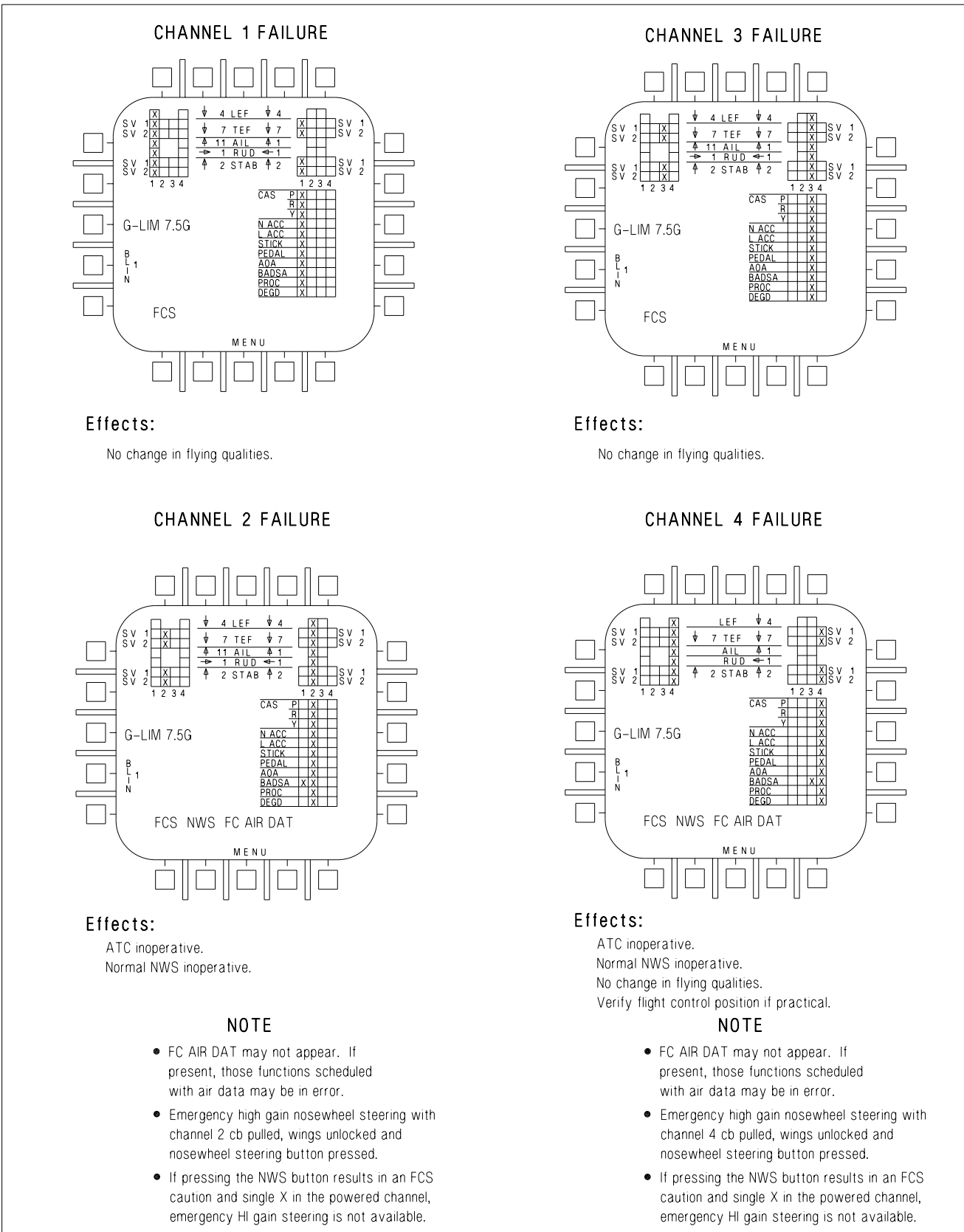
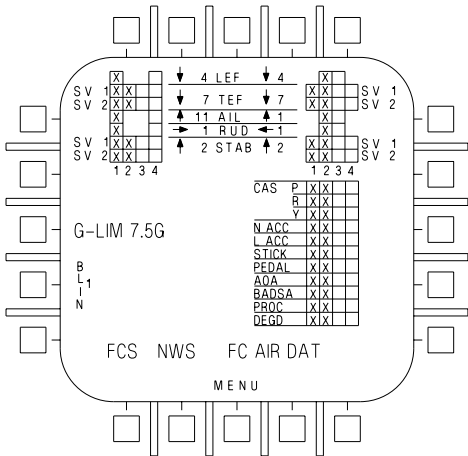

Figure 15-10. FCS Failure Indications and Effects (Sheet 1 of 10)

ADA520-132-1-045

CHANNELS 1 & 2 FAILURE



Effects:

Autopilot inoperative.
Normal NWS inoperative.

NOTE

- FC AIR DAT may not appear. If present, those functions scheduled with air data may be in error.
- Emergency high gain nosewheel steering with channel 2 cb pulled, wings unlocked, and NWS button pressed.
- If pressing the NWS button results in an FCS caution and single X in the powered channel, emergency HI gain steering is not available.

CHANNELS 1 & 4 FAILURE

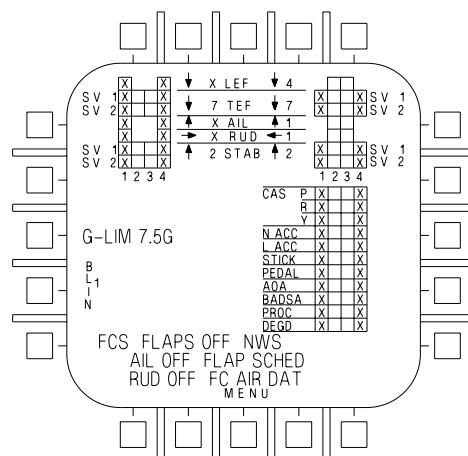

Effects:

Normal NWS inoperative.

- Left leading edge flap locked in failed position.
- Left aileron and left rudder failed (flutter damped).
- Autopilot and ATC inoperative.
- Flaps - AUTO
- Flaps freeze.
- Flaps - HALF
- Right leading edge flap scheduled with air data.
- Trailing edge flaps 30 ° maximum. Scheduled with airspeed.
- No aileron droop.
- No rudder toe-in.

CHANNELS 1 & 3 FAILURE

A simultaneous failure of channels 1 and 3 will prevent display of any FCS cautions. The FCS display will show the word INVALID.

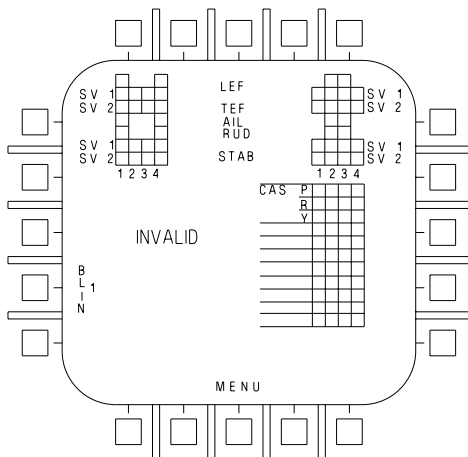

Effects:

No change in flying qualities.

NOTE

- FC AIR DAT may not appear. If present, those functions scheduled with air data may be in error.
- Emergency high gain nosewheel steering with channel 4 cb pulled, wings unlocked, and NWS button pressed.
- If pressing the NWS button results in an FCS caution and single X in the powered channel, emergency HI gain steering is not available.

Figure 15-10. FCS Failure Indications and Effects (Sheet 2 of 10)

ADA520-132-2-046

CHANNELS 2 & 3 FAILURE

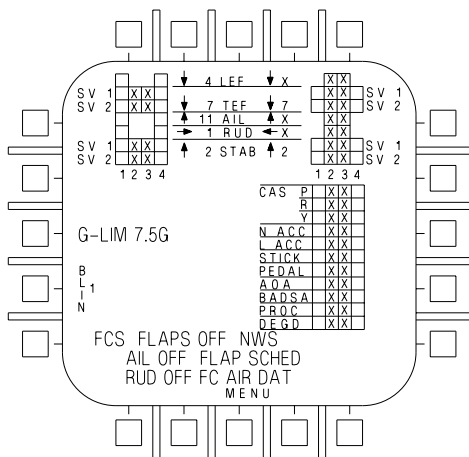

Effects:

- Normal NWS inoperative
- Right leading edge flap locked in failed position.
- Right aileron and right rudder failed (flutter dampened).
- Autopilot and ATC inoperative.
- Flaps – AUTO
- Flaps freeze.
- Flaps – HALF
- Left leading edge flap scheduled with air data.
- Trailing edge flaps 30 ° maximum. Scheduled with airspeed.
- No aileron droop.
- No rudder toe-in.

NOTE

- FC AIR DAT may not appear. If present, those functions scheduled with air data may be in error.
- Emergency high gain nosewheel steering with channel 2 cb pulled, wings unlocked, and NWS button pressed.

CHANNELS 2 & 4 FAILURE

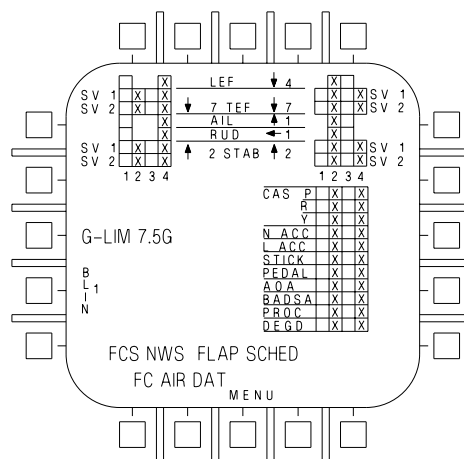

Effects:

- Autopilot and ATC inoperative.
- Flaps – AUTO
- Degraded flying qualities.
- Flaps function with frozen air data values.
- Flaps schedule with AOA.
- Flaps – HALF or FULL
- Trailing edge flaps 30 ° or 45 °.
- Leading edge flaps and rudder schedule with AOA.
- Nosewheel steering inoperative.

NOTE

FC AIR DAT may not appear. If present, those functions scheduled with air data may be in error.

Figure 15-10. FCS Failure Indications and Effects (Sheet 3 of 10)

ADA520-132-3-045

CHANNELS 3 & 4 FAILURE

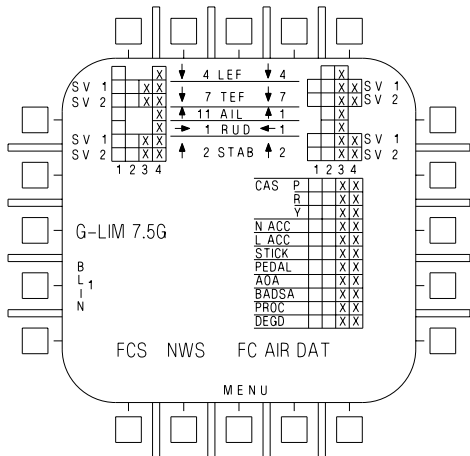

Effects:

Autopilot and ATC inoperative.
Normal NWS inoperative.

NOTE

- FC AIR DAT may not appear. If present, those functions scheduled with air data may be in error.
- Emergency high gain nosewheel steering with channel 4 cb pulled, wings unlocked, and NWS button pressed.
- If pressing the NWS button results in an FCS caution and single X in the powered channel, emergency HI gain steering is not available.

CHANNELS 1, 2, & 4 FAILURE

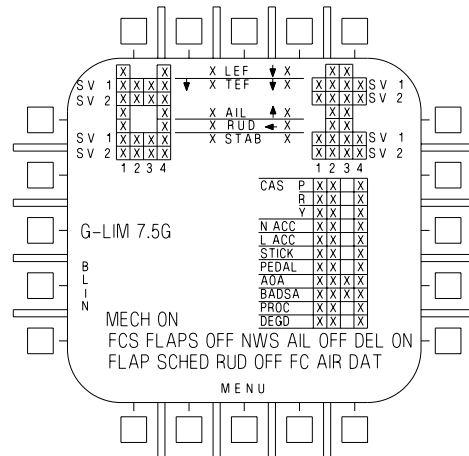

Effects:

Ailerons and rudders inoperative.
Stabilators in mechanical backup (MECH) mode.
Refer to MECH ON Caution procedure, this section.
'FCES' not present on annunciator panel.
Stick moves with trim.
T/O Trim button inoperative.
Trailing edge flaps hydraulically driven to 0°.
Leading edge flaps frozen.
Ailerons and rudders faired with relative wind.
Ratio Changer LO GAIN only.
NWS inoperative.

CHANNELS 2, 3, & 4 FAILURE

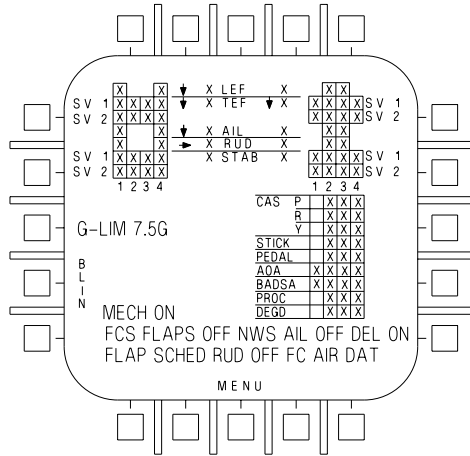

Effects:

Ailerons and rudders inoperative.
Stabilators in mechanical backup (MECH) mode.
Refer to MECH ON Caution procedure, this section.
'FCES' not present on annunciator panel.
Stick moves with trim.
T/O Trim button inoperative.
Trailing edge flaps hydraulically driven to 0°.
Leading edge flaps frozen.
Ailerons and rudders faired with relative wind.
Ratio Changer LO GAIN only.
NWS inoperative.

Figure 15-10. FCS Failure Indications and Effects (Sheet 4 of 10)

ADA520-132-4-045

ACTUATOR SINGLE SERVO VALVE FAILURE

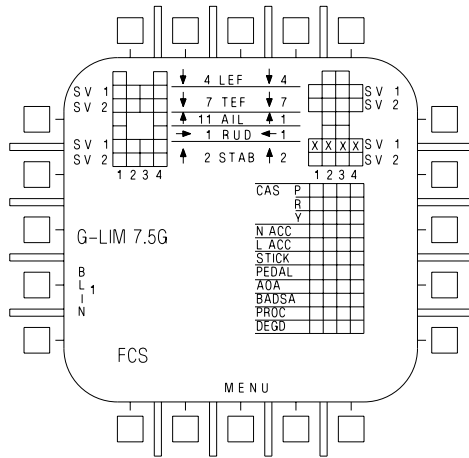

Effects:

No change in flying qualities. One more servo valve failure or three electrical failures will cause actuator to revert to degraded mode. For STAB failure, large, abrupt stick inputs while in the takeoff or landing configuration may cause reversion to MECH ON.

NOTE

FCS Status Display is shown for right stabilator servo valve 1 failure but is typical for either servo valve and left stabilator, either leading edge flap or either trailing edge flap.

ACTUATOR SINGLE ELECTRICAL FAILURE

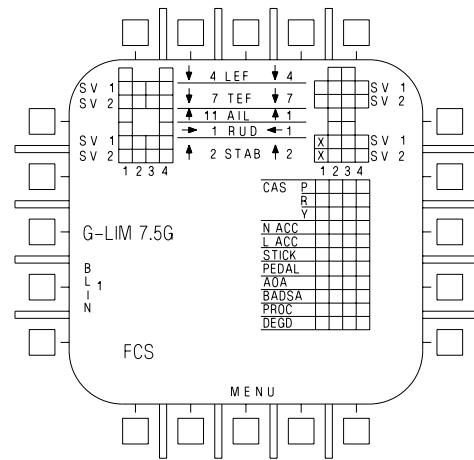

Effects:

No change in flying qualities. Two more electrical failures will cause actuator to revert to degraded mode.

NOTE

FCS status display is shown for right stabilator channel 1 failure but is typical for any channel and left stabilator, leading edge flap, or trailing edge flap.

STABILATOR ACTUATOR BOTH SERVO VALVES 4 CHANNEL FAILURE

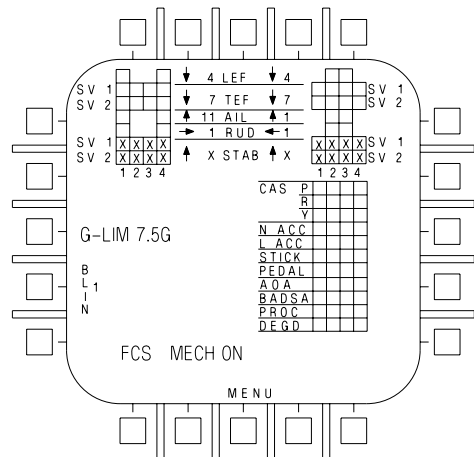

Effects:

Stabilators in mechanical backup (MECH) mode. Refer to MECH ON Caution procedure, this section.

Figure 15-10. FCS Failure Indications and Effects (Sheet 5 of 10)

PITCH STICK POSITION 4 CHANNEL FAILURE

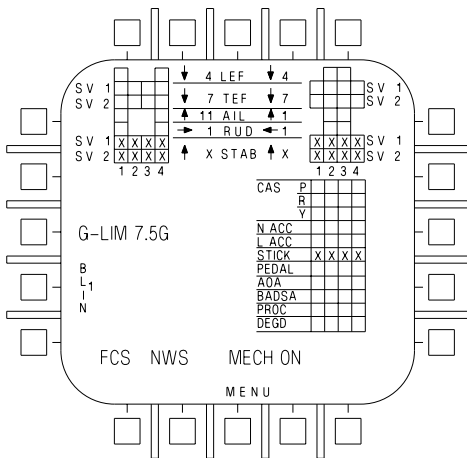

Effects:

Stabilators in mechanical backup (MECH) mode.
Refer to MECH ON Caution procedure, this section.

TRAILING EDGE FLAPS BOTH SERVO VALVES 4 CHANNEL FAILURE

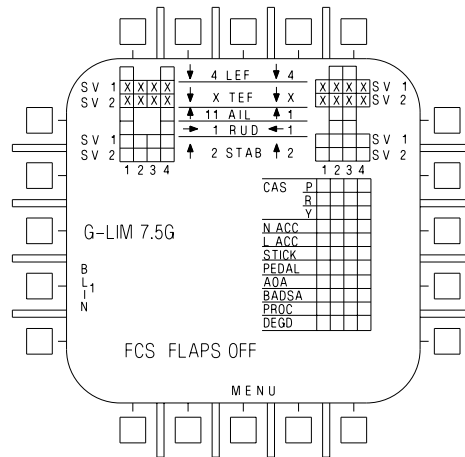

Effects:

Autopilot and ATC inoperative.
Trailing edge flaps hydraulically driven to 0°.
No aileron droop.
Excessive approach speed, refer to TEF OFF this section.

ROLL STICK POSITION 4 CHANNEL FAILURE

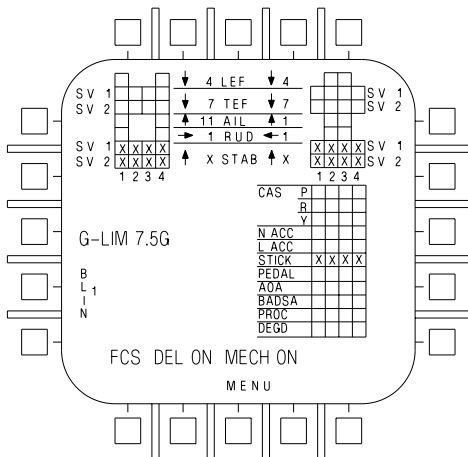

Effects:

Stabilators in mechanical backup (MECH) mode.
Refer to MECH ON Caution procedure, this section.
Flaps – AUTO
Ailerons inoperative with stick movement, will respond to trim switch.
Flaps – HALF or FULL
Ailerons droop but do not operate with stick movement, will respond to trim switch.

RUDDER CHANNELS 1 & 2 OR 3 & 4 FAILURE

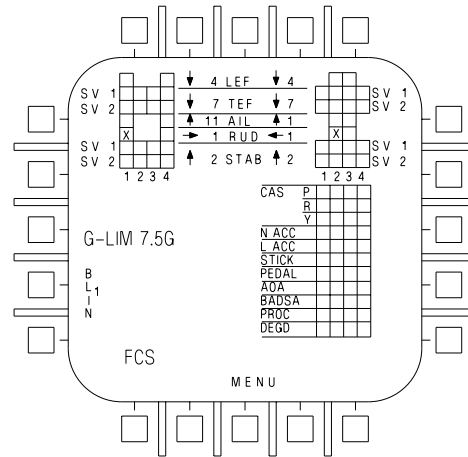

Effects:

No change in flying qualities.

NOTE

FCS status display shows channels 1 and 2 failure example.

Figure 15-10. FCS Failure Indications and Effects (Sheet 6 of 10)

RUDDER CHANNELS 1 & 4 OR 2 & 3 FAILURE

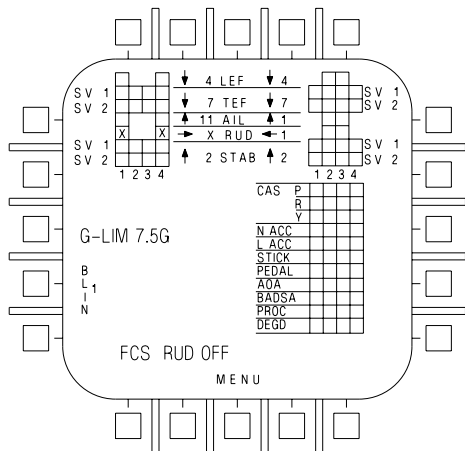

Effects:

Left rudder (channels 1 and 4) failed (flutter damped) or
 Right rudder (channels 2 and 3) failed (flutter damped).
 Directional control critical with one engine out.
 Autopilot inoperative.
 Flaps - HALF or FULL
 No rudder toe-in.

NOTE

FCS status display shows channels 1 and 4 failure example.

AILERON CHANNELS 1 & 4 OR 2 & 3 FAILURE

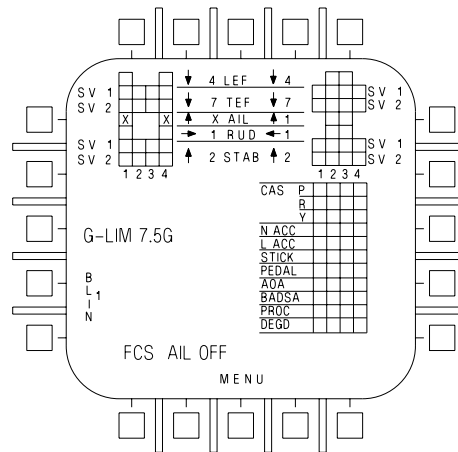

Effects:

Left aileron (channels 1 and 4) failed (flutter damped) or
 Right aileron (channels 2 and 3) failed.
 Autopilot inoperative.
 Flaps-HALF
 No aileron droop.
 Trailing edge flaps 30 °.
 Leading edge flaps and rudders schedule normally.

NOTE

FCS status display shows channels 1 and 4 failure example.

AILERON CHANNELS 1 & 2 OR 3 & 4 FAILURE

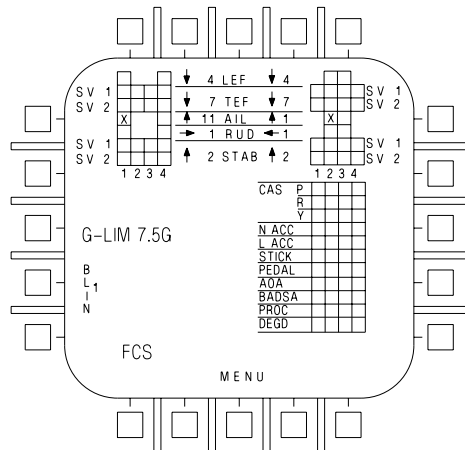

Effects:

No change in flying qualities.

NOTE

FCS status display shows channels 1 and 2 failure example.

AOA 4 CHANNELS FAILURE

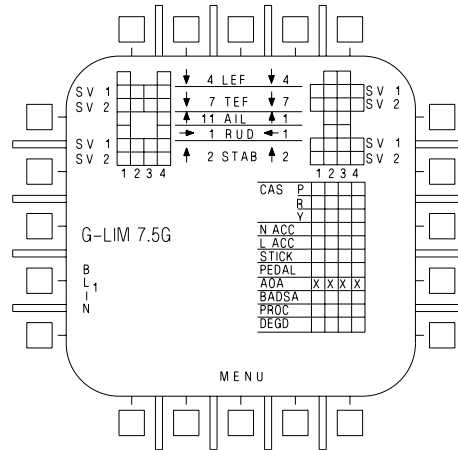

Effects:

Autopilot inoperative
 Flaps-AUTO
 FLAP SCHED never asserted.
 LEF/TEF go to 3 °/3 ° if ORIDE is selected.
 Flaps-HALF or FULL
 Normal flying qualities.
 LEF/TEF go to 17 °/30 ° or 45 ° if ORIDE selected.
 Leading edge flaps and rudders schedule with air data (simulated AOA).

Figure 15-10. FCS Failure Indications and Effects (Sheet 7 of 10)

AOA AND BACKUP AIR DATA SENSORS
4 CHANNEL FAILURE

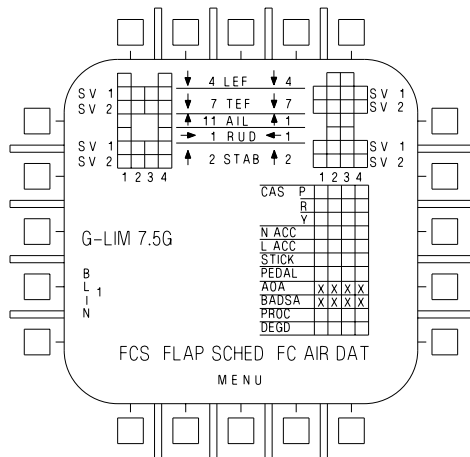

Effects:

Pitot-static instruments may be inaccurate.
Autopilot inoperative.

Flaps-AUTO

Degraded flying qualities.
Flaps freeze.
Flaps go to 3°/3° if ORIDE selected.

Flaps-HALF or FULL

No rudder toe-in.
Flaps freeze.
Flaps go to 17°/30° or 17°/45° if ORIDE selected.

LEADING EDGE FLAPS CHANNELS 1 & 4
OR 2 & 3 FAILURE

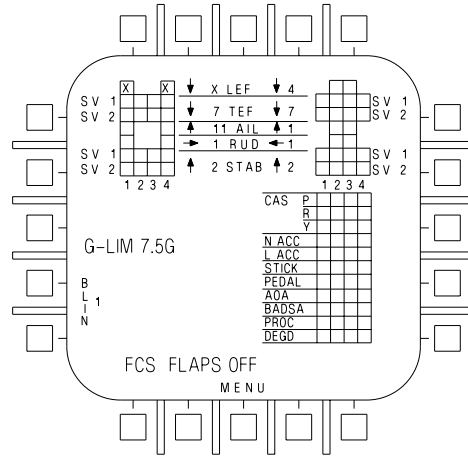

Effects:

Failed leading edge flap frozen.
Autopilot inoperative.

Flaps-AUTO

Good flap frozen symmetrically.
Good flap operates differentially.
Flaps-HALF or FULL
Good flap operates normally.

NOTE

FCS status display shows channels 1 and 4 failure example.

GYRO 2 CHANNEL FAILURE

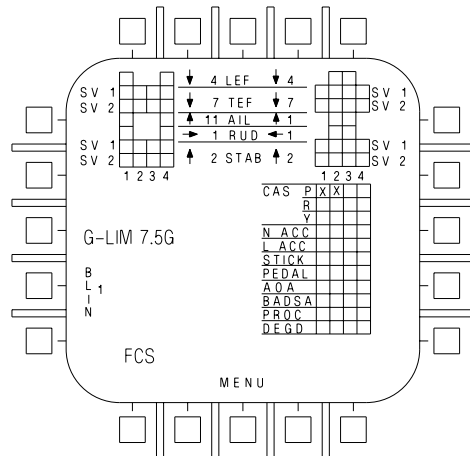

Effects:

No change in flying qualities.
Autopilot inoperative.

NOTE

FCS status display shows pitch rate gyro channels 1 and 2 failure for example.

PITCH RATE GYRO 4 CHANNEL FAILURE

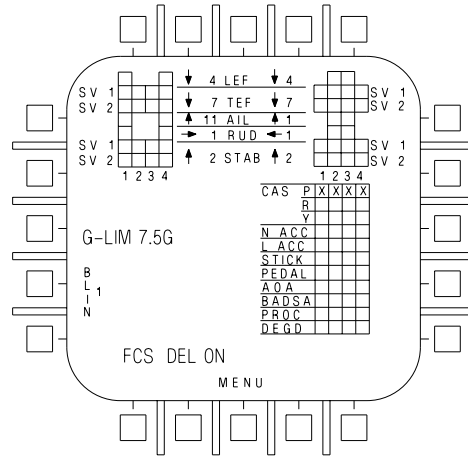

Effects:

Pitch in direct electrical link (DEL) mode.
No pitch augmentation.
Autopilot and ATC inoperative.

Flaps-AUTO

Poor pitch stability.
Excessive speed brake transient.

Figure 15-10. FCS Failure Indications and Effects (Sheet 8 of 10)

ROLL RATE GYRO 4 CHANNEL FAILURE

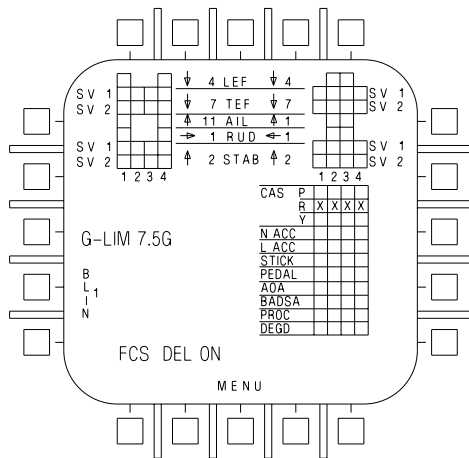

Effects:

- Roll in direct electrical link (DEL) mode.
- No roll augmentation.
- Reduced roll damping.
- Autopilot and ATC inoperative.

RUDDER PEDAL POSITION 4 CHANNEL FAILURE

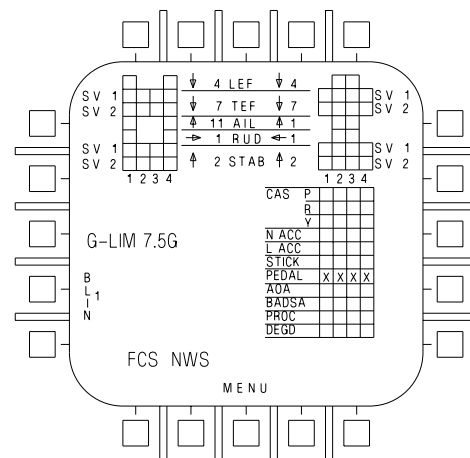

Effects:

- No rudder pedal control of rudders.
- No nosewheel steering.
- Trim gives 15 ° rudder.
- Lateral stick gives rudder for roll coordination.

YAW RATE GYRO 4 CHANNEL FAILURE

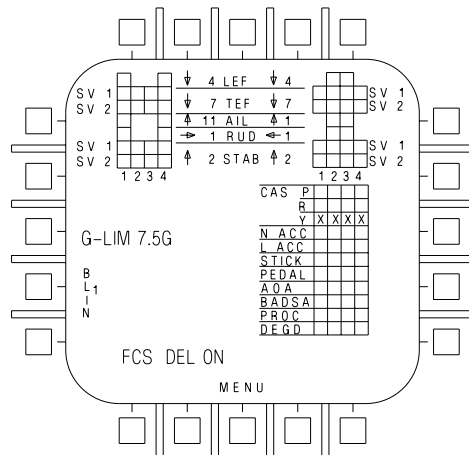

Effects:

- Roll and yaw in direct electrical link (DEL)
- No roll and yaw augmentation.
- Autopilot and ATC inoperative.
- Flaps-AUTO
 - Poor dutch roll damping.
 - Poor turn coordination.
- Flaps-HALF (do not use FULL flaps)
 - Poor dutch roll damping.
 - Poor turn coordination.

ACCELEROMETER 2 CHANNEL FAILURE

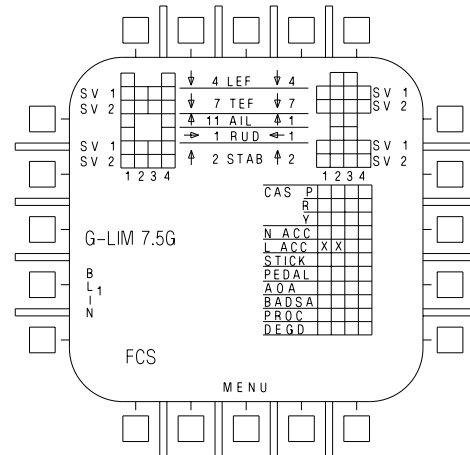

Effects:

- No change in flying qualities.
- Autopilot inoperative.

NOTE

- FCS status display shows lateral accelerometer channels 1 and 2 failure example.
- N ACC/L ACC applicable to F/A-18A after AFC 253 or 292 and F/A-18C/D.

Figure 15-10. FCS Failure Indications and Effects (Sheet 9 of 10)

**LATERAL ACCELEROMETER
4 CHANNEL FAILURE**

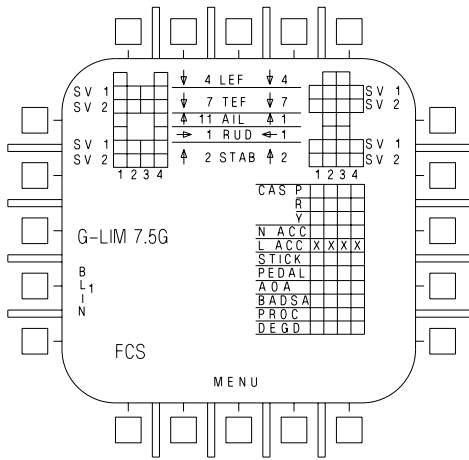

Effects:

- Degraded yaw CAS.
- Poor turn coordination.
- Autopilot inoperative.

NOTE

N ACC/L ACC APPLICABLE TO F/A-18A AFTER AFC 253 OR 292 AND F/A-18C/D

**NORMAL ACCELEROMETER
4 CHANNEL FAILURE**

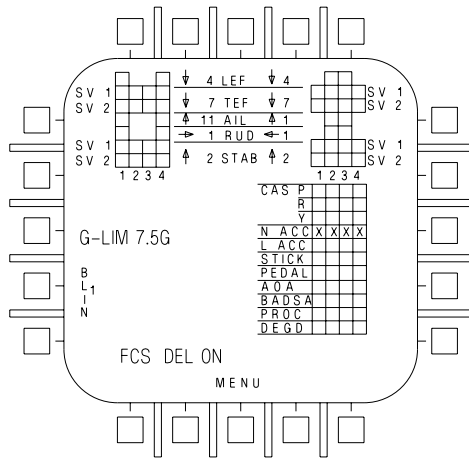

Effects:

- Pitch in direct electrical link (DEL) mode.
- No pitch augmentation.
- Autopilot inoperative.
- Flaps-AUTO
 - Poor pitch stability.
 - Excessive speed brake transient.
- Flaps-HALF or FULL
 - Pitch in CAS mode.

NOTE

N ACC/L ACC APPLICABLE TO F/A-18A AFTER AFC 253 OR 292 AND F/A-18C/D

**BACKUP AIR DATA SENSORS
4 CHANNEL FAILURE**

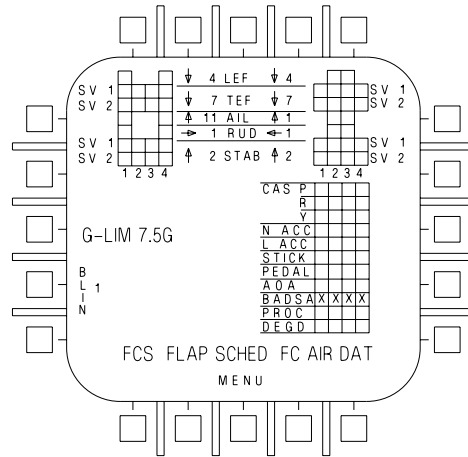

Effects:

- Pitot-static instruments may be inaccurate.
- Autopilot inoperative
- Flaps-AUTO
 - Degraded flying qualities.
 - Flaps schedule with AOA only.
 - Flaps go to 3° / 3° if ORIDE selected.
- Flaps-HALF or FULL
 - Trailing edge flaps 30° or 45°
 - Leading edge flaps and rudders schedule with AOA.

PROCESSOR 4 CHANNEL FAILURE

Effects:

- If software fault recovery process can clear fault- No effect.
- If complete processor 4 channel failure- No FCS failure indications on DDI.
- Stabilators revert to mechanical (MECH) mode.
- Ailerons and rudders revert to analog direct electrical link.
- Trailing edge flaps drive to 0.
- Leading edge flaps lock in position at failure.

NOTE

Processor 4 channel failure will cause many random FCS cautions.

Figure 15-10. FCS Failure Indications and Effects (Sheet 10 of 10)

15.30 FCS FAILURE

The reliability of the FCS is very high and, when failures do occur, they usually occur singly. No single failure will affect flying qualities. The flight control system has multiple redundancy and is designed to fail to the least critical configuration. Two flight control computers each have two flight control channels. Within each channel, each axis (pitch, roll, or yaw) is separate so that failure of one axis does not affect the other two. If normal CAS functions fail, each computer also provides a digital direct electrical link (DEL) between stick inputs and flight control surfaces. If roll or yaw digital DEL fails, the computers provide an analog DEL to the ailerons and rudders. If pitch digital DEL fails, a direct mechanical link from the stick to the differential stabilator actuators provides limited pitch and roll control. When a rudder or aileron actuator fails, the actuator degrades to a failed/flutter damped mode. The failed rudder or aileron will be slowly forced back to the faired position by aerodynamic loads. This failed/flutter damped failure mode has not been flight tested. Depending on which failures have occurred, flying qualities may be considerably degraded. Due to the variety of possible failure combinations, exact guidance cannot be given to cover every possible circumstance. However, specific procedures have been established for each FCS caution. See the Warning/Caution/Advisory Displays, figure 12-1, for appropriate action. Each instance requires individual judgement as to the flyability of the particular failure combination.

15.31 AOA PROBE DAMAGE

15.31.1 AOA Indications with AOA Probe Damage. Pilots should be alert for AOA probe damage after IFR basket impact during refueling, bird strikes, or icing conditions. Damage can result in AOA being declared invalid and AOA display inaccuracies. If AOA probe damage is ever suspected, an AOA/airspeed crosscheck, in the landing configuration, should be made with a wingman, if possible. Crosschecking with flaps AUTO may give a satisfactory crosscheck, but the probe can be bent in such a way that AOA anomalies are accentuated in the landing configuration. If AOA damage is suspected, follow the FLAP SCHED procedures. Also, with a declared AOA failure, ATC with flaps HALF or FULL is not available and selection should not be attempted.

15.31.1.1 FCC OFF Functionality. With flaps in AUTO, the FCC uses a split of $>10^\circ$ true AOA between the left and right AOA probes to declare AOA invalid. This failure in flaps-AUTO is characterized by the following indications:

- FCS caution
- Four channels of AOA are Xd out on the FCS status display.
- HUD AOA numeric display blanked.
- L and R AOA probe values lined out.

NOTE

An AOA probe split is determined by local AOA probe measurements and not the true AOA values provided for display on FCS status page. True AOA values displayed on the FCS status page are approximately 0.65 times local AOA values. Therefore, a split of 15.5° between local values approximates a 10° split between displayed true AOA values.

When flaps are HALF or FULL, there is a difference in thresholds used by the ADC and FCCs. An AOA can be declared invalid by the FCCs for splits as low as 3.3° . The FCC's split threshold will increase with sideslip. However, the ADC will consistently use a split threshold of 10° before declaring

AOA invalid. As a result, HUD AOA display, E-Bracket, AOA indexer lights and approach lights will continue to function when an AOA probe-split is less than 10° . The FCCs can still declare an AOA failure if the split is greater than 3.3° .

In HALF or FULL, a split between the AOA probes that is $>3.3^\circ$ and $<10^\circ$ is characterized by the following indications:

- FCS caution
- Four channels of AOA will be Xd out on the FCS status display. (Xs will latch.)

In HALF or FULL, the HUD AOA numeric display and E-bracket are normally driven by the average of both probes but will be blanked when AOA is declared invalid by both the ADC and FCC. This occurs when the split between the AOA probes is $>10^\circ$, and is characterized by the following indications:

- FCS caution
- Four channels of AOA will be Xd out on the FCS status display. (Xs will latch)
- HUD AOA numeric display blanked
- HUD E-bracket blanked
- AOA indexer lights and approach lights inoperative
- L and R AOA probe values lined out

Refer to figure 15-10 for a complete list of indications and effects.

15.31.1.2 ADC AOA Validity Functionality. Irrespective of flap state, the ADC will declare AOA invalid if the AOA probes differ by $>10^\circ$. Unlike FCC declared AOA failures, ADC declared AOA failures are not latched. ADC monitored AOA values can drift in and out of validity with maneuvers that cause the AOA probe splits to drift inside and outside the 10° threshold. As a result, the E-bracket, AOA numeric, indexer light and approach lights may blank and re-appear as the split crosses the threshold.

NOTE

Only when the ADC declares the AOA invalid will the indexer and external approach lights will be blanked.

L and R AOA probe values from the ADC and the INS AOA (center) value are displayed on the FCS status page. Whenever the ADC declares the AOA invalid, the L and R AOA values will continue to be displayed but they will have a line through them. The INS AOA value will not be lined out and will always be displayed irrespective of AOA anomalies.

An individual probe can be selected to drive the AOA E-bracket. Probe selection is accomplished by selecting GAIN ORIDE and pushing the AOA pushbutton to box and select the desired probe. The pilot can compare the INS AOA value against the L and R AOA values to determine which probe to select. When either the L or R AOA value is boxed, the AOA DEGD caution is displayed and the

selected AOA probe drives the E-bracket. In GAIN ORIDE, the INS AOA value drives the HUD AOA numeric value and, with Flaps HALF or FULL, the departure warning tone is inoperative.

CAUTION

The INS derived AOA value displayed in the center box on the FCS status page can become inaccurate when there's an AOA probe split. Therefore, if the INS derived AOA value does not match either L or R AOA value then AOA/airspeed crosscheck must be used to identify which probe is undamaged.

NOTE

Even with one AOA probe selected, as long as the split between the left and right AOA values is less than 10° , the ADC will continue to drive the AOA indexer and approach lights by the average value of both probes and will be inaccurate. Once a probe is selected, that probe will remain selected regardless of ADC AOA validity. The HUD E-bracket and AOA numeric will continue to be displayed as long as GAIN ORIDE and a probe is selected. If GAIN ORIDE is not selected, the HUD AOA numeric and E-bracket will blank when the ADC declares AOA invalid (i.e., AOA probe splits $>10^\circ$).

15.31.1.3 DAMAGED AOA PROBE PROCEDURE

The following procedure should be used for suspected AOA probe damage:

SUSPECTED AOA PROBE DAMAGE

1. FCS page - SELECT
2. Identify/confirm damaged probe.
3. Perform AOA/airspeed check before and after going dirty.
4. Refer to FLAP SCHED caution CORRECTIVE ACTION.

15.31.2 Jammed AOA Probe On Takeoff. When an AOA probe-split occurs within 12 seconds of takeoff (WoffW), FCC AOA is set at a fixed value of 10° and flaps-transition is inhibited, regardless of FLAP switch position, to prevent undesirable transients. The AOA probe-split threshold used by the FCC can be as little as 3.3° depending on sideslip. Two to ten seconds after WoffW, the FCS caution appears and all four AOA channels X-out on the FCS status display. The FCS will switch from using the fixed AOA value of 10° to using an estimated AOA value, calculated by the FCC, when an FCS reset

is performed or flap blow-up speed is exceeded. If Auto flaps is selected after takeoff, within the 12-second window, the flaps will retract at the end of 12 seconds.

NOTE

If the AOA tone is heard during takeoff roll, it may be an indication of dual stuck probes and the aircraft may not have sufficient pitch authority to rotate.

AOA Status	Flaps HALF or FULL No Split	Flaps Auto Split >3.3 and <10	Flaps HALF or FULL Split >3.3 and <10	Flaps Auto Split >10	Flaps HALF or FULL Split >10
Displays	HUD AOA: displayed E-bracket: displayed Indexers: displayed FCS AOA Xs: not set FCS caution: not set FLAP SCHED: not set L/R AOA: displayed	HUD AOA: displayed E-bracket: N/A Indexers: N/A FCS AOA Xs: not set FCS caution: not set L/R AOA: displayed	HUD AOA: displayed E-bracket: displayed Indexers: displayed FCS AOA Xs: SET FCS caution: SET FLAP SCHED: not set L/R AOA: displayed	HUD AOA: blanked E-bracket: N/A Indexers: N/A FCS AOA Xs: SET FCS caution: SET L/R AOA: lined out	HUD AOA: blanked E-bracket: blanked Indexers: blanked FCS AOA Xs: SET FCS caution: SET FLAP SCHED: not set L/R AOA: lined out
Indexer & External Approach Lights	Operative		Will be inaccurate.		Inoperative

Figure 15-11. AOA Probe Indications and Effects

15.32 PITOT STATIC PROBE DAMAGE.

Be alert for unannunciated pitot static probe damage after IFR basket impact during refueling, bird strikes, or icing conditions. The ADC can produce erroneous signals without any cautions or advisories if the pitot static probes sustain damage. HUD displayed airspeed may be inaccurate without error indications. Airspeed checks with a wingman should be made in the landing configuration if a damaged pitot static probe is suspected. Crosschecking in the cruise configuration may give a satisfactory crosscheck, but the probe may be bent in such a way that pitot static anomalies are accentuated in landing configuration.

The standby airspeed indicator receives signals from the left pitot static probe, so it will be accurate if only the right probe is damaged. If the left probe is damaged, the static source selector can be used to select the static pressure source from the right probe. The static source lever allows selection of right (BACKUP) or left (NORMAL) secondary static pressure to be applied to the standby indicated airspeed indicator, standby pressure altimeter, and standby vertical velocity speed indicator. With lever in the horizontal position, the selector valve is in NORMAL, with lever in the vertical position, the selector valve is in BACKUP.

NOTE

A detached pitot static line may cause malfunctions similar to those caused by a damaged pitot static probe. Selection of the secondary static source may or may not eliminate the problem.

If the GPS fails or is not available, and only ADC inputs are being used, inaccurate pitot static information will degrade INS performance.

CAUTION

If inflight damage to a pitot static probe is suspected, air data may be unreliable and FC AIR DAT procedures should be followed.

15.33 DIRECT ELECTRICAL LINK (DEL)

See the Warning/Caution/Advisory Displays, figure 12-1. Direct electrical link (DEL) operation results from the lack of reliable feedback data or operation within the FCS. DEL operation will usually occur in only one axis but yaw DEL operation forces the roll channel into roll DEL. In the DEL mode, pilot inputs position the control surfaces as a direct function of pilot input.

15.33.1 Digital DEL - DEL ON Caution. The digital roll DEL function is activated for any one of the following conditions: three roll rate gyro failures, reversion to digital yaw DEL, or reversion to analog yaw DEL. The digital yaw DEL function is activated for a three yaw rate gyro failure condition. The digital pitch DEL function is activated for any one of the following conditions:
With flaps in AUTO: three pitch rate gyro failures, or three normal accelerometer failures.
With flaps in HALF or FULL: three pitch rate gyro failures.

15.33.2 Digital DEL. If the FCS reverts to pitch DEL at transonic or supersonic speed, decelerate to 400 knots/Mach 0.8 to reduce the longitudinal PIO tendency. If the FCS reverts to roll and yaw DEL at transonic or supersonic speeds, slowly decelerate to below 400 knots/Mach 0.8 to reduce the uncomfortable sideforce oscillations due to weak dutch roll damping.

WARNING

In pitch DEL there is very little stabilator authority available. Therefore, the g available is extremely limited.

The use of the speedbrake in pitch DEL should be avoided, since it will normally lead to moderate longitudinal PIO. However, the speedbrake can be used for a 1 g incremental increase if required in an extreme situation. The trim rates are noticeably slower than in CAS, but they will allow neutral trimmed flight throughout the airspeed envelope. Damping of aircraft motion occurs only as a result of natural aircraft stability and is not enhanced by the FCS. Pilot inputs should be gentle at higher airspeeds since rapid inputs may aggravate the aircraft oscillations. Rapid power changes should be minimized as they may result in aggravation of PIO tendency due to trim changes. In roll and yaw DEL the use of the rudder is not recommended due to control sensitivity and dutch roll excitation. In pitch DEL, lateral stick inputs will couple into the pitch axis as a nose up rotation and will require a corresponding pitch input to correct. Normal formation flight and air refueling is possible with any axis

in DEL; however, caution must be exercised due to the reduced damping characteristics. Minimize in-close corrections during air refueling to prevent PIO.



Roll rates are significantly reduced at airspeeds above Mach 0.94 in roll or roll plus yaw DEL and may be as low as 65°/second.

For carrier or field landing, fly on-speed with flaps HALF. After a bolter in pitch DEL a large pitch up will occur which can be stopped with forward stick force. A similar pitch up will occur after a field landing and the pilot must consciously keep the aircraft on the ground; once stabilized after touchdown normal roll-out procedures can be used. Recommend field landings be conducted using a reduced sink rate to minimize the pitch up tendency. During approach in roll DEL the aircraft is easily excited in roll, resulting in a constant 2 or 3° roll oscillation. There is also no roll limiting, so lateral inputs will produce a noticeable increase in roll rates and roll response. The increased roll response may lead to a lateral PIO if large rapid inputs are used. Do not use more than ½ lateral stick or rudder pedal in approach configuration in roll DEL or roll plus yaw DEL, due to excessive sideslip and dutch roll; however, small timely rudder inputs can be used to dampen directional oscillations. Minimize maneuvering above on-speed when in roll and yaw DEL due to magnitude of sideslip generated. Jettison asymmetric wing stores. Minimize rapid power applications during approach in roll and yaw DEL with asymmetric stores as they will couple into the directional axis creating uncomfortable side forces. Do not exceed +12° AOA during approach maneuvering with asymmetric stores. Recommend a reduced sink rate landing with a short field arrestment when landing with asymmetric stores.



If a waveoff is carried out in pitch DEL, the pilot encounters a substantial stick force change during flap retraction. Almost full aft stick is required to maintain level flight.

For shipboard landings fly a straight-in approach with flaps HALF at on-speed AOA. The ability to effectively fly the aircraft with degraded flight controls increases significantly with time (steep learning curve). Consider lowering the gear and flaps (HALF flaps) early to evaluate the approach flying qualities. The ACLS/ILS needles would be used to ensure proper lineup by the “in the middle” positions. The LSO waveoff window should also be moved farther out such that only small glideslope/lineup corrections are required from the “in the middle” position.

15.33.3 Analog DEL. The FCS reverts to analog roll DEL and analog yaw DEL if there are three digital processor failures. In addition the analog roll DEL function is activated if three channels to the ailerons are Xd out and the analog yaw DEL function is activated if three channels to the rudders are Xd out. If the aircraft selects yaw DEL, the control laws also activate the digital roll DEL function. The flying qualities described for digital DEL (DEL ON caution) may or may not apply to this configuration. There is no analog pitch DEL mode.

If yaw analog DEL is active, the pilot’s rudder pedal provides direct rudder control. If roll analog DEL is active, the pilot’s lateral stick provides direct aileron control. Control surfaces move at a rate directly proportional to pilot input.

In roll analog DEL, the FCS provides no roll augmentation nor roll damping. Make shallow angle of bank turns and minimize side to side stick movements.

In yaw analog DEL, the FCS provides no roll and yaw augmentation. The aircraft will exhibit poor Dutch roll damping and poor turn coordination. If the aircraft selects yaw DEL, the control laws also activate the roll DEL function. Make shallow angle of bank, rudder coordinated turns and minimize side stick movements. Rudder pedal inputs are required to provide the direct electrical link to the rudders.

WARNING

Extreme caution should be used in analog DEL. Flight in this configuration has not been flight tested.

NOTE

- No air data flight control scheduling is available in analog DEL. The aircraft is more controllable in Full or Half flaps due to the availability of AOA information for control surface scheduling.
- The DEL ON caution is not displayed when in the analog roll DEL mode. The DEL ON caution is displayed when in analog yaw DEL since digital roll DEL is activated.

15.34 UNCOMMANDED PITCH AND ROLL EXCURSIONS

A stabilator simultaneous dual or four-channel feedback failure can cause uncommanded pitch and roll excursions. Unless pilot action is taken, the stabilator will not revert to MECH ON operation and the pitch and roll excursions will continue. Check the FCS status display. If there are two channel indications, a dual-channel failure has occurred. If there are no failure indications, a four-channel failure has occurred.

For a dual-channel failure, pulling one of the operating FCS channel circuit breakers causes the stabilators to revert to MECH ON with the ailerons, rudders and flaps operating normally in CAS. This configuration is adequate for field and shipboard landings at half flaps and onspeed AOA.

WARNING

Resetting the circuit breaker causes a return to the original failure mode with the resulting uncommanded pitch and roll excursions.

Refer to MECH ON Caution procedure for description of flight characteristics in the MECH ON mode.

For a four-channel failure, the only way to stop pitch and roll excursions is to pull three FCS circuit breakers to force the stabilator to MECH ON with ailerons, rudders, and flaps inoperative. This configuration has been safely flown at altitude but has not been flight tested. The aircraft should be trimmed, and flown as stick free as possible. Large rapid stick inputs result in extreme overshoots. Landing in either configuration is predicted to be hazardous.

1. Speedbrake - CHECK IN
2. Decelerate slowly below 400 knots/Mach 0.8.
3. Paddle switch - PRESS

If two channel failure indications in one stabilator -

4. Pull one operating FCS channel circuit breaker. DO NOT RESET.
5. Refer to MECH ON procedure.

If no FCS failure indications -

6. Climb to safe altitude.
7. Airspeed: below 250 knots.
8. Flaps - FULL
9. Lower gear and make Controllability Check.
10. If controllability permits landing - Short Field arrestment recommended

If control unsuitable for landing -

11. Climb to safe altitude.
12. Pull FCC circuit breakers 1, 2, and 3. DO NOT RESET.
13. Refer to MECH ON procedures.

15.34.1 Uncommanded Roll Excursion with Aileron Surface Missing/Damaged. Cracks in aileron outboard hinges may lead to failure resulting in partial or total loss of the control surface. An aileron hinge failure may be suspected if a sudden uncommanded roll-off combined with yaw and pitch occurs without an AIL OFF or FCS caution, a "Flight Controls, Flight Controls" alert or associated FCS Xs or BLIN codes. If the hinge has failed, it is likely that a portion of or all of the aileron surface will detach from the wing. However, aileron actuator functionality may be unaffected. The aileron position indicator on the FCS page will indicate the position of the actuator rod-end, even though the control surface is no longer attached. The only way to confirm this failure is a visual check of the suspected aileron surface to determine if the aileron surface is still attached and responding to control inputs.

Aileron surface departure may result in structural damage to the wing, empennage or fuselage. If the failed surface remains attached to the wing it may result in wing and/or aileron oscillations. If oscillations occur, immediately reduce airspeed by decelerating at 1g until the oscillations subside or are minimized. Maintain AOA <10°.



If aileron or wing oscillations are present, failure to immediately reduce airspeed until oscillations subside or are minimized may result in further structural failure.

Piloted simulation with a missing aileron has shown that flying qualities are degraded but adequate for all flap settings below 10° AOA. Lateral stick against the roll and rudder pedal in the opposite direction to counter side force buildup will be required for balanced flight. Aircraft response to normal control inputs is uncoordinated and roll performance will be more sluggish when rolling away from the detached/missing aileron. Lateral stick inputs will result in directional excursions. Lateral-directional motion will be lightly damped. Flap transitions to AUTO at low airspeeds and high gross weights may result in unrecoverable departure. If aileron damage occurs immediately after takeoff, selecting MAX throttles when airspeed is less than 220 KCAS and delaying selection of flaps AUTO until the flaps have scheduled up (above 250 KCAS) minimizes the risk of departure. Minimizing gross weight by jettisoning stores and maximizing acceleration improves flying qualities through the flap transition region.

WARNING

Flap transition to AUTO below 250 KCAS can result in large roll and yaw oscillations leading to unrecoverable departure, particularly at higher gross weights. Using smooth rudder pedal and stick inputs when controlling roll and yaw during transition will help avoid PIO. Reducing gross weight will reduce oscillations during transition.

Flying qualities are adequate for a shore-based landing; however, CV landings are extremely hazardous and are not recommended.

WARNING

Approaches to the ship are extremely hazardous. High rudder pedal and lateral stick forces required to keep a nominal sight picture will increase pilot workload and fatigue on approach. Ground loads may overstress the landing gear on touchdown due to combined roll/yaw attitudes. Line-up corrections in-close result in bank angle on touchdown that can result in a wingtip engaging the arresting wire. The aircraft will tend to drift towards the failed aileron and the LSO should expect constant line-up corrections on approach. At touchdown, NWS will engage with WonW and will cause large centerline excursions if rudder pedal inputs are not removed at touchdown.

If carrier-based, divert to an appropriate airfield. When determining the divert/BINGO profile, consider the presence of wing or aileron oscillations and flap setting and their impact on divert airspeed and fuel management.

CAUTION

Bingo profile may be adversely affected due to reduced airspeed necessary to avoid oscillations. Allow for a controllability check prior to landing.

Prior to landing, conduct a Controllability Check. Consideration should be given to jettisoning stores on failed wing to reduce lateral weight asymmetry and gross weight for landing. Determine whether

Flaps - HALF or Flaps - AUTO is appropriate based on crosswinds at the landing site. If crosswinds at the landing site are 15 knots or less, conduct Flaps - HALF Controllability Check, otherwise conduct FLAPS - AUTO Controllability Check.

NOTE

Flap transition from AUTO to HALF may result in roll into the failed aileron but does not result in significant transients.

Lateral weight asymmetries with heavy wing on the failed side will aggravate the roll-off and may preclude the aircrew's ability to zero the roll-off with trim.

Flying qualities should be adequate for a shore-based approach to landing. Flying qualities may be degraded such that roll inputs are sluggish and aircraft response to control stick or throttle inputs may be coupled in roll, pitch, and yaw. Line-up corrections will be sluggish and a straight-in approach is required to avoid late corrections.

Uncommanded Roll Excursion with Aileron Surface Missing/Damaged Procedure:

1. Reduce load factor to 1g and maintain balanced flight.
2. Do not exceed 10° AOA.

WARNING

Exceeding 12° AOA may result in an uncontrollable roll-off into the missing aileron resulting in OCF. If an uncontrollable roll-off occurs, immediately reduce AOA. If aileron or wing oscillations are present, failure to immediately reduce airspeed until oscillations cease can result in further structural failure.

If FLAPS FULL -

3. FLAP switch - HALF
4. Maintain airspeed below 230 KCAS.

If carrier-based -

5. DIVERT.

If FLAPS AUTO required for divert or for high crosswind landing (>15 kts) -

6. Reduce gross weight to the maximum extent practical (SEL JETT stores).
7. Throttles - MAX for Flap transition
8. Above 250 KCAS - FLAP switch - AUTO

WARNING

Flap transition to AUTO below 250 KCAS can result in large roll and yaw oscillations leading to unrecoverable departure, particularly at higher gross weights. Using smooth rudder pedal and stick inputs when controlling roll and yaw during transition will help avoid PIO. Reducing gross weight will reduce oscillations during transition.

CAUTION

Bingo profile may be adversely affected due to reduced airspeed necessary to avoid oscillations. Allow for a controllability check prior to landing.

For all cases -

9. Use smooth control inputs.
10. Land as soon as practical.

FOR LANDING

1. Execute Controllability Check procedure.
 - If crosswinds at field are 15 knots or less - FLAPS HALF.
 - If crosswinds at field are >15 knots - FLAPS AUTO. Consider maximum groundspeed for tires and arresting gear. If groundspeed is excessive, reduce gross weight or consider flying up to 10° AOA approach.
 - If able, SEL JETT stores on the same side as the missing aileron to reduce asymmetry on failed wing.

NOTE

Lateral weight asymmetry with the heavy wing opposite to the missing aileron improves flying qualities. Lateral weight asymmetries greater than 4,000 ft-lbs with heavy wing on same side as the missing aileron severely degrade flying qualities.

2. Fly a straight-in approach.
3. Fly a crabbed approach, taking out half the crab just before touchdown.

4. Make an arrested landing (if practical).



Expect unusually large crab angles with crosswind. If possible, land with crosswind into the missing aileron. NWS will engage with WonW and will cause large centerline excursions on the runway if rudder pedal inputs are not removed at touchdown. Use rudder trim to the maximum extent. Expect directional oscillations on touchdown when pedal is required.

15.35 MECH ON CAUTION

Refer to Warning/Caution/Advisory Displays, figure 12-1. Mechanical operation (MECH ON) can be the result of various FCS failures (with or without ailerons and rudders operative); complete electrical failure, including the battery (without ailerons and rudders operative); or as a deliberate pilot selection (pulling FCC channels 1 and 2 circuit breakers) to conserve battery power for landing after a double generator/double transformer-rectifier failure (without ailerons and rudders operative).

A rectangular icon with a thick black border containing the word "WARNING" in bold, uppercase letters.

WARNING

- Extreme caution should be exercised in MECH ON with ailerons/rudders inoperative. This configuration has not been flight-tested.
- Reversion to MECH ON has often resulted in large pitch-up or pitch-down transients.
- Resetting the FCS while in MECH may result in large pitch-up or pitch-down transients.

15.36 MECH ON WITH AIL AND RUD OPERATIVE

Refer to Warning/Caution/Advisory Displays, figure 12-1. If no surface hardover failures occur, reversions into MECH ON are normally characterized by a rapidly increasing aft stick force, stabilized at 3 to 5 pounds for flaps AUTO and 15 to 25 pounds in the landing configuration (on-speed). Use care at all airspeeds, especially above 400 knots/Mach 0.8, to avoid over control in pitch and resulting PIO. The stick force per g gradient is higher than a normal CAS aircraft but will allow adequate maneuvering performance. Do not use the speedbrake, since it will lead to severe longitudinal PIO. Rapid power changes should be minimized as this may result in aggravation of PIO tendency due to trim changes. Lateral stick inputs couple into the pitch axis as a nose up rotation and require a corresponding pitch input to correct. Formation flight and air refueling is possible, even with roll plus yaw DEL; however, pilot workload greatly increases. For air refueling ensure a good lineup and keep all inputs to a minimum when closing on the basket as a violent longitudinal PIO may result. For carrier or field landing, fly on-speed with flaps HALF. After a bolter in pitch MECH a large pitch up occurs which can be stopped with forward stick force. A similar pitch up occurs after a field landing and the pilot must consciously keep the aircraft on the ground; once stabilized after touchdown normal

roll-out procedures can be used. Recommend field landings be conducted using a reduced sink rate to minimize the pitch up tendency. A short field arrestment is also recommended.

CAUTION

If a waveoff is carried out with a subsequent transition to up and away flight, ensure that the FLAP switch is set to AUTO below 250 knots, as the aircraft is very prone to PIO if the flaps are allowed to automatically retract.

15.37 MECH ON WITH AIL AND RUD OFF

Refer to Warning/Caution/Advisory Displays, figure 12-1. Diagnosis of specific failure condition can be made by referring to the FCS failure indications and effects, figure 15-9. Note that the ratio changer may be failed to the flaps AUTO setting (low gain) or HALF/FULL setting (hi gain), independent of FLAP switch position. Flying qualities may be similar to those described in the MECH ON WITH AIL AND RUD OPERATIVE section. If the decision is made to land, approach speeds are much higher than normal at on-speed AOA. Nosewheel steering is inoperative.

15.38 FLAPS OFF CAUTION

See the Warning/Caution/Advisory Displays, figure 12-1. When a LEF failure occurs, the LEF brake locks the LEF in response to an out-of-tolerance condition. In addition, the LEF asymmetry brake locks the LEF when a split between the inboard and outboard LEFs (on the same wing) differ by more than 3° . Another lock out condition can occur when the difference between the commanded and actual position differ by more than 3° and the aircraft is maneuvering below 1.5 g. When the aircraft is maneuvering above 1.5 g, the FLAPS SCHED criteria are used to determine LEF failures.

CAUTION

If a HYD 1B and the left leading edge flap fail or a HYD 2A and the right leading edge flap fail together, do not press the FCS RESET button. Resetting the FCS with one of the above combinations may result in a second hydraulic circuit failure.

NOTE

LEF logic does not compare left wing LEF position to right wing LEF position.

The inboard and outboard LEF surfaces are mechanically connected by a common drive shaft. When a LEF failure occurs, the entire flap is locked to prevent further movement. If a mechanical failure occurs such that the inboard and outboard are split on the same wing, it has been shown that controllability is governed only by the position of the inboard flap. Therefore, the LEF procedures mandate visually confirming the position of the inboard LEF and is discussed in the following paragraphs.

15.38.1 LEF FAILED (WITH INBOARD POSITION FAILED UP BEYOND 4° OVER-TRAVEL STOP)

During high g maneuvering, all elements of the LEF braking system must work to stop the LEF in a failure mode. If the LEF back up brake system does not function properly, the LEF can move rapidly and possibly overpower the over-travel stop, resulting in a large leading edge up deflection (beyond the over-travel stop design maximum of 4° upward deflection). The LEF braking system is not designed to function beyond the over-travel stop. Any deflection beyond the over-travel stop could potentially deflect to a full structural limit of approximately 55°. With only the outboard section of the LEF failed up beyond the design limits, it has been shown that aircraft can be controllable in the landing configuration with HALF flaps.

Failures that result in extreme inboard LEF leading edge up deflections are highly susceptible to departure at airspeeds below 250 KCAS. The minimum controllable airspeed depends on the severity and configuration of the LEF failure. The only way to confirm extreme LEF failures is by visual check as the FCS indications will be inaccurate or blanked. Use care to maintain airspeed above 300 KCAS while assessing the LEF positions. Extreme failure of the inboard section of the LEF will result in immediate uncommanded roll and yaw that can be controlled with pilot input (lateral stick against the roll and rudder pedal in the opposite direction, countering side force buildup) given adequate airspeed. As airspeed decreases, roll and yaw moments will build, leading to a departure. Flight data shows that extreme failure of the inboard LEF, with or without the failure of the outboard section, to a position leading edge significantly up (beyond about 45°) results in an uncontrollable aircraft below approximately 250 KCAS in flaps AUTO. With flaps HALF, limited flight data indicate high buffet loads (to the point of not being able to read the HUD) at airspeeds of approximately 190 KIAS, and an abrupt departure at airspeeds slightly below 190 KIAS in this configuration.

The Rolling Surface to Rudder Interconnect (RSRI) in the flight control software may complicate an inboard LEF failure by attempting to coordinate the roll commanded by the pilot input (lateral stick) to counter roll-off. Simulation data shows that selecting GAIN ORIDE with flaps AUTO reduces RSRI commanded input and provides additional rudder control authority, which may allow controlled flight to slower airspeeds. Therefore, controllability checks in GAIN ORIDE with flaps AUTO are recommended. Reduce gross weight to the maximum extent possible prior to performing controllability checks. Landing in GAIN ORIDE with flaps AUTO with LEF failure has not been flight tested. Expect degraded flying qualities. Only a real-time controllability check can determine whether the individual LEF failure experienced will be controllable all the way to touchdown. Carrier landing is not recommended. Extreme caution is recommended because there is little to no warning of impending departure. This failure condition has never been flight tested.

WARNING

Leading edge up deflections of the inboard LEF beyond the 4° over-travel stop may result in an uncontrollable configuration below 250 KCAS. Selecting GAIN ORIDE with flaps AUTO may provide controllability at slower airspeeds. There may be little warning of impending departure as airspeed decreases. Immediate ejection may be required. Departure will be unrecoverable.

NOTE

Any deflection beyond the over-travel stop could potentially reach a full structural limit of approximately 55° leading edge up.

15.38.2 LEF FAILED (WITH INBOARD POSITION LESS THAN 4° UP) OR TEF FAILED

If the LEFs are locked in a more up-position than the automatic flap schedule dictates, then stall and departure AOA are lower (as low as 10° AOA if the LEFs are at 0°). Buffet with the LEFs at 0° is moderate at about 7° AOA. Use care to prevent AOA excursions above 10°. With the LEFs locked at 20° to 30° down, landing-configuration handling qualities are essentially normal. Even with the outboard section of the LEF failed up beyond the design limits, the aircraft can be controllable in the landing-configuration with HALF flaps.

With a LEF lockout/failure, upon selecting HALF-flap position, the functional LEF as well as the functional TEFs will extend normally. However, the failed/locked-out LEF remains frozen creating an asymmetric flight control surface condition that can be countered with lateral stick and trim. If the AUTO flap position is then selected, after selecting HALF or FULL, the functional LEF/TEFs do not retract until GAIN ORIDE is selected. If fuel is a concern (as with CV cyclic operation), selecting GAIN ORIDE with FLAP switch in AUTO allows all non-failed flaps to retract to a more fuel conserving 3°/3° position. Returning GAIN ORIDE switch to normal returns functional TEFs to normal scheduling, but as long as there is a failed/locked LEF, the functional LEF remains in the GAIN ORIDE position. With the GAIN switch in ORIDE above 350 knots an uncontrollable divergent pitch PIO may occur. With the FLAP switch AUTO, ORIDE provides 3°/3° flaps.

In the event of a TEF failure, the failed TEF trails to its neutral uplock position. To prevent asymmetry, the functional TEF is also shut off and trails to its neutral uplock position as well. With a TEF failure, if the TEFs are more up than the automatic flap schedule dictates, the aircraft attitude is more nose-up than normal at any given airspeed in AUTO. In the landing configuration, the approach speed is much higher at on-speed AOA. An AOA of 10° to 11° may be used for landing, but the over-the-nose field of view is reduced.

15.39 FLAP SCHED CAUTION

See the Warning/Caution/Advisory Displays, figure 12-1. The FLAP SCHED caution indicates the flaps are not scheduling properly. It is always accompanied by a Master caution and FCS caution. Air data failures will also cause the FLAP SCHED caution to be asserted.



With an air data failure, without GAIN ORIDE selected, the rudders go to full 30° toe in at touchdown which may result in an uncommanded nose pitch-up.

The FLAP SCHED caution is asserted if either the left or right LEF is off schedule (difference between the LEF position/command is greater than 10° with AOA above 12 degrees). A FLAPS SCHED caution accompanied by BLIN 221 provides a good indication that an off-schedule LEF caused FLAPS SCHED caution. PROM 10.7 never asserts a FLAP SCHED caution for AOA probe splits as the FCC will continue scheduling the flaps based on an AOA estimate. The FLAP SCHED caution remains for six seconds after the failure condition clears. AOA probe splits never assert a FLAP SCHED caution because the FCC will continue scheduling the flaps based on an AOA estimate.

For all FLAP SCHED cautions, establish straight and level flight then check handling qualities. If the leading edge flaps are frozen in a more up position than the scheduled position, stall and departure will occur at a lower AOA than normal. With the GAIN switch in ORIDE above 350 knots, an

uncontrollable divergent pitch PIO may occur. With the FLAP switch AUTO, ORIDE provides 3°/3° flaps.

For all FLAP SCHED cautions, select GAIN ORIDE for landing. Transition to the landing configuration at 200 knots, straight and level at a safe altitude, and check flying qualities. Aircraft response may be sensitive near 200 knots but will probably be about normal at ON-SPEED AOA. If AOA is failed, leading edge flaps and rudder toe-in are scheduled by an AOA approximation for 1 g flight. Stalls occur at a lower AOA with GAIN ORIDE selected due to fixed flap positions.

15.40 NWS CAUTION

See the Warning/Caution/Advisory Displays, figure 12-1. The NWS caution comes on when nosewheel steering is shut off due to detection of a failure in the system. Emergency high gain nosewheel steering is available after an FCS channel 2 or 4 failure. To engage the emergency mode, pull the failed channel circuit breaker, unlock the wings, and press the NWS button.

NOTE

If pressing the NWS button results in an FCS caution and single X in the powered channel, emergency HI gain steering is not available.

The NWS remains engaged in the high gain mode after the NWS button is released. The emergency mode can be disengaged by pressing the paddle switch. The emergency mode should be engaged only for low speed taxi. Emergency HI gain operation prevents detection of NWS command failures so be alert for uncommanded steering. Press the paddle switch immediately upon detection of uncommanded steering.

Nosewheel steering is not available with a HYD 2 failure. The NWS caution does not come on but the NWS cue on the HUD flashes. A flashing cue does not necessarily indicate failed nosewheel steering since the cue flashes with either an MC1 failure, or a HYD 2A and HYD 2B failure.

15.41 AILERON FAILURE/AIL OFF CAUTION

See the Warning/Caution/Advisory Displays, figure 12-1. When an aileron fails, the surface is driven to the faired position by air loads and is damped to prevent oscillations. If the ailerons were drooped, the functional aileron is driven to the undrooped position. With both ailerons undrooped, approach speed will increase about 8 knots in Flaps FULL, and 16 knots in Flaps HALF. The functional aileron continues to assist in providing control. Roll damping is noticeably less. Use care to prevent overcontrol and resulting lateral PIO, especially when approaching touchdown.

15.42 JAMMED CONTROLS

Stick inputs are position sensed and a jammed stick prevents normal control. If the linkage to the mechanical servo valve is jammed, an override spring cartridge allows stick motion. If the stick is jammed, trim provides ample authority for controlled flight. The autopilot, except for control stick steering, may also be used for aircraft control.

15.43 OUT-OF-CONTROL FLIGHT (OCF)

Departure from controlled flight can result in fully developed out-of-control flight. The basic F/A-18 airframe exhibits four spin modes (three upright and one inverted) and two Falling Leaf modes

(upright and inverted). The control system makes spin entry difficult (within asymmetric AOA limits) and suppresses Falling Leaf motion.

NOTE

Violent departure may cause structural damage. A wingman visual inspection (if available) and a controllability check should be performed following a violent departure.

15.43.1 Departure. The aircraft has departed when it is not properly responding to control inputs. **Releasing the controls, taking feet off rudders, and retracting the speedbrake recovers the aircraft from most departures.** Continued control inputs in this situation aggravate the situation and delay recovery. It is imperative that a departure be recognized immediately and the Departure Recovery procedure executed. If the aircraft does not respond to released controls after allowing 5 to 10 seconds for post-stall gyrations to cease, it may be in a Falling Leaf or spin. Reanalyze the situation. Execute the appropriate recovery procedures.

15.43.2 Falling Leaf. The Falling Leaf mode may be encountered during departure recovery, during the final stages of spin recovery, or following zero airspeed (vertical) maneuvers. This mode is characterized by repeated cycles of large, uncommanded yaw/roll motions which reverse directions every few seconds. At each reversal, the crew will sense high side-forces accompanied by near zero g. Repeated crew observations of this sensation on both sides of the aircraft confirm the Falling Leaf mode. The upright/positive AOA Falling Leaf mode is the most common Falling Leaf mode. Entry into the inverted/negative AOA Falling Leaf mode is highly unlikely. It is possible to get transient spin arrows during the Falling Leaf mode. During controls released recovery testing, average altitude loss prior to indications of recovery was 5,000 feet with the maximum altitude loss being 12,000 feet. Extraordinary patience is required during recovery. Positive indications that the aircraft is recovering are an increasingly nose low attitude and increasing peak airspeed. Recovery is normally preceded by the presence of a strong side-force coupled with an unload in a very nose low or slightly inverted attitude.

WARNING

Chasing transient spin recovery arrows will delay recovery. Do not chase the spin arrows.

15.43.3 Spin. The spin mode is the least often encountered out-of-control mode of the F/A-18. Spin is confirmed by the presence of a sustained yaw rate, fluctuating AOA, pegged turn needle and airspeed less than 150 knots. Yaw rate may be difficult to determine initially due to oscillation but should exhibit a predominant direction as spin rotation continues. When a spin has been visually confirmed, DDIs should be checked for a command arrow, and if present, full lateral stick should be applied in the direction of the arrow to provide anti-spin controls. The command arrow, by itself, is not confirmation of a spin because during the most violent departures the SRM logic is met and cycling or steady spin arrows are presented to the pilot for up to several seconds. If a spin has been confirmed with no command arrow present, SRM logic may not be fulfilled because of an oscillatory yaw rate and the use of the manual spin recovery switch is required for recovery. If manual spin recovery mode is used, exercise caution during pull-out (use smooth stick inputs) since the flight controls remain in SRM until the airspeed increases above 245 knots or the switch is placed to NORM. While in manual SRM the aircraft is very sensitive to control inputs in all axes until the flight controls revert to CAS. The command arrow indicates the proper control stick position for upright or inverted spin. For upright spins, the command arrow directs the pilot to apply full lateral stick with the spin direction. For inverted spins, the command arrow directs the pilot to apply full lateral stick opposite the spin

direction. Recovery begins immediately, but may take up to one turn to become apparent. When the yaw rate stops, smoothly neutralize lateral stick, ensure spin recovery switch is in NORM, and re-analyze the situation. The aircraft may enter a Falling Leaf during recovery from a spin.

NOTE

During highly oscillatory out-of-control motion, cycling of the command arrows may occur. Under these conditions, maintaining full lateral stick until the command arrow disappears may delay spin recovery and lead to excessive altitude loss (1,000 to 2,000 feet). If/when the pilot has confirmed that yaw rate has decreased to zero, anti-spin controls should be neutralized even if a sustained command arrow is present. This minimizes altitude loss during recovery.

15.43.4 OCF Recovery Procedures

*1. Controls - RELEASE, FEET OFF RUDDERS, SPEEDBRAKE IN

If still out of control -

*2. Throttles - IDLE

*3. Altitude, AOA, airspeed and yaw rate - CHECK

If command arrow present -

*4. Lateral stick - FULL WITH ARROW

When command arrow removed -

*5. Lateral stick - SMOOTHLY NEUTRAL

When recovery indicated by AOA and YAW rate tones removed, side forces subsided, and airspeed accelerating above 180 KCAS -

*6. Recover.

WARNING

Failure to ensure all criteria are met may result in departure during recovery.

Passing 6,000 feet AGL, dive recovery not initiated -

*7. Eject.

15.43.5 Post Departure Dive Recovery

WARNING

- Recovery is indicated when AOA and YAW rate tones are removed, side forces subside, and airspeed is accelerating above 180 knots.

Failure to ensure all criteria are met may result in redeparture during recovery.

- Limit AOA to 10° during a recovery from departure caused by a flap system failure/malfunction (FCS/FC AIR DAT/FLAPS OFF cautions) to avoid departing the aircraft. Departure warning is characterized by an uncommanded yaw/roll.
 - Post departure dive recovery initiated below 6,000 feet AGL is not assured. Delaying the ejection decision below 6,000 feet AGL while departed may result in unsuccessful ejection.
1. One-g roll to the nearest horizon.
 2. Throttles - MAX (MIL if altitude not critical)
 3. Pull to and maintain 25° to 35° AOA until positive rate of climb established (AOA configuration dependent).

WARNING

A positive rate of climb requires wings level pitch attitude (waterline) greater than indicated AOA.

If aircraft departs during dive recovery below 6,000 feet AGL -

4. Eject.

15.44 CONTROLLABILITY CHECK

Requirement: Malfunction, failure, or damage, which degrades approach and landing characteristics.

Purpose (to determine):

- Whether to attempt an approach or a controlled ejection
 - Safe landing configuration
 - Safe final approach airspeed/AOA
1. Climb to and maintain a safe altitude in VMC.
 - 15,000 feet AGL (recommended)
 - At or above 5,000 feet AGL (if practical)
 2. Coordinate a visual inspection (if possible).
 3. Plan to configure aircraft and conduct controllability check as close to field/CV as possible (avoid populated areas if able).
 - In all cases, consider BINGO fuel requirements.
 4. Reference the appropriate emergency procedure to plan the following:
 - Normal or Emergency Landing Gear Extension
 - Appropriate flap setting for controllability check and landing

- AOA and/or airspeed limitations
 - Any controllability issues that may arise from landing gear and/or flap extension
 - Desired landing gross weight and fuel dump plan
5. Consider Select Jettison stores prior to gear extension if:
- Lateral weight asymmetry is over 6,000 ft-lb to establish a more symmetric configuration
 - Emergency Landing Gear extension required (i.e., no HYD 2A)
 - Stated in appropriate emergency procedure

If single engine -

6. Reduce gross weight. Refer to figure 16-2.
7. Maintain operating engine above 85 % RPM during flap and landing gear extension.
8. Do not exceed 15° AOB in turns (if possible).

If normal landing gear extension possible (i.e., no HYD 2A caution) -

9. Slow to below 250 KCAS.
10. LDG GEAR handle - DN

If normal landing gear extension not possible -

9. Execute Landing Gear Emergency Extension procedure.
 - Do not configure flaps during Landing Gear Emergency Extension.
 - Return to Controllability Check procedure once gear extended.

Once landing gear down and locked -

10. DO NOT TRIM until minimum controllable airspeed is determined.
11. Crosscheck AOA and airspeed during decel.
12. FLAP switch - AUTO/HALF/FULL based on:
 - Flap setting stated in appropriate emergency procedure
 - If single engine, flaps HALF
 - Consideration of type landing, failure/damage, engine performance, etc.
13. Determine minimum controllable airspeed by slowing in 10 knot increments.
 - If still controllable at AOA limit stated in appropriate emergency procedure or on-speed, plan on flying appropriate AOA for approach and landing.
 - If one-half stick or rudder pedal deflection required to maintain balanced flight prior to AOA limit stated in appropriate emergency procedure or on-speed, add 10 knots for airspeed to be used during approach and landing.
 - If lateral stick required for balanced flight, plan for turns in the direction of stick displacement (if possible).
14. Assess:
 - Controllability in a 15° AOB turn
 - Throttle response and wave-off maneuver

If controllability unacceptable to attempt landing -

15. Consider a controlled ejection over an unpopulated area (if possible).

If controllability acceptable to attempt landing -

15. Fly a straight-in approach.
 - Do not go slower than the minimum-controllable-airspeed-plus-10 knots, or equivalent AOA, as determined during controllability check.

If single engine -

16. Execute Single Engine Approach and Landing procedure.

If dual engine -

16. Return to appropriate emergency procedure to ensure all corrective action steps are completed prior to attempting approach to landing.
17. If arrested landing desired/required, consider effects of approach speed on max arresting gear engagement speed.
18. If controllability changes or safe landing is not certain at any point on approach, execute wave-off/missed approach immediately.

CHAPTER 16

Landing Emergencies

16.1 SINGLE ENGINE FAILURE IN LANDING CONFIGURATION

- *1. Throttles - MIL or MAX
- *2. FLAP switch - HALF
- *3. Maintain on-speed AOA and balanced flight.
- 4. Refer to Single Engine Approach and Landing procedure.

NOTE

At some aircraft weight and high altitude conditions, and with one engine failed, even the use of MAX thrust on the operating engine may not provide positive rate of climb capability with half flaps and landing gear down. Maximum pressure altitude to achieve 100 fpm single engine rate of climb is provided in the adjacent chart, figure 16-1.

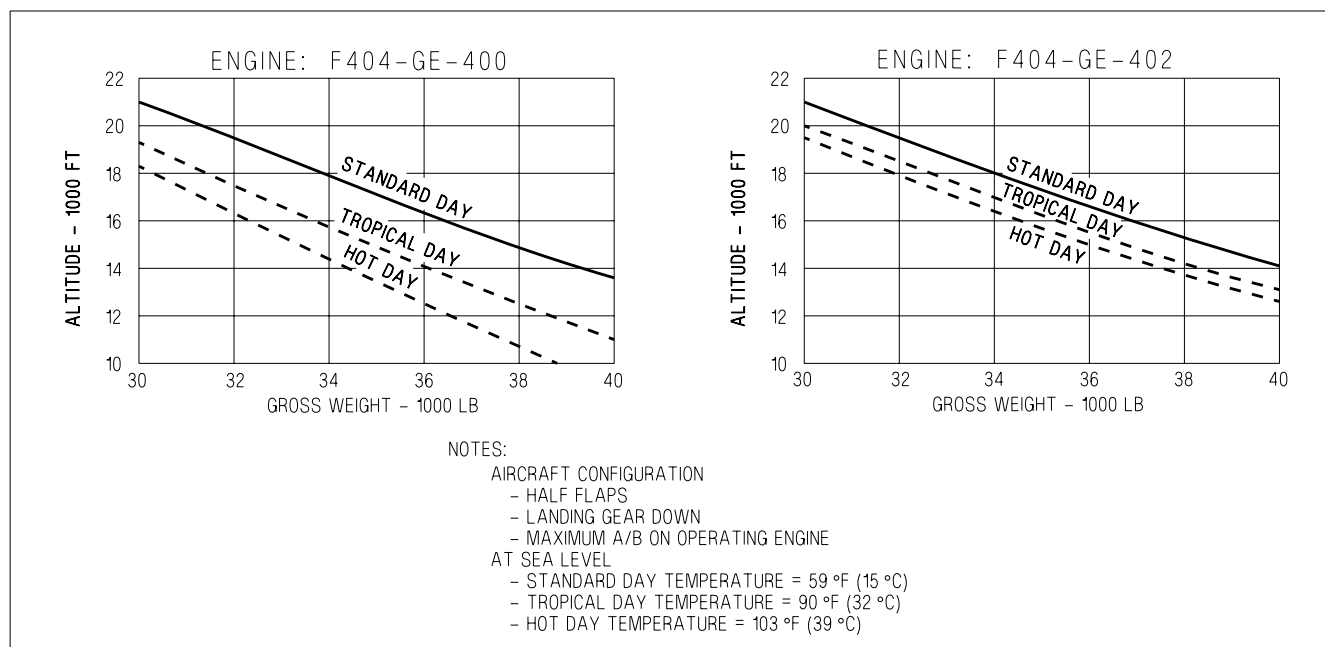

ADA520-323-1-045

Figure 16-1. Maximum Altitude for 100 FPM Single Engine Rate of Climb

16.2 SINGLE ENGINE WAVEOFF/BOLTER

WARNING

During single engine operations at MIL or MAX, loss of lateral and directional control may occur above the following AOAs:

Flaps FULL - 10° AOA

Flaps HALF - 12° AOA

NOTE

- Best rate of climb during single engine operation occurs at or near on-speed AOA regardless of configuration or gross weight.
- Minimal reduction in altitude loss can be obtained with selection of MAX during single engine waveoff, but this technique is not recommended due to increased pilot workload attendant with higher asymmetric thrust.
- Single engine waveoffs and bolters with F404-GE-402 (EPE) engines installed may require full rudder and coordinated lateral stick to control aircraft yaw and roll produced by asymmetric thrust.
- Figure 16-2 provides recommended maximum gross weight for single engine carrier recovery for both GE-F404-400 and -402 powered aircraft. Adjusting gross weight at or below the recommended weight ensures less than 50 feet altitude lost during an onspeed AOA single engine military power waveoff from an onspeed AOA/on glideslope condition. Maximum waveoff altitude lost for two engine operation under identical conditions is less than 30 feet. Recommended weights are applicable to windmilling or seized condition for the failed engine.
- With left engine failure, once positive rate of climb is achieved, raise the landing gear to improve acceleration and climb at a low angle of attack to a safe altitude/airspeed.

16.3 SINGLE ENGINE APPROACH AND LANDING

WARNING

- Use of afterburner on the good engine above on-speed AOA aggravates directional control problems resulting in higher single engine minimum control airspeed (about 8 to 10 knots).
- With F404-GE-402 (EPE) engines installed, use of afterburner on the good engine with full flaps selected (sudden single engine waveoff or bolter) may put the aircraft at or below single engine minimum control airspeed depending on gross weight. Exercise caution to avoid overrotation. Apply rudder and lateral stick as necessary to counter yaw

induced from asymmetric thrust until rudder control power is regained as the aircraft accelerates.

NOTE

- In the F/A-18C/D with either engine secured, significantly lower and/or cyclic dump rates have been experienced. When the right engine is secured, lower dump rates follow immediately and may be accompanied by a CG caution. When the left engine is secured, lower dump rates are experienced as total fuel reaches 6500 pounds (when tank 4 is empty).
- Hydraulic system capacity is dependent on respective engine rpm. Excessive simultaneous hydraulic system demands (i.e., landing gear activation, flap movement, and multiple flight control inputs, etc.) combined with single engine rpm below 85 % may exceed hydraulic system capacity or result in FCS reversion to MECH. Therefore, when practical, maintain engine with operating HYD system at or above 85 % rpm.
- To prevent repeated switching valve cycling, avoid stabilized flight where engine windmilling rpm produces hydraulic pressure fluctuations between 800 to 1600 psi.

GENERAL CONSIDERATIONS -

1. Reduce gross weight.

NOTE

Recommended single engine recovery weight is depicted in figure 16-2.

2. If practical, maintain operating engine rpm at or above 85 % rpm to preclude MECH reversion.
3. Consider crossbleed to provide HYD 2 pressure to extend the landing gear normally and to preserve APU accumulator pressure for emergency braking and emergency nosewheel steering.

CAUTION

- Do not crossbleed if engine and/or AMAD related damage is suspected.
- Extended crossbleeding of a failed engine traps feed tank fuel on that side if the FIRE light has not been pushed, and may result in a flameout.
- ATS exhaust may blister paint and cause possible door damage on the aft underside of the fuselage.

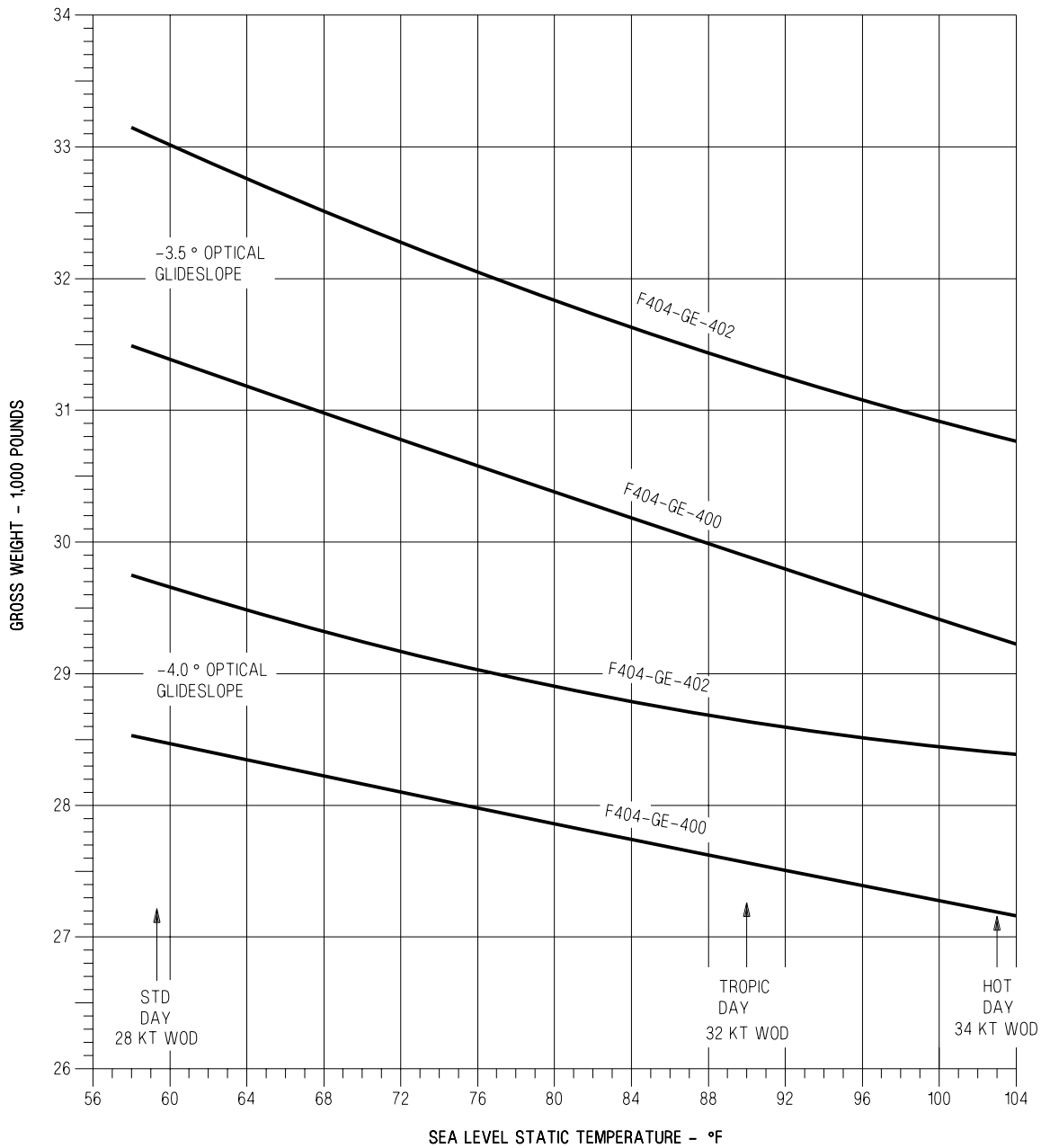

NOTES

- HALF FLAPS
- LANDING GEAR DOWN
- FAILED ENGINE - WINDMILLING OR SEIZED
- C.G. AT 25%MAC
- INCREASE MAX WEIGHT BY 250 LB FOR EACH 1% THE C.G. IS AFT OF 25%MAC
- DECREASE MAX WEIGHT BY 250 LB FOR EACH 1% THE C.G. IS FWD OF 25%MAC
- GREATER WOD PROVIDES IMPROVED WAVEOFF PERFORMANCE
- ADJUSTING GROSS WEIGHT AT OR BELOW THE RECOMMENDED WEIGHT ENSURES LESS THAN 50 FEET ALTITUDE LOST DURING AN ONSPEED AOA SINGLE ENGINE MILITARY POWER WAVEOFF FROM AN ONSPEED AOA/ON GLIDESLOPE CONDITION. MAXIMUM WAVEOFF ALTITUDE LOST FOR TWO ENGINE OPERATION UNDER IDENTICAL CONDITIONS IS LESS THAN 30 FEET

ADA520_339-1-37

Figure 16-2. Recommended Maximum Single Engine Recovery Weight

CAUTION

Starting the APU airborne may result in a BALD shutdown due to ingestion of exhaust gases into the APU ducting.

4. Fly a straight-in approach.
5. Plan approach to make turns using shallow bank angle ($\leq 15^\circ$).
6. Do not exceed on-speed AOA in turns.
7. Avoid turns into inoperative engine.

LEFT ENGINE FAILED -

1. FLAP switch - HALF
2. LDG GEAR handle - DN
3. Make a normal landing or a precautionary short field arrested landing (if practical).

RIGHT ENGINE FAILED -

1. FLAP switch - HALF
2. Execute Landing Gear Emergency Extension procedure.

If short field arresting gear available -

3. Make an arrested landing.

If short field arresting gear NOT available and right engine crossbleed NOT desired/required -

3. EMERG BRK handle - VERIFY PULLED TO DETENT (anti-skid is not available)
4. Make a normal landing.
5. Consider paddle switch - PRESS after touchdown to preserve APU ACCUM pressure for braking and slow speed NWS.
6. Use emergency brakes with steady brake pressure (DO NOT PUMP). Anti-skid is not available.

Once stopped on runway -

7. Do not taxi (even if HYD 2A caution is removed).

If short field arresting gear NOT available and right engine crossbleed IS desired/required -**If APU ACCUM caution light on (i.e., landing gear emergency extended) -**

3. Recharge the APU accumulator.
 - a. Left throttle - ADVANCE to 85 % rpm minimum
 - b. ENG CRANK switch - R

When HYD 2 pressure restored -

- c. HYD ISOL switch - ORIDE (until 10 seconds after APU ACCUM caution removed - approximately 20 seconds total)
- d. ENG CRANK switch - OFF

With APU ACCUM caution off -

- 4. APU switch - ON (READY light on within 30 seconds)
- 5. ENG CRANK switch - R

When HYD 2 pressure restored -

- 6. HYD ISOL switch - ORIDE (until 10 seconds after APU ACCUM caution removed - approximately 40 seconds total)
- 7. EMERG BRK handle - VERIFY RESET
- 8. Make a normal landing using normal brakes with anti-skid.

Once stopped on runway -

- 9. Do not taxi (even if HYD 2A caution is removed).

16.4 FORCED LANDING

Landing on an unprepared surface or with both engines failed is not recommended. If an engine cannot be restarted or if a suitable landing site is not available, eject.

16.5 PLANING LINK FAILURE

A planing link failure is indicated by a gear handle light, continuous rate beeping tone, and a flashing LEFT or RIGHT advisory light with the gear handle down. With no braking on landing rollout, a planing link failure will normally cause the aircraft to drift into the failed gear as the aircraft decelerates. However, the failure can result in landing gear positions that can range from slightly angled to fully perpendicular to the aircraft. The resulting swerve in the direction of the failure can be severe. Planing link failure indications that are momentary or disappear after initial activation may be indicative of an actual planing link failure.

WARNING

- A planing link failure may cause a sudden swerve on touchdown in the direction of the failed gear.
- Planing link failure may not be annunciated until after touchdown and may provide little to no pilot reaction time between initial annunciation and a violent yaw/swerve. Therefore, if flyaway airspeed is available, pilots should be prepared to make the decision to execute a go around immediately at initial planing link failure annunciation.

CAUTION

Planing link failure indications that are momentary or disappear after initial activation may be indicative of an actual planing link failure.

If detected after touchdown and flyaway airspeed available -

- *1. Go Around.

If flyaway airspeed not available -

- *1. Select emergency brakes (if appropriate).
- *2. HOOK handle - DOWN (if required)

If detected airborne, or following go around -

1. LDG GEAR handle - DO NOT CYCLE
2. ANTI SKID switch - OFF

If arresting gear available -

3. Make a fly-in short field arrestment with LSO assistance (if available).

If arresting gear not available -

3. Make a minimum sink rate landing.
4. Consider touchdown on good gear side of runway.
5. Avoid braking until as slow as practical or until needed to prevent loss of directional control.
6. Brake using the good gear and maintain directional control with NWS.

7. Use symmetrical braking only if necessary to avoid departing the runway.

WARNING

- Use of symmetrical wheel brakes with a planing link failure may cause a sudden swerve in the direction of the failed gear.
- The ability to maintain directional control with rudder will rapidly decrease as the aircraft decelerates on rollout.
- Lateral asymmetry via heavier or larger stores on the side of the failed gear may aggravate the severity of yaw/swerve in the direction of the failed gear.

8. Do not taxi once stopped.

16.6 LANDING GEAR UNSAFE/FAILS TO EXTEND

If the LEFT or RIGHT landing gear position indicator is flashing, and the landing gear warning light and warning tone are on, refer to PLANING LINK FAILURE.

If the landing gear warning light and warning tone are out -

1. AOA indexer lights - CONFIRM ON
2. INTR LT MODE switch - CHECK DAY
3. Landing gear position lights - CHECK FLUSH
4. LT TEST switch - TEST

If bulb(s) test bad and AOA indexer lights on -

5. It is safe to assume the landing gear is down and locked.
6. Get a visual inspection (if practical).
 - The approach lights should be illuminated if the landing gear is down and locked.
7. Landing gear may be raised as necessary to conserve fuel.
8. Make a normal landing.

If the landing gear warning light and warning tone are on -

1. AOA indexer lights - CONFIRM OUT
2. LT TEST switch - TEST
 - Verify that all 3 position lights and the landing gear warning light are on.
3. LDG GEAR handle - CHECK FULL DN (DO NOT CYCLE)
4. LG circuit breaker - CHECK IN

5. Get a visual inspection (if practical).
 - If one or more landing gear indicates unsafe, a visual inspection can only confirm general position and obvious damage.
 - There is no external indication of a locked landing gear.

Perform the following in order until 3 down and locked -

6. LG circuit breaker - CYCLE
7. Perform Landing Gear Emergency Extension procedure.
8. Perform positive and negative g maneuvers and gently roll and yaw aircraft to obtain safe gear indication.

If HYD 2A is operative and any gear still unsafe -

9. LDG GEAR handle - PUSH IN then ROTATE 90° CCW
10. LDG GEAR handle - UP (DOWNLOCK ORIDE if required)
11. If all gear up and locked, consider selective jettison of unwanted stores.
 - Selective jettison can only be performed with LDG GEAR handle UP and all landing gear up and locked.
12. LDG GEAR handle - DN
13. Perform Landing Gear Emergency Extension procedure.
14. Perform positive and negative g maneuvers and gently roll and yaw aircraft to attempt to drive the unsafe gear down and locked.

If any gear still indicates unsafe -

15. Refer to Landing Gear Malfunction - Landing Guide chart.

If at any time landing gear indicates three down and locked -

16. LDG GEAR handle - DO NOT CYCLE
17. Make minimum sink rate short field arrested landing (if available).
18. Pin the landing gear after landing.

16.7 LANDING GEAR EMERGENCY EXTENSION

1. Consider selective jettison of unwanted stores.
 - Selective jettison can only be performed with LDG GEAR handle UP and all landing gear up and locked.
2. FLAP switch - HALF or FULL
3. Slow below 160 KCAS if practical.
4. LDG GEAR handle - DN

If LDG GEAR handle cannot be moved to the DN position -

5. LG circuit breaker - PULL

With LDG GEAR handle DN or UP (DN preferred) -

6. LDG GEAR handle - ROTATE 90° CLOCKWISE then PULL TO DETENT
7. Verify three down and locked.
8. Make a short field arrestment (if practical).



On aircraft 161353 THRU 162477, if the landing gear is lowered by the emergency method with the gear handle up, the gear handle may move enough to cause gear retraction without deliberate pilot action unless the landing gear circuit breaker is pulled.

NOTE

- If the landing gear was emergency extended with the LDG GEAR handle in the UP position, the landing gear warning light remains on with the gear down and locked.
- The rear cockpit landing gear UNSAFE light illuminates with the circuit breaker pulled and the condition is normal.

9. EMERG BRK handle - PULL TO DETENT (Anti-skid is not available).



If the forward priority valve is failed, normal gear extension and normal braking will be inoperative. If emergency gear extension was required to achieve three down and locked with a good HYD 2A system, emergency brakes should be selected prior to landing as failure of normal braking is anticipated.

If HYD 2B is operative -

10. HYD ISOL switch - ORIDE (until 10 seconds after APU ACCUM caution removed - approximately 30 seconds total) by the emergency method with the gear handle up. The red light in the gear handle remains on with the gear down and locked.

CAUTION

On aircraft 161353 THRU 162477, if the landing gear is lowered by the emergency method with the gear handle up, the gear handle may move enough to cause gear retraction without deliberate pilot action unless the landing gear circuit breaker is pulled.

NOTE

The rear cockpit landing gear UNSAFE light illuminates with the circuit breaker pulled and the condition is normal.

11. Make a Short Field Arrestment (if practical).

If arrested landing not practical, after landing -

12. Use emergency brakes.

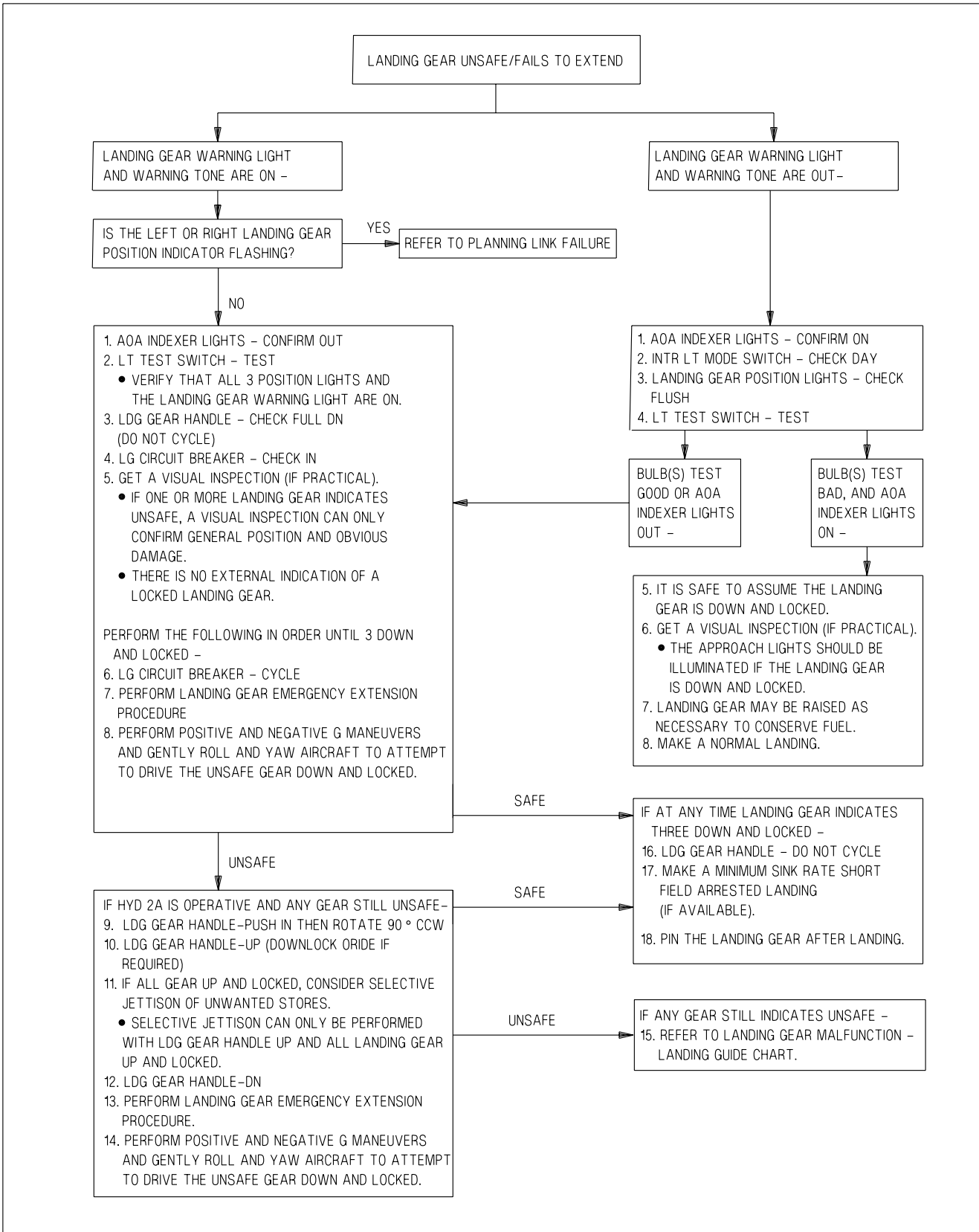

ADA520-328-1-058

Figure 16-3. Landing Gear Emergency Flow Chart





V-16-12

ORIGINAL

CARRIER LANDING

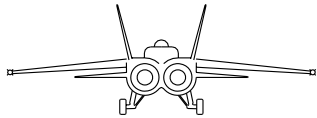
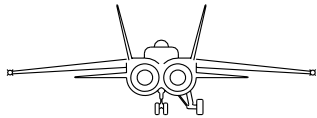
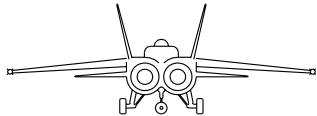
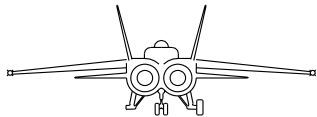
- ANY GEAR NOT LOCKED DOWN SHALL BE TREATED AS THOUGH IT WERE UP.
- IF ALL GEAR UNLOCKED, RETRACT GEAR AND REFER TO ALL GEAR UP.

- WITH PLANING LINK FAILURE, DO NOT CYCLE GEAR. MAKE NORMAL ARRESTMENT.
- OBTAIN VISUAL INSPECTION FOR ALL LANDING GEAR EMERGENCIES IF POSSIBLE.

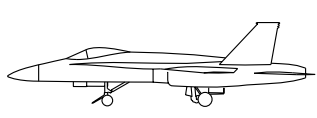
LANDING GEAR CONFIGURATION		ACTION	NOTES
	NOSE GEAR RETRACTED STUB OR TRAILING	DIVERT OR BARRICADE	1,2,3
	ONE MAIN GEAR RETRACTED OR TRAILING	DIVERT OR BARRICADE	1,2,4
	COCKED NOSE GEAR AND/OR ONE OR BOTH COCKED MAIN GEAR	NORMAL LANDING	2
	ONE OR BOTH MAIN GEAR STUB	DIVERT OR BARRICADE	1,2,3
	NOSE GEAR AND ONE MAIN GEAR RETRACTED OR TRAILING	RETRACT ALL GEAR. IF UNABLE TO RETRACT, EJECT.	
	BOTH MAIN GEAR RETRACTED OR TRAILING	DIVERT OR BARRICADE	1,2,4
	ALL GEAR UP	DIVERT OR BARRICADE WITH TANKS INSTALLED ONLY OR EJECT.	1,2,4
	LAUNCH BAR DOWN OR RED LAUNCH BAR LIGHT ILLUMINATED	DIVERT OR REMOVE CDP'S 1 AND 4 AND MAKE NORMAL LANDING.	







NOTES

1. CONSIDER EMERGENCY JETTISON OF ALL EXTERNAL ORDNANCE.
2. RETAIN AND DEPRESSURIZE EMPTY EXTERNAL FUEL TANKS (IF PRACTICAL).
3. HOOK DOWN BARRICADE ENGAGEMENT WITHOUT CROSS DECK PENDANTS.
4. HOOK DOWN BARRICADE ENGAGEMENT WITH CROSS DECK PENDANTS.

Figure 16-4. Landing Gear Malfunction – Landing Guide (Sheet 1 of 2)

FIELD LANDING

- ANY GEAR NOT LOCKED DOWN SHALL BE TREATED AS THOUGH IT WERE UP.
- IF ALL GEAR UNLOCKED, RETRACT GEAR AND REFER TO ALL GEAR UP.
- WITH PLANING LINK FAILURE, DO NOT CYCLE GEAR, MAKE FLY-IN ARRESTMENT.
- OBTAIN VISUAL INSPECTION FOR ALL LANDING GEAR EMERGENCIES IF POSSIBLE.
- FOR ALL EMERGENCIES, REQUEST LSO ASSISTANCE IF AVAILABLE.

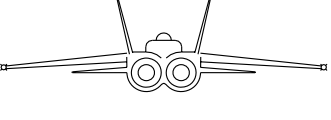
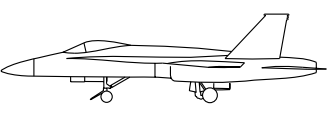
LANDING GEAR CONFIGURATION		ARRESTING GEAR		NO ARRESTING GEAR	
		ACTION	NOTES	ACTION	NOTES
	NOSE GEAR RETRACTED STUB OR TRAILING	NO ARRESTED LANDING REMOVE CDP	1,2,3, 4,5	LAND	1,2,3, 4,5
	ONE MAIN GEAR RETRACTED OR TRAILING	MAKE ARRESTED LANDING	1,2,3, 6	LAND	1,2,3, 7,8,9, 10
	COCKED NOSE GEAR AND/OR ONE OR BOTH COCKED MAIN GEAR	MAKE ARRESTED LANDING	2	LAND	2
	ONE OR BOTH MAIN GEAR STUB	NO ARRESTED LANDING REMOVE CDP	1,2,3, 7,8,9, 10	LAND	1,2,3, 7,8,9, 10
	NOSE GEAR AND ONE MAIN GEAR RETRACTED OR TRAILING	RETRACT ALL GEAR. IF UNABLE TO RETRACT, EJECT		RETRACT ALL GEAR. IF UNABLE TO RETRACT, EJECT	
	BOTH MAIN GEAR RETRACTED OR TRAILING	MAKE ARRESTED LANDING	1,2,5, 9	LAND	1,2,5, 9
	ALL GEAR UP	NO ARRESTED LANDING REMOVE CDP	1,2,5, 9	LAND	1,2,5, 9
	LAUNCH BAR DOWN OR RED LAUNCH BAR LIGHT ILLUMINATED	NO ARRESTED LANDING REMOVE CDP		LAND	

NOTES

1. CONSIDER EMERGENCY JETTISON OF ALL EXTERNAL ORDNANCE.
2. RETAIN AND DEPRESSURIZE EMPTY EXTERNAL FUEL TANKS (IF PRACTICAL).
3. MINIMUM DESCENT RATE LANDING.
4. LOWER NOSE GENTLY BEFORE FALL THROUGH.
5. SECURE ENGINES IF ANY GEAR RETRACTS OR COLLAPSES ON TOUCHDOWN.
6. HOLD MISSING DAMAGED GEAR OFF DECK UNTIL ENGAGEMENT.
7. ANTI-SKID OFF.
8. LAND ON SIDE OF RUNWAY TOWARD GOOD GEAR.
9. HOLD WINGS LEVEL AS LONG AS POSSIBLE.
10. USE NOSEWHEEL STEERING AND GOOD BRAKE TO MAINTAIN TRACK.

ADA520-66-2-056

Figure 16-4. Landing Gear Malfunction – Landing Guide (Sheet 2 of 2)

16.8 HOOK FAILS TO EXTEND

If hook will not extend -

1. Hook circuit breaker - PULL

If hook still will not extend - CV -

2. Divert.

If arrested landing required -

2. Shut down right engine, restart for landing.

NOTE

Shutting down right engine to reduce HYD 2 backpressure may allow partial arresting hook extension. Restart engine for landing. Arresting hook may retract at a maximum rate of 2°/minute.

16.9 LANDING WITH AFT CG

If the CG has moved aft of the aft CG limit, land as soon as practical. Delay in landing causes the CG to move further aft as fuel is burned. If any fuel remains in the centerline fuel tank, consider inhibiting transfer which, with a full tank, keeps the CG approximately 2.5 % further forward than with an empty tank. Maintain airspeed below Mach 0.7 and AOA less than 10° to minimize problems with longitudinal controllability and sensitivity. Jettison of external stores/tanks is normally not required. However, if controllability problems are encountered, jettison external wing stores/tanks first followed by the centerline store/tank. Avoid the use of abrupt longitudinal control inputs. Use a smooth control technique when making attitude/angle of attack corrections. Precise control of the touchdown point may have to be sacrificed to avoid a longitudinal PIO.

If CG aft of aft CG limit -

1. Maintain airspeed below Mach 0.7 and AOA less than 10°.
2. EMERG JETT button - PUSH (if required)

If stores cannot be jettisoned or CG still aft of 28.0% MAC -

3. Fly straight-in on-speed approach.
4. Minimize longitudinal stick motion which can result in a PIO.
5. Cushion the landing with thrust if necessary.

16.10 AUTO FLAP LANDING

1. Do not exceed 10° AOA.
2. Do not slow below 154 knots.

16.11 FIELD ARRESTMENT

16.11.1 Field Arresting Gear. Field arresting gear includes anchor chain, water squeezer, and Morest types. All require engagement of the arresting hook in a crossdeck pendant cable rigged across the runway. Location of the pendant further identifies the gear type as follows:

SHORT FIELD - Located 1,500 to 2,000 feet past approach end of runway. Usually requires request to rig.

MIDFIELD - Located near halfway point of runway. Usually requires request to rig for desired direction.

ABORT - Located 1,500 to 2,000 feet short of departure end of runway. Usually rigged for immediate use.

OVERRUN - Located shortly past departure end of runway. Usually rigged for immediate use.

A field may have all, none, or any combination of types. The pilot must know the type, location, and compatibility with your aircraft of the installed gear, and the local policy for rigging installed gear.



An engagement in the wrong direction into chain gear severely damages the aircraft.

Determine the conditions of an emergency by all means available (instruments, other aircraft, LSO, RDO, tower or other ground personnel). If fuel is streaming, a field arrested landing is not recommended due to the high probability of sparks and heat from the hook igniting the streaming fuel. Determine the best available arresting gear and the type of arrestment. Notify control tower as far in advance as possible and give estimated time to landing in minutes. Unrigged gear probably requires 10 to 20 minutes to rig. If conditions allow, make practice passes to accurately locate arresting gear. Lock shoulder harness.

Engage arresting gear on the centerline, in three-point attitude, as slow as practical, and with feet off brakes. After arrestment, common sense and conditions determine whether to keep engines running or to shut down the engines and evacuate the aircraft.

16.11.2 Short Field Arrestment. If there is a directional control problem, an anticipated stopping problem, or a minimum rollout is desired, make a short field arrestment. Request LSO assistance. The LSO should be near the touchdown point with a radio. Inform the LSO of the desired touchdown point. Lower the hook before starting approach and get a positive hook down check. Determine maximum engagement speed at landing gross weight (see figure 16-5). Approach speed depends on the emergency. A constant glide slope approach to touchdown is allowed (mirror or fresnel lens if available). Maintain approach power until arrestment is assured or waveoff is started. Touchdown on centerline at or just before arresting wire. Prepare for waveoff if wire is missed. After engagement, retard throttles to IDLE. Secure engines and evacuate aircraft if required.

16.11.3 Long Field Arrestment. Make a long field arrestment when there is a stopping problem (aborted takeoff, wet or icy runway, loss of brakes, etc.) and it is not possible to go around and make a short field arrestment. If a long field arrestment is selected due to an emergency which causes an approach speed so fast that it exceeds the approach-end arresting gear limits, be prepared for main

gear tire failure above 210 knots and nose gear tire failure above 190 knots. Lower the hook in time for it to fully extend before engagement (normally 1,000 feet before arresting gear). Line up on runway centerline. Tell control tower of your intention to engage arresting gear so that aircraft landing behind you are waved off. Do not delay a decision to go around based solely on the availability of long field gear.

CAUTION

After engagement into E-28 or BAK-13 arresting systems, when aircraft speed has been reduced to approximately 20 knots, braking should be applied to stop the forward motion of the aircraft. This prevents an aircraft with idle power from slowly pulling the gear through to a two-block position, and quickly allows the runway to be cleared for other operations. However, in the event of a two-block into any system except E-5, engine thrust should judiciously be applied at the end of the arrestment to minimize aircraft walkback. The aircraft brakes should not be applied during walkback. Some walkback is necessary to clear the deck pendant from the arresting hook; however, the application of excessive power in controlling walkback increases the possibility of deck-pendant hang-up in the arresting hook point.

16.12 FIELD ARRESTMENT GEAR DATA

Maximum engaging speeds, gross weights, and off-center distances are shown in the Field Arrestment Gear Data chart, figure 16-5. The applicable Aircraft Recovery Bulletin contains more detailed information.

16.13 BARRICADE ARRESTMENT

If a barricade arrestment is required, the LSOs will give a detailed briefing of barricade procedures.

1. Burn down or dump fuel as required to obtain the lowest gross weight feasible.
2. External ordnance - JETTISON
3. External fuel tanks - JETTISON EXCEPT AS NOTED IN LANDING GEAR MALFUNCTION - LANDING GUIDE - CARRIER LANDING

NOTE

Barricade engagement with installed AIM-7, AIM-120 and/or AIM-9 missiles is not recommended. AIM-7 and AIM-120 missiles may separate and AIM-9 missiles will probably separate from the aircraft. Inability to jettison/fire these missiles does not preclude successful barricade engagement. Barricade may be engaged with empty external tanks if tanks cannot be jettisoned. When live ordnance cannot be jettisoned, barricade engagement should only be attempted with all landing gear down.

4. Fly an on-speed, on-glideslope, on-centerline approach with zero drift all the way to touchdown.

When "Cut-Cut" called by LSOs -

5. Throttles - OFF

When aircraft motion ceases -

6. EGRESS

ARRESTING GEAR	AIRCRAFT GROSS WEIGHT/1000 POUNDS										MAXIMUM OFF-CENTER ENGAGEMENT (FEET)
	ALL FIELD LANDINGS (J)(K)			ALL FIELD LANDINGS (L)			ABORTED TAKEOFF (A)				
	28	30	33	34	36	39	40	44	48	51.9	
	MAXIMUM ENGAGING SPEED (KNOTS GROUND SPEED)										
E-28	175 (B)	175 (B)	175 (B)	175 (B)	175 (B)	175 (B)	175 (B)	175 (B)	175 (B)	175 (B)	40
E-28 (C)	170 (B)	170 (B)	170 (B)	170 (B)	170 (B)	170 (B)	170 (B)	170 (B)	170 (B)	160 (B)	40
M-21	150	150	150	145	145	145	135	135	135	135	10
M-31	157	157	157	120	120	120	135	135	135	135	10
BAK-9	160	160	160	160	160	160	160	160	160	156	30
BAK-12 (G)	160	160	160	160	160	160	160	160	159	146	50
DUAL BAK-12 (H)	152 (B)	152 (B)	152 (B)	152 (B)	152 (B)	152 (B)	152 (B)	152 (B)	152 (B)	152 (B)	30
BAK-13	160	160	160	160	160	160	160	160	160	160	40

NOTE

- (A) Data provided in aborted takeoff column may be used for emergency high gross weight arrestment.
- (B) Maximum engaging speed limited by aircraft limit horizontal-drag load factor (mass item limit g).
- (C) Only for the E-28 systems at Keflavik and Bermuda with 920 foot tapes.
- (D) Maximum engaging speed limited by arresting gear capacity, except where noted.
- (E) Off center engagement into an E-5 system may not exceed 25 % of the runway span.
- (F) Before making an E-5 system arrestment, the pilot must check with the air station to confirm the maximum engaging speed because of a possible installation with less than minimum required rated chain length. Chain length ratings are referenced in Flight Information Publication (IFR-SUPPLEMENT).
- (G) Standard BAK-12 limits are based on 150-foot span, 1-inch cross deck pendant, 40,000 pound weight setting, and 950 foot runout. No information available regarding applicability to other configurations.
- (H) Dual BAK-12 limits are based on 150 to 300-foot span, 1.25 inch cross deck pendant, 50,000 pound weight setting, and 1,200 foot runout. No information available regarding applicability to other configurations.
- (J) Maximum of 3.0° glide slope.
- (K) Consult appropriate NATOPS section for recommended approach speed.
- (L) Flared or minimum rate of descent landing.
- (M) The E-5 system data provided for long-field landing may be used for lightweight takeoff.

Figure 16-5. Field Arrestment Gear Data (Sheet 1 of 2)

FOR E-5 EMERGENCY ARRESTING GEAR												
AIRCRAFT F/A-18A/B/C/D												
ARRESTING GEAR RATING (F)	ALL FIELD LANDINGS (J) UP TO 33,000 POUNDS (K)				ALL FIELD LANDINGS (L) UP TO 39,000 POUNDS				ABORTED TAKEOFF (M) 39,100 - 51,900 POUNDS (A)			
	STANDARD CHAIN		HEAVY CHAIN		STANDARD CHAIN		HEAVY CHAIN		STANDARD CHAIN		HEAVY CHAIN	
	E-5 E-5-2	E-5-1 E-5-3	E-5 E-5-2	E-5-1 E-5-3	E-5 E-5-2	E-5-1 E-5-3	E-5 E-5-2	E-5-1 E-5-3	E-5 E-5-2	E-5-1 E-5-3	E-5 E-5-2	E-5-1 E-5-3
FEET OF CHAIN		MAXIMUM ENGAGING SPEED										
300-349	51	51	50	50	46	46	46	46	40	40	40	40
350-399	58	58	59	59	53	53	55	55	46	46	47	47
400-449	65	65	68	68	60	60	63	63	52	52	55	55
450-499	72	72	77	77	66	66	71	71	58	58	62	62
500-549	79	79	87	87	73	73	80	80	64	64	70	70
550-599	86	86	96	96	80	80	89	89	70	70	77	77
600-649	93	93	106	106	86	86	98	98	76	76	85	85
650-699	100	100	116	116	93	93	107	107	82	82	93	93
700-749	107	107	126	126	100	100	116	116	88	88	101	101
750-799	114	114	136	136	106	106	125	125	94	94	109	109
800-849	121	121	146	146	113	113	135	135	100	100	117	117
850-899	128	128	150	156	119	119	144	144	106	106	126	126
900-949	134	134	150	165	126	126	150	154	112	112	134	134
950-999	141	141	150	165	133	133	150	163	118	118	142	142
1000-1049	148	148	150	165	139	139	150	165	125	125	150	151
1050-1099	150	155	150	165	146	146	150	165	131	131	150	159
1100	150	161	150	165	150	152	150	165	137	137	150	165

NOTE

Maximum engaging speed limited by arresting gear capacity.
Off center engagement into an E-5 system may not exceed 25 %
of the runway span.

Figure 16-5. Field Arrestment Gear Data (Sheet 2 of 2)

Malfunction	Pages -000/-500	Divert	Pull Fwd	Next Avail	Normal	Notes
ENGINES						
BLEED Warning	V-12-3/ E66		X			1, 2, 5, 10
Engine Fire	V-15-1/ E68		X			1, 2, 5, 10
Stuck Throttle	V-15-2/ E9		X			1, 2, 5, 10, 13
Single Engine	V-16-1/ E41			X		1, 2, 5, 10
Engine Stall	V-15-4/ E99			X		1, 2, 5, 10
AMAD Caution	V-15-26/ E73			X		6
AMAD PR Caution	V-15-26/ E74			X		2, 5
ATS Caution	V-12-9/ E77			X		
Dual BLD OFF Cautions (Both BLEED Warn Lights Out)	V-12-11/ E80			X		11
BOOST LO Caution	V-12-12/ E81			X		6, 10
IN TEMP Caution	V-12-19/ E92			X		
OIL PR Caution	V-12-23/ E98			X		1, 2, 5, 10
FUEL						
Fuselage Fuel Leak	V-15-15/ E5		X			3
DUMP OPEN Caution	V-12-14/ E85		X			3
FUEL LO Caution	V-12-17/ E89		X			3
Internal Fuel Transfer Failure	V-15-16/ E6			X		3
CG or FUEL XFER Caution	V-12-17/ E89			X		3
HYDRAULIC						
Triple HYD Circuit Cautions	V-12-42/ E129	X				3, 5
HYD 1A/2B Circuit Cautions	V-12-38/ E122	X				1, 2, 8
All Other Dual HYD Circuit Cautions	V-12-36/ E120			X		1, 2, 5, 10
Single HYD Circuit Caution	V-12-34/ E117			X		2, 5
APU ACCUM Caution	V-12-8/ E75			X		2
BRK ACCUM Caution	V-12-12/ E81			X		2
ELECTRICAL						
AV AIR HOT Caution	V-12-10/ E78		X			
Dual GEN Cautions	V-15-19/ E48		X			2, 4, 5, 7, 9, 11
Single GEN Caution	V-12-17/ E87			X		
Dual T/R Failure	V-15-19/ E48			X		2, 5, 11
ADC Failure	V-15-34 -/ -			X		
CAUT DEGD Caution	V-12-13/ E83			X		
E/U BATT LO Caution	V-12-10/ E79			X		
FCS						
Aileron Surface Missing/Damaged	V-15-52/ E10	X				
MECH ON Caution	V-12-31,V-15-56/ E109	X				7, 9
FCS HOT Caution	V-12-29/ E106		X			
AIL or RUD OFF Caution	V-12-27/33/ E102/E111			X		7, 9
DEL ON Caution	V-12-27,V-15-49/ E103			X		7, 9
FC AIR DAT Caution	V-12-28/ E104			X		
FCES Caution	V-12-29/ E105			X		
FLAPS OFF Caution	V-12-30,V-15-57/ E107			X		7, 8
FLAP SCHED Caution	V-12-31,V-15-59/ E108			X		
MISCELLANEOUS						
Blown Tire	V-14-3/ E26			X		2
L BAR Warning	V-12-6/ E70			X		2, Remove CDP 1 and 4
Landing Gear Failure	V-16-12/ E29			X		2, Refer to Figure 16-4. Landing Gear malfunction-Landing Guide
Planing Link Failure	V-16-6/ E24			X		2
OBOGS DEGD Caution	V-15-28/ E97			X		
SDC Failure	I-2-112/-/ -			X		
Birdstrike	V-15-45/-/ -					12
NOTES :						
1. Aircraft will be flying a half flap straight-in. Approach speed will be higher, therefore wind over the deck requirements will increase. Consult applicable ARB for details. Possibility of malfunction affecting other engine. Ensure all possible effort is made to recover the aircraft immediately.						
2. Aircraft may require a tow out of the landing area.						
3. Immediate tanking required if any delay in recovery exists.						
4. Pilot will be unable to fold wings upon landing.						
5. For any HYD 2A caution, dual T/R failure, or dual GEN failure, landing gear will be emergency extended and aircraft will be committed to a dirty bingo if unable to recover. Consider bingo options before extending landing gear.						
6. Problem could be symptomatic of a fuel leak. If so, immediate recovery is required.						
7. Fly half flap approach. Handling characteristics are severely degraded.						
8. If LEF > 10°, recover next available recovery. If LEF < 10° or TEF at 0°, excessive airspeed and/or AOA may require divert.						
9. If ailerons and rudder are inoperative, aircraft must divert, or eject.						
10. Consideration should be given to aircraft configuration and outside air temperature prior to recovery. In hot weather, divert should be first option due to poor hot weather single engine wave off capability.						
11. Unable to transfer external fuel. Consider divert or jettison of external tanks.						
12. Decision for Pull Fwd or Next Avail recovery determined by nature of damage sustained during birdstrike. Refer to appropriate emergency on recovery matrix.						
13. If engine secured successfully, utilize Next Avail recovery.						

Figure 16-6. CV Recovery Matrix
V-16-21 (Reverse Blank)

ORIGINAL

CHAPTER 17

Ejection

17.1 EJECTION

The ejection seat must be used to escape from the aircraft in flight. If the canopy fails to jettison, the seat will eject through the canopy. Analysis of ejections shows:

1. Optimum speed for ejection is 250 knots and below.
2. Between 250 and 600 knots, appreciable forces are exerted on the body, making ejection more hazardous.
3. Above 600 knots, excessive forces are exerted on the body making ejection extremely hazardous.

When possible, slow the aircraft before ejection to reduce the forces on the body.

Never actuate the manual override handle before ejection. When the handle is actuated, the arm/safe handle is rotated to the safe position, the pilot is released from the seat, and the harness cannot be reconnected. Ejection is impossible and there is no restraint during a forced landing.

Whenever possible, ejection airspeed should be limited to a maximum of 400 KCAS when flying with the JHMCS helmet system.

WARNING

The JHMCS configuration can contribute to increased neck loads during ejection, particularly at moderate to high speeds. Generally, neck loads increase as ejection airspeeds increase and may cause severe or fatal injury. Aircrews should eject at the lowest possible airspeed to minimize neck and injury loads.

NOTE

Aircrew will brief system peculiarities and potential injury from out of position and high speed ejections prior to each flight when using A/A24A-56 JHMCS lightweight HGU-55 A/P helmet.

WARNING

If the seat becomes unlocked from the catapult and slides partially up the rails or completely out of the cockpit, ejection and/or chute deployment is still possible but the ejection handle must be pulled, followed by activation of the manual override handle. Under these circumstances low altitude ejection capabilities are compromised.

During ejection seat development and testing, the following seats were qualified for the respective minimum and maximum nude weight ranges for aviators listed here: SJU-5/A, 6/A, and SJU-17(V) 1/A, 2/A, and 9/A seats - 136 lb to 213 lb. SJU-17A(V) 1/A, 2/A, and 9/A seats - 136 lb to 245 lb.

WARNING

- Operation of the ejection seat by personnel weighing less than the qualified minimum nude weight or more than the maximum qualified weight (noted above) subjects the occupant to increased risk of injury.
- Aircrew should be trained in additional ejection risks associated with JHMCS. Ejection with JHMCS may cause severe or fatal injury.

17.1.1 General Injury Risks.

1. Ejection seat stability is directly related to occupant restraint. All occupants should be properly restrained in the seat by their torso harness for optimum performance and minimum injury risk.
2. Inertia reel performance may be degraded for occupants outside of the qualified weight range. Lighter occupants may be injured during retraction, and both light and heavy occupants may experience poor ejection positions, resulting in an increased risk of injury during ejection.

WARNING

An increased risk of severe injury or death during Parachute Landing Fall (PLF) exists with surface winds exceeding 25 knots. High surface winds contribute directly to total landing velocity. When time permits, select parachute steering and turn into the wind to reduce landing velocity.

17.1.2 Injury Risks For Lighter Weight Crewmembers.

1. The ejection seat catapult was designed for the ejection seat qualified weight range.
2. For SJU-5/A and 6/A seats only:
 - a. Occupants weighing less than 136 pounds are subject to a higher risk of injury on the ejection seat catapult due to greater accelerations.
 - b. Occupants weighing less than 136 pounds are at risk of parachute entanglement at low speeds.
 - c. Occupants weighing less than 136 pounds are at greater risk of injury due to seat instability before main parachute deployment.

3. For SJU-17(V)1/A, 2/A, and 9/A seats only:
 - a. Occupants weighing less than 136 pounds are subject to a higher risk of injury on the ejection seat catapult due to greater accelerations.
 - b. Occupants weighing less than 136 pounds are at risk of injury during ejections near the upper end of mode 1 (approaching 300 knots) due to high parachute opening shock.
 - c. Occupants weighing less than 136 pounds are at greater risk of injury during ejections above 300 knots due to instability during drogue deployment.
4. For SJU-17A(V)1/A, 2/A, and 9/A seats only:
 - a. Occupants weighing less than 100 pounds are subject to a higher risk of injury on the ejection seat catapult due to greater accelerations.
 - b. Occupants weighing less than 136 pounds are at risk of injury during ejections near the upper end of mode 1 (approaching 300 knots) due to high parachute opening shock.
 - c. Occupants weighing less than 136 pounds are at greater risk of injury during ejections above 300 knots due to seat instability during drogue deployment.

WARNING

Lighter weight aircrew have greater risk of neck injury during ejection while using the JHMCS configuration. Minimum nude aircrew weights authorized to fly with the JHMCS helmet system is 136 pounds. Aircrew weighing less than the authorized minimum nude weight are restricted from flying with the JHMCS helmet system.

17.1.3 Injury Risks For Heavier Weight Crewmembers.

1. For SJU-5/A and 6/A and SJU-17(V)1/A, 2/A, and 9/A seats only:
 - a. Occupants weighing more than 213 pounds may not attain sufficient altitude for parachute full inflation in Zero-Zero cases or at extremely low altitudes and velocities.
 - b. Occupants weighing more than 213 pounds are at a greater risk of injury during parachute landing due to high descent rates.
 - c. Occupants weighing more than 213 pounds may not attain sufficient altitude to clear the aircraft tail structure.
2. For SJU-17A(V)1/A, 2/A, and 9/A seats only:
 - a. Occupants weighing more than 245 pounds may not attain sufficient altitude for parachute full inflation in Zero-Zero cases or at extremely low altitudes and velocities.
 - b. Occupants weighing more than 245 pounds are at a greater risk of injury during parachute landing due to high descent rates.
 - c. Occupants weighing more than 245 pounds may not attain sufficient altitude to clear the aircraft tail structure.

17.1.4 Low Altitude Ejection. Low altitude ejection decisions must be based on the minimum speed, minimum altitude and sink rate limitations of the ejection system. Figure 17-1 shows minimum ejection altitude for a given sink rate. Figure 17-2 shows minimum ejection altitude for a given airspeed, dive angle and bank angle. Ejection seat trajectory is improved if the aircraft is zoomed. The additional altitude increases time available for seat separation and parachute deployment. Do not delay ejection if the aircraft is nose down and cannot be leveled.

With wings level and no sink rate, ejection is feasible within the following parameters:

1. Ground level - zero airspeed

WARNING

Safe ejection with SJU-5/A and 6/A seats may not be possible in a zero-zero condition if there is a tailwind component on the aircraft.

2. Ground to 50,000 feet - 600 knots maximum.

Ejection at low altitude allows only a matter of seconds to prepare for landing. Over water, inflation of the LPU is the most important step to be accomplished. Release of the parachute quick-release fittings as the feet contact the water is the second most important step to prevent entanglement in the parachute shroud lines.

When ejection is in the immediate vicinity of the carrier, parachute entanglement combined with wake and associated turbulence can rapidly pull a survivor under. The deployed seat survival kit may contribute to shroud line entanglement. The survivor must be prepared to cut shroud lines that are dragging him down.

The crashed aircraft may release large quantities of jet fuel and fumes which could hamper breathing and create a fire hazard if smoke or flare marker is present. The emergency oxygen system may be invaluable in this case and discarding the survival kit would terminate its use. However, totally discarding the survival kit may be appropriate after considering weather, sea conditions, and rescue potential.

The variety and complexity of conditions encountered during the time critical actions following a low altitude overwater ejection make it impossible to formulate procedures to cover every contingency.

WARNING

Safe ejection with SJU-5/A and 6/A seats may not be possible in a zero-zero condition if there is a tailwind component on the aircraft.

17.1.5 High Altitude Ejection. The basic low altitude procedure is applicable to high altitude ejection. The zoom is useful to slow the aircraft to a safer ejection speed or to provide more time and glide distance if immediate ejection is not necessary. If the aircraft is descending out of control, eject by 6,000 feet AGL. Even if under control, do not delay ejection below 2,000 feet AGL. Head the aircraft toward an unpopulated area, if possible.

WARNING

Low altitude ejection may result in parachute canopy disintegration due to the aircraft impact fireball.

17.1.6 Ejection Procedures. See figure 17-3.

17.2 DITCHING

In the event ejection has failed and the aircraft must be ditched, see figure 17-4.

17.3 SEAWATER ENTRY

If downed in seawater, SEAWARS will release the parachute canopy within 2 seconds. However, if able, manually release both upper koch fittings immediately upon seawater entry. The SEAWARS does not operate in freshwater.

SJU-5/6

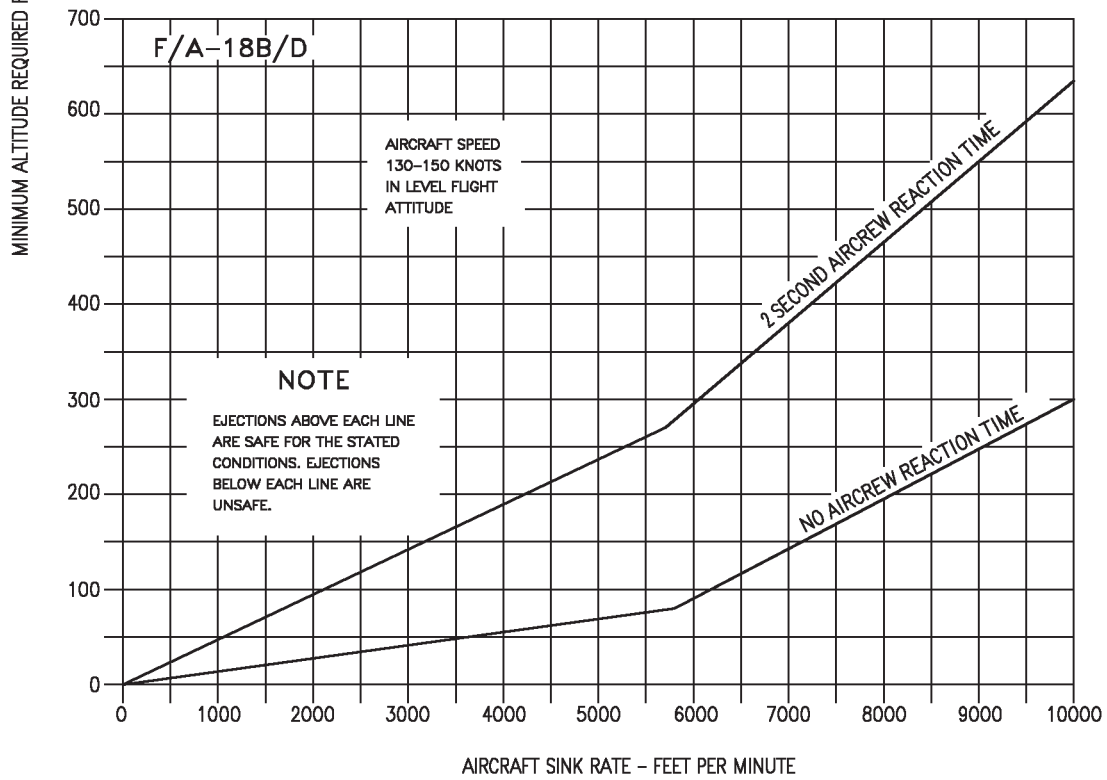
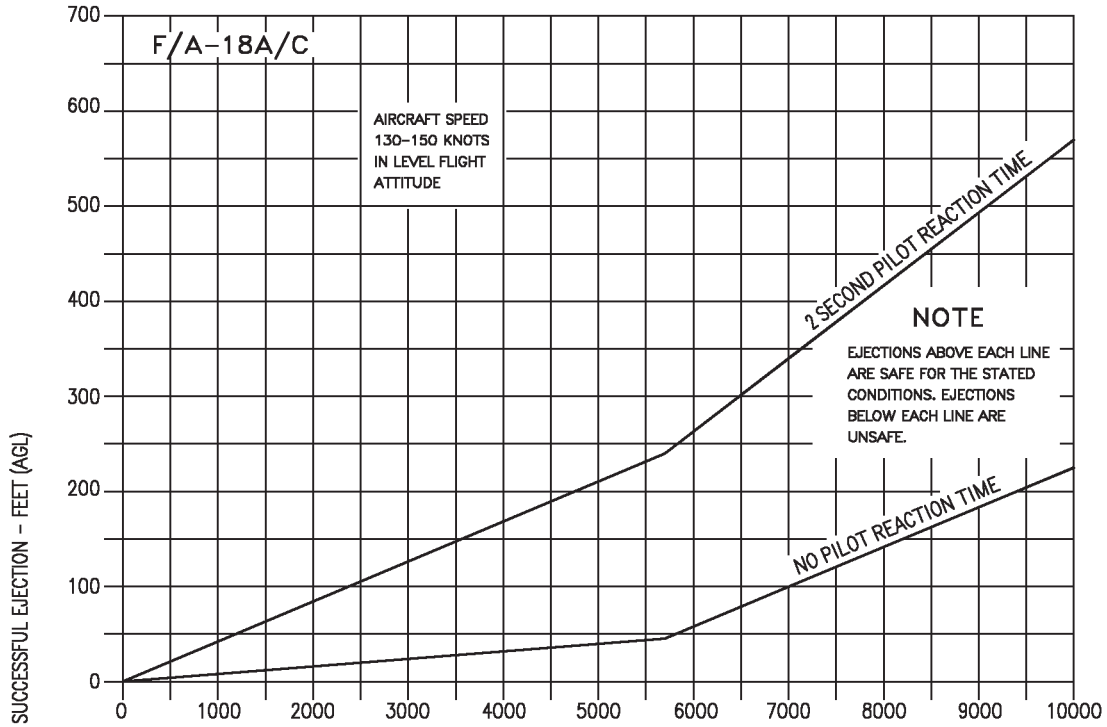

1BAC-NFM-00-(67-1)31-CATI

Figure 17-1. Ejection Sink Rate Effect (Sheet 1 of 3)

SJU-17 (F/A-18C)

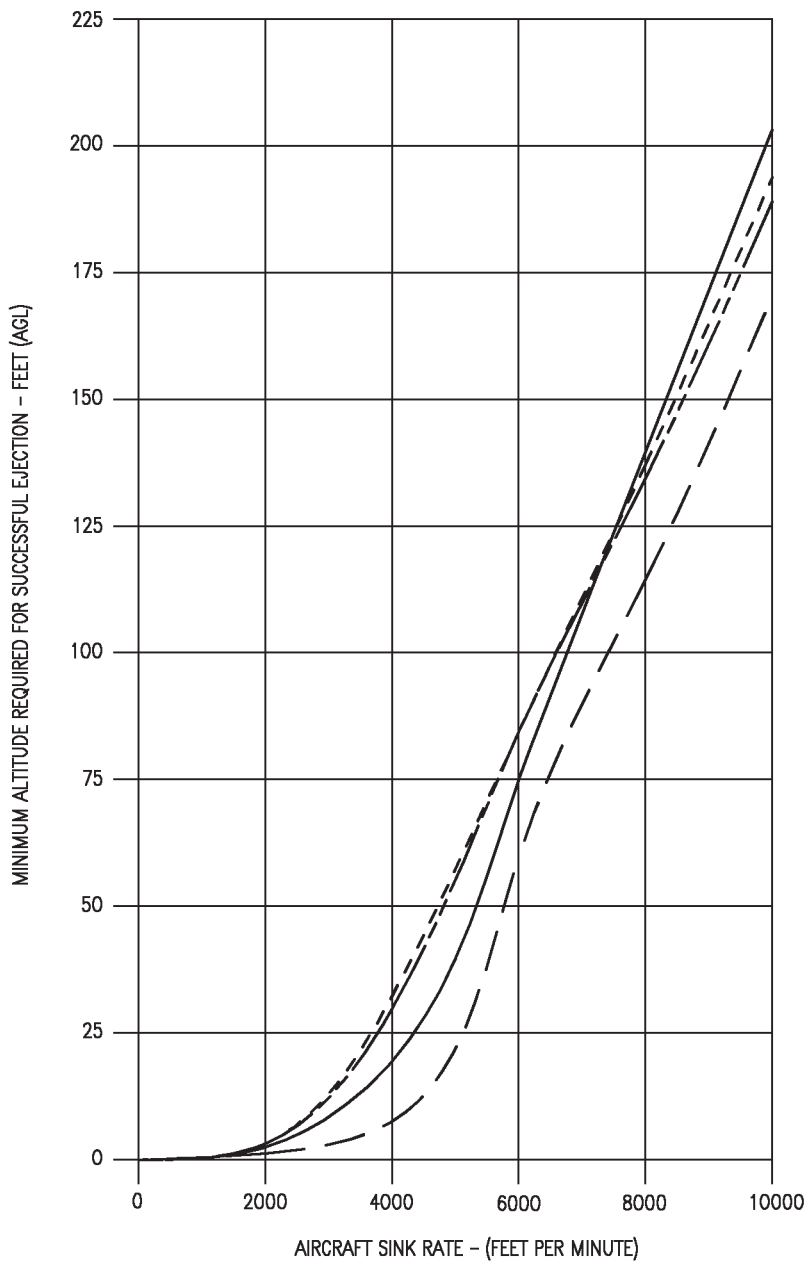

NOTES

- Minimum ejection heights are based on initiation of the escape system.
- Pilot reaction time is not included.
- Ejection altitude is below 5000 feet MSL.

LEGEND

- 130 KNOTS
- - - 250 KNOTS
- - - - 400 KNOTS
- - - - - 600 KNOTS

18AC-NFM-00-(67-2)31-CAT1

Figure 17-1. Ejection Sink Rate Effect (Sheet 2 of 3)

SJU-17 (F/A-18D)

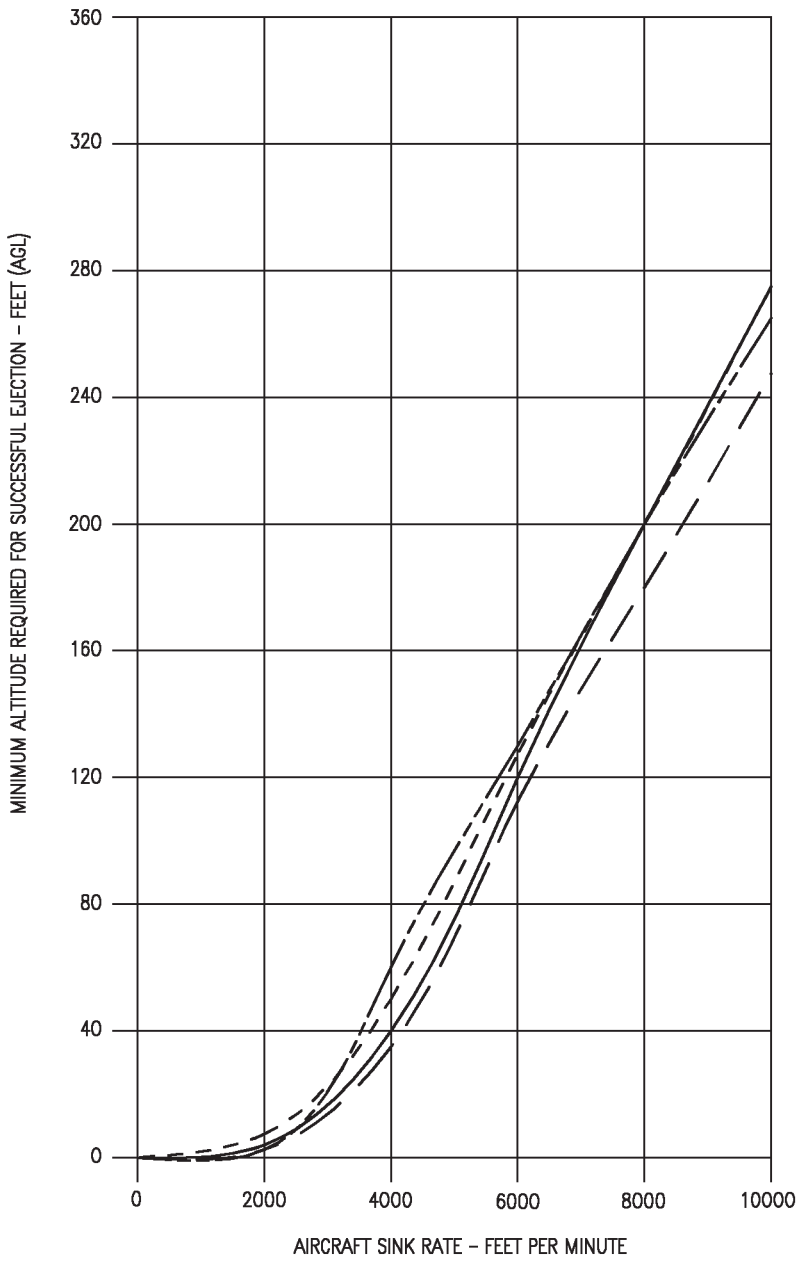

NOTES

- Minimum ejection heights are based on initiation of the escape system, and the time required for a complete dual sequenced ejection is included.
- Pilot reaction time is not included.
- Ejection altitude is below 5000 feet MSL.

LEGEND

- 130 KNOTS
- - - - - 250 KNOTS
- · - · - 400 KNOTS
- · - - - 600 KNOTS

18AC-NFM-00-(67-3)31-CAT1

Figure 17-1. Ejection Sink Rate Effect (Sheet 3 of 3)

SJU-5/6 AIRSPEED, DIVE ANGLE AND BANK EFFECTS (F/A -18A/C)

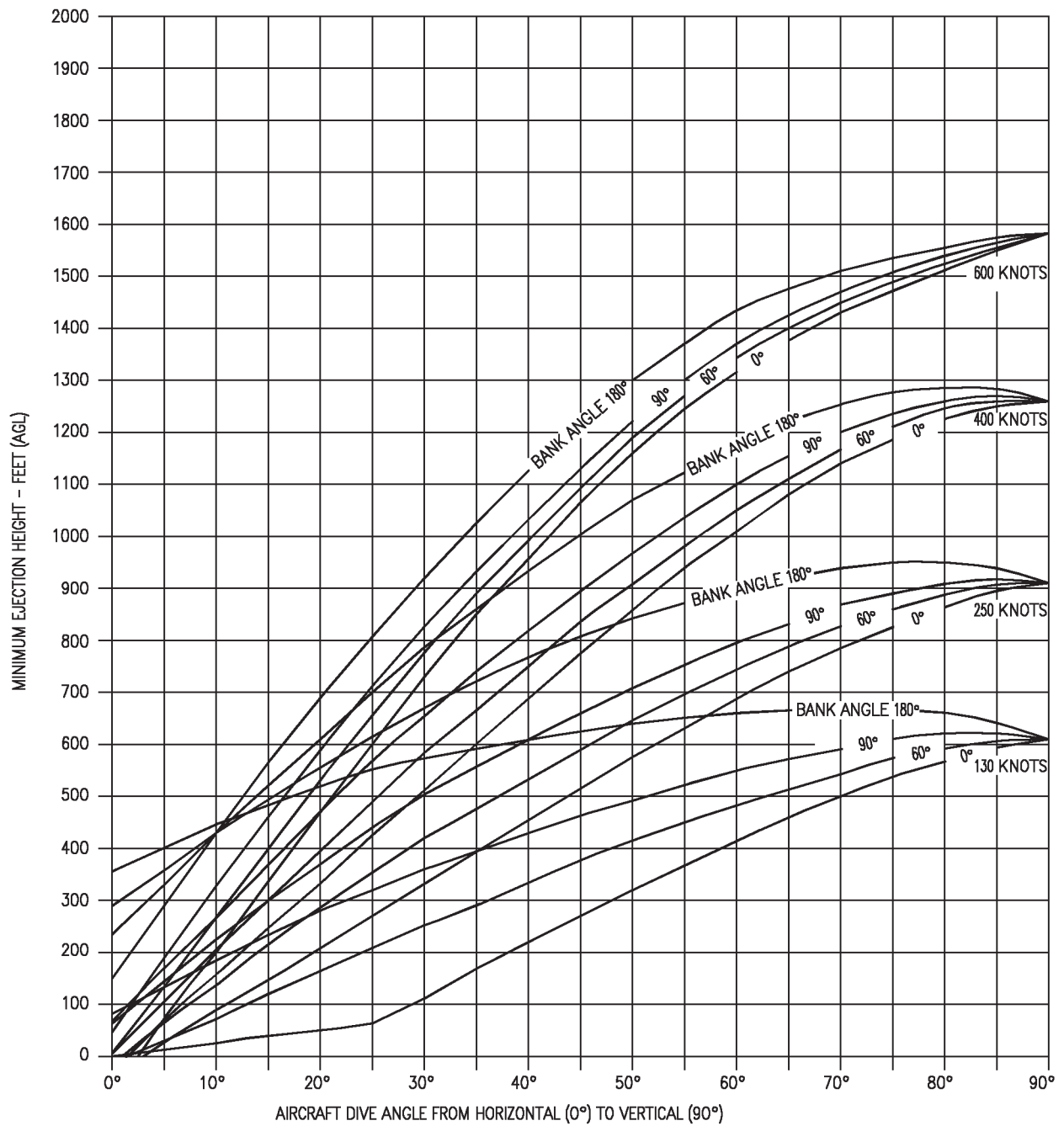

NOTES

- Minimum ejection heights are based on initiation of the escape system.
- Bank angle data is for coordinated flight. Yaw or slip will increase the height required for recovery.
- Pilot reaction time is not included.
- Ejection altitude is below 5000 feet MSL.

18AC-NFM-00-(68-1)31-CAT1

Figure 17-2. Minimum Ejection Altitude (Sheet 1 of 6)

SJU-17 AIRSPEED AND BANK ANGLE EFFECTS (F/A-18C)

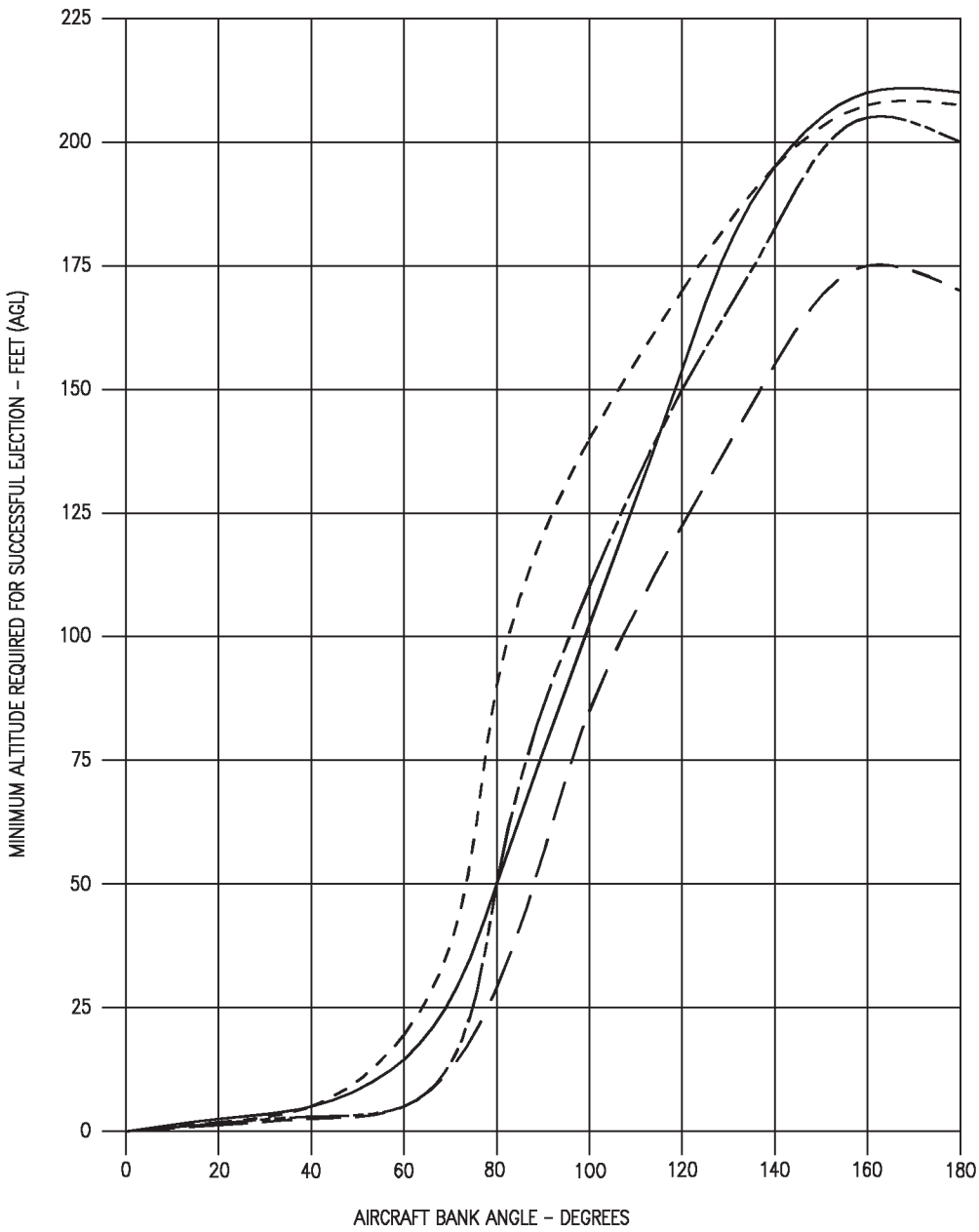

NOTES

- Minimum ejection heights are based on initiation of the escape system.
- Bank angle data is for coordinated flight. Yaw or slip will increase the height required for recovery.
- Pilot reaction time is not included.
- Ejection altitude is below 5000 feet MSL.

LEGEND

- 130 KNOTS
- - - - - 250 KNOTS
- 400 KNOTS
- 600 KNOTS

1BAC-NFM-00-(68-2)31-CAT1

Figure 17-2. Minimum Ejection Altitude (Sheet 2 of 6)

SJU-17 AIRSPEED AND DIVE ANGLE EFFECTS (F/A-18C)

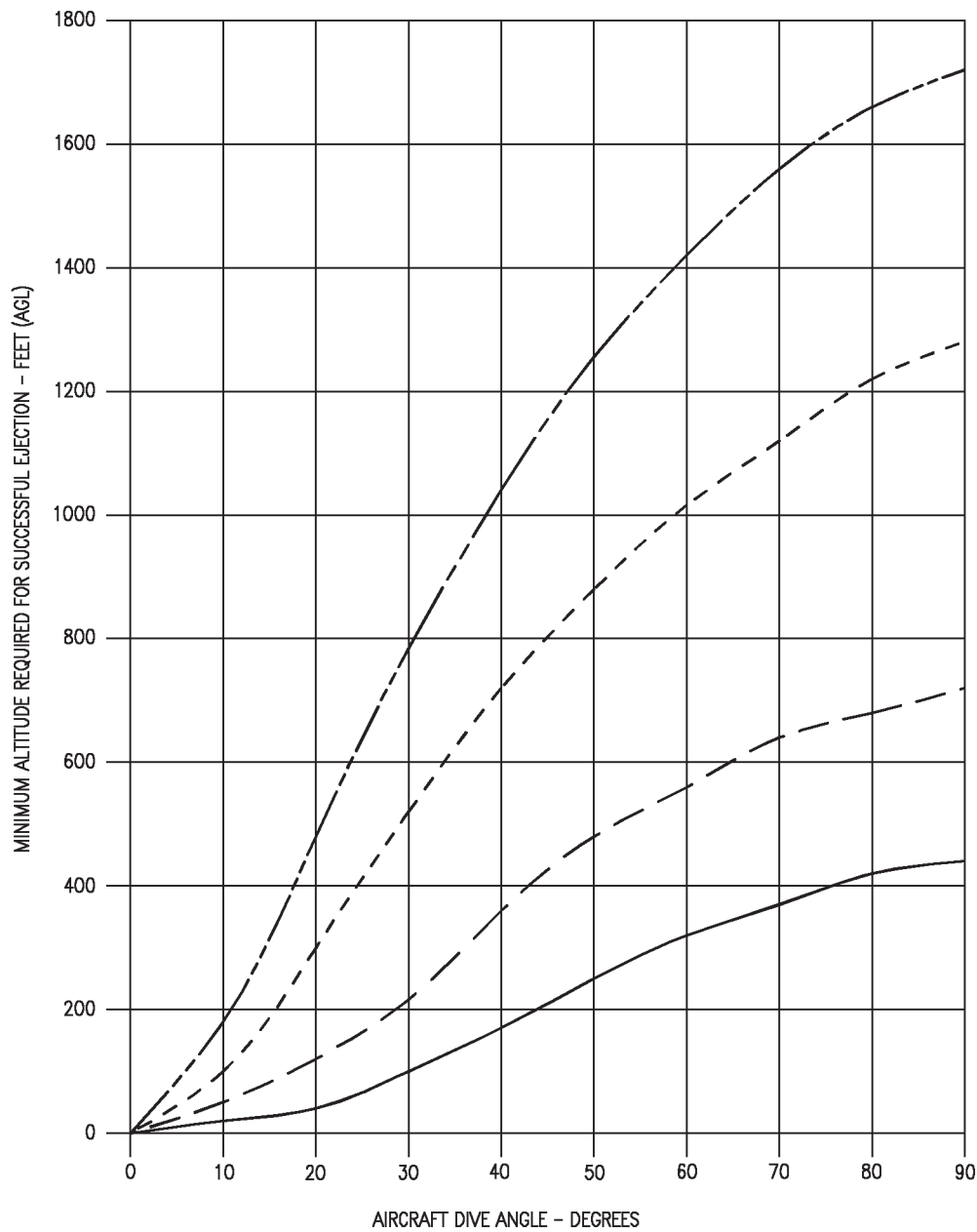

NOTES

- Minimum ejection heights are based on initiation of the escape system.
- Pilot reaction time is not included.
- Ejection altitude is below 5000 feet MSL.

LEGEND

- 130 KNOTS
- 250 KNOTS
- - - - - 400 KNOTS
- 600 KNOTS

18AC-NFM-00-(68-3)31-CAT1

Figure 17-2. Minimum Ejection Altitude (Sheet 3 of 6)

SJU-5/6 AIRSPEED, DIVE ANGLE AND BANK ANGLE EFFECTS (F/A-18B/D)

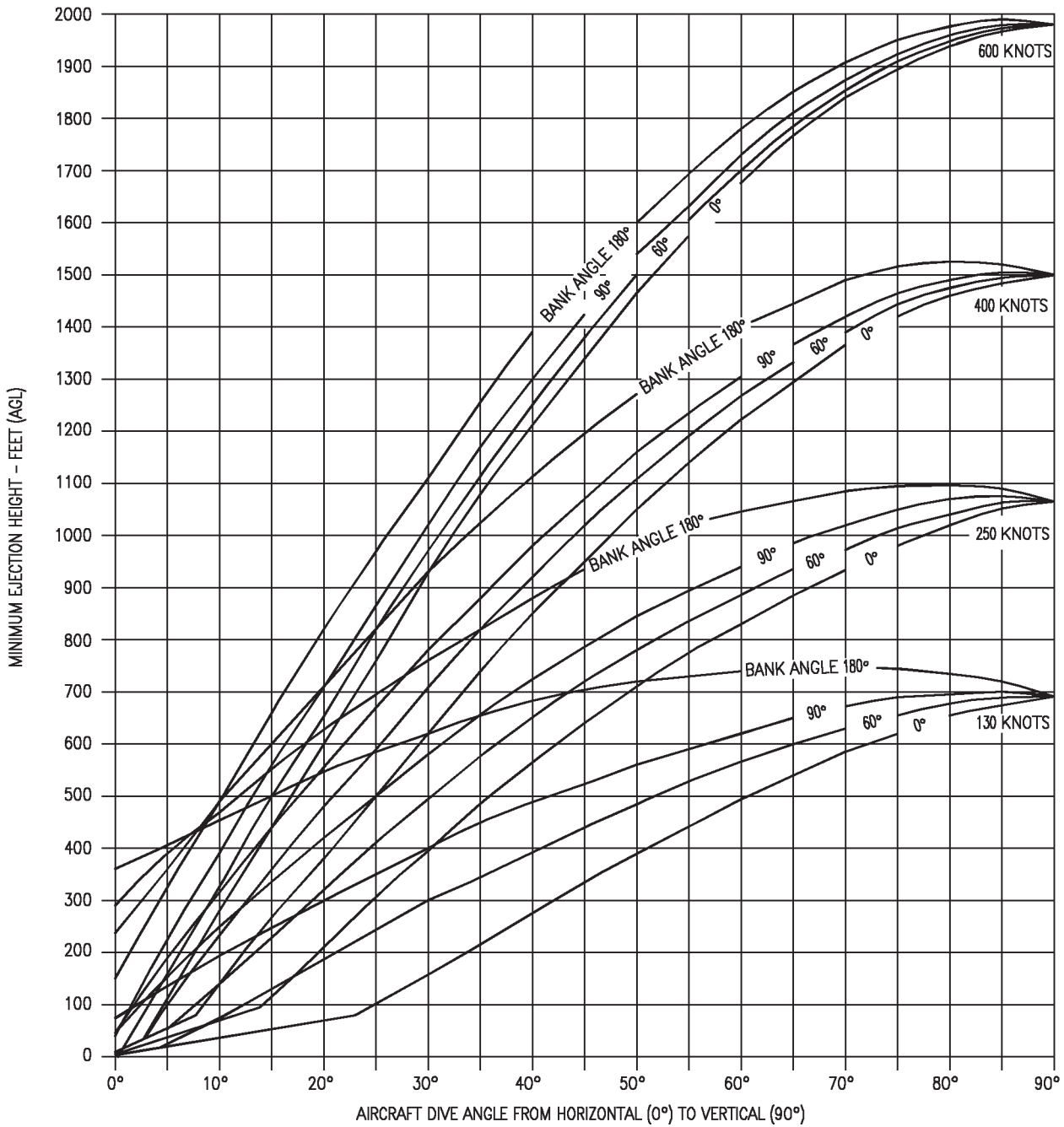

NOTES

- Minimum ejection heights are based on initiation of the escape system, and the time required for a complete dual sequenced ejection is included.
- Bank angle data is for coordinated flight. Yaw or slip will increase the height required for recovery.
- Aircrew reaction time is not included.
- Ejection altitude is below 5000 feet MSL.

1BAC-NFM-00-(69-1)31-CAT1

Figure 17-2. Minimum Ejection Altitude (Sheet 4 of 6)

SJU-17 AIRSPEED AND BANK ANGLE EFFECTS (F/A-18D)

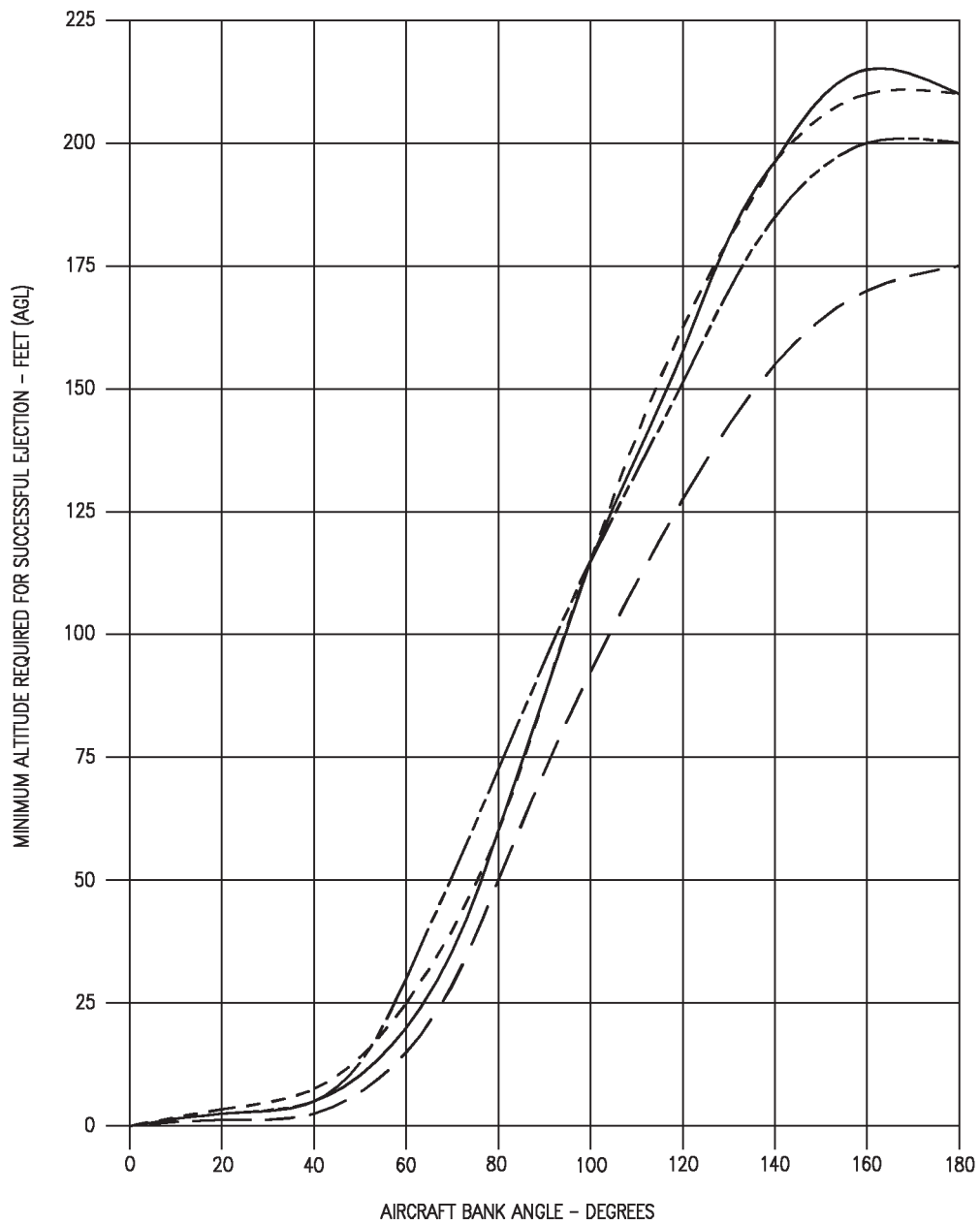

NOTES

- Minimum ejection heights are based on initiation of the escape system, and the time required for a complete dual sequenced ejection is included.
- Bank angle data is for coordinated flight. Yaw or slip will increase the height required for recovery.
- Aircrew reaction time is not included.
- Ejection altitude is below 5000 feet MSL.

LEGEND

- 130 KNOTS
- - - 250 KNOTS
- - - - 400 KNOTS
- - - - - 600 KNOTS

18AC-NFM-00-(69-2)31-CAT1

Figure 17-2. Minimum Ejection Altitude (Sheet 5 of 6)

SJU-17 AIRSPEED AND DIVE ANGLE EFFECTS (F/A-18D)

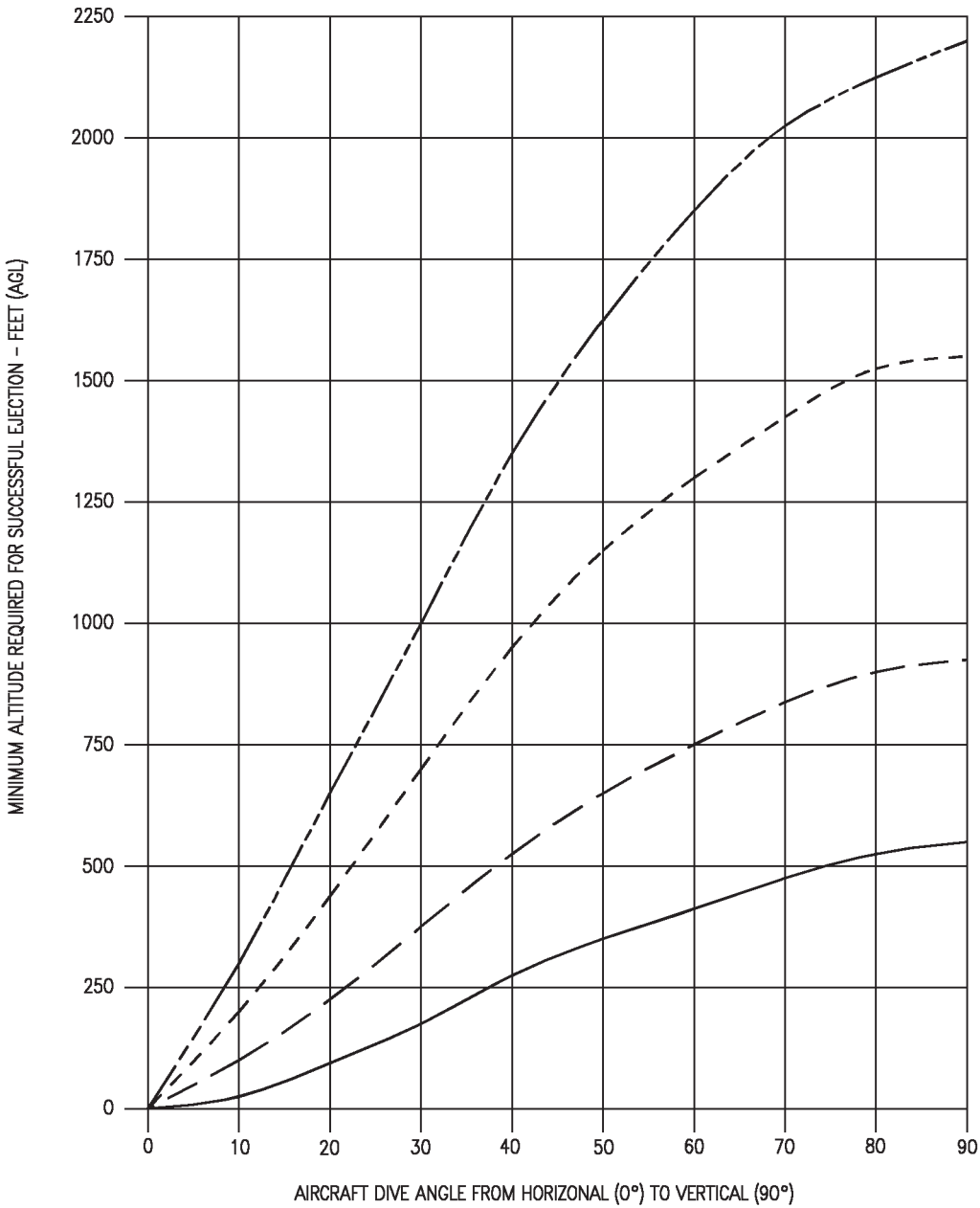

NOTES

- Minimum ejection heights are based on initiation of the escape system, and the time required for a complete dual sequenced ejection is included.
- Aircrew reaction time is not included.
- Ejection altitude is below 5000 feet MSL.

LEGEND

- 130 KNOTS
- - - - 250 KNOTS
- - - - 400 KNOTS
- - - - 600 KNOTS

18AC-NFM-00-(69-3)31-CAT1

Figure 17-2. Minimum Ejection Altitude (Sheet 6 of 6)

SJU-5/6 SEAT SYSTEMS

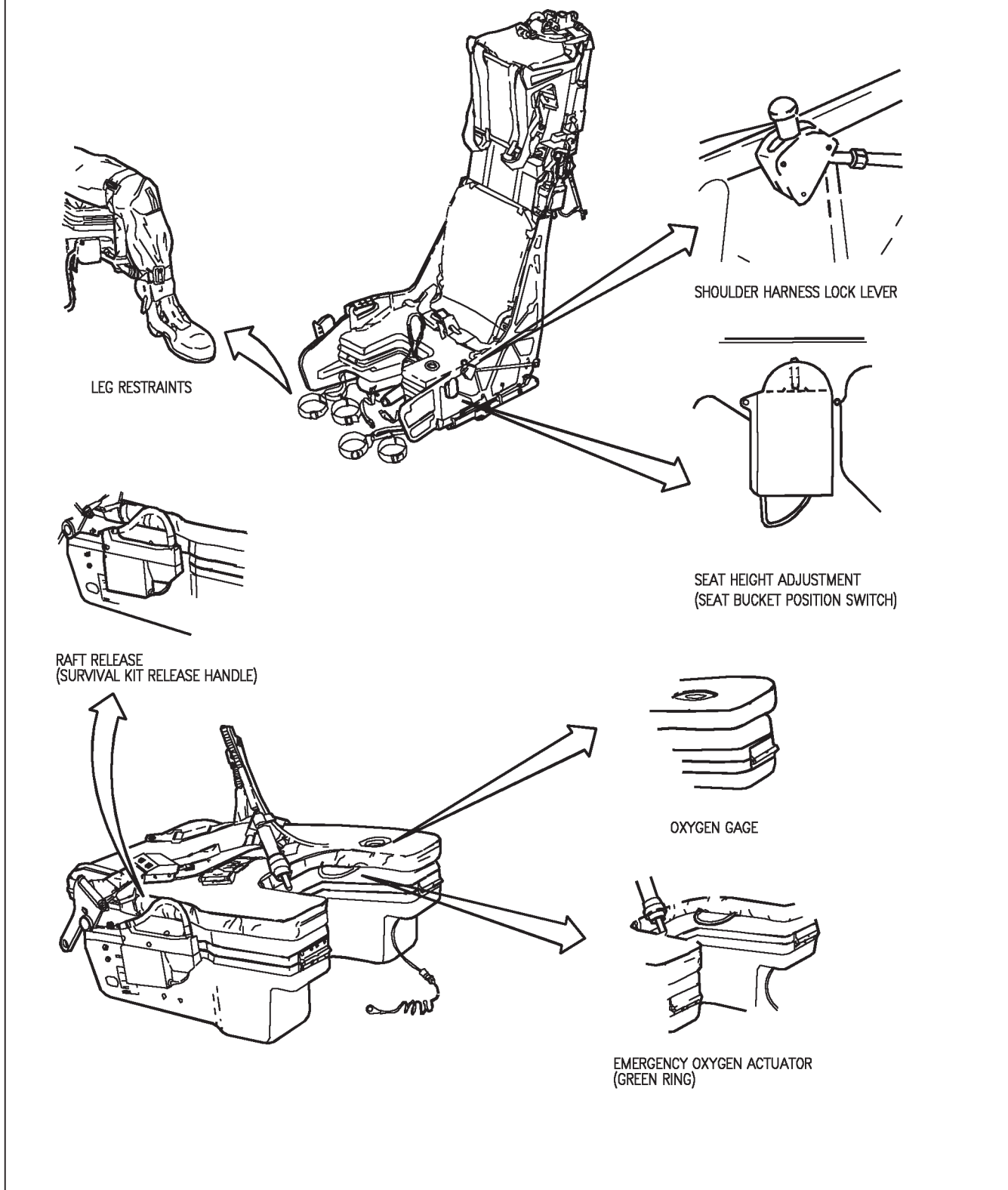

1BAC-NFM-00-(70-1)31-CAT1

Figure 17-3. Ejection Procedures (Sheet 1 of 24)

SJU-5/6 SEAT SYSTEMS (CONTINUED)

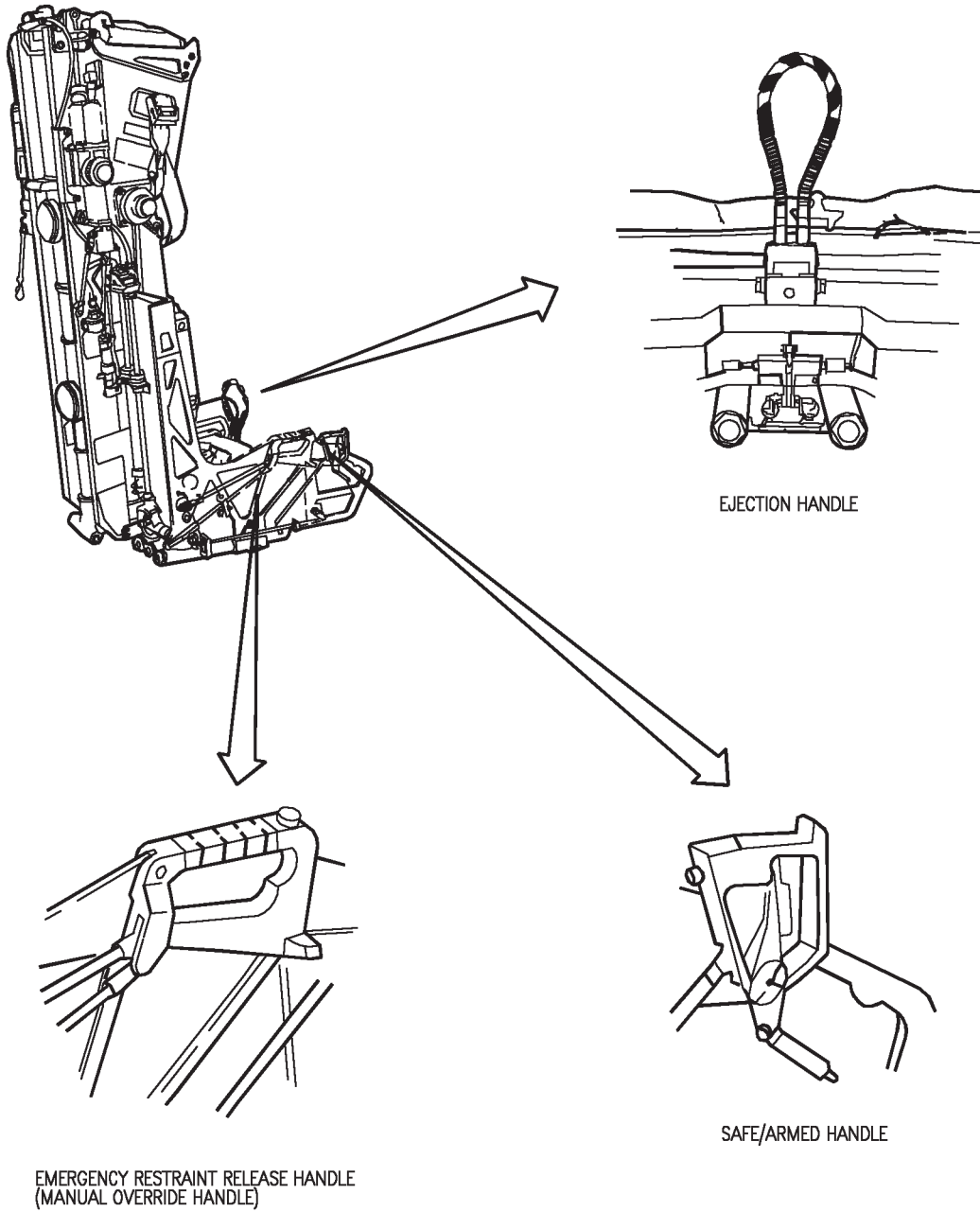

18AC NFM 00 70 231 CAT

Figure 17-3. Ejection Procedures (Sheet 2 of 24)

SJU-5/6 SEAT SYSTEMS (CONTINUED)
PINS REQUIRING REMOVAL
PRIOR TO FLIGHT:

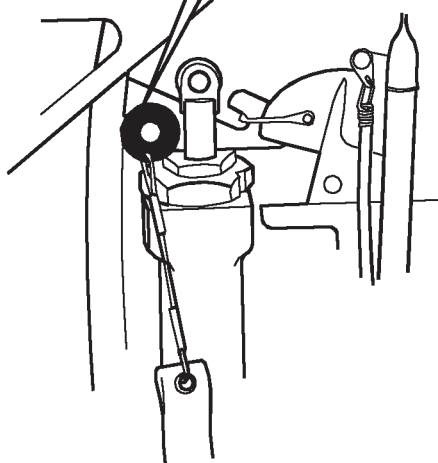
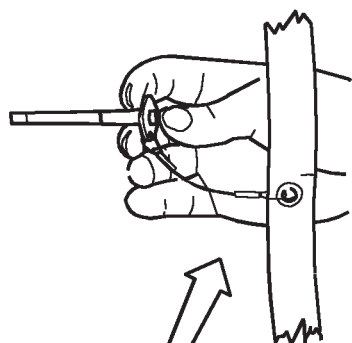
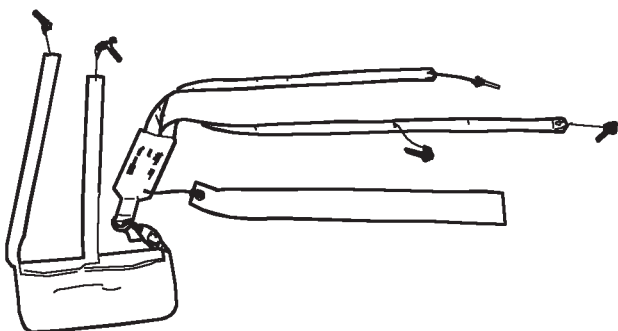

ROCKET MOTOR INITIATOR SAFETY PIN

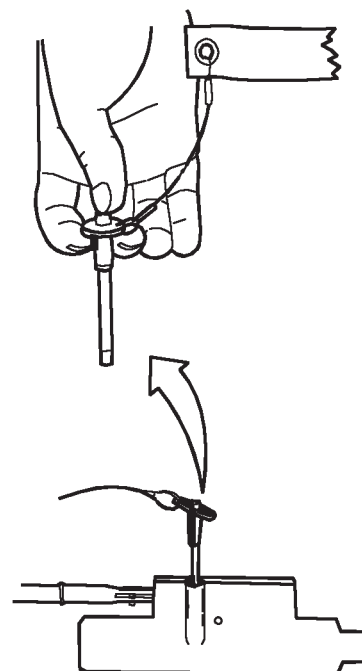

DROGUE GUN SAFETY PIN

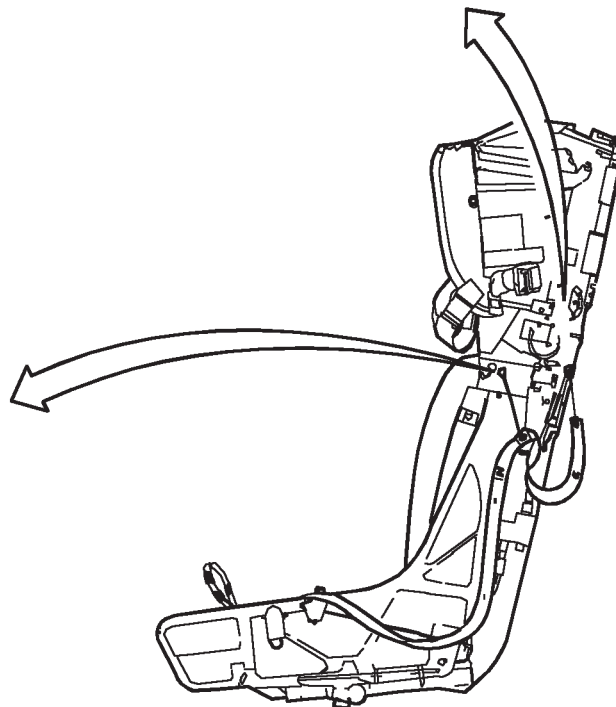
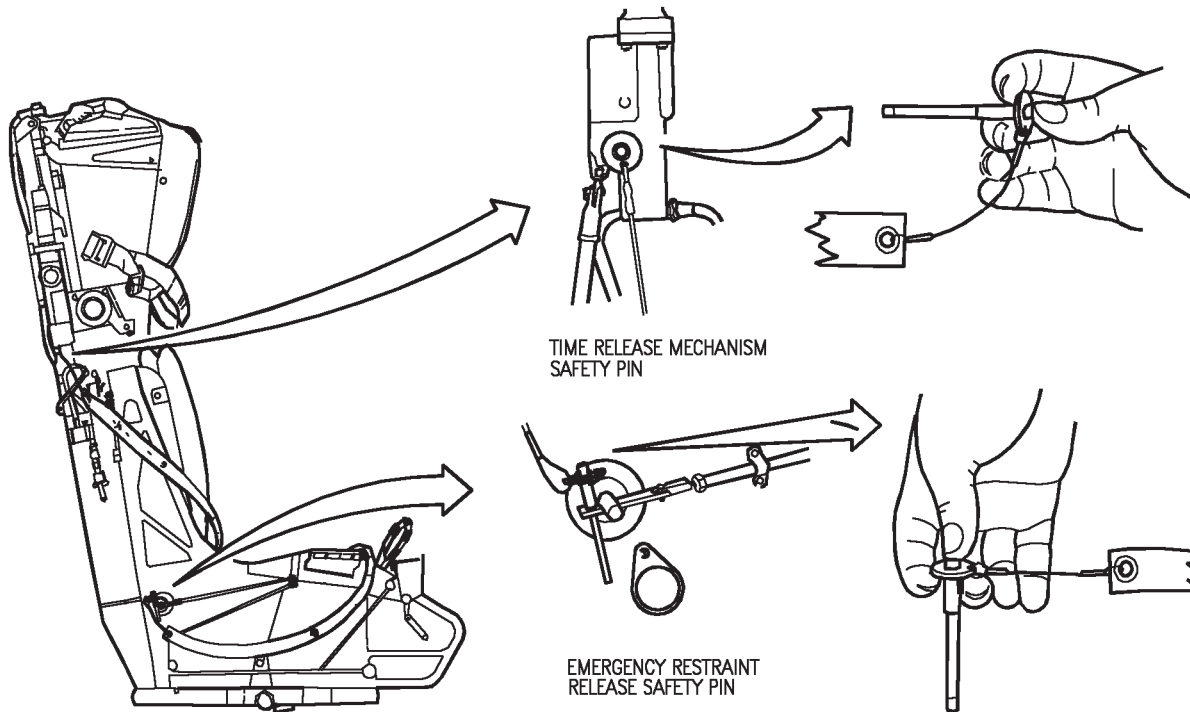
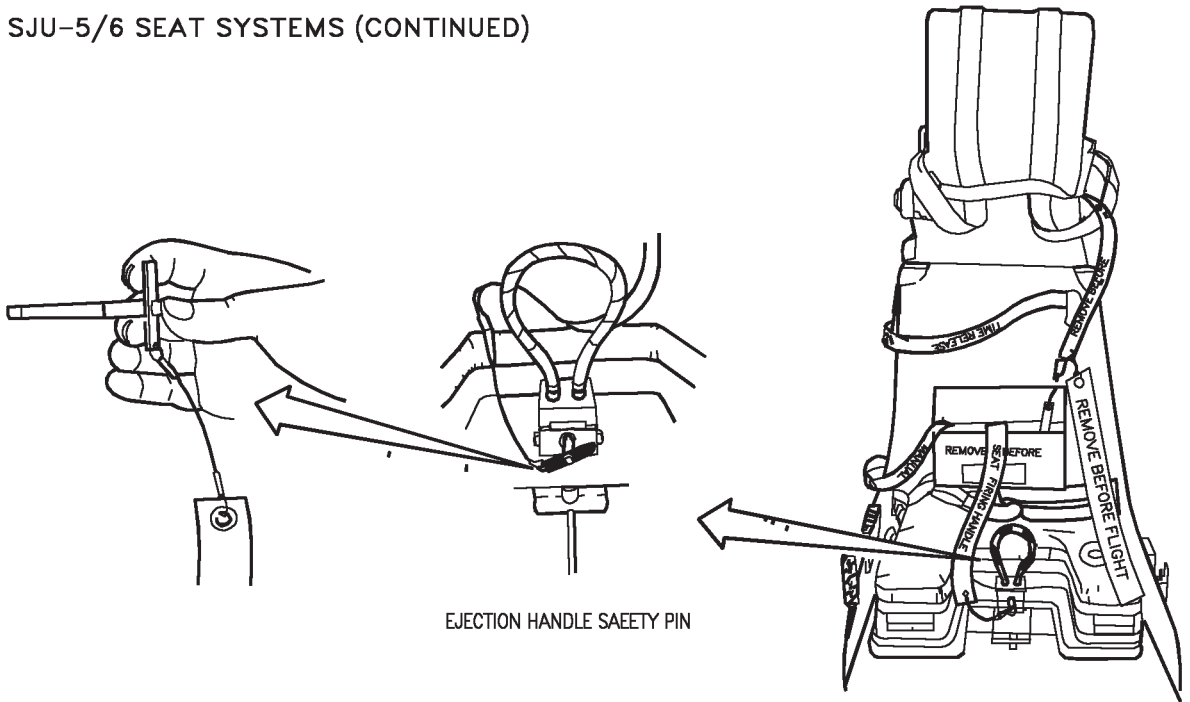

Figure 17-3. Ejection Procedures (Sheet 3 of 24)

SJU-5/6 SEAT SYSTEMS (CONTINUED)



18AC NFM 00 170 4131 CAT1

Figure 17-3. Ejection Procedures (Sheet 4 of 24)

SJU-5/6 SEAT SYSTEMS (CONTINUED)
EJECTION PREPARATION

IMMEDIATE EJECTION

For extreme emergency situations; pilot shall immediately initiate ejection.

CONTROLLED EJECTION

- If time and conditions permit -
1. Alert crewmember (F/A-18B/D only).
 2. Command selector valve - Rear crewmember check for appropriate position (F/A-18B/D only).

WARNING

- SOLO mode shall NOT be selected when both seats are occupied. If SOLO mode is selected when both seats are occupied, simultaneous ejection initiation may result in a collision between seats.
 - In the F/A-18B/D aircraft flying with two aircrew, it is important for both aircrew to initiate ejection with the ejection control handles. This will assure ejection of both aircrew in the event of an aircraft sequencing system failure, and will not alter the seat timing sequence if there is no sequencing system failure.
3. Trade airspeed for altitude (zoom).
 4. Level wings and minimize rate of descent.
 5. IFF - Squawk EMERGENCY.
 6. Follow radio distress procedures.
 7. Stow loose equipment.
 8. Cabin pressure switch - RAM/DUMP.
 9. Shoulder harness lock lever - LOCKED.
 10. Lap belt and shoulder harness tight, visor down, helmet secured, oxygen mask tight.
 11. Altimeter - CHECK.

WARNING

Minimum altitudes are dependent upon dive angle, airspeed, and angle of bank. Recommended minimums are 6,000 feet AGL if out-of-control or 2000 feet AGL if in controlled flight.

12. Slow aircraft as much as possible.

WARNING

Do not secure engines. Unsuccessful seat activation may require continued flight to allow alternate ejection method or ditching.

13. Throttles - Idle (airspeed 250 knots or less).

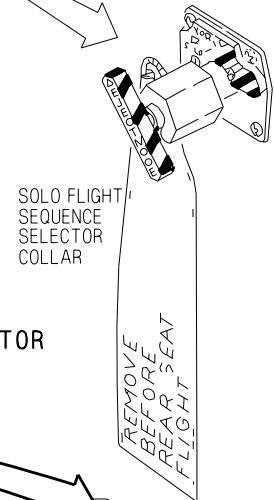
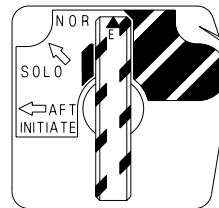
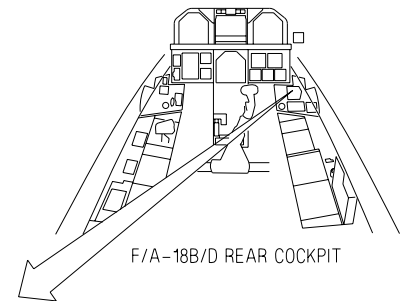

EJECTION MODE SELECTOR

OR

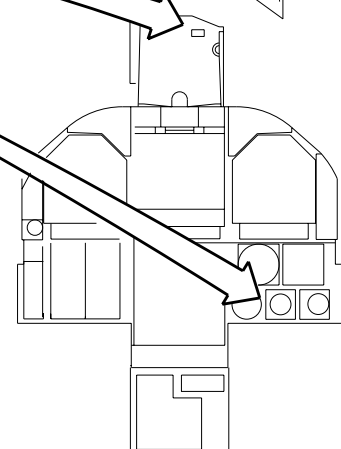

NOTE

Over 14,500 -11,500 feet, calculate free-fall time to automatic parachute opening altitude.

Figure 17-3. Ejection Procedures (Sheet 5 of 24)

SJU-5/6 (Continued)**Ejection Preparations****WARNING**

With the Armpit Camera System (ACS) installed, maintain the right elbow and arm close to the body .

EJECTION INJURIES AND BODY POSITIONING

**THESE PROPER BODY POSITIONS
MUST BE TAKEN TO PREVENT INJURIES**

- | | |
|--|---|
| 1. Press head firmly against headrest. | 5. Press buttocks firmly against the seat back. |
| 2. Elevate chin slightly (10°). | 6. Place thighs flat against seat. |
| 3. Press shoulders and back firmly against seat. | 7. Press outside of thighs against side of seat. |
| 4. Hold elbows and arms firmly towards sides. | 8. Place heels firmly on deck, toes on rudder pedals. |

EJECTION INITIATION

There are two acceptable methods for ejection initiation; the two-hand grip and the single-hand grip.

Two-hand method -

1. Grip the ejection handle with the thumb and at least two fingers of each hand, palms toward body.
Keep elbows close to body.

Single-hand method -

1. Grip handle with the strong hand, palm toward body. Grip wrist of strong hand with other hand, palm toward body. Keep elbows close to body.

Both methods -

2. Pull handle sharply up and toward abdomen, keeping elbows in. Ensure handle pulled to end of travel.
Continue holding handle until seat/man separation.

NOTE

In low altitude situations, a one-handed method, using one hand to initiate ejection and the other to maintain the aircraft in the safe operating envelope of the ejection seat, may be required. If firing the seat by this method, particular attention must be paid to maintaining proper body position.

Figure 17-3. Ejection Procedures (Sheet 6 of 24)

SJU-5/6 SEAT SYSTEMS (CONTINUED)
AUTOMATIC SEAT/MAN SEPARATION

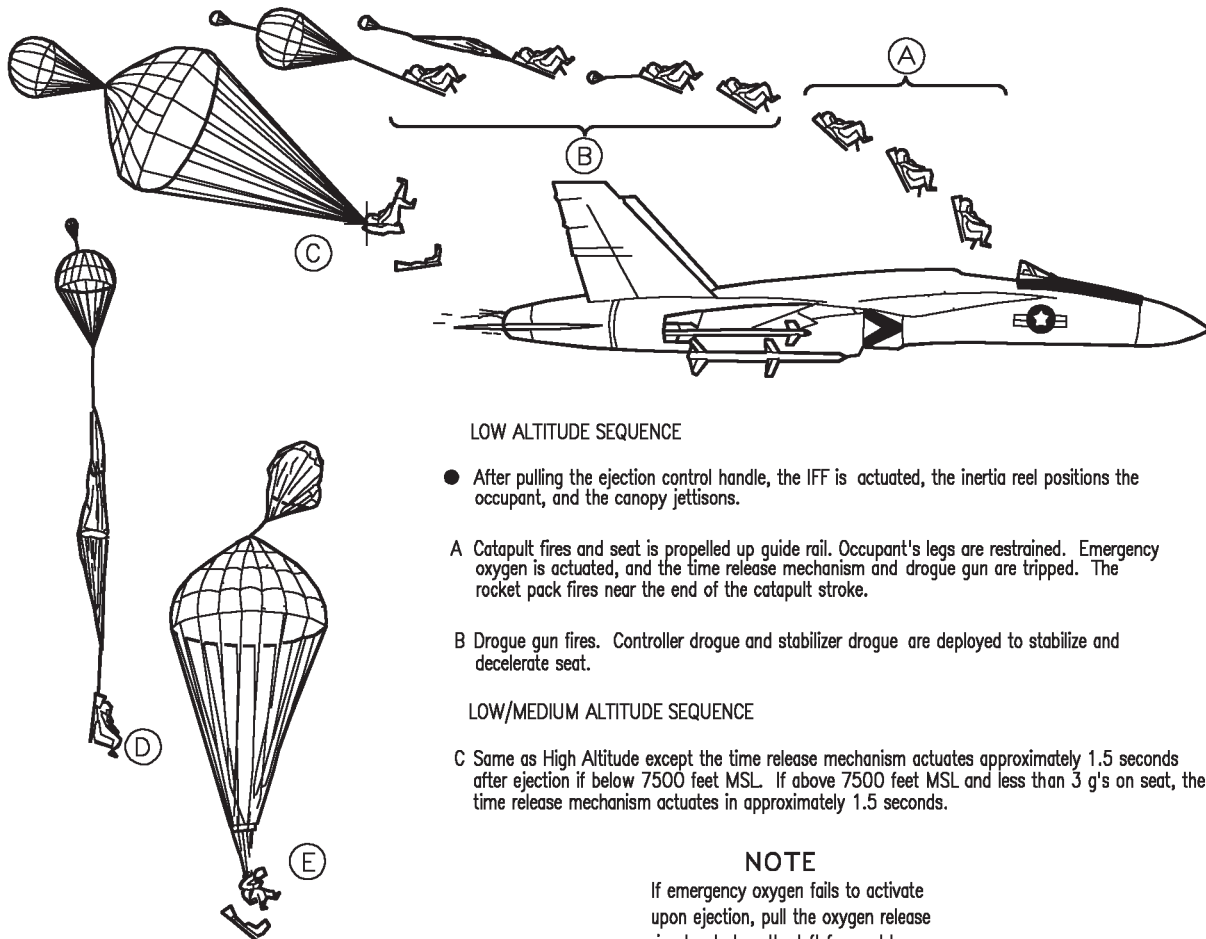

LOW ALTITUDE SEQUENCE

- After pulling the ejection control handle, the IFF is actuated, the inertia reel positions the occupant, and the canopy jettisons.
- A Catapult fires and seat is propelled up guide rail. Occupant's legs are restrained. Emergency oxygen is actuated, and the time release mechanism and drogue gun are tripped. The rocket pack fires near the end of the catapult stroke.
- B Drogue gun fires. Controller drogue and stabilizer drogue are deployed to stabilize and decelerate seat.

LOW/MEDIUM ALTITUDE SEQUENCE

- C Same as High Altitude except the time release mechanism actuates approximately 1.5 seconds after ejection if below 7500 feet MSL. If above 7500 feet MSL and less than 3 g's on seat, the time release mechanism actuates in approximately 1.5 seconds.

NOTE

If emergency oxygen fails to activate upon ejection, pull the oxygen release ring located on the left forward top of the seat kit.

HIGH ALTITUDE SEQUENCE

- D When between 14,500 MSL and 11,500 feet MSL is reached, the time release mechanism actuates to release the occupants harness and leg restraint lines. The scissor shackle is released and the drogue chute pull the link line to deploy the main parachute.
- E The opening shock of the parachute separates occupant from the seat allowing normal descent.

WARNING

If high terrain is not a factor, do not use manual seat/man separation until below 11,500 feet MSL.

Figure 17-3. Ejection Procedures (Sheet 7 of 24)

SJU-5/6 SEAT SYSTEMS (CONTINUED)

MANUAL SEAT/MAN SEPARATION

If below 11,500 feet MSL and automatic seat/man separation fails to occur:

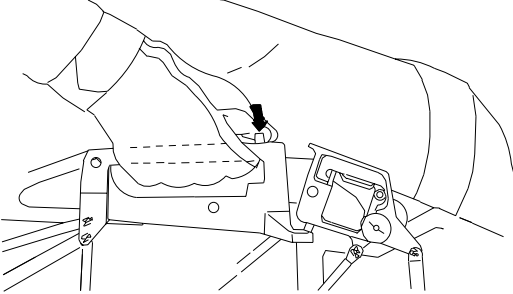

1. Locate manual override handle on right side of ejection seat. Depress handle release button and . . .

The following occurs when the handle is actuated:

- Manual override initiator cartridge fires to activate both the time release mechanism and drogue gun secondary cartridge.
- All occupant-to-seat restraints are released.

WARNING

The time release mechanism operates as a function of above mean sea level. If ejecting over high altitude terrain, manual seat/man separation may be required to provide adequate altitude for the main parachute to open.

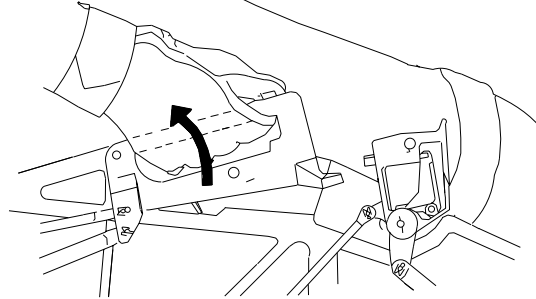

2. Rotate handle up and aft.

- Scissors shackle opens to release drogue parachutes and deploy main parachute.
- The opening shock of the parachute separates occupant from the seat allowing normal descent.

BAILOUT

There are no provisions for manual bailout.

POST EJECTION PROCEDURES

LPU INFLATION

WARNING

Although an automatic inflation device is designed to inflate the LPU automatically upon water contact, manual inflation of the LPU remains primary mode of actuation. Automatic actuation is intended for disabled or unconscious survivors or if there is insufficient time to manually activate the LPU.

NOTE

The procedures outlined apply to overland or overwater ejections.

1. Immediately following parachute opening shock, check the condition of the parachute canopy. If no damage/malfunction has occurred..
2. Locate beaded handles on LPU.
3. Pull beaded handles down and straight out to inflate.
4. Squeeze LPU waist lobes together to help release velcro on collar lobe or manually release velcro on collar, if necessary, to achieve complete collar lobe inflation.
5. Snap waist lobes together, (optional procedure).

WARNING

Failure to snap waist lobes before water entry may result in face down flotation.

ADA520-70-8-053

Figure 17-3. Ejection Procedures (Sheet 8 of 24)

SJU-5/6 SEAT SYSTEMS (CONTINUED)
SEAT KIT DEPLOYMENT

CAUTION

- Deployment of the seat kit/releasing the raft may create a snag hazard when over trees, power lines, building or "other such objects, and thus may be undesirable in these situations".
- Conducting parachute landings with the seat kit attached may cause injury during landing falls".



1. After inflating the LPU, prepare to deploy the seat kit.

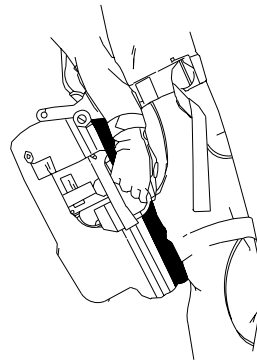

2. With the right hand locate the survival kit release handle on the right side of the seat kit.

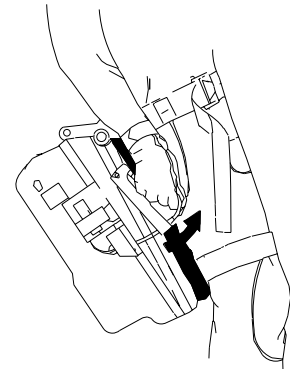

3. Firmly pull up on the survival kit release handle until handle is free of kit and the lower half of seat kit falls away.

NOTE

- Pulling the survival kit release handle unlocks the container: the lower half falls away but remains attached by a dropline. At full extension of the dropline, the liferaft is automatically inflated with CO₂.
- If the survival kit must be deployed after water entry, a snatch pull on the dropline near the CO₂ bottle is required to inflate the liferaft.

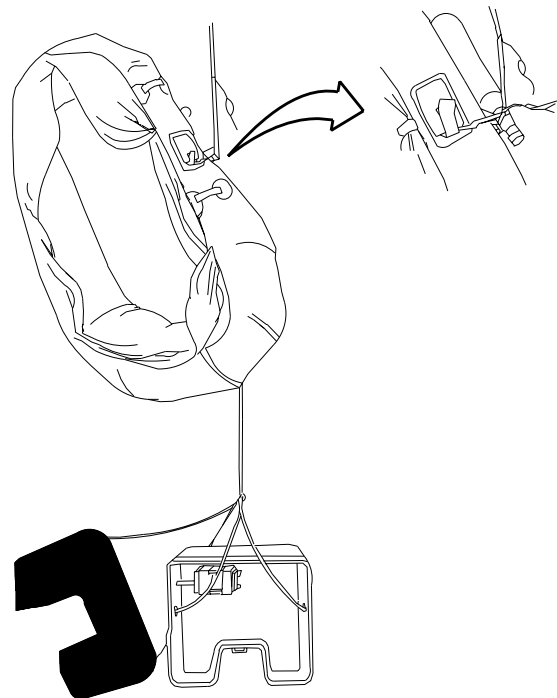

Seat kit deployed with the life-raft fully inflated approximately 17 feet below the upper half of the seat kit container.

ADA520-70-9-053

Figure 17-3. Ejection Procedures (Sheet 9 of 24)

SJU-5/6 SEAT SYSTEMS (CONTINUED)

INJURED ARM SEAT KIT DEPLOYMENT

1. Release oxygen mask from one side of the helmet.
2. Release lower oxygen hose from seat kit.
3. Release right seat kit quick-release fitting.
4. Using the left hand, rotate the seat kit until the survival kit release handle can be reached.
5. Use the legs to position and hold the seat kit.
6. Pull the survival kit release handle with the left hand. Allow the lower portion of seat kit to fall free.

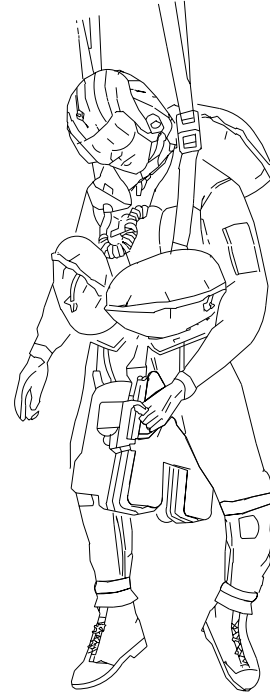

OPTIONS OVER WATER

If time and altitude permit, or rescue is not imminent, removing oxygen mask, visor and gloves may be considered.

NOTE

- Removal of gloves may facilitate subsequent release of parachute release fittings.
- Stow gloves in a secure place to prevent loss.
- The MBU series oxygen mask and miniature regulator provide underwater breathing capability and should be retained in low level over water ejections.

ADA520-70-10-043

Figure 17-3. Ejection Procedures (Sheet 10 of 24)

SJU-5/6 SEAT SYSTEMS (CONTINUED)

PARACHUTE LANDING FALL (PLF) PROCEDURES

Upon toes touching ground surface:

1. Arch side of body in direction of fall.
2. Contact ground at five points of body contact:
 - a. Balls of feet.
 - b. Calf.
 - c. Thigh.
 - d. Buttocks.
 - e. Upper back.
3. Release parachute fittings.

RAFT BOARDING

When clear of the parachute canopy, retrieve the LR-1 life raft by locating the dropline and pulling the raft to you.

1. Locate and remove the raft retaining lanyard from its pocket just above the CO₂ cylinder.

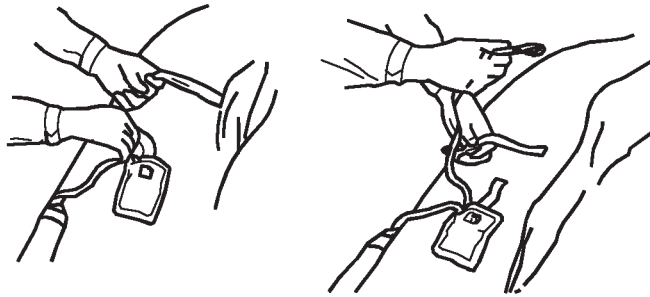

NOTE

Ensure that raft retaining lanyard is securely attached and oxygen hose has been disconnected from seat kit (if not previously accomplished) before releasing upper half of seat kit.

2. Attach the snaphook to gated helo-hoist lift ring.
3. Locate the quick-release fitting and release upper half of seat kit.
4. Bring raft around for entry into smaller end (stern).
5. Grasp stern and forcibly push under LPU waist lobes.
6. Using boarding handles, pull into raft and turn toward a seated position.
7. Locate the sea anchor and deploy it.
8. Retrieve lower half of seat kit.

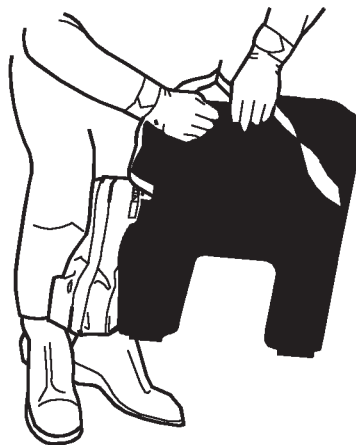

NOTE

- The AN/URT-33A is not secured and once removed from the seat kit, care must be taken to prevent its loss.
- The AN/URT-33A has a retrieval lanyard secured to it with rubber bands. Attach the lanyard to a suitable place on survival equipment. Then remove the AN/URT-33A from its bracket.

9. Locate and retrieve the AN/URT-33A from the lower half of the seat kit.
10. Immediately, secure survival package to gated helo-hoist lift ring.

SJU-17 SEAT SYSTEMS

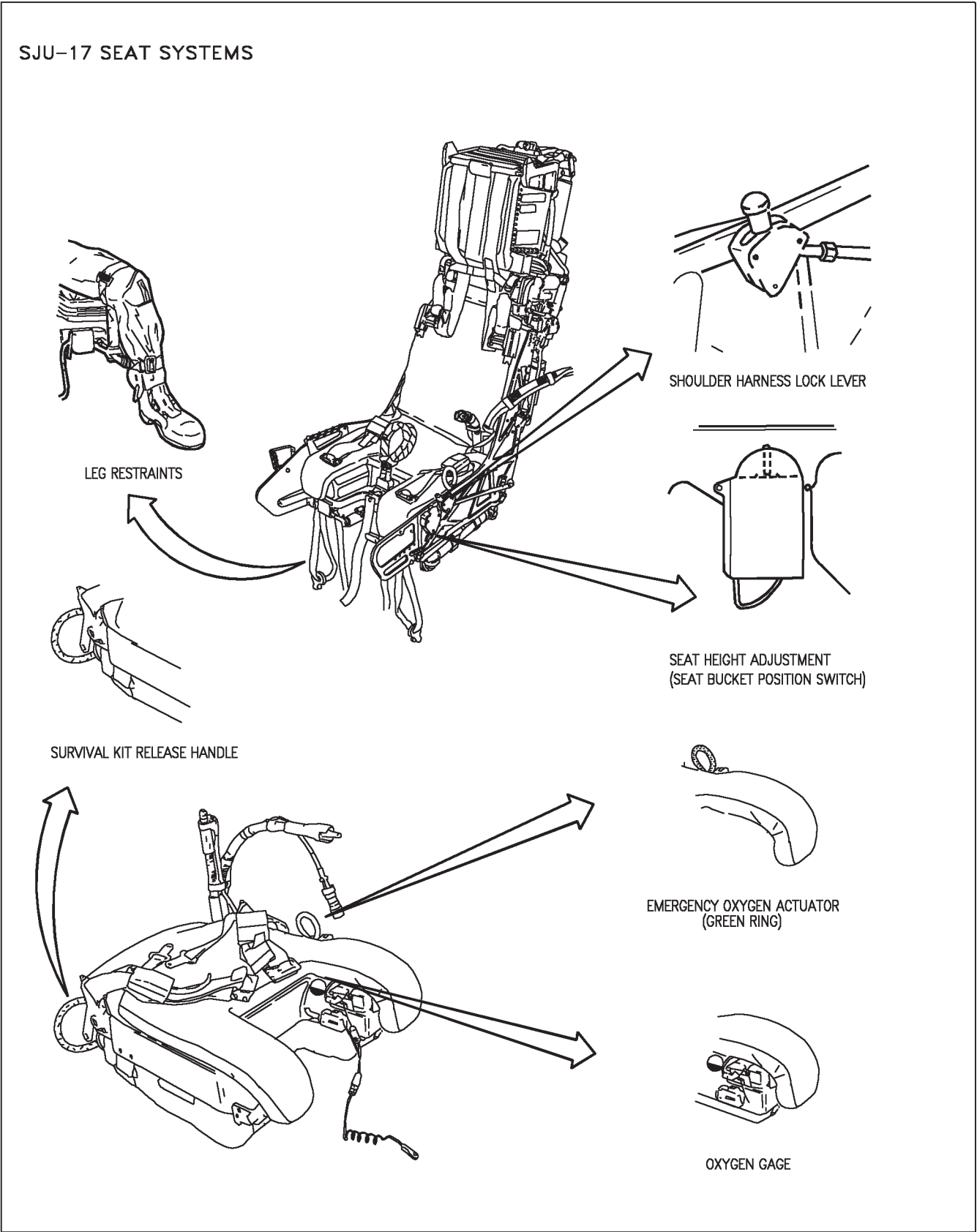

18AC-NFM-00-(147-1)31-CATI

Figure 17-3 . Ejection Procedures (Sheet 12 of 24)

SJU-17 SEAT SYSTEMS (CONTINUED)

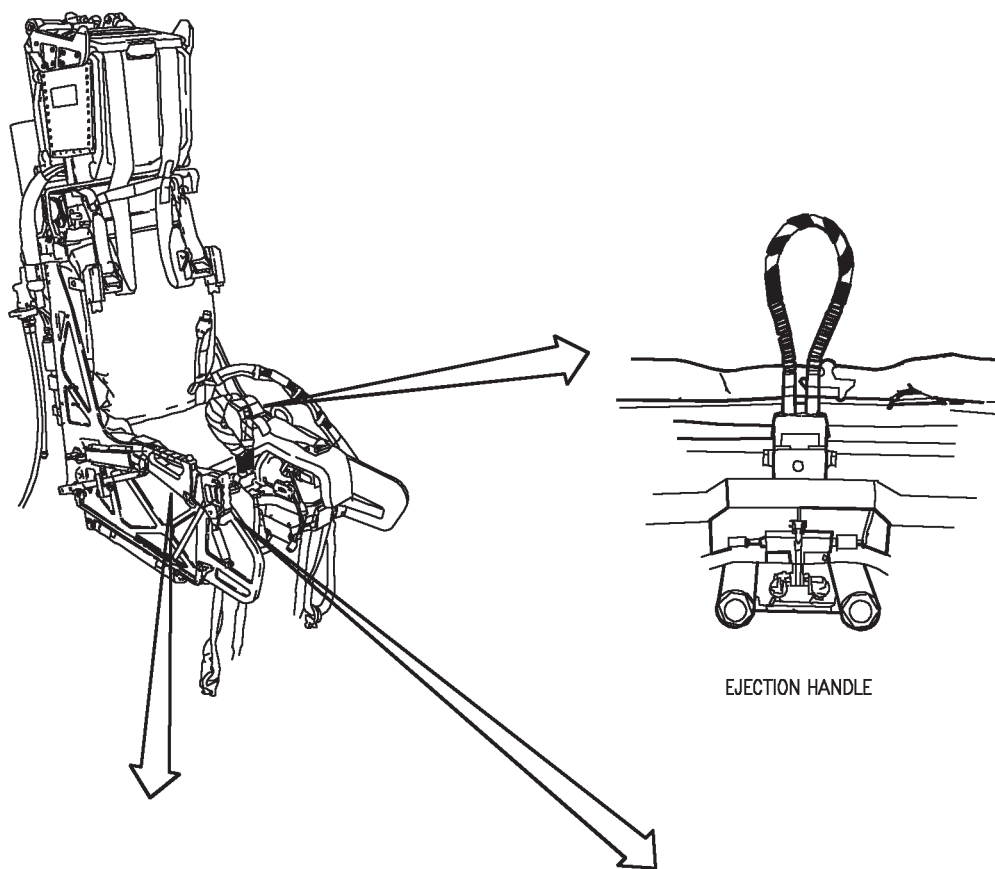

EJECTION HANDLE

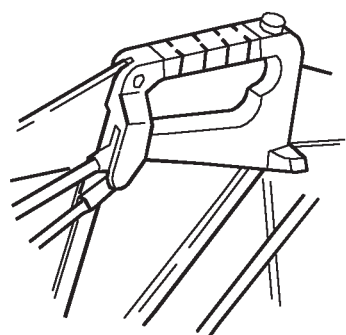

EMERGENCY RESTRAINT RELEASE HANDLE
(MANUAL OVERRIDE HANDLE)

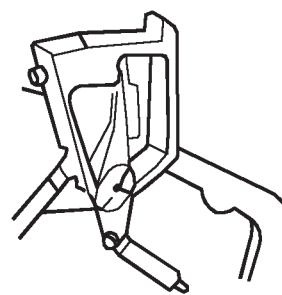

SAFE/ARMED HANDLE

Figure 17-3. Ejection Procedures (Sheet 13 of 24)

SJU-17 SEAT SYSTEMS (CONTINUED)

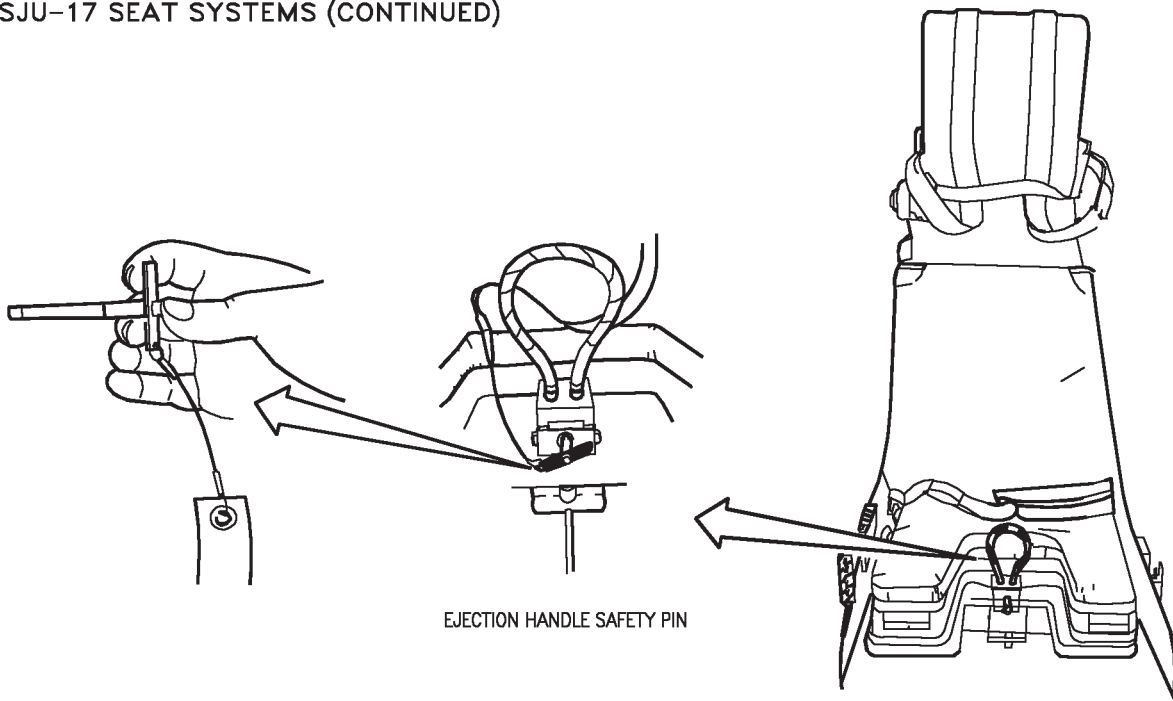

18AC-NFM-00-(147-3)31-CATI

Figure 17-3. Ejection Procedures (Sheet 14 of 24)

SJU-17 SEAT SYSTEMS (CONTINUED)
EJECTION PREPARATION

IMMEDIATE EJECTION

For extreme emergency situations, pilot shall immediately initiate ejection.

CONTROLLED EJECTION

If time and conditions permit –

1. Alert crewmember (F/A-18D only).
2. Command selector valve-Rear crewmember check for appropriate position (F/A-18D only).

WARNING

- SOLO mode shall NOT be selected when both seats are occupied. If SOLO mode is selected when both seats are occupied, simultaneous ejection initiation may result in a collision between seats.
- In the F/A-18B/D aircraft flying with two aircrew, it is important for both aircrew to initiate ejection with the ejection control handles. This will assure ejection of both aircrew in the event of an aircraft sequencing system failure, and will not alter the seat timing sequence if there is no sequencing system failure.
 3. Trade airspeed for altitude (zoom).
 4. Level wings and minimize rate of descent.
 5. IFF – Squawk EMERGENCY.
 6. Follow radio distress procedures.
 7. Stow loose equipment.
 8. Cabin pressure switch – RAM/DUMP.
 9. Shoulder harness lock lever – LOCKED.
 10. Lap belt and shoulder harness tight, visor down, helmet secured, oxygen mask tight.
 11. Altimeter – CHECK.

WARNING

Minimum altitudes are dependent upon dive angle, airspeed, and angle of bank. Recommended minimums are 6,000 feet AGL if out-of-control or 2000 feet AGL if in controlled flight.

12. Slow aircraft as much as possible.

WARNING

Do not secure engines. Unsuccessful seat activation may require continued flight to allow alternate ejection method or ditching.

13. Throttles-Idle (airspeed 250 knots or less).

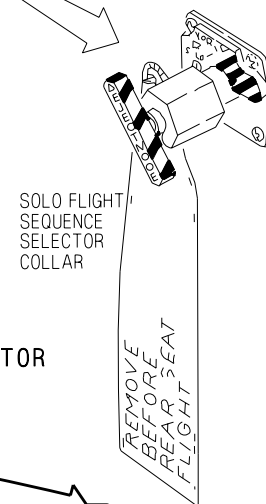
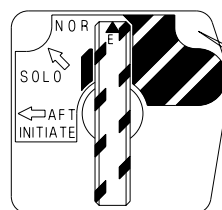
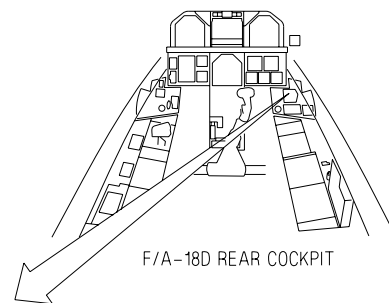

EJECTION MODE SELECTOR

OR

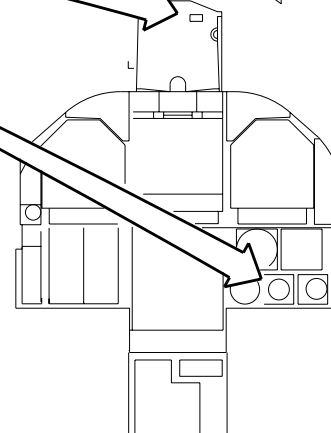

NOTE

Over 14,000 feet, calculate free-fall time to automatic parachute opening altitude.

Figure 17-3. Ejection Procedures (Sheet 15 of 24)

SJU-17 (Continued)**Ejection Preparations****WARNING**

With the Armpit Camera System (ACS) installed, maintain the right elbow and arm close to the body .

EJECTION INJURIES AND BODY POSITIONING

**THESE PROPER BODY POSITIONS
MUST BE TAKEN TO PREVENT INJURIES**

- | | |
|--|---|
| 1. Press head firmly against headrest. | 5. Press buttocks firmly against the seat back. |
| 2. Elevate chin slightly (10°). | 6. Place thighs flat against seat. |
| 3. Press shoulders and back firmly against seat. | 7. Press outside of thighs against side of seat. |
| 4. Hold elbows and arms firmly towards sides. | 8. Place heels firmly on deck, toes on rudder pedals. |

WARNING

If ejection occurs without QDC properly stowed in QMB, death will probably result from neck injury.

EJECTION INITIATION

There are two acceptable methods for ejection initiation; the two-hand grip and the single-hand grip.

Two-hand method -

1. Grip the ejection handle with the thumb and at least two fingers of each hand, palms toward body.
Keep elbows close to body.

Single-hand method -

1. Grip handle with the strong hand, palms toward body. Grip wrist at strong hand with other hand, palm toward body. Keep elbows close to body.

Both methods -

2. Pull handle sharply up and toward abdomen, keeping elbows in. Ensure handle pulled to end of travel.
Continue holding handle until seat/man separation.

NOTE

In low altitude situations, a one-handed method, using one hand to initiate ejection and the other to maintain the aircraft in the safe operating envelope of the ejection seat, may be required. If firing the seat by this method, particular attention must be paid to maintaining proper body position.

Figure 17-3. Ejection Procedures (Sheet 16 of 24)

SJU-17 SEAT SYSTEMS (CONTINUED)
AUTOMATIC SEAT/MAN SEPARATION

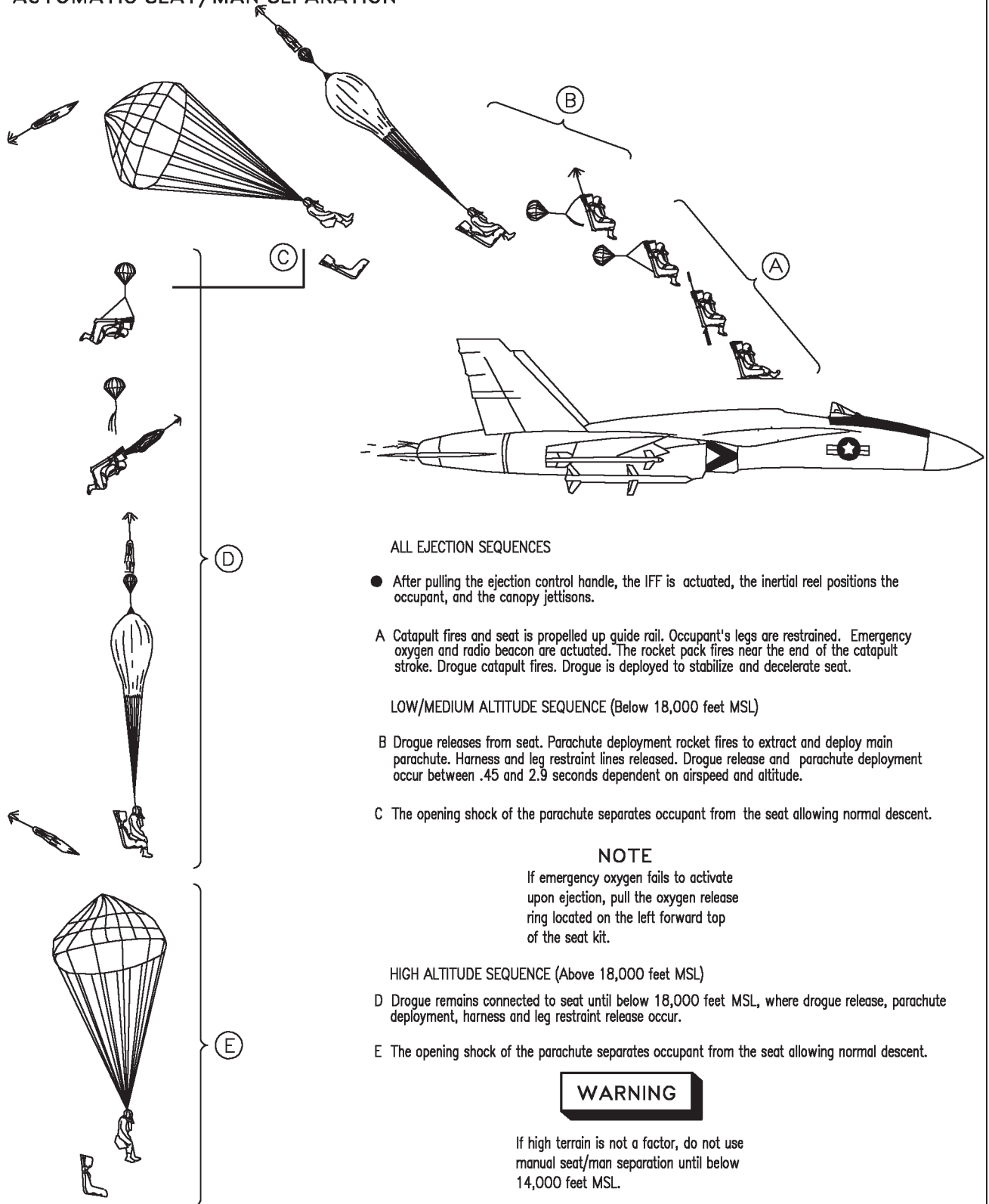

18AC-NFM-00-(147-6)31-CATI

Figure 17-3. Ejection Procedures (Sheet 17 of 24)

SJU-17 SEAT SYSTEM (CONTINUED)

MANUAL SEAT/MAN SEPARATION

If below 14,000 feet MSL and automatic seat/man separation fails to occur:

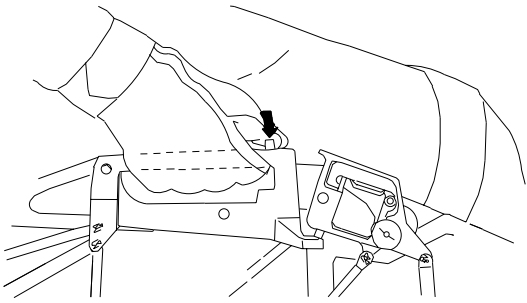

1. Locate manual override handle on right side of ejection seat. Depress handle release button and . . .

The following occurs when the handle is actuated:

- Manual override initiator cartridge fires to activate the parachute deployment rocket motor.
- All occupant-to-seat restraints are released.

WARNING

The barostat mechanism operates as a function of altitude above mean sea level. If ejecting over high altitude terrain, manual seat/man separation may be required to provide adequate altitude for the main parachute to open.

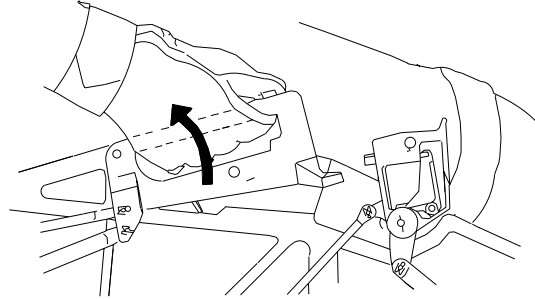

2. Rotate handle up and aft.

- The opening shock of the parachute separates occupant from the seat allowing normal descent.

BAILOUT

There are no provisions for manual bailout.

POST EJECTION PROCEDURES

LPU INFLATION

WARNING

Although an automatic inflation device is designed to inflate the LPU automatically upon water contact, manual inflation of the LPU remains the primary mode of actuation. Automatic actuation is intended for disabled or unconscious survivors or if there is insufficient time to manually activate the LPU.

NOTE

The procedures outlined apply to overland or overwater ejections.

1. Immediately following parachute opening shock, check the condition of the parachute canopy. If no damage/malfunction has occurred ...
2. Locate beaded handles on LPU.
3. Pull beaded handles down and straight out to infla
4. Squeeze LPU waist lobes together to help release veon collar lobe or manually release velcro on collar, if necessary, to achieve complete collar lobe inflation.
5. Snap waist lobes together. (optional procedure)

WARNING

Failure to snap waist lobes before water entry may result in face down flotation.

**SJU-17 SEAT SYSTEM (CONTINUED)
SEAT KIT DEPLOYMENT**

CAUTION

- Deployment of the seat kit/releasing the raft may create a snag hazard when over trees, power lines, building or "other such objects, and thus may be undesirable in these situations".
- Conducting parachute landings with the seat kit attached may cause injury during landing falls.



1. After inflating the LPU, prepare to deploy the seat kit.

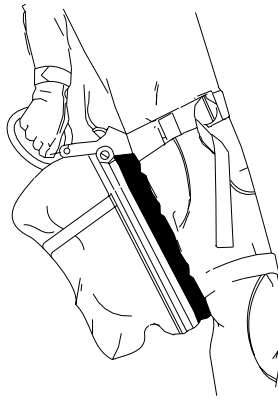

2. Locate either survival kit release handle on the underside of the seat kit.

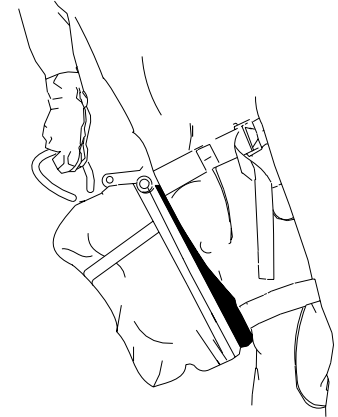

3. Firmly pull up on the survival kit release handle until handle is free of kit and the lower half of seat fall away.

NOTE

- Pulling the survival kit release handle unlocks the container deploying the liferaft and survival kit contents bag which remains attached by a drop line. At full extension of the dropline, the liferaft is automatically inflated with CO₂.
- If the survival kit must be deployed after water entry, a snatch pull on the red manual activation handle, near the CO₂ bottle, is required to inflate the liferaft.

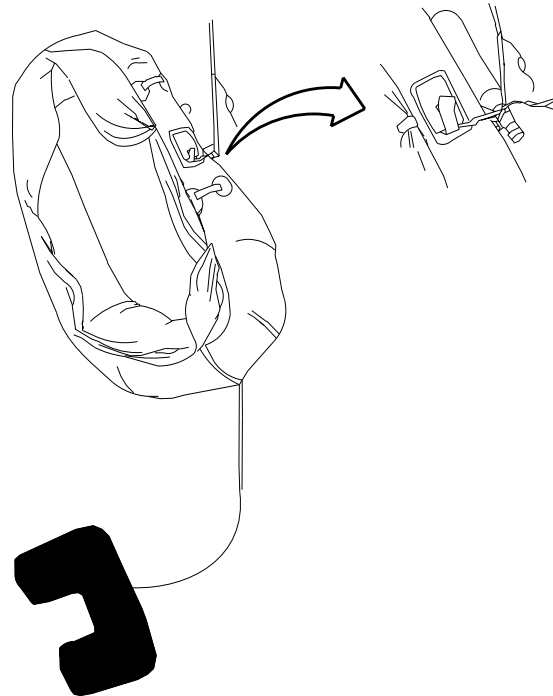

Seat kit deployed with the liferaft fully inflated approximately 17 feet below the upper half of the seat kit container.

Figure 17-3. Ejection Procedures (Sheet 19 of 24)

SJU-17 SEAT SYSTEMS (CONTINUED) PARACHUTE LANDING FALL (PLF) PROCEDURES

Upon toes touching ground surface:

1. Arch side of body in direction of fall.
2. Contact ground at five points of body contact:
 - a. Balls of feet.
 - b. Calf.
 - c. Thigh.
 - d. Buttocks.
 - e. Upper back.
3. Release parachute fittings.

RAFT BOARDING

When clear of the parachute canopy, retrieve the LRU-23/P life raft by locating the dropline and pulling the raft to you.

1. Locate and remove the raft retaining lanyard from its pocket just above the CO₂ cylinder.

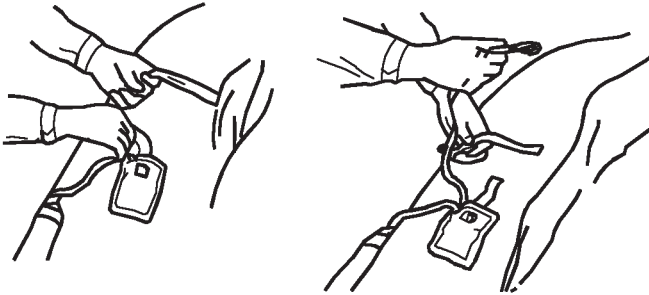

NOTE

Ensure that raft retaining lanyard is securely attached and oxygen hose has been disconnected from seat kit (if not previously accomplished) before releasing seat lid.

2. Attach the snaphook to gated helo-hoist lift ring.
3. Locate the quick-release fitting and release seat lid.
4. Bring raft around for entry into smaller end (stern).
5. Grasp stern and forcibly push under LPU waist lobes.
6. Using boarding handles, pull into raft and turn toward a seated position.
7. Locate the sea anchor and deploy it.
8. Retrieve survival kit.



NOTE

- The AN/URT-33A is not secured and once removed from the seat lid, care must be taken to prevent its loss.
- The AN/URT-33A has a retrieval lanyard secured to it with rubber bands. Attach the lanyard to a suitable place on survival equipment. Then remove the AN/URT-33A from its bracket.

9. Retrieve seat lid.
10. Remove seat cushion front lid.
11. Locate and retrieve the AN/URT-33A from under the cushion on the left side of the kit lid.
12. Immediately secure survival package to gated helo-hoist lift ring.

18AC-NFM-00-(147-9)31-SCAN

Figure 17-3. Ejection Procedures (Sheet 20 of 24)

PARACHUTE STEERING



Pull down on left or right lanyard to steer in desired direction.

LANDING PREPARATION OVER WATER

Try to determine the wind direction at the surface using white caps, smoke from the wreckage, or known surface winds in the vicinity. Note that the winds at the surface may be quite different from those encountered at altitude.

When nearing the surface, maneuver the parachute so that you are facing into the wind. Then assume the proper body position for landing:

- Feet together.
- Knees slightly bent.
- Toes pointed slightly downward.
- Eyes on the Horizon.
- Firmly grasp canopy release fittings.
- Tuck elbows in prior to water entry.

LANDING PREPARATION OVER LAND

Perform the same procedures as for over water, but with the following exceptions:

1. Visor – down.
2. Gloves – on
3. Do NOT deploy seat kit.

WARNING

- If a parachute landing is made into the water or a high wind prevents normal spilling of the parachute canopy, disconnect both quick-release fittings that attach risers to the torso-harness suit, thus jettisoning the parachute canopy.
- Do not disconnect the quick-release fittings until after contact with ground or water.

RESCUE

If survivor pickup is to be effected by rescue helicopter, the following procedures should be followed: (Unassisted rescue – no swimmer deployed)

1. Stow or discard loose gear, roll out of raft on right side (side with CO₂ cylinder).
2. Swim away from raft. Ensure that helmet visor has been lowered.
3. Remove raft retention lanyard after rescue device has been lowered.

WARNING

- To allow discharge of static electricity and prevent electrical shock, avoid touching rescue device until it has made contact with water/ground.
- To avoid severe injury, keep hands clear of hook and ring assemblies during hoisting.
- Under no circumstances should survivors attempt to assist their entrance into helicopter or move from the rescue device until helicopter aircrewman assists them to a seat in the aircraft.

PROCEDURES FOR USE OF THE RESCUE HOOK

1. Attach large hook to gated helo-hoist lift ring.
2. Cross arms in front of chest and place head down and to the left. Give thumbs-up signal to helo-hoist operator.

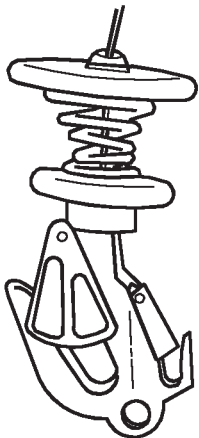

NOTE

The helo rescue hook has a small and large hook. The large hook is the primary hook for hoisting personnel.

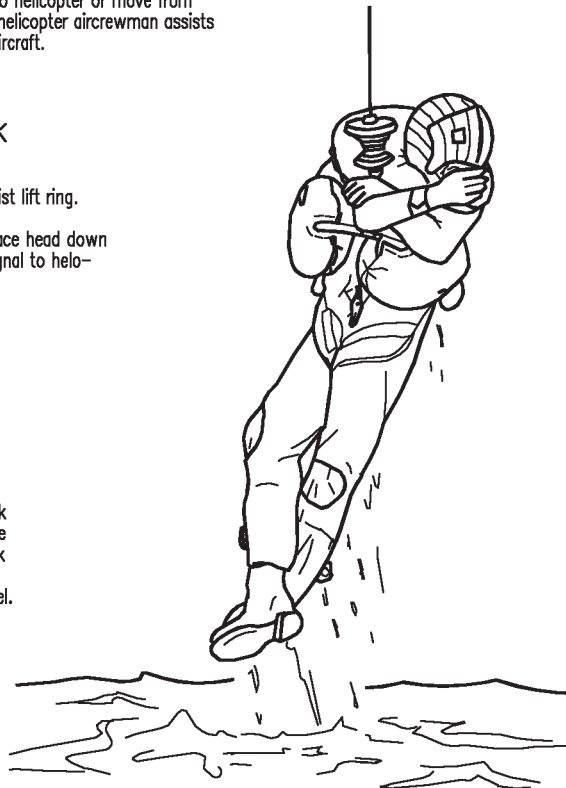

3. Position of aircrewman during helo-hoist. Upon clearing ground/water, cross feet.

18AC-NFM-00-(70-13)31-SCAN

Figure 17-3. Ejection Procedures (Sheet 22 of 24)

PROCEDURES FOR USE OF THE RESCUE STROP (HORSECOLLAR)

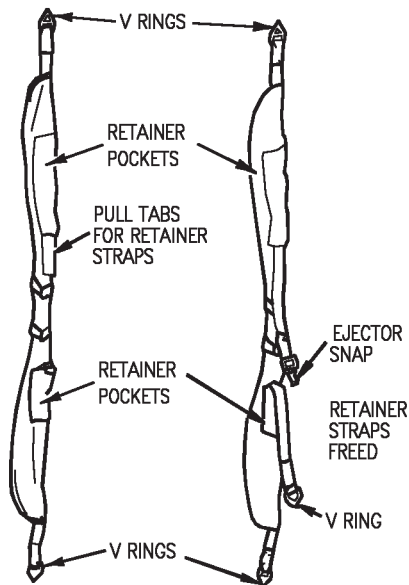

1. Grasp free end of rescue strop.
2. Swim in a circle toward rescue hook completely encircling body with rescue strop.

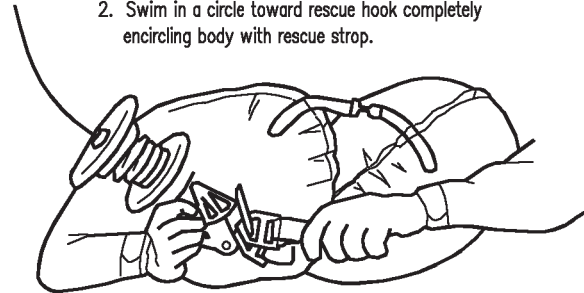

3. Attach free end of strop to large hook.

4. Pull both retainer straps free and connect ejector snap to V-ring of other retainer strap. Pull tight.
5. Ensure rescue strop is above PRU waist lobes and high on back. Wrap arms around strop and place hands in armpits. Keep head down, and give thumbs up signal to helo-hoist operator.

6. Position of aircrewman during hoist. Upon clearing water, cross feet.

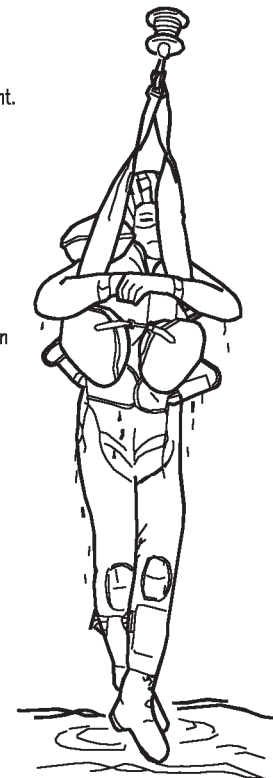
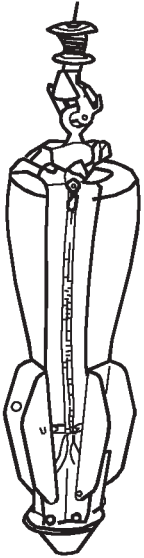
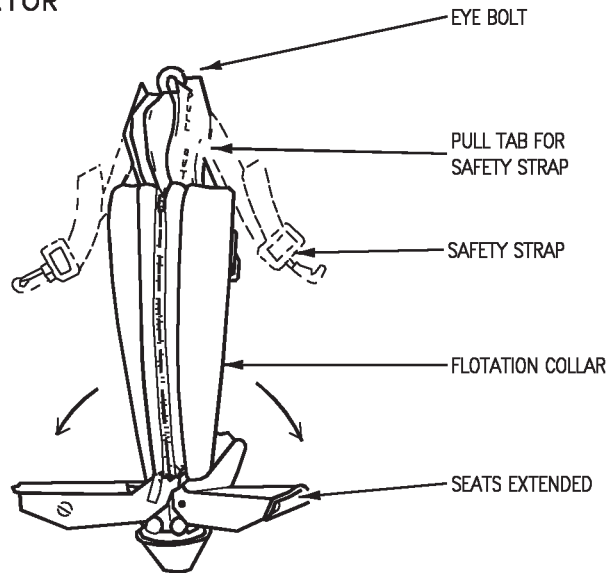

Figure 17-3. Ejection Procedures (Sheet 23 of 24)

PROCEDURES FOR USE OF THE FOREST PENETRATOR



Forest penetrator with flotation collar and seats retracted (safety straps omitted to show connection of rescue hook to eye-bolt).



Forest penetrator with flotation collar and seats extended.

1. Unsnap LPU waist lobes.
2. Extend only one seat on forest penetrator.
3. Sit on seat facing flotation collar. Using elbows, separate LPU waist lobes and pull shaft of penetrator close to chest.
4. Pass safety strap under arm around back, and under other arm. Connect safety strap and tighten.
5. Turn head down and to the left. Give thumbs up signal to helo-hoist operator.



6. Upon clearing water, cross feet.

18AC-NFM-00-(70-15)31-SCAN

Figure 17-3. Ejection Procedures (Sheet 24 of 24)

WARNING

The aircraft should be ditched only when ejection has failed.

DUTIES BEFORE IMPACT

- | | |
|-------------------------------|--|
| 1. Make radio distress call. | 8. Oxygen mask - TIGHTEN |
| 2. IFF - EMERGENCY | 9. Lower seat, assume position for ditching (feet on rudder pedals, knees flexed). |
| 3. External stores - JETTISON | 10. Shoulder harness - LOCK |
| 4. Landing gear - UP | 11. Canopy - JETTISON |
| 5. Flaps - DOWN | 12. Fly parallel to swell pattern. |
| 6. Arresting hook - DOWN | 13. Attempt to touch down along wave crest. |
| 7. Visor - DOWN | 14. Throttles - OFF BEFORE IMPACT |

DUTIES AFTER IMPACT

1. Manual override handle - PRESS BUTTON AND ROTATE AFT AND UP
2. Shoulder harness - RELEASE
3. Emergency oxygen - ACTIVATE

NOTE

- The emergency oxygen will actuate when the crewmember stands up. However, to avoid the time delay resulting from the distance required for the emergency oxygen actuation cable to travel to reach "cable stretch", the emergency oxygen should be activated prior to manually egressing with the SKU-3/A or SKU-7/A seat kit attached.
 - In the event of under water egress, it is possible to survive underwater with oxygen equipment until escape can be made.
4. Stand straight up without twisting to release survival kit sticker clips from the seat.

WARNING

If the cockpit has flooded, the LPU may have inflated due to the FLU-8 water activated automatic inflation device. If so, care must be taken during exit to avoid catching the lobes causing entanglement or LPU damage.

5. Abandon aircraft.
6. If the LPU has not automatically inflated - INFLATE
7. Deploy survival kit and inflate liferaft.

WARNING

If aircraft is abandoned under water, exhale while ascending to the surface to prevent bursting of lungs due to pressure differential between lungs and outside of body.

Figure 17-4. Ditching

CHAPTER 18

Immediate Action

18.1 GENERAL

This part contains only immediate action items. It is intended for review only and does not contain any steps which are not immediate action nor does it contain notes, cautions, warnings, or explanatory matter associated with particular procedures.

18.2 APU FIRE LIGHT

INFLIGHT or on GROUND

- *1. APU FIRE light - PUSH
- *2. FIRE EXTGHD READY light - PUSH

GROUND

- *3. Throttles - OFF

18.3 DUAL L BLEED and R BLEED WARNING LIGHTS / L/R ATS CAUTION / DUAL L/R BLD OFF CAUTION

IN FLIGHT

- *1. Throttles - Minimum practical

OBOGS Aircraft -

- *2. Emergency oxygen green ring(s) - PULL

All Aircraft -

- *3. BLEED AIR knob - OFF (DO NOT CYCLE)
- *4. Initiate rapid descent to below 10,000 feet cabin altitude.

18.4 SINGLE L BLEED or R BLEED WARNING LIGHT

IN FLIGHT

- *1. Throttle affected engine - IDLE
- *2. BLEED AIR knob - L OFF or R OFF (DO NOT CYCLE)

If light still on, do the following in order until light goes out -

- *3. Throttle affected engine - OFF

OBOGS Aircraft -

- *4. Emergency oxygen green ring(s) - PULL

All Aircraft -

- *5. BLEED AIR knob - OFF (DO NOT CYCLE)
- *6. Initiate rapid descent to below 10,000 feet cabin altitude.

18.5 FIRE LIGHT

GROUND

- *1. Throttles - OFF
- *2. FIRE light affected engine - PUSH
- *3. FIRE EXTGH READY light - PUSH

INFLIGHT

Dual FIRE lights -

- *1. Throttles - Minimum practical

Single FIRE light or Dual when side confirmed -

- *2. Throttle affected engine - OFF
- *3. FIRE light affected engine - PUSH
- *4. FIRE EXTGH READY light - PUSH
- *5. HOOK handle - DOWN

18.6 ENGINE CAUTIONS/ ENGINE STALL

L/R EGT HIGH, L/R FLAMEOUT, L/R IN TEMP, L/R OIL PR,
L/R OVRSPD, and L/R STALL

- *1. Throttle affected engine - IDLE

18.7 OBOGS DEGD CAUTION

INFLIGHT

- *1. Emergency oxygen green ring(s) - PULL
- *2. OXY FLOW knob(s) - OFF
- *3. Initiate rapid descent to below 10,000 feet cabin altitude.

18.8 FLIGHT CONTROL CAUTIONS

DEL ON, MECH ON

- *1. Speedbrake - CHECK IN
- *2. Decelerate slowly to below 400 knots/Mach 0.8.

18.9 FLAPS OFF CAUTION

- *1. Maintain airspeed above 300 KCAS and wings level.

18.10 HOT START

If EGT climbs rapidly through 750°C -

- *1. Throttle affected engine - OFF

18.11 BRAKE FAILURE/EMERGENCY BRAKES

If detected after touchdown and flyaway airspeed available -

- *1. Go Around.

If brake failure occurs at slow speed or flyaway airspeed not available -

- *1. Brakes - RELEASE
- *2. EMERG BRK handle - PULL TO DETENT
- *3. Brakes - APPLY gradually

18.12 EMERGENCY CATAPULT FLYAWAY

If flyaway airspeed available -

- *1. Throttles - MAX
- *2. Rudder pedal - FULL AGAINST YAW/ROLL
- *3. EMERG JETT button - PUSH
- *4. Maintain 10° pitch attitude with ∇ symbol.
 - Do not exceed half lateral stick.

If unable to arrest yaw/roll or stop settle -

- *5. Eject.

18.13 ABORT

- *1. Throttles - IDLE
- *2. Speedbrake - AS DESIRED

- *3. Brakes - APPLY
- *4. Stick - AFT below 100 knots (if required)
- *5. HOOK handle - DOWN (if required)

18.14 LOSS OF DIRECTIONAL CONTROL DURING TAKEOFF OR LANDING (BLOWN TIRE, NWS FAILURE) / PLANING LINK FAILURE

If detected after touchdown and flyaway airspeed available -

- *1. Go Around.

If flyaway airspeed not available -

- *1. Select emergency brakes (if appropriate)
- *2. HOOK handle - DOWN (if required)

18.15 DOUBLE GENERATOR OR DOUBLE TRANSFORMER - RECTIFIER FAILURE

If BATT SW caution light not on -

- *1. BATT switch - ORIDE

18.16 HYPOXIA/LOW MASK FLOW/NO MASK FLOW

- *1. Emergency oxygen green ring(s) - PULL
- *2. OXY FLOW knob(s) or OXYGEN supply lever(s) - OFF
- *3. Initiate rapid descent to below 10,000 feet cabin altitude.

18.17 COCKPIT SMOKE, FUMES, OR FIRE

OBOGS Aircraft -

- *1. Emergency oxygen green ring(s) - PULL
- *2. OXY FLOW knob(s) - OFF

All Aircraft -

- *3. Initiate rapid descent to below 10,000 feet cabin altitude.
- *4. CABIN PRESS switch - RAM/DUMP
- *5. CABIN TEMP knob - FULL COUNTERCLOCKWISE

18.18 LOSS OF CABIN PRESSURIZATION

OBOGS Aircraft -

- *1. Emergency oxygen green ring(s) - PULL
- *2. OXY FLOW knob(s) - OFF

SEE IC # 91

All Aircraft -

- *3. Initiate rapid descent to below 10,000 feet cabin altitude.

18.19 CABIN CAUTION LIGHT

BELOW 47,000 FEET MSL

OBOGS Aircraft -

- *1. Emergency oxygen green ring(s) - PULL
- *2. OXY FLOW knob(s) - OFF

All Aircraft -

- *3. Initiate rapid descent to below 10,000 feet cabin altitude.

18.20 OCF RECOVERY

- *1. Controls - RELEASE, FEET OFF RUDDERS, SPEEDBRAKE IN

If still out of control -

- *2. Throttles - IDLE
- *3. Altitude, AOA, airspeed and yaw rate - CHECK

If command arrow present -

- *4. Lateral stick - FULL WITH ARROW

When command arrow removed -

- *5. Lateral stick - SMOOTHLY NEUTRAL

When recovery indicated by AOA and yaw rate tones removed, side forces subsided, and airspeed accelerating above 180 KCAS -

- *6. Recover.

Passing 6,000 feet AGL, dive recovery not initiated -

- *7. Eject.

18.21 SINGLE ENGINE FAILURE IN LANDING CONFIGURATION

- *1. Throttles - MIL or MAX
- *2. FLAP switch - HALF
- *3. Maintain on-speed AOA and balanced flight.

PART VI

ALL WEATHER PROCEDURES

Chapter 19 - Instrument Flight

Chapter 20 - Extreme Weather Procedures

Chapter 21 - Hot Weather Procedures

Chapter 22 - Cold Weather Procedures

CHAPTER 19

Instrument Flight

19.1 INSTRUMENT FLIGHT

19.1.1 Before Takeoff. Thoroughly check flight instruments (primary and standby) and navigation equipment before takeoff. Cycle HUD attitude switch to STBY (note standby attitude reference display) and back to AUTO.

If icing conditions may be encountered, perform engine anti-ice detector test. If a climb through icing conditions is anticipated, place engine anti-ice and pitot switches ON.

19.1.2 In Flight. Frequently crosscheck primary and standby instruments. A slowly flashing velocity vector indicates the INS is still providing valid attitude information from the Attitude Heading Reference System (AHRS) mode, but ADC is now the data source for the velocity vector.

19.1.3 Approaches

19.1.3.1 Descent. Enroute descent should be flown at 250 knots, idle power.

19.1.3.2 Holding. Fly the holding pattern as directed/depicted and maintain 220 to 240 knots for maximum endurance at 15,000 to 20,000 feet. Total fuel flow is approximately 3,600 pph (60 pounds/minute).

19.1.3.3 Non-Precision. The navigation aids available provide excellent position keeping capability, multiple redundancy and steering cues. INS offset data can be used to provide accurate steering to a tacan IAF and the course select option can be used to obtain a visual reference on the HSI and steering cues on the HUD.

Penetration should be flown at 250 knots, 75 % RPM and speedbrake as required. Dirty up at 10 nm from touch down. Plan for 800 pounds of fuel required to fly from the IAF to landing for a typical CV tacan approach from 20,000 feet. Use of HALF flaps reduces fuel flow and increases approach speed 7 to 9 knots.

19.1.3.4 Precision. The downwind leg should be flown at 230 to 250 knots with gear UP and flaps AUTO. Transition to the landing configuration when directed or no later than 6 nm from touch down. To begin descent, lower the velocity vector to approximately -3° and maintain ON-SPEED AOA. Small changes in velocity vector placement can be used to control glidepath. Set radar altimeter at decision height and be prepared for missed approach.

19.2 DEGRADED SYSTEMS

If the INS built-in test detects a malfunction in the INS processor that prevents inertial navigation, the ASN-130 INS automatically reverts to the AHRS mode which provides unfiltered attitude data

to the mission computer. The AHRS mode can also be selected by placing the INS switch to GYRO.

WARNING

- When operating in AHRS mode at night or in IMC, avoid unnecessary high-G maneuvering flight. AHRS attitude should be frequently crosschecked with the standby attitude indicator, altimeter and magnetic compass.
- In the NAV mode, no indication of a slowly degrading INS is provided to the pilot other than increasing velocity errors. If there is an abnormally high velocity change, INS derived attitude should be carefully monitored.

If the INS built-in-test detects a malfunction in the INS processor that prevents inertial navigation, the ASN-139 INS and EGI INS automatically revert to standby attitude reference indicator. If the INS fails, the standby attitude reference should be selected with the HUD attitude switch.

CHAPTER 20

Extreme Weather Procedures

20.1 ICE AND RAIN

WARNING

In freezing conditions, water draining from beneath the left engine inlet can be drawn into the intake and freeze creating a potential ice FOD danger. This situation is most likely at temperatures near freezing with a dew point temp/freezing temp spread of less than 8°.

Before flight, check with the weather service for freezing level and probable icing areas. Flight through known or suspected icing conditions should be avoided, if possible, to prevent engine FOD from ice ingestion.

Prolonged flight in icing conditions is an emergency situation. Flight duration which allows a noticeable accumulation of ice (more than 3/8 inch) on the wing leading edge flaps constitutes prolonged flight. Ice will rapidly form on the inlet lip and, if allowed to accumulate, can be drawn into the engine causing compressor stall and major FOD. Severe icing conditions can result in rapid ice accumulation in a very short time. More than 1/2 inch of ice can form on the inlet lip in 8 minutes in light to moderate icing conditions. Ice from the inlet lip has been ingested by the engine while at 92 % rpm and in a steady state 24° bank resulting in compressor stall. At lower power settings, similar inlet ice has shed harmlessly overboard. An INLET ICE caution should serve as a warning to take immediate action to avoid further ice accumulation.

If icing is anticipated -

1. ENG ANTI ICE switch - ON (after engine start)
 - Verify LHEAT and RHEAT advisories present

NOTE

On deck with engines at ground idle, LHEAT/RHEAT advisory may not be present. Re-attempt check at 70 % RPM. If advisories not present maintenance action is required.

2. ENG ANTI ICE switch - TEST
 - Verify INLET ICE advisory present

20.1.1 Ground Operation

If visible moisture exists (rain, fog) and the temperature is 45°F (7°C) or less -

1. ENG ANTI ICE switch - ON (after engine start)
 - Verify LHEAT and RHEAT advisories present

NOTE

On deck with engines at ground idle, LHEAT/RHEAT advisory may not be present. Re-attempt check at 70% RPM. If advisories not present maintenance action is required.

2. PITOT ANTI ICE switch - ON (after taxi but prior to takeoff)

If an INLET ICE caution appears prior to takeoff -

3. Do not takeoff. Return to the line and have the engines inspected for possible FOD.

20.1.2 In Flight

1. ENG ANTI ICE switch - ON
2. PITOT ANTI ICE switch - ON
3. Adjust airspeed to provide at least +5°C (+10°C preferred) INLET TEMP on the DDI engine display.

If INLET TEMP of at least +5°C not possible -

4. Climb or descend out of icing danger zone (see figure 20-1). Monitor INLET TEMP and Mach. If time and fuel permit, climb to a safe altitude. Altitudes above about 25,000 feet or ambient temperatures below -30°C will generally prevent icing since the water droplets are frozen and will not adhere. Descend only if you are sure that ambient temperature is well above freezing at a safe altitude below.

If penetration into known icing conditions is unavoidable -

5. Adjust airspeed to provide at least +5°C (+10°C preferred) INLET TEMP on the DDI engine display.
6. Maintain less than 6° AOA, if possible. This reduces LEX ice accumulation.
7. Enter the cloud at the last possible moment and descend rapidly.
8. WINDSHIELD ANTI ICE/RAIN switch - AS REQUIRED
The ANTI-ICE position should be used as required to clear the windshield.



Do not operate the anti-ice system on a dry windshield. Place the windshield anti-ice/rain switch OFF immediately if a WDSHLD HOT caution appears.

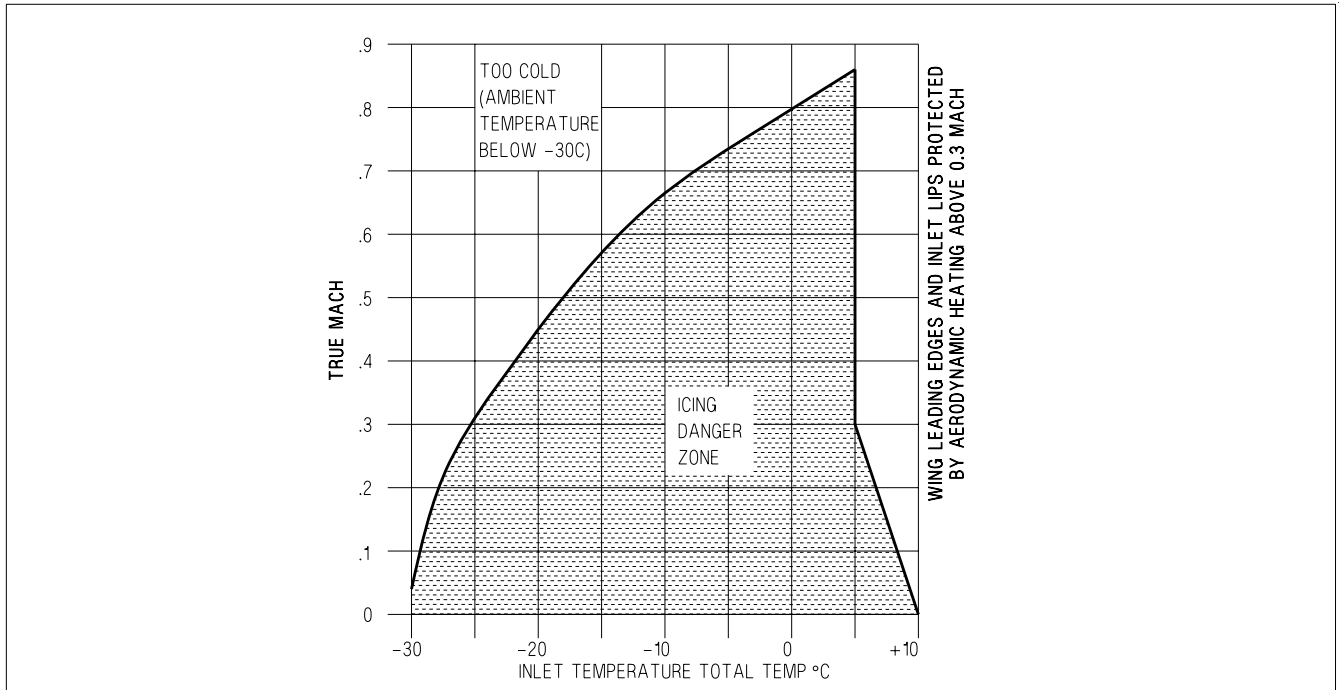

ADA520-71-1-045

Figure 20-1. Icing Danger Zone

If at least +5°C INLET TEMP cannot be maintained and/or ice accumulation visible on leading edge flaps -

9. Make a straight-in approach at 250 knots with throttles stabilized below 80 % rpm (if possible). Avoid throttle transients above 90 % rpm.
10. Avoid abrupt maneuvers and bank angles over 20°.
11. Reduce airspeed and transition to landing configuration at the last possible moment. This will minimize gear ice.

If missed approach necessary -

12. Slowly advance throttle to minimum power required for safe waveoff and raise gear and flaps as soon as possible.

Report all icing encounters on VIDS MAF and ensure engine is inspected for FOD before next flight.

If landing in heavy rain -

13. WINDSHIELD ANTI ICE/RAIN - RAIN
Do not operate rain removal on a dry windshield. Turn rain removal OFF immediately after landing or if WDSHLD HOT caution is displayed.
14. Reduce gross weight to minimum practical.
15. ANTI-SKID switch - ON
16. Land ON-SPEED.

If directional control problems occur after touchdown -

17. Make arrested landing if possible.

20.2 TURBULENT AIR AND THUNDERSTORM OPERATION

Avoid flight through thunderstorms and microbursts. The radar MAP mode can be used to detect storm cells. If penetration must be made, fly at optimum cruise airspeed but not less than 250 knots if above 35,000 feet.

CHAPTER 21

Hot Weather Procedures

21.1 BEFORE TAKEOFF

During ground operations all non-essential electronic equipment (radar, tacan, IFF, etc.) should be OFF until just prior to takeoff. To increase cockpit and avionics cooling when the ambient temperature is greater than 103° F, consider increasing the throttle setting above idle power or at ground idle, using the APU in AUG pull mode to supply bleed air to the ECS.



On aircraft 161353 THRU 163175 BEFORE IAYC 853, to minimize potential of APU damage due to surging, use bleed air AUG only when absolutely necessary to maintain cooling.

Calculate the effect of temperature and altitude (density ratio) on takeoff and abort performance. On aircraft THRU 161519 WITHOUT AFC 021 calculate minimum fuel for landing with the following formula: Add 90 pounds per °C (50 pounds per °F) above 21°C (70°F) to 1,500 pounds.

21.2 IN FLIGHT

Low altitude flight with less than 4,000 pounds fuel remaining may cause the AMAD to overheat. Monitor fuel temperature in flight and, if temperature exceeds 75°C, land as soon as practical to prevent loss of AMAD(s) and generator(s). Extended low altitude high speed flight in ambient conditions above 103°F may cause bleed air system overheat and shutdown. Refer to part 5.

21.3 DESCENT

When descending into warm humid conditions, abrupt canopy fogging can occur. To prevent this condition, move the defog handle to HIGH before descent.

Turn non-essential electrical equipment OFF before entering the landing pattern.

21.4 AFTER LANDING

Immediately turn avionics equipment OFF. Ground operating time can be extended by shutting down the left engine. After shutdown, leave the canopy open during the day to ventilate the cockpit if blowing sand or dust is not a factor.

CHAPTER 22

Cold Weather Procedures

22.1 EXTERIOR INSPECTION

If the aircraft has not flown within 4 hours, pay particular attention to the condition of the APU and brake accumulator pressures, nosewheel oleo pressure, and possible fuel leaks near the AMAD bays and along the inner lower wing roots.

22.2 BEFORE ENTERING COCKPIT

If APU start is anticipated, use the external canopy crank to raise the canopy, if possible, to conserve battery power.

22.3 INTERIOR CHECK

Leave the canopy open until the right engine has been started to permit rapid emergency egress.

If the aircraft has been cold soaked below -18°C (0°F), rudder pedal adjustment will be difficult or impossible and the inertia reel will not retract automatically until the cockpit warms up (5-10 minutes).

22.4 ENGINE START

APU starts can be successful if the UBATT voltage is at least 20.5 volts and the APU accumulator is fully charged. Heat may have to be applied to the accumulator pump piston area to ensure proper piston sealing and effective pumping.

For ambient temperatures below -23°C (-10°F), a deviation from normal crossbleed start procedures is preferred. Operating engine fuel flow should be set to at least 1,900 PPH (72% -75% rpm). Using this procedure, it may take 5 seconds longer to start.

Avoid activating any hydraulic actuated system for 2 minutes after both engines are on line. This allows hydraulic fluid to warm both systems, preventing hydraulic leaks.

22.5 BEFORE TAXI

Maintain at least 70% rpm. Turn pitot and engine anti-ice ON.

If the aircraft has not flown within 4 hours with ambient temperature below -18°C (0°F), up to three selections of the FCS exerciser mode may be required in order to obtain a successful FCS RESET after initial warmup.

With engine anti-ice ON, ECS air flow may be low enough to cause an AVAIR HOT caution. Increase rpm to increase air flow.

For cold weather operations below -18°C (0°F), three arresting hook cycles should be performed to bring extension time within specification.

22.5.1 Aircraft 164196 THRU 164912 BEFORE AFC 216. During cold weather operations, proper operation of the OBOGS monitor may not occur until after 15 minutes of warm up.

22.6 TAKEOFF

If snow or slush has accumulated, leave gear down for 1 minute after takeoff to clear snow or slush from the landing gear.

Very slow main landing gear retraction should be expected (about 30 seconds) following cold soak below -18°C (0°F). Carefully monitor gear uplock signals and, if possible, request visual verification.

PART VII

COMM-NAV EQUIPMENT AND PROCEDURES

Chapter 23 - Communications-Identification Equipment

Chapter 24 - Navigation Equipment

Chapter 25 - Backup/Degraded Operations

Chapter 26 - Visual Communications

Chapter 27 - Deck Ground Handling Signals

CHAPTER 23

Communication-Identification Equipment

23.1 INTERCOM SYSTEM

The intercom system (ICS) provides amplification and distribution of all voice communications, voice alerts and tones originating within the ICS and advisory tones originating external to the ICS. Intercommunications between the pilot and ground crew are also provided by the intercom system via an external panel on the right side of the aircraft. A volume control on the external panel is provided for adjusting audio volume to the ground crew headset.

23.1.1 Volume Control Before AFC 268. Six volume controls are provided to control pilot headset volume for (1) TACAN ident, (2) transmit sidetone/aircrew intercom audio/ground crew intercom audio, (3) RWR audio, (4) WPN delivery audio, (5) AUX 2 (formally ECM audio), and (6) auxiliary audio (available for other uses). Additional functions performed by the ICS are (1) control of comm 1 and comm 2 plain/cipher text mode, (2) comm 1, comm 2 guard channel transmit, (3) control/zeroize of IFF crypto code, (4) IFF Mode 4 control (visual and audible indications of interrogations) and, (5) IFF master switch for normal/emergency operation.

23.1.2 Volume Control After AFC 268. Eight volume controls are provided to control pilot headset volume for (1) voice activated intercom (VOX), (2) transmit sidetone/aircrew intercom audio/ground crew intercom audio, (3) MIDS A audio, (4) MIDS B audio, (5) RWR audio, (6) WPN delivery audio, (7) TACAN ident, and (8) auxiliary audio (available for other uses).

23.2 VHF/UHF AND MIDS COMMUNICATION SYSTEM

The aircraft has two voice communication radios which can be either two ARC-182, two ARC-210(RT-1556), one of each, or one ARC-210(RT-1556) and F/A-18C/D AFTER AFC 269 one ARC 210 DCS (Digital Communication System). The ARC 210 DCS is only installed as a comm 2 radio. The VHF/UHF radios, comm 1 and comm 2, provide air-to-air/air-to-ground voice communications, and in conjunction with Automatic Direction Finding (ADF) equipment, provide a DF function. The radios can be operated in a plain mode, an anti-jam (Have Quick) mode (ARC 210), a secure mode (KY-58 or DCS), and a relay mode, in either normal or secure voice. An additional function is generation of a 1,020 hz tone by either comm 1 or comm 2 that serves as an ident tone for weapon release. With AFC 270, the Multifunctional Information Distribution System (MIDS) is installed. MIDS, a joint service system, provides secure, jam resistant voice and data communications utilizing spread spectrum, frequency-hopping, and error detection/correction techniques. In addition, MIDS provides the functionality of the AN/ARN-118 TACAN.

The comm 1 and comm 2 radios operate in fixed frequency plain, fixed frequency/secure, Electronic Counter-Countermeasure (ECCM), or ECCM/secure mode. Comm 1 and comm 2 radios operate in the frequency bands listed below and, when enabled, integral guard receivers continuously monitor the emergency guard channels for each frequency band:

ARC-182

Frequency Band (MHz)	Modulation	Guard Channel (MHz)
30 to 87.975	FM	40.5
*108 to 155.975	AM	121.5
156 to 173.975	FM	156.8
225 to 399.975	AM/FM	243.0 (AM)

*Cannot transmit on 108 thru 117.975 MHz

ARC-210(RT-1556 and DCS)

Frequency Band (MHz)	Modulation	Guard Channel (MHz)
30 to 87.995	FM	
*108 to 135.995	AM	121.5
136 to 155.995	AM/FM	
156 to 173.995	FM	
225 to 399.975	AM/FM	243.0 (AM)

*Cannot transmit on 108 thru 117.995 MHz

Transmission and reception of amplitude and frequency modulated signals (AM and FM) occur in the respective frequency bands on spaced channels of 100 kHz (aircraft 161353 THRU 161705), 25 kHz (aircraft 161706 AND UP with ARC-182) or 5 kHz (ARC-210). Twenty channels in the 30 to 400 MHz band may be pre-set to assigned frequencies as a convenience in the rapid selection of operating frequencies.

When the Guard receiver (GRCV) is enabled, comm 1 or comm 2 is able to continuously monitor the 243.0 MHz AM Guard frequency while the radio is operating in the UHF band. When the radio is tuned in the VHF band, 121.5 MHz is monitored.

The ECCM modes are Have Quick (HQ) I, II, and Single Channel Ground/Airborne Radio System (SINCGARS). HQ I, an anti-jam (AJ) voice communication system, uses a single Word of Day (WOD) and operates in UHF AM mode using frequency hopping techniques. HQ II is an extension of HQ I operation that has multiple WODs and the capacity to store six multiple WODs. SINCGARS is also a jam-resistant voice communication system that operates in VHF FM mode.

Secure voice operation is accomplished using the KY-58 system or DCS. With the ARC-210 (RT-1556) during secure operation, the radio provides a Baseband/Diphase (BB/DP) control signal to the KY-58 to switch from BB to DP or vice versa. Diphase is the encrypted audio for the VHF/UHF FM mode. With the ARC 210 DCS a secure voice capability is integral and does not require a KY-58 speech encoder.

Comm 1 and comm 2 may be operated in a relay mode, in either normal (plain), secure (cipher), or ECCM operation. In this mode, the voice signal received by one communication set is retransmitted by the other communication set on a different, pre-assigned frequency, provided the two frequencies are spaced a minimum of 10 MHz apart. Cipher relay in Diphase mode is performed if and only if the Diphase option has been enabled for comm 1 or comm 2.

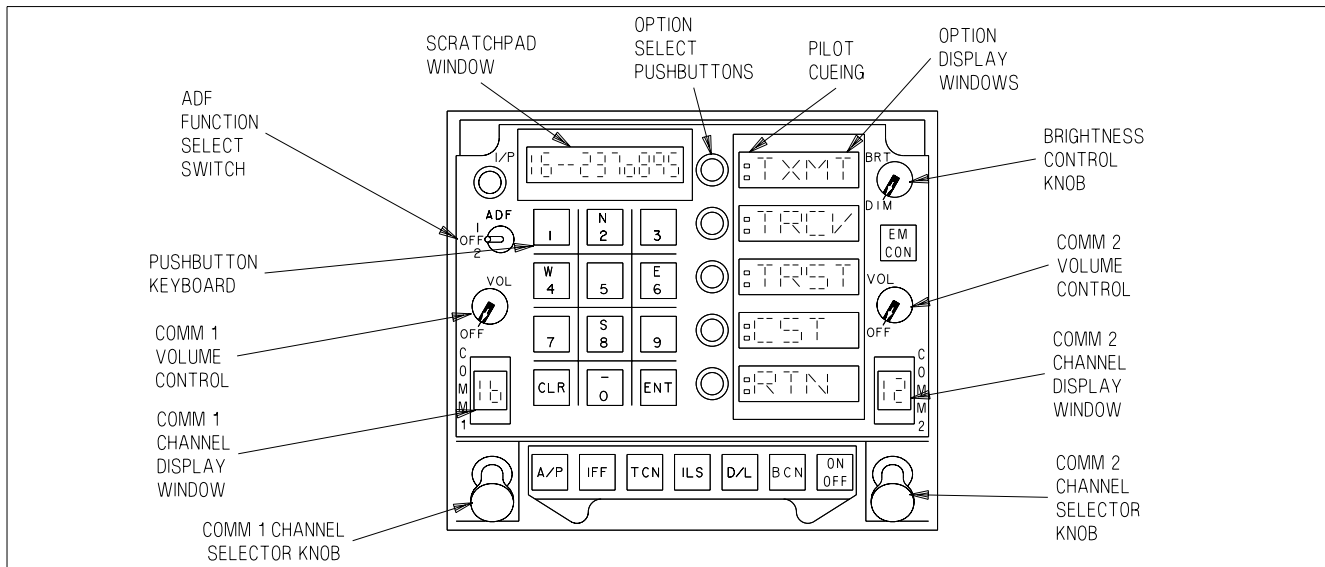

ADA520-332-1-045

Figure 23-1. Upfront Control (UFC)

23.2.1 VHF/UHF/MIDS Controls and Indicators. The comm 1 and comm 2 are operated by (1) off/on and volume controls on the UFC, (2) controls on the ICS, (3) communication switch on the right (inboard) throttle grip, and (4) on aircraft 163986 AND UP in the Night Attack configuration comm 1 and comm 2 switches on the left and right rear cockpit rudder pedals respectively. With AFC 270 MIDS is turned on/off thru the UFC by pressing either TACAN or LINK 16 options, then ON/OFF. On MIDS equipped aircraft the throttle mounted communication switch is a five position push-to-talk switch (MIDS A/MIDS B/COMM 1/COMM 2 corresponding to: FWD/AFT/UP/DN with center position OFF). On MIDS equipped F/A-18D aircraft a PTT panel contains two switches allowing the selection of comm 1 or MIDS A, and comm 2 or MIDS B controlling the operation of the rear cockpit rudder pedal switches.

23.2.1.1 UFC. The UFC (figure 23-1) is located on the main instrument panel immediately below the HUD. Controls on the UFC include (1) Volume controls for comm 1 and comm 2, (2) comm 1 and comm 2 channel select knobs, (3) display windows for comm 1 and comm 2 selected frequencies, (4) select switch for the ADF function, (5) pushbutton keypad and associated scratchpad window, (6) option select pushbuttons, (7) option display windows, and (8) the brightness control knob.

23.2.1.1.1 Comm 1 and Comm 2 Volume Controls. The two volume controls turn ON and adjust the audio volume of the respective comm 1 or comm 2.

23.2.1.1.2 Comm 1 and Comm 2 Channel Selector Knobs. When the comm 1 channel selector knob is pulled, the UFC displays UFC Comm Display which is active for controls of comm 1 functions only. When the comm 1 channel selector knob is rotated clockwise or counterclockwise in normal/non-AJ mode, one of the following modes is selected for use by the comm 1 receiver-transmitter and displayed: (1) one of 20 preset channels, (2) a manual frequency selection mode (M), (3) a guard channel (G), (4) a cue (C) channel/frequency for Single Channel Ground and Airborne Radio System (SINCGARS) (ARC-210), and (5) maritime (S) (ARC-210).

Rotating the comm 1 channel selector knob to position 1 through 20 selects the preset mode for the preset channel number selected. The receiver and transmitter operates on the fixed frequency stored in the selected preset channel. When the comm 1 selector knob is placed to G (guard), a G is displayed in the comm 1 channel display window and the receiver-transmitter is tuned to 121.5 MHz in the VHF

band or 243.0 UHF. The frequency selection is determined by the band currently in use. The M position selects the manual frequency select mode. This tunes the radio to the preset manual frequency. Using M channel allows the operator to change the communication frequency without disturbing the twenty fixed frequency presets. The C position tunes the radio to the preset Cue frequency in SINCGARS (SG) operation. The S position selects the maritime mode which tunes the radio to the selected maritime channel.

When the active comm is in the AJ mode, by rotating the comm 1 channel selector knob, the operator may select one of 20 Have Quick or SINCGARS preset channels, Manual Data Fill Mode (M), or Cue channel (C).

In ECCM mode, the position 1, 2, ..., or 20 selects the preset mode. These preset channels can be either a HQ I, II or SINCGARS presets. The radio operates on the Word Of Day, multiple WODs, or net number stored in the selected preset channel. The M position in AJ operation selects the Manual Data Fill Mode. This allows the operator to verify WOD for a particular day, manually load HQ WODs, or clear all stored net data. The C position channel operates just as the Cue channel in normal mode.

All modes listed above are arranged and described in three main operations: (1) normal and plain operation, (2) Have Quick, and (3) SINCGARS operation. Normal operation uses the twenty presets or the manual select channel in fixed frequency operation. Also available are the Guard and maritime channels. In Have Quick operation, the procedures for using (1) preset mode, (2) HQ Time options, and (3) manual data fill mode, are described. Similar to Have Quick, the SINCGARS operation includes (1) preset mode, (2) using SG Time options, (3) performing Electronic Remote Fill with ERF option, (4) data fill using Cold Start option, and (5) Cue channel selection.

The comm 2 channel selector knob performs the same functions as the comm 1 channel selector knob except that it controls the operation of the comm 2 receiver-transmitter.

23.2.1.1.3 Comm 1 and Comm 2 Channel Display Windows. These windows display the preset channel (1 thru 20), guard channel selection (G), manual position (M), and with ARC-210 cue (C) or maritime (S) as selected by the comm 1 or comm 2 channel selector knobs. In AJ mode, these windows display 1 thru 20 for the indication of HQ or SG preset channel number, M for manual data fill mode selection, or C for cue channel. In MIDS equipped aircraft the comm channel display window visually identifies which audio sources are currently active. An inverted triangle indicates comm 1 or comm 2 is transmitting or receiving. An upright triangle indicates MIDS A or MIDS B is transmitting or receiving. An hourglass symbol indicated simultaneous comm and MIDS radio operation. The triangle/hourglass symbols remain as long as the audio source is transmitting or receiving. The comm channel number (1 thru 20) is displayed for 2 seconds after a channel change occurs.

23.2.1.1.4 ADF Function Select Switch. The ADF function select switch has positions labeled 1, 2, and OFF. Placing the switch to the 1 position turns on power to the ADF set and indicates ADF bearing to the station selected on the comm 1 receiver-transmitter. Placing the switch to the 2 position turns on power to the ADF set and indicates ADF bearing to the station selected on the comm 2 receiver-transmitter. With the switch set to OFF, power to the ADF is removed. The ADF bearing symbol is a small circle displayed on the HSI display and indicates the ADF bearing to the station selected. Squelch is deselected when the ADF is selected. After the ADF is turned on, the SQUELCH has to be reselected.

23.2.1.1.5 Scratchpad Window. When the channel selector knob is pulled to the extended position in normal mode, the scratchpad window either displays the preset channel number and the frequency information, or it displays M- and the manual select frequency, G- and the Guard frequency, C- and the cue frequency, S- and the maritime channel number. If the active comm is in the AJ mode, when

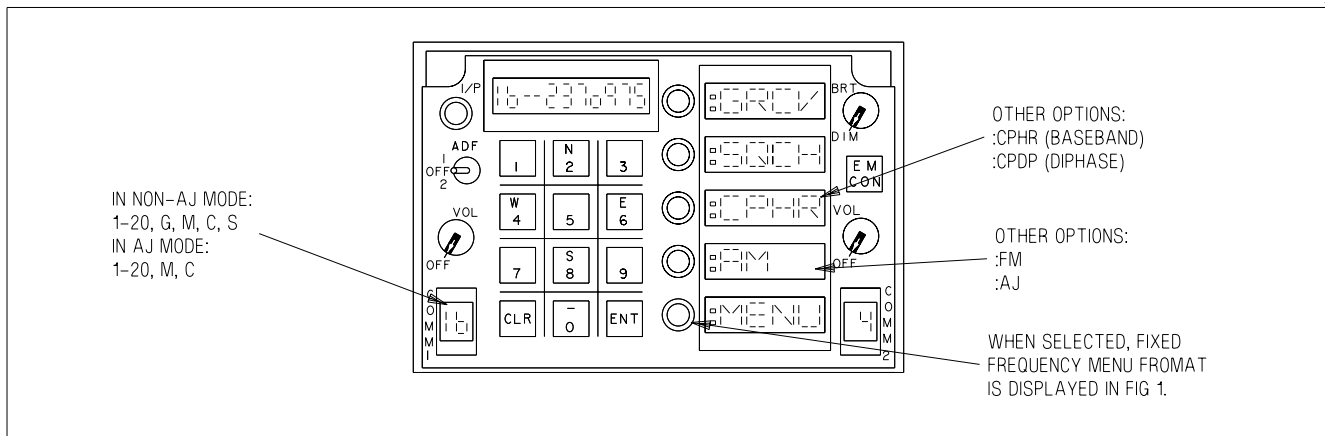

Figure 23-2. UFC COMM Display

ADA520-333-1-045

pulled, the scratchpad window displays the net number and the preset channel designations, H1, H2, or SG, depending upon the respective Have Quick I, II, or SINCGARS channel selected.

The scratchpad displays the new data or information entered using the UFC keyboard. In general, when the entered data is invalid or out of range, the scratchpad flashes ERROR for a moment and returns to the previous display.

23.2.1.1.6 Option Select Pushbuttons. An option is selected by pressing the pushbutton to the left side of the corresponding option display window.

23.2.1.1.7 Option Display Windows. When the comm 1 or comm 2 channel selector knob is pulled, the UFC displays Comm Display (see figure 23-2). GRCV and SQCH appear in option windows one and two respectively. Option window three displays cipher mode options, either CPHR, :CPHR, or :CPDP. Option window four displays the radio mode functions (either :AM, :FM, or :AJ) unless maritime mode is selected. MENU is displayed in the option five window.

- GRCV** When pressed, guard receiver enabled and a colon appears to the left of GRCV in option window one. Upon power up with WOW, status from last flight is remembered. When pressed while GRCV is colonized, Guard receiver is disabled.
- SQCH** When pressed, squelch reduces noise level in radio. A colon appears to the left of SQCH to indicate squelch is ON. When pressed while SQCH is colonized, squelch is OFF.
- CPHR** Upon successive pushbutton depressions, this option window toggles from CPHR (plain voice through :CPHR, :CPDP, and then return to CPHR.
- :CPHR** When displayed, cipher mode is enabled with Baseband operation.
- :CPDP** When displayed, cipher mode is enabled with Diphase operation. This option is displayed only when the active comm is in AM UHF and Diphase mode is selected.
- :AM or :FM** When displayed, indicates the active comm is in normal/non-AJ mode and the modulation of the current preset is AM or FM, depending upon the frequency band or the operator's selection.

- :AJ** When displayed, indicates the active comm is in the AJ mode. The current channel is a HQ or SG preset. When pressed, AJ mode is disabled and option window four displays either AM or FM depending upon the frequency preset channel. If the radio is tuned to a frequency in the AM only band and G, M, or C is the selected channel, option window four is blank.
- MENU** When pressed while :AM or :FM is displayed in option window four, the UFC displays Fixed Frequency Menu Display Format. Otherwise, if AJ is displayed and the current channel is either HQ or SG preset, respective UFC HQ Display or UFC SG Display. Selection of RTN option causes the UFC to display UFC Comm Display.

23.2.1.1.8 Brightness Control Knob. The knob has positions of BRT (bright) and DIM. The brightness of the display increases as the knob is rotated clockwise toward BRT.

23.2.2 Normal and Plain Operation

23.2.2.1 Fixed Frequency Preset. Unless otherwise specified, the UFC generally displays UFC Comm Display in fixed frequency normal operation such that GRCV, SQCH, CPHR, :AM, or :FM, and MENU are displayed in option windows one, two, three, four, and five, respectively.

Preset frequency selection: Disable AJ mode. Rotate the channel select knob to the desired preset channel (1 to 20). The scratchpad displays the selected channel number and the frequency. Also, the AM/FM modulation is updated and displayed in option window four.

Presetting frequencies: The operator can load or change the frequency of the twenty preset channels. Rotate the channel select knob to the channel to which the frequency is to be preset. After selected, a six digit frequency in Megahertz is entered using the keyboard. When a valid frequency is entered, the system determines the proper AM/FM modulation for the entered frequency if the modulation is not operator selectable. For frequencies in AM only or FM only, option window four is blank. If valid, the frequency and AM/FM mode are loaded and stored in the selected channel.

23.2.2.2 Manual Frequency Mode Selection. Rotate the channel select knob to M position and disable AJ mode. The scratchpad displays M- and the previously manual selected frequency. Option window four displays preset AM/FM mode or blanks for frequencies in AM only or FM only. The operator may enter a new frequency and modulation type using the keyboard and option window four pushbutton, respectively.

23.2.2.3 Guard Channel Selection. Rotate the channel selector knob to the G position. The scratchpad displays G- and the preset Guard frequency. The Guard channel only operates in non-AJ and plain mode. The operator can change the Guard frequency in the same way as that of a fixed frequency preset channel.

23.2.2.4 Maritime Mode Selection. Rotate the channel selector knob to the S position. The scratchpad displays S- and the previously selected channel. The operator may enter two digits for the desired maritime channel using the keyboard. These channel numbers must be in the range 1 to 28 or 60 to 88. The maritime channels are used to communicate with ships or coast stations only. Once a new channel is selected, the active comm tunes to the preset frequency stored in the selected maritime channel.

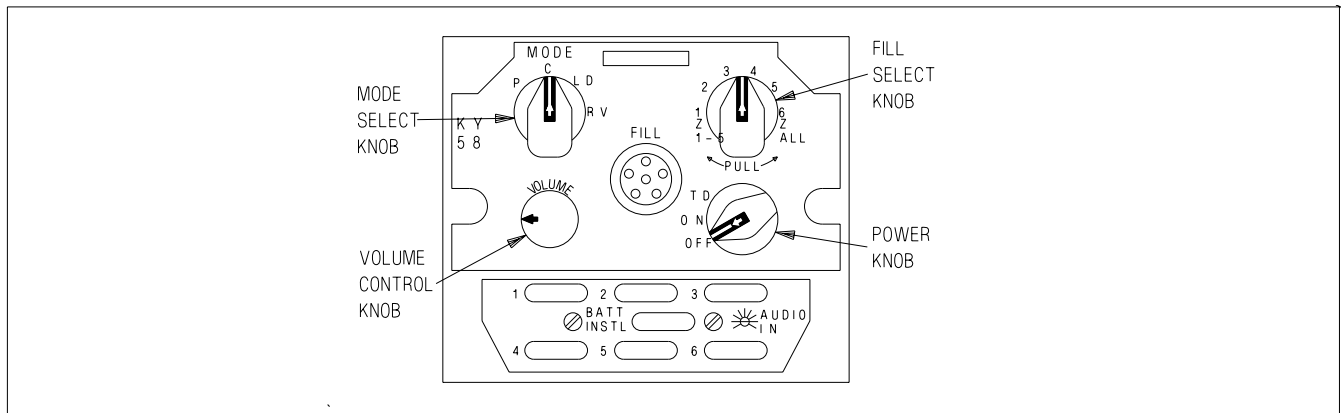

ADA520-72-1-045

Figure 23-3. KY-58 Control Panel Assembly

23.3 SECURE SPEECH SYSTEM (KY-58)

The secure speech system is used for ciphering (coding) or deciphering (decoding) audio routed through the COMM 1 and COMM 2 receiver-transmitters. The system consists primarily of the KY-58 control panel assembly on the right console. Controls and indicators are on the KY-58 control panel assembly and on the communication control panel on the left console.

23.3.1 KY-58 Control Panel Assembly. The control panel assembly functions as a ciphering or deciphering device for secure speech operation.

23.3.1.1 Ciphred Transmission. During ciphred transmissions, audio from the microphone is routed through the communication control panel to the KY-58 control panel assembly where it is enciphered. The enciphered audio is routed back to the communication control panel and then to COMM 1 or COMM 2 receiver-transmitter for transmission.

23.3.1.2 Ciphred Reception. During reception of ciphred information, the ciphred audio is routed from the COMM 1 or COMM 2 receiver-transmitter to the communication control panel and then to the control panel assembly for deciphering. The deciphered audio is routed to the communication control panel and to the headset.

23.3.1.3 Ciphred Relay Mode. During ciphred relay mode of operation, ciphred information received on one radio is routed from the radio, through the communication control panel to the second radio for transmission. The ciphred information received on the first radio is also routed through the communication control panel to the KY-58 control panel assembly for deciphering. The deciphered audio is routed through the communication control panel to the headset. This enables the crewmember to hear deciphered relayed audio when in the ciphred relay mode. When cipher is selected on the communication control panel immediately after operating in a relay plain, COMM 1 plain, or COMM 2 plain mode of operation, the crewmember must press the transmit key for either COMM 1 or COMM 2 two times to enable ciphred relay operations. When the relay aircraft is operating both radios within the same bandwidth, the two frequency selections must be separated by a minimum of 10 MHz.

23.3.2 Controls and Indicators. The only cipher control on the communication control panel is the RLY CIPHER/PLAIN switch (relay switch). The controls on the KY-58 control panel assembly are the MODE select knob, the unlabeled fill select knob, the VOLUME control knob, and the unlabeled power select knob (see figure 23-3).

23.3.2.1 Comm Relay Switch. This switch has positions of CIPHER, OFF, and PLAIN. Placing the switch to CIPHER enables the cipher relay mode. With the switch in OFF the relay mode is disabled. Placing the switch to PLAIN enables the plain relay mode.

23.3.2.2 Mode Select Knob. The mode select knob has positions of P, C, LD, and RV. Placing the knob to P enables plain mode of operation. Placing the knob to C enables the cipher mode of operation. With the knob set to LD the load mode of operation is enabled. This mode is used for loading data into the KY-58 control panel assembly. Information pertaining to the RV knob position (receiver variable) will be supplied later.

23.3.2.3 Fill Select Knob. The fill select knob has positions of 1 thru 6, a Z 1-5 position, and a Z ALL position. Setting the knob to one of the six numbered positions selects the position to be loaded with data. Placing the knob to Z 1-5 zeroizes data in positions 1 thru 5. Placing the knob to Z ALL zeroizes all data in positions 1 thru 6.

23.3.2.4 Volume Control Knob. The volume control knob adjusts the volume of the KY-58 control panel assembly audio. The volume control knob should be set to full volume position during secure voice transmission and reception.

23.3.2.5 Power Knob. This knob has positions of ON, OFF, and TD. Placing the knob to ON turns on power to the KY-58 control panel assembly if cipher mode has been selected. Placing the knob to OFF removes power to the system. With the knob in TD, power is turned on for the system if cipher mode has been selected and a time delay is selected for data processing. The knob must be in the TD position for ciphered relay operations.

23.3.3 KY-58 Operation. Other stations or aircraft involved in cipher or cipher relay communication must be in either the baseband or diphas mode.

1. Comm 1 and Comm 2 radios - ON
Comm 1 and Comm 2 radios are turned on and volume adjusted with the VOL 1 and 2 communication control knobs on the UFCD.
2. Comm 1 and Comm 2 channels - AS DESIRED
 - a. COMM 1 and COMM 2 channel select knobs - ROTATE (to select desired channel).
Selected channel is displayed in COMM 1 and 2 touch option/display on the UFCD.
3. Comm 1 and Comm 2 channel frequency - SET
 - a. Comm 1 and Comm 2 touch option/display - TOUCH
Channel number and frequency displayed in scratchpad GRCV, SQCH, and CPHR options appear on the option/ display.
 - b. Channel frequency - AS DESIRED
Enter new frequency with keypad. Press the ENT key to enter the new frequency.
4. CPHR touch option/display - TOUCH
The CPHR touch option/display is border highlighted and a series of tones are heard for 3 seconds indicating cipher is enabled with baseband operation. Touching the CPHR touch option/display again changes the display to CPDP with the border highlighted and enables cipher diphas mode.

23.3.3.1 KY-58 Cipher Mode. Other stations or aircraft involved in cipher communication must have the KY-58 fill select knob in the same position.

5. KY-58 power knob - ON
6. KY-58 MODE knob - C
7. KY-58 VOLUME knob - ADJUST TO MAX VOLUME
8. Comm switch on inboard throttle - ACTUATE
UP for Comm 1, DOWN for Comm 2. A short tone is heard in the headset.

23.3.3.2 KY-58 Relay Mode. Relay mode can operate in Plain, Cipher and ECCM mode. Other stations or aircraft involved in cipher relay communication must have the KY-58 fill select knob in the same position.

5. KY-58 power knob - TD
Other stations or aircraft involved in cipher relay communication must have the KY-58 power knob in the TD position.
6. KY-58 MODE knob - C
7. KY-58 VOLUME knob - ADJUST TO MAX VOLUME
8. COMM 1 ANT SEL switch - AUTO
9. Relay switch select - CIPHER
10. Comm switch on inboard throttle - ACTUATE
UP for Comm 1, DOWN for Comm 2. A short tone is heard in the headset.

NOTE

When the relay aircraft is operating both radios in the same bandwidth, the two radio frequencies must be separated by at least 10 MHz.

23.4 HAVE QUICK OPERATION AND OPTIONS (ARC-210) (AIRCRAFT 164945 AND UP, F/A-18A AFTER AFC 253 OR 292 AND AIRCRAFT 163427 THRU 164912 AFTER AFC 185.)

23.4.1 Preset Mode. Enable AJ mode to select a HQ preset channel while UFC Comm Display is active. See figure 23-4. Rotate the channel select knob to the desired HQ preset channel (1 to 20). The scratchpad displays H1 for HQ I (or H2 for HQ II) and the net number. If there is no valid data/waveforms or time stored for the selected channel, the scratchpad displays NO FILL.

The operator can enter or change the HQ net number of the twenty preset channels. Rotate the channel selector knob to the channel to which the net number is to be preset. AJ mode is enabled. A six digit HQ net number may be entered using the keyboard. Valid HQ net numbers range from 000.000 to 999.000 with the last three digits being 000 for HQ I, 025 for HQ II (NATO), or 050 for HQ II (non-NATO). A decimal point, separating the first three digits from the last three digits, is provided

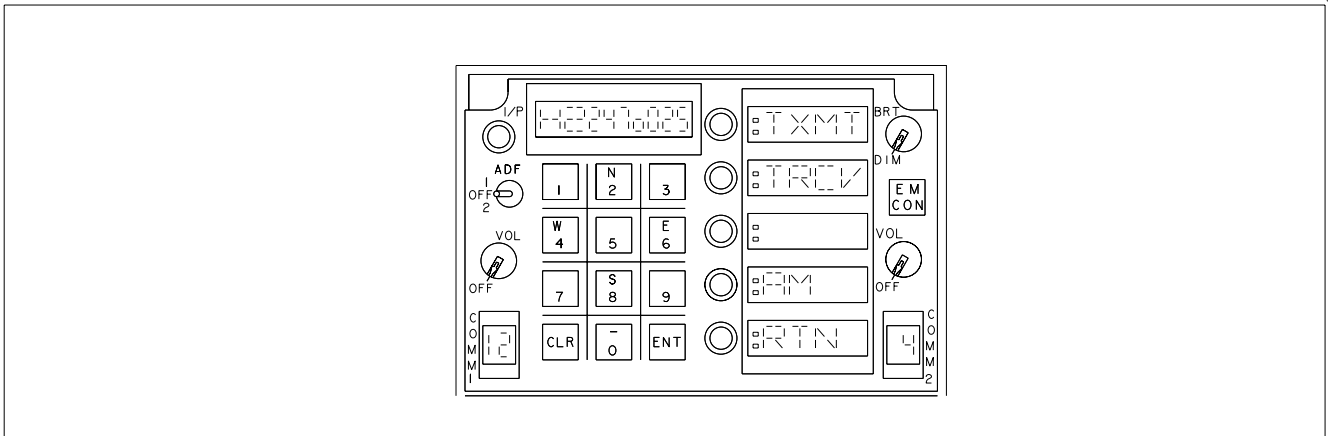

ADA520-334-1-044

Figure 23-4. UFC Have Quick Display

in the scratchpad automatically. If the entered net number is not valid, the scratchpad flashes ERROR and returns to the previous or NO FILL display. If valid, the active comm loads and stores the new net number and associated waveforms in the selected channel.

23.4.2 Using HQ Time Options.

23.4.2.1 Transmitting or Receiving Time Using UFC HQ Display. When MENU option is selected in UFC Comm Display and the selected channel is a HQ preset, the UFC displays the Have Quick display.

NOTE

Loss of GPS timing may affect HAVE QUICK operation.

TXMT (Time Transmit), TRCV (Time Receive), AM (Amplitude Modulation) and RTN (Return) are displayed in option windows one, two, four and five respectively. Option window three is blank.

TXMT When pressed, enables the active comm to transmit the Time Of Day (TOD) to other units for net time synchronization. A colon appears to the left of TXMT in option window one for two seconds and then removed.

TRCV When pressed, enables the active comm to receive the transmitted TOD from another net user. A colon appears to the left of TRCV in option window two until TOD is received. If sixty seconds pass after the option selection, the colon is removed and the Time Receive mode is deactivated.

RTN When pressed, causes the UFC to return to the UFC Comm Display.

23.4.2.2 Transmitting, Receiving, or Restarting Time Using Fixed Frequency Menu Format.

While the UFC displays Comm Display, disable AJ mode and rotate the channel selector knob to select a fixed frequency preset. When MENU option is selected, the UFC displays Fixed Frequency Menu Format. TXMT (Time Transmit), TRCV (Time Receive), TRST (Time Restart), CST (Cold Start), and RTN (Return) are displayed in option windows one, two, three, four, and five, respectively. When this format is active, the operator can restart time, transmit or receive time to/from other net users, or use the Cold Start option.

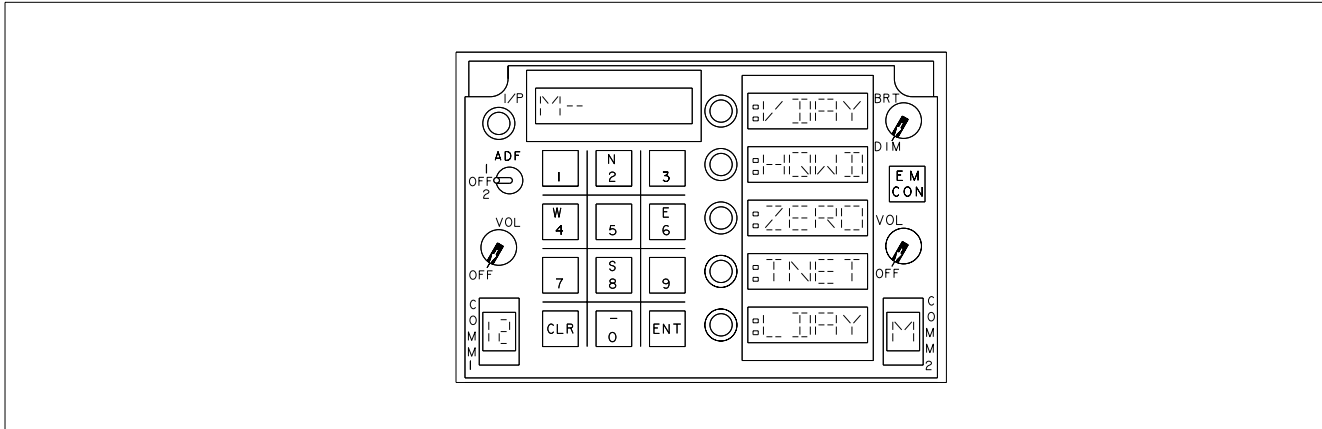

ADA520-335-1-045

Figure 23-5. UFC Manual Data Fill Display

The operation of TXMT and TRCV options are the same as TXMT and TRCV options described in the paragraph of Transmitting and Receiving Time Using UFC HQ Display. CST option is used when an operator, that is not part of an active SINCGARS net, wants to join the net. The operation of this option is described in Performing ERB (electronic remote fill) in SINCGARS Operation and Options section.

The TRST option is used to start or initialize time in the radio system at power-up. Performing this option takes two actions. First, upon selecting the option, the scratchpad displays ENABLE and a colon appears at the left side of TRST in option window three. Then, the operator can press either the CLR key to cancel TRST option, or the ENT key to activate Time start. When the CLR key is selected, the colon from the option is removed and the scratchpad changes to display the fixed frequency. Selection of the ENT key while ENABLE appears causes the radio to restart its clock. After executing the option, the system removes the colon and changes the scratchpad to display fixed frequency.

When RTN is pressed, the UFC returns to the Comm Display Format.

23.4.2.3 Using Manual Data Fill Mode. To selecting M channel and display manual fill options, enable AJ mode in UFC Comm Display before rotating the channel select knob to M position. The UFC displays Manual Data Fill Display, VDAY, HQWD, ZERO, TNET, and LDAY are displayed in option windows one, two, three, four, and five, respectively (see figure 23-5). The scratchpad displays M- in the left most windows. AJ communication is not available in this mode. When Manual Data Fill Mode is exited by selecting a preset channel, AJ mode is enabled.

VDAY option is used to verify that the HQ Word of Day has been loaded for a particular day. When VDAY is pressed, a colon appears at the left side of VDAY in option window one. From the keyboard, enter a two digit day code (in the range 0 to 31) followed by ENT key. The system generates an audible beep in the operator's headset if the entered day has a stored WOD for the selected day. Multiple days can be verified by entering each day as desired.

The HQWD option allows the operator to manually enter the HQ I WOD or the HQ II multiple WODs rather than using a data loader. A WOD consists of six segments (20 through 14). For HQ II, six WOD segments and a two digit day code (0 to 31) make up a multiple WOD. The system can store a single WOD or up to six multiple WODs.

When HQWD is pressed, a colon appears at the left side of HQWD in option window two and 20 in the scratchpad along with the associated WOD first segment. If this segment has no stored data, blanks are displayed in the scratchpad. The first segment data in the range of 200.000 to 399.975 in .025 increments is entered or changed using the keyboard.

Each successive segment (19, 18, ... 15) can be selected by pressing option 2 pushbutton again while the colonized HQWD is displayed. Data may be entered or changed for each segment, or the next segment may be selected. When segment 14 is displayed, the day of the month of that WOD is displayed in the far right windows. If no day code was stored, blanks are displayed and the day code may be entered using the keyboard. If the colonized HQWD option is selected while 14 and the day code are displayed, the scratchpad changes to display LOAD in the right-most windows. When the ENT key on the UFC keyboard is depressed while LOAD is displayed, the WOD loading is accomplished. If the loaded WOD is accepted by the radio system, a beep is heard in the operator's headset and the UFC displays M- in the two far left windows. Also, the colon from HQWD option window is removed.

The operator can then enter the next WOD and associated date by starting the preceding sequence over. The WOD loading is terminated by selecting another option or exiting the Manual Data Fill Mode.

23.4.2.4 Erasing All Net Data. ZERO option is used to erase all the stored HQ WODs and SINCGARS Transec data by filling with zeros.

When pressed, ZERO is displayed in the scratchpad window and a colon to the left of ZERO in option window three. At that time the CLR and ENT key on the UFC keyboard are active for selection. To cancel the selected option, press the CLR key. As a result, the colon from the option is removed and the scratchpad changes to display M- in the two left-most windows. Otherwise, pressing the ENT key while ZERO appears in the scratchpad initiates the ZERO function for the active comm. Once the ZERO option has been executed, the active comm zeroes all the stored WODs and training nets from its memory. After that, the UFC displays M- in the scratchpad and the colon is removed from the ZERO option window.

23.4.2.5 Using Training Net. TNET option allows training on the overall operation of HQ I or HQ II. These nets are unclassified. HQ I has 5 frequencies and HQ II has 16 frequencies used for frequency hopping.

TNET when pressed, a colon appears to the left of TNET in option window four and M- 1 or 2 in the scratchpad as a prompt for keyboard selection of HQ I or HQ II training nets, respectively. Because HQ I training net is not available and now performed through WOD data, do not select HQ I. For selecting HQ II training, enter 2 followed by the ENT key. The scratchpad displays 20 and the first stored training net frequency. Blanks are displayed if no data was stored.

The procedure for loading the training net frequencies is similar to the one described above in loading HQ WODs paragraphs. Upon successive depressions of option four pushbutton when TNET is colonized, the scratchpad displays 19, 18, ... 6, in the left-most windows and the next corresponding frequency in the right-most windows. If no training net frequencies have been stored in memory, blanks are displayed in place of the frequency. A new frequency is entered using the keyboard.

If the option is selected while 5 and its associated frequency are displayed, the scratchpad changes to display LOAD. When ENT key is pressed, sixteen HQ II training frequencies are sent to the system. If the loaded data is accepted by the radio, a beep is heard in the operator's headset and the scratchpad displays M- in the left-most windows. The colon from TNET option window is removed.

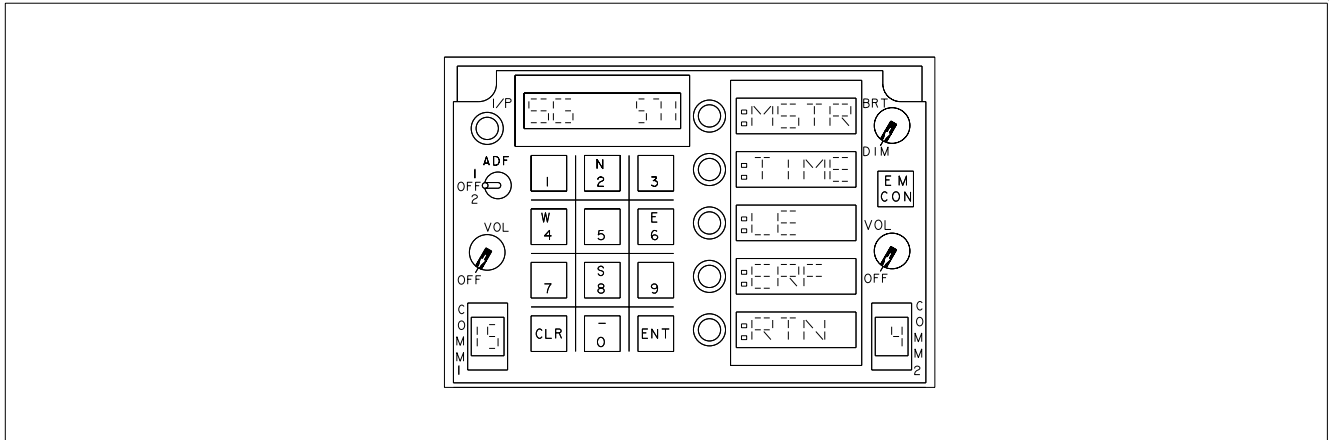

ADA520-336-1-045

Figure 23-6. UFC SINGARS Display

23.4.2.6 Loading an Operational Day. LDAY option is used to load the day of operation. The system correlates the stored WODs and the identified day code with the operating day.

When LDAY is pressed, a colon appears to the left of LDAY in option window five. While the scratchpad displays M- in the left-most windows, enter two digits (01 to 31) of the operating day. When the ENT key on the keyboard is pressed, a beep is heard in the operator's headset to indicate the day has been entered.

23.5 SINGARS OPERATION AND OPTIONS

23.5.1 Preset Mode. While the UFC displays Comm Display, enter AJ mode. Rotate the channel selector knob to select an SG channel preset (1 to 20). If the channel is a SG preset, the scratchpad displays an SG and the net number. A SINGARS net number may not be entered or changed.

23.5.2 Using Time Options in SG Display. If MENU option is selected in UFC Comm Display and the current channel is an SG preset, the UFC displays an SG Display. See figure 23-6. MSTR (Master Clock), TIME (Time Entry), LE (Late Entry), ERF (Electronic Remote Fill), RTN (Return), are displayed in option windows one, two, three, four, and five respectively. Selecting MSTR option enables the active comm to become the master clock which provides the time reference for a SINGARS net. TIME option allows each user to enter SG time. LE option is used to synchronize time to the net once time is entered using TIME option. When RTN is selected, the UFC returns to the Comm Display.

When MSTR is pressed, a colon appears to the left of MSTR in option window one to indicate that the comm has been designated as the master clock in the SG net. MSTR mode is active until another option is selected.

When TIME is pressed, a colon is displayed to the left of TIME in option window two and the scratchpad displays -- - to prompt the operator to enter in DD--HH-MM using the keyboard. If the entered time is valid, the scratchpad displays time until another option is selected. If the option is selected while colonized, the scratchpad changes to display SG and the net number.

When LE is pressed, the UFC displays a colon in front of LE in option window three. When the active comm has synchronized its time with the net time, it removes the colon from LE option and disables the Late Entry mode.

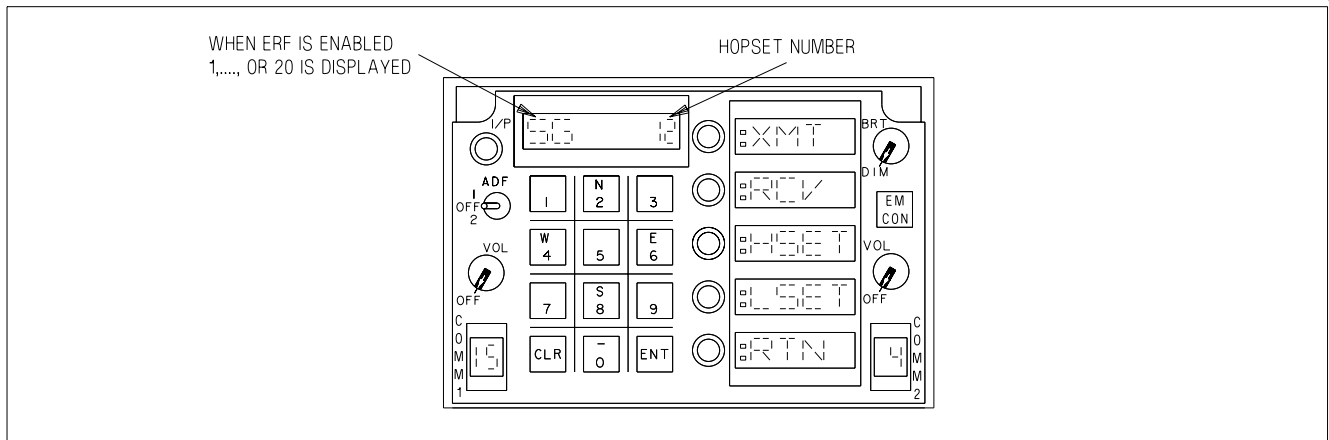

ADA520-337-1-045

Figure 23-7. UFC Electronic Remote Fill Display

23.5.3 Performing Electronic Remote Fill (ERF) with ERF Option. While the UFC displays SG Display, ERF appears in option window four. ERF allows the net data to be filled electronically over the air by another net user who has the required net data.

When ERF is pressed, XMT (transmit), RCV (receive), HSET (hopset), LSET (lockout set), and RTN (return) are displayed in UFC option windows one, two, three, four, and five respectively. See figure 23-7. Pressing RTN causes UFC to display SG Display.

When ERF option is selected, the scratchpad displays SG in the two left-most windows and the hopset or lockout set in the far right windows depending upon which option was last selected, HSET or LSET. A colon appears in front of HSET or LSET in the option display window to indicate the current selection. A new hopset or lockout set is entered by first selecting the desired HSET or LSET option if different from the current selection, and then the desired set number (1 to 20 for the hopset and 1 to 8 for the lockout set) using the keyboard. The entered set number is displayed in the scratchpad.

23.5.3.1 Transmission or Reception of Hopset or Lockout Set. Depending on the selected set data, selecting XMT option enables the radio to transmit the hopset or lockout set. A colon is displayed in front of XMT for two seconds after the transmission occurs. The XMT option is blanked in ADF operation.

Pressing the RCV option enables the radio to receive the selected set data. A colon is displayed adjacent to RCV until the selected set is received.

23.5.3.2 Performing ERF with CST Option. First, disable AJ mode and select a fixed frequency to perform cold start by changing channels or entering a new frequency. Then, MENU option on UFC Comm Display is selected to display Fixed Frequency Menu. When CST option is selected, the UFC displays the same ERF format as the one displayed when the ERF option is selected in the UFC SG Display, with the exception of scratchpad display. The channel number and the fixed frequency are displayed in the scratchpad. The operator can select these ERF options using the same procedures as described in paragraph 23.5.3.

23.5.3.3 Cue Channel Selection. A non-net user who is currently not on a net can contact an SG net user on the Cue frequency using the C channel. The C channel is selected using the channel selector knob of the active comm. Rotate the channel select knob to C position. The UFC displays Comm Display with option window five (MENU option) blanked. The scratchpad displays C- and the preset

Cue frequency. AM/FM modulation information displayed in option window four is provided in the same manner as it is for the fixed frequency presets. The Cue frequency can be changed similar to the programming of a normal channel by manually entering the frequency using the keyboard.

Visual and audio indications are provided to the operator being contacted by a non-net user. The channel display window flashes at a 1 Hz rate to signal the operator when the active comm receives the cue signal. Also, a beep is heard momentarily in the operator's headset. The operator generally selects the C channel to respond to the contact on the Cue frequency.

23.6 IDENTIFICATION SYSTEM

The IFF (identification friend or foe) transponder set provides automatic identification of the aircraft in which it is installed when challenged by a surface or airborne interrogator set and provides momentary identification of position (I/P) upon request. The system operates in modes 1, 2, and 3/A which are selective identification feature (SIF) modes and in mode C, the altitude reporting mode. Mode 4, which is a crypto mode, is available when the transponder computer (KIT) is installed in the aircraft.

23.6.1 Combined Interrogator Transponder (Aircraft 165222 AND UP, F/A-18A AFTER AFC 292, AND Aircraft 163985 THRU 165221 AFTER AFC 236). The Combined Interrogator Transponder (CIT) System is a dual purpose IFF system with transponder and interrogator capabilities. When functioning as a transponder, the system utilizes the ACI panel and antenna select panel controls. In the air interrogator mode, the system incorporates a beam forming network and a five blade antenna array mounted on the upper fuselage forward of the windscreen.



The CIT system can transmit on the ground. Ensure that personnel remain more than 18 inches away from the nose barrel mounted antennas during ground operation.

The CIT system works in conjunction with the MC, CC, ACI, UFC, ADC, IBU, LGCU and the displays. The UFC displays and controls for the CIT are shown in figure 23-8.

23.6.1.1 Transponder Operation. The transponder responds to interrogations in modes 1, 2, 3/A, 4, and C. The CIT only transponds when an interrogation in an enabled mode is received. The IFF transponder modes and codes can be selected and changed by selecting the Transponder (XP) IFF display on the UFC or automatically as described below. Initialization of the transponder codes is also available via a file on the MC.

23.6.1.2 Transponder Control Via the UFC

The transponder operation is controlled through the UFC by selecting the IFF function key on the UFC until XP is displayed in the scratchpad. Subsequent selection of the IFF function key toggles between AI and XP IFF displays. The current mode 3 code is displayed in the scratchpad and the modes that are currently enabled have colons displayed in the option windows. The mode 3 code is changed by use of the keyboard. When the ENT key is pressed, the new mode 3 code is entered into the IFF if valid. The modes and codes selected for transponder operation are selected independent of the interrogator modes and codes.

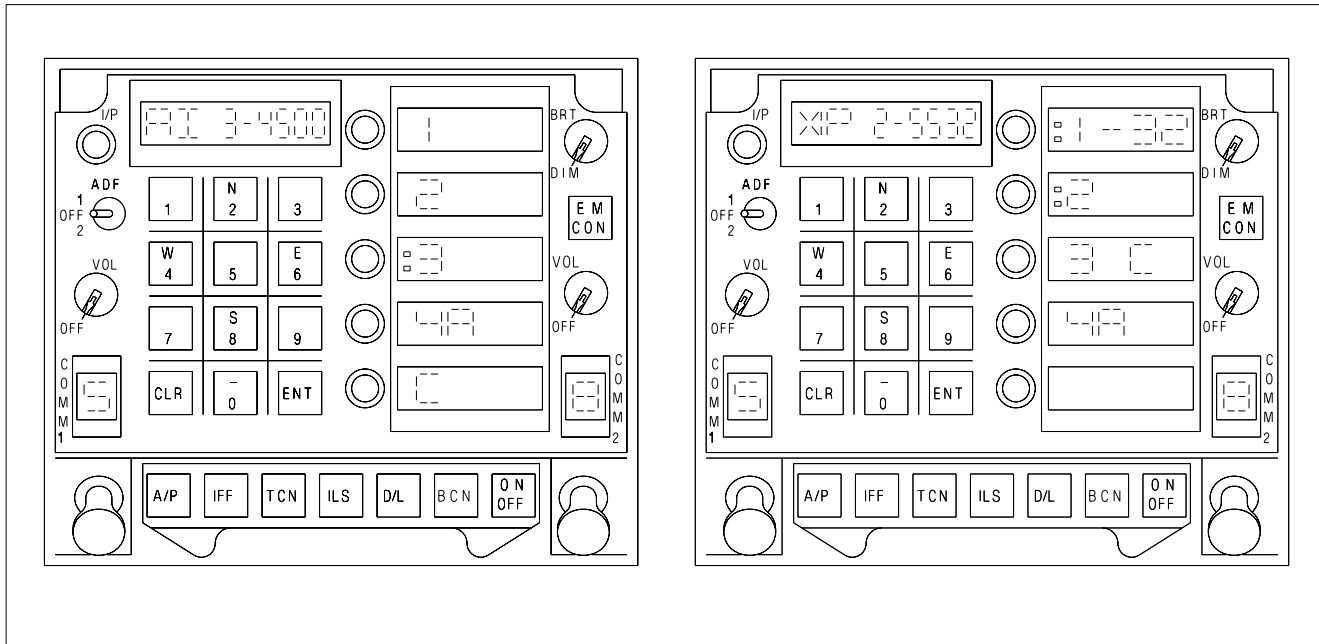

Figure 23-8. UFC IFF Display

ADA520-338-1-044

Modes 1 and 2 are enabled/disabled by pressing the appropriate option select switches. When mode 1 is enabled, the mode 1 code is displayed in the scratchpad. The mode 1 code can then be changed from the keyboard. A mode 1 code is valid if the first digit is 0-7 and the second digit is 0-3. When mode 2 is enabled, the mode 2 code is displayed in the scratchpad. The mode 2 code can then be changed from the keyboard. When the ENT key is pressed, the new mode 2 code is entered into the IFF if valid, (i.e. 4 digits, each 0-7).

Selection of option 3 provides the mode 3 code in the scratchpad and enables/disables modes 3 and C. Mode 3 can be selected independently from mode C. The mode enables for 3 and C are toggled for subsequent depressions of option 3 in the following order: 3 C displayed but disabled; :3 C displayed and both modes enabled; :3 displayed and enabled. When mode C is enabled, the IFF replies to mode C interrogations with digitally encoded pressure altitude from the air data computer. If mode 3 is not enabled, mode C will reply with bracket pulses only (i.e., zero altitude).

The option 4 selection is used for enabling/disabling the secure mode. If the KIV-6 crypto module is not installed, this option window is blanked. An IFF4 caution is displayed on the caution display line whenever the mode 4 codes are invalid or zeroized, there is a fault in the crypto unit, or the transponder is not replying to valid mode 4 interrogations (either due to mode 4 not being enabled or to a failure). Associated with the IFF4 caution is the voice alert message, Mode 4 Reply. If the transponder is not replying to valid mode 4 interrogations due to a code disparity, the mode 4 audio tone is presented in the aircrew's headset. If the transponder is replying to valid mode 4 interrogations, the M4 OK advisory is displayed on the left DDI. The mode 4 tone and M4 OK advisory can be controlled with the Mode 4 switch on the ACI.

23.6.1.3 Interrogator Operation

The interrogator can challenge in modes 1, 2, 3/A, 4 and C. The air interrogator modes and codes can be selected and changed by selecting the Air Interrogator (AI) IFF display on the UFC. Initialization of the transponder codes is also available via a file on the MU.

NOTE

All Combined Interrogator Transponder equipped F/A-18 aircraft shall limit CIT usage in non-tactical flight regimes. Specifically, Auto Mode Interrogations should not be selected during enroute transits to and from training areas or during cross country ferry flights. This operational limitation is intended for continental US flight operations only and is not intended to impact tactical doctrine or safety of flight requirements whatsoever.

23.6.1.4 Interrogator Mode/Code Selection on the UFC

The interrogator mode/code selection is controlled through the UFC by selecting the IFF function key on the UFC until AI is displayed in the scratchpad. Selection of the IFF function key toggles between the AI and XP IFF displays as shown in figure 23-8. The current Mode 3 code is displayed in the scratchpad and the modes that are currently enabled have colons displayed in the option windows. For correct code interrogations, the aircrew is able to select and change the code for Mode 1, Mode 2, or Mode 3 interrogations. The option windows on the interrogator display operate in the same manner as those on the transponder display. When an interrogation is commanded by the aircrew, the CIT interrogates in the modes selected on the AI UFC display. The modes and codes selected are sent to the CIT on the AVMUX by the MC. The modes and codes selected for interrogator operation are independent of the transponder modes and codes.

23.6.1.5 Automatic IFF Mode/Code Updates. The IFF update capability programs the mission computer to automatically change the codes of the IFF at specified times and/or at an interval. IFF modes can be enabled or disabled automatically when the aircraft crosses a specified geographic location. The system can be programmed during mission planning or in the cockpit.

The Mode 4 transponder and interrogator can be automatically updated on Zulu day transition. When this capability is enabled, Mode 4 automatically transitions to 4B when the aircraft Zulu time changes from 23:59:59 to 00:00:00.

23.6.1.5.1 Manually Loading Mission Planned Automatic IFF Data. Pre-planned mission data, if available, is loaded automatically by the MC during cold-start processing. The IFF pushbutton on the MUMI reloads the pre-planned mission data from the memory unit.

23.6.1.5.2 Programming Automatic IFF Data. The ROE/IFF PROG option on the SUPT menu calls up the Auto-IFF Program display allowing the pilot to review and edit the times, modes, and codes programmed into the automatic IFF system.

23.6.1.5.3 Automatic Disabling The MC automatically disables all features of the automatic update for IFF codes during automatic carrier landing, emission control, or following any manual update of the IFF codes using the UFC. This does not include manual updates to the programmable ROE or the manual enabling or disabling of IFF modes. When EMCON is removed, the system returns to its automatic update state. For ACL and manual IFF code updates, once disabled, the pilot must manually re-select the desired automatic update state.

23.6.1.5.4 Erasure of Auto-IFF Data. The data used by the automatic IFF system is erased when required. This includes full stop landing, ejection, or when commanded by the aircrew. The aircrew can prevent the erasure of this data, if desired, using the method currently implemented on the aircraft for sensitive/classified data.

23.6.2 IFF Controls and Indicators. The controls and indicators for IFF operation are on the UFC, communication control panel, and the right or left DDI.

23.6.2.1 UFC. The pushbuttons and indicators on this control used for IFF operation and display are the IFF function selector pushbutton, the ON/OFF selector pushbutton, the option select pushbuttons, the option display windows, the pushbutton keyboard, and the scratch-pad window.

23.6.2.1.1 IFF Function Selector Pushbutton. Pressing this pushbutton enables IFF options to be displayed on the option display windows (on the right side of the upfront control), enables the IFF status window (at the far left side of the scratchpad window) to display ON if the IFF is enabled, and allows the IFF code of the selected option to be displayed on the scratchpad window (located above the pushbutton keyboard). Mode 3 code is automatically displayed in the scratchpad when the IFF function selector pushbutton is pressed.

23.6.2.1.2 On/Off Selector Pushbutton. Pressing this pushbutton turns the IFF system on or off after first pressing the IFF function selector pushbutton. When the IFF function selector pushbutton is pressed, the status of the IFF modes are displayed via the cues in front of the option display windows. The last mode 1 code selection appears in the option one display window and a 3 (for mode 3/A) and a four digit code for the last mode 3 code entry appears on the scratchpad window.

23.6.2.1.3 Option Select Pushbuttons. The option select pushbuttons are used to select the IFF mode desired. The pushbuttons, from the top pushbutton downward, select modes 1, 2, 3/A, 4, or C. Alternately pressing the option 1 pushbutton enables or disables mode 1 operation. When option 1 is enabled a colon appears to the left of the option 1 display window, and the scratchpad window displays mode 1 and the last entered code. A mode 1 code can be set in with the pushbutton keyboard by pressing the proper pushbuttons and then pressing ENT (enter). When option 2 is enabled, a colon appears to the left of the window. A mode 2 code cannot be set in with the pushbutton keyboard. Pressing the option 3 select pushbutton causes mode 3 and the last code entered to be displayed on the scratchpad window. When option 3 is enabled a colon appears to the left of the window. A mode 3 code can be set in with the pushbutton keyboard and then entered with the ENT pushbutton. On aircraft with the mode 4 computer installed, pressing the option 4 pushbutton enables or disables mode 4A or mode 4B. If the option display appears as a colon and a 4A, pressing the pushbutton again disables 4A and a 4B appears in the option 4 display window. Pressing the option pushbutton again enables mode 4B indicated by the colon that appears to the left of the 4B. A mode 4 caution is displayed on the DDI if the mode 4 codes are zeroized, if there is a fault in the mode 4 computer, or if the transponder is not replying to valid mode 4 interrogations (either due to mode 4 not being enabled or to a failure). When option 5 is enabled a colon appears to the left of the window. To enable the complete altitude encoding mode (C), both option 3 and option 5 (mode C) select pushbuttons must be enabled. The altitude encoding mode uses 29.92 as a reference.

23.6.2.1.4 I/P Pushbutton. Pressing the I/P pushbutton enables the IFF system to transmit momentary identification of position.

23.6.2.2 Communication Control Panel. The communication control panel contains an IFF master switch, an IFF mode 4 switch, and an IFF crypto switch. The IFF mode 4 and IFF crypto switches are used for mode 4 on aircraft which have the mode 4 transponder computer (KIT) installed.

With the IFF master switch in EMERG, the IFF R/T replies with the emergency code. With the switch at NORM, the IFF R/T replies to interrogations with selected codes.

23.6.2.2.1 Mode 4 Switch. This switch has positions of OFF, DIS, and DIS/AUD.

OFF	Disables M4 OK advisory, mode 4 audio tone, IFF 4 caution, and voice alert.
DIS	Mode 4 advisory (M4 OK) appears when the IFF is responding to mode 4 interrogations. IFF 4 caution/voice alert enabled.
DIS/ AUD	M4 OK advisory and audio tone enabled when IFF is interrogated with valid mode 4 is interrogations. IFF 4 caution/voice alert enabled.

23.6.2.2.2 Crypto Switch. This switch has positions of HOLD, NORM, and ZERO. Placing the switch to HOLD, with the landing gear handle in the DN (down) position, retains the mode 4 codes if power to the system is lost. In the NORM position, mode 4 codes are available as long as power is not lost. Putting the switch to ZERO erases (zeroizes) the mode 4 codes. On aircraft equipped with MIDS, the crypto switch commands the MIDS terminal to hold or zero the crypto variables. HOLD is operational after the gear is down. If no action is taken, and the switch is left in the NORM position, the crypto variables are zeroed upon terminal shutdown or loss of primary power.

NOTE

- Ensure the MIDS terminal is ON, by ensuring L16 or TACAN is ON, prior to any attempt to zeroize IFF Mode 4 Crypto Keys via the CRYPTO switch.
- If aircraft equipped with the MIDS compatible transponder and KIT-1C, the manual ACI ZERO position does not zero MIDS keys. If the crypto switch has been placed to HOLD prior to MIDS power off after gear down, or if a landing gear cycle has not occurred, a maintenance procedure must be performed using the AN/CYZ-10 data transfer as outlined in A1-F18AC-600-300 to zeroize MIDS keys.

23.6.2.3 IFF 4 Caution/Voice Alert. An IFF 4 caution is displayed on the left DDI whenever the mode 4 codes are zeroized, there is a fault in the KIT, or the transponder is not replying to valid mode 4 interrogations because of mode 4 not being enabled or because of a failure. At the same time that the caution condition occurs, a corresponding voice alert message is heard twice in the pilot's headset. The voice alert message is "mode 4 reply, mode 4 reply". The IFF 4 caution/voice alert are disabled whenever the MODE 4 switch is in the OFF position.

23.6.2.4 IFFAI Caution. An IFFAI caution is displayed whenever the mode 4 codes are zeroized, there is a fault in the mode 4 interrogator, or there is a fault with the entire interrogator. The caution is not set if the KIV-6 crypto module is not installed in the CIT. The caution cannot be disabled via the MODE 4 switch on the ACI panel.

23.6.2.5 IFF OVRHT Caution. An IFF OVRHT caution is displayed whenever an IFF (APX-111) overheat condition is detected.

23.6.2.6 Emission Control Pushbutton. The emission control pushbutton on the right side of the UFC is labeled EMCON. Pressing the pushbutton switches the IFF or CIT, if on, to a standby mode so that it cannot transmit. At the same time EMCON is displayed vertically on the option display windows. When EMCON is turned off by pressing the pushbutton again, the IFF returns to its previous operating mode.

23.6.2.7 IFF BIT Check. To manually initiate an IFF BIT check, press the TCN/IFF pushbutton on the BIT display on the right DDI. IFF status is displayed on the BIT status display.

NOTE

If a KIT-1C is installed without Mode 4 crypto key installed, performing an IBIT of the IFF will likely cause a degrade of the CSC. A PBIT is performed when power is applied and an IBIT need not be performed.

23.6.2.8 IFF Antenna Selector Switch. The antenna selector switch is on the left console.

UPPER	Selects upper antenna.
BOTH	Provides automatic antenna selection.
LOWER	Selects lower antenna.

23.6.3 IFF Emergency Operation. The IFF emergency mode automatically becomes active upon pilot ejection from the cockpit.

23.7 COMMUNICATION-NAVIGATION-IDENTIFICATION INTERFACE

The radios, ADF, TACAN, MIDS (after AFC 270), ILS, data link, radar beacon, and IFF interface with the mission computer; and also interface with the CNI controls and upfront control displays through the communication system control. The communication system control (CSC) does the processing and data conversions necessary to communicate with and operate the equipment as commanded by the pilot through the UFC or by the mission computer. The CSC also does the processing for the UFC, including processing keyboard entries and providing the option readouts, cuing, and scratchpad display.

The CSC powers the UFC and converts standby attitude indicator signals used in the Electronic Attitude Display Indicator (EADI). If the CSC fails, the EADI display is unavailable.

CHAPTER 24

Navigation Equipment

Navigation equipment consists of the following: Inertial Navigation System (INS, AN/ASN-130A/139), Global Positioning System (GPS, AN/ASN 163) or Embedded INS/GPS (EGI), TACAN (RT 1159A/ARN-118), Instrument Landing System (ILS, AN/ARA-63), and Data Link (D/L, RT/1379A/ASW). Even though the ADF is part of the communication system, it has application in the navigation system and a brief description is provided.

24.1 NAVIGATION CONTROLS AND INDICATORS

Navigation controls and indicators consist of the UFC, HI/MPCD, DDI, HUD, INS mode switch, course set switch, and communication control panel. These controls and indicators are integrated in the navigation system. HI/MPCD and HUD symbology, and UFC functions are described in Chapter 2.

24.1.1 UFC. The UFC allows: ON/OFF operation of the ILS, TACAN, D/L, and ADF; data entry for the TACAN, GPS, and INS; and mode selection for the D/L.

24.1.2 Moving Map - Digital Map Set (DMS) (163985 AND UP). (Before AFC 327) The DMS utilizes the MPCD to provide the pilot/ WSO with a high resolution color map display for day/night navigation. The DMS display can be selected on the front or rear MPCDs; however, the DDIs display only a monochrome image.

(After AFC 327) The DMS is displayed in color and can be displayed on any DDI and the front and rear MPCD.

24.1.2.1 Map Option. The MAP option provides On/Off control of the DMS map when selected from an MPCD (MAP option is boxed when the map is ON). When MAP is selected from a DDI, the HSI format source alternates between stroke (DDI symbol generator) and raster (DMS mono-map) on all DDIs displaying the HSI format. The DMS map is commanded ON when the raster HSI is selected on a DDI or MPCD.

When Map Update is selected from the forward cockpit, the TDC is assigned to the Map Slew function. When Map Update is selected from the aft MPCD, the LDC is assigned to the Map Slew function (if the LDDI is not communicating on the AVMUX, the RDC will be assigned). When Map Update is selected from the Right or Left DDI, the RDC or LDC, respectively, is assigned to the Map Slew function. When Map Update is selected, MAP is automatically boxed. When Map Update is selected on a DDI, all DDIs displaying the HSI format are driven by the DMS mono-map.

24.1.2.1.1 DMS Map Range Scales. For HSI in T UP (Track Up) or N UP (True North Up), valid Range Scale/Map Type combinations are as follows: 40/1:2M, 20/1:2M-ZOOM, 10/1:500K, 5/1:250K.

For HSI in DCTR (Decenter) valid Range Scale/Map Type combinations are as follows: 80/1:2M, 40/1:2M-ZOOM, 20/1:500K, 10/1:250K.

Map compatible range scales are:

1. Centered (5, 10, 20, 40 nm)

2. Decentered (10, 20, 40, 80 nm)

24.1.3 HSI Display. The HI/MPCD displays: TACAN, INS (also INS alignment data), GPS, D/L, ILS, and ADF navigation symbology. The HI/MPCD also allows selection of various TACAN, ILS, INS, and D/L functions using the HI/MPCD option pushbuttons. See figure 24-1.

The forward and aft MPCDs are driven by a color output from the DMS when displaying the HSI format. The HSI format displayed on the DDI/MPCD is driven by either a mono-map output from the DMS or a DDI symbol generator. The DMS mono-map output contains the same information as the DMS color output (except for color), including cautions if they are provided with the color output. If the DMS fails, the MC commands the DDI to drive both MPCDs (forward and aft MPCDs are repeaters), and allows selection of all F/A-18 formats.

Navigation symbols and digital readouts are normally displayed on the MPCD. One of three TDC assignment symbols can be displayed in the upper right corner of a TDC compatible display, to indicate a TDC is assigned to the display in the front cockpit only, rear cockpit only, or both cockpits (respectively). When a TDC is assigned to the map slew function, SLEW is displayed in the upper right corner of the HSI display along with one of three arrows to indicate TDC assignment to the display in the front only, rear only, or both cockpits (respectively). See figure 24-1

24.1.3.1 HSI Option (After AFC 327). This option returns the operator to the Top Level HSI display after the DMS has been configured for operation. The HSI option coincides with the other HSI options found on similar HSI displays to ensure consistency between displays. See figure 24-2.

24.1.3.2 MODE Option (Aircraft 163985 AND UP). The HSI display MODE option is located adjacent to the center left pushbutton of the DDI or MPCD. Before AFC 327, selecting the MODE option enables T UP (Track-up), N UP (true north up), DCTR (decenter), MAP, and slew options to be displayed on the left side of the HSI display. After AFC 327, selecting the MODE option enables T UP (Track-up), CHRT (chart), DCTR (decenter), and slew options to be displayed on the left side of the HSI display. At aircraft power-up/WonW, the system initializes to: Map boxed (On), Centered, T UP, and 40 nm scale. See figure 24-1.

24.1.3.3 MODE Backup (Aircraft 163985 AND UP). If aircraft magnetic heading or aircraft horizontal velocities become invalid, the HSI format is limited to a Centered North-up mode. The T UP and DCTR legends are removed and their selection inhibited from the HSI Mode sublevel. The N UP legend on the HSI Mode sublevel is boxed under this condition. When aircraft magnetic heading and aircraft horizontal velocities become valid, the HSI format is driven to the currently selected mode and the T UP, N UP and DCTR legends are provided and processed on the HSI Mode sublevel.

NOTE

The currently selected HSI format mode option remains unchanged when the aircraft magnetic heading or aircraft horizontal velocities become invalid.

24.1.3.3.1 MAP Modes/Data Products. After AFC 327, each of the map modes (CHRT, DTED, and CIB) provides a different plan-view map/image. The actual presentation and availability of the different maps/images are independent and mutually exclusive. Only one map mode can be selected at any one time. The detailed images and associated area coverage for each mode are dependent on the map (theater) data loaded in the DMS or installed on the mission card. Each plan-view map, regardless of mode, presents an image that can support moving map capability and/or slew mode functions. When toggling through the different modes, different map images are available providing the mode specific

data is loaded/available for that particular geographic position and scale. The map modes and their associated data products are:

1. Chart (CHRT) mode provides a plan-view color map derived from Compressed ARC Digitized Raster Graphics (CADRG). This chart product replaces the Compressed Aeronautical Chart (CAC) map data currently used in the existing map (AN/ASQ-196).
2. Digital Terrain Elevation Data (DTED) mode provides a plan-view, panchromatic (gray scale), terrain plot with slope shading.
3. Controlled Image Base (CIB) mode provides a plan-view panchromatic image derived from a variety of mission planning, command, control, communications, and intelligence systems.

24.1.3.4 Map Data (163985 AND UP). The MDATA option is provided on the HSI/DATA sublevel format. MDATA is boxed when selected and remains boxed until A/C, WYPT, TCN, HSI, or INS/NAV CK is selected. When MDATA is selected, the DATA option is provided on the UFC. When MDATA is selected on the HSI, all DDI/MPCDs with the HSI format are driven by the DMS mono-map and the data frames are written in raster. The number of data frames is limited to 100.

24.1.3.4.1 Map Orientation Option. After AFC 327 this option is a multifunction option that combines the Track Up (T UP) and North Up (N UP) map orientation functions into a single option. Successive selections of the orientation option toggles the map between these two orientations as they are mutually exclusive. The T UP orientation is the default orientation. The DMS mono-map output contains the same information as the DMS color output (except for color), including cautions if they are provided with the color output. See figure 24-2.

24.1.3.5 SLEW Option (163985 AND UP). When map update is selected from the front cockpit, the TDC is assigned to the slew function. When map update is selected from the rear MPCD, the LDC is assigned to the slew function (if the left DDI has malfunctioned the right designator control is assigned). When map update is selected from the right or left DDI the right designator control (RDC) or LDC, respectively, is assigned to the map slew function. When map update is selected, MAP is automatically boxed and when selected on a DDI, all DDI and MPCDs displaying the HSI display are commanded to be driven by the DMS monochromatic map.

When WYPT Slew is selected from the forward cockpit, the TDC is assigned to the MAP Slew function for Waypoint Update. When WYPT Slew is selected from the aft MPCD, the LDC is assigned to the MAP Slew function for Waypoint Update (if the LDDI is not communicating on the AVMUX, the RDC is assigned). When WYPT Slew is selected from the right or left MPCD, the RDC or LDC, respectively, is assigned to the Map Slew function for Waypoint Update. When WYPT Slew is selected, MAP is automatically boxed. When WYPT Slew is selected on a DDI/MPCD, all DDIs/MPCDs displaying the HSI format are commanded to be driven by the DMS mono-map.

24.1.3.6 POS/XXX Option. This option is located along the top row of the HSI display and when selected provides the POS/XXX sublevel display. This sublevel display allows the selection of INS, MIDS (if installed), ADC, or TCN as the position keeping source. In addition, AINS and GPS can be selected in aircraft equipped with GPS. When one of these options is selected the top level HSI display is returned, with the appropriate selection denoted, i.e. POS/ADC. In non-GPS aircraft, POS/INS is automatically selected during ground operations when INS data is valid. Should the INS fail, the MC automatically begins ADC position keeping from the last valid INS position.

If MIDS is installed and operating, MIDS will be automatically selected as the aircraft position keeping source when INS fails. Because MIDS position keeping is unreliable and inflight alignment is not

possible when in POS/MIDS, air data position keeping (POS/ADC) should be manually selected if POS/MIDS is displayed.

In aircraft equipped with GPS, the normal present position keeping mode is Aided INS (AINS). In this mode the INS and GPS mutually aid each other to provide the optimal navigation solution. Automatic position keeping reversion with a hierarchy of AINS, INS, GPS, MIDS (if installed), and ADC is provided in case of an INS and/or GPS failure.

24.1.3.7 UPDT Option. The UPDT option is located along the top row of the HSI display and when selected provides the UPDT sublevel display. This sublevel display allows the selection of VEL (velocity), TCN, GPS, DSG (designation), AUTO, or MAP as the update source. Following the selection of one of the update options, an ACPT/REJ (accept/reject) display is presented in which the update can either be accepted or rejected. After selection of ACPT or REJ the top level HSI display is returned. There is no ACPT/REJ display presented when the AUTO option is selected. Velocity update is described in NTRP 3-22.4-FA18A-D and NTRP 3-22.2-FA18A-D NATIP. For F/A-18C/D, if a previous update has been accepted, a CANCEL option is also displayed on the UPDT sublevel which allows the aircrew to cancel the last accepted update.

24.1.3.8 SCL Option This option is located along the top row of the HSI display, and selects the range scales of 10, 20, 40, 80, or 160 nm. With aircraft 163985 AND UP, a 5 nm scale map is available. The scale is distance from the aircraft to the inside edge of compass rose. Successive actuations of the pushbutton causes the range scale to decrement and then to start over at 160 nm. The 250,000:1 map is displayed when the 5 nm range scale is selected. The 500,000:1 map is displayed when the 10 nm range scale is selected, and the 2,000,000:1 map is displayed when the 20 nm or 40 nm scale is selected. No map is displayed when the 80 nm or 160 nm range scale is selected.

24.1.3.9 MK Option. This option is located along the top row of the HSI display. The mark option is initialized to MK1 upon power up with WOW, regardless of the previous selection. A maximum of nine mark points may be entered. If all mark points have been used, and another mark point is entered, MK1 is replaced with the new mark data.

If a waypoint/OAP is not designated and the MK option is selected, the lat/long of the current overfly point is stored, with the elevation set to zero. If a location is designated, then the lat/long of the designated location is stored. In this situation, the aircraft altitude minus the altitude above the designated target is stored as the elevation.

24.1.3.10 DATA Option. The data option is located along the top row of the HSI display. Selecting this option provides the DATA sublevel display. This display is used to enter waypoint/OAP data, aircraft data (A/C), TACAN data, waypoint/OAP sequence data, radar and barometric altitude warning, groundspeed data, TOT data, and selection of the INS/NAV check display. Descriptions of the HUD EW, WYPT A/A and NCTR options are provided in the NTRP 3-22.2-FA18A-D NATIP. After selection of either the WYPT, A/C, or TCN option, the UFC or SEQUFC option is used to initialize the UFC for data entry. The HSI option is used to return the HSI display to the top level format.

24.1.3.11 WYPT, OAP Option. The WYPT, OAP option is located along the right side of the HI/MPCD. WYPT is displayed when steering is to a waypoint, and OAP is displayed when steering is to an OAP. If either the WYPT or OAP option is selected (boxed), direct great circle steering is provided to that waypoint/OAP. TGT is displayed at this location when a target is designated. If the selected waypoint is a GPS point, the GPS point identification code is displayed next to the WYPT option pushbutton.

24.1.3.11.1 Waypoint, OAP, Mark Point Selection. Along the right side of the HSI display just below the WYPT, OAP, TGT option, there are two arrows pointing in opposite directions with a number in between. This number indicates the current steer to waypoint/OAP/mark. The waypoint/OAP being steered to can be incremented/decremented by selecting the appropriate arrow option, thus changing the current steer to number. After all of the waypoints/OAPs have cycled through (0 through 24), the mark points can now be selected for display. Marks are displayed with an M preceding the number.

24.1.3.12 NAVDSG, O/S Option. This option is located along the right side of the HSI display. Selecting this option designates a waypoint/OAP, for weapon computations, sensor slaving, steering or position updating. Selecting the NAVDSG option designates the waypoint/OAP. After designating a waypoint, the NAVDSG option is removed, and TGT replaces WYPT. After designating an OAP, OAP remains boxed, and O/S replaces NAVDSG. When O/S is selected the offset point is designated, TGT replaces OAP, and O/S is removed.

24.1.3.13 SEQ # Option. The SEQ # option is located along the right side of the HSI display. At power up with WOW, this option initializes to SEQ 1 (unboxed). Successive actuations of the option toggles through a display sequence in the following order: SEQ 1 (boxed), SEQ 2 (unboxed), SEQ 2 (boxed), SEQ 3, (unboxed), SEQ 3, (boxed), and back to SEQ 1(unboxed). With the SEQ # option boxed, dashed lines are displayed connecting the waypoints of that sequence. The dashed lines connecting the waypoints (SEQ # boxed), are displayed for all HSI range scales, and all HSI modes. The dashed lines are removed when magnetic heading is invalid, aircraft position is invalid, or map slew is selected.

24.1.3.14 AUTO Option. The AUTO option is located along the bottom row of the HSI display. Selecting the AUTO option provides auto sequential steering to the first waypoint in the selected sequence; while boxing the AUTO and WYPT or OAP option (if not already boxed). Selecting the AUTO option while boxed deselects auto sequential steering and unboxes the AUTO option. The AUTO option is removed when: the INS is in an alignment mode, INS heading failure occurs, magnetic is invalid, aircraft present position is invalid, aircraft ground track is invalid, selected sequence contains less than two waypoints, aircraft is in auto or velocity update, FCS is coupled to the D/L or, a ground point is designated.

24.1.3.15 TIMEUFC Option. The TIMEUFC option is located along the bottom row of the HSI display. Selecting this option boxes TIMEUFC and initializes the UFC option display windows with the following clock options: SET (F/A-18C/D only), ET counter, CD timer, ZTOD, and LTOD (F/A-18C/D only). In aircraft equipped with GPS, it is important to load Zulu time as this aids in satellite acquisition. If local time is desired, it should be set after takeoff. This option is removed when: the INS is an alignment mode, INS heading failure occurs, or the aircraft is in velocity update. When TIMEUFC is selected, the 30 second timer is disabled.

24.1.3.16 MENU Option (163985 AND UP). When MENU is selected on the top level HSI display, the TAC Menu is displayed. The Tactical (TAC) option provides access to weapons, sensors and HUD formats. The TAC Menu is also displayed when the MENU option on any format is pressed. The Support (SUPT) menu is accessed through the Tactical (TAC) menu. When the SUPT menu is pressed, it provides access to the ADI, HSI, BIT, Checklists, Engines, Flight Controls, UFC Backup and Fuel formats.

24.1.3.17 L4MAP Option (F/A-18A/B). Refer to NTRP 3-22.2-FA18A-D NATIP.

24.1.3.18 SENSORS Option. Refer to NTRP 3-22.2-FA18A-D NATIP.

24.1.3.19 ACL Option. The ACL option is located along the left side of the HSI display. When selected, ACL is boxed and the link 4 display appears on the left DDI.

24.1.3.20 VEC Option. Refer to NTRP 3-22.2-FA18A-D NATIP.

24.1.3.21 D/L Option. Refer to NTRP 3-22.2-FA18A-D NATIP.

24.1.3.22 ILS Option. The ILS option is located along the left side of the HSI display. When selected, ILS is boxed and ILS steering appears on the HUD. On F/A-18C/D aircraft, ILS steering also appears on the EADI.

24.1.3.23 TCN Option. The TCN option is located along the left side of the HSI display. When selected, TCN is boxed and TACAN great circle steering appears on the HUD.

24.1.4 DDI. The DDIs are capable of displaying HSI display and D/L information by selecting the HSI or LINK4/SA option on the applicable menu.

24.1.5 HUD. The HUD displays basic flight symbology and steering information for the TACAN, ILS, ACL, INS, and GPS.

24.1.6 Sensor Control Panel. This panel contains the INS Mode Selector Knob, which controls INS mode selection. See figure 24-1.

24.1.6.1 INS Mode Select Knob. The INS mode select knob has switch positions of OFF, CV, GND, NAV, IFA, GYRO, GB, and TEST. Selecting OFF removes power from the INS. Selecting CV commands the INS carrier align mode with the MC providing the carrier align display. Selecting GND commands the INS ground align mode with the MC providing the ground align display. Selecting NAV commands the INS navigation mode which enables the MC to use INS information to provide navigation steering. Selecting IFA without GPS, commands the INS IFA (Inflight Alignment) mode with an IFA display. Selecting IFA with GPS, commands the Aided INS (AINS) position keeping or GPS inflight alignment with an IFA display. Selecting GYRO commands the AHRS (Attitude Heading Reference Set) mode. Selecting GB commands the gyro bias mode enabling the INS to do a gyro bias calibration. Selecting TEST enables the INS to perform an initiated BIT upon command from the MC.

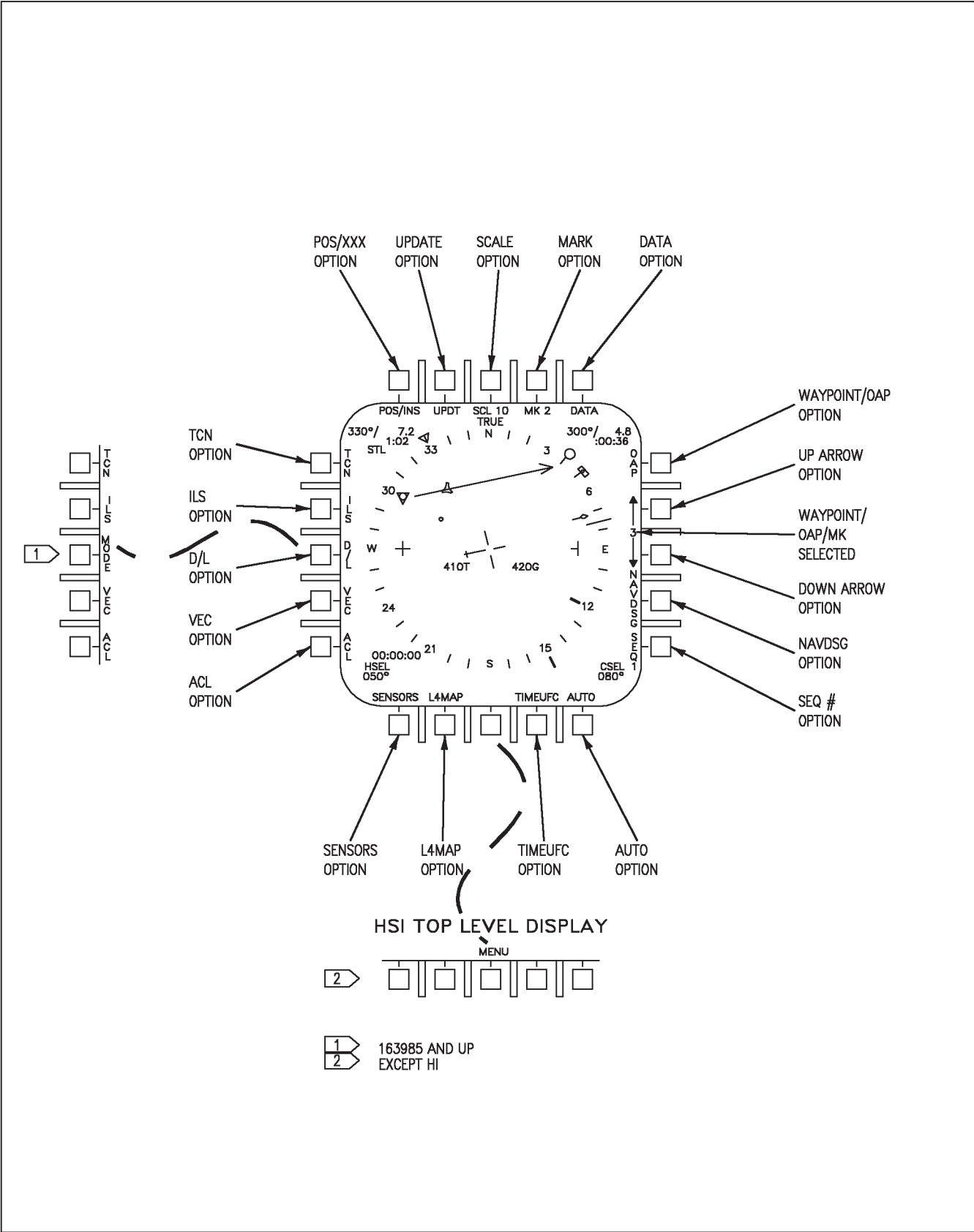
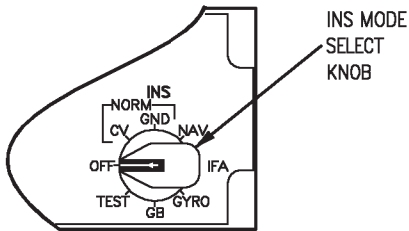
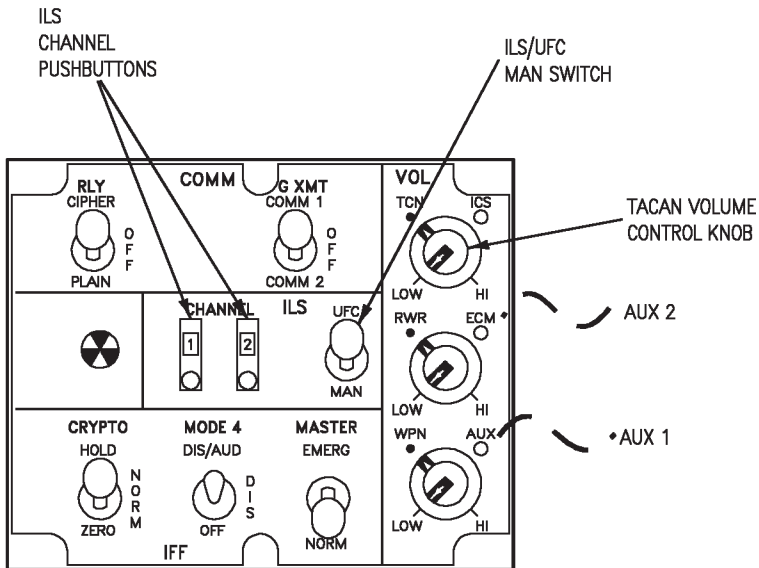
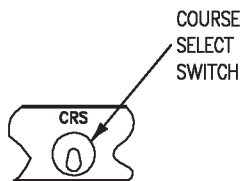

Figure 24-1. Navigation Controls and Indicators (Sheet 1 of 2)



SENSOR CONTROL PANEL



COMMUNICATION CONTROL PANEL

Figure 24-1. Navigation Controls and Indicators (Sheet 2 of 2)

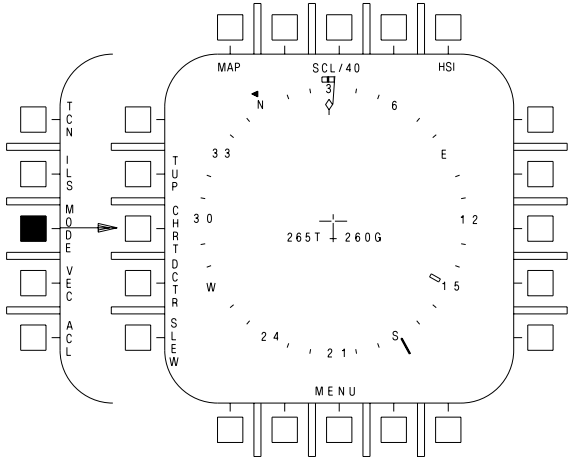

1. HSI MODE SUBLEVEL FORMAT

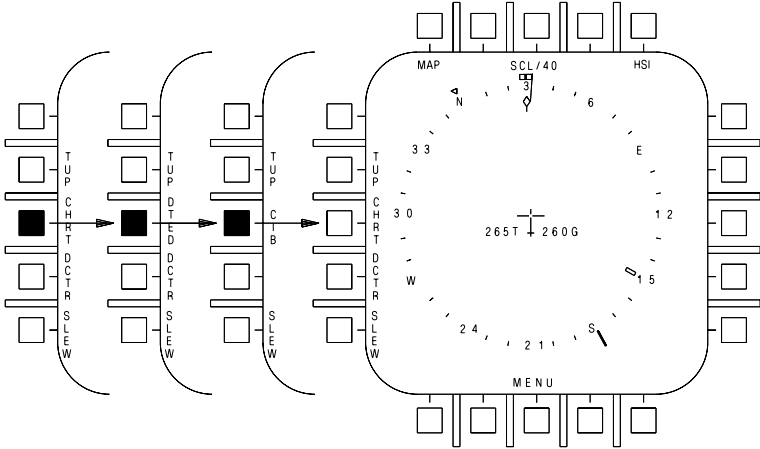

2. MAP MODE SEQUENCING

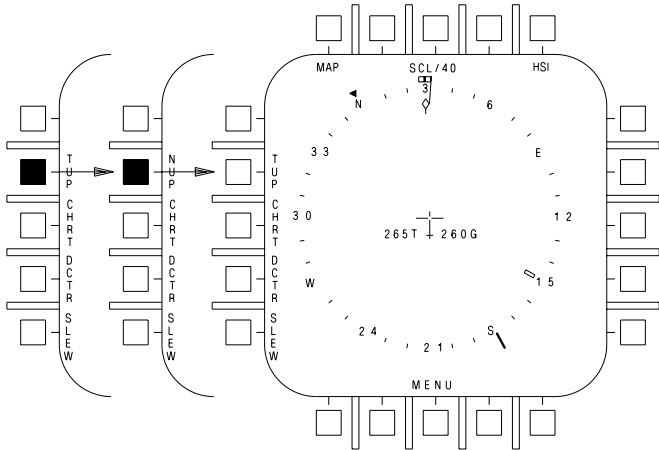

3. MAP ORIENTATION SEQUENCING

Figure 24-2. TAMMAC Mode Selections

24.1.7 Course Select Switch. The course select switch is used to set a course to the selected waypoint, OAP or TACAN station. When the switch is actuated with waypoint/OAP or TACAN direct great circle steering already selected, a course line appears through the waypoint/OAP or TACAN symbol on the HSI display, and steering information appears on the HUD. The course line rotates clockwise when the switch is held to the right and counterclockwise when the switch is held to the left. When a course is selected a digital readout appears on the lower right corner of the HSI display. See figure 24-1.

24.1.8 Communication Control Panel. This panel contains two ILS controls: ILS UFC/MAN switch and the ILS channel thumbwheels. It also contains the TACAN volume control knob.

24.1.8.1 ILS UFC/MAN Switch. When the switch is in the UFC position ILS power and channelization is controlled by the UFC. With the switch in the MAN position, ILS power is enabled and ILS channel changes are controlled by the ILS channel thumbwheels.

24.1.8.2 ILS Channel Thumbwheels. These thumbwheels are used to select ILS channels when the ILS UFC/MAN switch is set to MAN.

24.1.8.3 TACAN Volume Control Knob. This knob controls TACAN volume.

24.2 INERTIAL NAVIGATION SYSTEM (INS)/GLOBAL POSITIONING SYSTEM (GPS)

The AN/ASN-130A (aircraft 161353 THRU 163175 BEFORE AFC 231, 231 PT2, or 231 PT3), the AN/ASN-139 (aircraft 163427 THRU 164912 BEFORE AFC 175 PT2), the Embedded GPS/INS (EGI) (aircraft 161925 THRU 163175 AFTER AFC 231, 231 PT2, or 231 PT3), or the INS + GPS (aircraft 164945 AND UP, 163427 THRU 164912 AFTER AFC 175 PT2) inertial navigation system is a self-contained, fully automatic dead reckoning navigation system. The INS detects aircraft motion and provides acceleration, velocity, present position, pitch, roll, and true heading to related systems. Correction signals from accelerometers provide constant leveling. In GPS capable aircraft the INS is coupled to the GPS (in AINS mode) to provide a more accurate aided source of position and velocity.

The INS uses both periodic and initiated built-in test (BIT). The periodic BIT monitors essential parameters within the system and provides inflight, shipboard, and ground failure detection and isolation. Initiated BIT is performed on the ground and accomplishes that portion of the failure detection and isolation capability which periodic BIT is unable to do. The INS system provides automatic (AN/ASN-130A, manual for AN/ASN-139) INS degrading to an attitude heading reference system (AHRS) when INS BIT detects a significant fault in the inertial processor. An indication of automatic switching to AHRS is a flashing velocity vector on the HUD, a POS/ADC caution on the DDI and a master caution, provided that the INS is the position keeping source. Operating in AHRS mode, unfiltered INS attitude data is displayed to the pilot. While a properly functioning AHRS provides a very stable attitude reference, it is more susceptible to precession during sustained maneuvering flight

than the inertial mode. Slow climbs/dives, less than 7,000 feet per minute, can cause an error in the INS vertical velocity for a short time resulting in an INS VEL/NAV VVEL caution. The error goes to zero within a couple of minutes after the aircraft levels off and the caution goes away.

WARNING

There are some subtle failure modes wherein INS attitude and/or velocity can degrade or fail and the INS does not provide an indication of the condition. Therefore, prior to and during flight conditions in which accurate attitude information is required, a crosscheck of primary attitude indications versus standby attitude instruments should be performed. This crosscheck should also include the true airspeed/groundspeed relationship on the HI/MPCD. If the BIT display indicates an INS/ADC degrade, the standby instruments should be monitored and the INS/NAV CK display consulted to determine component malfunction.

CAUTION

Landings and catapult shots, without power applied to the INS, could cause damage to the accelerometers within the INS.

NOTE

It is acceptable to taxi with the INS in the OFF mode. It is preferable to wait for NO ATT to disappear before taxiing.

24.2.1 Inertial Navigation Unit (INU). The INU contains an inertial measurement unit (IMU) section, signal data converter section, and power supplies.

24.2.1.1 Inertial Measurement Unit (IMU) (AN/ASN-130A). The IMU contains a gyro stabilized platform and other electronics to maintain a stabilized platform and interface output signals with the signal data converter. If the signal data converter fails, the IMU operates as an attitude and heading reference set (AHRS).

The platform contains three accelerometers and two gyros which are isolated from external angular motion by a set of four gimbals. Gimbal motion and position are sensed by pick-off coils and synchro devices. Four-gimbal mounting provides a full 360° freedom of rotation about the stable element, allowing it to remain level with respect to local vertical and oriented to its alignment heading.

Platform outputs of acceleration, gyro motion, gimbal motion, and position are processed to align the platform in pitch, roll, and azimuth. After alignment, acceleration and attitude signals are used in the navigation computations. Signals representing pitch, roll, and relative azimuth are developed for aircraft attitude indications.

24.2.1.2 Inertial Measurement Unit (IMU) (AN/ASN-139 and EGI). The inertial measurement unit (IMU) contains ring laser gyros, accelerometers, and sensor electronics.

Three ring laser gyros (RLGs), one mounted in each aircraft reference axis, detect motion in their sensitive axis and provide channel A and channel B frequency outputs to sensor electronics.

Three accelerometers, one mounted in each aircraft reference axis, detect acceleration along their sensitive axis and provide linear acceleration to sensor electronics.

Sensor electronics monitor RLG and accelerometer operations to provide stabilization. Torque rebalance outputs provide accelerometer stabilization. Sensor electronics also provide processing of Channel A, Channel B, and acceleration inputs. Channel A and Channel B inputs are processed producing rotational counts representing aircraft roll, pitch, and yaw rates. Acceleration inputs are processed producing delta acceleration outputs.

24.2.1.3 Global Positioning System (GPS) (Aircraft 163427 THRU 164912 AFTER AFC 175 PT2, Aircraft 164945 AND UP, and aircraft with EGI). The Global Positioning System provides position, velocity, and time (PVT) data that can be used as an aid to the INS or as an independent navigation sensor.

NOTE

Standard military GPS systems do not provide a navigation integrity function which would monitor and crosscheck the validity of satellite transmitters and GPS receivers. GPS is only authorized as an aid to visual navigation (VFR) and situational awareness (SA). GPS may not be used as a primary or supplemental navigation source to file or fly in the National Air Space (NAS).

The GPS consists of an aircraft mounted receiver/processor which receives modulated signals from twenty-four high orbit satellites through the GPS antenna. The satellite data is used to determine aircraft position and velocity. The GPS can be initialized with crypto keys, enabling encrypted P-code (precise) navigation signals to be received. GPS has four modes of operation. In NOT READY mode the system is off. With Initialize mode (INIT) the power supply is turned on, almanac data and waypoint data are loaded into the MC. In addition, Cryptokey loading may be performed via a KYK-13. In NAV mode, the GPS tracks the best four satellite constellations possible to provide the most accurate PVT solution. TEST mode is provided for maintenance and inflight testing.

24.2.1.3.1 Mixed Mode Satellite Selection (MC OFP 15C AND UP). The mixed mode satellite function allows the pilot to track non-encrypted GPS signals when an encrypted signal is not available. Two modes of operation, secure mode (encrypted code only) and non secure mode (encrypted and/or non-encrypted code) can be selected via the NOSEC GPS option on the A/C DATA sublevel display. The secure mode is the default mode upon aircraft power up.

24.2.1.3.2 YCODE Advisory (MC OFP 12A, 15C AND UP). A YCODE advisory is displayed when encrypted GPS signal tracking is lost while in secure mode. Remaining in secure operation with a YCODE advisory can cause the aircraft to lose the ability to use GPS data.

24.2.1.3.3 NOSEC Advisory (MC OFP 15C AND UP). A NOSEC advisory is displayed when GPS is not in a secure mode.

24.2.1.4 Inertial Navigation (NAV) Mode. For aircraft without GPS installed, NAV mode is the primary mode of operation for the INS. In NAV the INS provides smoothed attitude and attitude rates to the MC for use in sensor stabilization. The INS provides position, velocity and acceleration information for navigation and weapon delivery.

24.2.1.5 Aided INS (AINS) Mode. For aircraft with GPS installed, Aided INS (AINS) is the primary position keeping mode. In AINS mode the INS and GPS are mutually aiding each other to provide an

optimal navigation solution. AINS is selected by placing the INS mode switch to IFA after a GND or CV alignment. The position keeping mode remains AINS unless GPS satellites are lost, an INS or GPS failure occurs, or the pilot manually chooses a different position keeping source. In AINS with ASN-139 INS, horizontal position is updated every 40 seconds, and velocities every 5 seconds. In AINS with EGI INS, horizontal position and velocity is updated every 4 seconds.

24.2.1.6 Attitude Heading Reference System (AHRS) Mode. The AHRS mode of the ASN-130 INS provides unfiltered attitude data to the MC when INS BIT detects a malfunction within itself or other hardware that precludes inertial navigation. AHRS mode can be selected by placing the INS switch to GYRO.

24.2.1.7 INS Signal Data Converter. The signal data converter contains the computer central processor unit (CPU), memory unit, IMU interface, and the primary INS input/output interface. The CPU provides for initial alignment and navigation computations. The CPU processes acceleration and attitude signals for computing east/west, north/south and vertical velocities and true heading. Also, the calculations for inertial altitude and aircraft present position are computed. The CPU also provides platform correction signals for all modes except AHRS.

24.2.2 INS BIT. Refer to Chapter 2, STATUS MONITORING SUBSYSTEM, INS BIT.

24.2.3 INS Alignment Modes. There are three types of INS alignment modes that can be selected via the INS Mode Selector Knob: CV (carrier alignment), GND (ground alignment), and IFA (radar inflight or GPS alignment).

24.2.3.1 CV Alignment Mode. Selecting CV alignment provides three types of CV alignment options: RF (radio frequency), CBL (cable), and MAN (manual). With the RF and CBL alignment options the aircraft is data linked to the SINS (ships inertial navigation system). However, with the MAN option there is no data link capability and alignment data must be entered manually.

24.2.3.1.1 RF/CBL (SINS) Alignment. With the RF/CBL (SINS) alignment, the aircraft's INS automatically compensates for the difference between the aircraft deck position and the SINS position. To perform this alignment, the parking brake must be set, and the INS mode selector knob must be switched to CV. When this is done the INS and data link are turned on, and the CV align display appears on the HSI display and UFC. At this point in time, the TIME display on the CV align display begins to increment. When proceeding with an RF alignment, information is received via radio frequency and RF is displayed to the right of CV on the CV align display. Also, the alignment frequency is displayed on the UFC scratchpad, which may be changed using the UFC keypad. When a cable is connected to the aircraft, information is received via the cable and CBL is displayed to the right of CV on the CV align display. RF/CBL flashes until SINS data becomes valid. During the first 1 to 2 minutes of alignment, the INS platform is being leveled (AN/ASN-130A), and NO ATT is displayed to the right of QUAL: on the CV align display. While the platform is being leveled a total of 10 waypoints can be received. When 10 waypoints have been received WYPTS is displayed below the time readout. If all waypoint data is not received, NO WYPTS is displayed below the time readout. Reception of waypoint data is not required for the alignment to proceed. After the platform has leveled, NO ATT is replaced with a quality number, and the INS begins to determine true north. The quality number is an estimate of present position accuracy. See figure 24-3.

When INS velocities become valid the quality number is replaced with OK and the INS may be switched to NAV. When NAV is selected, the alignment display is removed from the CV align display and the UFC displays the OPER option and operate frequency on the UFC scratchpad. At this point in time the INS present position is stored into waypoint zero if it is valid. However, if NAV is not

manually entered at weight off wheels and a groundspeed of greater than 80 knots, the INS automatically switches to NAV. At this time the INS also stores INS present position (if valid) into waypoint zero. If INS present position is invalid, aircraft present position is entered as waypoint zero.

24.2.3.1.2 INS CV Alignment (RF OR CBL) (SINS Procedures). The alignment procedures using SINS by RF or CBL input are the same. If the cable is not hooked up by the ground crew, then RF is used. For either RF or CBL alignments, the aircrafts INS automatically compensates for the difference between the aircraft deck position and the SINS position. Waypoint align data is not required for an RF or CBL carrier alignment since it is supplied by SINS.



- If the INS shuts down abnormally (power loss), set the INS mode selector knob to OFF for a minimum of 3 minutes (AN/ASN-130A). The AN/ASN-139 and EGI requires 5 seconds OFF time.
- If the INS mode selector knob is turned OFF in less than 40 seconds after selecting CV, the system must be left off for a minimum of 3 minutes (AN/ASN-130A). The AN/ASN-139 requires 5 seconds OFF time.

1. Parking brake - SET
2. ATT select switch - AUTO or INS
3. INS mode selector knob - CV

NO ATT appears on the HI/MPCD during the first 1 to 2 minutes of alignment and then is removed. CV RF or CV CBL, QUAL:, TIME:, and WYPTS are displayed on the HI/MPCD. The RF or CBL symbol flashes until the SINS data is tested for validity, then the QUAL digits start counting down and the TIME digits start counting up. If the alignment is interrupted for any reason, the TIME digits stop counting up and flash. After 20 seconds NO is displayed to the left of the word WYPTS if waypoints have not been received. When the INS alignment is completed, the word OK is displayed after the QUAL number. Time to align is normally less than 10 minutes. On aircraft 161925 AND UP, D/L align frequency is automatically displayed on the UFC scratchpad for 30 seconds after selecting CV align.

After alignment is complete -

4. INS mode selector knob - NAV (without GPS)/NAV or IFA (with GPS)

24.2.3.1.3 CV MAN (Manual) Alignment. A CV manual alignment is performed if the data link signal is not available or not desired by entering CV data via the UFC. Manual carrier alignment takes approximately 15 minutes.

NOTE

In aircraft equipped with GPS, GPS alignment may be performed in lieu of a manual alignment.

To perform a CV manual alignment, the parking brake must be set and the INS mode selector knob must be switched to CV. When this is done the INS and data link are turned on, and the CV align display appears on the HI/MPCD and UFC. Now select the MAN option to enable the manual align

display on the HI/MPCD and UFC. When MAN is selected MAN is boxed and the STD HDG option is removed, the manual align display allows entry of carrier lat/long data, heading (CV HDG) and speed (CV SPD). The INS uses this data to update present position during the alignment. See figure 24-3.

During the alignment NO ATT is displayed on the CV align display until the INS platform is leveled, then a QUAL (quality) number is displayed. The AC (alignment counter) number on the INS maintenance align 1 display on the DDI should also be monitored during alignment. To select INS align 1 display, press the BIT pushbutton on the DDI menu display, then press the MAINT pushbutton on the maintenance BIT display. As the alignment progresses the qual number on the HSI decreases and the AC number on the DDI increases. When a satisfactory alignment is achieved, OK is displayed next to the QUAL number. The INS can then be switched to the NAV mode. If it is not switched, it automatically reverts to the NAV mode when weight is off the wheels. If during manual alignment the carrier heading changes more than 10° and/or carrier speed varies more than 1 knot, and the AC number on the DDI is 3 or less, the pilot must enter the new data to reinitialize the alignment. This usually results in the QUAL number starting over at 99.9, however, it will rapidly align back to the QUAL number it had prior to the update and the continuation of the alignment will be faster than if the update had not been made. When AC=4 is displayed on the DDI the INS tracks CV heading and speed changes and the INS does not need to be reinitialized. The parking brake must remain set until alignment is complete. If the parking brake is released before OK is displayed, and the align quality is greater than 5 the system sequences into AHRS (GYRO) mode. If the action occurs with the align quality less than 5, the system goes to a limited performance navigation mode or complete reinitialization is required to complete the normal alignment, see figure 24-3. The pilot can enter present position anytime after selecting the INS manual carrier alignment mode.

24.2.3.1.4 INS CV Alignment (Manual Procedures). If an RF or CBL alignment is not possible or not desired, the existing carrier coordinates, course (CHDG) and speed (CVEL) can be manually entered while the carrier is maintaining a constant course and speed.



- If the INS shuts down abnormally (power loss), set the INS mode selector knob to OFF for a minimum of 3 minutes (AN/ASN-130A). The AN/ASN-139 requires 5 seconds OFF time.
- If the INS mode selector knob is turned OFF in less than 40 seconds after selecting CV, the system must be left off for a minimum of 3 minutes (AN/ASN-130A). The AN/ASN-139 requires 5 seconds OFF time.

1. Parking brake - SET

The parking brake must remain SET until the manual alignment is complete. If the parking brake is released before the alignment is complete the alignment must be re-initiated.

2. ATT select switch - AUTO or INS

3. INS mode selector knob - CV

4. HI/MPCD - PRESS MAN

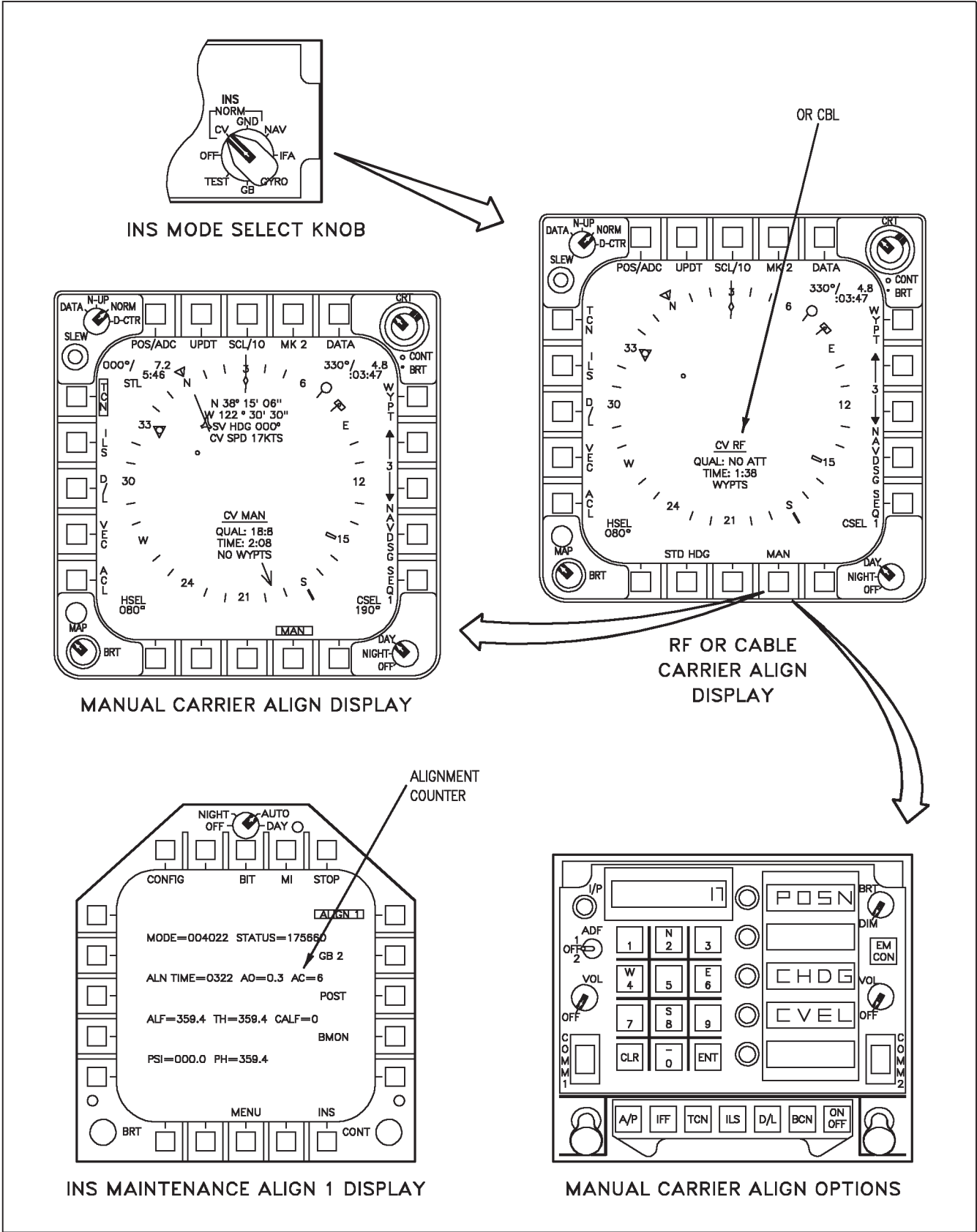

Figure 24-3. INS CV Align

On the UFC -

5. POSN option - PRESS, type N/S latitude, ENT
6. Type E/W longitude, ENT
7. CHDG option - PRESS, type true heading, ENT
8. CVEL option - PRESS, type velocity, ENT

After alignment is complete -

9. INS mode selector knob - NAV (without GPS)/ - NAV or IFA (with GPS)

NOTE

On GPS equipped aircraft, selecting IFA without an OK results in transition to IFA RDR.

24.2.3.2 GND (Ground) Alignment Mode. To perform an INS ground alignment, the parking brake must be set, and the INS mode selector knob must be switched to GND. When this is done the INS is turned on, and the GND align display appears on the HI/MPCD. At this point in time, the TIME display on the GND align display begins to increment. During the first 1 to 2 minutes of alignment (AN/ASN-130A), the INS platform is being leveled, and NO ATT is displayed to the right of QUAL: GND align display. After the platform has leveled NO ATT is replaced with a quality number and the INS begins to determine true north. The quality number is an estimate of present position accuracy. The aircraft may be taxied without restarting the alignment, however; the parking brake must be reset to complete the alignment, see figure 24-4.

NOTE

The most accurate alignment of the AN/ANS-139 and EGI is achieved by changing aircraft heading by at least 70° (180° optimum) after OK is displayed next to the quality number and allowing the alignment to continue.

The MC automatically transfers waypoint zero to the INS to be used as aircraft present position. This information appears on the GND align display. Waypoint zero position can be updated prior to selecting GND align. However, if an error is noticed after the alignment has begun, aircraft present position must be corrected since waypoint zero is transferred to the INS only once. If the aircraft present position is found to be incorrect, it must be corrected or the INS will align improperly. Refer to A/C Programming, this chapter to enter new aircraft position data.

After the INS alignment has reached an acceptable level (.5 is the lowest displayed), OK is displayed next to the quality number and the INS may be switched to NAV. When NAV is selected, the alignment display is removed from the HI/MPCD. If the NAV mode is not manually entered, the INS automatically switches to NAV when groundspeed is greater than 80 knots and weight is off wheels.

24.2.3.2.1 Stored Heading (STD HDG) Alignment. If the INS has been shut down after a good alignment, the aircraft has not been moved, and NAV has not been selected, a stored heading alignment may be selected to reduce INS alignment time. The STD HDG option is provided on the CV/GND align display. The STD HDG option is removed when the alignment has progressed to the

point where selecting the STD HDG option will not reduce alignment time and during a CV alignment when the MAN option is selected. Selecting the STD HDG option results in an alignment based on the stored heading when the INS was shutdown. To enter stored heading alignment, set the parking brake, place the INS mode select knob to CV/GND (This provides the CV/GND alignment display on the HI/MPCD, see figure 24-4) and select the STD HDG option. When stored heading alignment is entered, the alignment progresses the same as a normal ground alignment.

24.2.3.3 Incomplete Alignment Advisory (MC OFF 13C AND UP). An incomplete alignment advisory ~~ALGN~~ is displayed when the INS is manually switched to NAV without a complete alignment.

24.2.3.3.1 IFA (Inflight Alignment) Mode. There are several types of IFA: a complete IFA, a CV/GND alignment completion, or a gyro recovery. Aircraft equipped with GPS can perform an inflight alignment using GPS position and velocity. A complete IFA may be performed when the INS experiences a total shutdown. An IFA may be performed to complete a partial CV/GND alignment. A gyro recovery may be performed when the INS completely shuts down, and radar or ADC data is not available for a complete IFA, see figure 24-5.

24.2.3.4 Inflight Alignment. A complete IFA may be initiated after a total INS shutdown. During IFA, the ADC must be available to provide magnetic heading information, and the radar must be capable of providing continuous precision velocity update (CONT PVU) information. Once the INS has shutdown, place the ATT/ATTD switch to STBY to verify the accuracy of HUD attitude data by crosschecking the standby instruments. Select NAV master mode and radar altitude to HUD. Then place the INS knob to OFF for 5 seconds for the AN/ASN-139 and EGI (AN/ASN-130A requires 3 minutes). If MSP codes 02F or 061 are present, the INS knob should remain in OFF, and select POS/TACAN.

NOTE

- MSP codes 02F or 061 indicate that NAV data is frozen and the NAV data provided to the HUD is not reliable. IFA is no longer possible.
- If POS/MIDS is the current aircraft position source, select POS/ADC before commencing IFA procedures.

Bring up the A/C DATA sublevel display on the HI/MPCD to check winds aloft, present position, and magnetic variation. If A/C data is incorrect, refer to A/C Programming (this chapter), to enter correct aircraft data. Fly straight and level unaccelerated flight for 20 seconds, then place the INS knob to IFA (INS has been off for 5 seconds for the AN/ASN-139 and EGI or 3 minutes for AN/ASN-130A) and maintain straight and level unaccelerated flight for at least 30 seconds. Then fly straight and level as much as practical.

When IFA has been selected, the radar may be commanded to the PVU mode and the alignment display appears on the HI/MPCD, see figure 24-5. If the PVU mode is initialized, CONT PVU and SEA options are default selected (boxed). Verify the proper radar PVU mode is selected (LAND or SEA) and the TIME display begins to increment. During the first 10 to 25 seconds (AN/ASN-139 and EGI) or 1 to 2 minutes (AN/ASN-130A) of the alignment while the INS platform is being leveled, NO ATT is displayed to the right of QUAL on the Inflight Align display. Wait for 30 seconds of align time for the platform to level, then place the ATT/ATTD switch to AUTO or INS. NO ATT is then replaced with a quality number (which is an estimate of present position accuracy) and the INS ATT caution clears. Selecting INS or AUTO with the ATT/ATTD switch also replaces standby attitude reference data with INS attitude data (the waterline symbol on the HUD is replaced with a slowly flashing

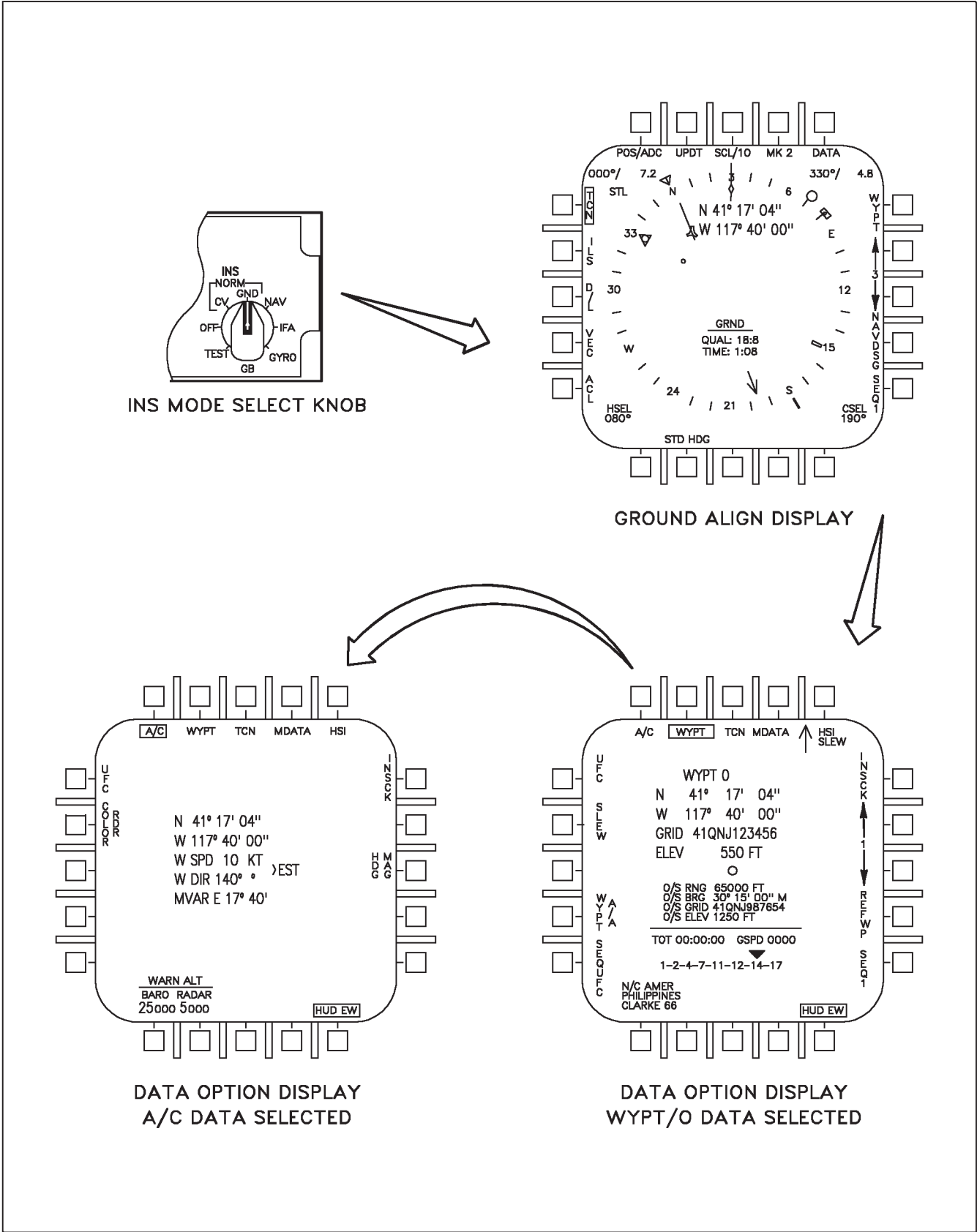
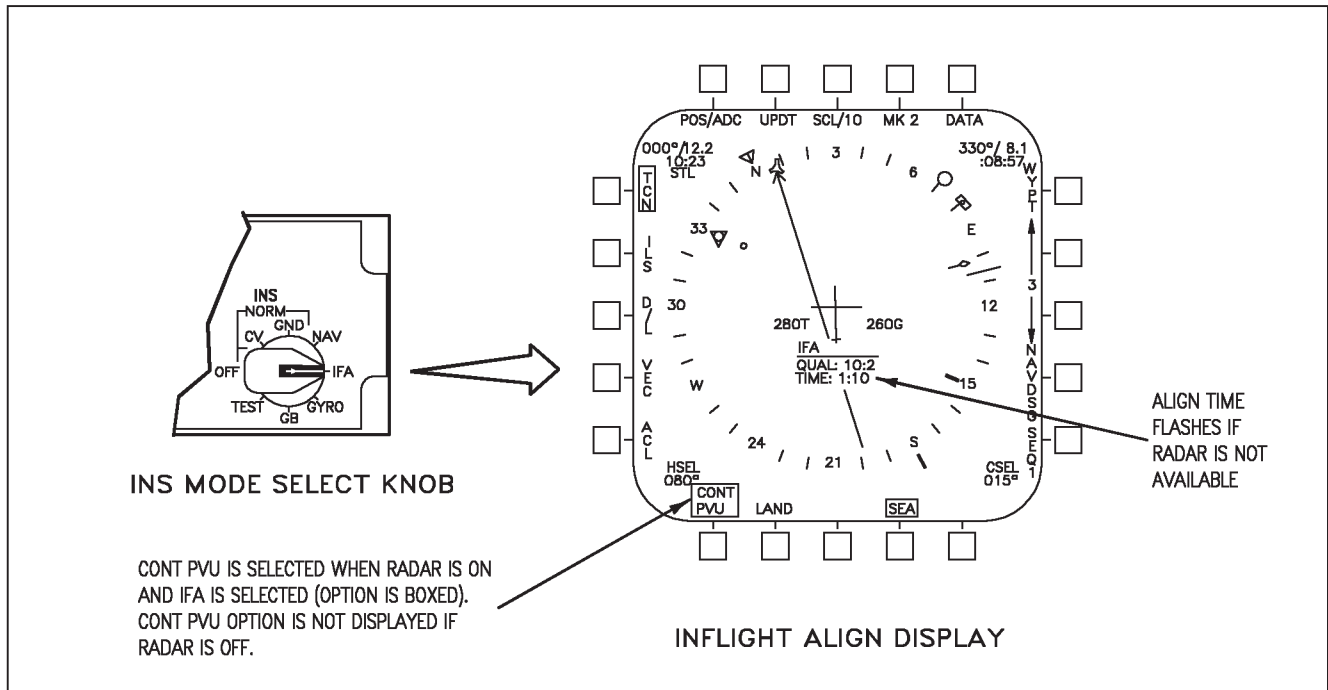

Figure 24-4. INS Ground Align



18AC-NFM-00-(76-1)31-CATI

Figure 24-5. INS Inflight Align

velocity vector). When horizontal position becomes valid, the POS/ADC caution clears. The velocity vector continues to slowly flash until velocities become valid (at approximately align quality of 5.0).

If MSP code 67 is present, select NOSEC on A/C DATA sublevel display.

NOTE

Selecting NOSEC reinitializes satellite acquisition, results in a MIXED advisory, and makes EGI susceptible to spoofing. If GPS keys are not loaded and NOSEC is not selected, the IFA may not complete.

Determine and continue to monitor alignment type during the duration of the IFA.

24.2.3.4.1 If GPS Data Available During Alignment (IFA GPS). Good satellite data for the IFA is indicated by IFA GPS on the HSI display as shown in figure 24-6. If GPS acquires good satellite data, perform one gentle 90° S-turn (less than 20° AOB and $\pm 10^\circ$ pitch) to facilitate GPS IFA. Then maintain straight and level flight as much as practical. GPS IFA takes approximately 10 minutes.

When the INS achieves align complete, the IFA GPS legend is removed and the MC automatically transitions back to AINS position keeping mode. This is indicated by the NAV display replacing the IFA GPS align display. If good GPS satellite data is available and then lost while an IFA GPS align is being performed, the INS goes to align hold for 65 seconds waiting to reacquire good satellite data. If good satellite data is reacquired within 65 seconds, the INS continues to align using GPS data. If good

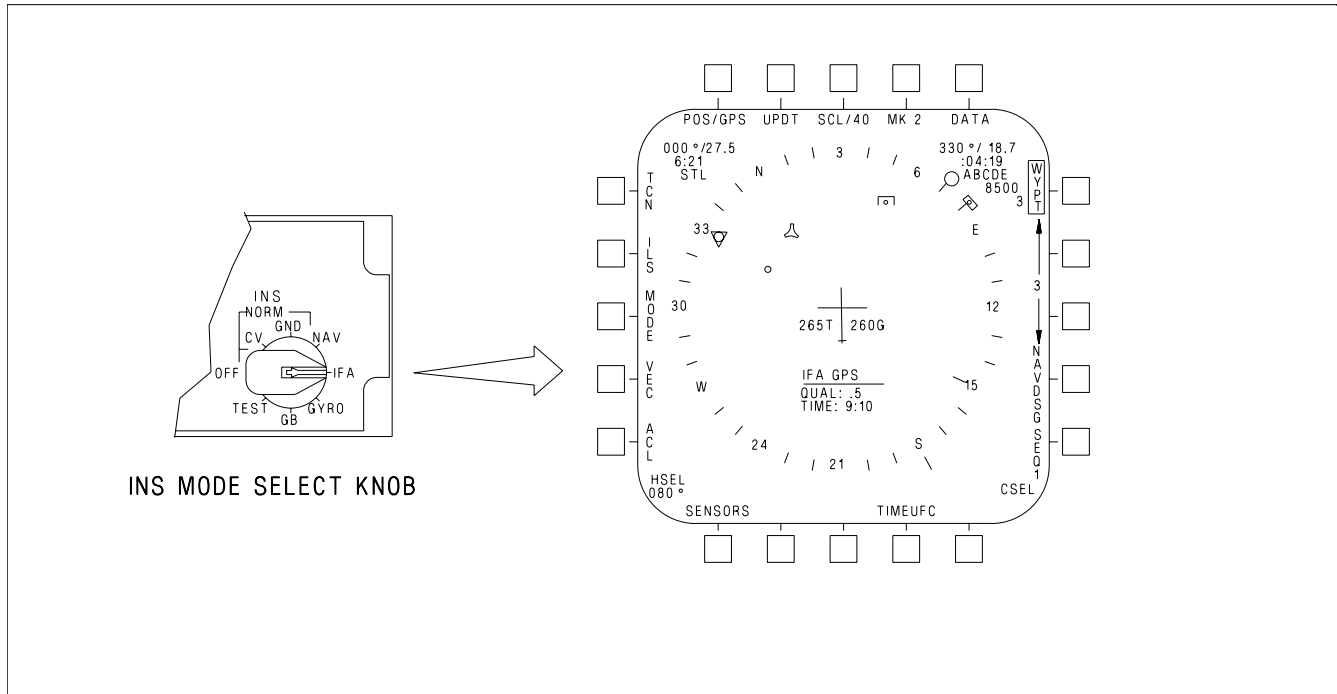

Figure 24-6. INS Alignment Display with GPS

ADA520-NFM-00_329-1-34

satellite data is not reacquired within 65 seconds, the MC attempts to finish the INS alignment with a radar IFA as described below.

NOTE

Monitor alignment type on HI/MPCD frequently to ensure GPS data is available for the alignment. If GPS data is not available, the HI/MPCD will display IFA RDR.

24.2.3.4.2 If No GPS Data Available During Alignment (IFA RDR). Fly straight and level for as much as practical during alignment. If a turn must be made during IFA, make the turn quickly (exceeding 30° of bank) and return to straight and level flight as soon as practical. This prevents the INS from aligning to a false reference by placing the alignment on hold until straight and level flight is regained. During IFA, air data dead reckoning is used for navigation and to maintain a current present position. If GPS is acquired, finish the INS alignment with GPS IFA as described above.

When the inflight align displays an OK after the QUAL number, place the INS knob to the NAV position.

The PVU mode may be overridden by deselecting the CONT PVU option; however, IFA quality will be affected. Deselecting CONT PVU commands PVU for 10 seconds of each minute alternating with the last selected radar mode. When air-to-ground ranging (AGR) mode is selected (for instance, via HUD designation), CONT PVU is deselected, 20 seconds of AGR is commanded, then PVU is commanded for 10 seconds of each minute alternating with AGR. In PVU mode, the radar provides Doppler velocities for the INS alignment. The radar look-down velocities angles are optimized for land or sea return by selection of the LAND or SEA options at the bottom of the display. PVU is inhibited for IFA if the aircraft is not in the NAV master mode. If the radar is not operating or if it is inhibited from operating in PVU, the time-in-alignment display flashes and the CONT PVU is not displayed since continuous PVU cannot be commanded. Present position can be provided for the alignment by

performing a position update using the UPDT option or by entering the aircraft data via the UFC using the DATA option. Another very good technique is to select TACAN position keeping if a stationary TACAN is available. Velocity updates cannot be performed during position updates during IFA. The VEL update option is still displayed but it returns to the Inflight align top level display upon selection.

WARNING

Following an IFA with RADAR, make every attempt to maintain VMC with a discernible horizon. Residual attitude errors may be subtle and difficult to discern without reference to a visible horizon or the standby instruments. If velocity vector information is suspect, select STBY to the HUD.

Crosscheck attitudes, velocities, and position, especially when entering terminal approach phase.

24.2.3.4.3 CV/GND Alignment Completion (Aircraft without GPS). An IFA may be used to complete a partial CV/GND alignment. At takeoff with a partial alignment the INS platform should already be leveled (no INS ATT caution). Therefore, all that needs to be done is to place the INS mode select knob to IFA with the appropriate PVU option selected, until an OK is displayed.

24.2.3.4.4 Gyro Recovery. A Gyro recovery is actually an attitude only INS in which reliable INS attitude data is recovered. Since only attitude information is being recovered, ADC and radar inputs are not required. To set up for a Gyro recovery, place the ATT select switch to AUTO or INS, and maintain straight and level unaccelerated flight. Next place the INS mode select knob to OFF for 3 minutes to allow the gyros to spin down (AN/ASN-130A). The AN/ASN-139 and EGI require 5 seconds OFF time. Then set the INS mode select knob to the GYRO position. As the platform levels, the INS ATT caution clears, and the INS attitude data replaces the standby reference indicator data on the HUD. Also, the flashing velocity vector replaces the waterline symbol until GPS velocity data is valid. At that point, the velocity vector stops flashing.

ASN-139 and EGI equipped aircraft provides a Gyro mode if the aircraft takes off before an adequate alignment is completed.

NOTE

The flashing velocity vector will be present for the remainder of the flight in this mode since no attempt will be made by the system to recover valid velocities.

Another method of performing a Gyro recovery would be to select IFA after being in OFF for three minutes, then select NAV after INS attitude becomes valid.

24.2.4 INS Check Display. The INSCK (INS check) display allows analysis of INS/GPS/ADC functional reliability. The velocity check more readily indicates an INS vertical loop problem. INS, GPS, and ADC vertical velocity will be periodically compared for the pilot. When an excessive disagreement between the two is sensed, a master caution light and tone comes on and the INS VEL caution illuminates.

The display is selected on the DATA sublevel display, by selecting the INSCK/NAVCK option. The top portion of the display consist of INS, GPS, and ADC velocities. The bottom portion consists of wind velocities, best available MC groundspeed (if valid) and best available MC true airspeed (if not

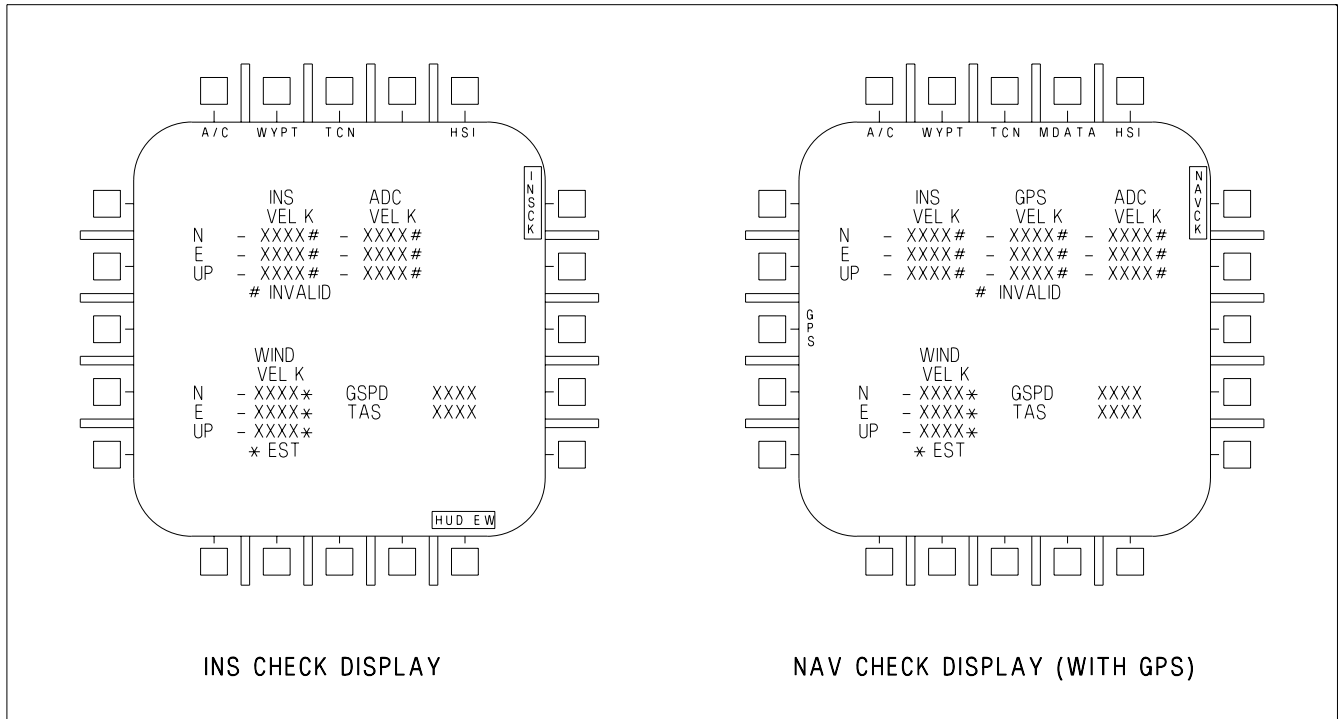

Figure 24-7. NAV/INS Check Display

18AC-NFM-00_114-1-34

zero). INS, GPS, and ADC velocity components are displayed on the INS Check display even if invalid. If INS, GPS, or ADC data is invalid, a # is displayed to the right of the invalid data along with # INVALID displayed above the wind velocity components. If wind velocity is estimated, a * is displayed to the right of the wind velocity components along with * EST displayed at the bottom of the format, see figure 24-7.

24.2.4.1 NAV Check Display. With MC OFP 12A, 13C AND UP, INSCK is renamed NAVCK and the function is identical as described above.

24.2.5 Waypoints, Offset Aimpoints (OAP) and Offsets. A waypoint is a geographical point whose latitude, longitude and elevation are stored in the MC. An OAP is a waypoint which has an offset associated with it. An offset is a point defined by bearing and range from the OAP along with elevation of the point (offset).

Mission data may be entered using the Data Transfer Equipment (DTE).

24.2.5.1 Waypoint/Offset Aimpoint Programming. To enter waypoint/OAP data, select the DATA option on the HSI top level display. The waypoint data display is automatically initialized with WYPT boxed. This display shows the current waypoint/OAP data: waypoint Lat/Long position, UTM Grid coordinates, and elevation; offset range, GRID, bearing, and elevation (if applicable). To enter waypoint/OAP data, select an up/down arrow to select the desired waypoint/OAP. Next, select the UFC option to initialize the UFC for waypoint/OAP data entry. On the UFC select the POSN pushbutton to enter lat/long data, the GRID pushbutton to enter UTM GRID data, the ELEV pushbutton to enter elevation data, and the O/S pushbutton to enter offset data (offset range, bearing, and elevation). Offset data is in relation to the offset aimpoint. Waypoint/OAP data is entered through the UFC keypad. With MC OFP 10A AND UP, there is a maximum of 25 waypoints (0 to 24) available for programming. With MC OFP 13C AND UP, there is a maximum of 60 waypoints (0 to 59) available for programming. Waypoints may be entered and displayed to a resolution of 0.01 arc seconds. This

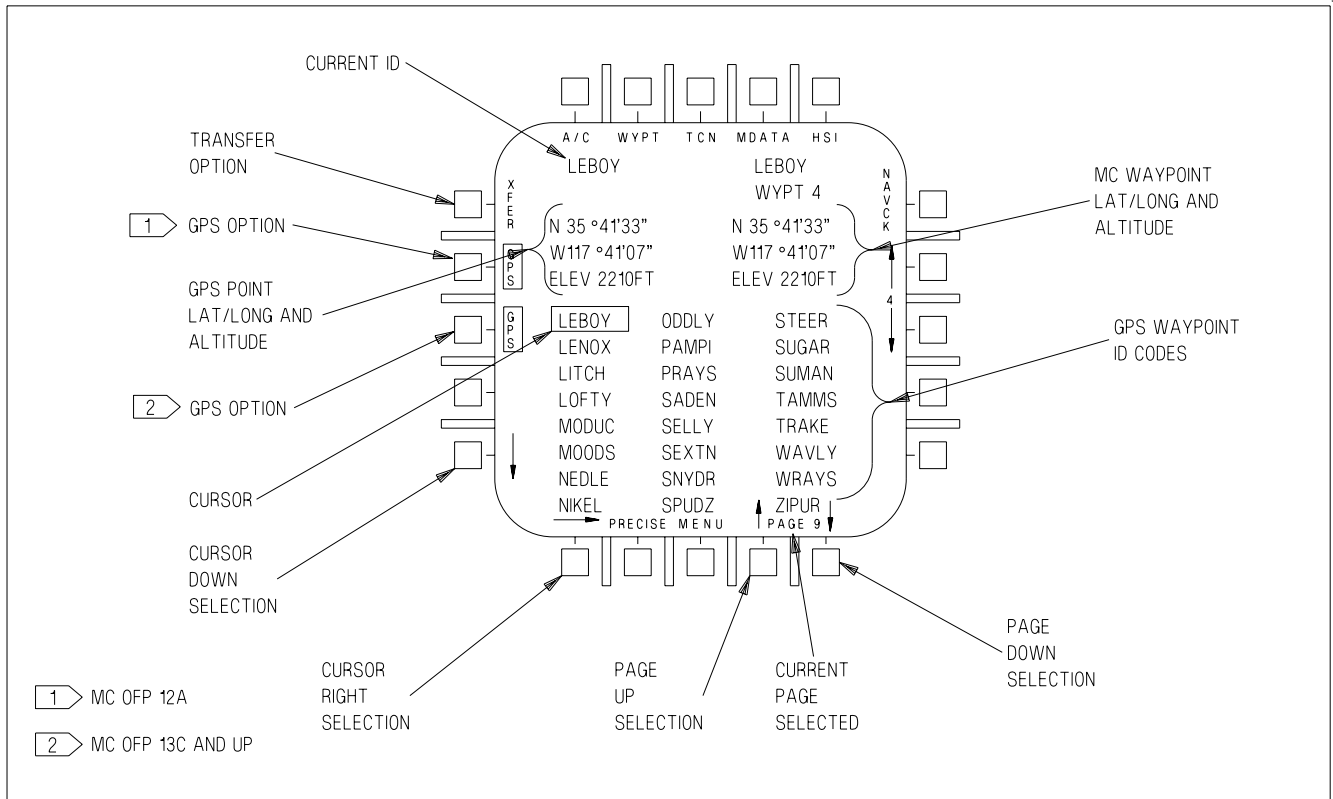

ADA520-330-1-047

Figure 24-8. GPS Point Data Display

corresponds to a resolution of less than one foot.

The PRECISE option on the HSI/DATA/WYPT sublevel enables precise lat-long data display and entry. Before MC OFP 20X with PRECISE unboxed, pressing LATLN DCML displays a precision of thousandths of a minute and pressing LATLN SEC (cold start default) displays a precision of seconds. With PRECISE boxed, lat-long precision is hundredths of a second in LATLN SEC and not available in LATLN DCML. After MC OFP 20X with PRECISE unboxed, lat-long precision is hundredths of a minute in LATLN DCML (cold start default) and seconds in LATLN SEC. With PRECISE boxed, lat-long precision is ten thousandths of a minute in LATLN DCML and hundredths of a second in LATLN SEC.

NOTE

For GND alignment, waypoint 0 should be within .01 NM (60 feet or .6 seconds) of the true position.

Waypoint position latitude is entered on the UFC in degrees, minutes, and seconds. If PRECISE option is boxed, select :HDTH on the UFC to enter hundredths of arc seconds or :TTHO to enter thousandths of a second. After latitude data is entered, the scratchpad initializes to the position (:POSN) format for longitude entry. See figure 24-9.

With MC OFP 13C AND UP, waypoint data can also be entered using the map slew method. To do this, select WYPT on the DATA option display, then actuate the SLEW button. Now press the TDC and slew the map to the desired lat/long position under the waypoint symbol.

NOTE

Lat/long and elevation data on the HI/MPCD reflect the current map position under the waypoint symbol as the map is being slewed.

Upon release of the TDC the current waypoint data is entered for the map position under the waypoint symbol. Select the next waypoint number as required (via the waypoint increment/decrement option buttons) for further waypoint data entry.

With MC OFP 13C AND UP, another map slew method may be used to enter waypoint data. To do this, select WYPT on the DATA option display, then actuate the SLEW button. Now press and hold the TDC to slew the map to the desired lat/long position under the waypoint symbol. This position is entered by selecting another waypoint (via the waypoint increment/decrement option buttons). Continue to hold the TDC, slew the map as required, and select the next waypoint for further waypoint data entry.

Offset aimpoints may also be entered using the map slew method, however, the associated offset must be entered through the UFC.

24.2.5.1.1 GPS Waypoint Programming. Aircraft with GPS can utilize the GPS to store up to 200 waypoints. GPS points are loaded into the GPS from the MU or MDL. GPS points can be displayed and/or transferred into the MC waypoint data base via the HSI/DATA/GPS display. With MC OFP 12A, the GPS LOAD option, available on the GPS display, commands the MC to load the GPS Almanac Data file, Point data, and Point ID files from the MDL.

A GPS point can be transferred into any MC waypoint by pressing the XFER option on the GPS point data display. When GPS option is selected the first 24 GPS points are displayed in alphanumeric order. Selection of points to load is accomplished via the right and down arrows and page selection arrows. Repeated selection of these arrows causes the cursor to wrap around. It may take as long as three seconds to retrieve selected position data and display it on the GPS point data display. See figure 24-8. To transfer GPS waypoints to the MC, select the desired waypoint number with the up/down arrows on the HSI/DATA/GPS sublevel, then move the cursor down/right and/or page up/down to the desired waypoint ID code, and press XFER. At this time the GPS LAT/LONG, GPS altitude, and current ID code displays are blanked and the XFER option is removed. The selected ID code is displayed in the "Current ID" position indicating that waypoint is requested. After approximately 3 seconds, the requested GPS LAT/LONG and GPS altitude is displayed and the XFER option is returned for transfer selection. If a GPS ID code is requested and is not available, the selected ID code is displayed with a line through it. Once a GPS waypoint has been transferred from the GPS to the MC it becomes an MC waypoint. The waypoint ID code is retained and is displayed on the top level HSI and HSI/DATA/WYPT formats when the waypoint is selected as the current waypoint.

24.2.5.1.2 UTM WYPT Data Entry. Data for all waypoints and OAPs may be entered as universal transverse mercator (UTM) coordinates. See figure 24-9, sheet 2. UTM Grid Coordinates are defined by a Spheroid or DATUM, Grid Zone Designation, Square Identification, and Easting/Northing. Grid zone designation divides the world area between N84° and S80° into 100 km squares. At power up with WOW the MC initializes waypoint elevation, O/S range and elevation, and TACAN elevation in FEET, and O/S bearing to TRUE. With MC OFP 12A, 13C AND UP, the PRECISE option on the DATA display allows the pilot to select either 100 meter or 1 meter accuracy. With PRECISE unboxed,

entering 3 easting and 3 northing digits provides accuracy up to 100 meters. With PRECISE boxed, entering 5 easting and 5 northing digits provides accuracy up to 1 meter. To enter UTM data for waypoints, perform the following:

1. Select DATA/WYPT on the HSI top level display.

If MC OFP 10A -

2. Select the desired spheroid by depressing the spheroid pushbutton.

If MC OFP 12A, 13C AND UP -

2. Select the desired DATUM by pressing the DATUM XX option pushbutton. Pressing the button momentarily increments the DATUM by one. Pressing and holding the DATUM button enables the UFC DATM format. The Datum number can be entered directly from 1 to 47. The MC selects the spheroid for the DATUM selected. The selected DATUM and corresponding spheroid are displayed above the button.
3. Select PRECISE option if 1 meter resolution is desired.

All aircraft -

4. Select UFC on the HSI. The first cockpit to select UFC has control of Grid data entry and has the GRID display on the RDDI.
5. Select GRID on the UFC. The MC determines the Grid Zone Designation and 100 km square ID of the reference position and construct a five by five Square Identification Grid (SIG) centered about the reference position and displayed on the RDDI. Reference position is either the A/C present position or the referenced waypoint position (REF WP Boxed).
6. Slew the acquisition cursor into the desired square, press and release the TDC.
7. On the UFC enter the six or ten digit Easting/Northing and press ENT. Leading zeros do not have to be input for Easting/Northing. The UTM coordinates are displayed on the HSI under the lat/long provided the latitude is within the N84° to S80° limits.

To enter UTM data for O/S, perform the following:

8. Select DATA/WYPT on the HSI top level display.
9. Select UFC on the HSI.
10. Select O/S on the UFC.
11. Select Grid on the UFC.
12. Slew the HOTAS cursor into the desired square, press and release the TDC.
13. Enter O/S Easting/Northing in the UFC.
The MC converts the UTM Grid coordinates to latitude/longitude and then to a range and bearing. O/S coordinates more than 400,000 feet from the OAP cause the UTM coordinates to flash in the O/S Grid field on the HSI. The UTM coordinate is displayed in the O/S field on the HSI.

SIG Square blanking must be checked any time the SIG is built. If the latitude is out of UTM range (above N84° or below S80°) the entire row is blanked. At certain latitudes, due to longitudinal line convergence, individual squares are blank.

Grid shift options are provided to view and select grid squares in the eight adjacent grid squares whenever the A/C or Waypoint symbol is in the center square of the SIG and the adjacent SIGs exist. See figure 24-9. N, S, E, W, SE, SW, NE, or NW can be selected by pressing the grid shift pushbuttons on the HSI, or by depressing and releasing the TDC when the HOTAS cursor is over a grid shift pushbutton legend. The MC determines a new center position about which to construct a new SIG. Selecting the A/C or waypoint symbol returns the SIG to the original position.

Units can be input as FEET or MTRS for elevation; FEET, MTRS, NM or YARD for range; and TRUE or MAG for heading. The MC tests that all bearing, range and elevation data input through the UFC are within their valid range.

Unit	Valid Range
Easting/ Northing	0 - 9999999999
Bearing	0 - 359° 59' 59"
Offset	0 - 400,000 FT
	0 - 122,000 MTRS
	0 - 66 NM
	0 - 133,000 YDS

When data is outside the valid range, the CSC causes the word ERROR to flash in the UFC scratchpad and requires the data be reinput.

24.2.5.2 TGT (Target) Programming. A target must be entered in a waypoint/OAP sequence so the MC can calculate the groundspeed required to arrive on target at the appropriate time. Only one waypoint/OAP can be designated as a target for all three sequences. With MC OFP 10A, a waypoint/OAP is identified as a target on the waypoint data sublevel display by an inverted triangle above the waypoint/OAP number (in the waypoint/OAP sequence). With MC OFP 13C AND UP, a target is identified by a box around the waypoint/OAP number. At power up with WOW the previous target waypoint/OAP is cleared.

To designate a waypoint/OAP as a target in a waypoint/OAP sequence, first select the DATA option on the HSI top level display. Then select the SEQUFC option on the waypoint data sublevel display to initialize the UFC. Now select the TGT option on the UFC, enter the waypoint/OAP number via the UFC keypad and select the ENT pushbutton. To undesignate the current target waypoint/OAP either enter the current target waypoint/OAP a second time or enter an invalid waypoint/OAP. See figure 24-9, sheets 1, 2, and 3.

24.2.5.3 TOT (Time On Target) Programming. TOT pertains to the programmed target waypoint/OAP, and is relative to the programmed ZTOD (zulu time of day). ZTOD must be programmed before TOT can be entered. TOT is programmed from 00:00:00 to 23:59:59 and is displayed on the waypoint data sublevel display.

To enter TOT select the DATA option on the HSI top level display. Then select the SEQUFC option on the waypoint data sublevel display to initialize the UFC. Now select the TOT option on the UFC, enter the desired TOT value via the UFC keypad and select the ENT pushbutton. See figure 24-9, sheets 1, 2 and 3.

24.2.5.4 Groundspeed Programming. Groundspeed pertains to the desired groundspeed for the final leg to the target waypoint in the sequence. Groundspeed values up to 999 knots may be entered. However, if groundspeed values exceed 999 knots, 999 knots is entered as the groundspeed.

To enter groundspeed, select the DATA option on the HSI top level display. Then select the SEQUFC option on the waypoint data sublevel display to initialize the UFC. Now select the GSPD option on the UFC; enter the desired GSPD value via the UFC keypad and select the ENT pushbutton. See figure 24-9, sheets 1, 2, and 3.

24.2.5.5 Waypoint/OAP Sequence Programming. A total of three waypoint/OAP sequences are available for waypoint/OAP sequence programming and a maximum of fifteen waypoint/OAPs may be programmed in each sequence. These sequences are used for AUTO sequential steering and time on target groundspeed cuing.

The waypoint data sublevel display on the HSI display must be used along with the UFC to allow the pilot to program a waypoint/OAP sequence. The SEQ # option on the lower right corner of the display indicates the waypoint/OAP sequence currently in use and initializes to the sequence selected on the HSI top level display. This option selects the sequence to be programmed (SEQ1, SEQ2 or SEQ3). Selecting the SEQUFC option on the lower left corner of the display, initializes the UFC for waypoint sequence programming. A waypoint/OAP cannot appear more than once in sequence, however, a waypoint/OAP may be entered in more than one sequence. Mark points cannot be programmed in a sequence. Each waypoint/OAP entered is placed to the right of the last waypoint/OAP in the sequence. If nine waypoints/OAPs are programmed, the first waypoint in that sequence is deleted and the remaining waypoints/OAPs move to the left one space. Data for the current waypoint/OAP inserted/deleted in the sequence is provided on the waypoint data level display.

To program a new waypoint/OAP sequence select: 1) the waypoint data sublevel display using the DATA option, 2) the desired sequence route number using the SEQ # option, 3) the SEQUFC option to initialize the UFC for sequence programming, 4) the INS option on the UFC, 5) the desired waypoint/OAP number via the UFC keypad, 6) the ENT pushbutton on the UFC keypad. Repeat steps 4 thru 6 for each waypoint/OAP in the sequence. See figure 24-9, sheets 1, 2, and 3.

To insert waypoints/OAP into an existing sequence select: 1) the waypoint data sublevel display using the DATA option, 2) the desired sequence route number using the SEQ # option, 3) the SEQUFC option to initialize the UFC for programming, 4) the INS option on the UFC, 5) the number of the waypoint/OAP to the left of the desired insertion point via UFC keypad, 6) the ENT pushbutton on the UFC keypad, 7) number of the waypoint/OAP to be inserted via the UFC keypad, 8) the ENT pushbutton via the UFC keypad.

To delete waypoints from a sequence select: 1) the waypoint data sublevel display using the DATA option, 2) the desired sequence route number using the SEQ # option, 3) the SEQUFC option to initialize the UFC for programming, 4) the DEL option on the UFC, 5) the number of the waypoint/OAP to be deleted via the UFC keypad, 6) the ENT pushbutton via the UFC keypad. When a waypoint/OAP is deleted from a sequence all waypoints/OAPs to the right of the deleted waypoint/OAP shift left one space.

24.2.5.6 Aircraft (A/C) Data Programming. To enter aircraft data, select the DATA option on the HSI display. WYPT is automatically the selected option when DATA is pressed. Then, select the A/C option to bring up the A/C data sublevel display. This display shows the current position keeping source, present position (lat-long) of the aircraft, current windspeed and direction, magnetic variation, and magnetic/true heading selection. Aircraft data is entered through the UFC keypad. See figure 24-9. BEFORE MC OFP 20X, lat/long is entered as Degrees/Minutes/Thousandths of minutes (LATLN DCML), or Degrees/Minutes/Seconds (LATLN SEC). With MC OFP 20X AND UP and PRECISE unboxed, lat-long is entered either as Degrees/Minutes/ Hundredths of minutes (LATLN DCML) or Degrees/Minutes/Seconds (LATLN SEC). With MC OFP 20X AND UP and PRECISE boxed, lat-long is entered either as Degrees/Minutes/Ten Thousandths of minutes (LATLN DCML) or Degrees/Minutes/Seconds/Hundredths of seconds (LATLN SEC). Actuating the LATLN XXXX option toggles between the selection of LATLN DCML and LATLN SEC. The selected LATLN format is reflected on all displays and UFC formats throughout the cockpit. After MC OFP 20X non-PRECISE DCML is the cold start default. If EGI or GPS is installed and the aircraft is tracking satellites the GPS estimated vertical error (GPS VERR), estimated horizontal error (GPS HERR) and time (GPS TIME) are displayed. To enter wind speed, wind direction or magnetic variation data, select the UFC option to initialize the UFC for aircraft data entry. On the UFC select: the WSPD pushbutton to enter wind speed data, the WDIR pushbutton to enter wind direction, and MVAR to enter magnetic variation.

24.2.5.7 True/Magnetic Heading Selection. Heading indications that appear in the HUD and HSI display can be referenced to either true north or magnetic north. The capability to select a true north heading is useful in extreme northern operations. With true north heading selected, the HSI display, A/A and A/G radar displays, Link 4 display, and the HUD are all referenced to true north. The true north indication on the HUD is a T displayed below the current heading. True north indications on the HSI display consist of TRUE being displayed below the current heading readout and a T being displayed below the lubber line. The true heading indications on the HSI display also appear on the Link 4 display. No indications of true north selection appear on the A/A or A/G radar display. Since aircraft magnetic variation is used as the best available magnetic variation source, the heading reference should not be changed when navigating a selected course. With true heading selected, TACAN symbology is also referenced to true north if the TACAN station is in the TACAN data table. If the TACAN station is not in the TACAN data table, magnetic is used. There is no indication when magnetic heading is selected. When INS true heading becomes invalid, magnetic heading is used. If MC1 fails, heading selection is not available. At power up with WOW the system initializes with magnetic heading selected. To select the desired reference heading, first select DATA in the HSI display. Then select the A/C option to access the A/C data sublevel display. Actuating the HDG XXX option toggles between the selection of HDG TRUE and HDG MAG.

24.2.5.7.1 Barometric (BARO)/Radar Low Altitude Warning Programming. The BARO/RADAR altitude warning can be set up to a maximum of 25,000 feet for BARO and 5,000 feet for RADAR. Setting the RADAR at a value greater than 5,000 feet results in 5,000 feet being used. Passing through the BARO/RADAR programmed altitude from above results in the ALTITUDE voice alert. Setting the BARO/RADAR altitude warning to 0 feet disables this function. At power up with WOW, RADAR altitude warning initializes to 0 feet and BARO altitude warning initializes to 5,000 feet.

To set the BARO/RADAR low altitude warning function, first select the DATA option on the top level HSI display. Then select the A/C option to bring up the A/C data sublevel display. The BARO/RADAR altitude functions are located on the lower left corner of the display. Select BARO or RADAR to initialize the UFC for altitude entry. Then select the ALT option on the UFC and enter the desired altitude through the UFC keypad. The entered altitude appears on the A/C data sublevel display below BARO/RADAR as appropriate. See figure 24-9, sheet 5.

24.2.5.7.2 NOSEC GPS Option. The mixed mode satellite function has two modes of operation. The two selectable modes are secure (encrypted code only) and non secure (encrypted and/or non-encrypted) operation. The NO SEC GPS legend is available as long as there is communication between the GPS receiver and the satellites. If communication is lost, the NOSEC legend is removed. The secure mode of operation is the default mode upon power up. The secure mode of operation is indicated by an unboxed NOSEC GPS legend, on the A/C DATA sublevel. In this mode, the MAGR/EGI tracks the encrypted GPS code only and is not susceptible to spoofing. Remaining in secure operation with a YCODE advisory can cause the aircraft to lose the ability to use GPS data.

The non secure mode of operation is selectable by boxing the NOSEC GPS legend. In this mode, the MAGR/EGI tracks either encrypted or non-encrypted GPS code and is susceptible to spoofing, and the NO SEC advisory is displayed. Typically, non secure operation should only be selected when the YCODE advisory is displayed in the secure mode and the pilot believes there is no danger of spoofing. Selecting NOSEC GPS in a spoofing environment makes the aircraft susceptible to erroneous GPS signals.

MC OFP 10A

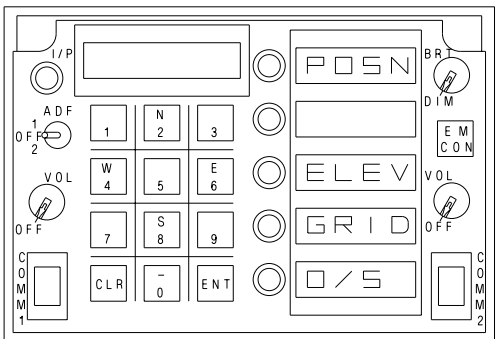
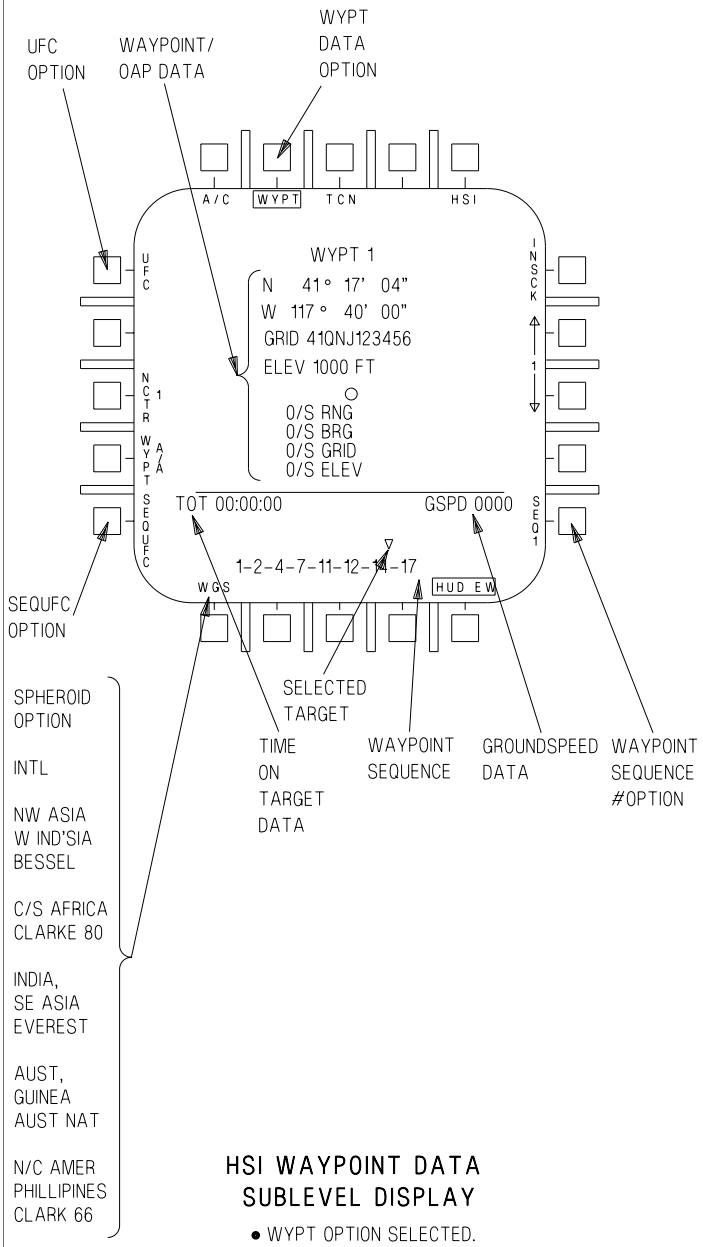

WYPT PROGRAMMING OPTIONS

- UFC OPTION ON HSI WAYPOINT DATA SUBLEVEL DISPLAY SELECTED

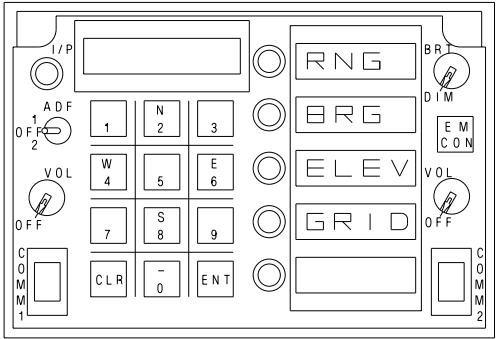

O/S PROGRAMMING OPTIONS

- O/S SELECTED ON UFC

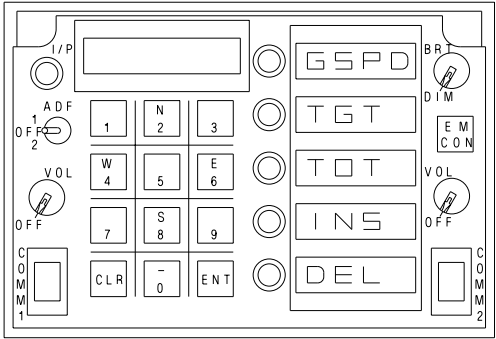

TARGET, TIME ON TARGET, GROUND SPEED AND WAYPOINT SEQUENCE PROGRAMMING OPTIONS

- SEQUFC OPTION ON HSI WAYPOINT DATA SUBLEVEL DISPLAY SELECTED

Figure 24-9. INS Programming (Sheet 1 of 7)

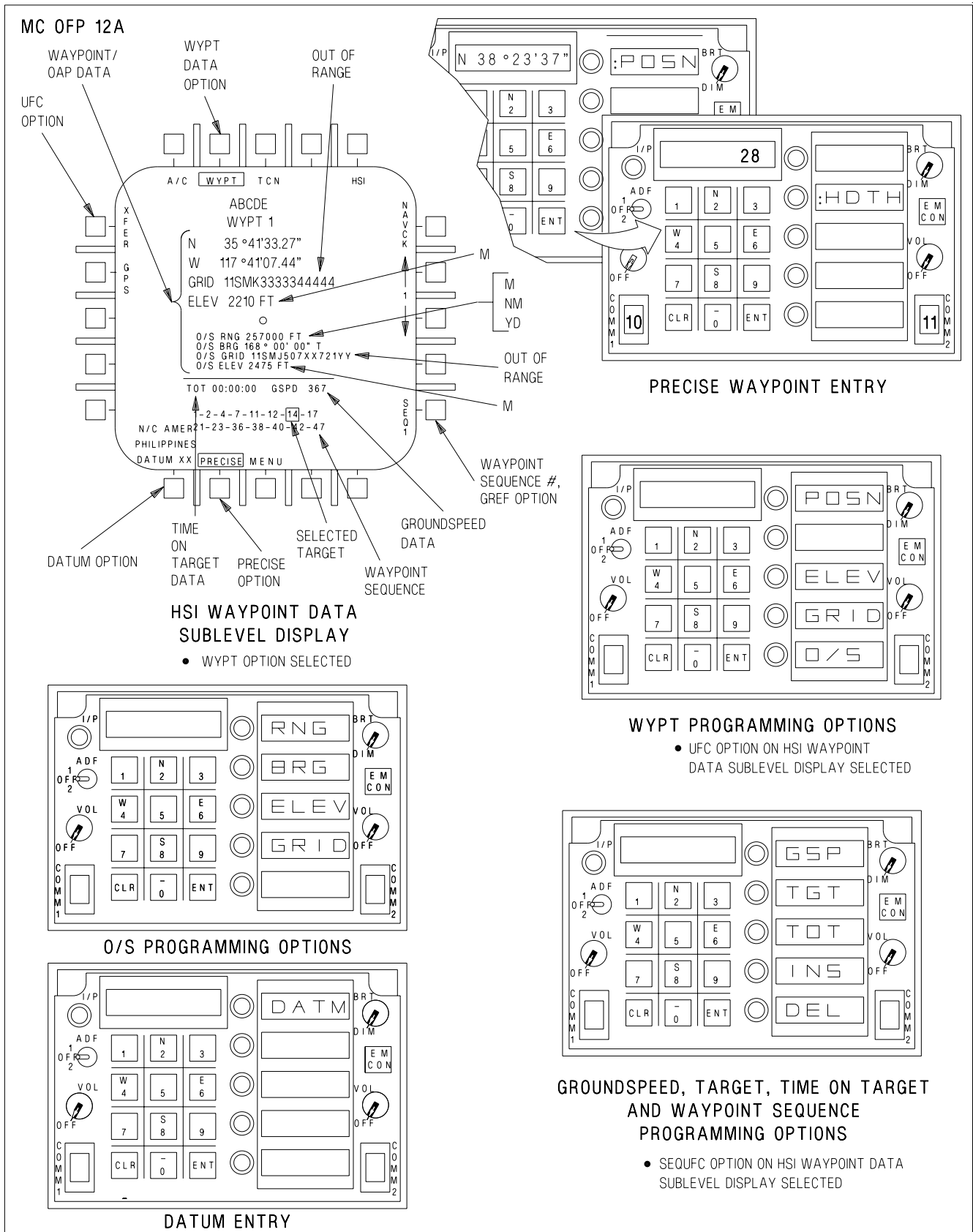

ADA520-115-7-047

Figure 24-9. INS Programming (Sheet 2 of 7)

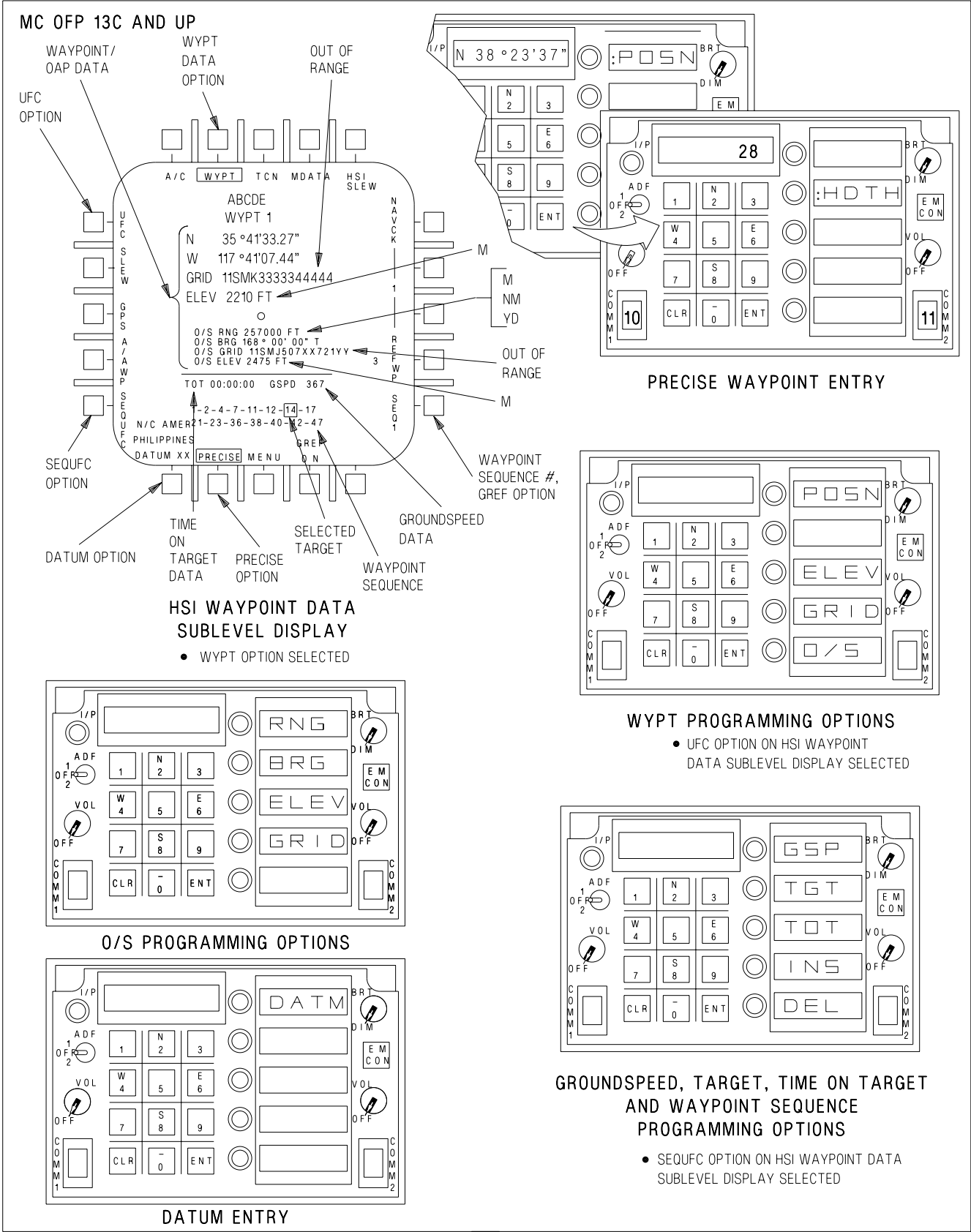

ADA520-347-1-049

Figure 24-9. INS Programming (Sheet 3 of 7)

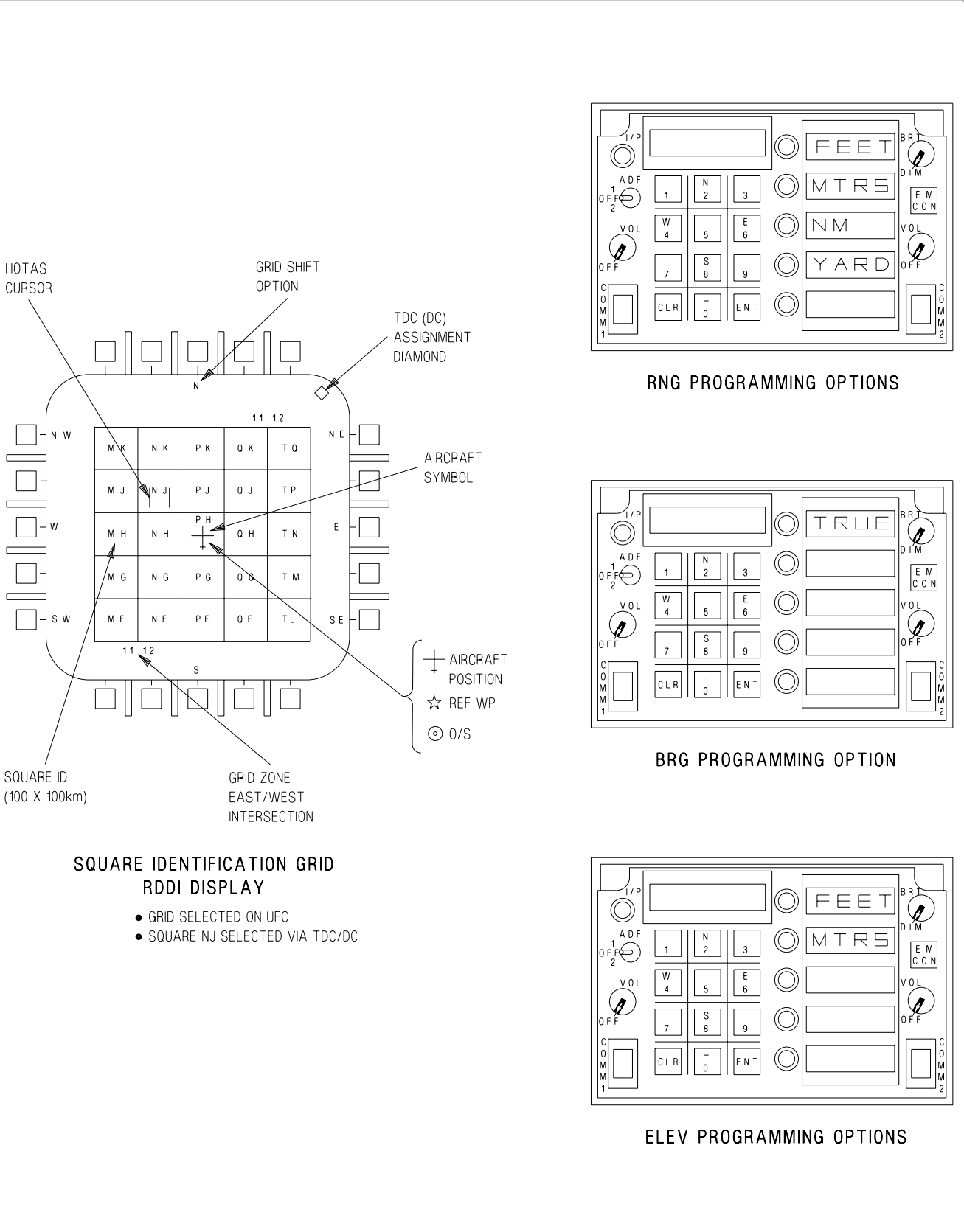
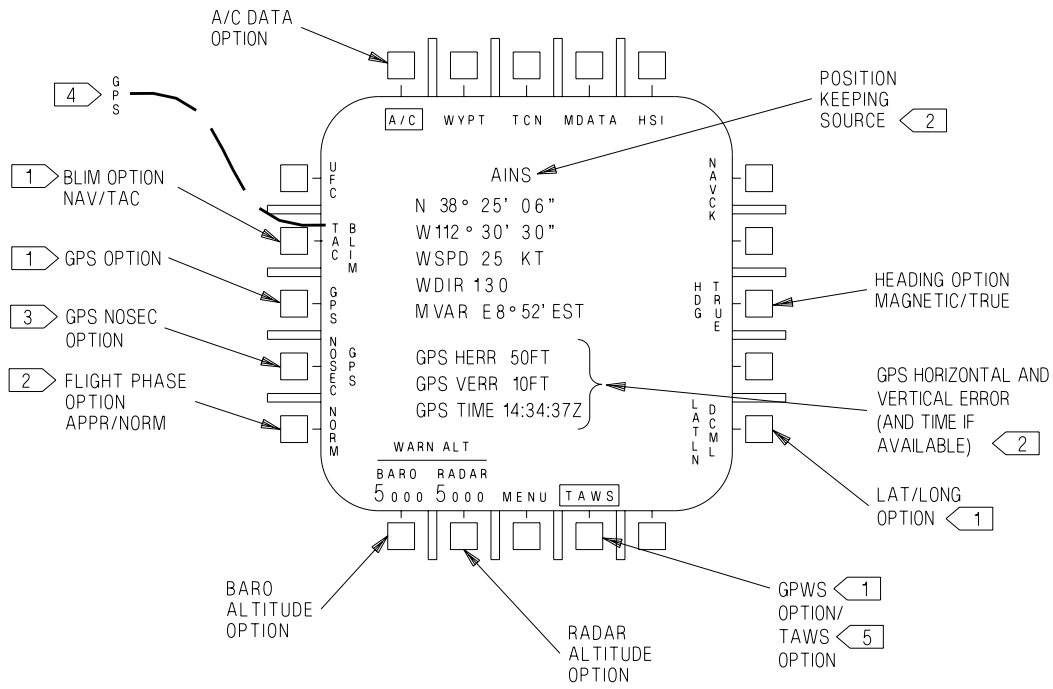

Figure 24-9. INS Programming (Sheet 4 of 7)

ADA520-115-4-038



HSI A/C DATA SUBLEVEL DISPLAY

A/C OPTION ON WYPT DATA
 • SUBLEVEL DISPLAY SELECTED

- 1) MC OFF 13C AND UP
- 2) AIRCRAFT WITH GPS
- 3) MC OFF 15C AND UP
- 4) MC OFF 12A
- 5) MC SCS 17C AND UP

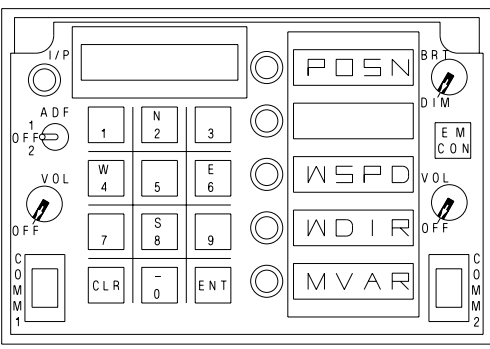

A/C PROGRAMMING OPTIONS

• UFC OPTION ON HSI A/C DATA SUBLEVEL DISPLAY SELECTED

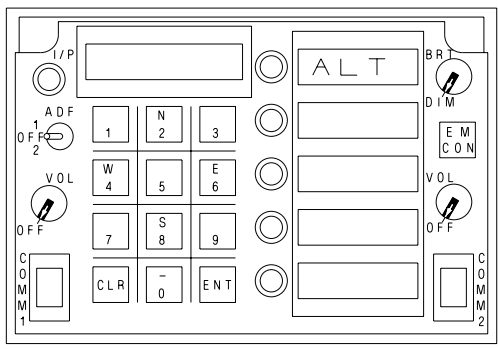

BARO/RADAR LOW ALTITUDE PROGRAMMING OPTIONS

• BARO OR RADAR OPTION ON HSI A/C DATA SUBLEVEL DISPLAY SELECTED

Figure 24-9. INS Programming (Sheet 5 of 7)

MC OFF 20X AND UP

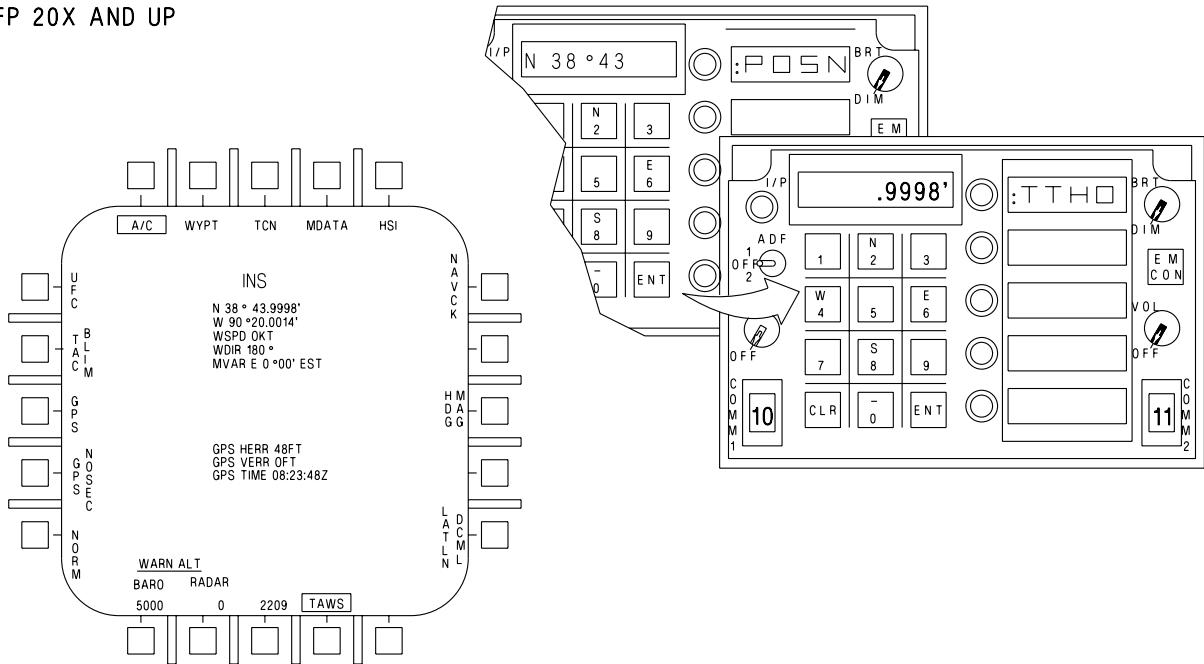

LATLN DCML

HSI A/C DATA SUBLEVEL DISPLAY - LATLN DCML (PRECISE)

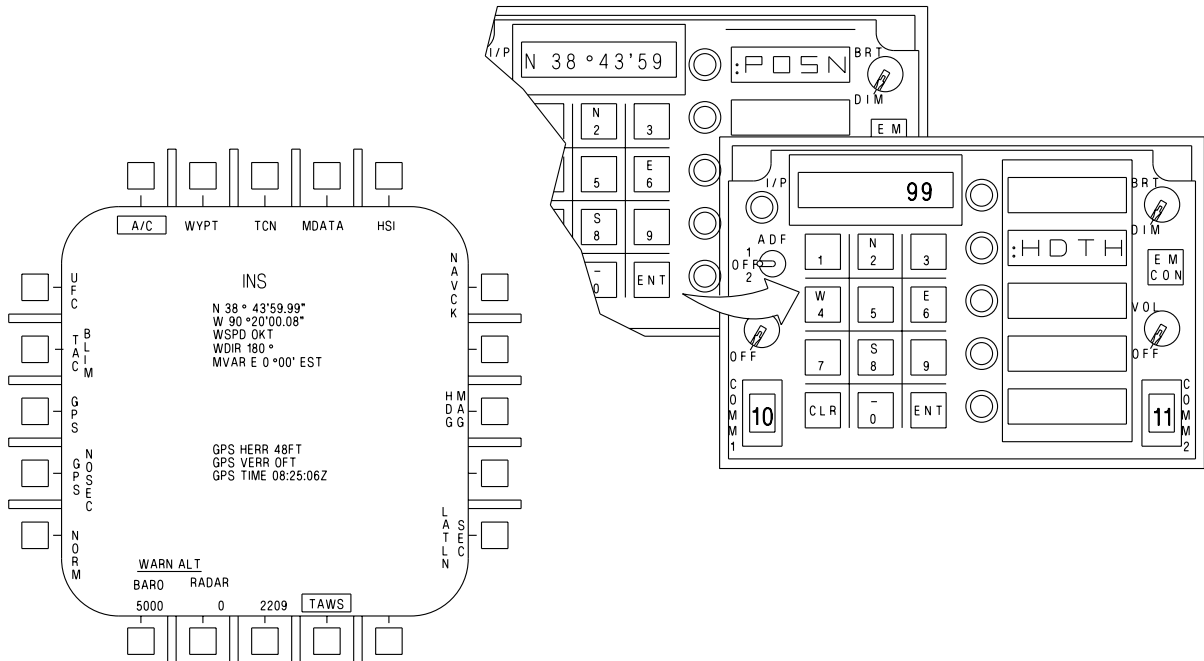

LATLN SEC

HSI A/C DATA SUBLEVEL DISPLAY - LATLN SEC (PRECISE)

Figure 24-9. INS Programming (Sheet 6 of 7)

ADA520-374-1-057

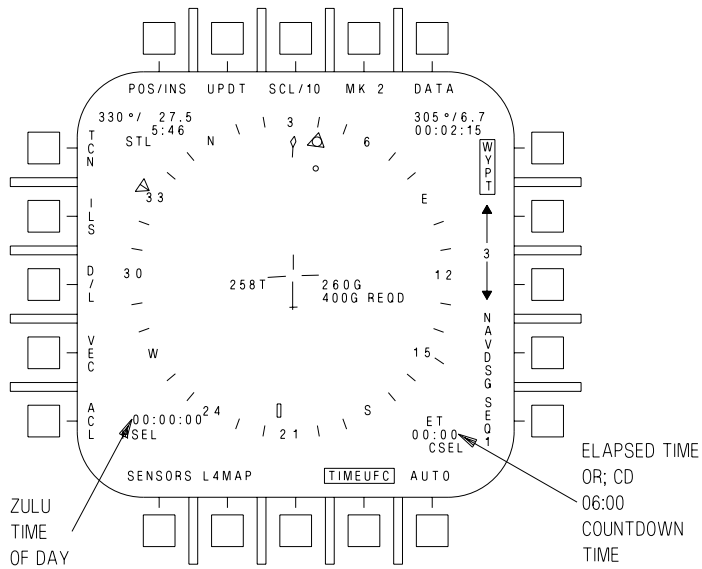

HSI TOP LEVEL DISPLAY

- TIMEUFC OPTION SELECTED

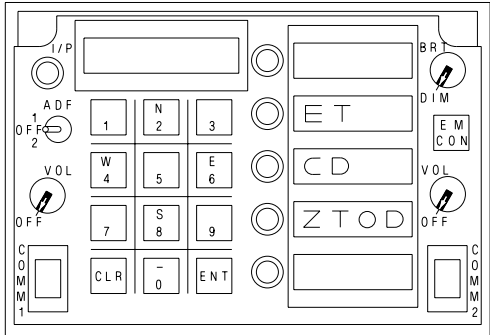

- TIMEUFC OPTION ON HSI TOP LEVEL DISPLAY SELECTED
MC OFP 10A

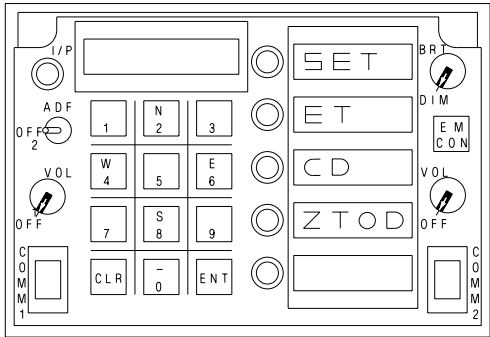

- TIMEUFC OPTION ON HSI TOP LEVEL DISPLAY SELECTED
MC OFP 12A

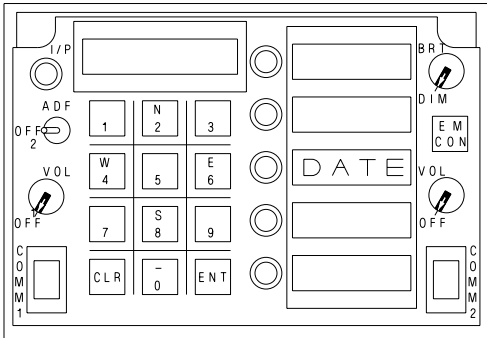

DATE PROGRAMMING

- SET OPTION ON UFC SELECTED
MC OFP 12A, 13C AND UP

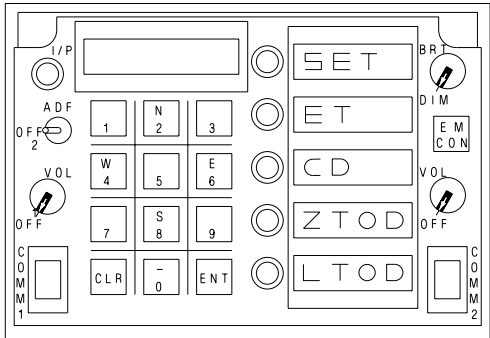

COUNTDOWN TIME AND ELAPSED TIME INITIALIZATION/ZULU TIME, LOCAL TIME AND DATE PROGRAMMING OPTIONS

- TIMEUFC OPTION ON HSI TOP LEVEL DISPLAY SELECTED
MC OFP 13C AND UP

Figure 24-9. INS Programming (Sheet 7 of 7)

ADA520-346-1-047

24.2.5.7.3 Flight Phase. If GPS is installed a flight phase option is available on the A/C display. The flight phase alternates between normal (NORM) flight and approach (APPR). When NORM is selected and the position keeping mode is POS/GPS a GPS advisory is displayed when the GPS estimated horizontal position error (EHPE) exceeds 333 meters. When APPR is selected and the position keeping mode is POS/GPS a GPS DEGD caution is displayed when the GPS estimated horizontal position error (EHPE) exceeds 33 meters for 10 seconds or more.

24.2.5.7.4 Zulu Time Of Day (ZTOD). For F/A-18A/B aircraft an MC internal counter is used to keep Zulu time. Therefore, ZTOD must be set to initialize the MC internal counter. Also, ZTOD must be set in order for ZTOD to be displayed on the HUD and HI/MPCD, and before the MC is able to calculate MC required groundspeed and TOT. In other words ZTOD must be set every time following aircraft power up.

For F/A-18C/D aircraft the FIRAMS Real Time Clock (RTC) is used to keep ZTOD. Therefore, the only time ZTOD would need to be set is if the FIRAMS RTC failed power up BIT. In this case the MC internal counter would be used which requires the MC internal clock to be set, exactly like F/A-18A/B aircraft. ZTOD is displayed on the HUD and HSI display and is needed to calculate MC required groundspeed and TOT. ZTOD may also be set using the IFEI, refer to Chapter 2.

To enter ZTOD, select the TIMEUFC option on the HSI top level display to initialize the UFC for ZTOD programming. Now select the ZTOD option on the UFC, enter ZTOD via the UFC keypad and select the ENT pushbutton. After entering ZTOD, it is displayed on the HUD and HSI display. Successive depressions of the ZTOD option displays/blanks ZTOD from the HUD. ZTOD is displayed on the lower left corner of the HUD and HSI display. ZTOD is not displayed on the HUD when either the ET or CD is selected for display. See figure 24-9, sheet 6.

24.2.5.7.5 Elapsed Time (ET). ET starts incrementing in minutes and seconds from 00:00 to 59:59. When 59:59 is reached ET resets and begins incrementing again from 00:00. ET is displayed on the lower left corner of the HUD and on the lower right corner of the HSI display. ET is not displayed on the HUD or HSI display when either ZTOD or CD is selected.

To activate ET, select the TIMEUFC option on the HSI top level display to initialize the UFC for ET selection. Now select the ET option on the UFC to display ET 00:00 on the HUD and HSI display. Successive depressions of the ET option displays/blanks ET from the HUD and HSI display. Then select the ENT pushbutton to start ET. Successive depressions of the ENT pushbutton start/stop the timer. See figure 24-9, sheet 6.

24.2.5.7.6 Countdown Time (CD). CD starts decrementing in minutes and seconds from its default value of 06:00. When 00:00 is reached, the CD timer is removed from the HUD and HI/MPCD displays. CD is displayed on the lower left corner of the HUD and on the lower right corner of the HI/MPCD. CD is not displayed on the HUD or HI/MPCD when either ZTOD or CD selected. The CD timer initializes to the default value at power up with WOW.

To activate CD, select the TIMEUFC option on the HI/MPCD top level display to initialize the UFC for CD selection. Now select the CD option on the UFC to display CD 06:00 on the HUD and HSI display. Successive depressions of the CD option displays/blanks CD from the HUD and HSI display. Press the ENT pushbutton to start CD. Successive depressions of the ENT pushbutton start/stop the timer. See figure 24-9, sheet 6.

The CD default value can also be reset by entering in a value between 00:00 and 59:59. To do this, select the TIMEUFC option on the HSI top level display to initialize the UFC for CD programming. Now enter in the reset value through the UFC keypad and press the ENT pushbutton. The reset value

must be less than or equal to 59:59 so that when the ENT pushbutton is pressed the CD timer begins to decrement. If the reset value is greater than 59:59, depression of the ENT pushbutton sets the reset value to 59:59 and freezes the CD timer.

24.2.5.8 Local Time Of Day Programming (LTOD). For F/A-18C/D aircraft, to set LTOD, select the TIMEUFC option on the HSI display to initialize the UFC for LTOD programming. Now select the LTOD option on the UFC, enter LTOD via the UFC keypad, then select the ENT pushbutton. LTOD may also be entered using the IFEI, see Chapter 2. The LTOD option is displayed only if the FIRAMS passes power up BIT. See figure 24-9, sheet 6.

24.2.5.9 Date Programming (SET). For F/A-18A/B aircraft with MC OFP 12A and F/A-18C/D aircraft, to set the date, select the TIMEUFC option on the HSI display to initialize the UFC for date programming. Select the SET option on the UFC to allow the DATE option to appear on the UFC. Enter the date via the UFC keypad, and select the ENT pushbutton. The date must be entered as two digit values in the following order: month, day and year. See figure 24-9, sheet 6.

24.2.6 Position Keeping. Selection of the POS/XXX option on the HSI display provides the position keeping option display, see figure 24-10. This display allows inflight selection of POS/INS, POS/MIDS (if installed), POS/ADC or POS/TCN as the position keeping source. In aircraft with EGI or GPS two additional sources, POS/AINS and POS/GPS can be selected as the position keeping source. Selecting one of these options returns the HSI display with the appropriate position keeping source selected. In aircraft without GPS, INS position keeping is automatically selected during ground operations when INS data is valid. Should the INS fail, the mission computer automatically begins ADC position keeping from the last valid INS position, however it is unreliable.

AINS and GPS position keeping is not available unless good GPS data is available. GPS data is good when the GPS vertical error (GPS VERR) and GPS estimated horizontal error (GPS HERR), as shown on the HSI A/C Data display, are each less than 100 feet.

WARNING

MIDS precise participant location and identification (PPLI) altitude shall not be used as an altitude reference for determining safe separation of aircraft or terrain avoidance.

NOTE

It may take up to 12 minutes for satellite acquisition and valid GPS position data.

In aircraft with GPS, AINS position keeping is selected by placing the INS mode switch to the IFA position. Automatic position keeping reversion with a hierarchy of AINS, INS, GPS, MIDS (if installed) and ADC is provided in case of an INS and/or GPS failure. TACAN position keeping

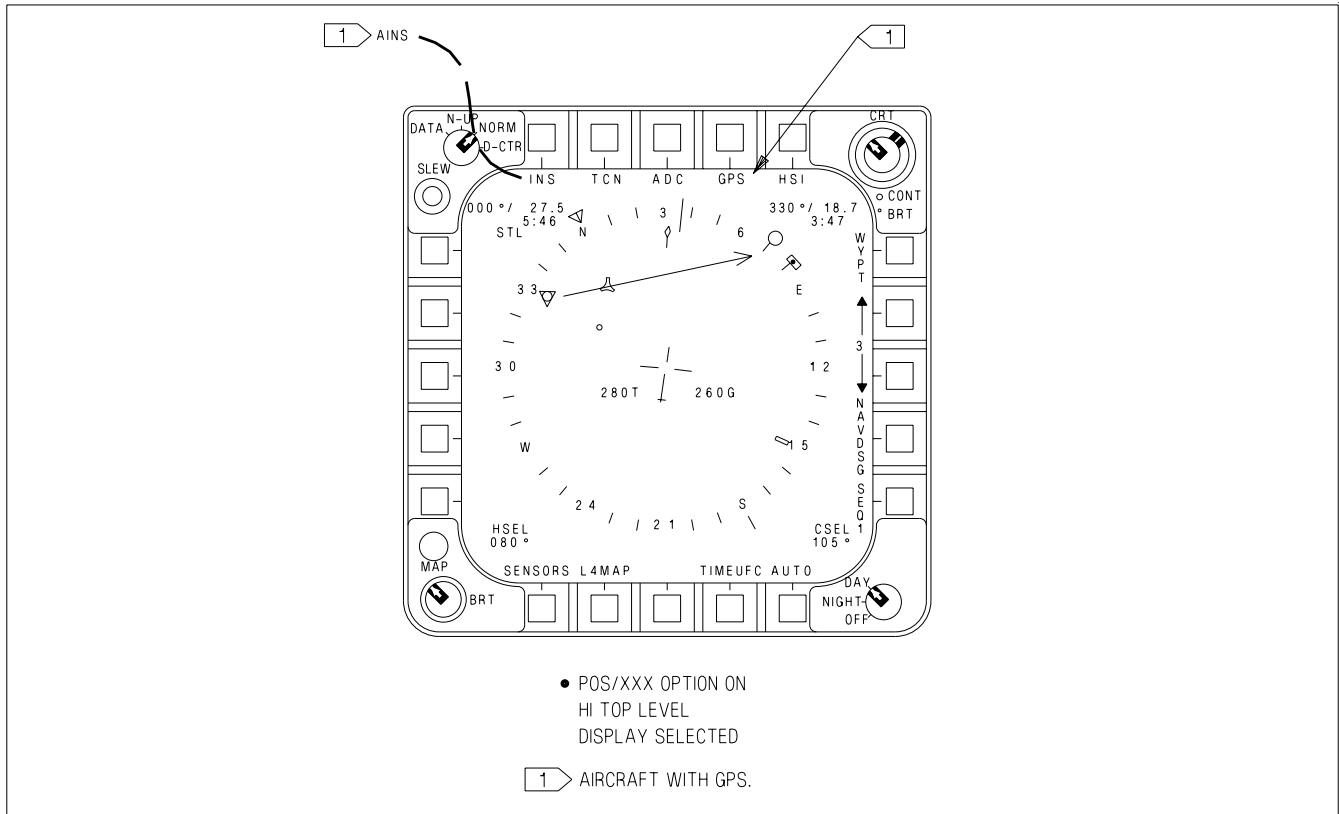

ADA520-116-1-045

Figure 24-10. Position Keeping

provides distance data from one of the previously stored TACAN stations. The desired TACAN station is selected via the UFC. See TACAN position keeping this section.

NOTE

MIDS position keeping is the default position keeping mode if GPS and INS are not available. Because MIDS alone is unreliable as a position keeping source, POS/ADC should be selected if INS and GPS fail or become unreliable as position keeping sources. Flight crews will be unable to enter data parameters required for an INS or radar inflight alignment (IFA) if POS/MIDS is the position keeping source.

24.2.7 Position Updating. Selecting the UPDT (update) option on the HSI display provides the update sublevel display, see figure 24-11. This display allows inflight selection of: VEL (velocity), TCN (TACAN), GPS, DSG (designate), AUTO (automatic), and MAP as the update options. These options provide position/velocity updating to the INS/ADC during NAV or IFA modes. All updates must be performed while in the NAV or A/G master modes, unless noted otherwise. TCN position updating is described in the TACAN section, and VEL updating is described in the NTRP 3-22.2-FA18A-D NATIP.

NOTE

Normally, position updates are not required. Erroneous updates will degrade an otherwise good INS even if corrected back to a known correct position. The update option is not available in AINS position keeping.

On F/A-18A after AFC 253 or 292 and F/A-18 C/D aircraft, after an update is performed, the CANCEL option is displayed on the HSI UPDATE option display. Pressing the CANCEL option cancels the previous update and removes the CANCEL option. The INS then updates the aircraft position using the last accepted position update. The CANCEL option is also removed upon touchdown or when present position is changed using the UFC.

24.2.7.1 Designation (DSG) Update. To perform a designation update press the UPDT option on the HSI display. Select the DSG option on the UPDT sublevel display. Designate a waypoint/OAP with a sensor (radar, FLIR, NFLR or LDT), a HUD designation, or an overfly designation. The DSG option may be selected before or after waypoint designation. When the designation has been performed and DSG option selected, sensor ranging components to the target are added to the previously entered waypoint position to give an aircraft computed position. The difference between the computed aircraft position and the onboard aircraft position produces the position error readout in bearing and range on the ACPT/REJ display. Selecting the ACPT option accepts the position update and returns the HSI display. Selecting the REJ option rejects the update and returns the HSI display. A DSG update may be performed in the A/A master mode if the designation was performed in A/G prior to entering A/A. With MC OFP 13C AND UP, the selection of UPDT/DSG suspends auto sequential steering and disengages coupled steering.

24.2.7.2 Post Flight Update. The INS post flight update collects terminal INS maintenance data. The post flight update is performed using the overfly designation update method. The INS determines the overfly designation update is a post flight update using the WOW transition. The aircraft must be completely stopped (parking brake engaged) to prevent erroneous terminal velocity data. The post flight update is not performed onboard ship.

The INS post flight update may be performed when: the parking brake is set, and the aircraft is within .01 NM (60 feet or .6 seconds) of the appropriate waypoint entered in the system (the update waypoint need not be waypoint 0). If the waypoint position is known but not programmed in the system, the position may be entered and used for the update. If no waypoints are available, no update should be attempted.

24.2.7.3 MAP Update. To perform a MAP update select the UPDT option on the HSI display. Now designate a waypoint/OAP with a sensor (radar, FLIR or LDT), a HUD designation or an overfly designation. Next select the MAP option on the update sublevel display. When this is done the word SLEW appears in the upper right corner of the HSI and the TDC is automatically assigned to the HSI (for map slewing). The map can now be slewed so the target on the map is under the designation symbol (diamond). The difference between the target position and the designated position produces the position error readout in bearing and range on the ACPT/REJ display. Selecting the ACPT option accepts the position update and returns the HSI display. Selecting the REJ option rejects the position update and returns the HSI display. The MAP option is not available if a map is not installed.

24.2.7.4 AUTO Update. To perform an AUTO update select the UPDT option on the HSI display. Now select the AUTO option on the UPDT sublevel display. When this is done the AUTO option is boxed and the VEL, TCN, DSG and MAP options are removed. The pilot must then assign the TDC

to the HI/MPCD, overfly the waypoint/OAP then press the TDC while over the waypoint/OAP. When this is done the MC enters the waypoint/OAP as the aircraft present position, and the HSI display is returned. Also, the next waypoint in succession becomes designated or, in the case of an OAP, the offset becomes designated. There is no ACPT/REJ display in the AUTO update mode.

24.2.8 NAV/TAC Bank Limit Options (MC OFF 13C AND UP). Bank angle control 1 (BAC1) is engaged when any coupled steering mode is engaged. BAC1 provides aircraft steering commands and limits and maintains the aircraft on course to the selected waypoint(s), offset aim point(s), or TACAN station. BAC1 also provides steering to capture and hold a course line through the current WYPT, OAP, or TACAN station. The maximum bank limit (BLIM) is selectable on the A/C data display. TAC BLIM is used for tactical missions and limits the bank angle between $\pm 30^\circ$ and $\pm 60^\circ$ with a bank rate between 10° and 30° per second based on airspeed. NAV BLIM is used for general navigation and sets bank angle to a fixed $\pm 30^\circ$ limit with a maximum bank angle rate of 10° per second.

24.2.9 Steering. There are several types of waypoint/OAP steering described here: direct great circle, course line, auto sequential and target.

24.2.9.1 Waypoint/OAP Direct Great Circle Steering. Direct great circle steering is available in all master modes and is selected/deselected by actuating the WYPT/OAP option on the HI/MPCD. Selecting waypoint/OAP steering deselects ILS, D/L and TACAN steering. When steering is selected, the option is boxed and direct great circle steering is provided on the HUD as shown in figure 24-12. To follow a direct great circle path to the waypoint/OAP, the aircraft is turned so that the command heading steering pointer under the heading scale is centered in the heading caret. The steering provided by the steering pointer is corrected for wind drift. When the steering pointer is within $\pm 5^\circ$ of the caret as measured on the heading scale, it provides a direct indication of steering error. Between $\pm 5^\circ$ and the ends of the heading scale ($\pm 15^\circ$), the steering pointer moves non-linearly so that it is at the end of the heading scale when the steering error is 30° . The steering pointer is displayed at the end of the heading scale when the steering error is greater than 30° during a turn, the steering pointer begins to move to provide anticipation for rolling out of the turn, and then the actual steering error is indicated when within 5° . Waypoint/OAP range, identification and number is displayed on the lower right side of the HUD.

On the HI/MPCD, the position of the waypoint/OAP is indicated by the waypoint/OAP symbol as shown on figure 24-12. If the selected steer to point is an OAP, the position of the offset is indicated by the offset symbol. Bearing to the waypoint/OAP is indicated by the pointer inside the compass rose. The waypoint/OAP symbol and pointer are displayed whether or not direct great circle steering is selected. They provide a navigation situation display only. Steering (corrected for drift) is provided only on the HUD. A digital readout of bearing and range to the waypoint/OAP is provided on the upper right corner of the HI/MPCD. Time to go to the waypoint/OAP in minutes and seconds, based upon range and present groundspeed, is provided under the bearing and range readout.

24.2.9.2 Waypoint/OAP Course Line Steering. Course line steering is used when it is desired to fly a selected course to the waypoint/OAP. To select course line steering first select direct great circle steering, then actuate the course select switch. When the course select switch is actuated, the course line appears through the waypoint/OAP symbol as shown in figure 24-13, sheet 1. The course line rotates clockwise while the course select switch is held to the right and counterclockwise while it is held to the left. A digital readout of the selected course is provided in the lower right corner of the HI/MPCD. When the waypoint/OAP symbol is beyond the range of the selected HI/MPCD scale, the waypoint/OAP symbol is limited at the inside of the compass rose coincident with the head of the pointer. The course line then rotates about the head of the pointer. It does not then overfly its correct

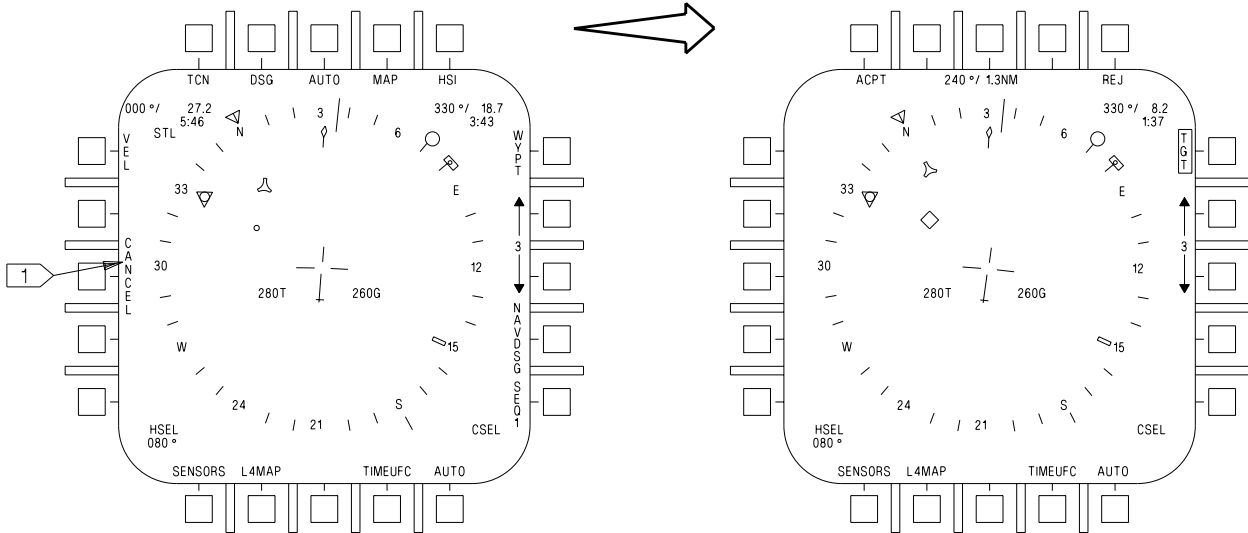

- UPDT OPTION ON THE HI TOP LEVEL DISPLAY SELECTED

1 F/A-18A AFTER AFC 253 OR 292 AND F/A-18C/D - CANCEL DISPLAYED

ACPT/REJ DISPLAY

- DSG OR MAP OPTION ON THE UPDATE SUBLEVEL DISPLAY SELECTED

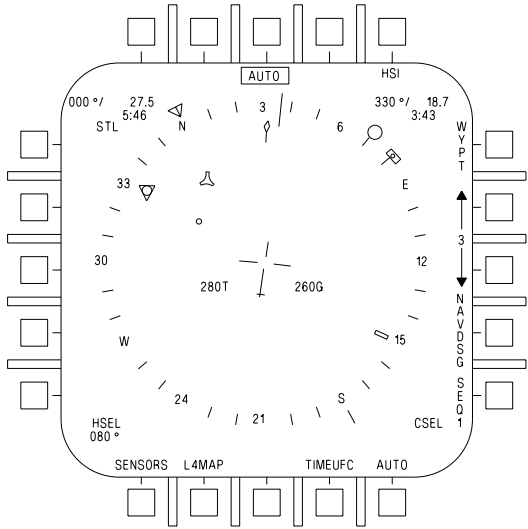

AUTO UPDATE DISPLAY

- AUTO OPTION ON THE UPDATE SUBLEVEL DISPLAY SELECTED

Figure 24-11. Position Updating Displays

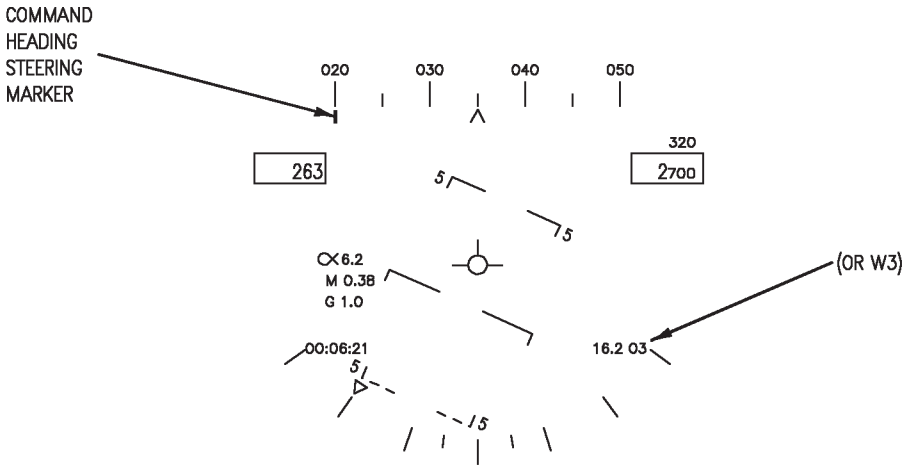

HUD STEERING DISPLAY

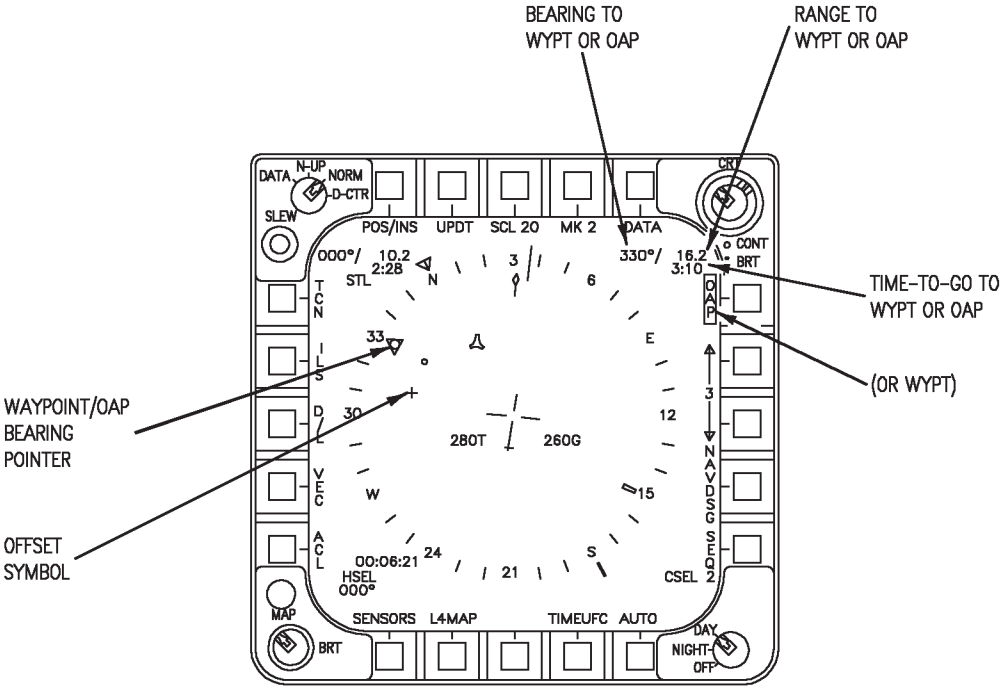

HI STEERING DISPLAY

Figure 24-12. Waypoint/OAP Direct Great Circle Steering

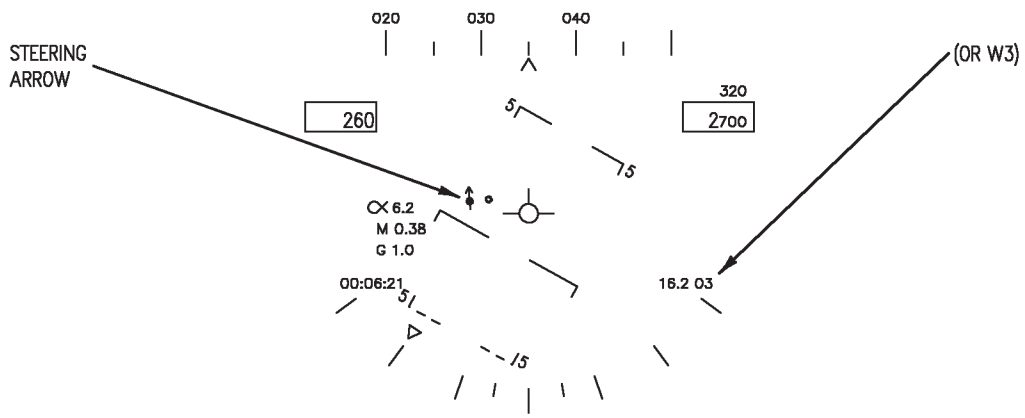

HUD STEERING DISPLAY

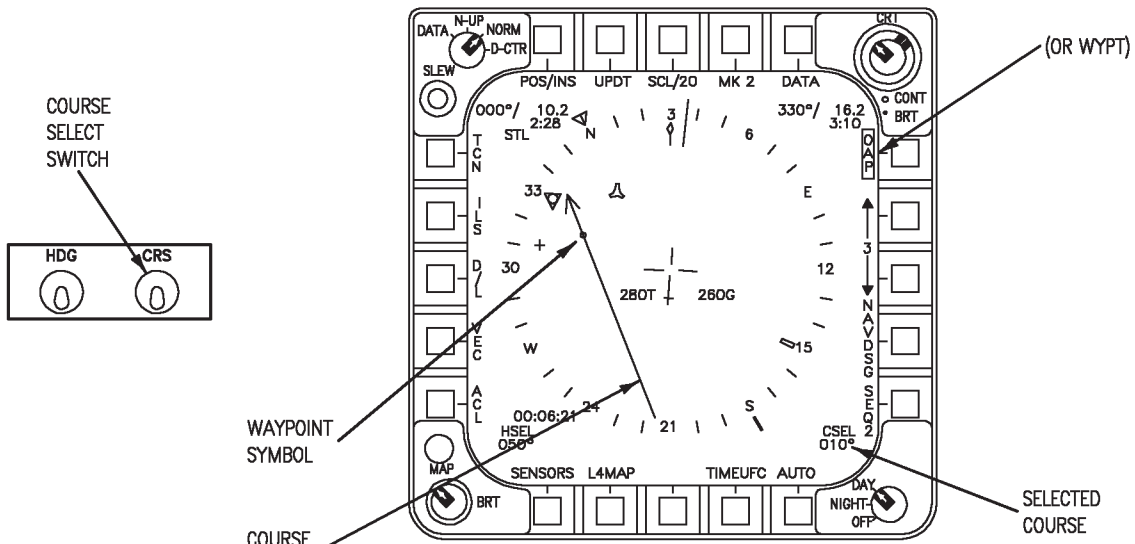

HI STEERING DISPLAY

Figure 24-13. Waypoint/OAP Course Line Steering (Sheet 1 of 2)

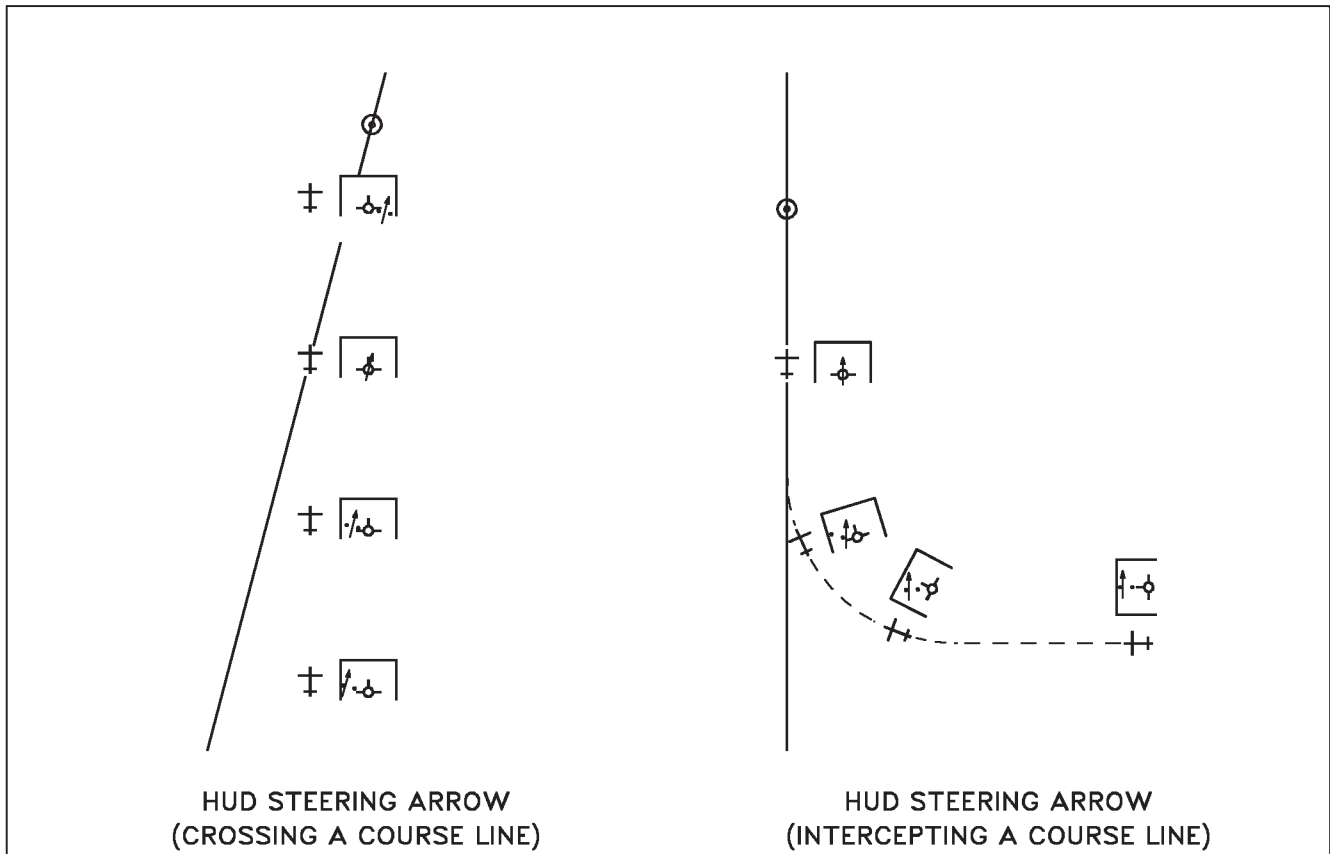

18AC-NFM-00-(81-2)31-CAT1

Figure 24-13. Waypoint/OAP Course Line Steering (Sheet 2 of 2)

position on the map. However, it does correctly indicate to which side of the aircraft the course lies and the intercept angle is correctly represented.

When a course line is selected, the steering on the HUD is as shown on figure 24-13, sheet 1. The arrow provides a horizontal situation indication relative to the velocity vector. As shown, the aircraft is to the right of the selected course, but is converging toward it. Two dots are displayed on the side of the velocity vector toward the steering arrow and in a line perpendicular to it. The outermost dot represents full scale deflection of the arrow (8°) and the innermost dot indicates half scale deflection (4°). If the arrow moves to the other side of the velocity vector, the dots appear on that side. The dots are not displayed when within approximately 1.25° of being on course. Figure 24-13, sheet 2 shows an example of the HUD steering arrow display as the aircraft crosses a course line. Figure 24-13, sheet 2, also shows the display as the aircraft turns to intercept a course line. The HUD situation arrow display is available only in NAV master mode, although waypoint/OAP steering can be selected and the course arrow can be displayed and used on the HI/MPCD in any master mode. However, only waypoint/OAP direct great circle steering is available on the HUD when designated. Also, course line steering can be deselected either by deselecting waypoint/OAP direct great circle steering, or by selecting a new waypoint/OAP, thus initializing direct great circle.

24.2.9.3 Coupled Waypoint/OAP Steering (MC OFF 13C AND UP). When waypoint steering is coupled CPL WYPT is displayed on the HUD and HSI display, and a CPLD advisory appears on the DDI. The aircraft steers to intercept the desired course line, or flies to the point if no course line is selected. Bank angle is limited by NAV or TAC Bank Limit option as selected on the A/C sublevel display and described in chapter 2. As the aircraft gets close to the desired course, the bank angle is

reduced to maintain the aircraft on the desired course. If course line steering is not selected, once the aircraft reaches the waypoint or offset aim point (OAP), WYPT steering uncouples. If course line steering is selected, the aircraft remains coupled and flies an outbound radial. Heading hold, and RALT or BALT (if selected) remain engaged when the aircraft passes the waypoint. If a ground point is designated, WYPT steering will not couple, or uncouples if previously coupled. If waypoint steering does not engage or disengages without being commanded, an AUTOPILOT caution is displayed on the DDI, and CPL WYPT flashes for 10 seconds on the HUD and HSI displays. The caution can be cleared with the paddle switch.

24.2.9.4 AUTO Sequential Steering. Before AUTO sequential steering can be selected a waypoint/OAP sequence must be programmed.

AUTO sequential steering is selected by actuating the AUTO option (AUTO boxed) on the HI/MPCD. When selected, other steering modes not compatible with AUTO sequential are deselected.

With AUTO sequential steering engaged, great circle steering is provided to the first waypoint/OAP in the selected sequence, see figure 24-14. When range to the steer to waypoint/OAP is less than 5 NM and bearing is greater than 90°, the next waypoint/OAP in the sequence is automatically selected. Great circle steering is automatically provided for each new steer to waypoint/OAP in the sequence. During AUTO sequential steering course line steering is available, however course line is deselected when the steer to waypoint/OAP is within the range and bearing mentioned above. The waypoint/OAP up/down arrows provide manual selection for steering to the desired waypoint/OAP in the sequence.

With AUTO sequential steering engaged, selecting the SEQ # option provides dashed lines on the HSI connecting the waypoint/OAPs of the chosen sequence, see figure 24-14.

AUTO sequential steering is deactivated when any of the following occur: the AUTO option deselected (unboxed), the last waypoint/OAP in the sequence is within the parameters mentioned above, selection of another steering mode, the FCS is coupled to the D/L, AUTO update is selected, a ground point is designated, magnetic heading is invalid, aircraft present position is invalid, aircraft ground track is invalid, or steering waypoint/OAP range/bearing is invalid.

With MC OFP 13C AND UP, auto sequential steering is suspended if UPDT/DSG is selected to perform an overfly designation. The automatic transition to the next waypoint does not take place until the update is either accepted or rejected and the sequence criteria is satisfied.

24.2.9.5 Coupled Auto Sequential Steering (MC OFP 13C AND UP). When auto sequential steering is coupled CPL SEQ # () (current sequence number: 1, 2, or 3 replaces the parenthesis) is displayed on the HUD and HSI display and a CPLD advisory appears on the DDI. The aircraft steers to intercept the desired course of the current WYPT/OAP in the sequence. Bank angle is limited by NAV or TAC mode as described in Chapter 2. As the aircraft gets close to the desired course, the bank angle is reduced to maintain the aircraft on the desired course. An OVFLY () option is available on the WYPT data option display. When this option is selected (boxed), the aircraft overflies the current WYPT/OAP in the sequence before intercepting the course of the next one. When OVFLY () is not selected, the aircraft performs a lead turn to intercept the course of the next WYPT/OAP just prior to reaching the current point. Once the aircraft reaches the last point in the sequence, auto sequential steering uncouples. Heading hold and RALT or BALT (if selected) remain engaged when the aircraft passes the final point. If auto sequential steering does not engage or disengages without being commanded, an AUTOPILOT caution is displayed on the DDI, and CPL SEQ () flashes for 10 seconds on the HUD and HSI displays. The caution can be cleared with the paddle switch.

Coupled AUTO sequential steering is selected as described above in the Auto Sequential Steering paragraph.

Coupled AUTO sequential steering is deactivated as described above in the Auto Sequential Steering paragraph.

Coupled auto sequential steering is disengaged if UPDT/DSG is selected to perform an overfly designation. The automatic transition to the next waypoint does not take place. When auto disengage from coupled steering occurs, autopilot cautions occur. Coupled steering does not automatically re-engage after the update is complete.

24.2.9.6 Groundspeed Cuing. Before groundspeed cuing is available for display, certain criteria must be met: a waypoint/OAP sequence must be entered, a target waypoint/OAP in the sequence must be selected, time of day must be entered (ZTOD or LTOD), and TOT must also be entered. With waypoint/OAP great circle steering engaged to the target waypoint/OAP, the MC calculates the groundspeed required to arrive at the target based on a direct path to the target and the entered TOT. With AUTO sequential engaged, the MC calculates the groundspeed required to arrive at target waypoint/OAP taking the sequential path to the target. The MC calculates the necessary groundspeed based on the pilot entered groundspeed, providing there is enough time to travel the final leg at the entered groundspeed and arrive at the target at the TOT. However, if there is not enough time to travel the final leg at the pilot entered groundspeed, the MC ignores the pilot entered groundspeed and calculate a groundspeed to arrive at the target on time.

NOTE

- Programming a required groundspeed is not necessary for ground-speed cuing calculations.
- The designated target waypoint/OAP must be in the waypoint/OAP sequence in order for the required groundspeed cueing function to operate.

If the target is an OAP the groundspeed required calculation includes the distance from the OAP to the offset. If the target is NAV designated the MC uses the NAV designation location in the calculation of groundspeed required for TOT. Also, once the target waypoint/OAP is NAV designated, any other designation means may be used to adjust the designation and the groundspeed calculation continues to be calculated to the adjusted designation.

HUD cuing of required groundspeed consists of a tick mark and arrow head located under the airspeed box. The arrow head is referenced to the tick mark, to indicate if the aircraft is traveling too fast or too slow to reach the target on time. The arrow head is displayed to the left of the tick mark when the aircraft is traveling too slow and displayed to the right of the tick mark when the traveling too fast. Full displacement of the arrow head left or right of the tick mark indicates a difference of 30 knots between actual and required groundspeed. The aircraft is traveling the correct speed when the arrow head is centered on the tick mark. The required groundspeed readout is displayed on the HI/MPCD under the present ground speed readout. See figure 24-14 for an example of HUD and HI/MPCD groundspeed cuing.

24.2.10 Designation. Designation of a waypoint/OAP is the action by which the pilot identifies a waypoint/OAP position to the MC so that position can be used for sensor slaving, steering or position updating. Navigation and overfly designations are discussed here, while sensor designations are

described in the NTRP 3-22.2-FA18A-D NATIP. Designating a waypoint/OAP instigates the following changes on the HI/MPCD: the NAVDSG option is removed/replaced with the O/S option, WYPT/OAP is replaced with a boxed TGT/OAP legend, the waypoint symbol is replaced with the target diamond, the waypoint symbol inside the waypoint steering pointer is also replaced with the target diamond and the steering information in the upper right corner now relates to the target. Designating a waypoint/OAP also provides the following changes on the HUD: a target diamond appears below the heading scale to provide target heading information, another target diamond also appears indicating the target line of sight (LOS) and the WYPT data (range) on the lower right corner is replaced with TGT data. HUD target steering operates the same as described for waypoint/OAP great circle steering.

24.2.10.1 NAVDSG (Navigation) Designation. Selecting the NAVDSG option designates the waypoint as a target, with the changes mentioned above appearing at designation, see figure 24-15.

To NAVDSG an OAP the procedure is slightly different. When the NAVDSG option is selected the OAP is designated and all data for the designated target on the HI/MPCD and HUD operates the same as described above, except for the following: the NAVDSG legend is replaced with the O/S option, and the OAP option is boxed. The O/S option must now be selected to add the offset data to the OAP position which completes the designation. Another method of adding the offset data to the OAP position (completing the designation) is to assign the TDC to the HI/MPCD then actuate the TDC. When this occurs, the O/S legend is removed, the boxed OAP legend is replaced with a boxed TGT legend, the offset symbol is replaced with the target diamond and the designated aimpoint reverts to the aimpoint symbol. A NAVDSG cannot be performed if a waypoint/OAP is already designated, see figure 24-15.

24.2.10.2 Overfly Designation. An overfly designation is performed on a waypoint/OAP by pressing the TDC while it is assigned to the HI/MPCD and the aircraft is overflying the waypoint/OAP. When this happens the MC assumes that the aircraft is over the waypoint/OAP and the aircraft present position at that time is designated as the waypoint/OAP position. In the case of an OAP the offset data is automatically added to the aircraft present position to complete the designation. When an overfly designation is performed the changes mentioned above occur, see figure 24-16.

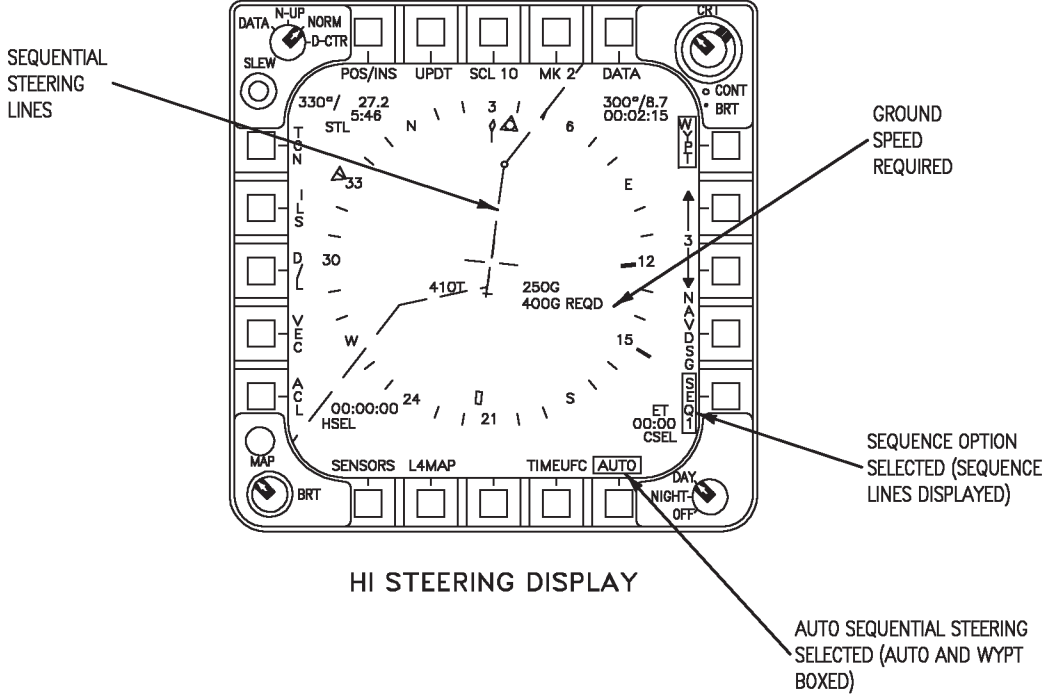
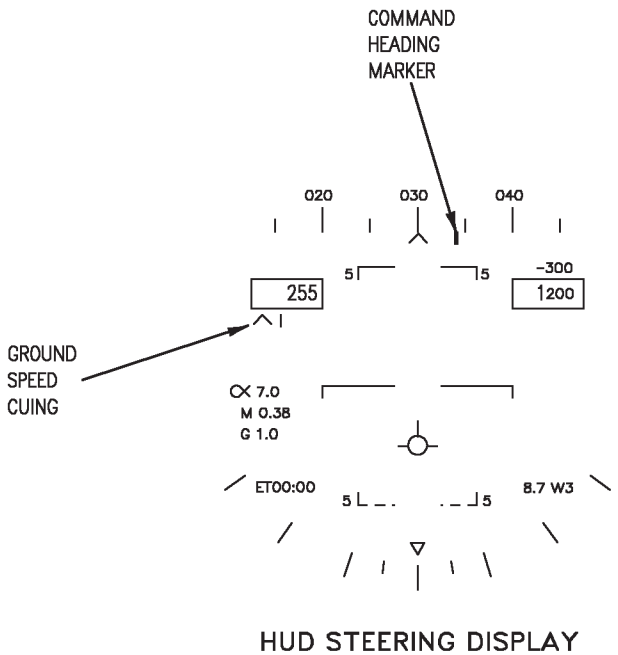
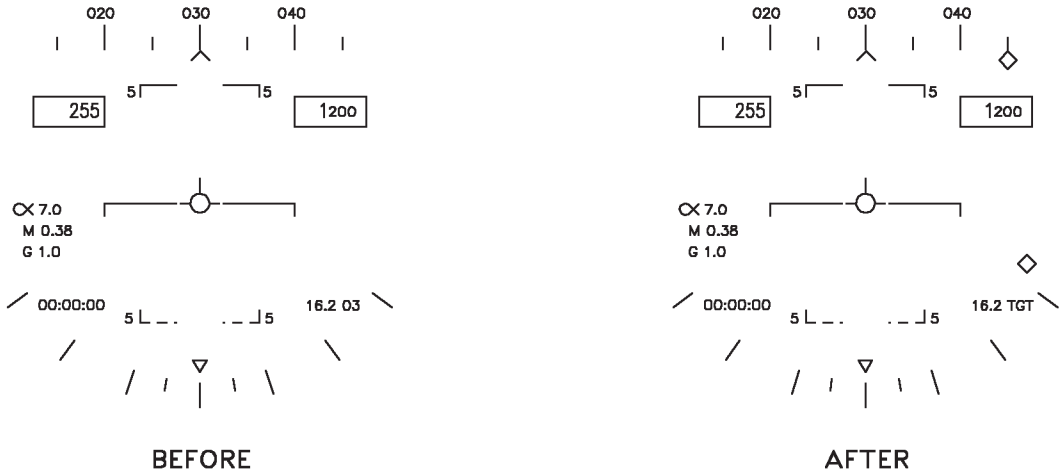
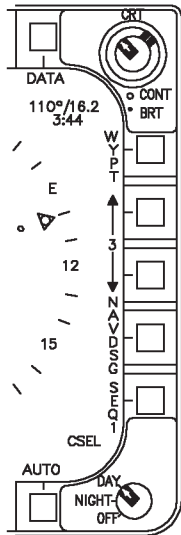

Figure 24-14. AUTO Sequential Steering



HUD NAVDSG DESIGNATION DISPLAY



BEFORE

NAVDSG OF A WAYPOINT

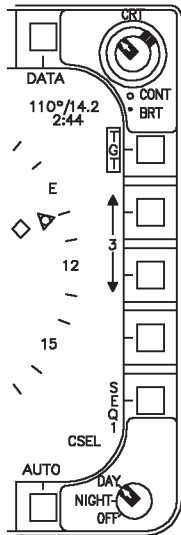

AFTER
NAVDSG
SELECTED

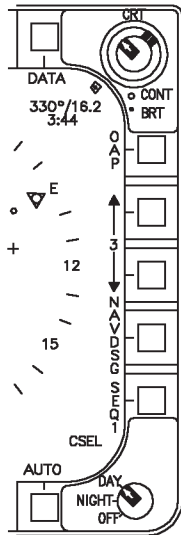

BEFORE

NAVDSG OF AN OAP

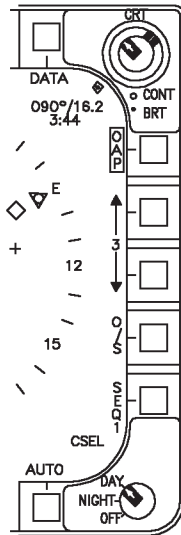

NAVDSG
SELECTED

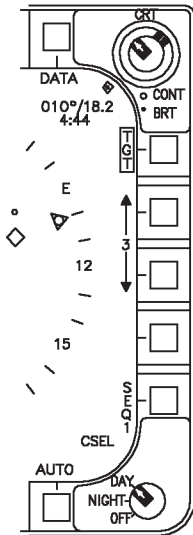

O/S SELECTED
OR
TDC PRESSED

Figure 24-15. Navigation Designation (NAVDSG)

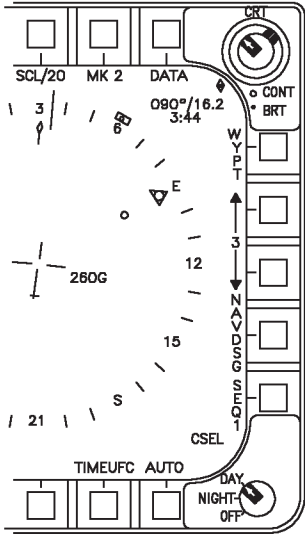

BEFORE

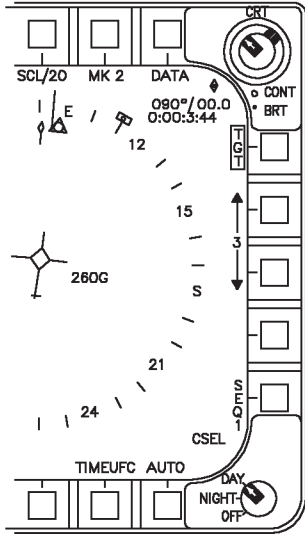

AFTER
(TDC PRESSED)

HI WAYPOINT OVERFLY DESIGNATION DISPLAY

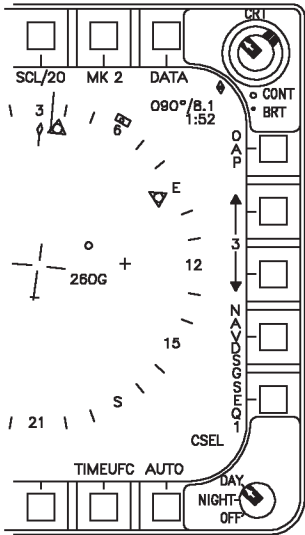

BEFORE

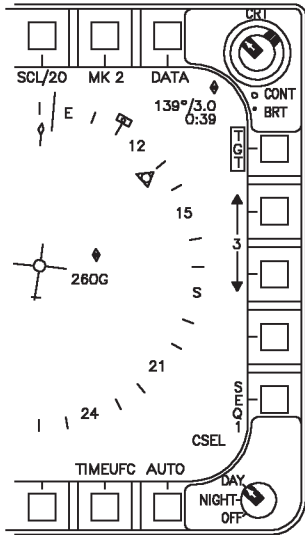

AFTER
(TDC PRESSED)

HI OAP OVERFLY DESIGNATION DISPLAY

NOTE

HUD SYMBOLRY FOR AN OVERFLY DESIGNATION IS IDENTICAL TO A NAVDSG.

Figure 24-16. Overfly Designation

24.2.11 INS Updates (Not available in AINS)**Radar**

1. Master mode - NAV (RADAR SURF) or A/G
2. Radar mode - EXP 1, EXP 2, EXP 3, or MAP
3. WYPT - SELECT
4. NAV DSG - PRESS
5. TDC/DC - ASSIGN TO RADAR
6. UPDT - PRESS
7. DSG - PRESS
8. Slew cursor over waypoint and release TDC
9. Accept or reject

HUD

1. WYPT - SELECT
2. NAV DSG - SELECT
3. TDC/DC - ASSIGN TO HUD
4. UPDT - PRESS
5. DSG - PRESS
6. Slew HUD diamond over waypoint and release TDC/DC
7. Accept or reject

Overfly

1. WYPT - SELECT
2. TDC/DC - ASSIGN TO HI/MPCD
3. UPDT - PRESS
4. DSG - PRESS
5. Actuate TDC/DC when aircraft is over waypoint
6. Accept or reject

AUTO

1. WYPT - SELECT
2. TDC/DC - ASSIGN TO HI/MPCD
3. UPDT - PRESS
4. AUTO - PRESS
5. Actuate TDC/DC when aircraft is over waypoint

Map

1. WYPT - SELECT
2. UPDT - PRESS
3. MAP - PRESS (automatically assigns TDC/DC to HI/MPCD)
4. Overfly desired geographical reference and actuate TDC/DC
5. Select slew and slew map reference under aircraft symbol, release TDC/DC
6. Accept or reject

TACAN

(1 of 10 available TACAN stations must be in reception range)

1. UPDT - PRESS
2. TCN - PRESS
3. Accept or reject

Velocity

1. UPDT - PRESS
2. VEL - PRESS
3. Accept or reject

24.3 ADF (Automatic Direction Finder).

The OA-8697/ARD ADF is a VHF/UHF direction finder operating in the 100 to 400 MHz frequency range. The system has two sections: the antenna section which receives and modulates rf signals, and the audio processing section which resolves bearing in the ADF audio received from the VHF/UHF receiver-transmitter. Bearing information received by the ADF is sent to the MC where the data is processed to position the ADF bearing pointer on the HI/MPCD. The channel to the station to which ADF bearing is required is selected on the comm 1 or comm 2 radio.

The ADF system is turned on using the ADF function selector switch on the UFC. Placing the switch to the 1 position applies power to the ADF and indicates ADF bearing to the station selected on the comm 1 radio. Placing the switch to the 2 position applies power to the ADF and indicates ADF bearing to the station selected on the comm 2 radio. Placing the switch to the OFF position removes power from the ADF. ADF audio is adjusted by either the comm 1 or comm 2 volume control knob. ADF symbology appears as a small circle on the HI/MPCD.

24.4 TACAN (Tactical Air Navigation).

The RT-1159A/ARN-118 TACAN system gives precise relative bearing and/or slant range distance to a TACAN ground station or range to a suitably equipped aircraft. The TACAN system operates in the L-Band frequency range, limiting the operating range to line of sight which depends upon aircraft altitude. The maximum operating range is 390 nm when the selected TACAN station is a surface beacon and 200 nm when the selected TACAN station is an airborne beacon. The aircraft receives a three letter morse code signal to identify the beacon being received. When operating in conjunction with aircraft having air-to-air capability, the A/A mode provides line of sight distance between two aircraft operating their TACAN sets 63 channels apart. Up to five aircraft can determine line of sight distance from a sixth lead aircraft in the A/A mode.

In MIDS-equipped aircraft, TACAN functionality is embedded in the MIDS terminal, replacing the AN/ARN-118 in door 13R. To preclude MIDS interference with the IFF system, notch frequency filters were placed in the MIDS TACAN antenna lines. The upper filter is fixed, while the lower filter is switched in for LINK-16 transmissions, and out for TACAN transmissions and all reception. Because the upper antenna filter is fixed, it filters A/A TACAN frequencies on channels 1-36 and 64-99 (X and Y). A/A TACAN channels should be chosen outside of these ranges. The upper filter makes the top antenna unusable for T/R (Air to Ground) TACAN channels 1-29 X and Y, 47X to 63X and 64Y to 92Y. For TACAN channels in these ranges, the bottom antenna is the only antenna for TACAN. With a centerline tank installed, the antenna is blocked approximately $180^{\circ} \pm 15^{\circ}$ relative to the aircraft nose. This shadowing of the bottom antenna, combined with the lower transmitter power of the MIDS (200W versus 1000W for AN/ARN-118), causes reduced ranges for DME at channels within the range of the filter when flying directly away from the TACAN station. Flight test data at afloat stations shows that maximum tail-aspect DME ranges of approximately 22 nm at 6,000 feet and 26 nm at 15,000 feet can be expected to make DME unreliable when headed outbound in the marshal stack. At shore stations, flight tests have shown substantially better tail-aspect DME ranges (e.g. 52 nm at 15,000 feet). DME ranges in the forward and side quadrants of the aircraft, and bearing performance in all quadrants, are not impacted. Therefore, approach performance on the affected channels is nominal.

NOTE

MIDS equipped aircraft may experience TACAN bearing and DME dropouts. MIDS equipped aircraft with a centerline tank may experience loss of DME during outbound legs from TACAN stations 1 to 29X and Y, 47X to 63X and 64Y to 92Y.

24.4.1 TACAN BIT. To manually initiate a TACAN BIT check, ensure the TACAN is turned on, then press the TCN/IFF option on the BIT sublevel display. If the TACAN is good, the DDI shows the BIT status as GO. If the TACAN does not pass the BIT check, the BIT status shows DEGD. The TACAN system also has an automatically initiated BIT. If the automatic BIT check detects a wrong signal or a failure, a TACAN DEGD is displayed on the DDI BIT display and the BIT line on the left DDI. If no fault is detected, nothing is displayed next to TCN. In MIDS equipped aircraft, the only way to execute a TACAN BIT is by initiating a MIDS BIT. To run a MIDS BIT, MIDS must be selected in the COMM submenu of the BIT display.

24.4.2 TACAN Mode Selection. To enable the TACAN system actuate the TCN function selector pushbutton on the UFC. This allows the TACAN channel number and ON/OFF status to be displayed on the UFC scratchpad, along with the TACAN mode options on the UFC option windows, see figure 24-17. Now actuate the ON/OFF selector pushbutton to turn the TACAN system on. The TACAN channel number may be changed using the UFC keypad.

When the TCN pushbutton is selected, the following TACAN mode options appear: T/R (transmit/receive), RCV (receive), A/A (air-to-air), along with the X and Y channels options. In the T/R mode the TACAN computes bearing and measures slant range from the selected TACAN station. In the RCV mode only bearing from the selected TACAN station is computed. In the A/A mode, interrogations and replies are only single pulse from one aircraft to another.

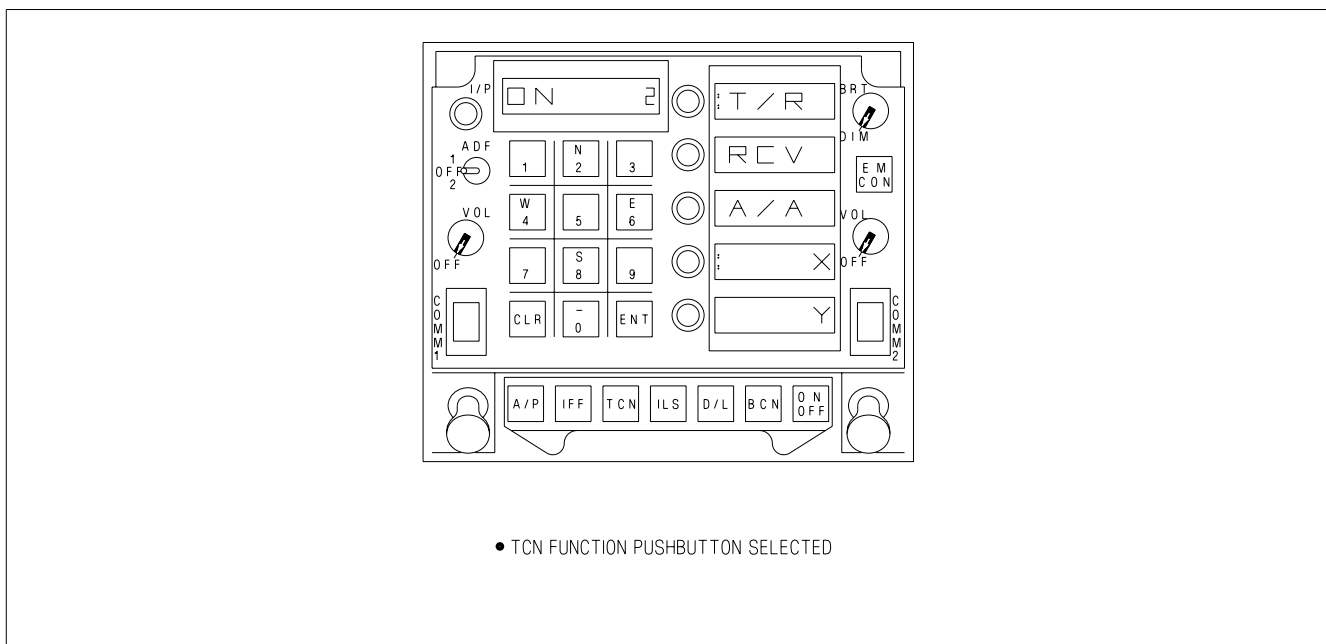

Figure 24-17. TACAN Mode Selection

ADA520-121-1-045

24.4.3 TACAN Programming. To enter TACAN station data, select the DATA option on the HSI display. Then select the TCN option on the DATA sublevel display to bring up the TACAN data sublevel display. This display shows the current TACAN station data: lat/long position, elevation and magnetic variation. To enter the TACAN station number, select the up/down arrow to select the desired TACAN station number. Next, select the UFC option to initialize the UFC for TACAN station data entry. On the UFC select: the X or Y pushbutton to select the TACAN channel, the POSN pushbutton to enter lat/long data, the ELEV pushbutton to enter elevation data, and the MVAR pushbutton to enter magnetic variation. TACAN data is entered through the UFC keypad for up to 10 TACAN stations. See figure 24-18.

24.4.3.1 TCN/AC MGVAR Option (MC OFP 13C AND UP). TACAN or AC magnetic variation can be selected from the HSI/DATA/TCN display. AC MGVAR is the default. In regions where the magnetic variation is rapidly changing, selecting TCN MGVAR can give more consistent steering information relative to the TCN station. See figure 24-18.

24.4.4 TACAN Position Keeping. The TACAN system may be used for position keeping purposes. To do this the TACAN system must be in the T/R mode with the proper channel (X or Y) and channel number selected. The TACAN station selected must be one of the prestored stations. Now select the

POS/XXX option on the HSI display. This provides the position keeping option display, see figure 24-10. Next, select the TCN option as the position keeping source. When this is done the HSI display is returned along with POS/TCN displayed as the position keeping source.

24.4.5 TACAN Position Updating. The TACAN system may also be used for position updating purposes. To do this the TACAN system must be in the T/R mode with the proper channel (X or Y) and channel number selected. The TACAN station selected must be one of the prestored stations. Now select the UPDT option on the HSI display, this provides the UPDT option display, see figure 24-11. Next, select the TCN option; when this is done the MC uses position data from the selected TACAN station to compute aircraft present position. The difference between the TACAN computed present position and the on board determination of aircraft present position produces the position error readout in bearing and range on the ACPT/REJ display. Selecting the ACPT option accepts the position update and returns the HSI display. Selecting the REJ option rejects the update and returns the HSI display.

24.4.5.1 TACAN Steering. Two types of TACAN steering are available for selection: direct great circle and course line steering. These TACAN steering options are mechanized identical to waypoint/OAP direct great circle and course line steering, with steering being referenced to the TACAN. Selecting the TCN option on the HSI display provides TACAN direct great circle, see figure 24-19. Activating the CSEL switch with TACAN direct great circle already selected provides TACAN course line steering, see figure 24-20.

24.4.5.2 Coupled TACAN Steering (F/A-18A after AFC 253 or 292 and F/A-18C/D). When TACAN steering is coupled CPL TCN is displayed on the HUD and HSI display, and a CPLD advisory appears on the DDI. The aircraft steers to intercept the desired course line, or flies to the TACAN station if no course line is selected. Bank angle is limited by NAV or TAC mode as described in chapter 1. As the aircraft gets close to the desired course, the bank angle is reduced to maintain the aircraft on the desired course. If a course line is selected, the aircraft continues past the TACAN station on the outbound radial until the mode is decoupled. If no course line is selected, TACAN steering uncouples when the aircraft reaches the TACAN station. Heading hold and RALT or BALT (if selected) remain engaged when the aircraft passes the TACAN station. If TACAN steering does not engage or disengages without being commanded, an AUTOPILOT caution is displayed on the DDI, and CPL TCN flashes for 10 seconds on the HUD and HSI displays. The caution can be cleared with the paddle switch.

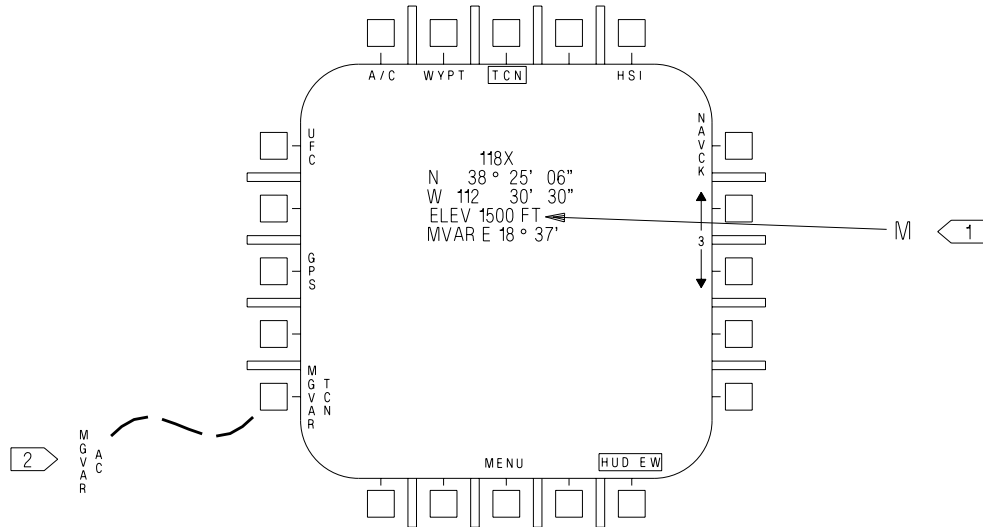

HSI TCN DATA SUBLEVEL DISPLAY

- TCN OPTION SELECTED.

- 1 F/A-18A AFTER AFC 253 OR 292 AND F/A-18 C/D
- 2 MC OFP 13C AND 15C

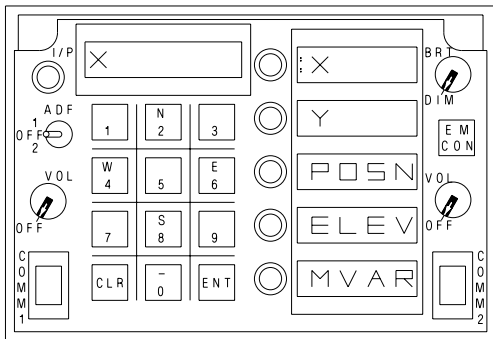

TCN PROGRAMMING OPTIONS

- WHEN UFC OPTION ON HSI TCN SUBLEVEL DISPLAY SELECTED.

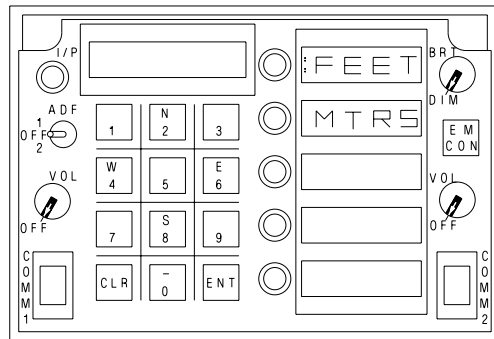

ELEV PROGRAMMING OPTIONS

- WHEN ELEV OPTION ON UFC SELECTED
F/A-18A AFTER AFC 253 OR 292 AND F/A-18 C/D.

Figure 24-18. TACAN Programming

COMMAND HEADING
STEERING POINTER

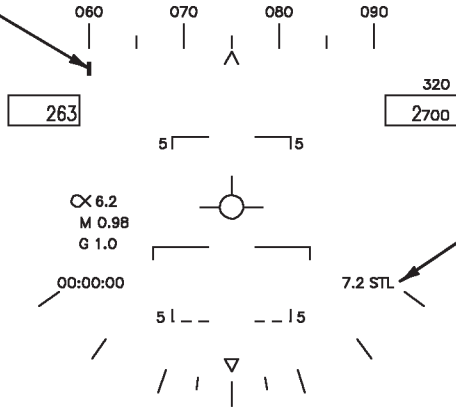

SLANT RANGE
TO TACAN STATION

HUD STEERING DISPLAY

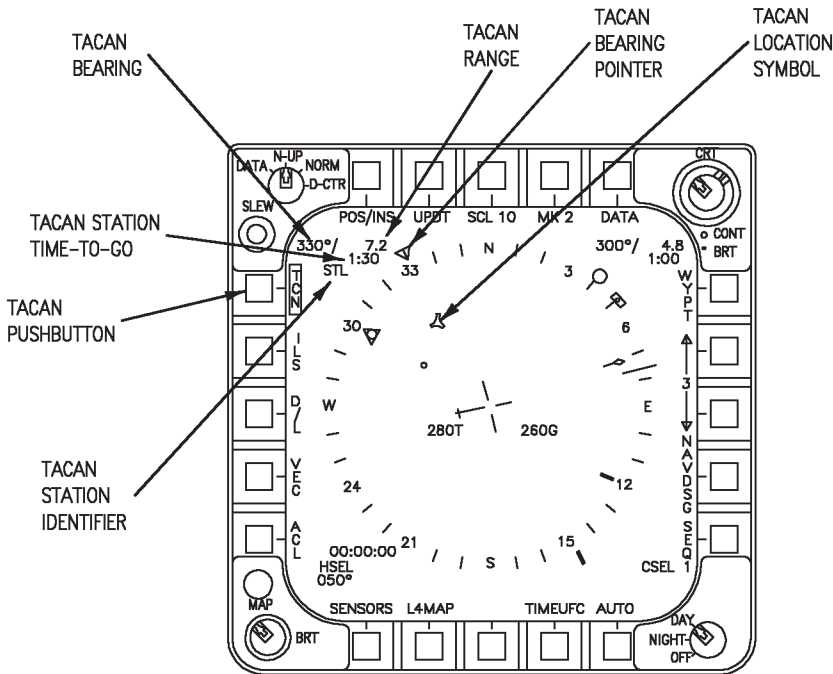

HI STEERING DISPLAY

Figure 24-19. TACAN Direct Great Circle Steering

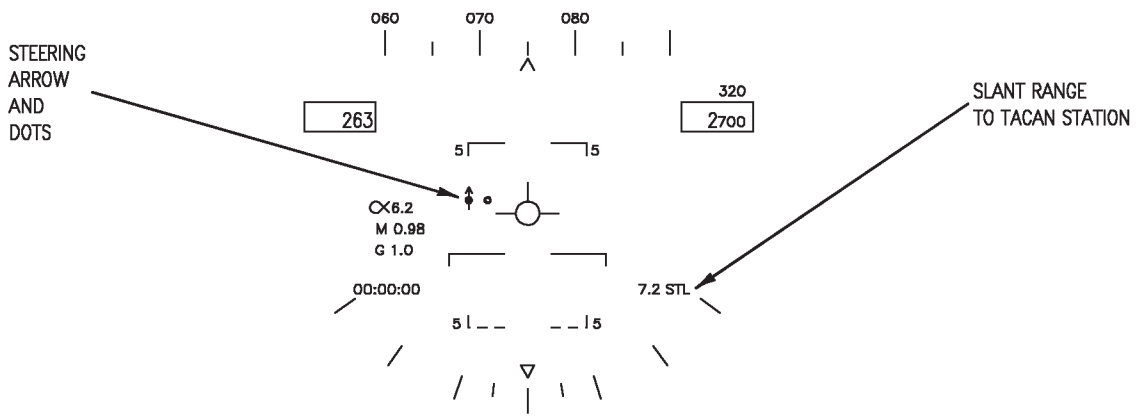

HUD STEERING DISPLAY

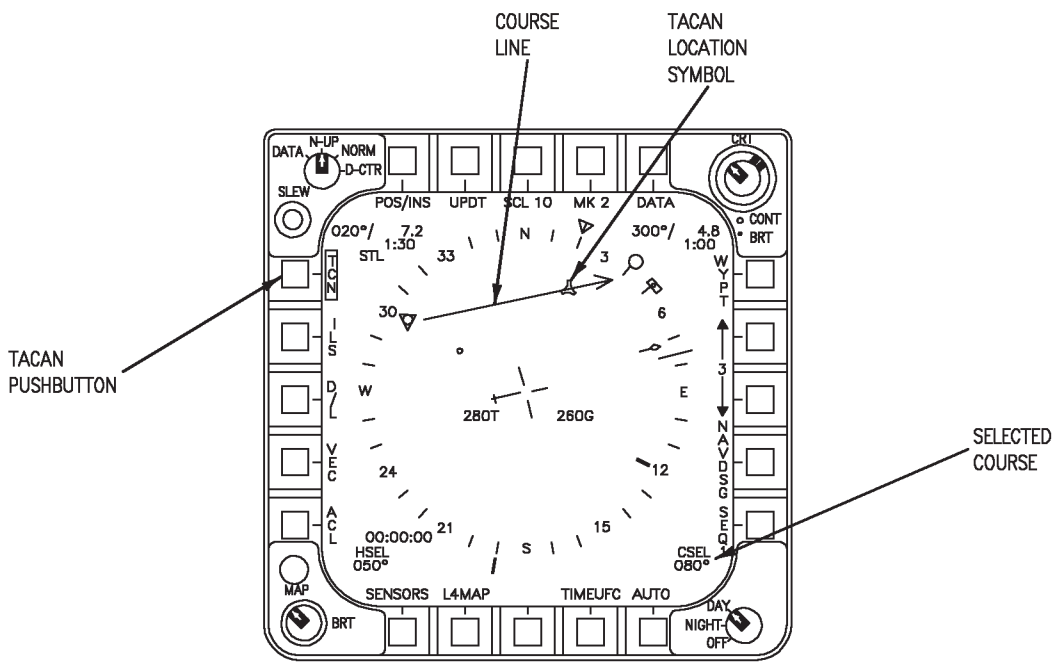

HI STEERING DISPLAY

Figure 24-20. TACAN Course Line Steering

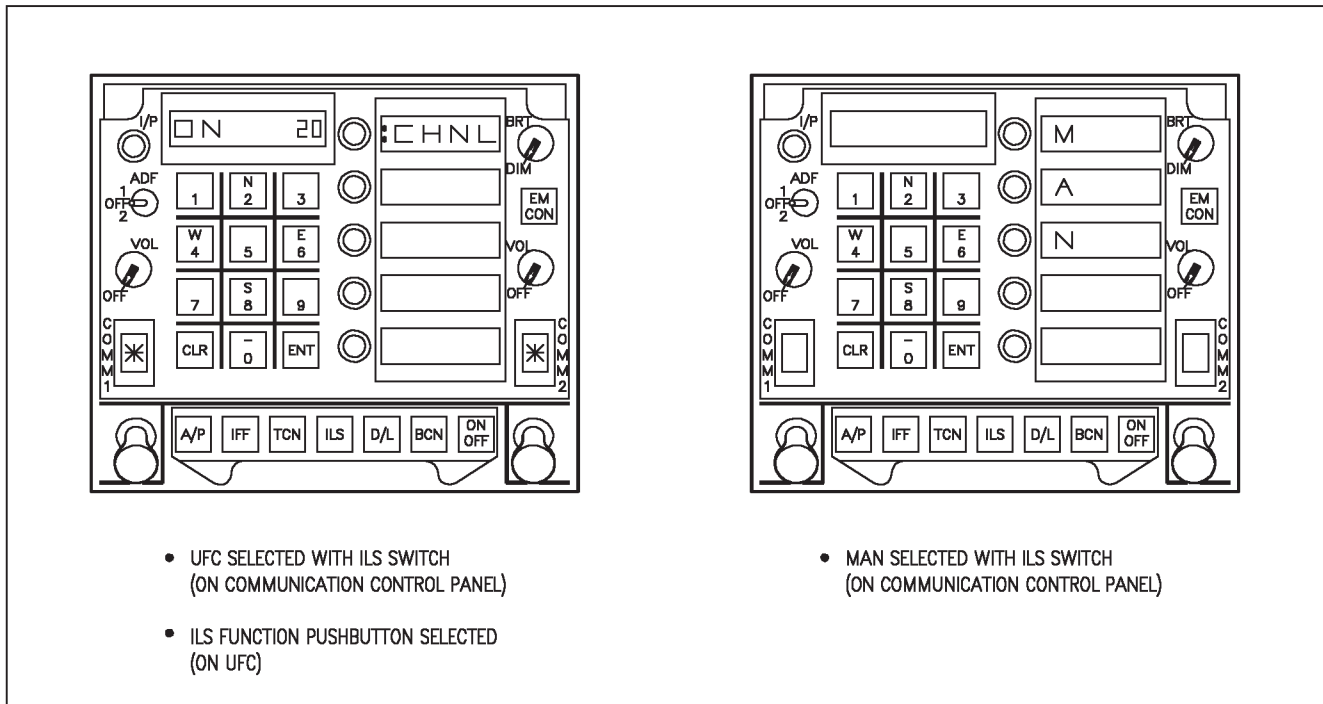

18AC-NFM-00-(117-1)31-CAT1

Figure 24-21. ILS Initialization

24.5 ILS (INSTRUMENT LANDING SYSTEM)

The AN/ARA-63A ILS is an all weather approach guidance system which operates with an aircraft carrier installed transmitting set AN/SPN-41. The ILS decodes transmitted azimuth and elevation signals during an approach and provides steering information for display on the HUD, standby attitude reference indicator, and on F/A-18C/D aircraft the EADI. The major components of the AN/ARA-63A system are a receiver and decoder.

24.5.1 ILS Receiver. The ILS receiver receives coded transmissions of azimuth and elevation guidance data from surface transmitters. The receiver transforms these signals into coded pulses suitable for processing in the decoder. A BIT module for system BIT check is contained within the receiver.

24.5.2 ILS Decoder. The ILS decoder receives and decodes azimuth and elevation pulses from the receiver, and converts them to azimuth and elevation command signals for the HUD and standby attitude reference indicator.

24.5.3 ILS BIT. To manually initiate an ILS BIT check, ensure the ILS is on, then select the ILS/AUG/BCN/D/L option on the BIT sublevel display. If any of the BIT monitored outputs fail, a BIT status message of DEGD (degraded) appears on the BIT sublevel display. If the BIT checks are good, a BIT status message of GO appears on the BIT sublevel display.

24.5.4 ILS Initialization. To enable the ILS, place the ILS UFC/MAN switch on the communication control panel to the UFC position, then actuate the ILS function selector pushbutton on the UFC. This allows the ILS channel number and ON/OFF status to be displayed on the UFC scratchpad along with the CHNL option appearing on the UFC option window, see figure 24-21. Now actuate the ON/OFF selector pushbutton to turn the ILS on. The ILS channel may be changed (1 to 20) using the UFC keypad. The ILS is automatically selected when the ACL data link mode is selected.

Another method of enabling the ILS is to place the ILS UFC/MAN switch on the communication control panel to the MAN position. When this is done the ILS is turned on and the ILS channel pushbuttons on the communication control panel are used for channel selection. Also, the letters M A N appear vertically on the UFC option display windows, see figure 24-21.

24.5.5 ILS Steering. When the ILS is on and the ILS option on the HSI display is selected (boxed), ILS steering is provided on the HUD, the standby attitude reference indicator, and on F/A-18 C/D aircraft the EADI, see figure 24-22. The azimuth and elevation deviation bars are referenced to the velocity vector, however, when the waterline symbol is displayed, the deviation bars are referenced to it. As shown, the deviation bars are deflected full scale and the aircraft is below glideslope and to the left of course. The azimuth bar is deflected full scale for azimuth deviations of $\pm 6^\circ$ to $\pm 20^\circ$. The elevation bar is deflected full-scale down for elevation deviations of 1.4° to 20° , and full-scale up for deviations of -1.4° to -3° . If a valid azimuth or elevation signal is not received by the ILS, the corresponding bar is not displayed.

ILS steering is automatically provided when the ACL mode is selected and valid ILS steering signals are received.

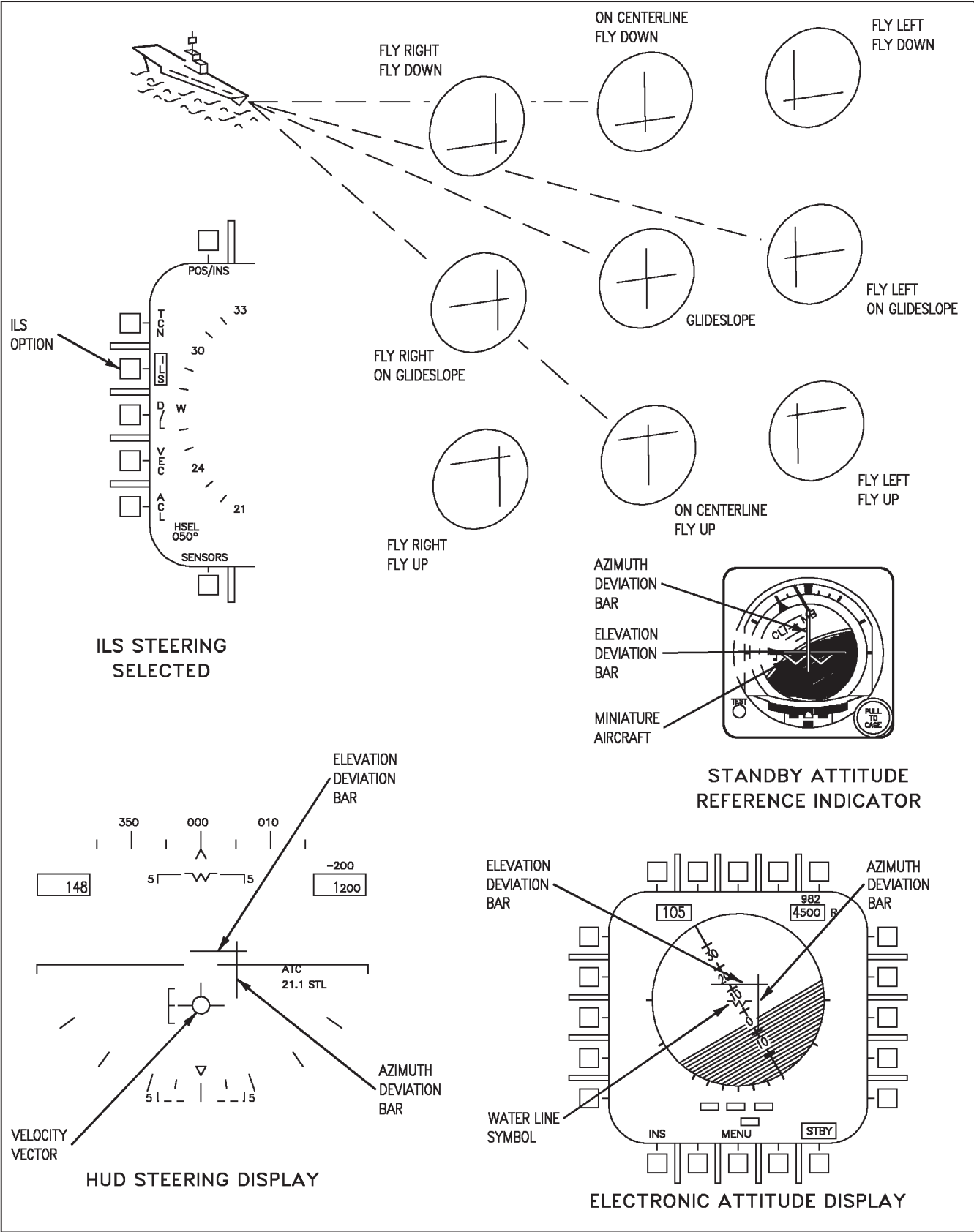

18AC-NFM-00-(88-1)31-CATI

Figure 24-22. ILS Steering

24.6 DATA LINK SYSTEM

All information on the data link systems (i.e., LINK 4 and LINK 16), except for the automatic carrier landing mode, is contained in the NTRP 3-22.2-FA18A-D NATIP. For typical Automatic Carrier Landing procedures, refer to Chapter 8.

24.6.1 Automatic Carrier Landing Mode. The system for automatic landing of aircraft onto the aircraft carrier deck comprises the AN/SPN-42 installed aboard the carrier and Automatic Carrier Landing (ACL) equipment installed in the aircraft. The aircraft data link system is the ACL component over which steering commands are received from the carrier for guidance of the aircraft.

The data link ACL mode is available only when the NAV master mode is selected. The ACL steering commands may be coupled to the flight control computer for fully automatic approaches to touchdown, or the pilot may elect to use the steering displays for a manually controlled landing. The traffic control (T/C) mode is a submode of ACL. The T/C mode provides data link heading commands to aid the pilot in reaching the marshal point and/or it may be used for azimuth alignment from marshal until ACL acquisition. These heading commands can be coupled to the flight control computer for automatic lateral axis control or can be used for manual steering aids.

Two uplinked control messages (label 5 and label 6) are uniquely addressed to a specific aircraft and received via the data link for ACL mode (and T/C submode) control and display. The label 5 message only is used for T/C mode, while both label 5 and label 6 are required for ACL modes 1, 1A, and 2 control and display. The contents of the uplinked label 5 and label 6 messages follows:

Label 5 Message

Command Altitude (feet)	Displayed on Link 4/SA display.
Command Airspeed (knots)	Displayed on Link 4/SA display.
Command Rate of Descent (feet per minute)	Displayed on Link 4/SA display.
Command Heading	Displayed on Link 4/SA and HUD.
Group 1 Discretes	ACL RDY, CMD CNT, LND CHK, NOT CMD, W/O, and CHG CHNL.
Group 2a Discretes	Monitor altitude and altitude change
Warning	Receipt of either discrete causes the command altitude and command rate of descent to be underlined on the Link 4/SA display.
Group 2b Discretes	Monitor speed and speed change warning. Receipt of either discrete causes the command airspeed to be underlined on the Link 4/SA display.
Group 2c Discretes	ADJ A/C, VOICE and 10 SEC.

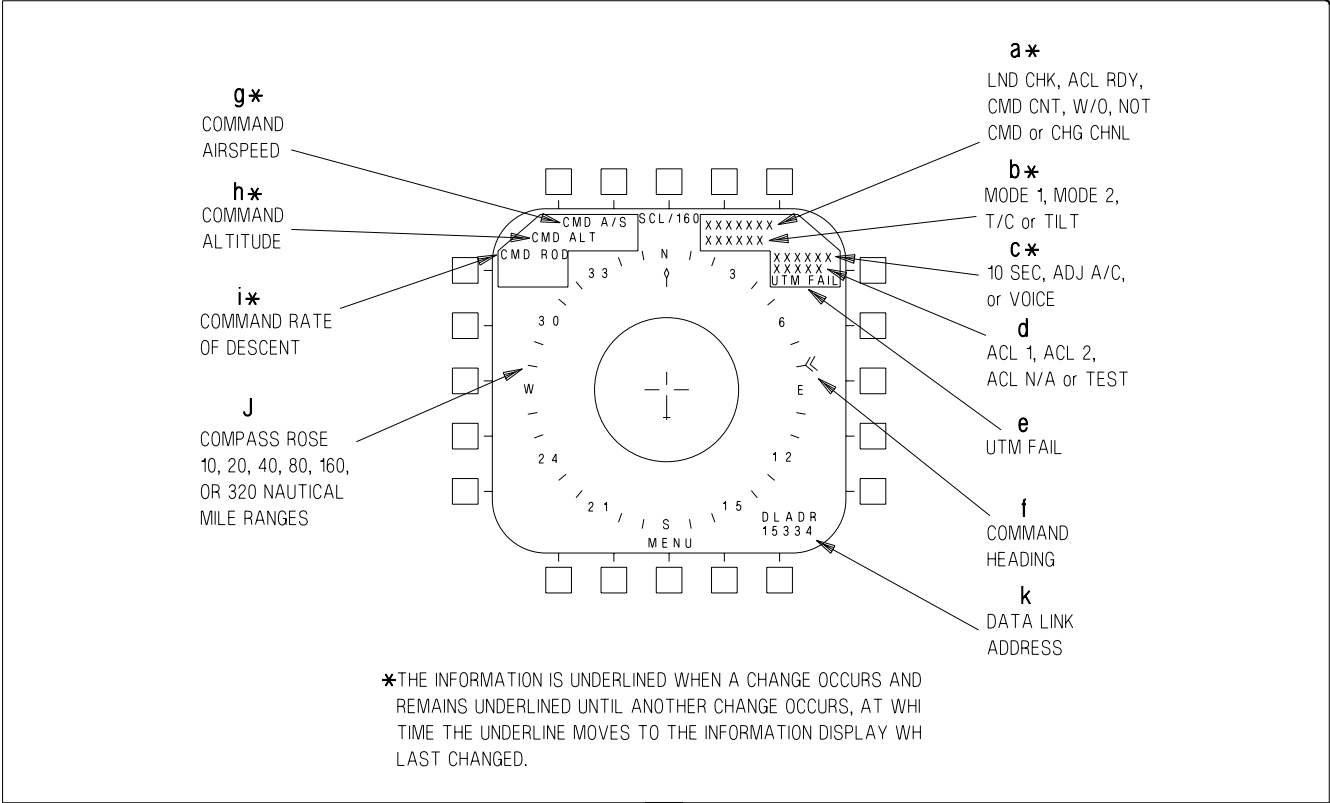

ADA520-90-1-049

Figure 24-23. DDI Link 4 ACL Display

Label 6 Message

Vertical Glide Slope Error	Used for data link HUD situation display.
Lateral Glide Slope Error	Used for data link HUD situation display.
Mode Status Discrete	Indicates that uplinked longitudinal and lateral axes commands may be used for mode 1 approach.
Longitudinal Axis Command (altitude rate in feet/second)	Used by FCS for longitudinal axis control.
Lateral Axis Command (roll angle in degrees)	Used by FCS for lateral axis control.

The ground station also periodically uplinks two universal test messages (UTM-3A and UTM-3B). These two messages have a canned constant content and carry a universal address, rather than being addressed uniquely to a controlled aircraft, as are the label 5 and label 6 messages. During ACL mode test, the data link is commanded to accept these two UTM as part of the determination of onboard ACL capability.

24.6.1.1 ACL Mode Displays. The ACL mode displays consist of the Link 4/SA display on the left DDI and the data link situation display on the HUD. The following paragraphs contain a general

description of the displays related to the ACL mode. A more explicit definition of the utilization of these displays is presented in ACL Mode Operation, this chapter.

24.6.1.1.1 Link 4/SA Display. Figure 24-23 shows the ACL and T/C information which may be displayed on the Link 4/SA display. The lettered symbols and cues on the display are described after the corresponding letter in the following paragraphs.

a. The following uplinked group 1 discrettes may be displayed in this slot.

LND CHK	Landing check indicates that SPN-42 control radar communication has been established. It also cues the pilot to be in the landing configuration with ATC engaged.
ACL RDY	ACL ready indicates that SPN-42 acquisition has occurred and uplinked longitudinal axis (altitude rate) and lateral axis (roll rate) commands are being received equal to zero. The ACL RDY indication is also displayed on the HUD. Receipt of the ACL RDY discrete is one of the onboard prerequisites for ACL couple.
CMD CNT	Command control discrete indicates that the carrier has received a verbal confirmation from the pilot that FCS is coupled to the ACL longitudinal and lateral commands, and further indicates to the pilot that longitudinal and lateral commands are now active.
W/O	When this discrete is received the FCS is uncoupled from the uplinked commands.
NOT CMD	The not command discrete indicates that label 5 information is invalid. When this discrete is received the label 5 information is removed from the Link 4/SA display and the FCS is uncoupled from the T/C heading command/ACL steering commands.
CHG CHNL	The change channel discrete indicates that the data link frequency should be changed.

b. The following ACL mode operational cues may be displayed in this slot.

MODE 1	Indicates that the entire loop is capable and ready for coupling for dual axes ACL control.
MODE 2	Indicates that the entire loop is not capable of Mode 1 coupled approach but is capable of Mode 2 manual control approach using uplinked situation steering.
T/C	Traffic control cue indicates that the entire loop is capable and ready for couple to the T/C heading command.
TILT	Indicates that the uplinked information is not being updated. When this condition exists all uplinked information is removed from the displays and the FCS is uncoupled from the data link commands.

c. The following uplinked group 2c discrettes may be displayed in this slot. These cues are displayed for 30 seconds after initial receipt, then removed.

10 SEC	Indicates that SPN-42 is now adding deck motion compensation to the longitudinal and lateral axes commands. This discrete is received approximately 12.5 seconds before touchdown.
ADJ A/C	Adjacent aircraft cue indicates that another aircraft has been detected in the area of controlled aircraft.
VOICE	Indicates that the pilot is to establish voice contact with control.

d. The following onboard capability cues are displayed in this slot.

ACL 1	Indicates that onboard systems are capable of an ACL or T/C couple to the FCS.
ACL 2	Indicates that onboard systems are not capable of ACL or T/C couple to FCS, but are capable of displaying uplinked information for a mode 2 manual approach.
ACL N/A	Indicates that onboard systems are not capable of using uplinked information and that a carrier controlled approach (CCA) must be made.
TEST	Indicates that ACL mode is in test.

e. The UTM FAIL cue is displayed in this slot when valid uplinked UTM 3A and UTM 3B were not received during automatic test.

f. Command heading is displayed via the double chevron symbol on the outside of the compass rose.

g. Command airspeed is displayed in this slot.

h. Command altitude is displayed on this slot.

i. Command rate of descent is displayed in this slot.

j. The compass rose is track-up oriented with selectable ranges of 10, 20, 40, 80, 160, and 320 nm.

k. Data Link Address that is currently set in the Link 4 RT.

24.6.1.1.2 HUD ACL Display. Figure 24-24 shows the possible HUD display information. The lettered symbols and cues on the HUD are described after the corresponding letter in the following paragraphs.

a. Uplinked command heading is indicated by the command heading steering pointer below the heading scale.

b. The following cues may be displayed in this slot:

10 SEC	Displayed for 30 seconds after receipt and then removed. Also displayed on Link 4/SA display.
--------	---

TILT	Displayed when communication has been lost with data link control. Also displayed on Link 4/SA display.
DATA	Displayed for 10 seconds and flashed at a rate of two times per second when new data is initially displayed on the link 4/SA display.
W/O	(MC OFP 13C AND UP) When this discrete is received the FCS is uncoupled from the uplinked commands.

c. The following cues may be displayed in this slot:

ACL RDY	Displayed when received via data link and the FCS is not coupled. Also displayed on Link 4/SA display.
CPLD P/R	Coupled in pitch and roll is displayed when the FCS is coupled to the longitudinal and lateral commands. The cue is flashed for 10 seconds at two times per second then removed if the couple attempt is unsuccessful, or if uncouple occurs for any reason other than pilot deselection. Disengagement, other than pilot initiated, also results in an AUTOPILOT caution.
CPLD HDG	Coupled to heading commands cue is displayed when FCS is coupled in the T/C mode. This cue is flashed for the same reasons as described for the PLD P/R cue.

d. The following cues may be displayed in this slot. These cues are mode independent and may be displayed in any master mode:

ATC	Displayed when automatic throttle control is engaged. If an unsuccessful engagement attempt occurs, or if the ATC disengages for any reason other than pilot deselection, the ATC cue to flashed for 10 seconds at two times per second, then removed.
NWS	Indicates low gain nosewheel steering is engaged.
NWS HI	Indicates high gain nosewheel steering is engaged.

e. When ACL mode is initially selected, waypoint steering is automatically deselected, if selected, and the system is automatically undesignated if an aimpoint is designated. If tacan is on, tacan range is automatically displayed regardless of tacan steering selection unless the pilot subsequently designates an aimpoint or selects waypoint steering.

f. The tadpole steering symbol is referenced to the velocity vector and provides uplinked flight path steering indications for the ACL glideslope and course.

24.6.1.2 ACL Mode Operation. The data link ACL mode is selected by actuating the ACL option button on the HI/MPCD.

24.6.1.2.1 Initialization. When selected, the ACL legend on the HI/MPCD is boxed and the Link 4/SA display is automatically selected on the left DDI. The TEST cue is displayed indicating the ACL mode is in test. The ILS, data link, and radar beacon are automatically turned on (if not previously on). IBIT is run on the data link and radar beacon systems. The uplinked UTM is monitored for valid receipt. When ACL testing is complete the TEST cue is removed, the noted systems are placed in the correct operational mode, the stored data link ACL frequency is automatically selected, and the pilot is cued on the Link 4/SA display relative to onboard ACL capability (ACL 1, ACL 2, or ACL N/A) as

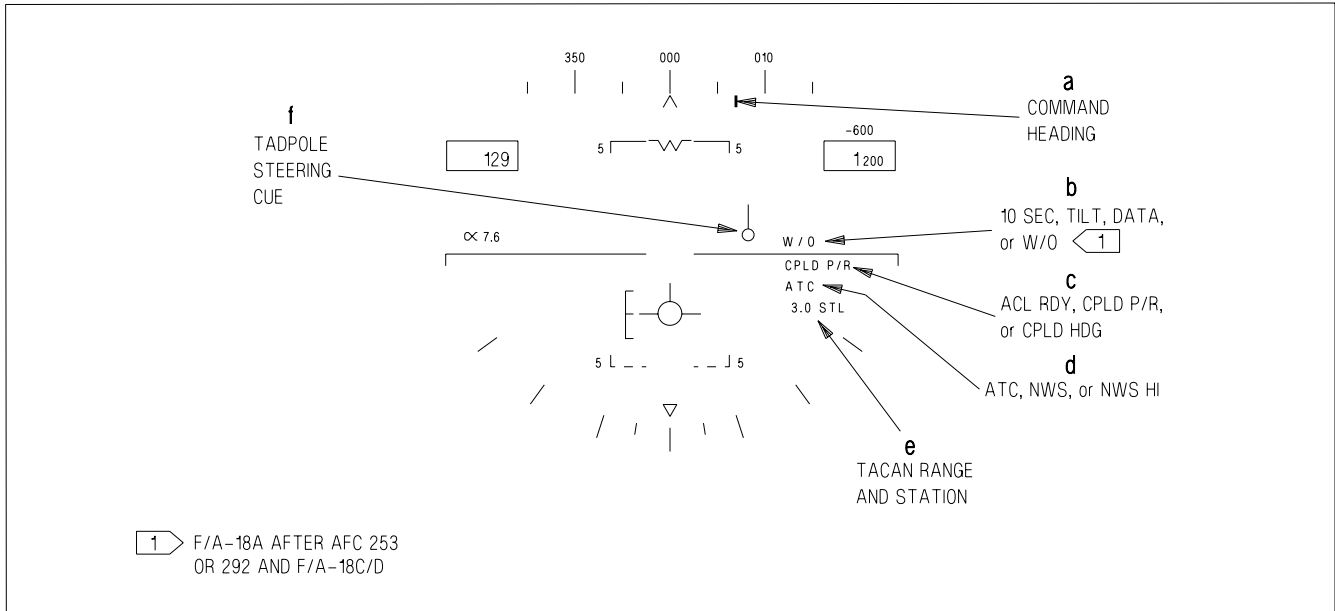

Figure 24-24. HUD ACL Display

ADA520-91-1-044

previously described. If during test, a valid uplinked UTM message was not received, the UTM FAIL cue is displayed on the Link 4/SA display.

With SCS 17C, the data link address that is currently set in the Link 4 is displayed. When the aircraft is CIT equipped and the Mode 2 code is not equal to the last four digits being displayed in the data link address, a M2ID advisory is displayed. The IFF Mode 2 code in the CIT can be set to the proper D/L address by pressing the DL ADR option pushbutton. The M2ID advisory is removed when the IFF mode 2 code is set equal to the last four digits of the D/L address.

24.6.1.2.2 Traffic Control Couple. When an uplinked label 5 message is received, a determination is automatically made relative to total loop capability. If the ACL loop is ready for a T/C couple, the T/C cue appears on the Link 4/SA display and autopilot options are initialized on the upfront control with the CPL option displayed (figure 24-25). The prerequisites for a CPL option for T/C follow:

1. Onboard systems fully operational.
2. Valid label 5 message received.
3. Waveoff (W/O) discrete not received.
4. Uplinked information being updated (no TILT cue).
5. NOT CMD discrete not being received.
6. Label 6 message not being received.

With T/C displayed FCS couple is selected by actuating the CPL option button on the UFC. When coupling to the T/C heading command is successful a colon is displayed in front of the CPL option on the UFC and the CPLD HDG cue is displayed on the HUD. After couple the FCS will bank the aircraft to maximum of 30° to capture and hold the uplinked heading command. Aircraft pitch attitude may be controlled by the pitch hold function of the heading hold mode or by the BALT or RALT altitude

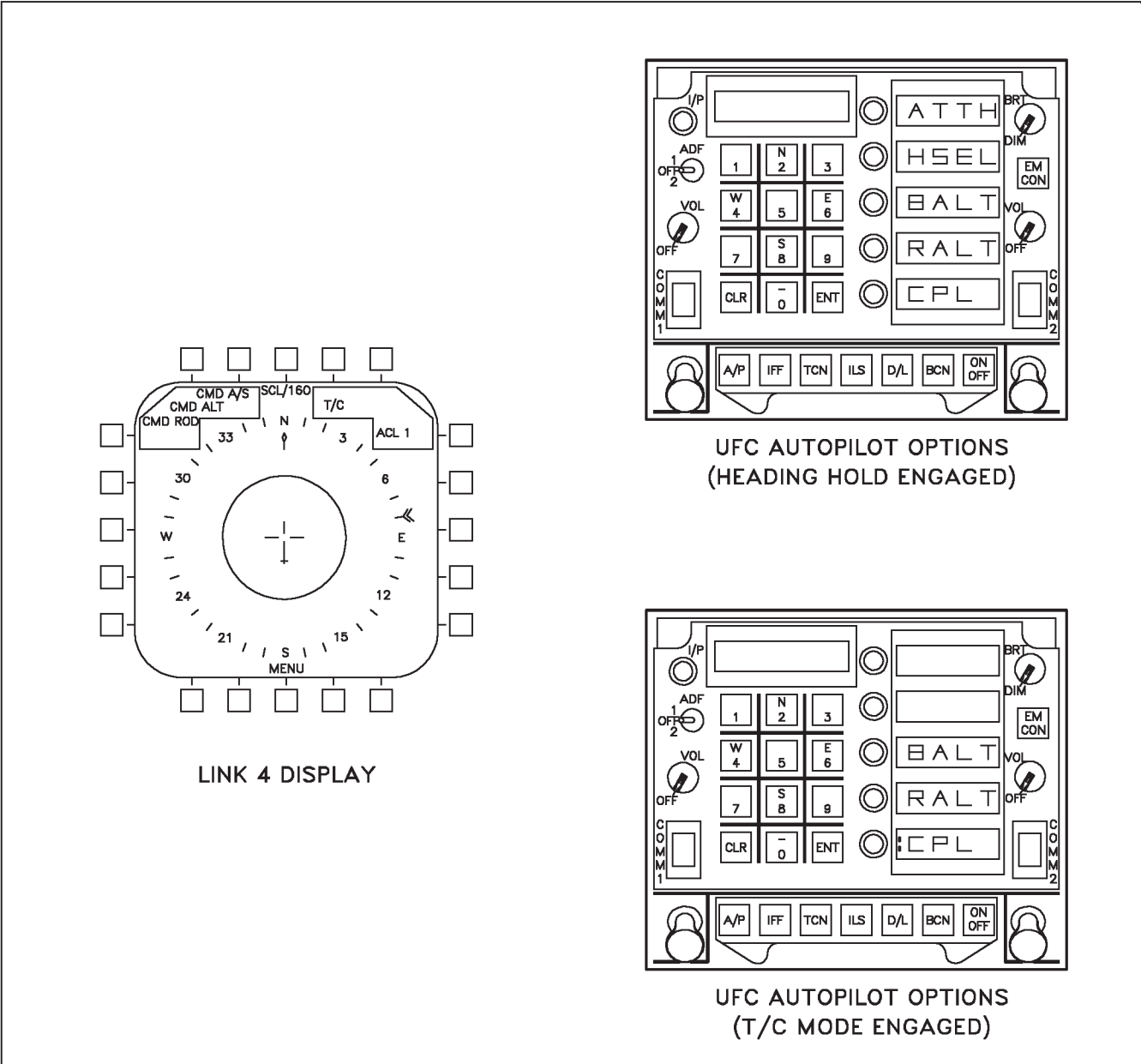

Figure 24-25. Traffic Control Couple Display

18AC-NFM-00-(92-1)31-CAT1

hold modes of the autopilot. A T/C couple precludes use of all other outer loop autopilot modes except BALT and RALT. When engaged, the T/C couple disengages (with reversions as noted) for any of the following reasons:

1. Heading hold mode disengagement with reversion to CAS operation.
2. Roll control stick steering engagement with reversion to lateral axis heading hold mode.
3. Loss of valid uplinked heading command for more than 10 seconds (TILT) with reversion to lateral axis heading hold mode.
4. Pilot deselection of CPL option with reversion to lateral axis heading hold mode.

5. Pilot actuation of paddle switch with reversion to CAS.
6. Receipt of uplinked W/O discrete with reversion to lateral axis heading hold mode.
7. Receipt of uplinked NOT CMD discrete with reversion to lateral axis heading hold mode.

An unsuccessful T/C couple attempt, or disengagement of the T/C couple for any reason other than pilot deselection, results in an AUTOPILOT caution as well as the CPLD HDG on the HUD flashing for 10 seconds.

24.6.1.2.3 ACL Mode 1. When an uplinked label 6 message is received, a determination is made with respect to total loop capability relative to dual-axis (lateral and longitudinal) ACL couple. If ACL couple is determined to be available, the MODE 1 cue is displayed on the Link 4/SA display and the autopilot options are initialized on the UFC with CPL option displayed as shown in figure 24-26.

When the pilot selects the CPL option on the UFC, an ACL couple to the FCS is requested if proper prerequisites are met.

NOTE

- If FCS is already coupled to T/C command heading, the first actuation of the CPL option disengages T/C couple and a second actuation requests ACL couple.
- Mode 1 is available only with full flaps selected.

The MC prerequisites for initial ACL couple are as follows:

1. Basic FCS outer loop (heading hold) engaged. If heading hold is not engaged when the CPL option is actuated it is automatically requested, and when FCS indicates it is engaged, ACL couple is requested.
2. Onboard test results indicate ACL 1 capability.
3. Uplinked ACL RDY discrete being received. ACL RDY is only required for initial couple. It is not required after ACL couple occurs.
4. Uplinked A/P bit set to couple state.
5. Valid uplinked longitudinal and lateral axes commands being received (no TILT).

To indicate FCS is coupled, a colon is displayed next to CPL option on the UFC and the CPLD P/R cue is displayed on the HUD. When ACL couple initially occurs, the FCS fades in the longitudinal and lateral uplinked commands to minimize engagement transients. After FCS is coupled to the dual-axis commands, the FCS limits the accepted magnitude of the uplinked commands to prevent excessive pitch or roll changes due to large and/or erroneous uplinked commands. When FCS is coupled to ACL, uncouple will occur, with reversion as noted, for any of the following reasons.

1. Heading hold mode disengagement with reversion to CAS operation.
2. Pitch or roll control stick steering engagement with reversion to CAS when CSS is no longer engaged.

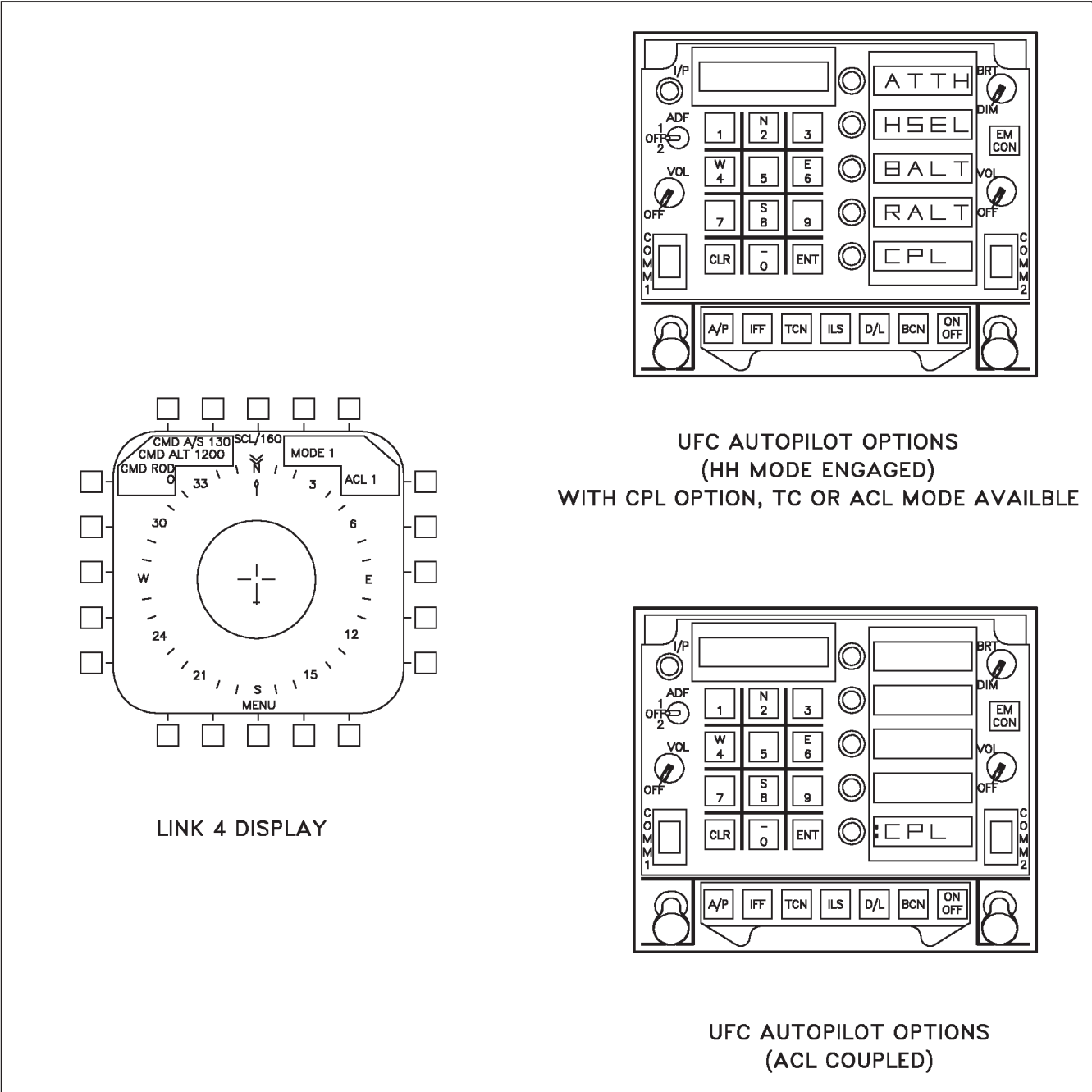
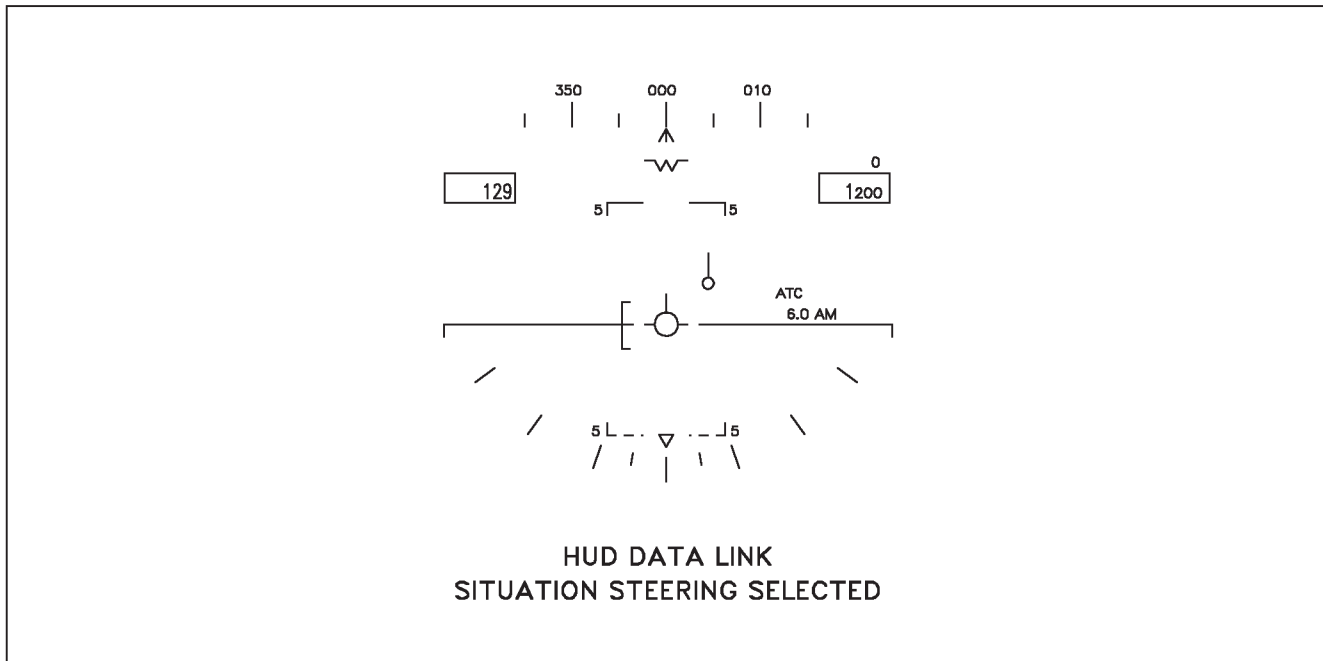

Figure 24-26. ACL Mode 1 Display

18AC-NFM-00-(93-1)31-CAT1

- 3. WOW with reversion to CAS.
- 4. Paddle switch actuation with reversion to CAS.
- 5. UFC CPL option actuation with reversion to CAS.
- 6. Receipt of W/O discrete with reversion to CAS.
- 7. Receipt of command degrading approach to mode 2 state with reversion to CAS.



18AC-NFM-00-(94-1)31-CATI

Figure 24-27. ACL Mode 2 Steering Display

8. Loss of valid uplinked commands for more than 2 seconds (TILT) with reversion to CAS.
9. Detection of degraded onboard capability below that required for MODE 1 with reversion to CAS.

During an ACL coupled approach the D/L situation steering and the ILS situation steering may remain selected for HUD display to allow the pilot to monitor the progress of the automatic control in capturing and holding the desired glideslope and azimuth.

24.6.1.2.4 ACL Mode 1A. For an ACL mode 1A approach, the aircraft may be coupled to data link commands as described in the Mode 1 paragraph, then uncoupled at minimums (200 feet and 0.5 mile) and manual control as described for Mode 2 used the rest of the way to touchdown.

24.6.1.2.5 ACL Mode 2. When a label 6 message is initially received and a mode 1 or mode 2 capability exists, a mode 2 manual approach may be made. The data link HUD steering which may be manually selected with the D/L option button on the HI is automatically selected. The D/L legend on the HI is boxed and the data link situation steering tadpole is displayed on the HUD with the tadpole referenced to the velocity vector as shown in figure 24-27. The ILS situation display may remain selected on the HUD for crosscheck on the D/L situation display and/or either D/L or ILS display may be deselected by actuating the option button on the HI. Mode 2 approaches may be made with or without ATC engaged, but if available, ATC should be used for angle of attack/airspeed control. If ATC is not engaged the HUD angle of attack bracket should be used to control AOA/airspeed, while the glide slope is maintained by flying the D/L situation steering display on the HUD.

24.6.1.3 Typical ACL Approach.

Figures 24-28 and 24-29 describe the controls and displays for a “canned” mode 1 ACL approach. The ACL mode is optimized for the described approach, but abbreviated approaches and/or deviations

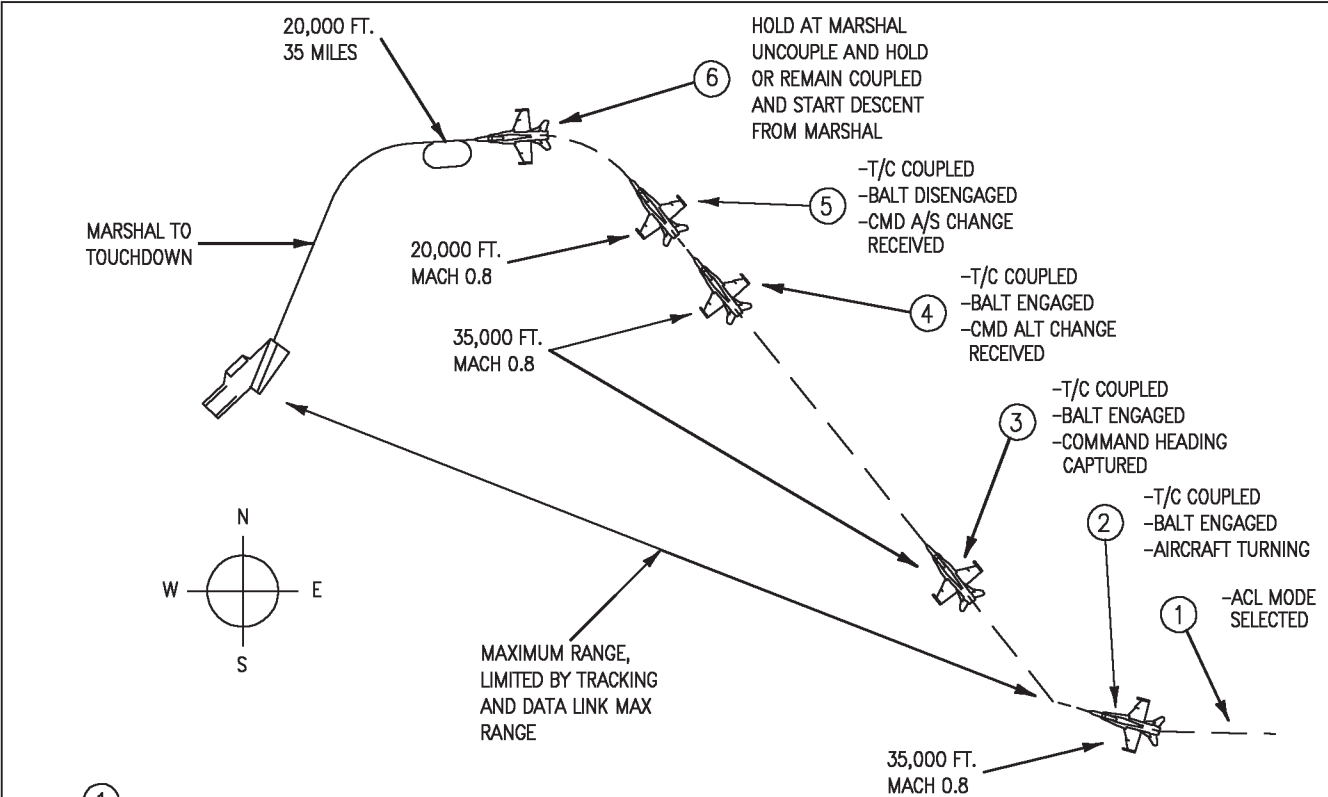

At ① the pilot has selected ACL mode on the HI and the onboard system is in test, as noted on the link 4 display. The HH mode has been engaged as shown by the other autopilot option being displayed on the UFC. D/L command information may be shown on the link 4 display and the HUD during test.

① ACL MODE SELECTED (SYSTEM IN TEST)

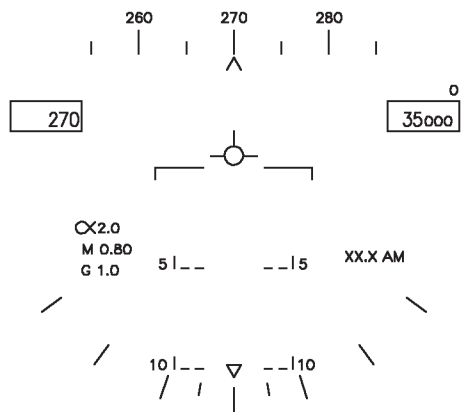
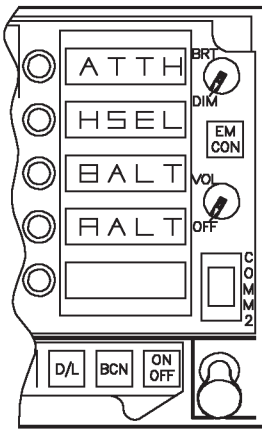
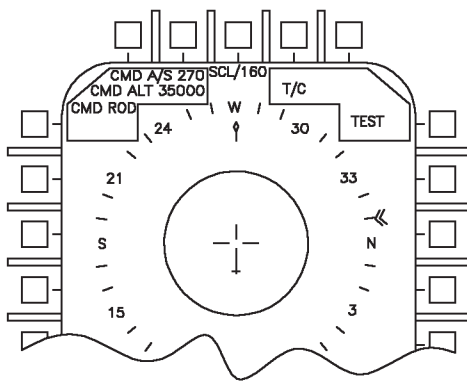

At ② the test is complete and link 4 display shows ACL 1 onboard capability as well as total loop T/C capability. The pilot has coupled to the uplinked T/C command heading and has engaged the BALT altitude hold mode. The aircraft is banking to capture the uplinked command.

Figure 24-28. T/C Guidance to Marshal (Sheet 1 of 3)

② T/C COUPLED AND BALT ENGAGED (TURNING TO CAPTURE HEADING)

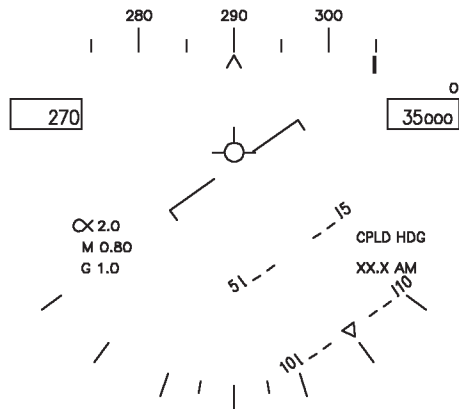
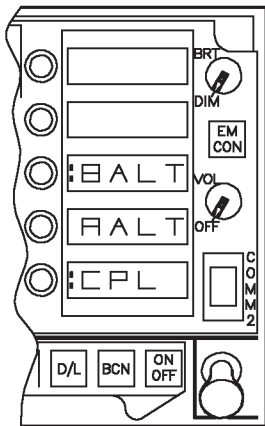
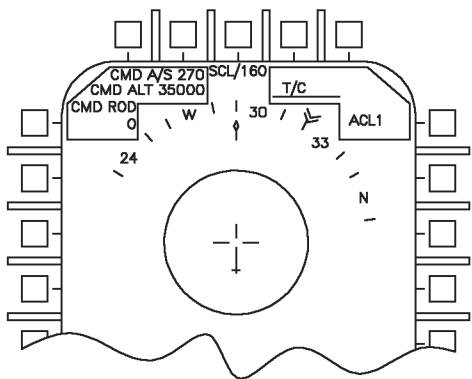

At ③ the aircraft has captured the desired T/C command heading and is holding an altitude of 35,000 feet.

③ T/C COUPLED AND BALT ENGAGED (COMMAND HEADING CAPTURED)

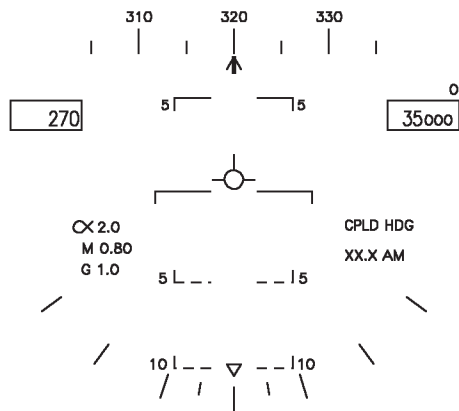
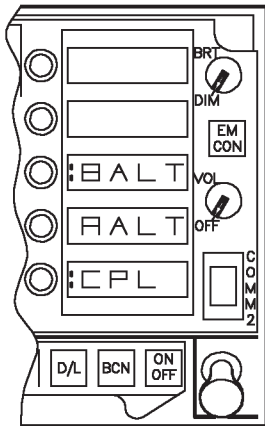
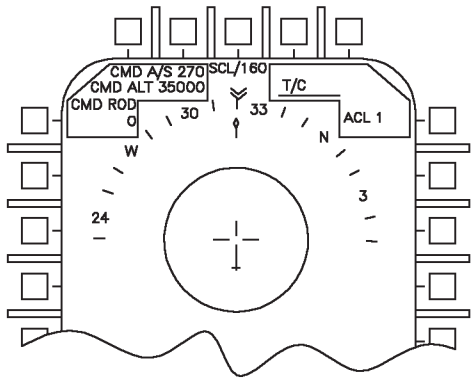

At ④ the uplinked T/C command altitude (CMD ALT) and rate of descent (CMD ROD) has just changed, as indicated by the underlines on the link 4 display. The DATA legend is flashed on the HUD for 10 seconds to inform the pilot that new information is displayed on the link 4 display. The new altitude and rate of descent commands inform the pilot to descend to 20,000 feet at a descent rate of 4,000 feet per minute.

④ T/C COUPLED AND BALT ENGAGED (CMD ALT CHANGE RECEIVED)

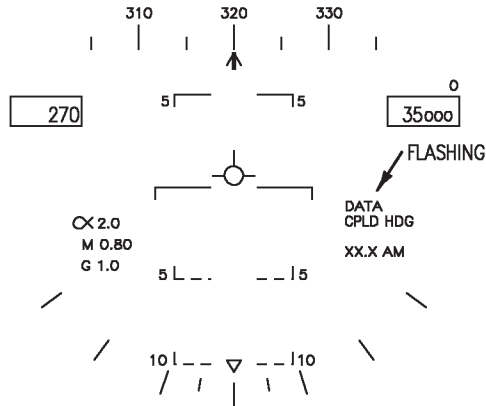
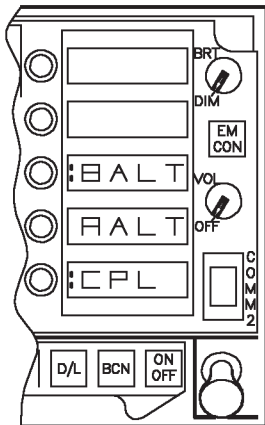
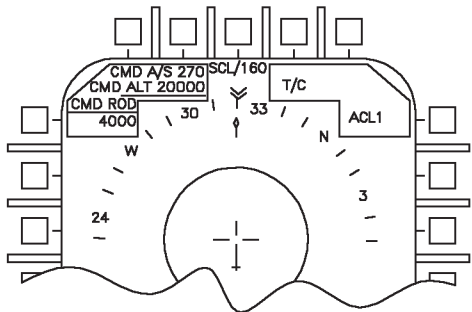
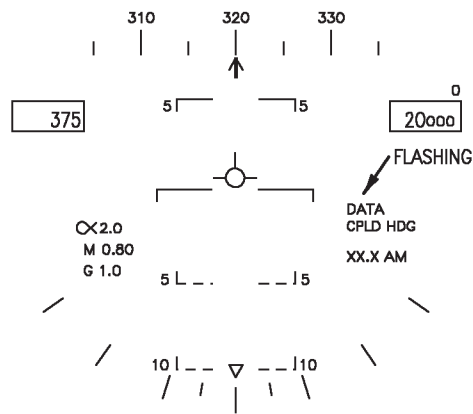
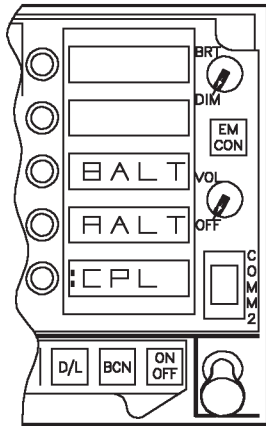
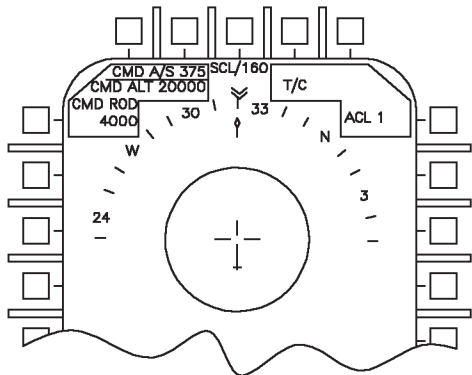

Figure 24-28. T/C Guidance to Marshal (Sheet 2 of 3)

At ⑤ the pilot has leveled off at the new altitude. A new uplinked command airspeed has also been received and the pilot has established the new airspeed which maintains 0.8 Mach at 20,000 feet as commanded. With the new altitude established, the pilot may reengage BALT hold.

⑤ T/C COUPLED AND BALT DISENGAGED (CMD A/S CHANGE RECEIVED)



At ⑥ the aircraft is set up to hold in the marshal pattern at 20,000 feet. The uplinked D/L commands have been removed from the displays due to receipt of the uplink NOT CMD. The carrier does not attempt to issue data link commands while the aircraft is holding in marshal since the uplinked command mechanization is not structured to provide aid during holding.

⑥ BALT ENGAGED-T/C UNCOUPLED (HOLDING IN MARSHAL PATTERN)

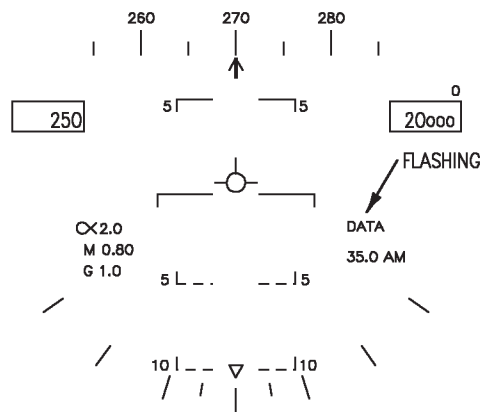
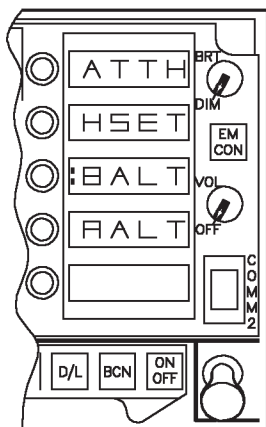
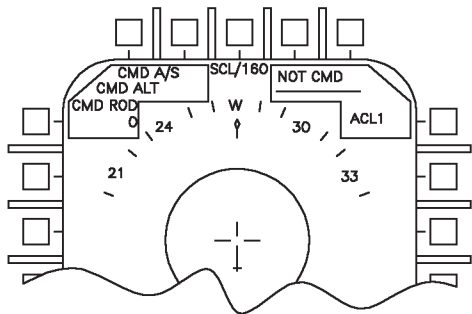

The pilot is given, via carrier control, a marshal departure time and a TACAN range and bearing window for departure at the designated time. Once on the outboard leg for marshal departures, the uplinked D/L command information (command heading, altitude, rate of descent and airspeed) may be uplinked and displayed.

Figure 24-28. T/C Guidance to Marshal (Sheet 3 of 3)

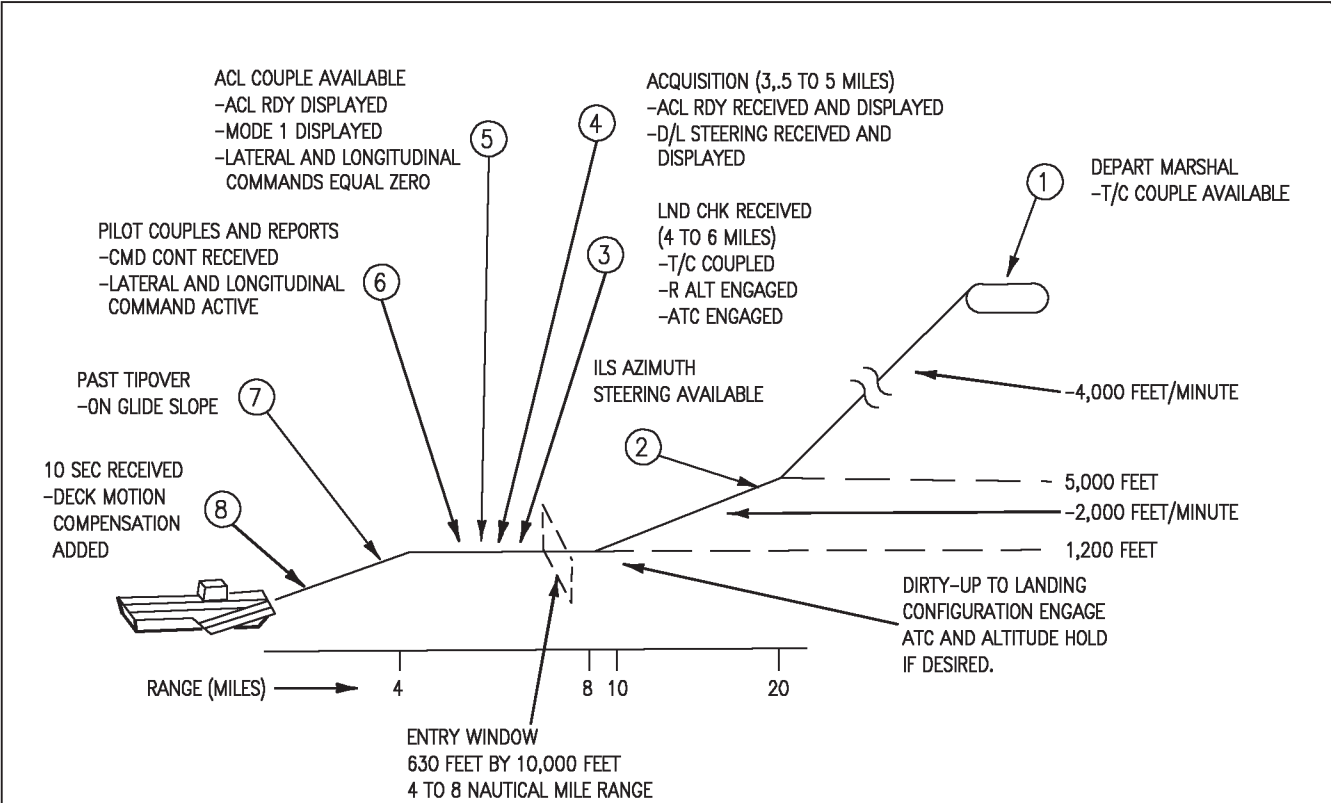

At ① the pilot started the descent to platform. The aircraft has again been coupled to unlinked T/C command heading and is banking to capture this heading. The pilot has established the desired airspeed and descent rate as commanded via uplinked commands shown on the link 4 display. The desired result of following these commands will be to arrive on platform at a 5,000-foot altitude and 20 nautical mile range, then to shallow the descent rate to 2,000 feet per minute.

① DEPARTING MARSHAL
(T/C COUPLED, BALT DISENGAGED VIA CSS OR
UFC BALT OPTION BUTTON ACTUATION)

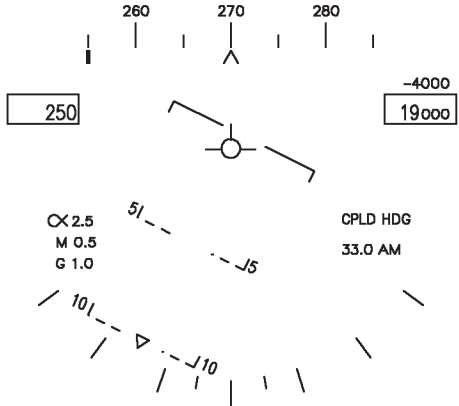
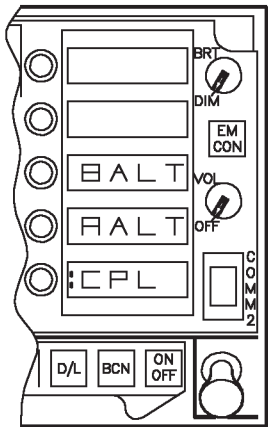
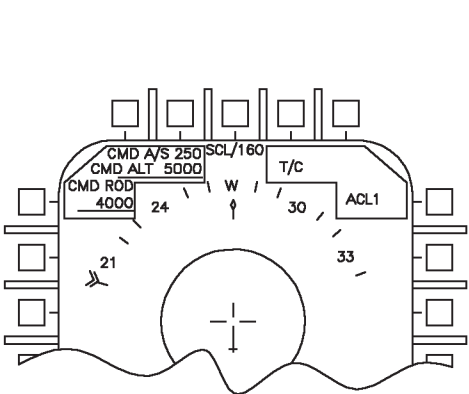
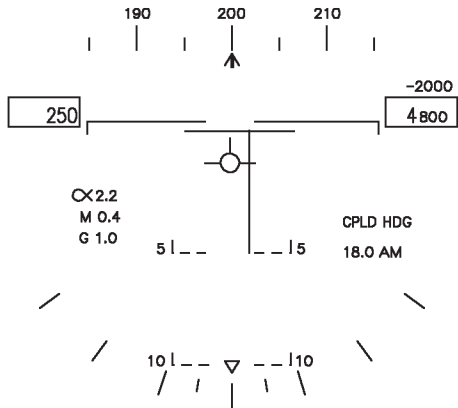
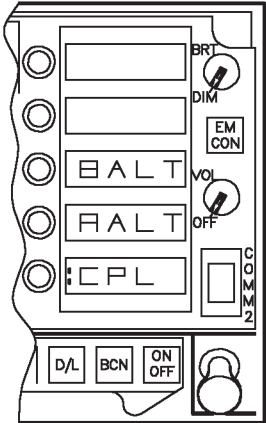
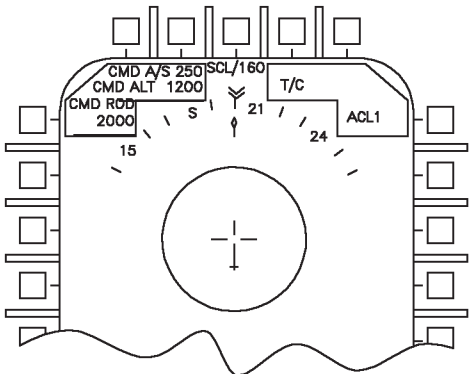

Figure 24-29. ACL Control - Marshal to Touchdown (Sheet 1 of 5)

At ② the aircraft is on platform with a descent rate of 2,000 feet per minute intended to arrive at a 1200-foot altitude at approximately 10 nautical miles. Valid ILS situation steering is available and has automatically been selected for HUD display when initially received. (The pilot may deselect the ILS steering via the HI ILS steering select button when desired.) The pilot may utilize the ILS azimuth deviation to manually capture and/or maintain the desired azimuth alignment for approach, but the glide slope ILS deviation bar should not be used until tipover, since it will be indicating fly-up.

② ILS AZIMUTH STEERING VALID



At ③ the aircraft has leveled at 1,200 feet, in the landing configuration, with auto throttle control engaged, as indicated by the ATC cue on the HUD. The underlined legend on the link 4 display shows that the uplinked LND CHK discrete has been received. This cue indicates that positive SPN-42 communication has been established as well as cuing the pilot that the aircraft should be in the landing configuration and at the approach speed. From this point in the approach, the HUD velocity vector should be caged to enhance and/or optimize the angle of attack bracket and situation steering display on the HUD.

③ LND CHK DISCRETE RECEIVED
(LANDING CONFIGURATION WITH T/C COUPLED,
RALT AND ATC ENGAGED)

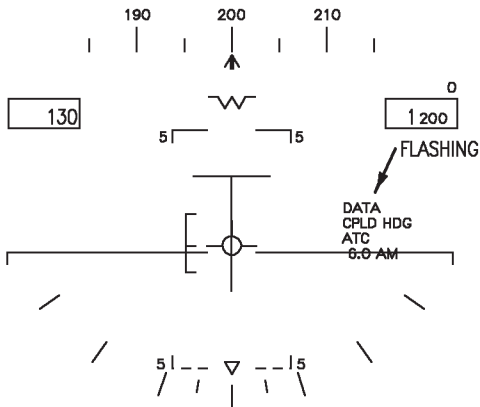
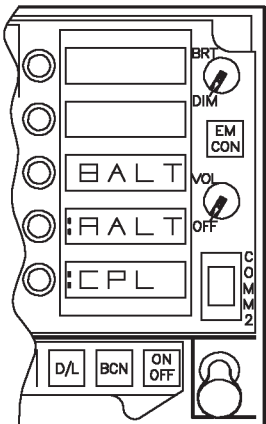
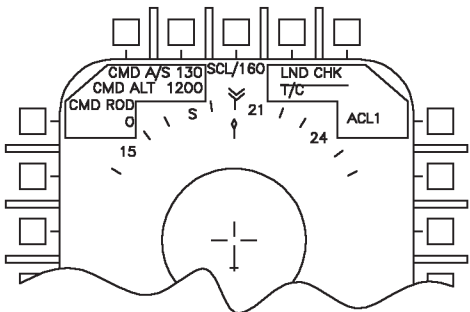
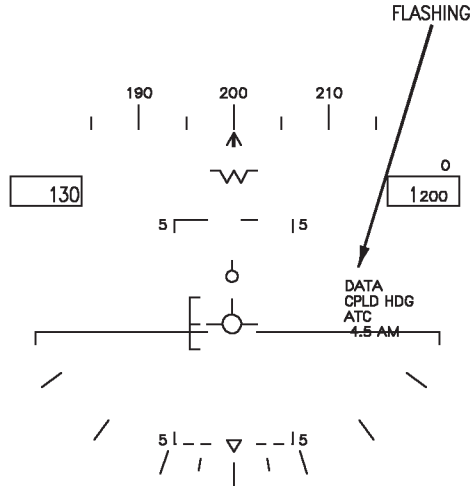
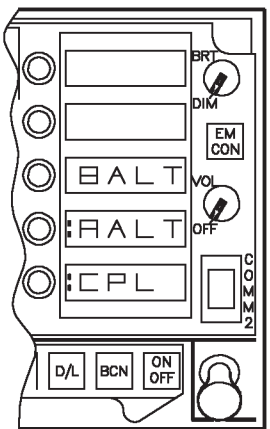
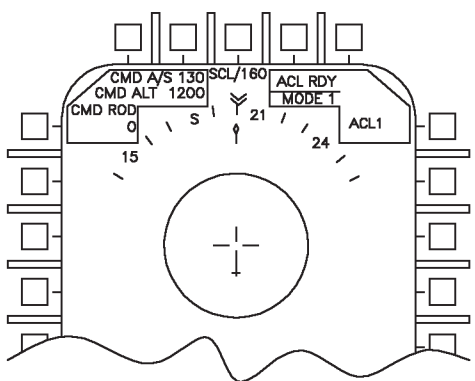

Figure 24-29. ACL Control - Marshal to Touchdown (Sheet 2 of 5)

At ④ the pilot has engaged radar altitude hold (RALT) at 1,200 feet. The uplinked ACL RDY legend indicates that the SPN-42 has acquired the aircraft and is now uplinking longitudinal and lateral commands to the aircraft equal to 0 feet per second and 0° roll attitude. The MODE 1 legend indicates that the total loop is capable of, and/or ready for, a dual-axis couple of the uplinked commands to the FCS. The FCS is still coupled to the uplinked command heading as indicated by the CPLD HDG legend displayed on the HUD. Also available is the uplinked D/L situation steering shown via the tadpole display on the HUD. The pilot has deselected the ILS steering, but may select or deselect either or both ILS and D/L situation steering to monitor coupled control progress.

④ ACQUISITION
(T/C COUPLED, ACL RDY RECEIVED, D/L STEERING AUTOMATICALLY DISPLAYED, AND PILOT HAS DESELECTED ILS STEERING)



At ⑤ the pilot has uncoupled from the uplinked T/C command heading by deselection of the CPL option on the UFC. When the aircraft is not coupled, the ACL RDY legend is displayed on the HUD. To couple the aircraft to the dual-axis uplinked longitudinal and lateral commands requires that the pilot again select the CPL option on the UFC.

⑤ ACL COUPLE AVAILABLE
(T/C UNCOUPLED BY PILOT)

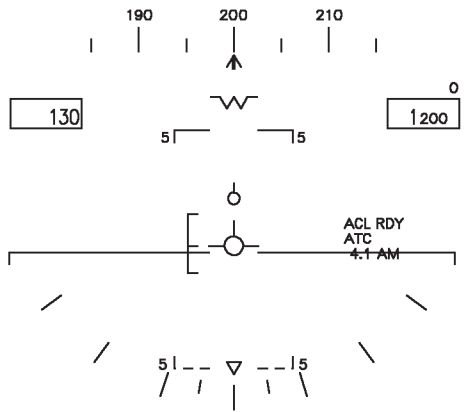
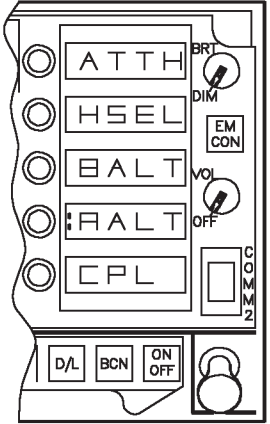
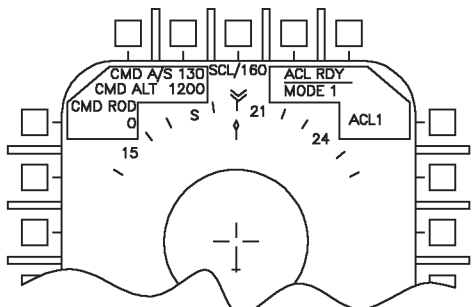
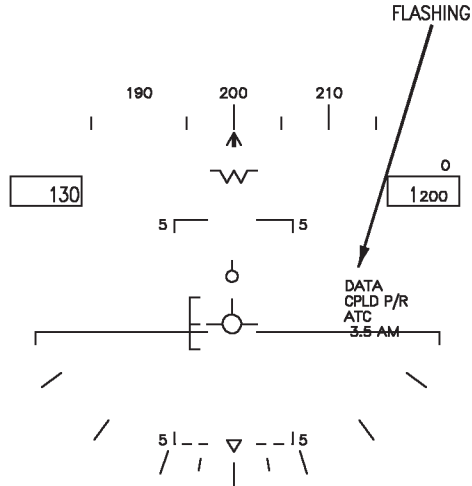
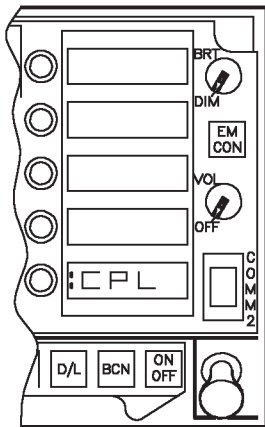
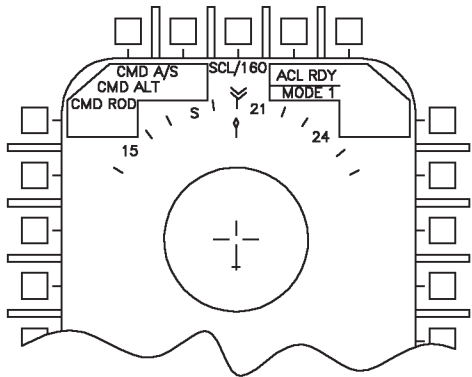

Figure 24-29. ACL Control - Marshal to Touchdown (Sheet 3 of 5)

At ⑥ the aircraft is now coupled to the uplinked dual-axis commands as indicated by the CPLD P/R legend display on the HUD. The pilot has reported couple to the carrier control via voice communication, and subsequently the aircraft has received the uplinked CMD CNTR discrete indicating that the uplinked longitudinal and lateral commands are active. The uplinked commands of heading, airspeed, altitude, and rate of descent are removed from the link 4 and HUD displays by the MC when the aircraft is coupled to the dual-axis commands as these commands are no longer updated by the carrier. The pilot will be advised via voice communication as he approaches tipover, but no aircraft control action is required on his part. (At least 30 seconds of coupled control is desirable prior to tipover.)

⑥ ACL MODE COUPLED BY PILOT
(CMD CNT RECEIVED)



At ⑦ the aircraft is past tipover on the desired glide slope and azimuth as indicated by the alignment of the D/L tadpole inside the velocity vector on the HUD.

⑦ PAST TIPOVER
(ACL MODE COUPLED, ON GLIDE SLOPE)

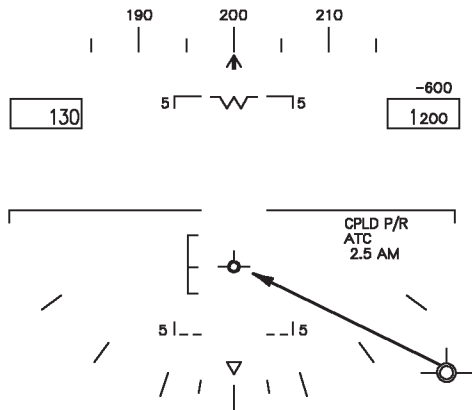
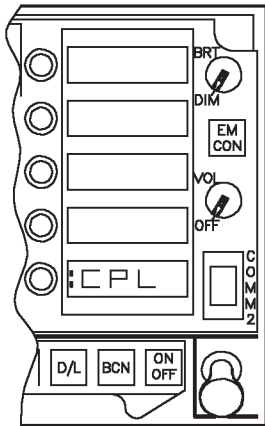
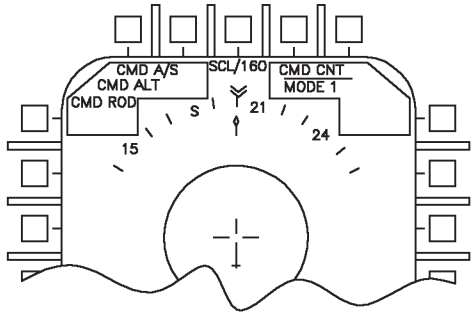
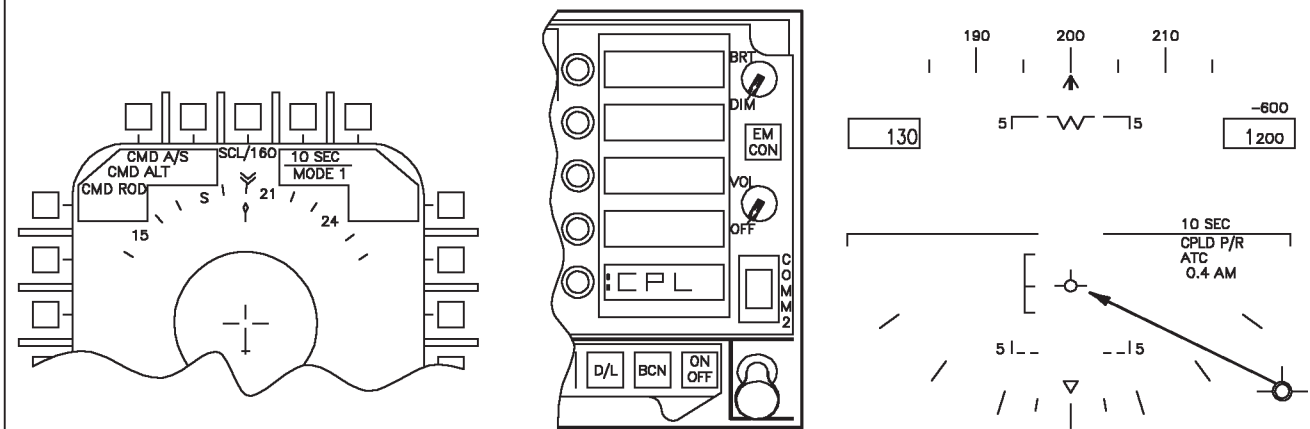

Figure 24-29. ACL Control - Marshal to Touchdown (Sheet 4 of 5)

At ⑧ approximately 12.5 seconds prior to touchdown, the uplinked 10 SEC discrete is received and displayed on both the HUD and the link 4 displays. Receipt of the 10 SEC discrete indicates that deck motion compensation is now being added to the uplinked longitudinal and lateral commands.

⑧ 10 SEC DISCRETE RECEIVED
(ACL COUPLED, ON GLIDE SLOPE)



At approximately 1.5 seconds from touchdown the uplinked longitudinal and lateral commands are frozen. At touchdown (weight on wheels), the aircraft uncouples from the uplinked commands.

18AC-NFM-00-(96-5)31-CATI

Figure 24-29. ACL Control - Marshal to Touchdown (Sheet 5 of 5)

as required may be used, dependent upon existing operational procedures and subsequent collaboration between the pilot and carrier control. Figure 24-28 shows a plan view of the approach with controls and displays for selected points prior to marshal. Figure 24-29 shows descent from marshal to touchdown. The depicted scenario uses only D/L steering and commands complemented with ILS steering in order to more clearly define D/L capability. It does not show TCN or WYPT steering which may be used in conjunction with, or independent of, D/L steering during the approach.

CHAPTER 25

Backup/Degraded Operations

25.1 MISSION COMPUTER NO. 1 FAILURE

If there is a failure of MC 1 (navigation computer), there are certain capabilities which are lost. The flight control computer is not provided with g limiter and stores information. The FCC reverts to a 7.5 g aircraft with no roll rate limiting for stores. The control of CNI equipment via the UFC is not affected by an MC 1 failure. Full Attack display and some basic Store display capability exists. MC 2 provides limited backup for the functions described below.

25.1.1 Status Monitoring Functions. MC 2 provides limited backup for status monitoring functions. MC 1, HYD 1A, HYD 1B, HYD 2A and HYD 2B cautions are available. An AUTO PILOT caution is displayed if MC 1 fails while autopilot is selected. A backup Master Caution tone is provided when voice alerts are not available. The data link advisories displayed during backup operation are TILT, W/O and 10 SEC.



Failure of MC 1 causes a loss of all DDI caution displays except AUTO PILOT, MC 1, HYD 1A, HYD 1B, HYD 2A, and HYD 2B.

25.1.2 Navigation Functions. Some basic navigation capabilities are provided by the backup functions of MC 2. Functions not available when MC 1 is failed are the autopilot functions, the HI/MPCD map and navigation situations display, EGI GPS or GPS and the HUD steering displays (except for data link). In addition, the HSI functions of selecting the position keeping source, position updating, target marking, and data entry and display are not provided when MC 1 is failed. The functions provided by MC 2 are the basic HUD flight data, a backup HSI display with INS, TACAN and ADF information, a mode II ACL capability, and automatic throttle control. ILS steering is available on the standby attitude indicator. If the INS fails when MC 1 is failed, no backup position keeping is provided. In this case the standby attitude reference indicator is used by MC 2 for attitude information and the velocity vector is not displayed on the HUD.

25.1.3 Backup HUD Display. With MC 1 failed, the backup HUD display is identical with the primary HUD display, except that the bank angle scale is not provided and the heading scale is at the same position as in the weapon delivery modes. The ghost velocity vector is provided during backup operation, and the velocity vector may be caged/uncaged. The landing HUD display and data link steering are still available. On the ground, the position of the velocity vector and the pitch ladder may be erratic. In some cases the velocity vector may be removed from the HUD.

25.1.4 Backup HSI Display. With MC 1 failed, the backup HSI display consists of a magnetic compass rose oriented heading-up with a TACAN pointer and an ADF pointer. A digital readout of TACAN bearing and distance and the station identifier are provided in the upper left corner. The INS present position is displayed inside the compass rose at the top center. Waypoint 0 position is also displayed. The ACL mode option pushbutton is also displayed for selection if desired.

25.2 BACKUP ATTITUDE AND NAVIGATION SYSTEM

If a failure occurs in the primary attitude and navigation system (INS), output signals of pitch, roll, magnetic heading, and airspeed are provided to the mission computer system for use in the backup attitude navigation computations. The backup system consists of a standby attitude reference indicator, a static power inverter, and a magnetic azimuth detector.

25.2.1 Standby Attitude Reference Indicator. The standby attitude reference indicator (figure 25-1) is a self-contained pitch and roll instrument on the main instrument panel. An electrically driven vertical gyro maintains vertical orientation by use of an electronic erection system. The erection system automatically cuts off the roll erection circuit when lateral accelerations exceed approximately 0.15 g, the pitch erection circuit remains active. The gyro spin speed and erection system provides a minimum of 3 minutes of attitude information with a total power loss. Pitch and roll synchros provide backup pitch and roll attitude for use by other systems. The attitude presentation is 360° in roll, 92° in climb, and 78° in dive.

25.2.2 Static Power Inverter. If there is an interruption or loss of aircraft ac power, 28 volt dc power is applied to the static power inverter to produce the 115 volt ac power needed for standby attitude reference indicator operation.

25.2.3 Magnetic Azimuth Detector. The magnetic azimuth detector (MAD) consists of 3 sensing elements configured in a wye. The sensing elements are mounted so that their average positions are maintained in the horizontal component of the earth's magnetic field. The air data computer processes the detected magnetic heading and develops the magnetic error compensation signals.

25.2.4 Backup Attitude and Navigation System Controls and Indicators. The controls and indicators for the backup system are on the HI/MPCD and the standby attitude reference indicator.

25.2.4.1 HI/MPCD. The HI/MPCD provides horizontal situation and steering control displays.

25.2.4.2 Standby Attitude Reference Indicator Controls and Indicators. The controls and indicators on the standby attitude reference indicator (figure 25-1) are described as follows:

1. OFF flag. This flag is in view when power is removed or the pull to cage knob is pulled out or does not properly retract.
2. Miniature airplane. This represents the nose and wings of the airplane and indicates pitch and roll attitude relative to the horizon. The miniature airplane is adjustable from +5° thru -10° of pitch trim by rotating the pull to cage knob clockwise or counterclockwise when the knob is pushed in.
3. Pull to cage knob. When the knob is pulled out and held it orients the gyro spin axis to the ARI case (pitch and roll position). When the knob is pulled out and rotated clockwise to engage detent the ARI becomes caged.



Damage to the gyro might occur if the indicator is moved rapidly in the pitch or roll axes while the gyro is spinning and caged. If the knob is in the locked position, it must be pulled out to clear the detent before it can be turned counterclockwise.

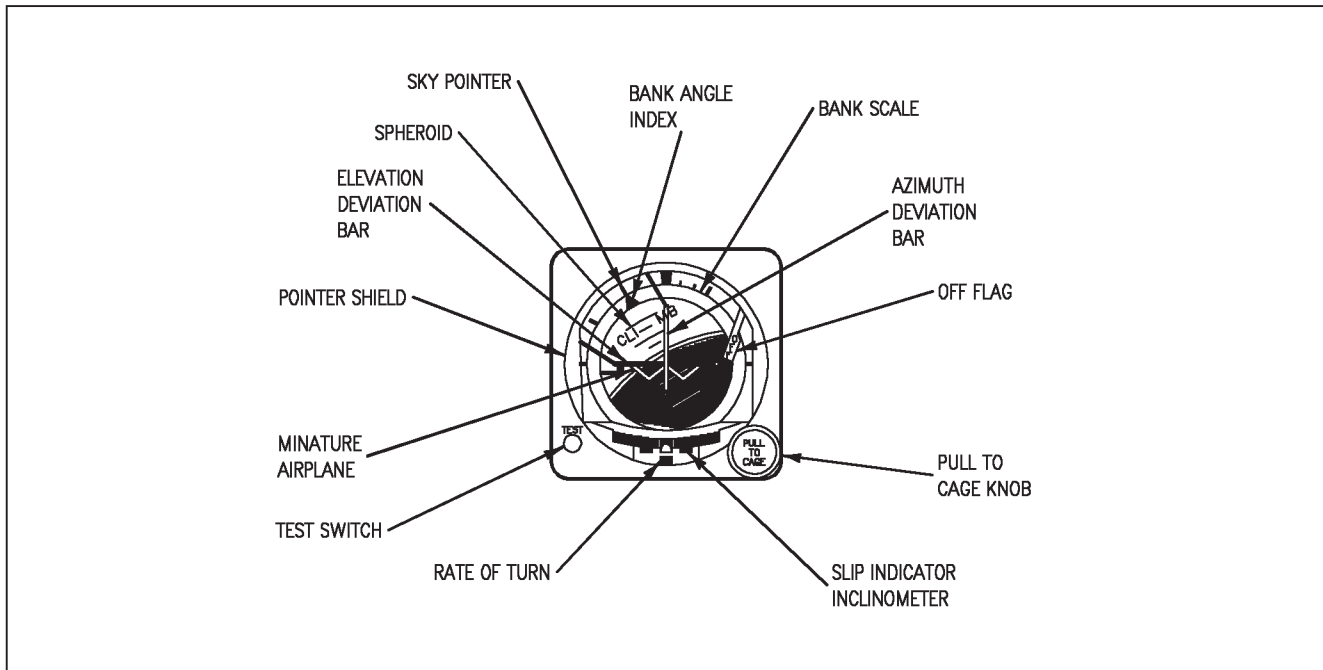

Figure 25-1. Standby Attitude Reference Indicator

18AC-NFM-00-(97-1)31-CATI

4. Slip indicator (inclinometer). This mechanical indicator displays sideslip.
5. Rate of turn needle. This needle displays the rate of turn. One needle width of deflection indicates a 90° per minute rate of turn.
6. Test switch. The test switch is pressed and the vertical and horizontal pointers position to center of the miniature airplane and the rate of turn needle deflects two needle widths.
7. Pointer shield. This shield conceals the vertical pointer when in the stowed position.
8. Elevation deviation bar. In the ACLS/ICLS mode this bar provides direction information for pitch steering.
9. Bank scale. The scale rotates with the aircraft to provide measurement of angular displacement by the bank angle index during maneuvers.
10. Azimuth deviation bar. In the ACLS/ICLS MODE this bar provides direction information for azimuth steering.
11. Sky pointer. The pointer rotates with the aircraft to indicate vertical (sky) in any roll attitude.
12. Bank angle index. The index indicates vertical in any roll attitude.
13. Display sphere. The sphere is directly coupled to the gyro gimbals to provide a direct reading of pitch and roll. The sphere is marked at each 5° in pitch.

25.3 NAVIGATION BACKUP

Position keeping for aircraft navigation requires available sources of heading information, attitude information and velocity. The INS normally provides position keeping for the aircraft. However, under

various failure conditions, alternate sources of heading, attitude and/or velocity information may be used for position keeping. The backup heading modes are discussed in a following paragraph. The attitude reference indicator is the alternate source of attitude information. The alternate sources of velocity information are GPS and air data (true airspeed and angle of attack) or radar doppler velocities. Air data vertical velocity is an alternate velocity source if only the vertical component of INS velocity is invalid. The flight control set is an alternate source for angle of attack information.

The system automatically reverts to alternate data sources under failure conditions. For example, GPS (if installed), MIDS (if installed), or air data position keeping (in that order) is automatically selected in case of an INS failure. If MIDS is installed and operating, MIDS will be automatically selected as the aircraft position keeping source when INS or GPS (if installed) fails. Because MIDS position keeping is unreliable, air data position keeping (POS/ADC) should be manually selected if POS/MIDS is displayed. During air data position keeping, true airspeed and angle of attack from the air data computer and the last computed wind, or the wind inserted by the pilot via the UFC, are used. The wind can also be updated during air data position keeping by performing a velocity update. A new wind is calculated when the velocity update is accepted. The velocity vector on the HUD is flashed at a slow rate (on for 0.8 seconds and off for 0.8 seconds) during air data position keeping. A POS/ADC caution is displayed on the DDI along with a master caution light and tone, when the INS reverts to ADC position keeping.

The radar doppler velocities are automatically used by the mission computer if they are available and no other velocity sources are available (INS, GPS and ADC failed). This applies whether or not TACAN position keeping is selected. Doppler velocities are available when the radar is operating in a doppler beam sharpened (DBS) mode or PVU mode. Thus, the MC automatically uses the doppler velocities under these conditions if a DBS mode is selected, or if velocity update is selected (without accepting or rejecting the update).

25.3.1 Navigation Controls and Indicators

25.3.1.1 HI/MPCD Display. The symbols and digital readouts that normally appear on the HI/MPCD during backup system operation are the same as in the INS operation except for the POS OPTION DISPLAY description.

25.3.1.2 POS Option Display. Pressing the POS/ADC pushbutton on the HSI display commands the mission computer system to use air data computer true air speed, MAD heading, wind speed, and direction to compute aircraft latitude and longitude in waypoint steering computation.

25.3.2 Backup Heading Mode Control. If the INS computer should fail or if the INS switch is rotated to the GYRO position, the ASN-130 INS reverts to the attitude heading reference system (AHRS) mode and true heading is no longer available from the INS. In this case, the mission computer slaves the INS platform heading with the MAD to provide damped magnetic heading. The slaving of the INS platform to the MAD occurs in straight and level flight. During maneuvers, when roll is greater than $\pm 5^\circ$ or pitch is greater than $\pm 10^\circ$, the MAD output is not used. Upon reversion to the Slaved heading mode, the bottom row of option selections on the HSI are HDG/SLV, SYNC, and ERECT. The sync option can be used to quickly synchronize the heading with the MAD output if a heading error exists. The MC automatically synchronizes the heading with the MAD output when the heading error is greater than 11.25° during level flight. Pressing the ERECT option commands the INS to increase the gains in the INS erection loops, thus fast-leveling the platform. SYNC and ERECT are momentary options and they should be used only in straight and level flight. Backup heading is not available with the ASN-139 and EGI.

If it is desired to change the backup heading mode, the heading status option pushbutton should be pressed (HDG/SLV in this case) and the available heading options (SLV, DG, and COMP) are presented on the HSI. Selecting any of these three options commands the MC to display the selected option and necessary controls for that option. In the case of failure conditions, the next best available source is automatically selected.

Selection of the DG heading mode or failure of the MAD while in the HDG/SLV mode, causes the bottom pushbuttons on the HI/MPCD to display HDG/DG, HDG (arrow left), HDG (arrow right), and ERECT. The MC computes aircraft heading using the INS platform heading as a smoothed heading source compensating for wander angle (the difference between true north and platform heading) and earth rate. The pilot may correct the aircraft heading by using the two HDG slew option buttons. Following the initial setting of the heading, the MC provides heading compensation for earth rate. However, changes in magnetic variation must be entered via the upfront control since the aircraft uses the last known value of magnetic variation.

If the pilot selects the Compass heading mode, if the INS is turned off, or if the INS fails completely, the mission computer uses the MAD output, damped with body rate data from the flight control system. During maneuvers, when roll is greater than $\pm 5^\circ$ or pitch is greater than $\pm 10^\circ$, the flight control system body rates, alone, are used to determine heading. In the compass heading (HDG/COMP) mode, the bottom buttons are labeled HDG/COMP and ERECT. The ERECT option is displayed only when the ASN-130 INS is still operating in the AHRS mode. The MC uses the last known magnetic variation to compute true heading.

25.4 BACKUP FREQUENCY CONTROL

Backup frequency control for the radios in case of an upfront control or communication system control (CSC) malfunction is provided via the multiplex bus and a DDI display. The UFC backup (UFC BU) display can be selected from the menu. Both Comm 1 and Comm 2 can be controlled from the UFC BU display. When the COM1 or COM2 button is pressed, the frequency on which that radio is operating is displayed below the legend COM1 or COM2, as appropriate. A new frequency is selected by first selecting OVRD and then using the numerical buttons along the sides of the display and ENT button at the bottom. With MC OFP 10A AND UP, four digit frequencies can be entered. Four digits limit the frequency resolution to 100KHz. With MC OFP 13C AND UP, six digit frequencies can be entered. Frequencies can be entered to 5 KHz of resolution. As the new frequency is entered, it is displayed in the scratch pad above the COM1 or COM2 legend. When the ENT button is pressed, the frequency displayed in the scratchpad is stored in the mission computer as the preset frequency for the radio. Pressing the CLR button clears the scratchpad if an error is made when entering a backup frequency. When OVRD option in the upper right corner of the display is selected, it is boxed and the radio operates on the preset frequency stored for it in the mission computer, overriding the normal frequency control from the UFC and CSC. When OVRD is deselected, frequency control reverts to the upfront control. The frequency displayed below the COM1 or COM2 legend is always the frequency on which the radio is operating, whether or not OVRD is selected. Upon power up with WOW, the preset frequencies stored in the mission computer for COM1 and COM2 are initialized to be the same as the last valid radio operating frequencies.

If the radio is operating in AJ mode, AJ is displayed in place of the frequency display. If the radio is operating in AJ when OVRD is selected, the radio automatically tunes to the new frequency and exits AJ mode.

CHAPTER 26

Visual Communications

Communications between aircraft are visual whenever possible. Flight leaders shall ensure that all pilots in the formation receive and acknowledge signals when given. The visual communications chapters of NAVAIR 00-80T-113 should be reviewed and practiced by all pilots. Common visual signals applicable to flight operations are listed in figure 26-1.

GENERAL SIGNALS

SIGNAL		MEANING	RESPONSE
DAY	NIGHT		
Thumbs up, or nod of head.	Flashlight moved vertically up-and-down repeatedly.	Affirmative. (“Yes”, or, “I understand.”)	
Thumbs down, or turn of head from side to side.	Flashlight moved horizontally back-and-forth repeatedly.	Negative. (“No”, or, “I do not understand.”)	
Hand cupped behind ear as if listening.		Question. Used in conjunction with another signal, this gesture indicates that the signal is interrogatory.	As appropriate.
Hand held up, with palm outward.		Wait	
Hand waved back and forth in an erasing motion in front of face, with palm turned forward.	Letter N in code, given by external lights.	Ignore my last signal.	
Employ fingers held vertically to indicate desired numeral 1 through 5. With fingers horizontal, indicate number which added to 5 gives desired number from 6 to 9. A clenched fist indicates 0. (Hold hand near canopy when signaling.)		Numerals as indicated.	A nod of the head (“I understand”). To verify numerals, addressee repeats. If originator nods, interpretation is correct. If originator repeats numerals, addressee should continue to verify them until they are understood.

Figure 26-1. Visual Communications (Sheet 1 of 9)

GENERAL SIGNALS (CONT)

SIGNAL		MEANING	RESPONSE
DAY	NIGHT		
Make hand into cup-shape, then make repeated pouring motions.		I am going to dump fuel.	
Slashing motion of index finger across throat.		I have stopped dumping fuel.	

MALFUNCTIONING EQUIPMENT (HEFOE CODE)

SIGNAL		MEANING	RESPONSE
DAY	NIGHT		
Weeping signal and then indicating by finger - numbers 1 to 6 the affected system.	Flashlight held close to top of canopy, pointed toward wingman, followed by 1 to 6 dashes to indicate system affected.	Number of fingers or dashes means: 1. Hydraulic 2. Electric 3. Fuel 4. Oxygen 5. Engine 6. FCS	Day: Nod, or thumbs up. ("I understand.") Night: Vertical movement of flashlight. Pass lead to disabled plane or assume lead, if indicated.

Figure 26-1. Visual Communications (Sheet 2 of 9)

TAKEOFF, CHANGING LEAD, LEAVING FORMATION, BREAKUP, LANDING

SIGNAL		MEANING	RESPONSE
DAY	NIGHT		
<p>1. Section/Division Lead gives thumbs up.</p> <p>2. Wingman gives thumbs up.</p> <p>3. Section/Division Lead kisses off wingman.</p>	<p>1. Section/Division Lead turns formation lights off.</p> <p>2. Wingman turns formation lights off. 2a. Wingman turns formation lights on.</p> <p>3. Section/Division Lead turns formation lights on.</p>	<p>1. I am ready to take position on the runway.</p> <p>2. I am ready to take position on the runway. 2a. I am ready for takeoff roll.</p> <p>3. I am executing takeoff roll.</p>	<p>1. Standby for response from wingman.</p> <p>2. Lead calls for take-off. 2a. Section/Division Lead formation lights on.</p> <p>3. Wingman roll in order.</p>
<p>1. Leader pats self on the head, points to wingman.</p>	<p>1. Lead aircraft turns strobe lights ON.</p> <p>2. If external lights are inoperative, leader shines flashlight on hard-hat, then shines light on wingman.</p>	<p>Leader shifting lead to wingman.</p>	<p>1. Wingman pats head and assumes lead.</p> <p>2. Wingman turns strobe lights OFF and assumes lead.</p> <p>If external lights are inop-</p> <p>3. Wingman shines flashlight at leader, then on his hard hat and assumes lead.</p>
<p>Leader pats self on head and holds up two or more fingers.</p>		<p>Leader shifting lead to division designated by numerals.</p>	<p>Wingman relays signal; division leader designated assumes lead.</p>
<p>Pilot blows kiss to leader.</p>		<p>I am leaving formation.</p>	<p>Leader nods (“I understand”) or waves goodbye.</p>
<p>Leader blows kiss and points to aircraft.</p>		<p>Aircraft pointed out leave formation.</p>	<p>Wingman indicated blows kiss and executes.</p>
<p>Leader points to wingman, then points to eye, then to vessel or object.</p>		<p>Directs plane to investigate object or vessel.</p>	<p>Wingman indicated blows kiss and executes.</p>

Figure 26-1. Visual Communications (Sheet 3 of 9)

TAKEOFF, CHANGING LEAD, LEAVING FORMATION, BREAKUP, LANDING (CONT)

SIGNAL		MEANING	RESPONSE
DAY	NIGHT		
Division leader holds up and rotates two fingers in horizontal circle, preparatory to breaking off.		Section breakoff.	Wingman relays signal to section leader. Section leader nods (“I understand”) or waves goodbye and executes.
Leader describes horizontal circle with forefinger.	Series of “I’s” in code, given by external lights.	Breakup (and rendezvous).	Wingman take lead, pass signal after leader breaks and follow.
Landing motion with open hand: 1. Followed by patting head. 2. Followed by pointing to another aircraft.		Refers to landing of aircraft, generally used in conjunction with another signal. 1. I am landing. 2. Directs indicated aircraft to land.	1. Nods. (“I understand”) or waves goodbye. 2. Aircraft indicated repeats signal, blows a kiss and executes.
Open hand held vertically and moved forward or backward, palm in direction of movement.		Adjust wing position forward or aft.	Wingman moves in direction indicated.
Open hand held horizontally and moved slowly up or down, palm in direction of movement.		Adjust wing position up or down.	Wingman moves up or down as indicated.
Open hand used as if beckoning inboard or pushing outboard.		Adjust wing position laterally toward or away from leader.	Wingman moves in direction indicated.
Hand opened flat and palm down, simulating dive or climb.		I am going to dive or climb.	Prepare to execute.
Hand moved horizontally above glare shield, palm down.		Leveling off.	Prepare to execute.

Figure 26-1. Visual Communications (Sheet 4 of 9)

TAKEOFF, CHANGING LEAD, LEAVING FORMATION, BREAKUP, LANDING (CONT)

SIGNAL		MEANING	RESPONSE
DAY	NIGHT		
Two fingers pointed toward eyes (meaning IFF/SIF signals), followed by: 1. CUT 2. 3-digit numerals		1. Turn IFF/SIF to "STANDBY". 2. Set mode and code indicated: first numeral-mode, second and third numerals-code.	Repeat then execute.
Head moved backward.		Slow down.	Execute.
Head moved forward.		Speed up.	Execute.
Headed nodded right or left.		I am turning right or left.	Prepare to execute.
Thumb waved backward over shoulder.	Series of 00s in code, given by external lights.	Take cruising formation or open up.	Execute.
1. Holds up right (or left) forearm vertically, with clenched fist or single wing-dip. 2. Same as above, except with pumping motion or double wing-dip.	1. Single letter R (or K) in code, given by external lights. 2. Series of RRs (or KKs) in code, given by external lights.	1. Wingman cross under to right (or left) echelon or in direction of wing-dips. 2. Section cross under to right (or left) echelon or in direction of wing-dips.	1. Execute. 2. Execute.
Triple wing-dip.	Series of VVs in code, given by external lights.	Division cross under. Form a Vee or balanced formation.	Execute. Execute.
Series of zooms.	Series of XXs in code, given by external lights.	Close up or join up; join up on me.	Execute.
Rocking of wings by leader.		Prepare to attack.	Execute preparation to attack.
Rocking of wings by any other member of flight.		We are being, or are about to be, attacked.	Stand by for and execute defensive maneuvers.

Figure 26-1. Visual Communications (Sheet 5 of 9)

TAKEOFF, CHANGING LEAD, LEAVING FORMATION, BREAKUP, LANDING (CONT)

SIGNAL		MEANING	RESPONSE
DAY	NIGHT		
Lead plane swishes tail.		All aircraft in this formation form step-down column in tactical order behind column leader.	Execute. Leader speeds up slightly to facilitate formation of column.
Shaking of ailerons. Head raised then lowered.	Long dash, given with external lights.	Execute signal; used as required in conjunction with another signal.	Execute last signal given.
Open and close four fingers and thumb.	Three dashes with external lights.	Extend or retract speed brake as appropriate.	Repeat signal. Execute upon head nod from leader or when leader's speed brake extends/retracts.
Rotary movement of clenched fist in cockpit as if cranking wheels, followed by head nod.	Two dashes with external lights.	Lower or raise landing gear and flaps, as appropriate.	Repeat signal. Execute when leader changes configuration.
Pointing index finger toward runway/ship in stabbing motion, repeatedly, followed by lead change signal.	One dash with external lights.	Landing runway or ball and ship in sight.	Ashore: Take position for landing. Carrier: Breakoff and land.
Raised fist with thumb extended in drinking position.		How much fuel have you?	Repeat signal, then indicate fuel in hundreds of pounds by finger-numbers.
Leader lowers hook.	Letter H in code, given by external lights.	Lower arresting hook.	Wingman lower arresting hook. Leader indicates wingman's hook is down with thumbs-up signal.
Open hand held up, fingers together, moved in fore-and-aft chopping motion (by leader).		Course to be steered is present compass heading.	Nod of head ("I understand").

Figure 26-1. Visual Communications (Sheet 6 of 9)

ELECTRONIC COMMUNICATIONS AND NAVIGATION

SIGNAL		MEANING	RESPONSE
DAY	NIGHT		
Tap earphones, followed by patting of head, and point to other aircraft.		Take over communications.	Repeat signals, pointing to self, and assume communications lead.
Tap earphones, followed by patting of head.		I have taken over communications.	Nod ("I understand").
Tap earphones and indicate by finger-numerals, number of channel to which shifting.		Shift to channels indicated by numerals.	Repeat signal and execute.
Vertical hand, with fingers pointed ahead and moved in a horizontal sweeping motion with four fingers extended and separated.		What is bearing and distance to the TACAN station?	Wait signal, or give magnetic bearing and distance with finger-numerals. The first three numerals indicate magnetic and the last two or three, distance.

VISUAL EMERGENCY SIGNALS (AIR-TO-AIR)

SIGNAL		MEANING	RESPONSE
DAY	NIGHT		
Arms bent across forehead weeping.	Horizontal motion of flashlight shone at other aircraft.	General emergency signal meaning, I am in trouble.	Carry out squadron doctrine for escort of disabled aircraft.
Landing motion with open hand.	Circular motion of flashlight shone at other aircraft.	I must land immediately.	Assume lead if indicated and return to base or nearest suitable field.
Point to pilot and give series of thumbs down movements.	Flash series of dots with exterior lights.	Are you having difficulty?	Thumbs up: I am all right. Thumbs down: I am having trouble. Lights off once then on steady: I am all right. Lights flashing: I am having trouble.

Figure 26-1. Visual Communications (Sheet 7 of 9)

ARMAMENT

SIGNAL		MEANING	RESPONSE
DAY	NIGHT		
<p>1. Pistol-cocking motion with either hand.</p> <p>2. Followed by question-signal.</p> <p>3. Followed by thumbs-down signal.</p>		<p>1. Ready or safety guns.</p> <p>2. How much ammo do you have?</p> <p>3. I am unable to fire.</p>	<p>1. Repeat signal and execute.</p> <p>2. Thumbs up -“over half”; thumbs down -“less than half.”</p> <p>3. Nod head (“I understand”).</p>
<p>1. Shaking fist.</p> <p>2. Followed by question-signal.</p> <p>3. Followed by thumbs-down signal.</p>		<p>1. Arm or safety bombs, as applicable.</p> <p>2. How many bombs do I have?</p> <p>3. I am unable to drop.</p>	<p>1. Repeat signal and execute.</p> <p>2. Indicate with appropriate finger-numerals.</p> <p>3. Nod head (“I understand”).</p>
<p>1. Shaking hand, with fingers extended downward.</p> <p>2. Followed by question-signal.</p> <p>3. Followed by thumbs-down signal.</p>		<p>1. Arm or safety missile/rockets as applicable.</p> <p>2. How many missiles/rockets do I have?</p> <p>3. I am unable to fire.</p>	<p>1. Repeat signal and execute.</p> <p>2. Indicate with appropriate finger-numerals.</p> <p>3. Nod head (“I understand”).</p>
<p>Pistol cocking motion with either hand, followed by fore and aft pulling motion with a clenched fist.</p>	<p>1. Strobe light ON and OFF by lead aircraft.</p> <p>2. Strobe light turned ON for second time (allow time for setting up switches).</p>	<p>Jettison external stores.</p> <p>1. Set up your switches for jettison.</p> <p>2. You are cleared to drop.</p>	<p>Repeat signal and execute.</p> <p>1. Set up jettison/ordnance switches.</p> <p>2. Execute.</p>

Figure 26-1. Visual Communications (Sheet 8 of 9)

AIR REFUELING

SIGNAL		MEANING	RESPONSE
DAY	NIGHT		
<p>One finger turn-up signal.</p> <p>Form cone-shape with hand, all fingers extended aft (make signal close to canopy).</p> <p>1. Cone moved aft</p> <p>2. Cone moved forward</p>		<p>By receiver: start turbine.</p> <p>1. By receiver: extend drogue.</p> <p>2. By receiver: retract.</p>	<p>Tanker execute. Receiver gives thumbs-up when turbine starts.</p> <p>Tanker execute. Receiver give thumbs-up if:</p> <p>1. Drogue extends properly.</p> <p>2. Drogue retracts fully and air turbine feathers.</p>
<p>Make hand into cup-shape, then make repeated pouring motions.</p>		<p>By tanker: I am going to dump fuel.</p>	<p>By receiver: Nod. Give thumbs-up when fuel dumping commences.</p>
<p>Slashing motion of index finger across throat.</p>		<p>By tanker: I have stopped dumping fuel.</p>	<p>By receiver: Give thumbs-up if fuel dumping has ceased.</p>

Figure 26-1. Visual Communications (Sheet 9 of 9)

CHAPTER 27

Deck/Ground Handling Signals

Communications between aircraft and ground personnel are visual whenever practical, operations permitting. The visual communications chapters of Aircraft Signals NATOPS Manual (NAVAIR 00-80T-113) should be reviewed and practiced by all flightcrew and ground crew personnel. For ease of reference, visual signals applicable to deck/ground handling are listed in Figure 27-1. During night operations, wands shall be substituted for hand and finger movements.

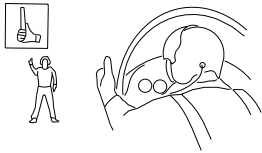

ACKNOWLEDGEMENT

A CLENCHED FIST WITH THUMB POINTING STRAIGHT UP INDICATES SATISFACTORY COMPLETION OF A CHECK ITEM. A CLENCHED FIST WITH THUMB POINTING STRAIGHT DOWN INDICATES UNSATISFACTORY COMPLETION AND/OR DO NOT CONTINUE.

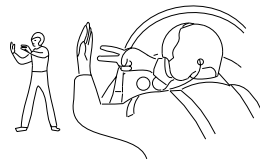

INSERT/PULL ELECTRICAL POWER

PILOT INSERTS/PULLS INDEX AND MIDDLE FINGER TO/FROM OPEN PALM. SIGNALMAN RESPONDS WITH SAME SIGNAL.

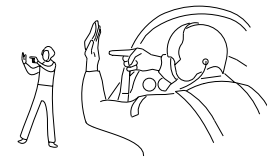

INSERT/PULL EXTERNAL AIR

PILOT INSERTS/PULLS INDEX FINGER TO/FROM OPEN PALM. SIGNALMAN RESPONDS WITH SAME SIGNAL.

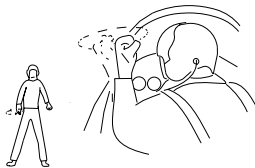

FCS IBIT/FCS EXERCISER/ FLIGHT CONTROLS WIPEOUT

PILOT MOVES CLENCHED FIST IN CIRCULAR MOTION IN VIEW OF SIGNALMAN.

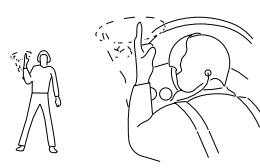

START APU/ENGINE

PILOT EXTENDS FINGERS TO INDICATE APU OR ENGINE IS READY FOR START. IF ALL CLEAR, SIGNALMAN RESPONDS WITH SIMILAR GESTURE POINTING AT APU EXHAUST OR PROPER ENGINE WHILE ROTATING OTHER HAND IN CLOCKWISE MOTION

- 3 FINGERS - APU
- 2 FINGERS - RIGHT ENGINE
- 1 FINGER - LEFT ENGINE

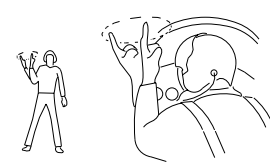

ENGINE RUN-UP

PILOT MOVES INDEX FINGER IN CIRCULAR MOTION INDICATING HE IS READY TO RUN UP ENGINE. SIGNALMAN RESPONDS WITH SIMILAR SIGNAL WHEN ALL CLEAR.



CHECK NOSE WHEELWELL DDI

PILOT MAKES T WITH HANDS AND POINTS TO NOSE.

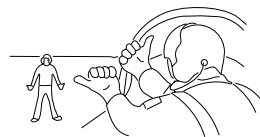

PULL CHOCKS

PILOT MAKES SWEEPING MOTION OF FISTS WITH THUMBS EXTENDED OUTWARD. SIGNALMAN SWEEPS FISTS APART AT HIP LEVEL WITH THUMBS EXTENDED OUTWARD.



AM I CLEAR UNDERNEATH

WITH LEFT HAND OPEN, PALM OUT, PILOT MAKES SWEEPING MOTION ACROSS COCKPIT FROM RIGHT TO LEFT.

Figure 27-1. Deck Ground Handling Signals (Sheet 1 of 4)

<p>FOLD WINGS ARMS, FROM STRAIGHT OUT SWEEPED IN TO HUG SHOULDER.</p>	<p>WING LOCK EXTEND ARM TO SIDE, LEVEL WITH SHOULDER BEND ARM UPWARD, AND SLAP ELBOW.</p>	<p>SPREAD WINGS ARMS IN HUGGING POSITION, THEN SWEEPED OUT TO SIDES.</p>	<p>LOWER LAUNCH BAR/TOW LINK REST RIGHT ELBOW IN LEFT PALM AT WAIST LEVEL. BRING RIGHT HAND DOWN TO HORIZONTAL POSITION. NIGHT: SAME EXCEPT WITH WANDS.</p>	<p>RAISE LAUNCH BAR/TOW LINK REST RIGHT ELBOW IN LEFT PALM AT WAIST LEVEL. WITH RIGHT FOREARM HORIZONTAL. BRING RIGHT HAND UP TO SHOULDER LEVEL. NIGHT: SAME AS DAY EXCEPT REST RIGHT ELBOW ON WAND.</p>
<p>AIR REFUELING PROBE ARM ACROSS CHEST, FIST CLENCHED. EXTEND ARM HORIZONTALLY TO THE SIDE POSITION. USE LEFT ARM FOR AIR REFUELING PROBE AND RIGHT ARM FOR RAT. REVERSE THE PROCEDURE FOR RETRACT.</p>	<p>SPEED BRAKE EXTEND ARMS AT WAIST WITH PALMS TOGETHER. KEEP WRISTS TOGETHER AND OPEN PALMS.</p>	<p>HOOK UP RIGHT THUMB JERKED UP TO MEET HORIZONTAL LEFT HAND.</p>	<p>HOOK DOWN LOWER RIGHT FIST SUDDENLY, THUMB EXTENDED DOWNWARD, TO MEET HORIZONTAL PALM OF LEFT HAND HELD IN FRONT OF BODY.</p>	
<p>STICK AFT LEADING EDGE DOWN</p>	<p>STICK FWD LEADING EDGE UP</p>	<p>FCS IBIT/FCS EXERCISER/ FLIGHT CONTROL WIPEOUT</p>	<p>LEFT RUDDER IN RUDDER SWINGS LEFT</p>	<p>RIGHT RUDDER IN RUDDER SWINGS RIGHT</p>
<p>LEFT STICK RIGHT AILERON DOWN</p>	<p>AILERON CHECK NEUTRAL STICK AILERON UP</p>	<p>RIGHT STICK LEFT AILERON DOWN</p>	<p>NOSE GEAR STEERING RIGHT INDEX FINGER POINTING TO RIGHT SIDE OF NOSE FOR RIGHT TURN AND VICE VERSA FOR LEFT TURN; OPPOSITE HAND POINTING TO NOSE GEAR.</p>	<p>EXTERIOR LIGHTS HOLD THE INDEX AND MIDDLE FINGER IN A "V" SIGNAL POINTING TOWARDS THE EYES.</p>

Figure 27-1. Deck Ground Handling Signals (Sheet 2 of 4)



COME AHEAD

HANDS AT EYE LEVEL, EXECUTE MOTION: RATE OF MOTIONS INDICATES DESIRED SPEED OF AIRCRAFT. FOR NIGHT OPERATION, WAVE WANDS SIDE TO SIDE.



RIGHT TURN

PULL DESIRED WING AROUND WITH REGULAR "COME AHEAD". POINT AT OPPOSITE BRAKE.



LEFT TURN

PULL DESIRED WING AROUND WITH REGULAR "COME AHEAD". POINT AT OPPOSITE BRAKE.

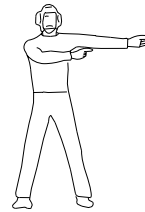

TURNOVER OF COMMAND

BOTH HANDS POINTED AT NEXT SUCCEEDING TAXI SIGNALMAN.



SLOW DOWN

DOWNWARD PATTING MOTION, HANDS OUT AT WAIST LEVEL



STOP

ARMS UPRAISED, FISTS CLENCHED AND HELD IN SIMPLE "POLICEMEN'S STOP".



EMERGENCY STOP

ARMS CROSSED ABOVE HEAD FISTS CLENCHED.



HOT BRAKES

MAKE RAPID FANNING MOTION WITH ONE HAND IN FRONT OF THE FACE. POINT TO WHEEL WITH OTHER HAND.



ENGINE FIRE

DESCRIBE A LARGE FIGURE EIGHT WITH ONE HAND AND POINT TO THE FIRE AREA WITH THE OTHER HAND.



CUT ENGINE

HAND DRAWN ACROSS NECK IN "THROAT CUTTING" MOTION.

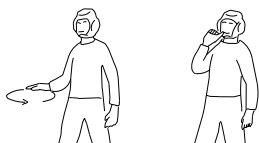

GROUND REFUELING ALL TANKS, NO EXTERNAL POWER
CIRCULAR MOTION PARALLEL TO THE HORIZON WITH ONE HAND EXTENDED FOLLOWED BY A DRINKING MOTION (THUMB TO MOUTH).

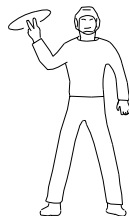

FINAL READY
TWO FINGERS IN CIRCULAR MOTION

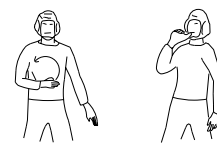

GROUND REFUELING INTERNAL TANKS NO EXTERNAL POWER
CIRCULAR MOTION WITH THE PALM OF HAND TOWARD STOMACH (AS RUBBING STOMACH) FOLLOWED BY A DRINKING MOTION (THUMB TO MOUTH).

Figure 27-1. Deck Ground Handling Signals (Sheet 3 of 4)

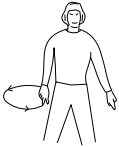

START APU

POINTS TO APU EXHAUST WITH LEFT HAND
INDEX FINGER: MOVES RIGHT HAND IN
HORIZONTAL CIRCLE, INDEX AND MIDDLE
FINGER POINTED DOWN.
NIGHT: SAME AS DAY EXCEPT WITH WANDS.
MAKES THROAT CUTTING SIGNAL WITH LEFT
HAND WHILE RIGHT HAND MAKES APU SIGNAL
TO SHUT DOWN APU.



FLAPS FULL

HANDS FLAT TOGETHER, THEN
OPENED WIDE FROM WRISTS.
ARMS IN CLOSE TO BODY.

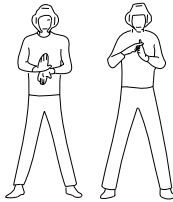

FLAPS HALF

FLAPS FULL SIGNAL FOLLOWED
BY CROSSED INDEX FINGERS.



FLAPS AUTO

HANDS, OPENED, WIDE FROM
WRIST, SUDDENLY CLOSED,
ARMS IN CLOSE TO BODY.

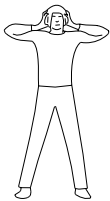

GROUND INTERCOM

CUP HANDS OVER EARS OR
POINT WANDS TO EARS.



SET TAKEOFF TRIM

RAISE AND LOWER
FULLY EXTENDED ARM



**AOA PROBE/PITOT
PROBE HEAT CHECK**

RUN FINGERS OF ONE HAND
OVER TWO EXTENDED FINGERS
OF THE OTHER HAND IN A
PULLING MOTION



FINAL CHECK

DOWNWARD BRUSHING MOTION
OF THE CHEST WITH BOTH
HANDS FOLLOWED BY HANDS
OUT OF COCKPIT SIGNAL

NIGHT SIGNALS

NIGHT SIGNALS ARE THE SAME AS DAY SIGNALS EXCEPT AS NOTED,
FLASHLIGHTS OR WANDS WILL SUBSTITUTE FOR HAND AND FINGER
MOVEMENTS DURING NIGHT OPERATIONS.

DECK PERSONNEL COLOR CODING

REFER TO CV NATOPS MANUAL

Figure 27-1. Deck Ground Handling Signals (Sheet 4 of 4)

PART VIII

WEAPONS SYSTEMS

For F/A-18A-D safety-of-flight information, general stores and components, and unclassified ballistic stores and weapons, see NTRP 3-22.4-FA18A-D.

For F/A-18A-D classified ballistic weapons, A/G guided weapons, A/A combat weapons and data, other stores, radar systems, EW, EO/IR, reconnaissance, CNI, MSI, and tactical training systems, see NTRP 3-22.2-FA18A-D.

PART IX

FLIGHT CREW COORDINATION

Chapter 28 - General

CHAPTER 28

Crew Resource Management

28.1 DEFINITION

Crew resource management is the use and integration of all available skills and resources to collectively achieve and maintain flight efficiency, situational awareness, and mission effectiveness.

Effective crew coordination is essential for aircraft employment; however F/A-18 crew coordination differs from previous crew served tactical aircraft in that “who does what when” is determined by the mission and mission phase and not by where equipment controls are located in the cockpit. The most successful crews are those who have flown together extensively and know each other’s areas of responsibility before manning the aircraft. The mission commander is responsible for mission success. The pilot as the aircraft commander is solely responsible for the safe control of the aircraft throughout the entire mission. Crewmembers/WSOs assist the pilot as necessary and should anticipate developments. The responsibility for every evolution is a shared responsibility. Crew coordination provides a system of checks and balances which, properly utilized, ensure effective and efficient mission accomplishment.

28.2 CRITICAL SKILLS OF CREW RESOURCE MANAGEMENT

28.2.1 Decision Making. Effective decision making refers to the ability to use logical and sound judgement to make decisions based on available information. This includes assessing the problem, verifying information, identifying solutions, anticipating the consequences of decisions, informing others of the decision and rationale, and evaluating these decisions. Good decisions optimize risk management and minimize errors, while poor decisions can increase them and is a leading cause of failure to complete missions and of mishaps.

28.2.2 Assertiveness. Assertiveness refers to the ability, willingness, and readiness to take action. This involves making decisions, demonstrating initiative and the courage to act, and stating and maintaining a position until convinced otherwise by the facts. Each flight member must be willing to act assertively if they are going to fulfil their responsibility toward mission success.

28.2.3 Mission Analysis. Mission effectiveness relies on the aircrew’s ability to coordinate, allocate, and monitor flight and aircraft resources. Mission analysis includes organizing and planning for what will occur during the mission, monitoring the current situation, and reviewing and providing feedback on what has occurred. Failure to develop a good plan, or to revise a plan when the situation changes, can result in a failed mission or a mishap.

28.2.4 Communication. Effective aircrew communication skills ensure timely transfer and assimilation of accurate information and provide useful feedback. Open professional communication that avoids defensiveness and encourages accurate understanding of the intended message is critical to the information flow in the flight. Aviators should be aware of the basic sociological, psychological, and environmental barriers to communication and attempt to overcome them.

28.2.5 Leadership. Leadership is the ability to direct and coordinate the activities of the mission and to stimulate the flight to work together as a team. The ultimate responsibility for safety of flight rests with the aircraft commander/pilot in command. Every crewmember however has the responsibility

toward safety of flight, compliance with NATOPS and SOPs, and mission accomplishment. Within the chain of command each crewmember must exercise vigilance and support the aircraft commander with timely recommendations and back up as directed.

28.2.6 Adaptability/Flexibility. The ability to alter one's course of action, another's action and/or situational demands demonstrates good adaptability/flexibility. The critical aspects of being adaptable are anticipating problems, recognizing and acknowledging any changes or abnormalities, taking alternative actions, providing and asking for assistance, and interacting constructively with flight members. The success of a mission depends on the ability to alter behavior and dramatically manage flight resources to meet situational demands.

28.2.7 Situational Awareness. Situational awareness is the accurate comprehension of all factors affecting the aircraft. It is the ability to identify the source and nature of problems, extract and interpret essential information, maintain an accurate perception of the external environment, and detect a situation requiring action. Mission accomplishment depends on the level of situational awareness of all members of the flight and outside agencies.

28.2.8 Factors That Degrade Crew Resource Management

1. Fixation on one task to the detriment of others.
2. Confusion.
3. Violation of NATOPS/FLIGHT minimums.
4. Violations of SOP.
5. No one in charge.
6. No lookout doctrine.
7. Failure to meet mission/planning milestones.
8. Absence of communications.

28.3 FLIGHT MEMBER POSITIONS

28.3.1 Mission Commander. The mission commander shall be a qualified naval aviator or naval flight officer designated by appropriate authority. The mission commander shall be responsible for all phases of the assigned mission except those aspects of safety of flight which are related to the physical control of aircraft and fall within the prerogatives of the pilot in command. In accomplishing this, the mission commander may exercise command over a single naval aircraft or formations of naval aircraft. The mission commander shall direct a coordinated plan of action and be responsible for effectiveness of the mission. The mission commander's responsibilities include, but are not limited to:

1. Allocation of assets.
2. Supervise and allocate planning tasks.
3. Assess capabilities and limitations of the flight.
4. Establish go/no-go criteria.

5. Assign roles and responsibilities.
6. Ensure compliance with applicable orders, directives and ROE/ROC.
7. Delegate authority as required.

28.3.2 Pilot In Command. The pilot in command is the pilot of an individual aircraft. The pilot in command is responsible for the safe, orderly flight of the aircraft and well-being of the crew. In the absence of direct orders from higher authority cognizant of the mission, responsibility for starting or continuing a mission with respect to weather or any other condition affecting the safety of the aircraft rests with the pilot in command. The pilot in command may also be mission commander or formation leader when so designated.

28.3.3 Formation Leader. A formation of two or more Naval aircraft shall be under the direction of a formation leader who is authorized to pilot Naval aircraft. The formation leader is responsible for the safe and orderly conduct of the formation. The status of each member of the formation shall be clearly briefed and understood prior to takeoff. The formation leader may also be the mission commander when so designated.

28.3.4 Crew Member. Personnel whose presence is required on board an aircraft to perform crew functions in support of the assigned mission (i.e. copilot, bombardier/navigator, weapons and sensors officer, air observer, special crew, trainee, etc.).

28.3.5 Weapons and Sensors Officer. The Weapons and Sensors Officer (WSO) is directly involved in all operations and weapons systems employment of the F/A-18 aircraft except actual control of the aircraft. The WSO integrates with the pilot to collectively achieve and maintain crew efficiency, situational awareness, and mission effectiveness. When designated as mission commander, the WSO is also responsible for all phases of the assigned mission, except those aspects of safety of flight which are related to the actual physical control of the aircraft and fall within the prerogatives of the pilot in command.

28.4 AIRCREW RESPONSIBILITIES BY FLIGHT PHASE

28.4.1 Mission Planning and Briefing. All members of the flight should be involved in the mission planning process and must be familiar with the mission requirements prior to the flight brief.

The flight brief shall be conducted with all members of the flight present. Any supporting assets (GCI, fighter escort, EW, etc.) shall be briefed face-to-face if possible. Flights requiring special coordination or control should also be briefed face-to-face. Each type of flight or phase of flight may require unique briefing requirements.

28.4.2 Pretakeoff. AOB review, preflight, prestart and poststart evolutions are conducted individually or jointly, for dual crewmember flights, with the aid of ground maintenance crews (plane captains, trouble shooters, ordnance, etc.) Timing must be considered when coordinating operations with other activities. Marshalling and taxi with a flight should be in order with special emphasis on FOD avoidance. A minimum taxi interval should be emphasized for FOD considerations. During section taxi the wingman cannot focus on other tasks or allow himself to get behind.

A challenge/reply acknowledgment is required in dual crewmember aircraft prior to canopy repositioning and during the accomplishment of takeoff/landing checklist procedures. The use of HOTMIKE should be considered during ground/flight phases where immediate action is required.

28.4.3 Takeoff/Departure. The following should also be considered and briefed when conducting a formation takeoff in addition to the typical takeoff considerations such as gross weight, performance, and abort capability:

- interval for FOD avoidance
- staggered line-up for abort
- cross wind handling characteristics
- jet exhaust/turbulence patterns
- abort criteria and configuration changes prior to IMC
- wingman position
- airspeed
- runway
- abort

Departure procedures are dependent upon weather and mission requirements.

The following are some considerations that may require crew coordination:

- clearance compliance
- climb schedule and interval of multiplane formations
- weather avoidance or penetration
- individual departure to join on top.

28.4.4 Enroute. Enroute procedures may differ greatly depending on mission requirements. Some task assignment and execution considerations are:

- navigation (INS management)
- specific sensor usage (i.e. radar, TFLIR)
- communications
- lookout
- transition TO/FROM NVG equipment usage
- weapon employment programming

“Who does what to what when” should be in sufficient detail as to preclude redundant and possibly negative effort.

28.4.5 Recovery. Egress, approach and landing options are numerous and dependent upon mission objectives, weather, and types of landing. The following elements should be considered and may require crew resource management: navigation and communication systems management, course rules, re-entry procedures, approach and landing weather, landing type and capabilities (i.e. gross weight, crosswind limitations, aircraft configuration), fuel for normal and alternate recoveries, formation size and composition based upon maneuverability and landing area congestion, instrument recovery/penetration procedures (single aircraft and/or formation), power and maneuvering margins for wingmen, jet wash and turbulence avoidance, terminal control/LSO procedures, landing interval and priorities, FOD avoidance during landing and taxi, and dearming procedures.

28.4.6 Mission Critique. Mission assessment is critical following a flight whether the mission was a multi-aircraft strike, an FCLP period, or a functional check flight. A critical and credible debrief of mission effectiveness improves future mission success and enhances aircrew and supporting agency coordination. A proper debrief should provide flight members and supporting agencies with information on strengths and weaknesses so that future training and mission planning can focus on problem areas and exploit strong areas.

28.5 SPECIAL CONSIDERATIONS

28.5.1 Functional Checkflights. All requirements for functional checkflights are listed in COMNAVAIRFORINST 4790.2 series and are to be performed using the applicable functional check flight checklist. Crew coordination shall be in accordance with standard NATOPS procedures and apply during the entire checkflight. F/A-18 NATOPS chapter 10 outlines additional checks to establish acceptance standards for the systems peculiar to the F/A-18 aircraft. All instrument and indicator readings, warning lights, and radar and navigation displays in the aft cockpit will be compared throughout the flight with the corresponding information available from the front cockpit. Close crew coordination ensures proper and correct utilization of all functional check flight procedures. Only those pilots and aircrew/WSOs designated in writing by the squadron commanding officer shall perform squadron functional checkflights.

28.5.2 Formation Flights. Formation flights involving two or more aircraft require a high degree of crew coordination to ensure mission accomplishment and to reduce the mid air collision potential to a minimum. During all missions involving formation flights in either VFR or IFR weather, the aircrew/WSO should aid in the operation of the aircraft radar, sensors, and weapons system. The pilot should be able to devote primary attention to flying the aircraft and maintaining sight of all other aircraft in the flight.

28.5.3 Air Combat Maneuvering (ACM). Delineating the entire realm of aircrew responsibility during ACM is beyond the scope of this manual. Careful preplanning and briefing are necessary to ensure adequate crew coordination prior to any ACM mission. As a minimum, each flight member must have a constant awareness of the rules of engagement, flight safety, fuel state (including bingo), attitude, and minimum prebriefed base altitude and carry on a continuous supportive commentary.

28.6 EMERGENCIES

Mission planning and briefing should address contingencies which may affect the flight. Proper planning minimizes the effect of deviations from the planned mission. The possibility of a mission abort or even the loss of an aircraft or aircrew can be significantly reduced by anticipating critical phases of flight and preparing for potential emergency situations. An example is the thorough brief of bird strike emergencies and divert fields along a low-level navigation route.

Part V contains procedures to correct an abnormal or emergency condition. Modify these procedures as required in case of multiple emergencies, adverse weather, or other peculiar factors. Use common sense and sound judgement to determine the correct course of action.

In dual crewmember aircraft, crew resource management is vital in an emergency situation. A plan should be discussed as to each crewmember's actions during an emergency, i.e., the pilot controls aircraft and performs immediate action procedures, the crew member handles communication and confirms immediate action and follow on emergency procedures from the PCL are completed. A plan for both controlled and uncontrolled ejection should be discussed such as ejection selection handle setting, ejection warning voice calls, who initiates ejection, etc. Ground egress procedures should also be coordinated to preclude the ejection of an unstrapped crewmember and to deconflict egress routes.

PART X

NATOPS EVALUATION

Chapter 29 - NATOPS Evaluation

CHAPTER 29

NATOPS Evaluation

29.1 CONCEPT

The standard operating procedures prescribed in this manual represent the optimum method of operating the F/A-18 aircraft. The NATOPS Evaluation is intended to evaluate compliance with NATOPS procedures by observing and grading individuals and units. This evaluation is tailored for compatibility with various operational commitments and missions of both Navy and Marine Corps units. The prime objective of the NATOPS Evaluation program is to assist the unit commanding officer in improving unit readiness and safety through constructive comment. Maximum benefit from the NATOPS Program is achieved only through the vigorous support of the program by commanding officers as well as pilots.

29.1.1 Implementation. The NATOPS Evaluation program shall be carried out in every unit operating naval aircraft. Pilots desiring to attain/retain qualification in the F/A-18 shall be evaluated initially in accordance with OPNAVINST 3710.7 series, and at least once during the twelve months following initial and subsequent evaluations. Individual and unit NATOPS Evaluations will be conducted annually; however, instruction in and observation of adherence to NATOPS procedures must be on a daily basis within each unit to obtain maximum benefits from the program. The NATOPS Coordinators, Evaluators, and Instructors shall administer the program as outlined in OPNAVINST 3710.7 series. Evaluatees who receive a grade of Unqualified on a ground or flight evaluation shall be allowed 30 days in which to complete a reevaluation. A maximum of 60 days may elapse between the date the initial ground evaluation was commenced and the date the flight evaluation is satisfactorily completed.

29.1.2 Definitions. The following terms, used throughout this section, are defined as to their specific meaning within the NATOPS program.

29.1.2.1 NATOPS Evaluation. A periodic evaluation of individual pilot standardization consisting of an open book examination, a closed book examination, an oral examination, and a flight evaluation.

29.1.2.2 NATOPS Reevaluation. A partial NATOPS Evaluation administered to a pilot who has been placed in an Unqualified status by receiving an Unqualified grade for any of his ground examinations or the flight evaluations. Only those areas in which an unsatisfactory level was noted need be observed during a reevaluation.

29.1.2.3 Qualified. Well standardized; evaluatee demonstrated highly professional knowledge of and compliance with NATOPS standards and procedures; momentary deviations from or minor omission in non-critical areas are permitted if prompt and timely remedial action is initiated by the evaluatee.

29.1.2.4 Conditionally Qualified. Satisfactorily standardized; one or more significant deviations from NATOPS standards and procedures, but no errors in critical areas and no errors jeopardizing mission accomplishment or flight safety.

29.1.2.5 Unqualified. Not acceptably standardized; evaluatee fails to meet minimum standards regarding knowledge of and/or ability to apply NATOPS procedures, one or more significant

deviations from NATOPS standards and procedures which could jeopardize mission accomplishment or flight safety.

29.1.2.6 Area. A routine of preflight, flight or postflight.

29.1.2.7 Sub-area. A performance sub-division within an area, which is observed and evaluated during an evaluation flight.

29.1.2.8 Critical Area/Sub-area. Any area or sub-area which covers items of significant importance to the overall mission requirements, the marginal performance of which would jeopardize safe conduct of the flight.

29.1.2.9 Emergency. An aircraft component, system failure, or condition which requires instantaneous recognition, analysis, and proper action.

29.1.2.10 Malfunction. An aircraft component or system failure or condition which requires recognition and analysis, but which permits more deliberate action than that required for an emergency.

29.2 GROUND EVALUATION

29.2.1 General. Prior to commencing the flight evaluation, an evaluatee must achieve a minimum grade of Qualified on the open book and closed book examinations. The oral examination is also part of the ground evaluation but may be conducted as part of the flight evaluation. To assure a degree of standardization between units, the NATOPS instructors may use the bank of questions contained in this section in preparing portions of the written examinations.

29.2.1.1 Open Book Examination. The open book examination shall consist of, but not be limited to, the question bank. The purpose of the open book examination portion of the written examination is to evaluate the pilot's knowledge of appropriate publications and the aircraft.

29.2.1.2 Closed Book Examination. The closed book examination may be taken from, but not limited to, the question bank and shall include questions concerning normal/emergency procedures and aircraft limitations. Questions designated critical are so marked.

29.2.1.3 Oral Examination. The questions may be taken from this manual and drawn from the experience of the Instructor/Evaluator. Such questions should be direct and positive and should in no way be opinionated.

29.2.1.4 OFT/WST Procedures Evaluation. An OFT may be used to assist in measuring the pilot's efficiency in the execution of normal operating procedures and his reaction to emergencies and malfunctions. In areas not served by an OFT, this may be done by placing the pilot in an aircraft and administering appropriate questions.

29.2.1.5 NAMT Systems Check. If desired by the individual squadron, Naval Air Maintenance Trainer facilities may be utilized to evaluate pilot knowledge of aircraft systems and normal and emergency procedures.

29.2.1.6 Grading Instructions. Examination grades shall be computed on a 4.0 scale and converted to an adjective grade of Qualified or Unqualified.

29.2.1.6.1 Open Book Examination. To obtain a grade of Qualified, an evaluatee must obtain a minimum score of 3.5.

29.2.1.6.2 Closed Book Examination. To obtain a grade of Qualified, an evaluatee must obtain a minimum score of 3.3.

29.2.1.6.3 Oral Examination and OFT Procedure Check (If Conducted). A grade of Qualified or Unqualified shall be assigned by the Instructor/Evaluator.

29.3 FLIGHT EVALUATION

The flight evaluation should be conducted in an OFT but may be conducted on any routine syllabus flight with the exception of flights launched for FCLP/CARQUAL training. Emergencies will not be simulated unless flight is accomplished in a F/A-18B/D with a qualified IP in the rear seat.

The number of flights required to complete the flight evaluation should be kept to a minimum; normally one flight. The areas and sub-areas to be observed and graded on a flight evaluation are outlined in the grading criteria with critical areas marked by an asterisk (*). Sub-area grades will be assigned in accordance with the grading criteria. These sub-areas shall be combined to arrive at the overall grade for the flight. Area grades, if desired, shall also be determined in this manner.

The areas and sub-areas in which pilots may be observed and graded for adherence to standardized operating procedures are outlined in the following paragraphs.

NOTE

- If desired, units with training missions may expand the flight evaluation to include evaluation of standardized training methods and techniques.
- The IFR portions of the Flight Evaluation shall be in accordance with the procedures outlined in the NATOPS Instrument Flight Manual.

29.3.1 Mission Planning/Briefing

1. Flight Planning.
2. Briefing.
3. Personal Flying Equipment (*)

29.3.2 Preflight/Line Operations. Inasmuch as preflight/line operations procedures are graded in detail during the ground evaluation, only those areas observed on the flight check will be graded.

1. Aircraft Acceptance
2. Start
3. Before Taxiing Procedures

29.3.3 Taxi**29.3.4 Takeoff (*)**

1. ATC Clearance
2. Takeoff

29.3.5 Climb/Cruise

1. Departure
2. Climb and Level-Off
3. Procedures Enroute

29.3.6 Approach/Landing (*)

1. Tacan, GCA, ILS/ACLS, Radar, ADF
2. Landing

29.3.7 Communications

1. R/T Procedures
2. Visual Signals
3. IFF Procedures

29.3.8 Emergency/Malfunction Procedures (*). In this area, the pilot will be evaluated only in the case of actual emergencies, unless evaluation is conducted in the OFT/WST or TF/A-18.

29.3.9 Post Flight Procedures

1. Taxi
2. Shutdown
3. Inspection and Records
4. Flight Debriefing

29.3.10 Mission Evaluation. This area includes missions covered in the NATOPS Flight Manual, F/A-18 Tactical Manual, and NWP NWIPs for which standardized procedures/techniques have been deployed.

29.3.11 Applicable Publications. The NATOPS Flight Manual contains the standard operations criteria for F/A-18 aircraft. Publications relating to environmental procedures peculiar to shorebased and shipboard operations and tactical missions are F/A-18 Tactical Manual, NWPs, NWIPs, ATC/CATCC Manual, Local Air Operations Manual, and Ship Air Operations Manual.

29.3.12 Flight Evaluation Grading Criteria. Only those sub-areas provided or required will be graded. The grades assigned for a sub-area shall be determined by comparing the degree of adherence to standard operating procedures with adjectival ratings listed below. Momentary deviations from standard operating procedures should not be considered as unqualifying provided such deviations do not jeopardize flight safety and the evaluatee applies prompt corrective action.

29.3.13 Flight Evaluation Grade Determination. The following procedure shall be used in determining the flight evaluation grade: A grade of Unqualified in any critical area/sub-area will result in an overall grade of Unqualified for the flight. Otherwise, flight evaluation (or area) grades shall be determined by assigning the following numerical equivalents to the adjective grade for each sub-area. Only the numerals 0, 2 or 4 are to be assigned in sub-area. No interpolation is allowed.

Unqualified	0.0
Conditionally qualified	2.0
Qualified	4.0

To determine the numerical grade for each area and the overall grade for the flight, add all the points assigned to the sub-areas and divide this sum by the number of sub-areas graded. The adjective grade shall then be determined on the basis of the following scale.

0.0 to 2.19 - Unqualified
 2.2 to 2.99 - Conditionally Qualified
 3.0 to 4.0 - Qualified

EXAMPLE: (Add Sub-area numerical equivalents) $(4+2+4+2+4) \div 5 = 3.20$ Qualified

29.3.13.1 Final Grade Determination. The final NATOPS evaluation grade shall be the same as the grade assigned to the flight evaluation. An evaluatee who receives an Unqualified on any ground examination or the flight evaluation shall be placed in an Unqualified status until he achieves a grade of Conditionally Qualified or Qualified on a reevaluation.

29.3.13.2 Records and Reports. A NATOPS Evaluation Report (OPNAV Form 3510-8) shall be completed for each evaluation and forwarded to the evaluatee's commanding officer only. This report shall be permanently filed in the individual NATOPS Flight Personnel Training/Qualification jacket.

29.3.13.3 Critique. The critique is the terminal point in the NATOPS evaluation and is given by the Evaluator/Instructor administering the check. Preparation for the critique involves processing, reconstructing data collected, and oral presentation of the NATOPS Evaluation Report. Deviations from standard operating procedures will be covered in detail using all collected data and worksheets as a guide. Upon completion of the critique, the pilot will receive the completed copy of the NATOPS Evaluation Report for certification and signature. The completed NATOPS Evaluation Report is then presented to the Unit Commanding Officer.

29.3.13.4 NATOPS Evaluation Question Bank. The following bank of questions is intended to assist the unit NATOPS Instructor/Evaluator in the preparation of ground examinations and to provide an abbreviated study guide. The questions from the bank may be combined with locally originated questions in the preparation of ground examinations. The closed book exam shall consist of no less than 50 questions. The time limit for the closed book exam is 1 hour and 30 minutes. The requirements for the open book exam are the same as those for the closed book exam, except there is no time limit.

29.4 NATOPS EVALUATION QUESTION BANK

1. What is military thrust of the F404-GE-400/402 engine?
2. What is afterburner thrust of the F404- GE-400/402 engine?
3. When will you get engine ignition?
 - a.
 - b.
 - c.
 - d.
4. When will you get afterburner ignition?
 - a.
 - b.
5. How is a limited amount of fuel provided for negative G or inverted flight?
6. True/False: The F/A-18's IDLE rpm is the same on the ground as inflight.
7. Which one of the following caution and advisory displays will not activate the "engine left (right)" voice alert?
 - a. L or R OVRSPD
 - b. L or R EGT HIGH
 - c. L or R BOOST LO
 - d. L or R OIL PR
8. What are the modes of operation of the automatic throttle control (ATC)?
 - a.
 - b.
9. What conditions must be met to engage the approach mode of the automatic throttle control?
 - a.
10. What conditions must be met to engage the cruise mode of the automatic throttle control?
 - a.
 - b.

11. Which fuel tanks are transfer tanks?
 - a.
 - b.
 - c.
12. Which fuel tanks are feed tanks?
 - a.
 - b.
13. What does a TANK PRESS HI caution display on the DDI indicate?
 - a. On the ground -
 - b. Inflight -
14. Normal internal fuel is transferred using
15. External fuel is transferred by
16. True/False: With external tank control switch in stop transfer and hook handle down, fuel will transfer when FUEL LO caution display comes on.
17. What two fuel valves close when an engine fire light is pressed?
 - a.
 - b.
18. List four events which individually will cause fuel dump to stop.
 - a.
 - b.
 - c.
 - d.
19. True/False: The fuel low level indicating system is completely independent of the fuel quantity indicating system.
20. What fuel state illuminates the FUEL LO light, MASTER CAUTION light, and activates fuel low voice alert?
21. True/False: There is no voice alert associated with BINGO fuel.

22. Either AMAD may be driven pneumatically through an by the APU, opposite engine bleed air, or external air.
23. Each AMAD mechanically drives a,, and
24. True/False: Operation of APU is totally automatic after the APU switch is placed ON.
25. What provides electrical power for APU ignition and start control circuits?
26. What is used to start the APU?
27. True/False: If ATS caution is on when a DDI comes on, shut down the affected engine to avoid starter damage.
28. What is the cockpit warning of a single transformer-rectifier failure?
29. What is indicated by the BATT SW light coming on in the air with the battery switch on?
30. What eight circuit breakers are located in the cockpit?
31. True/False: The exterior lights master switch must be on for operation of the position and formation lights, but not for the strobe lights.
32. What failure(s) will illuminate the emergency instrument light and the BATT SW caution light?
33. The right or HYD system 2 provides power to:.....
34. What are the primary and two backup modes of the flight control system?
 - a.
 - b.
 - c.
35. What are the primary flight controls?
36. What does pressing the T/O trim button in flight do?
37. What is the FCS reset button used for?
38. With the spin switch in NORM, when will the spin recovery mode be activated?
39. What does having the flight controls in a spin recovery mode do for you as a pilot?
40. What position are the flaps in when the flight controls are in a spin recovery mode?
 - a.
 - b.

41. On takeoff, accelerating with the FLAP switch in HALF, at what speed will the flaps begin AUTO scheduling?
42. True/False: Once EMERG has been selected on FCS COOL switch, selection of NORM will switch FCC A and right TR cooling back to avionics air.
43. Rudder toe-in is a function of FLAP switch position and ... with maximum toe-in being
44. True/False: An AIL OFF caution display indicates that the roll axis is now in the direct electrical link mode.
45. True/False: Stabilator position on the FCS status display on the DDI shows a (+) for trailing edge up (or nose up), and a (-) for trailing edge down (or nose down).
46. What occurs with gear handle UP, airspeed below 175 knots, altitude less than 7,500 feet, and rate of descent greater than 250 feet per minute?
 - a.
 - b.
47. True/False: Pressing and holding the nosewheel steering button a second time will select the high mode ($\pm 75^\circ$) and NWS HI is displayed on the HUD.
48. True/False: The hook light remains on except when the hook is up and latched.
49. Normally, what kind of power is needed to fold or spread the wings?
50. Is it normal to have L PITOT HT and R PITOT HT advisories displayed on the DDI while on the ground with pitot heat switch in AUTO?
51. What will the standby attitude indicator be powered by if the right 115 volt ac bus fails?
52. The APU fire detection/extinguishing systems operates from power, provided the switch is ON.
53. The bleed air shutoff valves are closed when the fire and bleed air test switch is placed to TEST A and TEST B positions. How do you get the valves back open?
 - a.
 - b.
54. True/False: The canopy can be jettisoned in the closed position only.
55. Why would you not pull the manual override handle in flight before ejection?
56. What conditions must be met to utilize the emergency jettison button?
 - a.
 - b.

57. The switch must be in the position to use the selective jettison system.
58. What occurs when the unlighted MASTER CAUTION light is pressed?
59. True/False: For cautions with voice alert, the master caution tone comes on after the voice alert.
60. What two ways can you stop any BIT test in progress and return the equipment to normal operation?
 - a.
 - b.
61. What two systems require additional switchology other than pressing the associated button when performing initiated BIT checks?
 - a.
 - b.
62. How much has the fuel quantity in tank 1 been reduced in the F/A-18B/D aircraft?
63. True/False: The aft cockpit does not have an internal canopy switch or an internal manual canopy handcrank.
64. True/False: There are provisions for normal landing gear extension from the rear cockpit.
65. The leg restraint lines must be buckled at all times during flight to ensure and to enhance
66. Failure to route the restraint lines properly through the garters could cause:
67. True/False: High gain nosewheel steering should be used on takeoff roll up to 50 knots.
68. On a section takeoff, turns into the wingman will not be made at altitudes less than feet AGL.
69. True/False: The second section may commence the takeoff roll after the first section has rolled 1,000 feet.
70. True/False: Before descent it is necessary to preheat the windshield by increasing defog airflow.
71. True/False: For optimum braking above 40 knots, with anti-skid, full brake pressure should be used.
72. True/False: Ensure anti-skid is OFF for all shipboard operations.
73. Nosewheel steering low mode (may/may not) be engaged while the launch bar is down (circle correct answer).
74. A carrier landing pattern starts with a level break at feet, on the bow of the ship.

75. True/False: The seat rocket thrusters may ignite spilled fuel or hydraulic fluid and may injure ground crew in the immediate vicinity.
76. True/False: If you must land with the launch bar extended, you should request that the field arresting gear cables be removed.
77. A time critical situation exists if you have directional control problems during takeoff. If you suspect nosewheel steering failure, the first thing you should do is:
- 1.
78. If the aircraft begins to settle after a catapult launch and the settling cannot be stopped you must
79. What are the emergency procedures if you have lost thrust on takeoff?
80. True/False: It is unlikely that a blown nose tire will FOD an engine.
81. During flight brief consideration of takeoff abort possibilities, the following items should be considered.
- a. Weight
 - b. Speed
 - c. Runway length remaining
 - d. All of the above
82. When making an arrested abort, allow time for the arresting hook to extend; as a guide, lower the hook feet before the cable.
83. If the landing gear fails to retract you should perform the following:
- a. Pull the landing gear control circuit breaker.
 - b. Cycle the gear and pull negative g's.
 - c. Put the landing gear handle down and do not cycle
 - d. Press on - its probably a false light.
84. What two methods may be used to retain both hydraulic systems if the engine core is rotating?
- a.
 - b.
85. True/False: If the right engine is being rotated with crossbleed to provide normal systems operation and fuel flow on the left engine is reduced below 2,000 pph (as during landing) the right engine hydraulic pump may not provide sufficient flow for nosewheel steering and normal brakes.

86. True/False: Most engine stalls are self clearing.
87. True/False: Engine stalls may produce audible bangs.
88. True/False: If a stalled engine will not clear, you may shut down the engine and attempt a restart.
89. What airspeed may be required to maintain 12 % windmilling rpm?
90. True/False: Engine crossbleed may not be used to achieve a 12 % rpm for engine restart.
91. With one engine windmilling below 12 %, the remaining engine should be operated at or above. . . . % rpm and PPH fuel flow to utilize the crossbleed airstart capability.
92. True/False: Hydraulic system 2A failure is the only single hydraulic system failure which requires pilot action.
93. Hydraulic system 1A does not power which of the following?
 - a. Right Aileron
 - b. Right Trailing Edge Flap
 - c. Leading Edge Flaps
 - d. Left Trailing Edge Flaps
94. True/False: With HYD 2A failure, anti-skid is available.
95. With HYD 2A failure what type of landing should be considered?
 - a. Normal landing
 - b. Formation landing
 - c. Long field arrestment
 - d. Short field arrestment if practical
96. The aircraft is uncontrollable on what single hydraulic circuit?
97. True/False: Gravity fuel flow is sufficient to sustain minimum afterburner operation.
98. True/False: You are in the spooldown restart envelope at 450 knots, 23,000 feet and N_2 50 %.
99. True/False: You are in the windmill restart envelope at Mach 0.75, 25,000 feet and 14 % N_2 .
100. True/False: A crossbleed restart is recommended at Mach 0.68 and 10,000 feet.
101. True/False: You may attempt an APU restart below 250 knots and 10,000 feet.

102. True/False: If tank 1 fails to transfer, as much as 1,100 pounds of fuel may not be usable for approach and landing.
103. True/False: One generator is insufficient to carry the total aircraft electrical load.
104. The utility and emergency batteries will provide limited dc power for approximately minutes.
105. True/False: During a dual generator failure, do not turn off any of the flight control systems in an attempt to conserve battery power.
106. Remaining battery life may be estimated as the U BATT LO light comes on when approximately percent of the total time remains (Aircraft 161353 THRU 161528).
107. If the cabin temperature knob is full clockwise with the cabin temperature switch in MAN, cockpit temperature can reach as high as °F.
108. True/False: The most probable source of visible smoke or fumes in the cockpit is from the engine bleed or residual oil in the ECS ducts.
109. True/False: With both generators inoperative and good batteries your landing gear position indicator will function normally.
110. True/False: With both generators inoperative and good batteries your hydraulic pressure indicator will be inoperative.
111. True/False: Pressing the emergency jettison button, simultaneously jettisons stores from the parent bomb racks on external stores stations 2, 3, 5, 7, and 8.
112. True/False: Weight must be off the main landing gear or landing gear handle must be up for the emergency jettison system to be operational.
113. True/False: Failure of FCS channels 1 and 3 will not affect the flying qualities of the aircraft.
114. True/False: If the trailing edge flaps are failed in the 0° position, final approach airspeed is not significantly affected.
115. True/False: A single-engine landing is made at HALF flaps.
116. With 1,000 feet per minute sink rate, at 130 to 150 knots, with a 2 second reaction time, the minimum altitude for a successful ejection is feet in the F/A-18B at 0° angle of bank.
117. With 30° nose down and 90° angle of bank, and 200 knots, the minimum altitude for a safe ejection is feet in the F/A-18.
118. The correct procedure for an APU ACCUM caution airborne is:
119. List the steps for an out-of-control recovery (all aircraft).
120. Thunderstorm penetration should be made between optimum cruise and knots below 35,000 feet, and no less than knots above 35,000 feet.

121. What precautions must be observed when using the windshield rain removal?
122. The COM-NAV functions not available when MC 1 has failed are:
123. True/False: The right and left DDIs are physically and functionally interchangeable.
124. The bank angle scale pointer, on the HUD, is limited at ... and ...when the limit is exceeded.
125. The velocity vector represents:
126. True/False: Do not lock the gyro in the caged position with the pull to cage knob if the gyro is spinning.

Using Stall Speed chart:

Mil power
Gross weight - 28,000 pounds
Gear/flaps - DOWN

127. Determine - Stall Speed 0° Bank =
128. Determine - Stall Speed 45° Bank =

Using Landing Approach Speed chart:

Gross weight - 28,000 pounds
Flaps - 30°

129. Determine - Recommended Approach Speed =
130. What action must the pilot take in order to slew the moving map with the TDC?
- a.
 - b.
131. The GYRO position on the INS mode selector switch:
- a. Connects the gyros to the attitude heading reference system in order to complete an inflight alignment
 - b. Enables the mission computer to use the gyros in computations for air-to-air weapons delivery
 - c. Is the attitude mode where the INS operates only as an attitude heading reference system
 - d. All of the above
132. REJ 1 removes what from the HUD display?

138. State the ranges for the following: 400 402 as applicable
- a. Ground idle rpm -
 - b. Flight idle rpm -
 - c. Maximum oil pressure (2½ minutes after start with ambient temperature below -18°C, 0°F)
Minimum oil pressure (ground idle) -
 - d. Inflight oil pressure:
 - (1) Idle -
 - (2) Military -
139. The maximum speeds of the following are:
- a. Refueling probe -
 - b. Gear retraction/extension -
 - c. Gear emergency extension -
 - d. Trailing edge flaps -
 - e. Canopy open -
140. State the following limitations:
- a. Maximum gross weight field takeoff -
 - b. Maximum landing weight (field landing - flared) -
 - c. Carrier landing
 - (1) Aircraft 161353 THRU 163782 -
 - (2) Aircraft 163985 AND UP -
 - d. Maximum air refueling altitude -
 - e. Maximum closure on refueling drogue -
 - f. Maximum time at negative g -
 - (1) Aircraft THRU 161924 -
 - (2) Aircraft 161925 AND UP -
 - g. Minimum time between negative g maneuvers (Aircraft THRU 161924) -

141. If the velocity vector begins to flash slowly but is not HUD limited:
 - a. Selected ordnance has been released.
 - b. The mission computer may be displaying a degraded velocity vector
 - c. The waterline symbol is HUD limited
 - d. STBY attitude indicator is providing HUD attitude information
142. The HUD landing display (elongated horizon bar, AOA bracket, waterline symbol, steering display) will be presented
 - a. When selected through the HUD control panel
 - b. When selected on the right DDI
 - c. When gear is down and NAV master mode is selected
 - d. Any time that the gear is down
143. True/False: While using NAV master mode, the pilot has the option to cage or uncage the velocity vector on the HUD.
144. At what altitude will the cockpit begin to pressurize?
145. What action should be taken if FCS HOT caution light comes on in flight?
 - a.
 - b.
146. When the G XMT switch is placed to COMM 1 or COMM 2 the:
 - a. Selected radio will receive/transmit on 243.0 only
 - b. Selected radio will receive only 243.0
 - c. Selected radio will transmit only 243.0
147. The hydraulic pumps are located on the and maintain hydraulic pressure between psi.
148. The HYD 2 priority valves close at approximately psi.
149. Placing the HI mode selector switch to NORMAL displays compass rose aligned with the aircraft
 - a. Magnetic ground track
 - b. Magnetic heading
150. By what method are external tanks pressurized on the ground?

151. What indication does the pilot have to indicate low or lost motive flow pressure?
152. Fuel is transferred from external tanks by:
- The passing of motive flow fuel through an ejector pump which utilizes the venturi principle to induce fuel flow.
 - Bleed air to pressurize each external tank.
 - Electrically powered boost pumps located inside each tank.
 - AMAD driven boost pumps that utilize the venturi principle to induce the flow from each tank.
153. True/False: In the F/A-18B/D there is no provision to lower the landing gear from the rear cockpit.
154. With a failure of hydraulic system 2A, what alternate method exists for extending the air refueling probe?
155. Fuel dump is accomplished by:
- Motive flow (ejector pumps)
 - Electrical pump powered by essential bus
 - AMAD driven boost pump
 - Variable displacement pumps driven by hydraulic system 2A
156. Normal brake system pressure is provided by hydraulic system
157. What optical indications of NWS failure will the pilot have available besides the MASTER CAUTION light?
- -
158. What should occur when the oxygen test button is pressed?
159. Where is the manual canopy crank handle located inside the F/A-18 cockpit?
160. Depending on aircraft attitude and power setting, the fuel dump rate is about pounds/minute.
161. True/False: During single engine operations, significantly lower fuel boost pump rates have been experienced in the F/A-18C/D.
162. True/False: Mechanical linkage will allow normal retraction of the nose gear even with the launch bar extended.

163. After emergency extension of the air refueling probe, how is the probe retracted? (With loss of 2A system)
164. What is the meaning of an OFF flag in the fuel gauge?
165. How many low fuel indications does the pilot receive? What are they?
166. Switching to RDR position on the HUD altitude switch will:
 - a. Cause radar altimeter information to be displayed at all times, until BARO is reselected.
 - b. Cause radar altimeter information to be displayed when at or below 5,000 feet AGL and valid.
 - c. Cause radar altimeter information to be displayed on the HUD while barometric altitude continues to be displayed on the DDI.
 - d. Cause radar altimeter information to be displayed just below the boxed barometric altitude display.
167. When data link information has been lost during an ACL mode 1 or 2 approach, the HUD indication will be:
 - a. TILT cue
 - b. Break X
 - c. Flashing velocity vector
 - d. Both a and b
168. While using the A/A master mode the velocity vector on the HUD will be:
 - a. Caged
 - b. Uncaged
169. True/False: With an air-to-ground store or tank on a wing station, maximum roll rate is automatically reduced about 33%.

PART XI

PERFORMANCE DATA

Refer to Supplemental Flight Manual(s) A1-F18AC-NFM-200/210.

APPENDIX

SYSTEM ORGANIZATIONAL MAINTENANCE MANUALS.

The list below contains the publication numbers and titles of the manuals that provide organizational maintenance data by system. This list does not include supplements. The respective manual introduction has information on supplements.

Principles of Operation A1-F18A()	System Schematics A1-F18A()	System Title
-120-100	-120-500	Seat, Canopy, Survival Equipment, and Bording Ladder
-130-100	-130-500	Landing Gear and Related Systems
-240-100	-240-500	Secondary Power System
-270-100	-270-500	Power Plant and Related Systems
-410-100	-410-500	Environmental Control Systems
-420-100	-420-500	Electrical System
-440-100	-440-500	Lighting System
-450-100	-450-500	Hydraulic System
-460-100	-460-500	Fuel System
-510-100	-510-500	Instrument Systems
-560-100	-560-500	Air Data Computer System
-570-100	-570-500	Integrated Flight Controls
-580-100	-580-500	Maintenance System Display and Recording System or Flight Incident Recorder and Monitoring System
-600-100	-600-500	Communication, TACAN, ADF, Electronic Altimeter, IFF, and MIDS Systems
-630-100	-630-500	Data Link, Instrument Landing, and Radar Beacon Systems
-710-100	-710-500	Embedded GPS/INS (EGI) System or Global Positioning System

Principles of Operation A1-F18A()	System Schematics A1-F18A()	System Title
-730-100	-730-500	Inertial Navigation, Backup Altitude, and Navigation Systems
-731-100	-731-500	Digital Mapset/TAMMAC Digital Map System
-740-100	-740-500	Weapon Control System
-741-100	-741-500	Mission Computer System
-742-100	-742-500	Radar System
-743-100	-743-500	Laser Detector Tracker and Strike Camera Systems
-744-100	-744-500	Forward Looking Infrared System
-745-100	-745-500	Multipurpose Display Group
-746-100	-746-500	Advanced Targeting Forward Looking Infrared System or Navigation Infrared Receiving System
-750-100	-750-500	Gun System
-760-100	-760-500	Tactical Electronic Warfare Systems
-770-100	-770-500	Video Recording and Reconnaissance Systems

ALPHABETICAL INDEX

Page
No.

1

10,000 Feet III-7-25
10,000 Feet to Landing III-10-24, III-10-29, III-10-36, III-10-44, III-10-47
18,000 TO 10,000 Feet III-10-22, III-10-28, III-10-43, III-10-46

A

A/A Weapon Select Switch..... I-2-207
ABORT V-14-2, V-18-3
Aborted Takeoff. III-9-1
AC Electrical Power..... I-2-30
Acceleration Limitations. I-4-9
Accumulators. I-2-43
ACI Configuration Check. I-2-149
ACL Mode 1. VII-24-71
ACL Mode 1 and 1A Approaches..... III-8-12
ACL Mode 1A. VII-24-73
ACL Mode 2. VII-24-73
ACL Mode 2 Approach..... III-8-13
ACL Mode Displays..... VII-24-65
ACL Mode Operation. VII-24-68
ACL Option..... VII-24-6
Actuator Exerciser Mode..... I-2-48
Adaptability/Flexibility. IX-28-2
ADC AOA Validity Functionality. V-15-46
ADC FAILURE EFFECTS V-15-34
ADC Failure/HUD Symbology Degrades. I-2-107
ADF (Automatic Direction Finder)..... VII-24-54
ADF Function Select Switch. I-2-109, VII-23-4
AFCS Caution and Advisory Displays. I-2-60
After Landing..... III-7-32, III-7-38, III-10-26, III-10-30, III-10-37, III-10-47
AFTER LANDING..... VI-21-1
After Takeoff. III-7-25
AFTERBURNER FAILURE V-15-1
Afterburner Fuel Control..... I-2-2
Aided INS (AINS) Mode..... VII-24-12
AIL OFF Caution Display..... I-2-57
AILERON FAILURE/AIL OFF CAUTION..... V-15-60
Air Combat Maneuvering (ACM)..... IX-28-5
AIR DATA COMPUTER (ADC) I-2-159
Air Induction System. I-2-1
AIR REFUELING. III-9-6
Air Refueling System. I-2-21
Air Turbine Starter Caution Display. I-2-29
Airborne HMD Accuracy Check with CATM/AIM-9X..... III-9-16

	Page No.
Airborne HMD Accuracy Check with Radar.....	III-9-16
AIRBORNE HMD ACCURACY CHECKS	III-9-15
AIRCRAFT	I-4-1
Aircraft 161353 THRU 161519 AFTER AFC 039 AND 161520 AND UP.....	V-15-17
Aircraft 161353 THRU 161519 BEFORE AFC 039.	V-15-16
Aircraft 164196 THRU 164912 BEFORE AFC 216.	VI-22-1
Aircraft (A/C) Data Programming.....	VII-24-29
Aircraft Attitude Data.	I-2-199
AIRCRAFT DESCRIPTION	I-1-1
Aircraft Dimensions.....	I-1-1, I-2-201
Aircraft Gross Weight.....	I-1-1, I-2-201
Aircraft or Catapult Malfunction.....	III-8-17
Aircraft Stability and Dynamic Response.....	IV-11-4
AIRCREW RESPONSIBILITIES BY FLIGHT PHASE.....	IX-28-3
Airframe Mounted Accessory Drive (AMAD).....	I-2-26
Airspeed Limitations.....	I-4-2
ALE-39 Countermeasures Dispensing Set (CMDS).	I-2-120
ALE-39 Programmer.....	I-2-210
ALE-47 Advisories.	I-2-120
ALE-47 Countermeasures Dispensing Set.	I-2-120
Alert Five Launch	III-9-14
Alert Scramble Launch Procedures.....	III-9-13
Alignment Exit.	I-2-196
Alignment Verification.....	I-2-199
All Equipment.	I-2-171
Altitude Pointer.	I-2-73
Altitude Switch.	I-2-73, I-2-101
AMAD CAUTION.....	V-15-26
AMAD PR CAUTION.....	V-15-26
AMAD Pump BOOST LO Caution Display.	I-2-16
AMPCD (Aircraft 163985 AND UP AFTER AFC 380).	I-2-93
AMU Maintenance Format Options and Display Information.....	I-2-116
AMU/PC Cards Cautions and Advisories.....	I-2-119
Analog DEL.	V-15-50
Angle-Of-Attack (AOA) Indexer.....	I-2-76
Angle-of-Attack (AOA) Limitations.	I-4-7
Angle-Of-Attack Probes.....	I-2-159
Anti-G System.....	I-2-141
Anti-Skid System.	I-2-66
AOA Indexer Control.	I-2-101
AOA Indications with AOA Probe Damage.....	V-15-45
AOA PROBE DAMAGE.....	V-15-45
Applicable Publications.	X-29-4
Application.	I-2-43
Approach.	III-7-27, III-7-38, III-9-7, III-9-12
Approach Lights/Arresting Hook Floodlight.....	I-2-39
Approaches.....	VI-19-1
Approach/Landing (*)	X-29-4

	Page No.
APU ACCUM Caution Display.....	I-2-28
APU Fire Extinguishing System.....	I-2-121
APU FIRE LIGHT.....	V-18-1
APU Fuel Feed.....	I-2-16
APU Switch.....	I-2-28
Area.....	X-29-2
Armpit Camera System.....	I-2-115
Arrested Landing.....	III-9-12
Arrested Landing and Exit From the Landing Area.....	III-8-14
Arresting Hook Handle.....	I-2-69
Arresting Hook System.....	I-2-69
Arrestment and Exit From the Landing Area.....	III-8-17
Assertiveness.....	IX-28-1
Asymmetric Stores Landing.....	III-7-30
ASYMMETRIC THRUST EFFECTS.....	V-15-4
ATC Approach Mode.....	I-2-9
ATC Approach Mode Technique.....	III-8-9
ATC Cruise Mode.....	I-2-10
Attitude Heading Reference System (AHRS) Mode.....	VII-24-13
Attitude Hold.....	I-2-63
Attitude Reference Indicator.....	I-2-207
Attitude Selector Switch.....	I-2-101
AUTO BIT.....	I-2-174
Auto Flap Configuration.....	IV-11-3
AUTO FLAP LANDING.....	V-16-16
AUTO Flaps.....	IV-11-17
AUTO Option.....	VII-24-5
AUTO PILOT Caution Display.....	I-2-57
AUTO Sequential Steering.....	VII-24-47
AUTO Update.....	VII-24-41
Automatic Battery Cutoff.....	I-2-36
Automatic Carrier Landing Mode.....	VII-24-64
Automatic Disabling.....	VII-23-17
Automatic Erase.....	I-2-86
AUTOMATIC FLIGHT CONTROL SYSTEM (AFCS).....	I-2-60
Automatic IFF Mode/Code Updates.....	VII-23-17
Automatic Throttle Control (ATC).....	I-2-8
Autopilot.....	I-2-61
Auxiliary Power Unit (APU).....	I-2-28
Auxiliary Release Switch.....	I-2-143
Avionic BIT.....	I-2-163
Avionics Cooling and Pressurization.....	I-2-141
AVIONICS SUBSYSTEM.....	I-2-76
Azimuth Indicator.....	I-2-210

B

Backpad Adjustment Mechanism (SJU-17A(V)1/A, 2/A, and 9/A).....	I-2-134
BACKUP ATTITUDE AND NAVIGATION SYSTEM.....	VII-25-2

Backup Attitude and Navigation System Controls and Indicators.....	VII-25-2
BACKUP FREQUENCY CONTROL.....	VII-25-5
Backup Heading Mode Control.....	VII-25-4
Backup HSI Display.....	VII-25-1
Backup HUD Display.....	VII-25-1
Balance Control (Aircraft 163985 AND UP).....	I-2-100
Banner Drop.....	III-9-10
Banner Release Failure.....	III-9-10
Banner Towed Target Equipment.....	III-9-8
Banner Towing Limitations.....	I-4-9
BANNER TOWING SYSTEM.....	III-9-8
Barometric Altitude Hold.....	I-2-63
Barometric (BARO)/Radar Low Altitude Warning Programming.....	VII-24-29
Barometric Low Altitude Warning.....	I-2-73
BARRICADE ARRESTMENT.....	V-16-17
BATT SW Caution Light/Display.....	I-2-36
Battery Caution Lights and Displays.....	I-2-32
Battery Switch.....	I-2-32
Battery Switch.....	I-2-35
Before Catapult Hook-Up.....	III-8-3
Before Engine Shutdown.....	III-7-33, III-7-39
Before Entering Cockpit.....	III-7-6, III-7-36
BEFORE ENTERING COCKPIT.....	VI-22-1
Before Plug-in.....	III-9-6
Before Takeoff.....	III-7-23, III-7-38, III-10-42, III-10-45, VI-19-1
BEFORE TAKEOFF.....	VI-21-1
Before Taxi.....	III-7-18, III-7-37, III-8-17, III-10-8, III-10-27, III-10-32, III-10-40, III-10-44
BEFORE TAXI.....	VI-22-1
BINGO Caution.....	I-2-19
Bingo Caution Display.....	I-2-20
BIT Checks.....	I-2-74
BIT Initiate Pushbutton.....	I-2-113
BIT Initiate Pushbuttons.....	I-2-115
BIT Initiation (F/A-18A AFTER AFC 253 OR 292 AND F/A-18C/D).....	I-2-167
BIT Initiation (F/A-18A/B BEFORE AFC 253 OR 292).....	I-2-167
BIT Light.....	I-2-73
BIT Logic Inspection (BLIN) Codes.....	I-2-181
BIT Recording On The Memory Unit.....	I-2-192
Black Level Control (Aircraft 163985 AND UP).....	I-2-100
Bleed Air Augmentation.....	I-2-29
Bleed Air Knob.....	I-2-138
Bleed Air System.....	I-2-137
BLOCK NUMBERS.....	I-1-2
Boarding Ladder.....	I-2-127
Bolter.....	III-9-12
Boresight Reference Unit (BRU).....	I-2-188
Both Engines From APU.....	I-2-29
BRAKE FAILURE/EMERGENCY BRAKES.....	V-13-4, V-18-3

Brake System.....	I-2-66
Braking Technique.....	III-7-28
Breathing Regulator.....	I-2-158
Briefing.....	III-6-1
BRIEFING/DEBRIEFING.....	III-6-1
Brightness Control.....	I-2-88, I-2-93
Brightness Control Knob.....	I-2-109, VII-23-6
Brightness Selector Knob.....	I-2-88
Built-In Test (BIT).....	I-2-190

C

CABIN Caution Light.....	I-2-140
CABIN CAUTION LIGHT.....	V-18-5
Cabin Pressure Switch.....	I-2-140
Cabin Pressurization Warning System (CPWS).....	I-2-140
Canopy Caution Display.....	I-2-124
Canopy Sill DISP Switch.....	I-2-210
Canopy System.....	I-2-122, I-2-202
Carrier Electromagnetic Environment.....	III-8-1
Carrier INS Environment.....	III-8-2
Carrier Qualification.....	II-5-2
Catapult Afterburner Operation.....	III-8-6
Catapult Hook-Up.....	III-8-4, III-8-17
Catapult Launch.....	III-8-7, III-8-17
Catapult Suspend.....	III-8-8
Caution and Advisory Displays.....	I-2-7
Caution/Advisory Indications.....	I-2-166
Cautions/Advisories.....	I-2-188
Ceiling/Visibility Requirements.....	II-5-2
CENTER OF GRAVITY (CG).....	IV-11-21
CFIT Protection Provided - Altitude Loss During Recovery (ALDR).....	I-2-150
CG Caution Display (MC OFP 10A AND UP).....	I-2-12
CG Control.....	I-2-12
CG Determination.....	IV-11-21
CG Limitations.....	I-4-6
CG Worksheet.....	IV-11-22
Chaff/Flare/ECM Switch.....	I-2-209
Channel Display Windows.....	I-2-112
Channel Selector Knobs.....	I-2-112
Chase Position.....	III-9-11
CHECK TRIM Caution Display.....	I-2-57
Checkflight Requirements (Rear Cockpit).....	III-10-27, III-10-43, III-10-44
Ciphered Reception.....	VII-23-7
Ciphered Relay Mode.....	VII-23-7
Ciphered Transmission.....	VII-23-7
Circuit Breakers.....	I-2-37
CK ECS Caution Light.....	I-2-140
CK FLAPS Caution Display.....	I-2-57

	Page No.
CK SEAT Caution (F/A-18C/D)	I-2-130
CK SEAT Caution (F/A-18D).....	I-2-204
Climb.....	III-7-25
Climb Pushbutton.	I-2-26
Climb/Cruise	X-29-4
Clock.	I-2-74
Closed Book Examination.....	X-29-2, X-29-3
Coarse Alignment.	I-2-192
Cockpit Air Conditioning and Pressurization.	I-2-139
Cockpit Controls and Displays.	I-2-87
Cockpit Displays Initiated BIT (MC OFP 10A AND UP).....	I-2-175
Cockpit Displays Initiated BIT (MC OFP 13C AND UP)	I-2-179
COCKPIT SMOKE, FUMES, OR FIRE.....	V-15-30, V-18-4
COCKPIT TEMPERATURE HIGH.....	V-15-29
Cockpit Unit (CU).	I-2-188
Cockpit Video Recording System (Aircraft 164945 AND UP and Aircraft 163985 THRU 164912 AFTER AFC 207).....	I-2-114
Cold Weather and FCS Exerciser Mode.	I-2-173
Combined Interrogator Transponder (Aircraft 165222 AND UP, F/A-18A AFTER AFC 292, AND Aircraft 163985 THRU 165221 AFTER AFC 236).	VII-23-15
Comm 1 and Comm 2 Channel Display Windows.....	VII-23-4
Comm 1 and Comm 2 Channel Selector Knobs.....	VII-23-3
Comm 1 and Comm 2 Volume Controls.	VII-23-3
Comm Relay Switch.	VII-23-8
Command Selector Valve.....	I-2-205
Communication.	IX-28-1
Communication Control Panel.	VII-23-18, VII-24-10
COMMUNICATION-NAVIGATION-IDENTIFICATION INTERFACE.....	VII-23-20
Communications.....	X-29-4
CONCEPT	X-29-1
Conditionally Qualified.....	X-29-1
Configuration Check.	I-2-190
Console Lighting.....	I-2-40
Contact.	III-9-7
Contrast Control.....	I-2-88, I-2-93, I-2-94
Control Augmentation System (CAS).....	I-2-52
Control Stick.	I-2-45
Control Stick (AIRCRAFT 161354 THRU 163778 and trainer configured 163986 AND UP). .	I-2-207
CONTROLLABILITY CHECK	V-15-63
Controls and Indicators.	I-2-73, VII-23-7
Countdown Time (CD).....	VII-24-38
Coupled Auto Sequential Steering (MC OFP 13C AND UP).....	VII-24-47
Coupled Steering (MC OFP 13C AND UP).....	I-2-63
Coupled TACAN Steering (F/A-18A after AFC 253 or 292 and F/A-18C/D).	VII-24-57
Coupled Waypoint/OAP Steering (MC OFP 13C AND UP).	VII-24-46
Course Select Switch.....	VII-24-10
Course Set Switch.....	I-2-109

Crash Survivable Flight Incident Recorder System (CSFIRS) (Aircraft 163427 THRU 164279
 AFTER AFC 258)..... I-2-163
 Crew Member..... IX-28-3
 Critical Area/Sub-area..... X-29-2
 CRITICAL SKILLS OF CREW RESOURCE MANAGEMENT IX-28-1
 Critique..... X-29-5
 Cross Bleed From First Engine..... I-2-29
 Cross Country..... II-5-2
 Crosswind Landing..... III-7-29
 Crosswind Takeoff..... III-7-25
 Cruise..... III-7-26
 Cruise Check..... III-7-26
 Cruise Formation..... III-9-3
 Cruise/Pattern..... III-9-9
 Crypto Switch..... VII-23-19
 CSC MUX FAILURE V-15-19
 Cue Channel Selection..... VII-23-14
 Current Endurance Area..... I-2-24
 Current Range Area..... I-2-24
 CV Alignment Mode..... VII-24-13
 CV MAN (Manual) Alignment..... VII-24-14
 CV/GND Alignment Completion (Aircraft without GPS)..... VII-24-22
 CVRS Control Panel..... I-2-114

D

DAMAGED AOA PROBE PROCEDURE V-15-47
 DATA LINK SYSTEM..... VII-24-64
 DATA Option..... VII-24-4
 Date Programming (SET)..... VII-24-39
 Day Brightness Selector..... I-2-93
 DAY OPERATIONS III-8-2
 DC Electrical Power (Aircraft 161353 THRU 161528 BEFORE AFC 049)..... I-2-31
 DC Electrical Power (AIRCRAFT 161702 AND UP AND AIRCRAFT 161353 THRU 161528
 AFTER AFC 049)..... I-2-35
 DDI..... VII-24-6
 DDI Configuration Display Country ID Code..... I-2-182
 DDI Configuration Display OFP ID Numbers..... I-2-182
 DDI Fuel Display..... I-2-20
 DDI Spin Recovery Displays..... I-2-50
 DDI Video..... I-2-112, I-2-114
 DDI/HI/MPCD/AMPCD/HUD Initiated BIT..... I-2-179
 Debriefing..... III-6-3
 Decision Making..... IX-28-1
 Default Area..... I-2-24
 DEFINITION IX-28-1
 Definitions..... X-29-1
 Defog Handle/Cockpit Louvers..... I-2-140
 Defogging System..... I-2-140

	Page No.
DEGRADED MODE HANDLING QUALITIES.....	IV-11-16
DEGRADED SYSTEMS	VI-19-1
DEL ON Caution Display.....	I-2-57
Departure.....	V-15-61
Departure Characteristics.....	IV-11-8
Departure Resistance.....	IV-11-7
Departure Warning Tone.....	I-2-49
Deployable Flight Incident Recorder Set (DFIRS) (Aircraft 164627 AND UP).....	I-2-160
Descent.....	III-9-9, VI-19-1
DESCENT	VI-21-1
Descent/Penetration.....	III-7-26 , III-7-38
Designation.....	VII-24-48
Designation (DSG) Update.....	VII-24-41
Designator Control Assignment (DCA)/Sensor Control.....	I-2-207
Digital DEL.....	V-15-49
Digital DEL - DEL ON Caution.....	V-15-49
Digital Display Indicators.....	I-2-206
Digital Display Indicators (DDI).....	I-2-87
Dimming and Test Functions.....	I-2-144
Direct Electrical Link (DEL).....	I-2-53
DIRECT ELECTRICAL LINK (DEL).....	V-15-49
Disengagement.....	III-9-7
Dispense Switch.....	I-2-4
DISPLAY MALFUNCTION.....	V-15-32
Display Select Control (AIRCRAFT 161704 THRU 163778).....	I-2-207
DITCHING	V-17-4
D/L Option.....	VII-24-6
DMS Map Range Scales.....	VII-24-1
Double Generator Failure.....	V-15-19
DOUBLE GENERATOR OR DOUBLE TRANSFORMER - RECTIFIER FAILURE.....	V-18-4
DOUBLE GENERATOR OR DOUBLE TRANSFORMER-RECTIFIER FAILURE.....	V-15-19
Down Lock Override Button.....	I-2-64
DUAL L BLEED and R BLEED WARNING LIGHTS / L/R ATS CAUTION / DUAL L/R BLD OFF CAUTION	V-18-1
Dump Open Caution Display.....	I-2-17

E

Effects of Light.....	III-9-11
Effects on Vision.....	III-9-11
EGRESS	V-13-3
EGT.....	I-4-1
EJECTION.....	V-17-1
Ejection Control Handle.....	I-2-130
Ejection Procedures.....	V-17-4
Ejection Seat.....	I-2-128
Ejection Seat SAFE/ARMED Handle.....	I-2-130
Ejection Seat System.....	I-2-202
Elapsed Time (ET).....	VII-24-38

	Page No.
ELECTRICAL POWER SUPPLY SYSTEM	I-2-30
Electronic Attitude Display Indicator (EADI).....	I-2-91
Electronic Unit Failure.....	I-2-200
Electronics Unit (EU).....	I-2-188
EMERGENCIES	IX-28-5
Emergency.....	X-29-2
Emergency Brake Handle.	I-2-206
Emergency Brake System.....	I-2-67
Emergency Canopy System.....	I-2-124
EMERGENCY CATAPULT FLYAWAY	V-14-1, V-18-3
EMERGENCY EQUIPMENT.....	I-2-142
Emergency Gear Extension.....	I-2-65
Emergency Instrument Light.....	I-2-40
Emergency Jettison Button.	I-2-142, I-2-210
Emergency Landing Gear Handle.	I-2-206
Emergency Oxygen (LOT 13 AND UP).	I-2-158
Emergency Oxygen Supply (LOT 4-12).....	I-2-154
EMERGENCY TANKER DISENGAGEMENT	V-15-19
Emergency/Malfunction Procedures (*).	X-29-4
Emergency/Parking Brake Handle.	I-2-68
Emission Control Pushbutton.	I-2-109, VII-23-20
Engine Anti-Ice.	I-2-3
Engine Anti-Ice Switch	I-2-3
ENGINE CAUTIONS/ ENGINE STALL.....	V-18-2
Engine Control System.....	I-2-2
Engine Controls and Instruments	I-2-3
Engine Crank Switch.....	I-2-3
ENGINE FAILS TO START/HUNG START	V-13-1
ENGINE FAILURE	V-15-3
ENGINE FIRE IN FLIGHT	V-15-1
Engine Instrument Light.....	I-2-41
Engine Limitations.....	I-4-1
Engine Monitor Display (EMD).....	I-2-6
Engine Monitor Indicator (EMI) (F/A-18A/B).....	I-2-5
Engine Shutdown.....	III-7-34
ENGINE STALL.....	V-15-4
Engine Start.	III-7-13, III-8-2 , III-10-3, III-10-30, III-10-37
ENGINE START	VI-22-1
ENGINE STUCK AT MIL (AFTER DESELECTING AFTERBURNER).....	V-15-1
Engine/AMAD Fire Extinguishing System.....	I-2-121
Engines.....	I-2-1
Enroute.....	IX-28-4
ENTRANCE/EGRESS SYSTEMS	I-2-122
ENVIRONMENTAL CONTROL SYSTEM	I-2-137
Equipment Groups.....	I-2-171
Equipment Status Displays.	I-2-164, I-2-182, I-2-206
Erase and Hold Data.....	I-2-86
Erase Data (CRYPTO Switch).....	I-2-84

Page
No.

Erasing All Net Data.....	VII-23-12
Erasure of Auto-IFF Data.....	VII-23-18
E/U BATT Voltmeter.....	I-2-36
Event Mark.....	I-2-113
Event Marker.....	I-2-115
Exterior Inspection.....	III-7-1
EXTERIOR INSPECTION	VI-22-1
Exterior Lighting.	I-2-37
Exterior Lights Master Switch.	I-2-38
External Canopy Jettison Handles (Aircraft 161353 THRU 162477).	I-2-127
External Canopy Switch.	I-2-123
External Electrical Power.....	I-2-36
External Light Management.	III-7-39
External Manual Canopy Actuation Fitting.	I-2-124
External Power Start.....	I-2-29
External Power Switch.....	I-2-36
EXTERNAL STORES	I-4-9
EXTERNAL STORES JETTISON.....	V-15-32
External Tank Fuel Control Switches.	I-2-13 , I-2-22
External Tank Pressurization Caution Display.	I-2-11
EXTERNAL TANK TRANSFER FAILURE.....	V-15-17
External Transfer.....	I-2-13
External Transfer Caution Display.....	I-2-13

F

F/A-18 Departure Prone Flight Regions.	IV-11-9
F/A-18A/C (F/A-18B/D Front Cockpit)	III-10-2, III-10-30, III-10-37
F/A-18B/D Aircraft 161354 THRU 163778.	I-2-201
F/A-18D Aircraft 163986 AND UP.	I-2-201
Factors That Degrade Crew Resource Management	IX-28-2
Falling Leaf.....	V-15-61
Falling Leaf Mode.....	IV-11-11
Fan Test Switch.	I-2-141
Fault Indicator.....	I-2-88, I-2-101
FC AIR DAT Caution Display.	I-2-57
FCC Circuit Breakers.	I-2-52
FCC OFP Functionality.....	V-15-45
FCES Caution Light.	I-2-57
FCF CHECKLIST - PROFILE A (Includes combined profiles B and C)	III-10-2
FCF CHECKLIST - PROFILE B.....	III-10-30
FCF CHECKLIST - PROFILE C.....	III-10-37
FCF CHECKLIST - PROFILE D	III-10-44
FCS Caution Display.....	I-2-57
FCS Cautions.....	I-2-57
FCS Degraded Modes (DEL/MECH).....	IV-11-17
FCS FAILURE.....	V-15-45
FCS FAILURE INDICATIONS AND EFFECTS	V-15-34
FCS HOT Caution.....	I-2-52

	Page No.
FCS HOT Caution Display.....	I-2-57
FCS Initiated BIT.	I-2-171
FCS or AV COOL Switch.....	I-2-52
FCS RESET Button.	I-2-47
FCS Status Display.	I-2-58
FEED TANK TRANSFER FAILURE.....	V-15-17
Ferry Squadrons.	II-5-2
Field Arresting Gear.	V-16-16
FIELD ARRESTMENT.....	V-16-16
FIELD ARRESTMENT GEAR DATA	V-16-17
FIGHTER/ATTACK/TRAINER/RECCE (F/A-18B/D).....	I-2-201
Fill Select Knob.	VII-23-8
Final Grade Determination.....	X-29-5
FINE Alignment.....	I-2-196
Fire and Bleed Air Test Switch.	I-2-121
FIRE DETECTION/EXTINGUISHING SYSTEMS	I-2-120
Fire Extinguisher Pushbutton.....	I-2-120
FIRE LIGHT.....	V-18-2
Fire Warning Lights.	I-2-204
Fire Warning/Extinguisher Lights/Voice Alert.....	I-2-120
Fixed Frequency Preset.	VII-23-6
Flap Operation	I-2-55
Flap Position Lights.	I-2-56
FLAP SCHED CAUTION	V-15-59
FLAP SCHED Caution Display.....	I-2-57
Flap Switch.....	I-2-45
Flaps.	I-2-54
Flaps Auto.....	I-4-7
Flaps Half or Full.....	I-4-5, I-4-8
FLAPS OFF CAUTION	V-15-57, V-18-3
FLAPS OFF Caution Display.	I-2-57
Flight Codes.	III-6-1
FLIGHT CONTROL CAUTIONS	V-18-3
Flight Control Computers (FCC).....	I-2-51
Flight Control Modes.	IV-11-1
FLIGHT CONTROL SYSTEM.....	I-2-43
FLIGHT EVALUATION.....	X-29-3
Flight Evaluation Grade Determination.	X-29-5
Flight Evaluation Grading Criteria.	X-29-5
Flight Incident Recorder and Aircraft Monitoring Set (FIRAMS) (F/A-18C/D).....	I-2-160
FLIGHT MEMBER POSITIONS	IX-28-2
FLIGHT PERFORMANCE ADVISORY SYSTEM.....	I-2-24
Flight Performance Advisory System (FPAS) (F/A-18A Aircraft AFTER AFC 253 OR 292, and F/A-18C/D Aircraft.)	I-2-24
Flight Phase.	VII-24-38
Flight Preparation.	III-9-12
Flight Procedures.....	III-9-8
FLIGHT TRAINING SYLLABUS TRAINING PHASES.....	II-5-1

	Page No.
Flood/Chart Lighting.	I-2-40
Flying Qualities with Lateral Weight Asymmetries.	IV-11-6
FORCED LANDING.	V-16-6
FORMATION FLIGHT.	III-9-1
Formation Flights.	IX-28-5
Formation Leader.	IX-28-3
Formation Lights.	I-2-38
Formation Takeoff.	III-7-25
Formation Taxi/Takeoff.	III-9-1
FPAS Advisory.	I-2-26
FPAS Display.	I-2-24
Fuel Advisory.	I-2-19
Fuel Dump System.	I-2-17
Fuel Feed System.	I-2-13
Fuel Feed With Failed Ejector or Turbo Pump.	I-2-16
Fuel Feed With Loss Of Motive Pressure.	I-2-16
Fuel Flow Area.	I-2-26
Fuel Hot Caution Display.	I-2-16
Fuel Lo Level Indications.	I-2-17
Fuel Low BIT.	I-2-20
Fuel Quantity.	I-2-202
Fuel Quantity Advisory Display.	I-2-21
Fuel Quantity BIT.	I-2-18
Fuel Quantity Indicating System (F/A-18A/B).	I-2-18
Fuel Quantity Indicating System (F/A-18C/D).	I-2-19
Fuel Quantity Indicator.	I-2-18
Fuel Quantity Indicator (F/A-18B).	I-2-204
Fuel Quantity Selector Pushbutton.	I-2-19
Fuel Quantity Selector Switch.	I-2-18
Fuel Recirculation System.	I-2-16
FUEL SYSTEM.	I-2-10
Fuel Tank Pressurization and Vent.	I-2-10
FUEL TRANSFER FAILURES.	V-15-16
FUEL XFER Caution Display (MC OFF 13C AND UP).	I-2-12
Function Selector Pushbuttons.	I-2-111
Functional Checkflights.	IX-28-5
FUSELAGE FUEL LEAK.	V-15-15

G

G Limiter.	I-2-48
Gain Control.	I-2-94
Gain Override.	IV-11-19
Gain Switch.	I-2-47, I-2-55
General Injury Risks.	V-17-2
General Mission Briefing Guide.	III-6-1
Generator Control Switches.	I-2-31
Generator, GEN TIE Caution Lights, and Displays.	I-2-31
Generator TIE Control Switch.	I-2-31

	Page No.
Glideslope.	III-8-9
G-LIM 7.5 G Caution Display.....	I-2-57
G-LIM OVRD Caution Display.	I-2-57
G-Limiter.	IV-11-4
Global Positioning System (GPS) (Aircraft 163427 THRU 164912 AFTER AFC 175 PT2, Aircraft 164945 AND UP, and aircraft with EGI).	VII-24-12
GND (Ground) Alignment Mode.....	VII-24-17
GO AROUND	V-14-3
GPS Waypoint Programming.	VII-24-25
GPWS - Ground Proximity Warning System (MC OFP 10A+ AND UP, 13C AND UP).	I-2-149
GPWS Aural Cues.	I-2-153
GPWS Visual Cues.....	I-2-152
Grading Instructions.	X-29-2
Gravity Transfer.....	I-2-12
GROUND EVALUATION.....	X-29-2
GROUND FIRE.....	V-13-1
Ground Operation	VI-20-2
Ground Power Switches.....	I-2-37
Ground Procedures.	III-9-8
Ground Proximity Warning System.	I-2-200
Ground Refueling System.	I-2-22
GROUND TRAINING SYLLABUS	II-5-1
Groundspeed Cuing.	VII-24-48
Groundspeed Programming.	VII-24-28
Guard Channel Selection.....	VII-23-6
Gyro Recovery.	VII-24-22

H

HALF or FULL Flap Configuration.....	IV-11-1, IV-11-17
Hand Controllers (F/A-18D night attack configured AIRCRAFT 163986 AND UP).....	I-2-207
HANDLING QUALITIES	IV-11-1
Hangar Deck Operation.....	III-8-3
HAVE QUICK OPERATION AND OPTIONS (ARC-210) (AIRCRAFT 164945 AND UP, F/A-18A AFTER AFC 253 OR 292 AND AIRCRAFT 163427 THRU 164912 AFTER AFC 185.).	VII-23-9
Heading Select.....	I-2-63
Heading Set Switch.	I-2-109
Head-Up Display.	I-2-207
Head-Up Display (HUD).....	I-2-100
Helmet Display Unit (HDU).	I-2-185
Helmet Mounted Display (HMD)/Aft Helmet Mounted Display (AHMD).....	I-2-185
Helmet Not Installed.	I-2-200
Helmet Tracker Failure.	I-2-200
Helmet-Vehicle Interface (HVI) Connectors.....	I-2-185
HI (Aircraft 161353 THRU 163782).	I-2-91
HI Brightness Selector Knob.....	I-2-92
High Altitude (Above 30,000 Feet).....	III-10-21, III-10-28, III-10-36, III-10-46
High Altitude Ejection.	V-17-4
High AOA Flying Qualities.....	IV-11-5

High Speed Asymmetric FLIR Pod Handling Qualities (TFLIR, ATFLIR, NAVFLIR). IV-11-6
 High Yaw Rate Spin. IV-11-13
 HI/MPCD. VII-25-2
 HI/MPCD Display. VII-25-4
 HMD Alignment. III-9-15
 HMD Video Recording. I-2-188
 HMD/AHMD OFF/BRT Knobs. I-2-188
 HMD/AHMD Symbology. I-2-199
 Holding. VI-19-1
 HOME FUEL Caution. I-2-26
 HOOK FAILS TO EXTEND. V-16-15
 HOT BRAKES/BRAKE FIRE. V-13-2
 Hot Refueling. III-7-33
 Hot Seat Procedure. III-9-13
 HOT START. V-13-1, V-18-3
 HSI Display. VII-24-2
 HSI Display Symbology. I-2-95
 HSI Option (After AFC 327). VII-24-2
 HSI with Waypoint or TACAN Steering Selected. I-2-26
 HUD. VII-24-6
 HUD ACL Display. VII-24-67
 HUD Advisory Data Symbology. I-2-108
 HUD BIT Checks. I-2-109
 HUD Reject 1. I-2-149
 HUD Symbology. I-2-101
 HUD Symbology Brightness Control. I-2-100
 HUD Symbology Brightness Selector Knob. I-2-100
 HUD Symbology Degrades. I-2-106
 HUD Symbology Not Replicated on the HMD. I-2-199
 HUD Symbology Reject Switch. I-2-100
 HUD Symbology Replicated on the HMD. I-2-199
 HUD Video Camera. I-2-113, I-2-114
 HUD Video Camera Control Panel. I-2-113
 HUD Video Control Switch (Aircraft 163985 AND UP). I-2-100
 HUD/DDI Selector Switch. I-2-113
 HUD/LDDI Selector Switch. I-2-114
 Hydraulic Circuits. I-2-42
 HYDRAULIC FAILURE V-15-9
 Hydraulic Power. I-2-45
 HYDRAULIC POWER SUPPLY SYSTEM I-2-41
 HYPOXIA/LOW MASK FLOW/NO MASK FLOW V-15-27 , V-18-4

I

ICE AND RAIN. VI-20-1
 IDENTIFICATION SYSTEM. VII-23-15
 If GPS Data Available During Alignment (IFA GPS). VII-24-20
 If No GPS Data Available During Alignment (IFA RDR). VII-24-21
 IFA (Inflight Alignment) Mode. VII-24-18

	Page No.
IFEI Brightness Control Knob.	I-2-113, I-2-114
IFEI Initiated BIT.	I-2-180
IFEI Lighting.	I-2-40
IFF 4 Caution/Voice Alert.	VII-23-19
IFF Antenna Selector Switch.	VII-23-20
IFF BIT Check.	VII-23-20
IFF Controls and Indicators.	VII-23-18
IFF Emergency Operation.	VII-23-20
IFF Function Selector Pushbutton.	VII-23-18
IFF OVRHT Caution.	VII-23-19
IFFAI Caution.	VII-23-19
Ignition System.	I-2-3
ILS BIT.	VII-24-61
ILS Channel Thumbwheels.	VII-24-10
ILS Decoder.	VII-24-61
ILS Initialization.	VII-24-61
ILS (INSTRUMENT LANDING SYSTEM).	VII-24-61
ILS Option.	VII-24-6
ILS Receiver.	VII-24-61
ILS Steering.	VII-24-62
ILS UFC/MAN Switch.	VII-24-10
Immediate Action Items.	V-12-1
Implementation.	X-29-1
In Flight.	VI-20-2, VI-19-1, VI-21-1
Incomplete Alignment Advisory (MC OFP 13C AND UP).	VII-24-18
Individual Units.	I-2-171
Inertial Measurement Unit (IMU) (AN/ASN-130A).	VII-24-11
Inertial Measurement Unit (IMU) (AN/ASN-139 and EGI).	VII-24-11
Inertial Navigation (NAV) Mode.	VII-24-12
INERTIAL NAVIGATION SYSTEM (INS)/GLOBAL POSITIONING SYSTEM (GPS).	VII-24-10
Inertial Navigation Unit (INU).	VII-24-11
Inflight Alignment.	VII-24-18
Initial NATOPS Qualification.	II-5-1
Initialization.	VII-24-68
Initiated BIT (IBIT).	I-2-190
Injury Risks For Heavier Weight Crewmembers.	V-17-3
Injury Risks For Lighter Weight Crewmembers.	V-17-2
Inlet Duct Doors.	I-2-2
INS Alignment Modes.	VII-24-13
INS BIT.	VII-24-13
INS Check Display.	VII-24-22
INS CV Alignment (Manual Procedures).	VII-24-15
INS CV Alignment (RF OR CBL) (SINS Procedures).	VII-24-14
INS Failure/HUD Symbology Degrades.	I-2-106
INS Initiated BIT.	I-2-174
INS Mode Select Knob.	VII-24-6

**Page
No.**

INS Signal Data Converter..... VII-24-13
 INS Terminal Data. I-2-183
 INS Updates (Not available in AINS) VII-24-53
 INSTRUMENT FLIGHT VI-19-1
 Instrument Lighting. I-2-40
 INSTRUMENTS..... I-2-71
 Integrated Fuel/Engine Indicator..... I-2-19
 Integrated Fuel/Engine Indicator (IFEI) Engine Display (F/A-18C/D)..... I-2-5
 Integrated Fuel/Engine Indicator (IFEI) Time Displays (F/A-18 C/D)..... I-2-74
 Intercom Controls..... I-2-204
 Intercom Function Selector Switch..... I-2-204
 INTERCOM SYSTEM..... VII-23-1
 Interior Check..... III-7-9, III-7-36
 INTERIOR CHECK..... VI-22-1
 Interior Lighting. I-2-39, I-2-206
 Intermediate Yaw Rate Spin. IV-11-12
 Internal Canopy Jettison Handle..... I-2-127, I-2-205
 Internal Canopy Switch. I-2-123
 Internal Manual Canopy Handcrank. I-2-123
 Internal Transfer I-2-11
 Internal Transfer (F/A-18A/B). I-2-11
 Internal Transfer (F/A-18C/D). I-2-11
 Internal Wing Tank Fuel Control Switch..... I-2-12
 Internal Wing Tank Fuel Control Switch. I-2-22
 Interrogator Mode/Code Selection on the UFC..... VII-23-17
 Interrogator Operation..... VII-23-17
 Invalid FCS Status Display V-15-34
 Inverted Spin. IV-11-13
 I/P Pushbutton. I-2-109, VII-23-18

J

Jammed AOA Probe On Takeoff..... V-15-47
 JAMMED CONTROLS V-15-60
 Jettison Systems..... I-2-142
 JHMCS Alignment..... I-2-192
 JOINT HELMET MOUNTED CUEING SYSTEM (JHMCS)..... I-2-185

K

KY-58 Cipher Mode. VII-23-9
 KY-58 Control Panel Assembly. VII-23-7
 KY-58 Operation..... VII-23-8
 KY-58 Relay Mode..... VII-23-9

L

L and R AMAD Caution Display..... I-2-28
 L and R AMAD PR Caution Display..... I-2-28

	Page No.
L4MAP Option (F/A-18A/B).....	VII-24-5
LANDING	III-7-26
Landing Gear Control Handle.....	I-2-64
LANDING GEAR EMERGENCY EXTENSION	V-16-9
LANDING GEAR FAILS TO RETRACT	V-14-5
Landing Gear Position Lights.....	I-2-206
Landing Gear Position/Planing Link Failure Lights.....	I-2-65
Landing Gear System.....	I-2-64
LANDING GEAR UNSAFE/FAILS TO EXTEND	V-16-8
Landing Gear UNSFE Light.....	I-2-206
Landing Gear Warning Lights/Tone.....	I-2-65
Landing Pattern.....	III-8-8, III-8-17, III-9-12
Landing Rollout.....	III-7-28
LANDING SYSTEM.....	I-2-64
LANDING WITH AFT CG.....	V-16-15
Landing/Taxi Light.....	I-2-39
Lateral Weight Asymmetry AOA Limitations.....	I-4-8
Lateral Weight Asymmetry Limitations.....	I-4-6
Launch Bar System.....	I-2-68
Leadership.....	IX-28-1
Leading Edge Flap Failures.....	IV-11-19
LEF FAILED (WITH INBOARD POSITION FAILED UP BEYOND 4° OVER-TRAVEL STOP).....	V-15-58
LEF FAILED (WITH INBOARD POSITION LESS THAN 4° UP) OR TEF FAILED	V-15-59
Left and Right Fire Warning Lights.....	I-2-16
Leg Restraint Snubber Release Tabs.....	I-2-131
Leg Restraint System.....	I-2-131
LIGHTING	I-2-37
Lights Test Switch.....	I-2-41, I-2-206
Limitations.....	I-4-9
Line Operations.....	III-7-1
Link 4/SA Display.....	VII-24-66
Loading an Operational Day.....	VII-23-13
Local Time Of Day Programming (LTOD).....	VII-24-39
Long Field Arrestment.....	V-16-17
LOSS OF CABIN PRESSURIZATION	V-15-31, V-18-4
LOSS OF DC ESSENTIAL BUS	V-15-21
LOSS of DIRECTIONAL CONTROL DURING TAKEOFF or LANDING (BLOWN TIRE, NWS FAILURE)	V-14-3
LOSS OF DIRECTIONAL CONTROL DURING TAKEOFF OR LANDING (BLOWN TIRE, NWS FAILURE) / PLANING LINK FAILURE	V-18-4
Loss of INS data to FCCs.....	IV-11-18
LOSS OF THRUST ON TAKEOFF.....	V-14-4
Low Altitude Ejection.....	V-17-3
Low Altitude Index Pointer.....	I-2-73
Low Altitude Warning Light.....	I-2-73
Low Yaw Rate Spin.....	IV-11-12
L(R) Bleed Air Warning Lights.....	I-2-138

L(R) Bleed Off Caution Displays.....	I-2-138
L/R Pitot HT Caution Display.....	I-2-71
Lubrication System.....	I-2-3

M

Magnetic Azimuth Detector.....	VII-25-2
Magnetic Transmitter Unit (MTU).....	I-2-188
Malfunction.....	X-29-2
Manual Erase.....	I-2-86
Manual Frequency Mode Selection.....	VII-23-6
Manual Override Handle.....	I-2-133
Manual SRM.....	IV-11-14
Manually Loading Mission Planned Automatic IFF Data.....	VII-23-17
Map Brightness Knob.....	I-2-92
Map Data (163985 AND UP).....	VII-24-3
Map Loading Format Options.....	I-2-116
Map Loading Format Status Information.....	I-2-118
Map Loading Interruptions.....	I-2-119
MAP Modes/Data Products.....	VII-24-2
Map Option.....	VII-24-1
Map Orientation Option.....	VII-24-3
Map Theater Data Loading.....	I-2-116
MAP Update.....	VII-24-41
Maritime Mode Selection.....	VII-23-6
Master Caution.....	I-2-143
Master Caution Light.....	I-2-206
Master Mode Buttons.....	I-2-207
Master Modes.....	I-2-87
MC CONFIG Caution Display.....	I-2-183
MC/HYD ISOL Panel.....	I-2-87
MECH ON CAUTION.....	V-15-56
MECH ON Caution Display.....	I-2-57
MECH ON WITH AIL AND RUD OFF.....	V-15-57
MECH ON WITH AIL AND RUD OPERATIVE.....	V-15-56
Mechanical Linkage (MECH).....	I-2-54
Medium Altitude (15,000 Feet).....	III-10-19, III-10-28, III-10-36, III-10-42, III-10-46
Meet The Hornet.....	I-1-1
Memory Unit Mission Initialization (MUMI) Display.....	I-2-84
Menu Display (F/A-18A AFTER AFC 253 OR 292 AND F/A-18C/D).....	I-2-88
Menu Display (F/A-18A/B BEFORE AFC 253 OR 292).....	I-2-88
MENU Option (163985 AND UP).....	VII-24-5
Minimum Flight Qualifications.....	II-5-1
Minimum Ground Training Syllabus.....	II-5-1
Minimum Requirements.....	II-5-1
Missed Approach.....	III-9-7
Mission.....	I-1-2
Mission Analysis.....	IX-28-1
Mission Commander.....	IX-28-2

	Page No.
Mission Computer Failure.....	I-2-200
Mission Computer (MC) System.	I-2-76
MISSION COMPUTER NO. 1 FAILURE	VII-25-1
Mission Critique.	IX-28-4
Mission Data Entry.	I-2-84
Mission Data Entry (MC OFP 12A, 13C AND UP).....	I-2-84
Mission Evaluation.....	X-29-4
Mission Initialization.....	I-2-84
MISSION PLANNING.....	III-6-1
Mission Planning and Briefing.	IX-28-3
Mission Planning/Briefing	X-29-3
Mixed Mode Satellite Selection (MC OFP 15C AND UP).	VII-24-12
MK Option.	VII-24-4
Mode 4 Switch.....	VII-23-19
MODE Backup (Aircraft 163985 AND UP).....	VII-24-2
MODE Option (Aircraft 163985 AND UP).	VII-24-2
Mode Select Knob.	VII-23-8
Mode Selector Knob.	I-2-92
Mode Selector Switch.....	I-2-113, I-2-115
Mode Switch.....	I-2-139
Mode Switch (AIRCRAFT 163985 AND UP).....	I-2-39
Moving Map - Digital Map Set (DMS) (163985 AND UP).....	VII-24-1
MPCD (Aircraft 163985 AND UP BEFORE AFC 380).	I-2-92
MPCD/AMPCD (AIRCRAFT 163986 AND UP).	I-2-207
Multifunction Switch (MFS).....	I-2-209
Multipurpose Display Group.....	I-2-87

N

NAMT Systems Check.....	X-29-2
NATOPS Evaluation.....	X-29-1
NATOPS Evaluation Question Bank.	X-29-5
NATOPS EVALUATION QUESTION BANK.....	X-29-6
NATOPS Reevaluation.	X-29-1
NAV Check Display.....	VII-24-23
NAV Master Mode TDC Priority.	I-2-200
NAVDSG (Navigation) Designation.	VII-24-49
NAVDSG, O/S Option.	VII-24-5
NAVIGATION BACKUP.....	VII-25-3
NAVIGATION CONTROLS AND INDICATORS	VII-24-1
Navigation Controls and Indicators	VII-25-4
Navigation Functions.	VII-25-1
Navigation Master Mode.....	I-2-200
NAV/TAC Bank Limit Options (MC OFP 13C AND UP).	VII-24-42
Negative G Baffles.....	I-2-16
Night.....	II-5-1
Night Attack Configuration.	I-2-201
Night Brightness Selector.....	I-2-93
NIGHT FLYING.....	III-7-39

	Page No.
NIGHT OPERATIONS	III-8-14
NIGHT VISION DEVICE (NVD) OPERATIONS	III-9-11
Night/Day Brightness Selector.	I-2-94
Non-Avionic BIT.	I-2-181
Non-BIT Status.....	I-2-182
Non-Precision.....	VI-19-1
Normal and Plain Operation.....	VII-23-6
Normal Brake System.....	I-2-66
Normal Canopy Operation.	I-2-122
Normal Oxygen Supply (LOT 4-12).	I-2-154
Normal Takeoff.....	III-7-23
NOSEC Advisory (MC OFP 15C AND UP).	VII-24-12
NOSEC GPS Option.....	VII-24-30
Nosewheel Steering.	III-7-27
Nosewheel Steering System.	I-2-66
Nozzles.	I-4-1
Nuclear Consent Control Panel (Aircraft 163986 THRU 164738).	I-2-210
NVG Compatible Cockpit Lighting Retrofit.....	I-2-39
NWS CAUTION	V-15-60
NWS Caution Display.....	I-2-58

O

Object/Target Detection.	III-9-12
OBOGS Control Switch.	I-2-158
OBOGS DEGD Caution.....	I-2-157
OBOGS DEGD CAUTION	V-18-2
OBOGS DEGRADE/FAILURE (Cautions of any duration)	V-15-28
OBOGS Monitor.....	I-2-155
OCF Recovery.	IV-11-10 , V-18-5
OCF Recovery Procedures	V-15-62
OFF Flag.	I-2-73
Off/Brightness Control.....	I-2-94
OFT/WST Procedures Evaluation.....	X-29-2
Oil Pressure.....	I-4-2
On-Board Oxygen Generating System (OBOGS) (LOT 13 AND UP).	I-2-155
On/Off Selector Pushbutton.....	VII-23-18
Open Book Examination.	X-29-2, X-29-3
Operating Area Briefings.....	III-6-3
Optimum Endurance Area.	I-2-24
Optimum Range Area.....	I-2-24
Option Display Windows.....	I-2-111, VII-23-5
Option Select Pushbuttons.....	I-2-109, VII-23-5, VII-23-18
Oral Examination.....	X-29-2
Oral Examination and OFT Procedure Check (If Conducted).....	X-29-3
OUT-OF-CONTROL FLIGHT (OCF)	IV-11-7, V-15-60
Overfly Designation.....	VII-24-49
Overheat Condition.	I-2-192

	Page No.
OVRD Button.	I-2-183
OXY FLOW Knob.....	I-2-158
OXY LOW Display.	I-2-154
OXYGEN LEAK (Aircraft 161353 THRU 164068).....	V-15-26
Oxygen Quantity Gage.....	I-2-154
OXYGEN Supply Lever.	I-2-154
OXYGEN SYSTEM.....	I-2-154
Oxygen Test Button.	I-2-154

P

Parade.....	III-9-3
Parking Brake System.	I-2-68
Performing Electronic Remote Fill (ERF) with ERF Option.....	VII-23-14
Performing ERF with CST Option.....	VII-23-14
PERSONAL FLYING EQUIPMENT.....	II-5-1
Pilot Controls	I-2-45
Pilot Cueing.	I-2-109
Pilot In Command.	IX-28-3
Pilot Relief Modes.....	I-2-61
Pitch and Roll Trim Switch.....	I-2-47
Pitch Stability.	IV-11-3
Pitch Up.....	IV-11-4
Pitot Heater Switch.....	I-2-71
Pitot Pressure.....	I-2-71
PITOT STATIC PROBE DAMAGE.....	V-15-48
Pitot-Static System.	I-2-71
PLANING LINK FAILURE.....	V-16-6
POS Option Display.	VII-25-4
Position Keeping.....	VII-24-39
Position Lights.....	I-2-38
Position Updating.....	VII-24-40
Post Departure Dive Recovery.....	V-15-62
Post Flight Procedures	X-29-4
Post Flight Update.....	VII-24-41
POSTFLIGHT	III-7-32
POS/XXX Option.	VII-24-3
Power Knob.	VII-23-8
POWER PLANT SYSTEMS.....	I-2-1
POWER TRANSMISSION SHAFT (PTS) FAILURE.....	V-15-9
Precision.....	VI-19-1
Preflight.....	III-8-2, III-8-17 , III-10-2, III-10-30, III-10-37
PREFLIGHT CHECK	III-7-1
Preflight FCS initiated BIT.....	I-2-172
Preflight FCS initiated BIT Operation.....	I-2-172
Preflight FCS initiated BIT PASS/FAIL.....	I-2-173
Preflight/Line Operations.....	X-29-3
Preset Mode.	VII-23-9, VII-23-13

	Page No.
Pretakeoff.	IX-28-3
Primary Chase Responsibilities	III-9-10
Primary Flight Controls.....	I-2-43
Primary Radar Low Altitude Warning.....	I-2-72
Probe Unlock Caution Display.	I-2-22
Programming Automatic IFF Data.	VII-23-17
Prohibited Maneuvers.....	I-4-3
PTT Comm Select Panel.....	I-2-210
Pumps and Reservoirs.	I-2-42
Push to Test Switch.	I-2-73
Pushbutton Keyboard.....	I-2-111
Pushbuttons.	I-2-88
Push-to-Talk Foot Pedal Switches (F/A-18D night attack configured AIRCRAFT 163986 AND UP).	I-2-209

Q

QUALIFICATIONS AND CURRENCY REQUIREMENTS	II-5-1
Qualified.....	X-29-1

R

RADAR Altimeter Set (AN/APN-194(V)).	I-2-72
RADAR Altitude Hold.	I-2-63
Radar Elevation Control.	I-2-209
Rear Cockpit.....	I-2-204
REAR COCKPIT PROCEDURES (F/A-18B/D)	III-7-36
RECCE Configuration.	I-2-201
RECCE Control Panel.	I-2-210
Recorder On Light.	I-2-114, I-2-115
Records and Reports.....	X-29-5
Recovery.....	IX-28-4
Refueling Technique.	III-9-6
Repetition of Preflight FCS initiated BIT.....	I-2-173
Requirements For Various Flight Phases.....	II-5-1
RESTART	V-15-5
Reversion.	I-2-163
RF/CBL (SINS) Alignment.	VII-24-13
R-LIM OFF Caution Display.....	I-2-58
RPM.....	I-4-1
RUD OFF Caution Display.....	I-2-58
Rudder Pedal Adjust Lever.	I-2-45
Rudder Pedals.	I-2-45
Rudder Trim Knob.	I-2-47
Running Preflight FCS Initiated BIT After Flight.....	I-2-173

S

Sample Problem CG for F/A-18 C Gear Up.	IV-11-24
--	----------

Sample Problem CG for F/A-18C Gear Down.	IV-11-23
SCL Option	VII-24-4
Scratchpad Window.....	I-2-111, VII-23-4
Seat Bucket Position Switch.	I-2-133
Seat Caution Mode Switch (F/A-18D).....	I-2-205
Seat Position Sensor (SPS).....	I-2-188
Seat SJU-17(V)1/A, 2/A, and 9/A, and SJU-17A(V)1/A, 2/A, and 9/A.	I-2-129
Seat Survival Kit (SKU-10/A).....	I-2-132
SEAWATER Activated Release System (SEAWARS).	I-2-130
SEAWATER ENTRY	V-17-5
Secondary Flight Controls.....	I-2-54
SECONDARY POWER SYSTEM.....	I-2-26
Secondary Radar Low Altitude Warning.	I-2-73
Section Approaches/Landing.	III-9-5
SECTION CCA	III-8-17
Section Landing.....	III-9-5
Section Takeoff.	III-9-1
SECURE SPEECH SYSTEM (KY-58)	VII-23-7
Selective Jettison.	I-2-142
Selective Jettison Knob.	I-2-142
Sensor Control Panel.....	VII-24-6
SENSORS Option.	VII-24-5
Sensors/Modes.....	I-2-150
SEQ # Option.	VII-24-5
SERVICING	I-3-1
Setting the Alert.	III-9-13
Shipboard Taxi/Takeoff Checks	III-10-14, III-10-32
Shorebased Takeoff Checks	III-10-17, III-10-34
SHORT AIRFIELD FOR TACTICAL SUPPORT (SATS) PROCEDURES.....	III-9-12
Short Field Arrestment.	V-16-16
Shoulder Harness Inertia Reel.	I-2-130
Shoulder Harness Lock/Unlock Handle.	I-2-131
Signal Data Computer (F/A-18C/D).....	I-2-112
SINGGARS OPERATION AND OPTIONS	VII-23-13
SINGLE ENGINE APPROACH AND LANDING.....	V-16-2
SINGLE ENGINE FAILURE IN LANDING CONFIGURATION.....	V-16-1, V-18-5
Single Engine Operation.	IV-11-17
Single Engine Waveoff.	IV-11-17
SINGLE ENGINE WAVEOFF/BOLTER	V-16-2
SINGLE L BLEED or R BLEED WARNING LIGHT.....	V-18-1
Situational Awareness.....	IX-28-2
SJU-5/A and 6/A Seat.	I-2-128
SLEW Option (163985 AND UP).	VII-24-3
Slew Pushbutton.....	I-2-92
SMS Initiated BIT.....	I-2-173
Solo.....	II-5-1
SPD BRK Light.	I-2-60
SPECIAL CONSIDERATIONS	IX-28-5

	Page No.
Speedbrake.	I-2-59
Speedbrake Switch.....	I-2-60
Spin.	V-15-61
Spin Recovery.	IV-11-14
Spin Recovery Command Arrows.....	IV-11-15
Spin Recovery Mode (SRM).	IV-11-14
Spin Recovery Switch and Light.	I-2-49
Spin Recovery System.	I-2-49
Spins.	IV-11-12
Stalls in HALF or FULL Flaps.....	IV-11-1
Standby Airspeed Indicator.	I-2-72
Standby Altimeter.	I-2-72
Standby Attitude Reference Indicator.....	I-2-71, VII-25-2
Standby Attitude Reference Indicator Controls and Indicators.	VII-25-2
Standby Magnetic Compass.....	I-2-76
Standby Rate of Climb Indicator.....	I-2-74
Start Cycle.....	I-2-29
Start-up BIT (SBIT).....	I-2-190
Static Power Inverter.	VII-25-2
Static Pressure.....	I-2-71
Station Jettison Select Buttons.....	I-2-142
Status Messages.....	I-2-191
Status Monitoring Backup.	I-2-182
Status Monitoring Functions.....	VII-25-1
STATUS MONITORING SUBSYSTEM.....	I-2-160
Steering.....	VII-24-42
Steering Information.....	I-2-87
Stick Force.	IV-11-3
Stop Button.	I-2-181
Stored Heading (STD HDG) Alignment.....	VII-24-17
Strobe Lights.	I-2-39
STUCK THROTTLE/ ENGINE FAILS TO RESPOND.....	V-15-2
Sub-area.	X-29-2
Suit Ventilation System.....	I-2-141
Survivability.....	I-2-10
Survival Kit (SKU-3/A).....	I-2-131
S/W CONFIG Caution Display.....	I-2-183
Symbology Control.....	I-2-94
System BIT Steps.....	I-2-171

T

TACAN BIT.....	VII-24-55
TACAN Mode Selection.	VII-24-56
TACAN Position Keeping.....	VII-24-56
TACAN Position Updating.....	VII-24-57
TACAN Programming.	VII-24-56
TACAN Steering.....	VII-24-57
TACAN (Tactical Air Navigation).....	VII-24-55

	Page No.
TACAN Volume Control Knob.....	VII-24-10
TACTICAL AIRCRAFT MOVING MAP CAPABILITY (TAMMAC).....	I-2-115
TAKEOFF	III-7-23 , III-9-9 , III-10-18, III-10-35, III-10-42 , VI-22-2
Takeoff (*)	X-29-4
Takeoff and Landing Characteristics.	IV-11-1
Takeoff, Landing, and Catapult Launch with High Lateral Weight Asymmetries.	IV-11-2
Takeoff/Departure.	IX-28-4
TAMMAC Status Monitoring.	I-2-116
Tank Pressurization Caution Display.....	I-2-11
Target Chase Procedures.....	III-9-10
TAWS - Terrain Awareness Warning System (SCS 17C AND UP).	I-2-145
TAWS Modes.....	I-2-146
TAWS Operation.	I-2-146
TAWS Warnings.....	I-2-147
Taxi.	III-7-22, III-8-2, III-8-17 , III-10-14, III-10-27, III-10-41, III-10-44, III-10-45, X-29-4
TCN Option.	VII-24-6
TCN/AC MGVAR Option (MC OFP 13C AND UP).....	VII-24-56
TDC/DC Switch.	I-2-209
Temperature Knobs.....	I-2-139
TGT (Target) Programming.....	VII-24-27
Throttles.....	I-2-3
Throttles (AIRCRAFT 161354 THRU 163778 and trainer configured 163986 AND UP).	I-2-207
Time Set Mode.	I-2-75
TIMEUFC Option.	VII-24-5
T/O Trim Button.	I-2-47
TOT (Time On Target) Programming.....	VII-24-27
Total Temperature Probe.	I-2-160
Touchdown.	III-7-27
Tow Banner Adapter Limitations.	I-4-9
Traffic Control Couple.	VII-24-69
Trailing Edge Flap Failures.	IV-11-19
Training Configuration.....	I-2-201
Transformer-Rectifier Failure.....	V-15-19
Transmission or Reception of Hopset or Lockout Set.....	VII-23-14
Transmitting or Receiving Time Using UFC HQ Display.	VII-23-10
Transmitting, Receiving, or Restarting Time Using Fixed Frequency Menu Format.....	VII-23-10
Transponder Control Via the UFC.....	VII-23-15
Transponder Operation.	VII-23-15
True/Magnetic Heading Selection.....	VII-24-29
TURBULENT AIR AND THUNDERSTORM OPERATION	VI-20-4
Typical ACL Approach.....	VII-24-73

U

UFC.	VII-23-3, VII-23-18, VII-24-1
-----------	-------------------------------

	Page No.
UNCOMMANDED FUEL DUMP	V-15-18
UNCOMMANDED PITCH AND ROLL EXCURSIONS	V-15-51
Uncommanded Roll Excursion with Aileron Surface Missing/Damaged.	V-15-52
Undesignate Button.....	I-2-209
Unit Commanders Authority.....	II-5-2
Unqualified.....	X-29-1
UNRESPONSIVE ENGINE.....	V-15-1
UPDT Option.....	VII-24-4
Upfront Control.....	I-2-207
Upfront Control (UFC).	I-2-109
Using HQ Time Options.	VII-23-10
Using Manual Data Fill Mode.....	VII-23-11
Using Time Options in SG Display.....	VII-23-13
Using Training Net.	VII-23-12
Utility Flood Light.....	I-2-40
UTM WYPT Data Entry.	VII-24-25

V

Valves.	I-2-42
VEC Option.	VII-24-6
Vent Fuel Caution Display.....	I-2-11
VHF/UHF AND MIDS COMMUNICATION SYSTEM	VII-23-1
VHF/UHF/MIDS Controls and Indicators.....	VII-23-3
Video Tape Recorder.....	I-2-113
Video Tape Recorders.....	I-2-114
Video Tape Recording System (VTRS) (Aircraft 161353 THRU 164912 BEFORE AFC 207)..	I-2-112
Visual Warnings.	I-2-148
Voice Alert.....	I-2-58
Voice Alert System.....	I-2-144
Voice Warnings.	I-2-147
Volume Control After AFC 268.	VII-23-1
Volume Control Before AFC 268.	VII-23-1
Volume Control Knob.....	VII-23-8
Volume Control Knobs.....	I-2-204
Volume Control Panel.....	I-2-210
Volume Controls.....	I-2-112

W

WAIVERS.....	II-5-2
WARNING/CAUTION Lights Knob.....	I-2-41
Warning/Caution/Advisory Lights and Displays.	I-2-143
Warnings, Cautions, and Advisories.	V-12-1
Waveoff.....	III-7-30, III-8-9, III-9-12
Waypoint, OAP, Mark Point Selection.	VII-24-5
Waypoint/OAP Course Line Steering.....	VII-24-42
Waypoint/OAP Direct Great Circle Steering.....	VII-24-42
Waypoint/OAP Sequence Programming.....	VII-24-28

Page
No.

Waypoint/Offset Aimpoint Programming..... VII-24-23

Waypoints, Offset Aimpoints (OAP) and Offsets. VII-24-23

Waypoint/TACAN Steering Area..... I-2-26

Weapons and Sensors Officer. IX-28-3

Weather Conditions..... III-9-11

Weight Limitations. I-4-8

Weight-On-Wheels (WOW) System. I-2-64

Wet Runway Landing..... III-7-29

Windshield Anti-Ice and Rain Removal System. I-2-141

Windshield Anti-Ice/Rain Switch..... I-2-141

Windshield Hot Display..... I-2-141

Wing Fold Handle. I-2-70

WING FOLD SYSTEM I-2-69

WOW SYSTEM FAILURE..... V-14-7

WYPT, OAP Option. VII-24-4

Y

YCODE Advisory (MC OFP 12A, 15C AND UP)..... VII-24-12

Z

Zulu Time Of Day (ZTOD)..... VII-24-38

FOLDOUTS

TABLE OF CONTENTS

	PAGE NO
Figure FO-1. Front Cockpit F/A-18A/B.....	FO-3
Figure FO-2. Rear Cockpit F/A-18B	FO-7
Figure FO-3. Front Cockpit F/A-18C/D Aircraft 163427 thru 163782	FO-11
Figure FO-4. Rear Cockpit F/A-18D Aircraft 163434 thru 163778	FO-15
Figure FO-5. Front Cockpit F/A-18C/D Aircraft 163985 And Up	FO-19
Figure FO-6. Rear Cockpit F/A-18D Aircraft 163986 And Up	FO-23
Figure FO-7. Electrical System (Bus Power) Aircraft 161353 thru 161528.....	FO-27
Figure FO-8. Electrical System (Bus Power) Aircraft 161702 And Up.....	FO-29
Figure FO-9. Ejection Seat (SJU-5/6)	FO-31
Figure FO-10. Ejection Seat (SJU-17 (V) 1/A-2/A)	FO-33
Figure FO-11. Fuel System	FO-37
Figure FO-12. Environmental Control System	FO-43

FOLDOUT SECTION

The purpose of the Foldout Section is to make these illustrations available for ready reference while reading the associated text. The illustrations are referenced from several sections of the manual and are referred to in the text as (see figure FO-, foldout section).

The System Foldouts are extremely simplified to provide a general understanding of very complicated systems. They do not contain all components, circuits, etc. For a complete diagram(s) of a system, refer to the applicable maintenance publication.

1. LOCK SHOOT LIGHTS
2. HEAD UP DISPLAY (HUD)
3. ANGLE OF ATTACK INDEXER LIGHTS
4. LEFT ENGINE FIRE WARNING/EXTINGUISHER LIGHT
5. MASTER CAUTION LIGHT
6. LEFT WARNING/CAUTION/ADVISORY LIGHTS
7. HUD VIDEO CAMERA CONTROL
8. RIGHT WARNING/CAUTION/ADVISORY LIGHTS
9. AUXILIARY POWER UNIT FIRE WARNING/EXTINGUISHER LIGHT
10. RIGHT ENGINE FIRE WARNING/EXTINGUISHER LIGHT
11. CANOPY INTERNAL JETTISON HANDLE
12. MASTER ARM PANEL
13. LEFT DIGITAL DISPLAY INDICATOR (DDI)
14. UPFRONT CONTROL PANEL (UFC)
15. RIGHT DIGITAL DISPLAY INDICATOR (DDI)
16. MAP GAIN/SPIN RECOVERY PANEL
17. EMERGENCY JETTISON BUTTON
18. HUD CONTROL PANEL
19. STANDBY MAGNETIC COMPASS
20. STATION JETTISON SELECT

INSTRUMENT PANEL

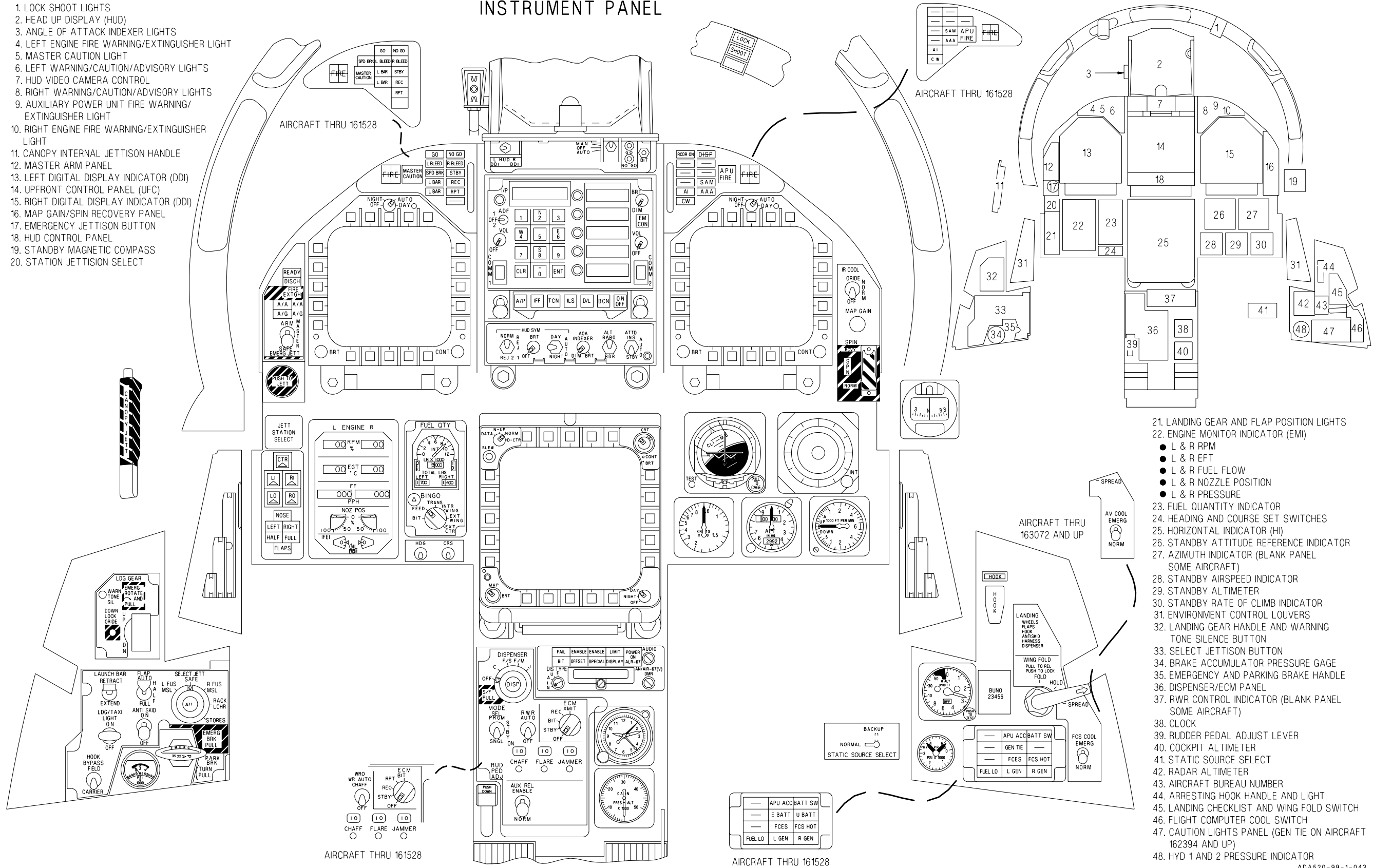

21. LANDING GEAR AND FLAP POSITION LIGHTS
22. ENGINE MONITOR INDICATOR (EMI)
 - L & R RPM
 - L & R EGT
 - L & R FUEL FLOW
 - L & R NOZZLE POSITION
 - L & R PRESSURE
23. FUEL QUANTITY INDICATOR
24. HEADING AND COURSE SET SWITCHES
25. HORIZONTAL INDICATOR (HI)
26. STANDBY ATTITUDE REFERENCE INDICATOR
27. AZIMUTH INDICATOR (BLANK PANEL SOME AIRCRAFT)
28. STANDBY AIRSPEED INDICATOR
29. STANDBY ALTIMETER
30. STANDBY RATE OF CLIMB INDICATOR
31. ENVIRONMENT CONTROL LOUVERS
32. LANDING GEAR HANDLE AND WARNING TONE SILENCE BUTTON
33. SELECT JETTISON BUTTON
34. BRAKE ACCUMULATOR PRESSURE GAGE
35. EMERGENCY AND PARKING BRAKE HANDLE
36. DISPENSER/ECM PANEL
37. RWR CONTROL INDICATOR (BLANK PANEL SOME AIRCRAFT)
38. CLOCK
39. RUDDER PEDAL ADJUST LEVER
40. COCKPIT ALTIMETER
41. STATIC SOURCE SELECT
42. RADAR ALTIMETER
43. AIRCRAFT BUREAU NUMBER
44. ARRESTING HOOK HANDLE AND LIGHT
45. LANDING CHECKLIST AND WING FOLD SWITCH
46. FLIGHT COMPUTER COOL SWITCH
47. CAUTION LIGHTS PANEL (GEN TIE ON AIRCRAFT 162394 AND UP)
48. HYD 1 AND 2 PRESSURE INDICATOR

Figure FO-1. Front Cockpit F/A-18A/B Aircraft (Sheet 1 of 2)

1. FIRE TEST PANEL
2. GROUND POWER PANEL
3. THROTTLE QUADRANT
4. EXTERIOR LIGHTS PANEL
5. FUEL PANEL
6. FLIGHT CONTROL SYSTEM PANEL
7. COMMUNICATION PANEL
8. LIQUID OXYGEN QUANTITY INDICATOR
9. ANTI-G VALVE
10. PILOT SERVICES PANEL
 - ANTI-G
 - SUIT VENT
 - OXYGEN
11. COMMUNICATION CONNECTION
12. MISSION COMPUTER AND HYDRAULIC ISOLATE PANEL
13. ANTENNA SELECT PANEL

NOTE

- Radio override switch on F/A-18B aircraft only
14. AUXILIARY POWER UNIT PANEL
 15. GENERATOR TIE CONTROL SWITCH (SOME AIRCRAFT)
 16. ECM DISPENSER BUTTON
 17. GROUND POWER DECAL
 18. LEFT ESSENTIAL CIRCUIT BREAKERS
 19. CANOPY MANUAL HANDLE AND DRIVE
 20. NUCLEAR WEAPON SWITCH

LEFT CONSOLE

RIGHT CONSOLE

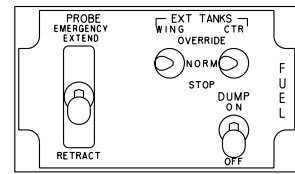

AIRCRAFT THRU 161528

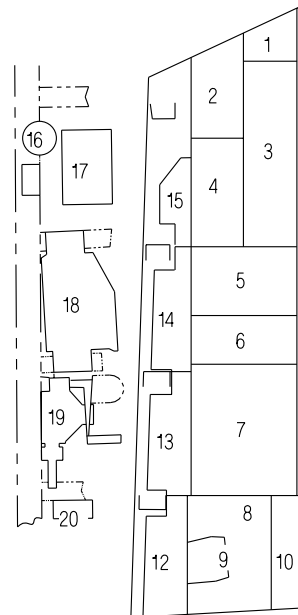

Q1

F/A-18B

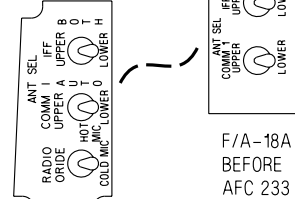

F/A-18A BEFORE AFC 233

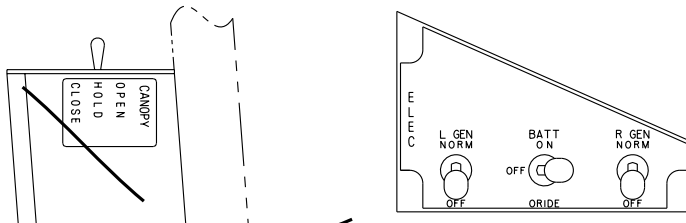
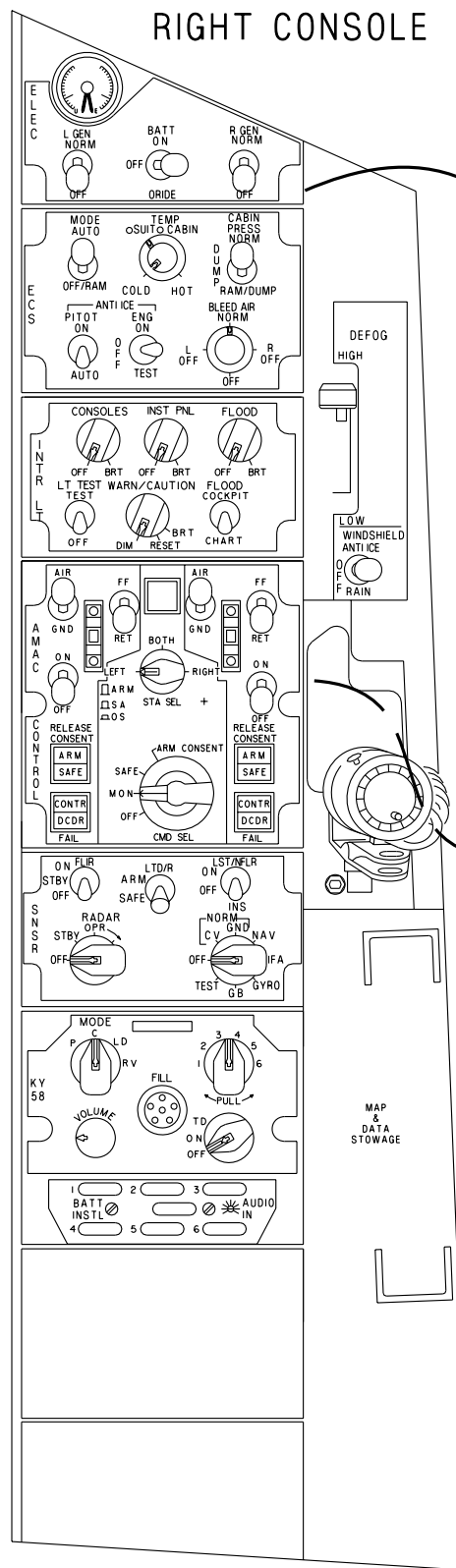
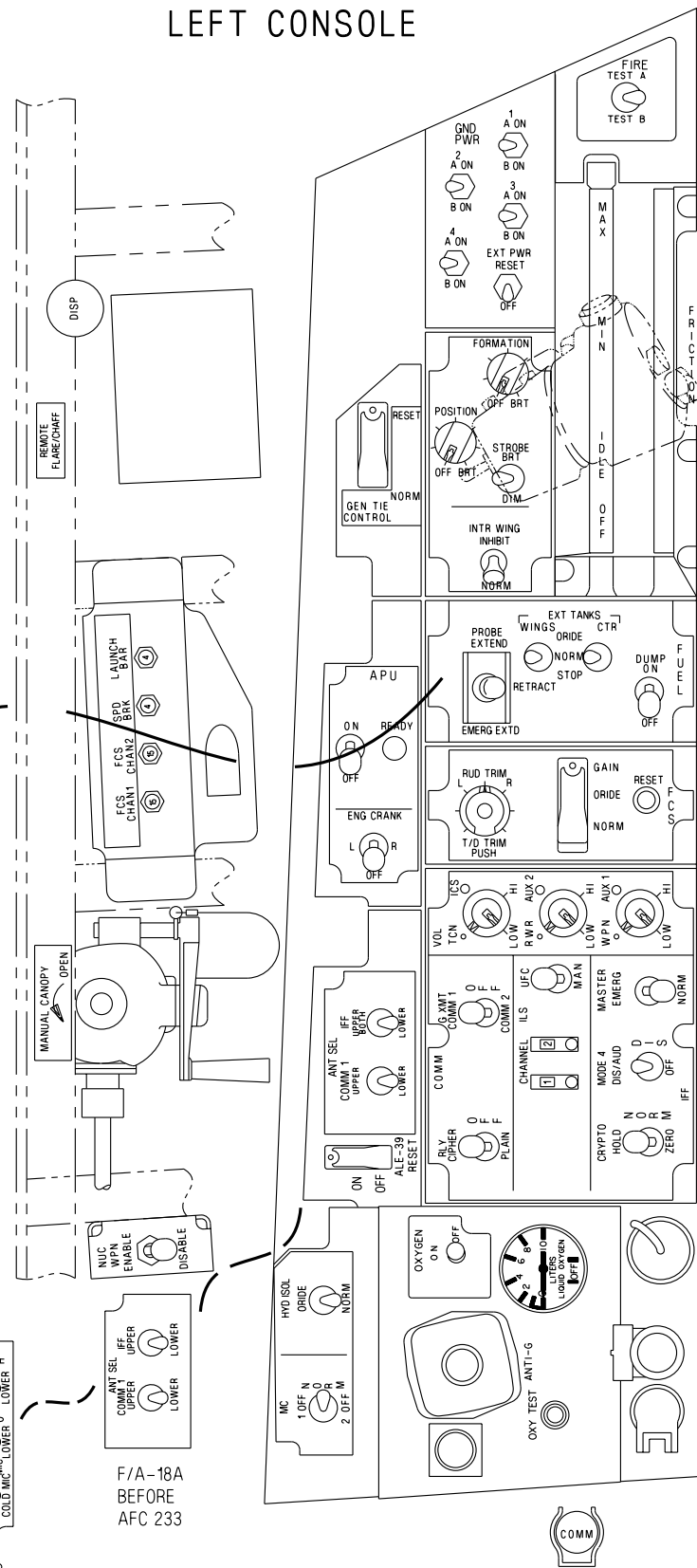

AIRCRAFT THRU 161528

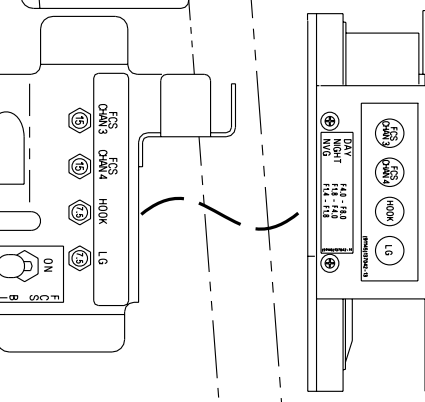

AFTER AFC 194

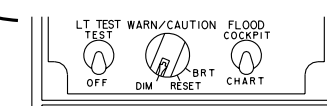

WITHOUT AMAC INSTALLED

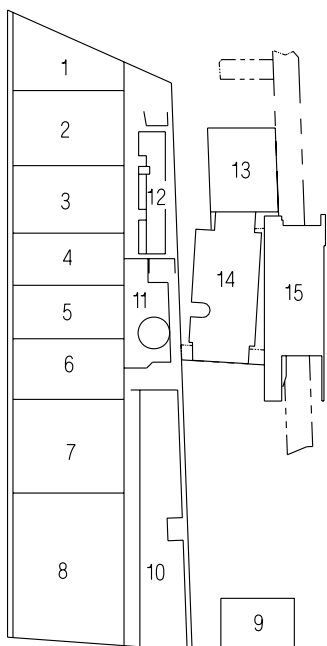
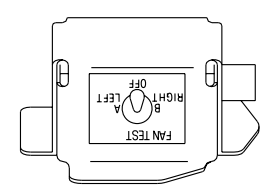

1. ELECTRICAL POWER PANEL
2. ENVIRONMENT CONTROL SYSTEM PANEL
3. INTERIOR LIGHTS PANEL
4. AMAC CONTROL
5. SENSOR PANEL
6. KY-58 CONTROL
7. BLANK PANEL
8. BLANK PANEL
9. FAN TEST SWITCH
10. MAP AND DATA CASE
11. UTILITY LIGHT
12. DEFOG PANEL
13. INTERNAL CANOPY SWITCH
14. RIGHT ESSENTIAL CIRCUIT BREAKERS
15. VIDEO CAMERA

Figure FO-1. Front Cockpit F/A-18A/B Aircraft (Sheet 2 of 2)

INSTRUMENT PANEL

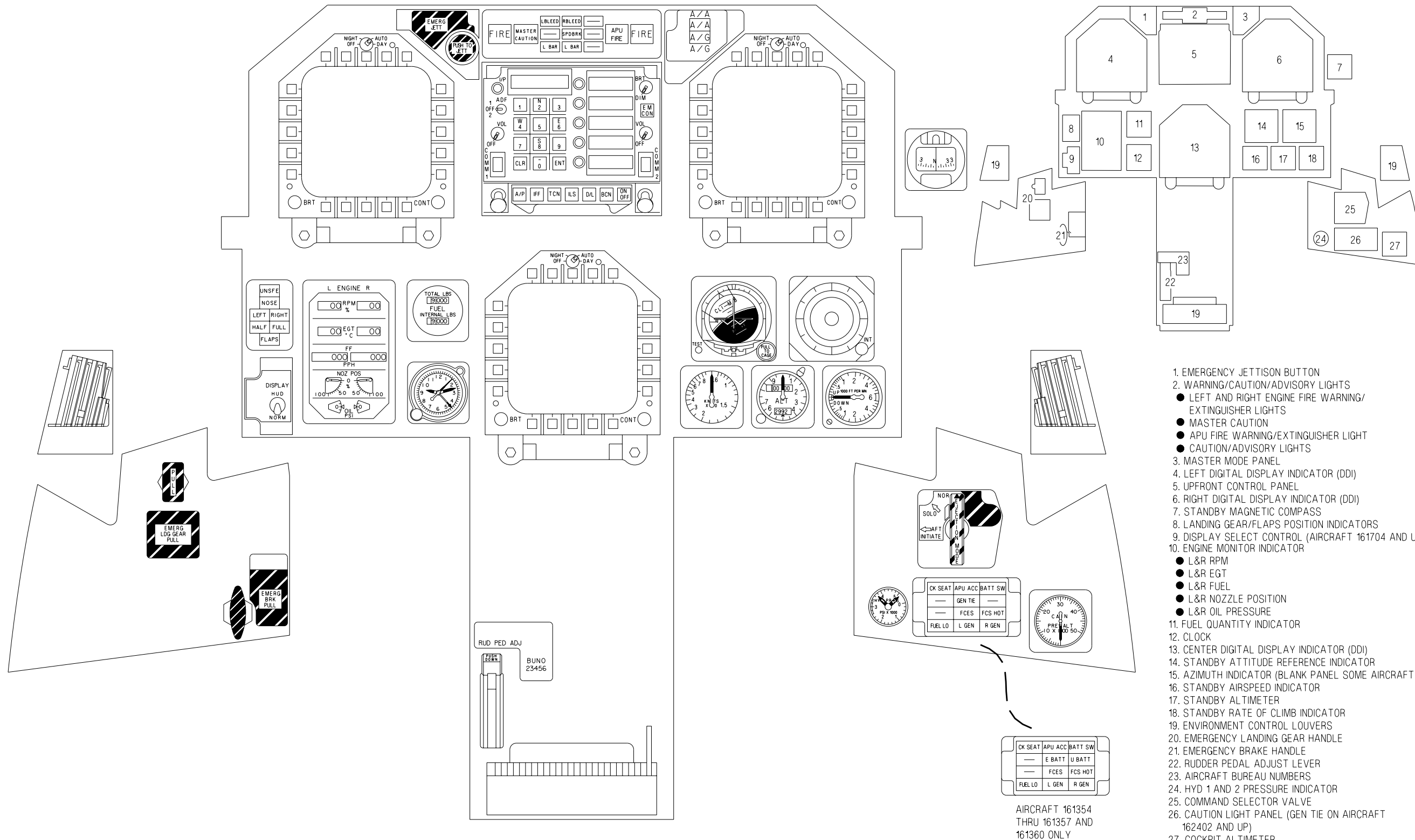

1. EMERGENCY JETTISON BUTTON
2. WARNING/CAUTION/ADVISORY LIGHTS
 - LEFT AND RIGHT ENGINE FIRE WARNING/ EXTINGUISHER LIGHTS
 - MASTER CAUTION
 - APU FIRE WARNING/EXTINGUISHER LIGHT
 - CAUTION/ADVISORY LIGHTS
3. MASTER MODE PANEL
4. LEFT DIGITAL DISPLAY INDICATOR (DDI)
5. UPFRONT CONTROL PANEL
6. RIGHT DIGITAL DISPLAY INDICATOR (DDI)
7. STANDBY MAGNETIC COMPASS
8. LANDING GEAR/FLAPS POSITION INDICATORS
9. DISPLAY SELECT CONTROL (AIRCRAFT 161704 AND UP)
10. ENGINE MONITOR INDICATOR
 - L&R RPM
 - L&R EGT
 - L&R FUEL
 - L&R NOZZLE POSITION
 - L&R OIL PRESSURE
11. FUEL QUANTITY INDICATOR
12. CLOCK
13. CENTER DIGITAL DISPLAY INDICATOR (DDI)
14. STANDBY ATTITUDE REFERENCE INDICATOR
15. AZIMUTH INDICATOR (BLANK PANEL SOME AIRCRAFT)
16. STANDBY AIRSPEED INDICATOR
17. STANDBY ALTIMETER
18. STANDBY RATE OF CLIMB INDICATOR
19. ENVIRONMENT CONTROL LOUVERS
20. EMERGENCY LANDING GEAR HANDLE
21. EMERGENCY BRAKE HANDLE
22. RUDDER PEDAL ADJUST LEVER
23. AIRCRAFT BUREAU NUMBERS
24. HYD 1 AND 2 PRESSURE INDICATOR
25. COMMAND SELECTOR VALVE
26. CAUTION LIGHT PANEL (GEN TIE ON AIRCRAFT 162402 AND UP)
27. COCKPIT ALTIMETER

AIRCRAFT 161354
THRU 161357 AND
161360 ONLY

Figure FO-2. Rear Cockpit F/A-18B Aircraft
(Sheet 1 of 2)

LEFT CONSOLE

1. BLANK PANEL
2. THROTTLE QUADRANT
3. BLANK PANEL
4. BLANK PANEL
5. PILOT SERVICE PANEL
 - ANTI-G
 - SUIT VENT
 - OXYGEN
6. LIQUID OXYGEN QUANTITY INDICATOR
7. ANIT-G VALVE
8. AN/ALE-39 PROGRAMMER
9. CANOPY INTERNAL JETTISON HANDLE
10. VOLUME CONTROL

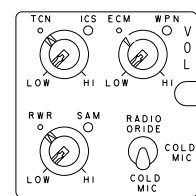

AIRCRAFT 161354
THRU 161357 AND
161360 ONLY

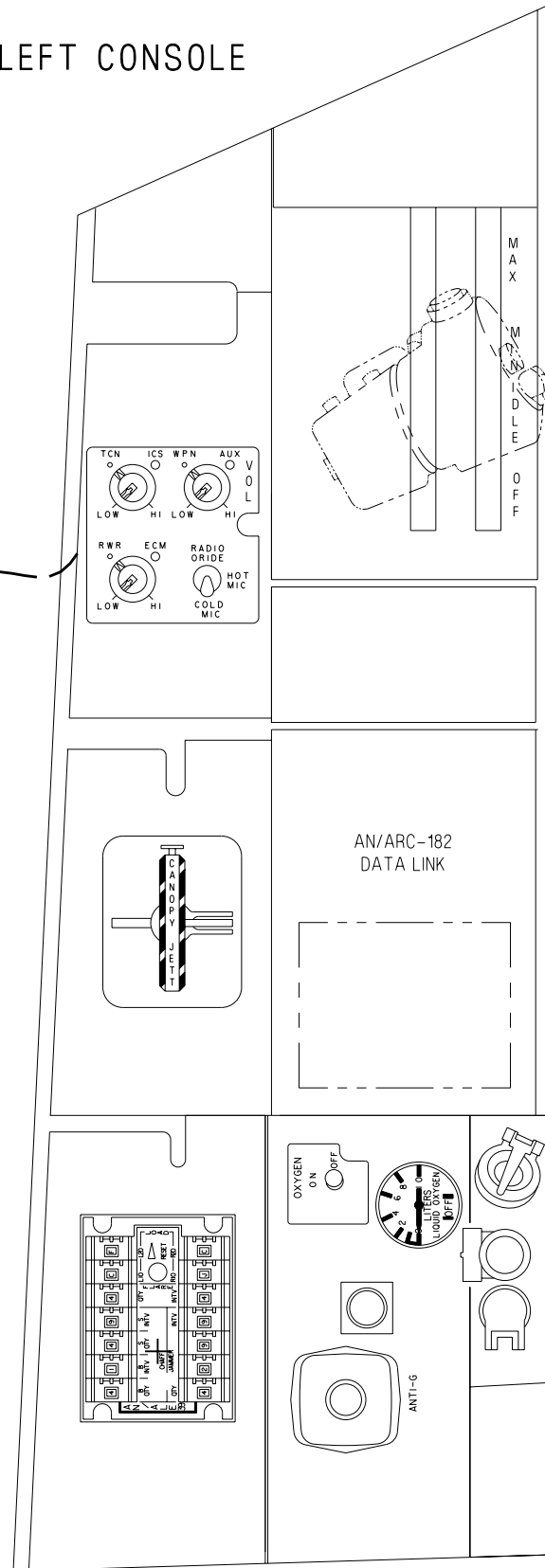
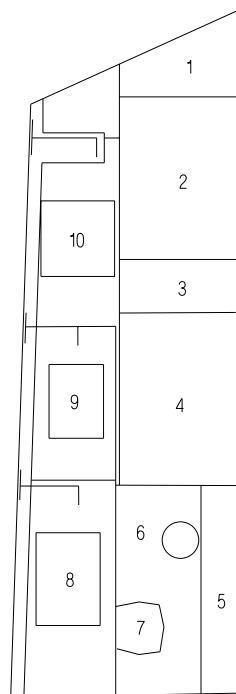

RIGHT CONSOLE

1. BLANK PANEL
2. INTERNAL LIGHTS PANEL
3. BLANK PANEL
4. BLANK PANEL
5. BLANK PANEL
6. BLANK PANEL
7. MAP AND DATA CASE
8. UTILITY LIGHT
8. FAN TEST SWITCH
10. BLANK PANEL

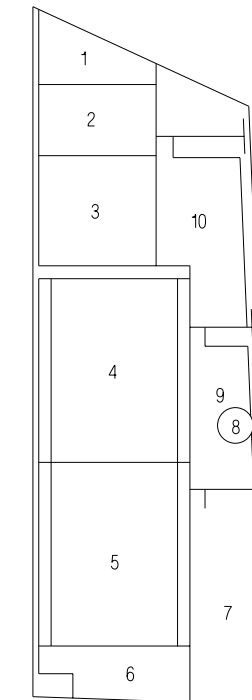
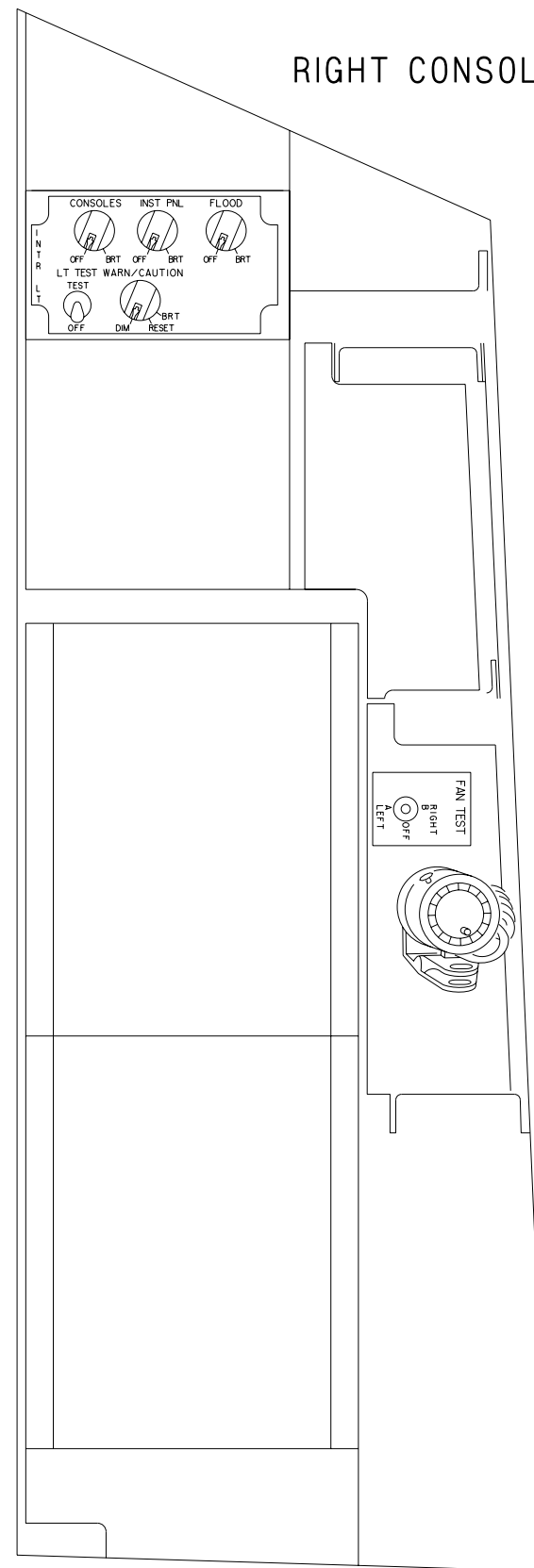
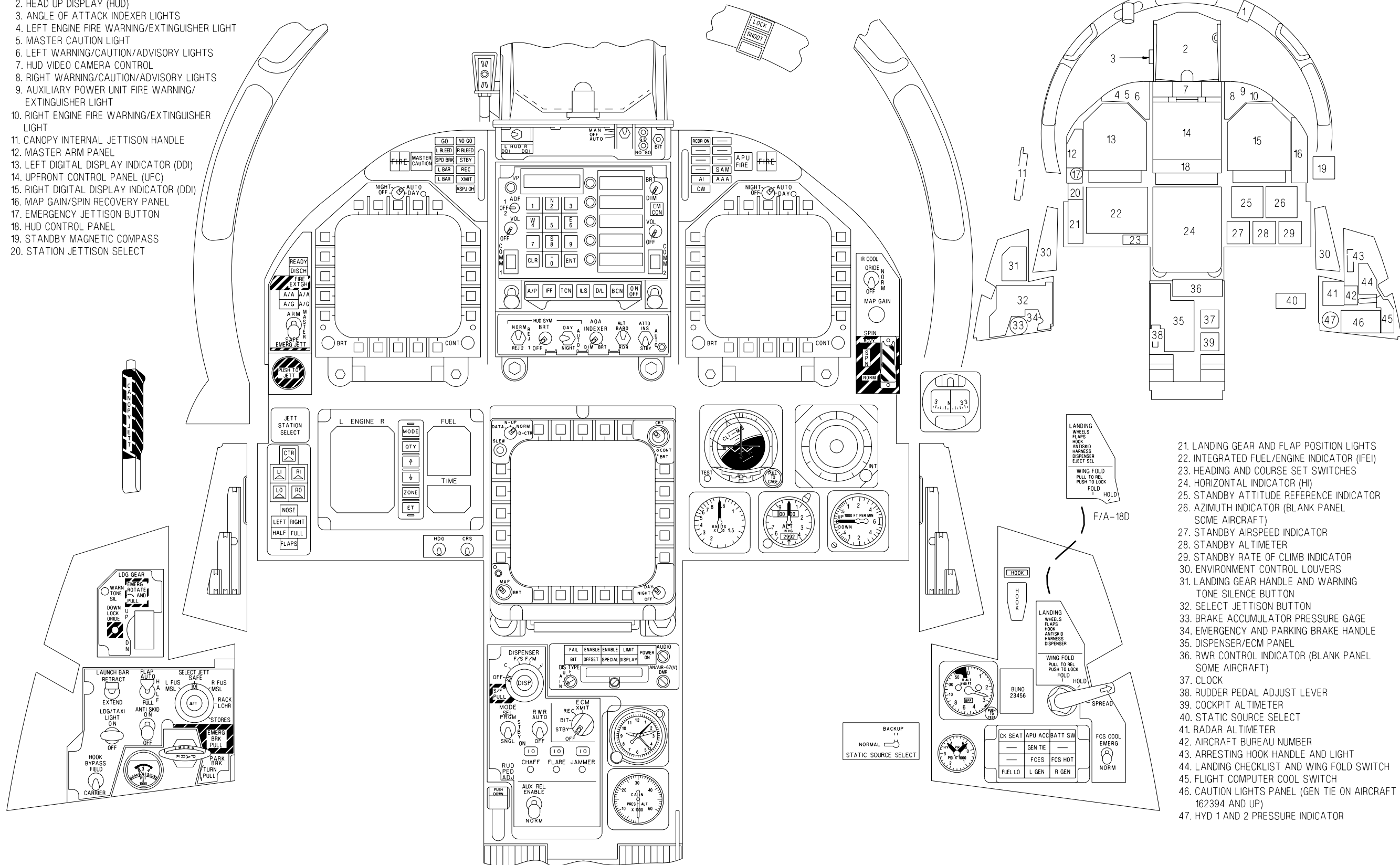

Figure FO-2. Rear Cockpit F/A-18B Aircraft
(Sheet 2 of 2)

1. LOCK SHOOT LIGHTS
2. HEAD UP DISPLAY (HUD)
3. ANGLE OF ATTACK INDEXER LIGHTS
4. LEFT ENGINE FIRE WARNING/EXTINGUISHER LIGHT
5. MASTER CAUTION LIGHT
6. LEFT WARNING/CAUTION/ADVISORY LIGHTS
7. HUD VIDEO CAMERA CONTROL
8. RIGHT WARNING/CAUTION/ADVISORY LIGHTS
9. AUXILIARY POWER UNIT FIRE WARNING/EXTINGUISHER LIGHT
10. RIGHT ENGINE FIRE WARNING/EXTINGUISHER LIGHT
11. CANOPY INTERNAL JETTISON HANDLE
12. MASTER ARM PANEL
13. LEFT DIGITAL DISPLAY INDICATOR (DDI)
14. UPFRONT CONTROL PANEL (UFC)
15. RIGHT DIGITAL DISPLAY INDICATOR (DDI)
16. MAP GAIN/SPIN RECOVERY PANEL
17. EMERGENCY JETTISON BUTTON
18. HUD CONTROL PANEL
19. STANDBY MAGNETIC COMPASS
20. STATION JETTISON SELECT

INSTRUMENT PANEL



21. LANDING GEAR AND FLAP POSITION LIGHTS
22. INTEGRATED FUEL/ENGINE INDICATOR (IFEI)
23. HEADING AND COURSE SET SWITCHES
24. HORIZONTAL INDICATOR (HI)
25. STANDBY ATTITUDE REFERENCE INDICATOR
26. AZIMUTH INDICATOR (BLANK PANEL SOME AIRCRAFT)
27. STANDBY AIRSPEED INDICATOR
28. STANDBY ALTIMETER
29. STANDBY RATE OF CLIMB INDICATOR
30. ENVIRONMENT CONTROL LOUVERS
31. LANDING GEAR HANDLE AND WARNING TONE SILENCE BUTTON
32. SELECT JETTISON BUTTON
33. BRAKE ACCUMULATOR PRESSURE GAGE
34. EMERGENCY AND PARKING BRAKE HANDLE
35. DISPENSER/ECM PANEL
36. RWR CONTROL INDICATOR (BLANK PANEL SOME AIRCRAFT)
37. CLOCK
38. RUDDER PEDAL ADJUST LEVER
39. COCKPIT ALTIMETER
40. STATIC SOURCE SELECT
41. RADAR ALTIMETER
42. AIRCRAFT BUREAU NUMBER
43. ARRESTING HOOK HANDLE AND LIGHT
44. LANDING CHECKLIST AND WING FOLD SWITCH
45. FLIGHT COMPUTER COOL SWITCH
46. CAUTION LIGHTS PANEL (GEN TIE ON AIRCRAFT 162394 AND UP)
47. HYD 1 AND 2 PRESSURE INDICATOR

Figure FO-3. Front Cockpit F/A-18C/D Aircraft 163427 thru 163782 (Sheet 1 of 2)

ADA520-352-1-043

1. FIRE TEST PANEL
2. GROUND POWER PANEL
3. THROTTLE QUADRANT
4. EXTERIOR LIGHTS PANEL
5. FUEL PANEL
6. FLIGHT CONTROL SYSTEM PANEL
7. COMMUNICATION PANEL
8. LIQUID OXYGEN QUANTITY INDICATOR
9. ANTI-G VALVE
10. PILOT SERVICES PANEL
 - ANTI-G
 - SUIT VENT
 - OXYGEN
11. COMMUNICATION CONNECTION
12. MISSION COMPUTER AND HYDRAULIC ISOLATE PANEL
13. ANTENNA SELECT PANEL

NOTE

Radio override switch on F/A-18D aircraft only

14. AUXILIARY POWER UNIT PANEL
15. GENERATOR TIE CONTROL SWITCH (SOME AIRCRAFT)
16. ECM DISPENSER BUTTON
17. GROUND POWER DECAL
18. LEFT ESSENTIAL CIRCUIT BREAKERS
19. CANOPY MANUAL HANDLE AND DRIVE
20. NUCLEAR WEAPON SWITCH

LEFT CONSOLE

RIGHT CONSOLE

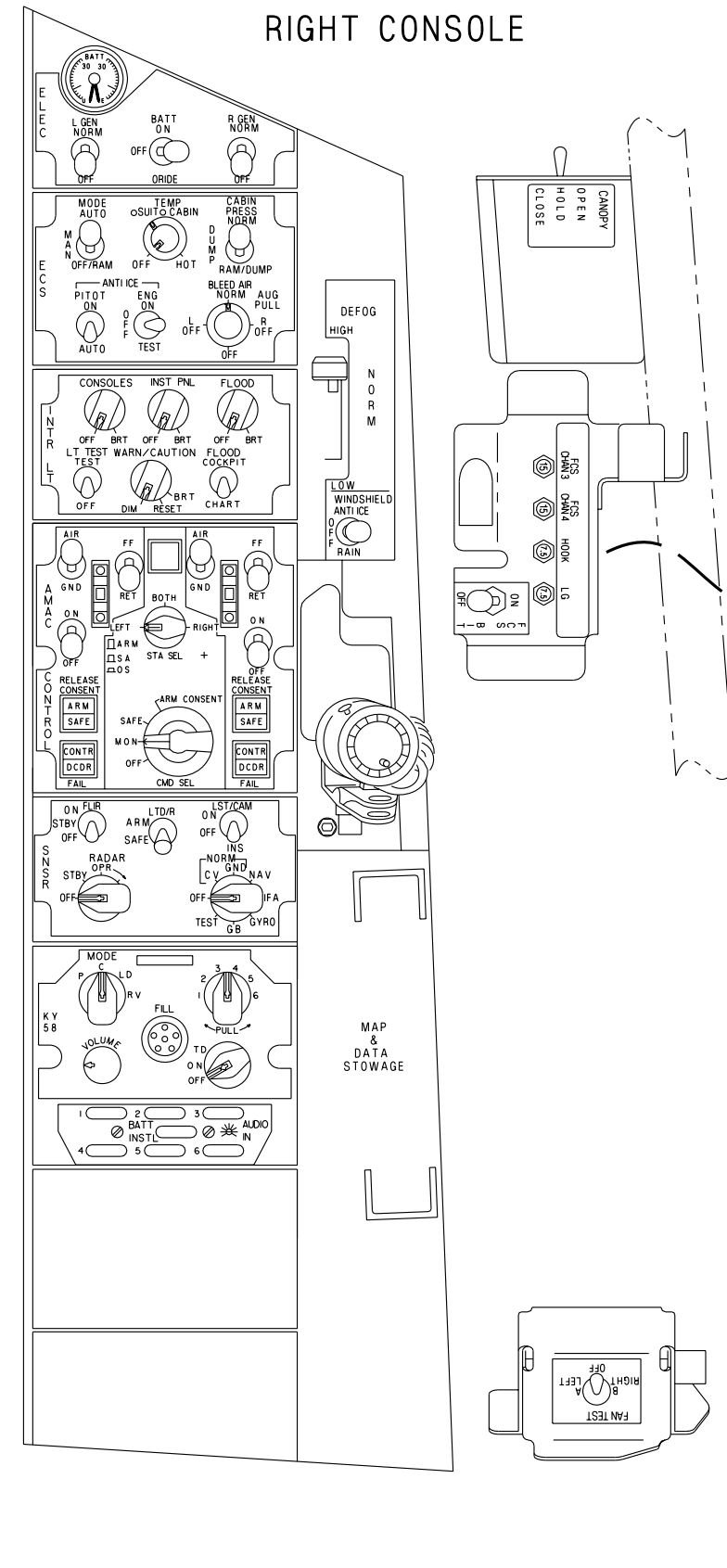
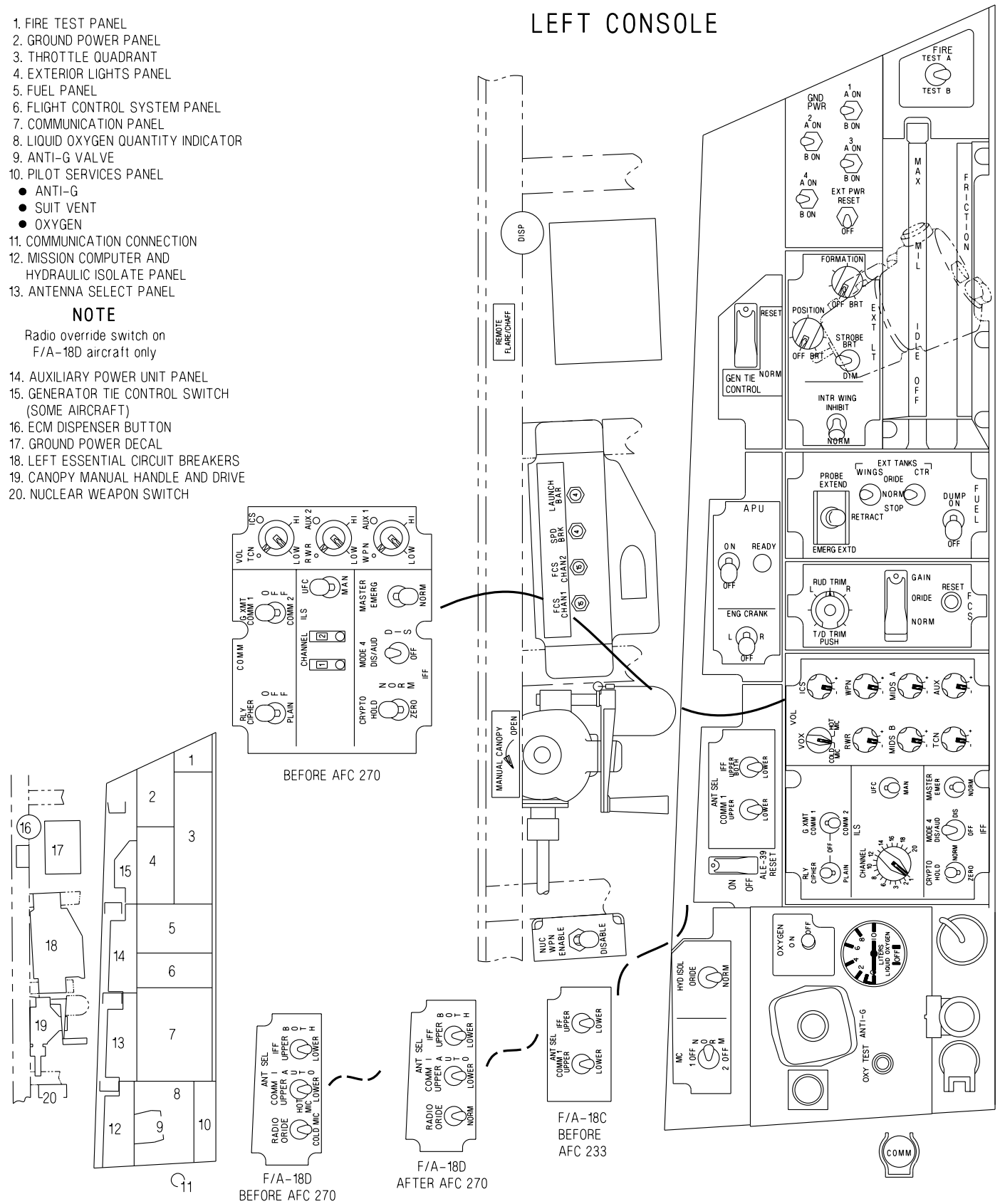

1. ELECTRICAL POWER PANEL
2. ENVIRONMENT CONTROL SYSTEM PANEL
3. INTERIOR LIGHTS PANEL
4. AMAC CONTROL
5. SENSOR PANEL
6. KY-58 CONTROL
7. BLANK PANEL
8. BLANK PANEL
9. FAN TEST SWITCH
10. MAP AND DATA CASE
11. UTILITY LIGHT
12. DEFOG PANEL
13. INTERNAL CANOPY SWITCH
14. RIGHT ESSENTIAL CIRCUIT BREAKERS
15. VIDEO CAMERA

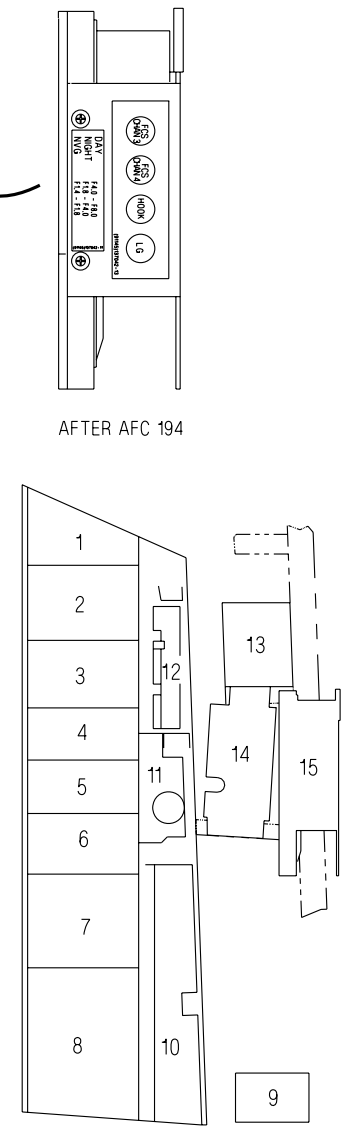
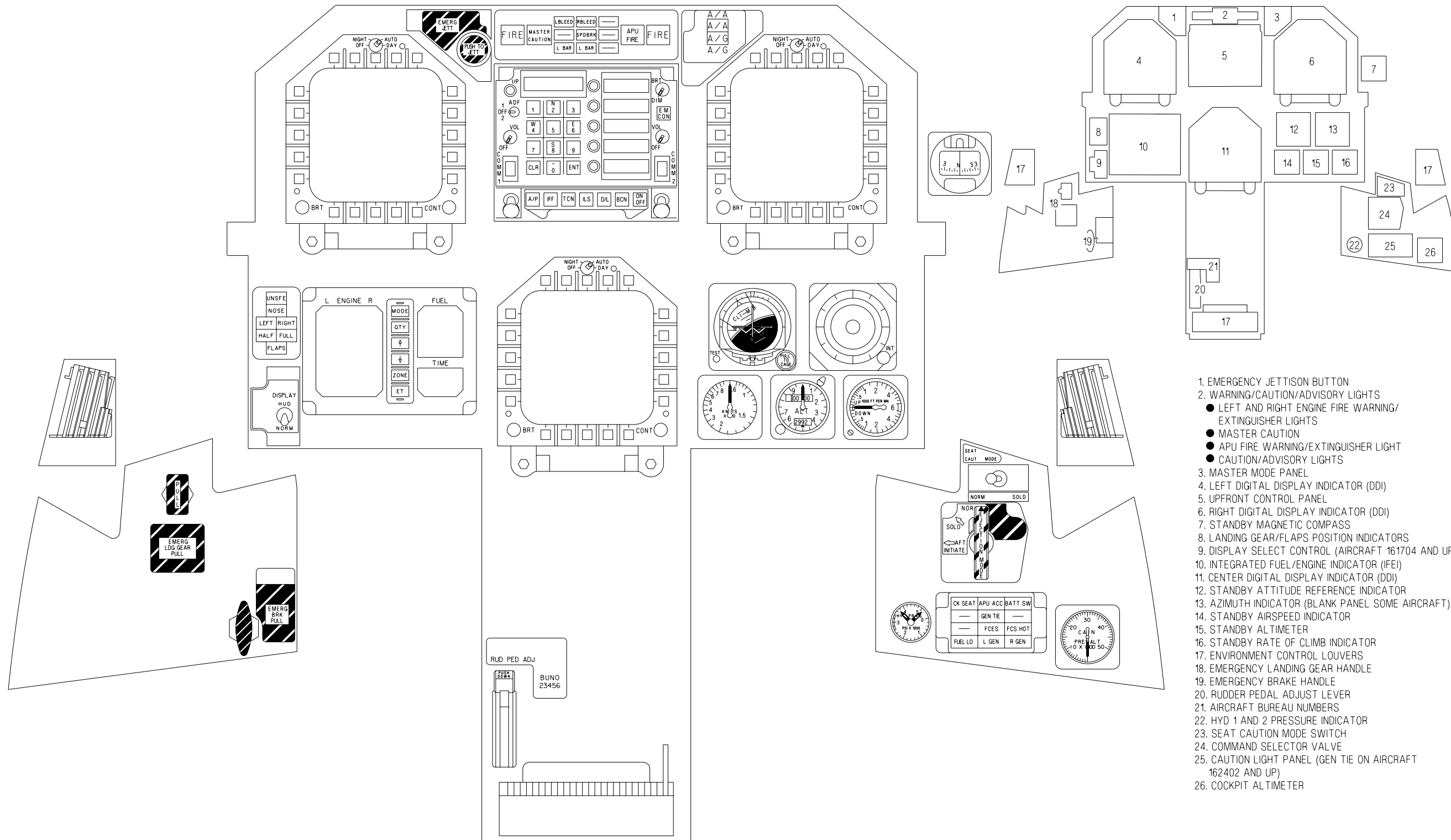

Figure FO-3. Front Cockpit F/A-18C/D Aircraft 163427 thru 163782 (Sheet 2 of 2)

INSTRUMENT PANEL



1. EMERGENCY JETTISON BUTTON
2. WARNING/CAUTION/ADVISORY LIGHTS
 - LEFT AND RIGHT ENGINE FIRE WARNING/ EXTINGUISHER LIGHTS
 - MASTER CAUTION
 - APU FIRE WARNING/EXTINGUISHER LIGHT
 - CAUTION/ADVISORY LIGHTS
3. MASTER MODE PANEL
4. LEFT DIGITAL DISPLAY INDICATOR (DDI)
5. UPFRONT CONTROL PANEL
6. RIGHT DIGITAL DISPLAY INDICATOR (DDI)
7. STANDBY MAGNETIC COMPASS
8. LANDING GEAR/FLAPS POSITION INDICATORS
9. DISPLAY SELECT CONTROL (AIRCRAFT 161704 AND UP)
10. INTEGRATED FUEL/ENGINE INDICATOR (IFEI)
11. CENTER DIGITAL DISPLAY INDICATOR (DDI)
12. STANDBY ATTITUDE REFERENCE INDICATOR
13. AZIMUTH INDICATOR (BLANK PANEL SOME AIRCRAFT)
14. STANDBY AIRSPEED INDICATOR
15. STANDBY ALTIMETER
16. STANDBY RATE OF CLIMB INDICATOR
17. ENVIRONMENT CONTROL LOUVERS
18. EMERGENCY LANDING GEAR HANDLE
19. EMERGENCY BRAKE HANDLE
20. RUDDER PEDAL ADJUST LEVER
21. AIRCRAFT BUREAU NUMBERS
22. HYD 1 AND 2 PRESSURE INDICATOR
23. SEAT CAUTION MODE SWITCH
24. COMMAND SELECTOR VALVE
25. CAUTION LIGHT PANEL (GEN TIE ON AIRCRAFT 162402 AND UP)
26. COCKPIT ALTIMETER

ADA520-353-1-043

Figure FO-4. Rear Cockpit F/A-18D Aircraft 163434 thru 163778 (Sheet 1 of 2)

LEFT CONSOLE

1. BLANK PANEL
2. THROTTLE QUADRANT
3. BLANK PANEL BEFORE AFC 270
3. VOLUME CONTROL AFTER AFC 270
4. BLANK PANEL
5. PILOT SERVICE PANEL
 - ANTI-G
 - SUIT VENT
 - OXYGEN
6. LIQUID OXYGEN QUANTITY INDICATOR
7. ANIT-G VALVE
8. AN/ALE-39 PROGRAMMER
9. CANOPY INTERNAL JETTISON HANDLE
10. VOLUME CONTROL BEFORE AFC 270
10. BLANK PANEL AFTER AFC 270

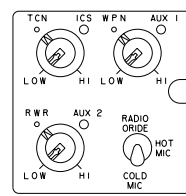

BEFORE AFC 270

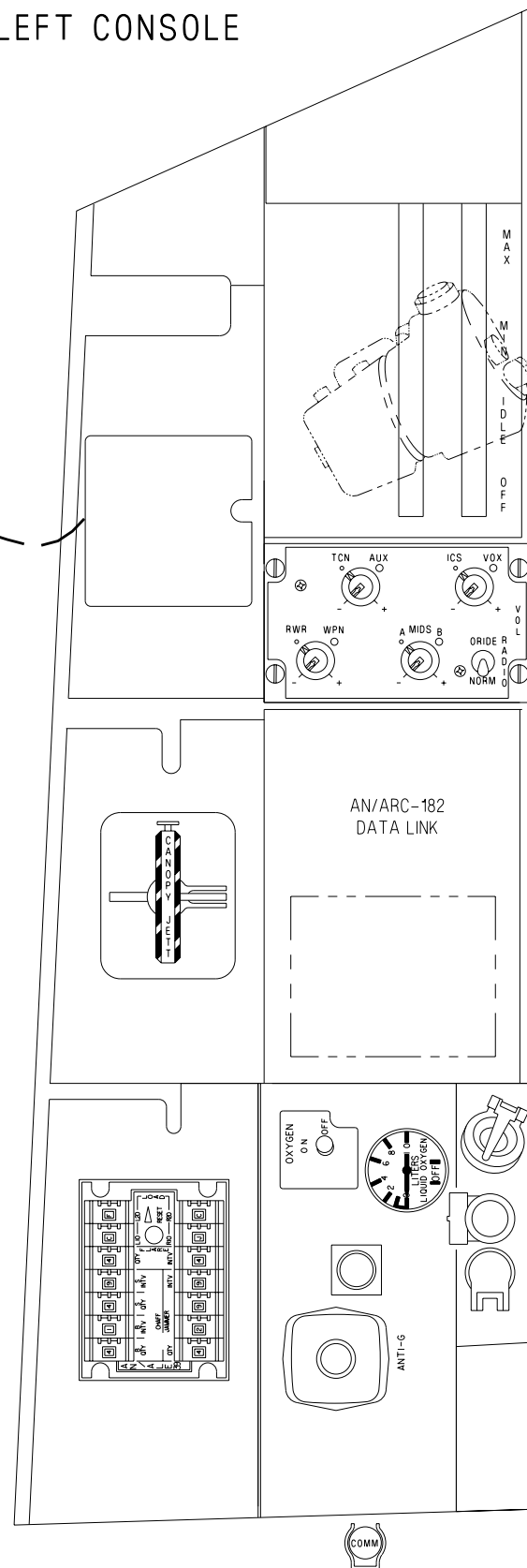
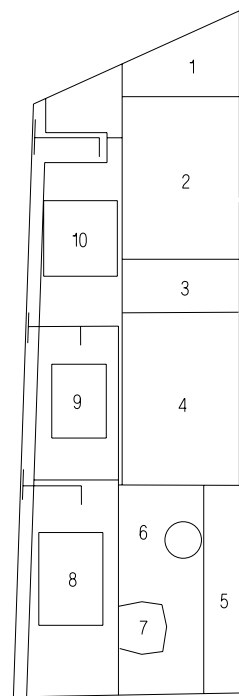

RIGHT CONSOLE

1. BLANK PANEL
2. INTERNAL LIGHTS PANEL
3. BLANK PANEL
4. BLANK PANEL
5. BLANK PANEL
6. BLANK PANEL
7. MAP AND DATA CASE
8. UTILITY LIGHT
8. FAN TEST SWITCH
10. BLANK PANEL

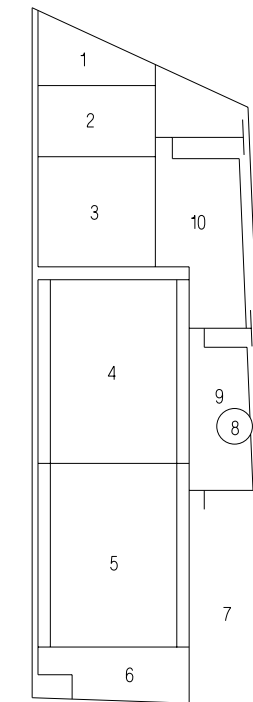
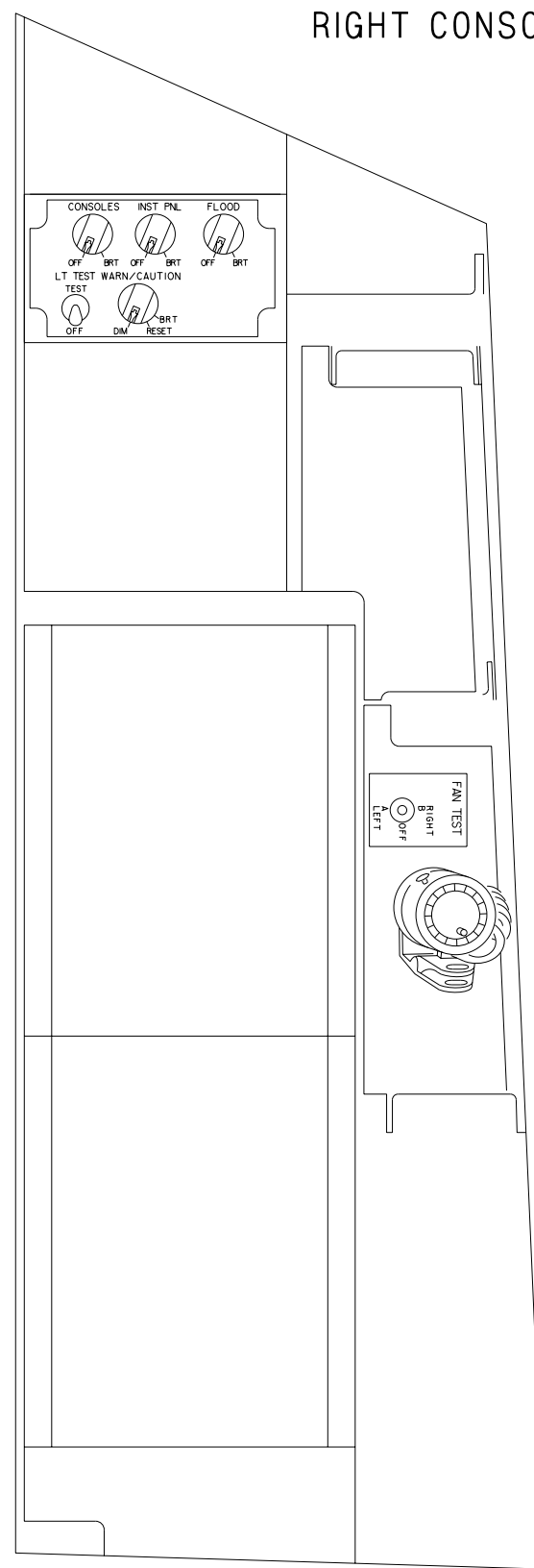
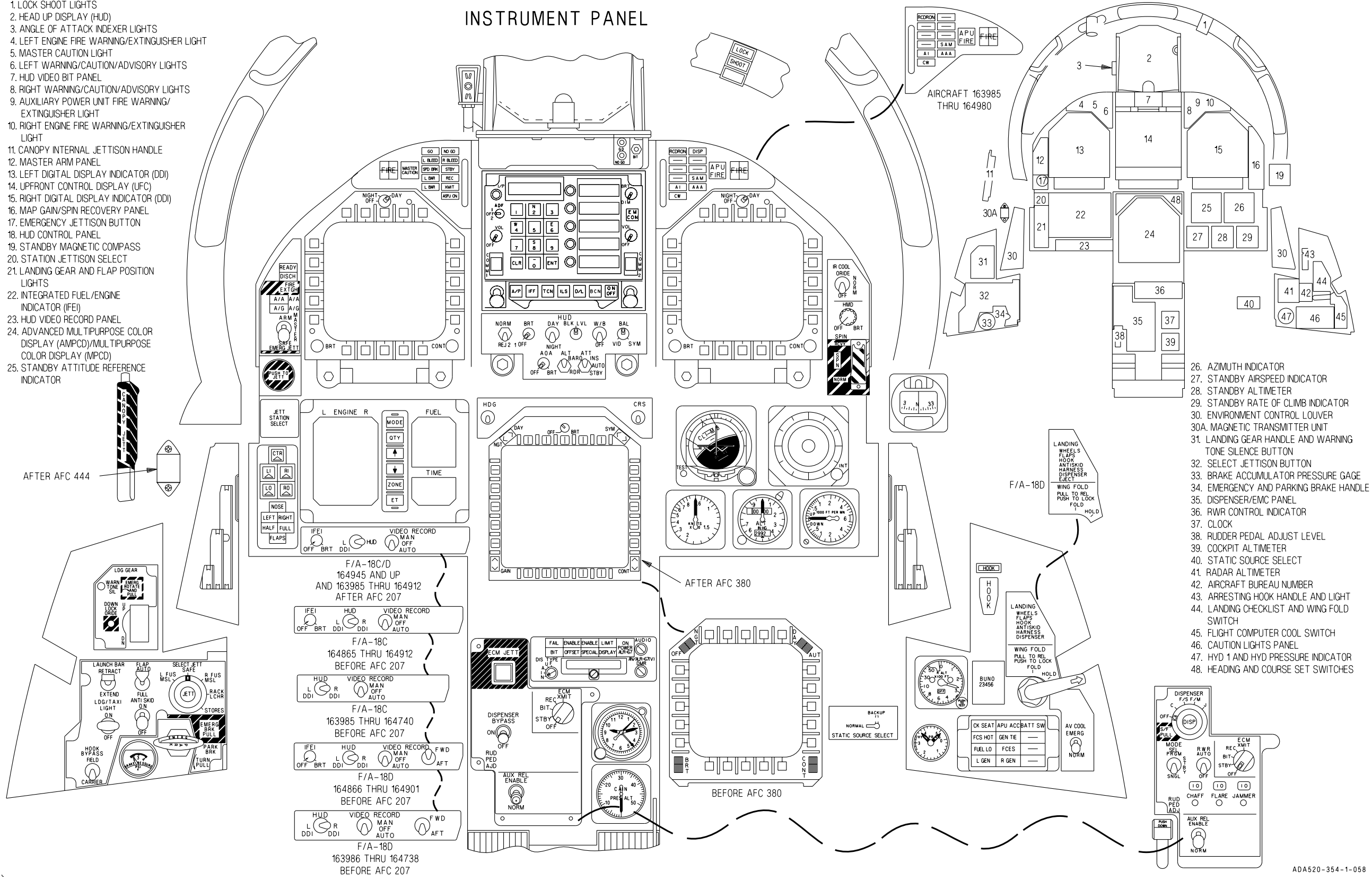

Figure FO-4. Rear Cockpit F/A-18D Aircraft 163434 thru 163778
(Sheet 2 of 2)

ADA520-353-2-053

1. LOCK SHOOT LIGHTS
2. HEAD UP DISPLAY (HUD)
3. ANGLE OF ATTACK INDEXER LIGHTS
4. LEFT ENGINE FIRE WARNING/EXTINGUISHER LIGHT
5. MASTER CAUTION LIGHT
6. LEFT WARNING/CAUTION/ADVISORY LIGHTS
7. HUD VIDEO BIT PANEL
8. RIGHT WARNING/CAUTION/ADVISORY LIGHTS
9. AUXILIARY POWER UNIT FIRE WARNING/EXTINGUISHER LIGHT
10. RIGHT ENGINE FIRE WARNING/EXTINGUISHER LIGHT
11. CANOPY INTERNAL JETTISON HANDLE
12. MASTER ARM PANEL
13. LEFT DIGITAL DISPLAY INDICATOR (DDI)
14. UPFRONT CONTROL DISPLAY (UFC)
15. RIGHT DIGITAL DISPLAY INDICATOR (DDI)
16. MAP GAIN/SPIN RECOVERY PANEL
17. EMERGENCY JETTISON BUTTON
18. HUD CONTROL PANEL
19. STANDBY MAGNETIC COMPASS
20. STATION JETTISON SELECT
21. LANDING GEAR AND FLAP POSITION LIGHTS
22. INTEGRATED FUEL/ENGINE INDICATOR (IFEI)
23. HUD VIDEO RECORD PANEL
24. ADVANCED MULTIPURPOSE COLOR DISPLAY (AMP/CD)/MULTIPURPOSE COLOR DISPLAY (MPCD)
25. STANDBY ATTITUDE REFERENCE INDICATOR

INSTRUMENT PANEL



26. AZIMUTH INDICATOR
27. STANDBY AIRSPEED INDICATOR
28. STANDBY ALTIMETER
29. STANDBY RATE OF CLIMB INDICATOR
30. ENVIRONMENT CONTROL LOUVER
- 30A. MAGNETIC TRANSMITTER UNIT
31. LANDING GEAR HANDLE AND WARNING TONE SILENCE BUTTON
32. SELECT JETTISON BUTTON
33. BRAKE ACCUMULATOR PRESSURE GAGE
34. EMERGENCY AND PARKING BRAKE HANDLE
35. DISPENSER/EMC PANEL
36. RWR CONTROL INDICATOR
37. CLOCK
38. RUDDER PEDAL ADJUST LEVEL
39. COCKPIT ALTIMETER
40. STATIC SOURCE SELECT
41. RADAR ALTIMETER
42. AIRCRAFT BUREAU NUMBER
43. ARRESTING HOOK HANDLE AND LIGHT
44. LANDING CHECKLIST AND WING FOLD SWITCH
45. FLIGHT COMPUTER COOL SWITCH
46. CAUTION LIGHTS PANEL
47. HYD 1 AND HYD PRESSURE INDICATOR
48. HEADING AND COURSE SET SWITCHES

Figure FO-5. Front Cockpit F/A-18C/D Aircraft 163985 And Up (Sheet 1 of 2)

ADA520-354-1-058

1. FIRE TEST PANEL
2. GROUND POWER PANEL
3. THROTTLE QUADRANT
4. EXTERIOR LIGHTS PANEL
5. FUEL PANEL
6. FLIGHT CONTROL SYSTEM PANEL
7. COMMUNICATION PANEL
8. LIQUID OXYGEN QUANTITY INDICATOR (163985 THRU 164068)
- OBOGS (164196 AND UP)
9. ANTI-G VALVE
10. PILOT SERVICES PANEL
- ANTI-G
- LOWER HVI CABLE ASSY
- OXYGEN
11. COMMUNICATION CONNECT
12. MISSION COMPUTER AND HYDRAULIC ISOLATE PANEL
13. ANTENNA SELECT PANEL
14. AUXILIARY POWER UNIT PANEL
15. GENERATOR TIE CONTROL SWITCH (SOME AIRCRAFT)
16. ECM DISPENSER BUTTON
17. GROUND POWER DECAL
18. LEFT ESSENTIAL CIRCUIT BREAKERS
19. CANOPY MANUAL HANDLE AND DRIVE
20. HVI STOWAGE/NUCLEAR WEAPON SWITCH
21. VIDEO SENSOR HEAD
22. OBOGS MONITOR (164196 AND UP)

LEFT CONSOLE

RIGHT CONSOLE

1. ELECTRICAL POWER PANEL
2. ENVIRONMENT CONTROL SYSTEM PANEL
3. INTERIOR LIGHTS PANEL
4. AMAC CONTROL
5. SENSOR PANEL
6. KY-58 CONTROL
7. NIGHT VISION GOGGLE STORAGE
8. FAN TEST SWITCH
9. MAP AND DATA CASE
10. UTILITY LIGHT
11. DEFOG PANEL
12. INTERNAL CANOPY SWITCH
13. RIGHT ESSENTIAL CIRCUIT BREAKERS
14. VIDEO SENSOR HEAD
15. VIDEO CAMERA

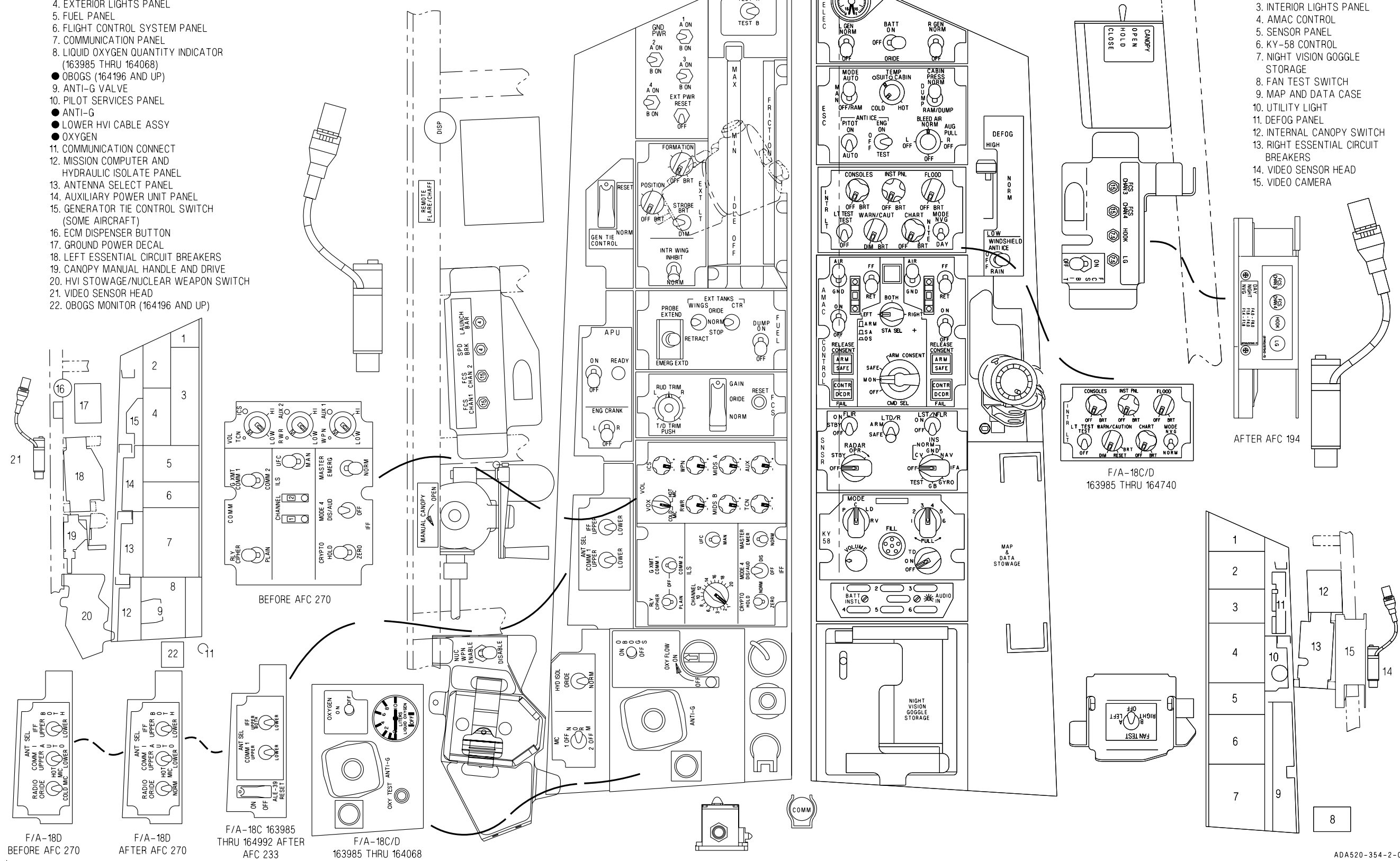

F/A-18D BEFORE AFC 270

F/A-18D AFTER AFC 270

F/A-18C 163985 THRU 164992 AFTER AFC 233

F/A-18C/D 163985 THRU 164068

F/A-18C/D 163985 THRU 164740

Figure FO-5. Front Cockpit F/A-18C/D Aircraft 163985 And Up (Sheet 2 of 2)

INSTRUMENT PANEL

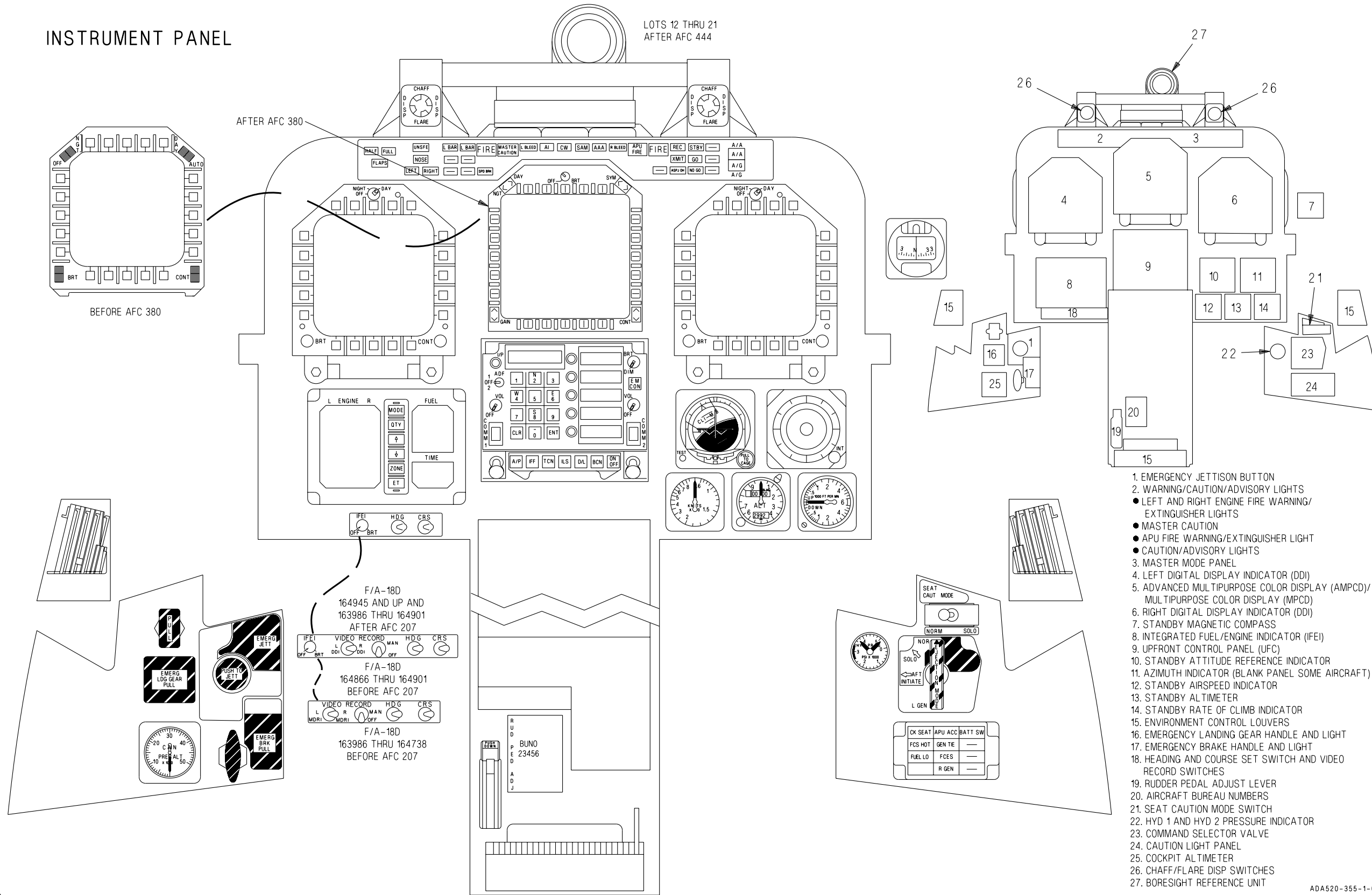

1. EMERGENCY JETTISON BUTTON
2. WARNING/CAUTION/ADVISORY LIGHTS
 - LEFT AND RIGHT ENGINE FIRE WARNING/EXTINGUISHER LIGHTS
 - MASTER CAUTION
 - APU FIRE WARNING/EXTINGUISHER LIGHT
 - CAUTION/ADVISORY LIGHTS
3. MASTER MODE PANEL
4. LEFT DIGITAL DISPLAY INDICATOR (DDI)
5. ADVANCED MULTIPURPOSE COLOR DISPLAY (AMPCD)/ MULTIPURPOSE COLOR DISPLAY (MPCD)
6. RIGHT DIGITAL DISPLAY INDICATOR (DDI)
7. STANDBY MAGNETIC COMPASS
8. INTEGRATED FUEL/ENGINE INDICATOR (IFEI)
9. UPFRONT CONTROL PANEL (UFC)
10. STANDBY ATTITUDE REFERENCE INDICATOR
11. AZIMUTH INDICATOR (BLANK PANEL SOME AIRCRAFT)
12. STANDBY AIRSPEED INDICATOR
13. STANDBY ALTIMETER
14. STANDBY RATE OF CLIMB INDICATOR
15. ENVIRONMENT CONTROL LOUVERS
16. EMERGENCY LANDING GEAR HANDLE AND LIGHT
17. EMERGENCY BRAKE HANDLE AND LIGHT
18. HEADING AND COURSE SET SWITCH AND VIDEO RECORD SWITCHES
19. RUDDER PEDAL ADJUST LEVER
20. AIRCRAFT BUREAU NUMBERS
21. SEAT CAUTION MODE SWITCH
22. HYD 1 AND HYD 2 PRESSURE INDICATOR
23. COMMAND SELECTOR VALVE
24. CAUTION LIGHT PANEL
25. COCKPIT ALTIMETER
26. CHAFF/FLARE DISP SWITCHES
27. BORESIGHT REFERENCE UNIT

ADA520-355-1-058

Figure FO-6. Rear Cockpit F/A-18D Aircraft 163986 And Up (Sheet 1 of 2)

1. BLANK PANEL
2. BLANK PANEL
3. LEFT HAND CONTROLLER
- 4A. RECCE CONTROL PANEL (164649 AND UP)
- 4B. PUSH TO TALK COM PANEL (AFTER AFC 270)
5. VOLUME CONTROL
6. EU/CU COVER AND HVI STOWAGE (AFTER AFC 444)
BLANK PANEL (BEFORE AFC 444)
7. PILOT SERVICE PANEL
 - ANTI-G
 - LOWER HVI CABLE ASSY (AFTER AFC 444)
 - OXYGEN
8. LIQUID OXYGEN QUANTITY (163986 THRU 164068)
● OBOGS (164196 AND UP)
9. ANTI-G VALVE
10. COMMUNICATION CONNECTION
11. AN/ALE-39 PROGRAMMER
12. CANOPY INTERNAL JETTISON HANDLE
13. BLANK PANEL
14. ECM DISPENSE BUTTON

LEFT CONSOLE

RIGHT CONSOLE

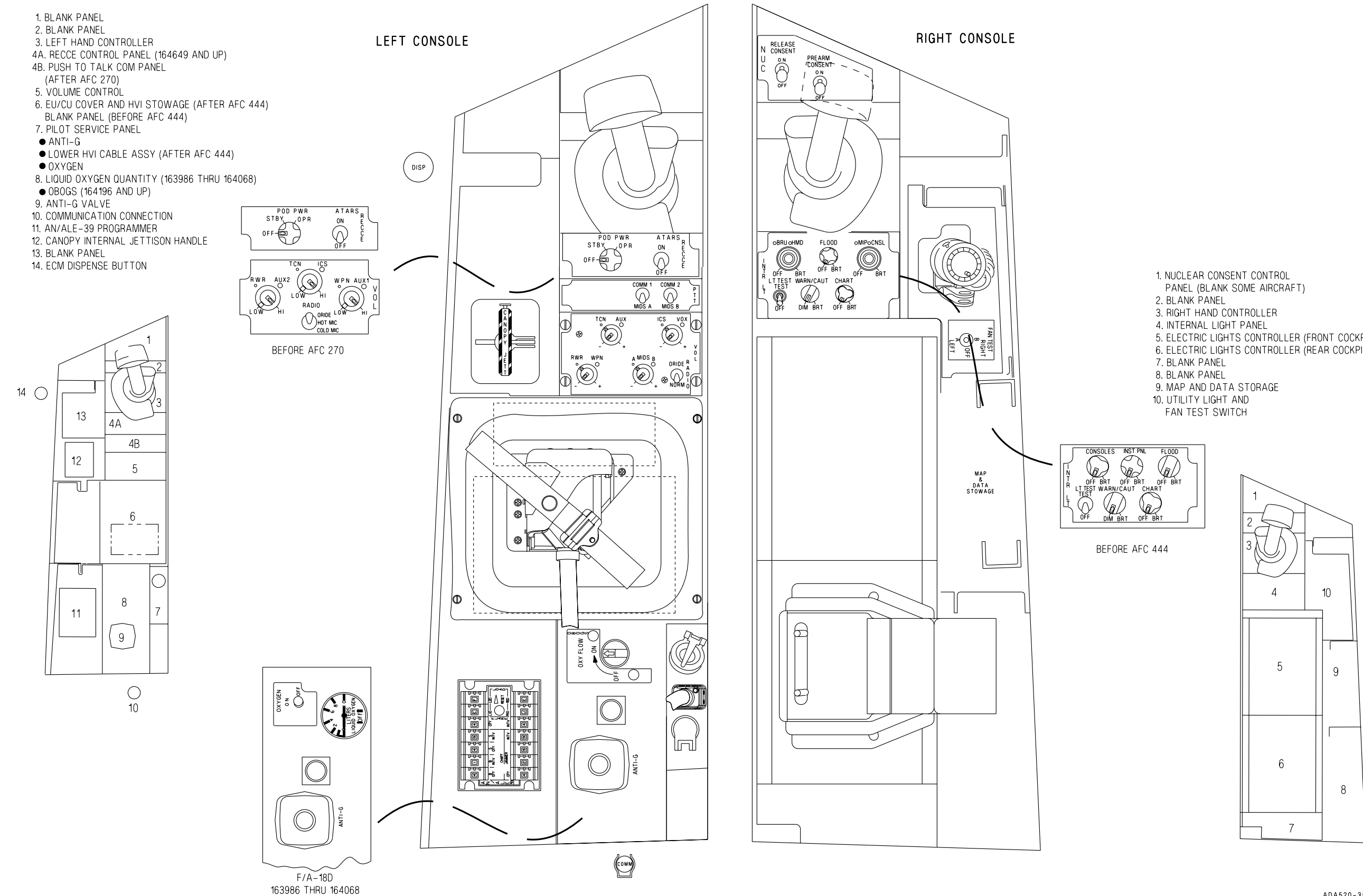

1. NUCLEAR CONSENT CONTROL PANEL (BLANK SOME AIRCRAFT)
2. BLANK PANEL
3. RIGHT HAND CONTROLLER
4. INTERNAL LIGHT PANEL
5. ELECTRIC LIGHTS CONTROLLER (FRONT COCKPIT)
6. ELECTRIC LIGHTS CONTROLLER (REAR COCKPIT)
7. BLANK PANEL
8. BLANK PANEL
9. MAP AND DATA STORAGE
10. UTILITY LIGHT AND FAN TEST SWITCH

Figure FO-6. Rear Cockpit F/A-18D Aircraft 163986 And Up (Sheet 2 of 2)

ADA520-355-2-058

RIGHT 115/200 VOLT AC BUS	ADC AMAC APRCH LT ARM STA 5 THRU 9 AVIONICS GND CLG FAN	CSC ECS CONT ELEC ALT FUEL QUAN IND	HARM CMD LAUNCH CMPTR HUD ICE DETR INTER BLANKER	INT LTS CONT MFD (RDDI) MSN COMPTR NO. 2 PROCESSOR	R AOA PROBE HTR R BL AIR DR R CABIN CLG FAN R PITOT PROBE HTR	R WING FOLD R XFMR RECT STBY ATT IND STROBE LT	TACAN UTIL BAT HEATER 26 VAC AUTO XFMR
RIGHT 26 VOLT AC BUS	ADF HYD SYS NO. 1	HYD SYS NO. 2 INS					
RIGHT 28 VOLT DC BUS	ADF AMAC AN/ALE-39 CONT AN/ALE-39 PWR ANT SEL APC APRCH LT CONT	ARM STA 5 THRU 9 ARM STA 7 AERO 5 ARM STA 8 AERO 5 AUG RCVR-BEACON AVIONICS/LCS CLG FAN CONT BLEED AIR CONTROL VALVES	CAB CLG FAN CONT CABIN RAM AIR VALVE CSC ECS CONT	ENG ANTI-ICE VALVE ENG ICE DETR FCES CHAN 3 FCES CHAN 4 GND CLG FANS CONT HARM CMD LNCH CMPTR	HOOK HUD INTERCOM INT LTS LG LG CONT L/R ENG ANTI-ICE V LST/SCAM POD	PROBE HTR CONT PROCESSOR R BL AIR CONT V R BL DR/ENG CONT THROTTLE BOOST	UHF R/T NO. 2 UND COOL SENSOR UTIL BAT/CHGR WING FLD CONT A WSHLD A/I RAIN RM V
14/28 VDC NON-ESS WARN LTS BUS (FWD CKPT)	HOOK LT ELECTRONIC ALT LOW ALT LT RED LAUNCH BAR LT				14/28 VDC NON-ESS WARN LTS BUS (AFT CKPT)	LDG GR UNSAFE RED LAUNCH BAR LT	
6-14/28 VDC NON-ESS ANNUNCIATOR LTS BUS (FWD CKPT)	A/A , A/G SELECT LTS GREEN LAUNCH BAR LT LOCK AND SHOOT LTS SPD BRK STATION SELECT LTS				6-14/28 VDC NON-ESS ANNUNCIATOR LTS BUS (AFT CKPT)	A/A AND A/G SELECT LTS GREEN LAUNCH BAR LT SPD BK	
14/28/24 VDC MASTER CAUTION/WARN LTS BUS (FWD CKPT)	LDG GR HDL LT MASTER CAUTION LT RED LAUNCH BAR LT SPIN RECOVERY LT				14/28/24 VDC MASTER CAUTION/WARN LTS BUS (AFT CKPT)	MASTER CAUTION LT	
6-14/28/24 VDC ESS ANNUNCIATOR LTS BUS (FWD CKIT)	APU READY LT CAUTION LTS PANEL FLAP POSITION LTS LDG GR POSITION LTS READY/DISCH LTS				6-14/28/24 VDC ESS ANNUNCIATOR LTS BUS (AFT CKPT)	CAUTION LTS PANEL FLAP POSITION LTS LDG GR POSITION LTS	
ESSENTIAL 24/28 VOLT DC BUS	ARM STA 2 THRU 6 ASYM BK FCCA BL AIR LEAK DET LOOP A BL AIR LEAK DET LOOP B CAB AIR DUMP VLV	CHECK BAT RELAY SW CROSSFEED FUEL VLV EMER MON FCC A ASYM BRAKE FCES CHAN 1	FCES CHAN 2 FCS RM AIR DR ACTR FEXT FIRE DET LOOP A FIRE DET LOOP B	FUEL DUMP IFF R/T INTERCOM INT LTS LDG GR CONT UNIT	L ENG IND LVCU RLY CONT L/FUEL S/O VLV PITCH TRIM PROCESSOR SMS	RATIO CHANGER R ENG IND R /FUEL S/O VLV RMG RLY CONT SMS	STBY ADI STBY ALTM UHF XCVR NO.1 UTIL LT
LEFT 28 VOLT DC BUS	AFT SEAT ADJUST ANTI SKID APC ARM STA 1 THRU 4 ARM STA 2 THRU 5 ARM STA 3 THRU 5	ASY BK FCC-B BLD AIR DUCT CONT CANOPY CONT DATA LINK ECM CLG VLV EJCTR VALVES EMER BAT CHRGR	ENG IDLE A-B LK OUT EXT FUEL TK CONT EXT LTS CONT FCC ASYM BRAKE FUEL LEVEL LOW FUEL TK PRESS	GND PWR CONT GUN DECODER HYD ISOL PWR IFR PROBE ILS LAUNCH BAR L ASYMMETRY BRAKE	L BL AIR CONT V L BLEED DOOR/ENG CONT LCS RAM AIR DOOR ACTR LCS RAM AIR/LCS PUMP/CONT LDC BUS SENSING MASTER ARM	NWS RDR ANT RDR ENABLE RDR 28VDC SEAT ADJUST SPD BRK STICK STOP CONT	TACTS DC PWR UHF COMM NO 2 UTIL PWR WINGFOLD CONT B WING FUEL
LEFT 115/200 VOLT AC BUS	ALQ-126 ARM STA 1 THRU 4 AWW-4 EHSI/HSO (RPTR DIS- PLAY)	EMERG BAT HTR FORMATN LTS GUN DECODER	IFF COMPUTER/ TRANSPONDER IFR LTS ILS INS	L AOA PROBE HTR L BLEED DOOR L CABIN COOL FAN LCS CLG FAN LCS CLG PUMP	LDG/TAXI LT LIQ LVL CONT L PITOT PROBE HTR L WING FOLD EDU L XFMR RECT	MSN COMP NO.1 MMD (LEFT DDI) OXYGEN GAGE POSITION LTS RDR DATA PROC RDR XMTR	STROBE LTS TACTS AC PWR TOT TEMP PROBE HTR UTIL POWER

Figure FO-7. Electrical Bus Power Aircraft 161353 thru 161528

RIGHT 115/200 VOLT AC BUS	ADC AMAC APRCH LT ARM STA 5 THRU 9 AVIONICS GND CLG FAN	BATT CHG TRU CSC ECS CONT ELEC ALT FUEL QUANT IND GPS	HARM CMD LAUNCH CMPTR HUD ICE DETR INTER BLANKER	INT LTS CONT MFD (RDDI) MSN COMPTR NO. 2 NIGHT ATTK CHART LT PROCESSOR	R AOA PROBE HTR R BL AIR DR R CABIN CLG FAN R PITOT PROBE HTR	R WING FOLD R XFMR RECT (SMS) STBY ATT IND STROBE LT	TACAN UTIL BAT HEATER VIDEO TAPE RECORDER 26 VAC AUTO XFMR
RIGHT 26 VOLT AC BUS	ADF HYD SYS NO. 1	HYD SYS NO. 2 INS					
RIGHT 28 VOLT DC BUS	ADF AMAC AN/ALE-39 CONT AN/ALE-39 PWR ANT SEL APC APRCH LT CONT	ARM STA 5 THRU 9 ARM STA 7 AERO 5 ARM STA 8 AERO 5 AUG RCVR-BEACON AVIONICS/LCS CLG FAN CONT BLEED AIR CONTROL VALVES	CAB CLG FAN CONT CABIN RAM AIR VLV CSC DFIRS POWER ECS CONT	ENG ANTI-ICE VALVE ENG ICE DETR FCES CHAN 3 FCES CHAN 4 HARM CMD LNCH CMPTR	HOOK HUD INTERCOM INT LTS LG LG CONT UNIT LST/SCAM POD	NVG FLDT CONT PROBE HTR CONT PROCESSOR R BL DR/ENG CONT THROTTLE BOOST	UHF R/T NO 2 UND COOL SENSOR VIDEO TAPE RCDR VIDEO RCDR SYS WING FLD CONT A WSHLD A/I RAIN RM V
14/28 VDC NON-ESS WARN LTS BUS (FWD CKPT)	HOOK LT ELECTRONIC ALT LOW ALT LT RED LAUNCH BAR LT				14/28 VDC NON-ESS WARN LTS BUS (AFT CKPT)	LDG GR UNSAFE RED LAUNCH BAR LT	
6-14/28 VDC NON-ESS ANNUNCIATOR LTS BUS (FWD CKPT)	A/A , A/G SELECT LTS AAA LT AI LT ASPJ OH CW LT GO LT	GREEN LAUNCH BAR LT LOCK AND SHOOT LTS NO GO LT RCDR ON LT REC LT REP LT	SAM LT SPD BRK STATION SELECT LTS STBY LT XMIT		6-14/28 VDC NON-ESS ANNUNCIATOR LTS BUS (AFT CKPT)	A/A AND A/G SELECT LTS GREEN LAUNCH BAR LT SPD BK	
14/28/24 VDC MASTER CAUTION/WARN LTS BUS (FWD CKPT)	LDG GR HDL LT MASTER CAUTION LT RED LAUNCH BAR LT SPIN RECOVERY LT				14/28/24 VDC MASTER CAUTION/WARN LTS BUS (AFT CKPT)	MASTER CAUTION LT	
6-14/28/24 VDC ESS ANNUNCIATOR LTS BUS (FWD CKPT)	APU ACC APU READY LT ATSCV CAUTION LTS PANEL	CK SEAT FLAP POSITION LTS LDG GR POSITION LTS READY/DISCH LTS			6-14/28/24 VDC ESS ANNUNCIATOR LTS BUS (AFT CKPT)	CAUTION LTS PANEL FLAP POSITION LTS LDG GR POSITION LTS	
ESSENTIAL 24/28 VOLT DC BUS	ARM STA 2,3,6,7,8 ASYM BK FCCA BL AIR LEAK DET LOOP A BL AIR LEAK DET LOOP B CAB AIR DUMP VLV	CHECK BAT RELAY SW CROSSFEED FUEL VLV ENG MON EMER IFR FCCA ASYM BRAKE FCES CHAN 1	FCES CHAN 2 FCS RM AIR DR ACTR FEXT FIRE DET LOOP A FIRE DET LOOP B	FUEL DUMP IFF R/T INTERCOM INT FUEL-ENG IND INT LTS (ANN LTS)	L ENG IND L GCU/NG RLY CONT LMG RLY CONT L/FUEL S/O VLV PITCH TRIM PROCESSOR SMS	RATIO CHANGER R ENG IND R /FUEL S/O VLV RMG RLY CONT	STBY ADI STBY ALTM UHF XCVR NO.1 UTIL LT
LEFT 28 VOLT DC BUS	AFT SEAT ADJUST ALR-67 IND CONT/FLTR ANTI SKID APC ARM STA 1 THRU 4 ARM STA 2 AERO 5 ARM STA 3 AERO 5	BLD AIR DOOR CONT BUS TIE CANOPY CONT CROSSMOTIVE VLV DATA LINK DIG MAP SET ECM CLG VLV	EJCTR VALVES ENG IDL/A-B LKOUT EXT FUEL TK CONT EXT LTS CONT FCC ASYM BRAKE FUEL LEVEL LOW FUEL TEST	FUEL TK PRESS FUEL TRANSFER GND PWR CONT GUN DECODER HYD ISOL PWR IFR PROBE ILS	LAUNCH BAR L ASYMMETRY BRAKE L BL AIR CONT V L BLEED DOOR/ENG CONT LCS RAM AIR DOOR ACTR LCS RAM AIR/LCS PUMP/CONT LDC BUS SENSING LEVEL CONTROL VALVES	MASTER ARM MEMORY UNIT NWS OBOGS RDR ANT RDR ENABLE RDR 28VDC	SEAT ADJUST SPD BRK TACTS DC PWR UHF COMM NO 2 UTIL PWR WINGFOLD CONT B WING FUEL
LEFT 115/200 VOLT AC BUS	ALQ-126 ALQ-165 ALR-67 ARM STA 1 THRU 4 AWW-4	DIG MAP SET EMERG BAT HTR FORMATN LTS FUZE FNCTN CONT GUN DECODER	IFF COMPUTER/XPONDR IFR LTS ILS INS	L AOA PROBE HTR L BLEED DOOR L CAB CLG FAN LCS CLG FAN LCS CLG PUMP	LDG/TAXI LT LIQ LVL CONT L PITOT PROBE HTR L WING FOLD EDU L XFMR RECT	MSN COMP NO.1 MMD (LEFT DDI) OBOGS CONCTR OXYGEN GAGE POSITION LTS RDR NO.1 AND NO 2	STROBE LTS TACTS AC PWR TOT TEMP PROBE HTR UTIL POWER

Figure FO-8. Electrical Bus Power Aircraft 161702 And Up

SEAWATER ACTIVATED
RELEASE SYSTEM (SEAWARS)

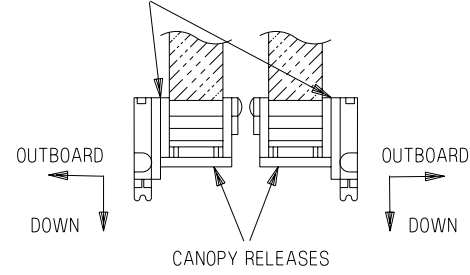

DETAIL A

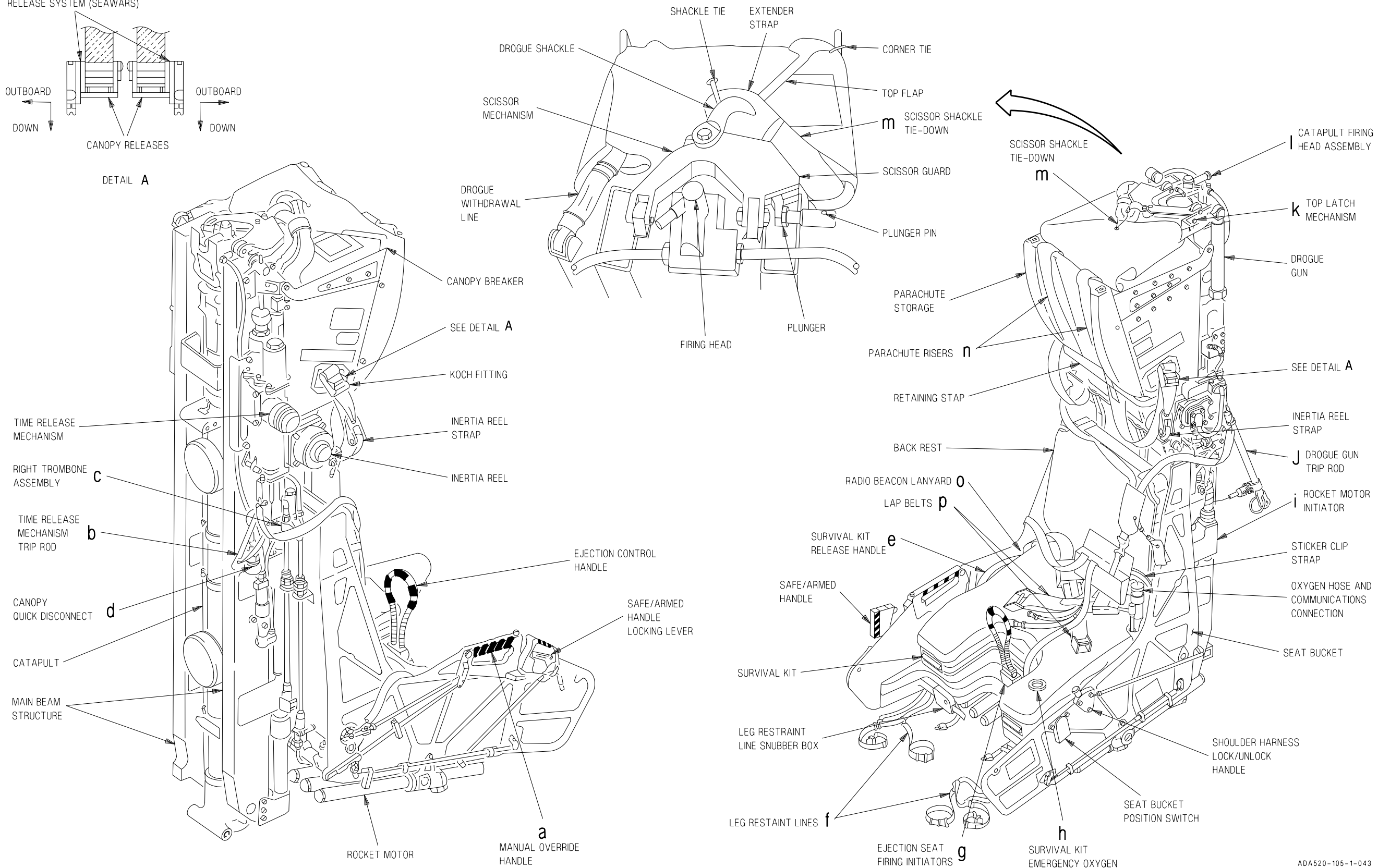

Figure FO-9. Ejection Seat (SJU-5/6)

ADA520-105-1-043

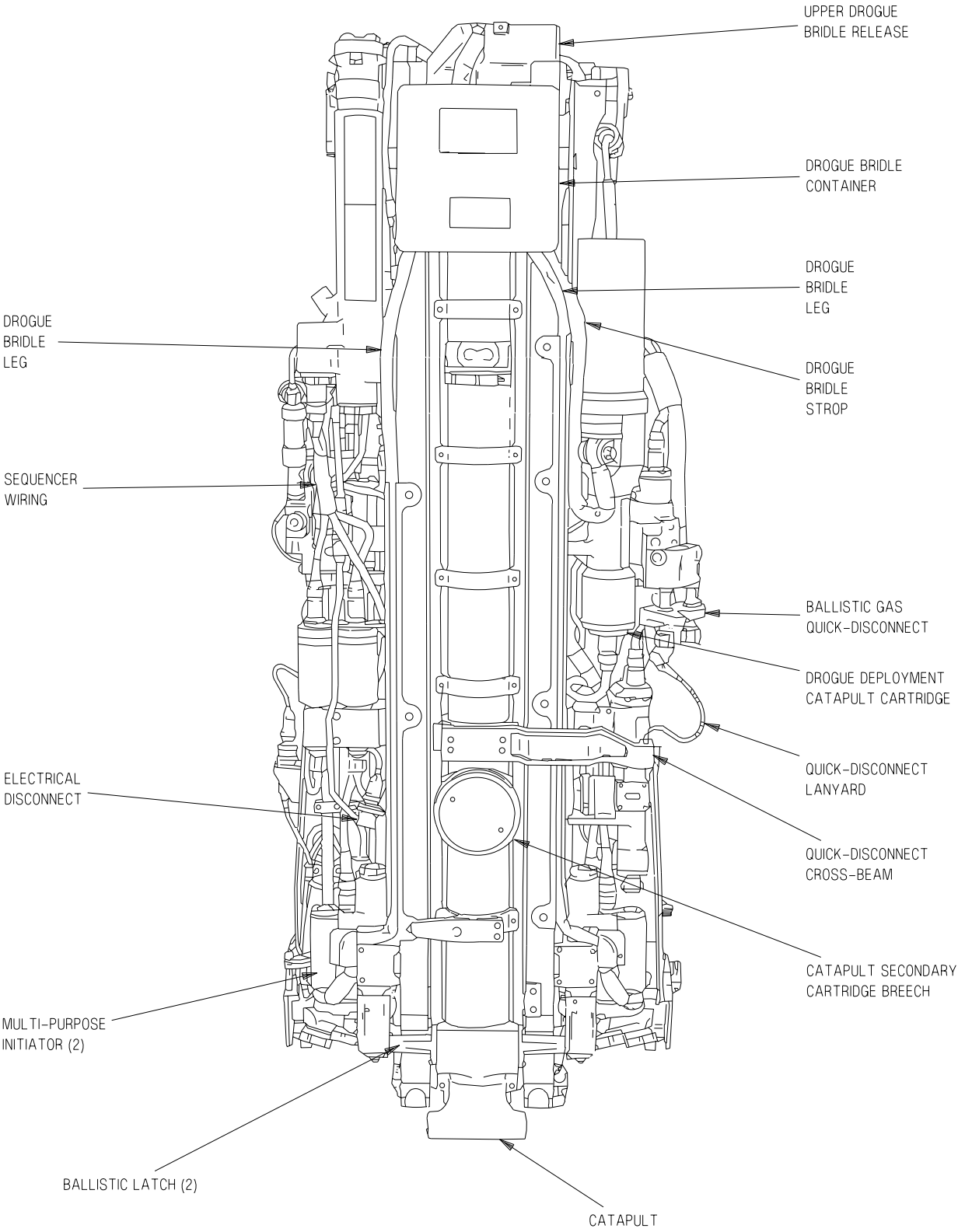

Figure FO-10. Ejection Seat (SJU-17 (V) 1/A-2/A)
(Sheet 1 of 2)

ADA520-143-1-043

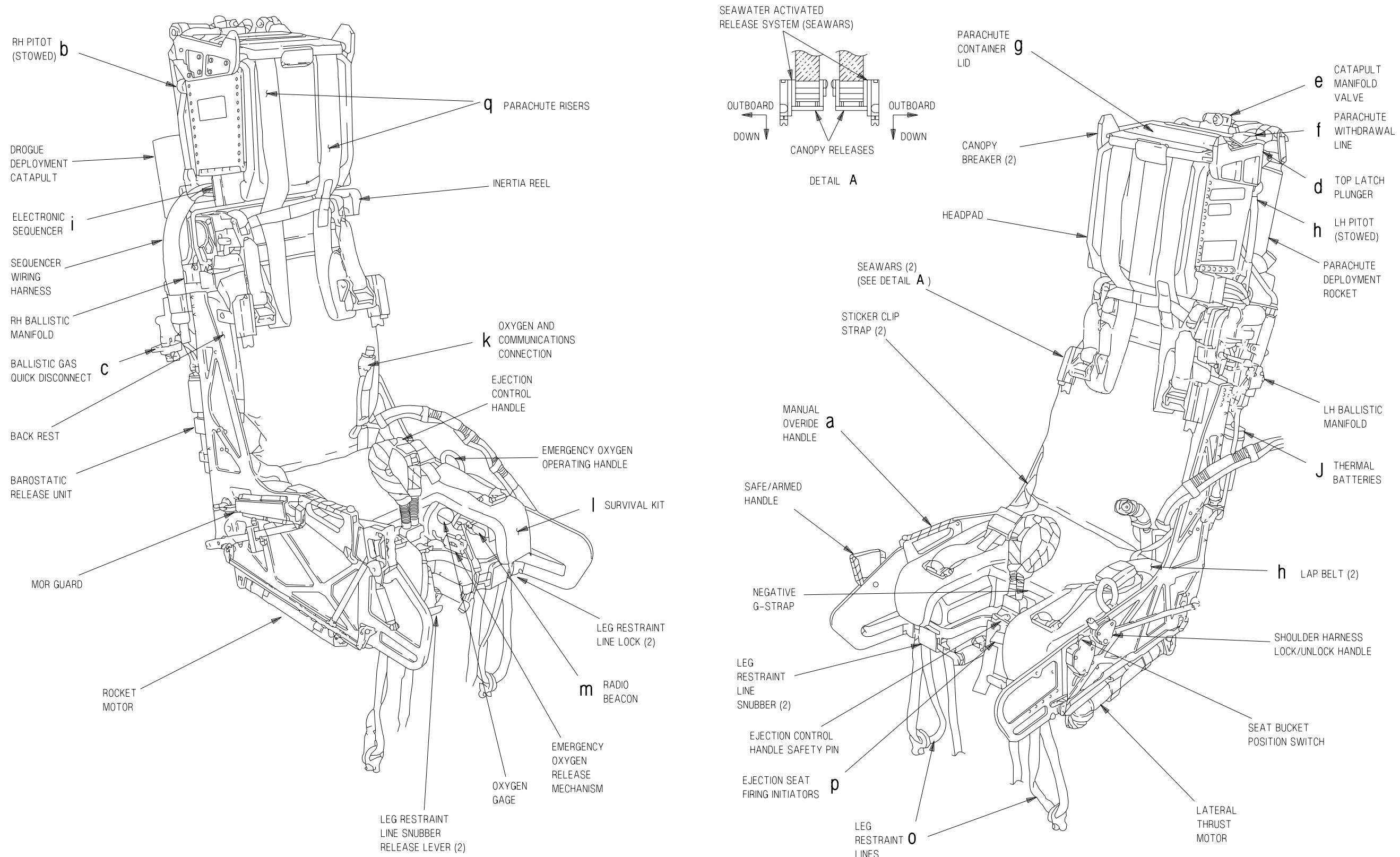

Figure FO-10. Ejection Seat (SJU-17 (V) 1/A-2/A)
(Sheet 2 of 2)

ADA520-143-2-043

FA-18A/B

(FEED, TRANSFER, GRAVITY SYSTEMS)

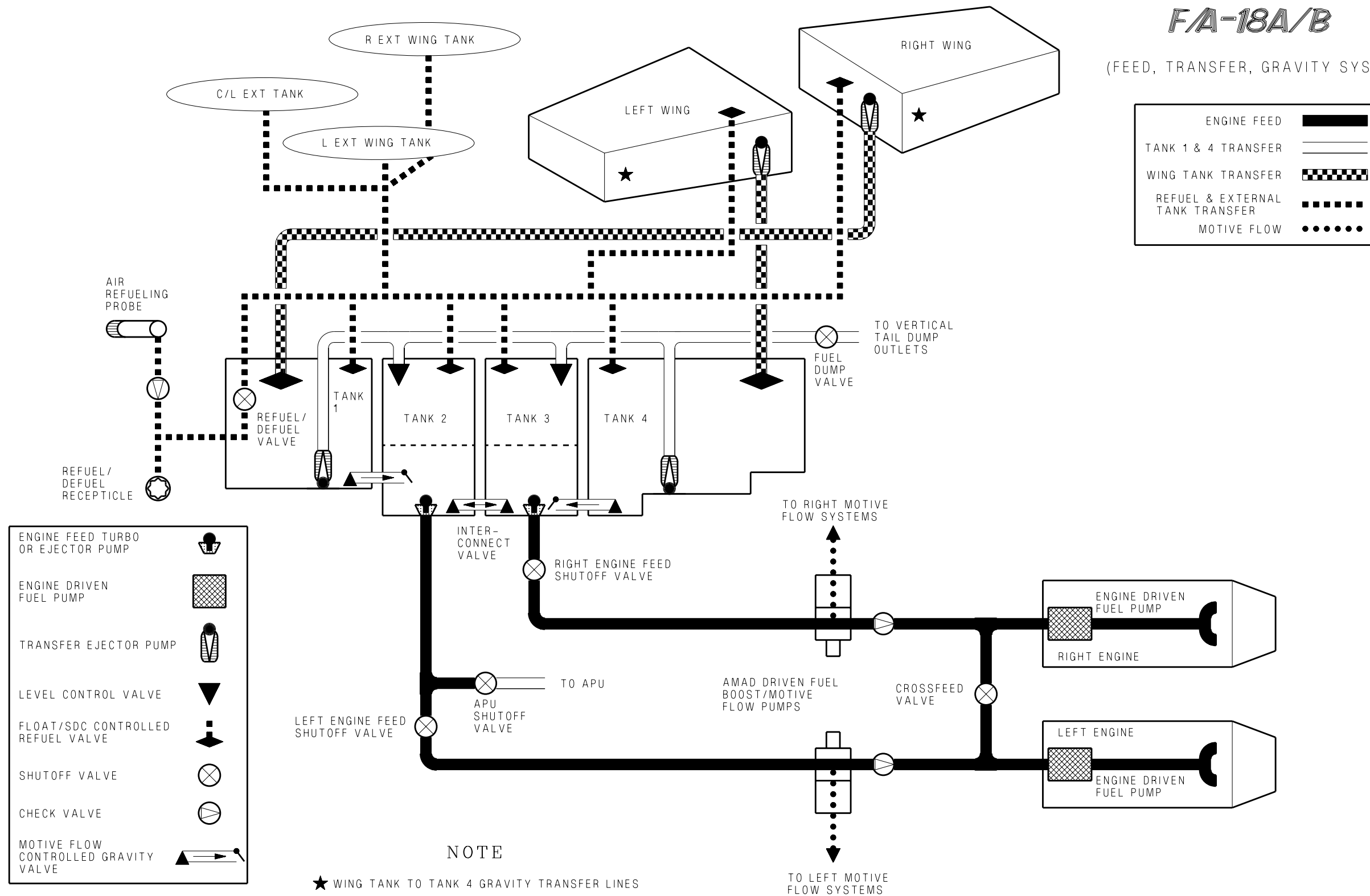

Figure FO-11. Fuel System (Sheet 1 of 3)

ADA520-107-1-043

FA-18C/D

(FEED, TRANSFER, GRAVITY SYSTEMS)

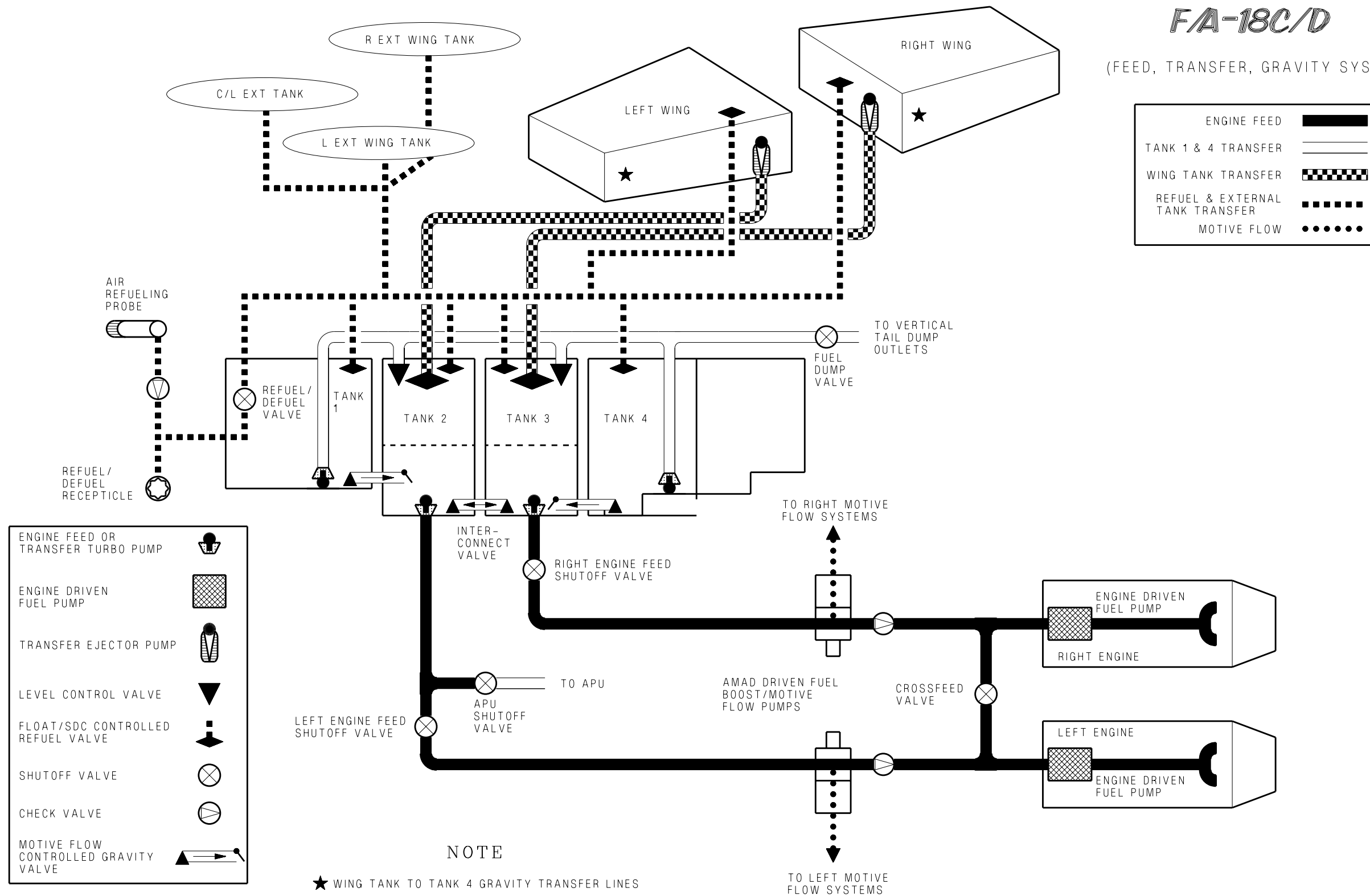
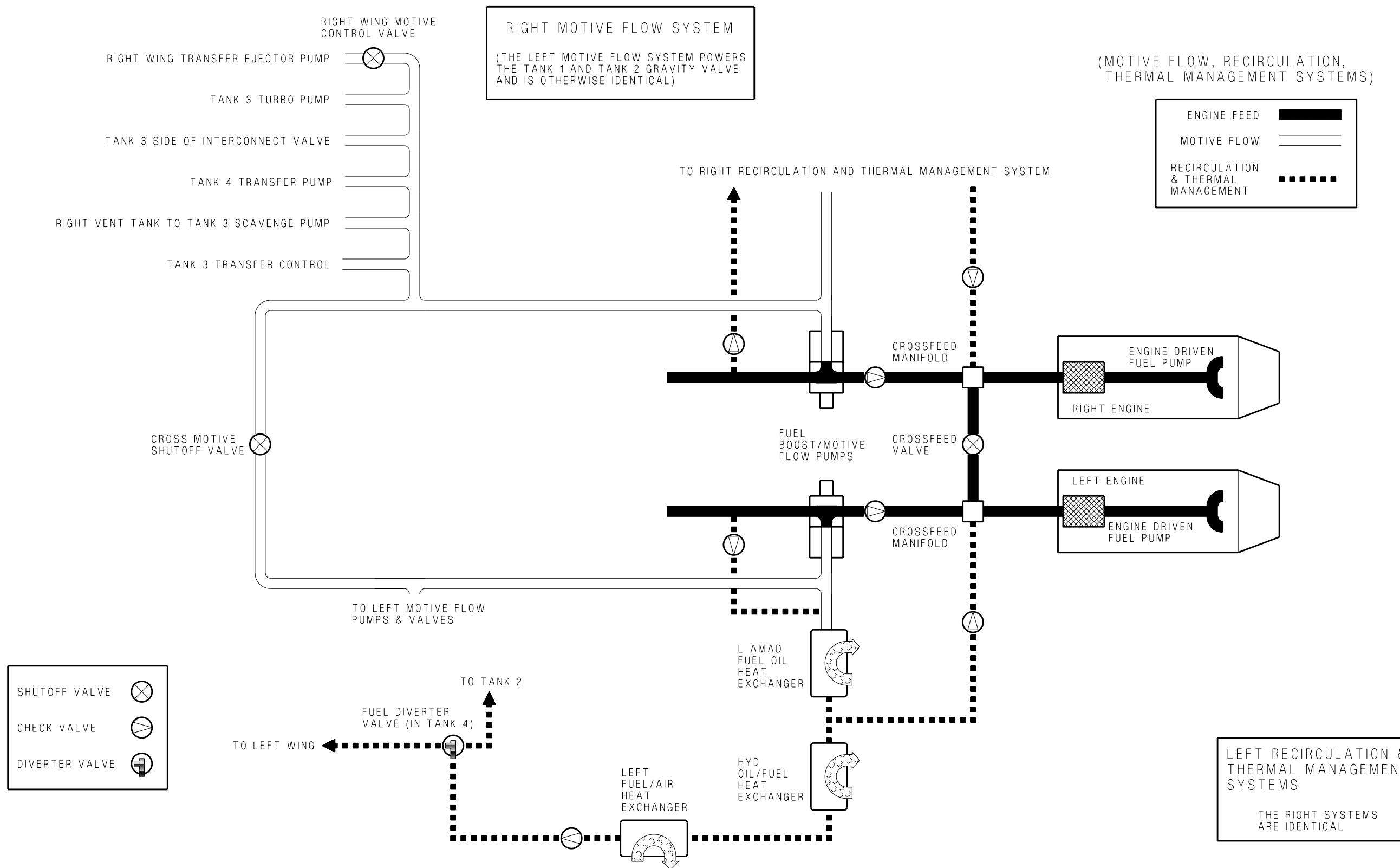

Figure FO-11. Fuel System (Sheet 2 of 3)

ADA520-107-2-043



ADA520-107-3-043

Figure FO-11. Fuel System (Sheet 3 of 3)

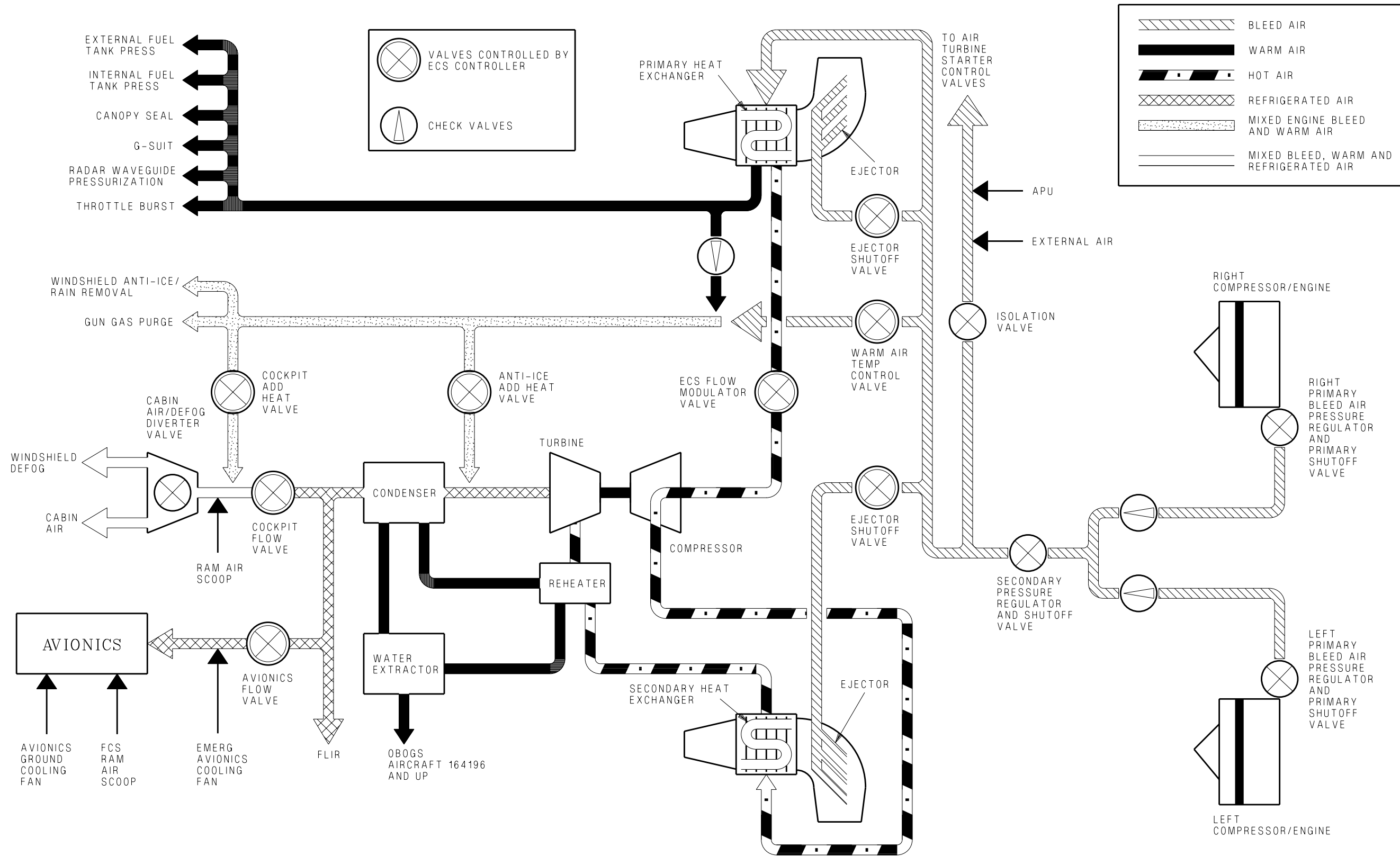

ADA520-356-1-043

Figure FO-12. Environmental Control System

FO-43 (Reverse Blank)

ORIGINAL

LIST OF EFFECTIVE PAGES

Effective Pages	Page Numbers	Effective Pages	Page Numbers
ORIGINAL	1 (Reverse Blank)	ORIGINAL	VI-20-1 Thru VI-20-4
ORIGINAL	3 (Reverse Blank)	ORIGINAL	VI-21-1 (Reverse Blank)
ORIGINAL	5 Thru 30	ORIGINAL	VI-22-1 Thru VI-22-2
ORIGINAL	31 (Reverse Blank)	ORIGINAL	71 (Reverse Blank)
ORIGINAL	33 (Reverse Blank)	ORIGINAL	VII-23-1 Thru VII-23-20
ORIGINAL	35 Thru 56	ORIGINAL	VII-24-1 Thru VII-24-81 (Reverse Blank)
ORIGINAL	58 (Obverse Blank)	ORIGINAL	VII-25-1 Thru VII-25-5 (Reverse Blank)
ORIGINAL	59 (Reverse Blank)	ORIGINAL	VII-26-1 Thru VII-26-9 (Reverse Blank)
ORIGINAL	I-1-1 Thru I-1-5 (Reverse Blank)	ORIGINAL	VII-27-1 Thru VII-27-5 (Reverse Blank)
ORIGINAL	I-2-1 Thru I-2-210	ORIGINAL	73 (Reverse Blank)
ORIGINAL	I-3-1 (Reverse Blank)	ORIGINAL	75 (Reverse Blank)
ORIGINAL	I-4-1 Thru I-4-12	ORIGINAL	IX-28-1 Thru IX-28-5 (Reverse Blank)
ORIGINAL	61 (Reverse Blank)	ORIGINAL	77 (Reverse Blank)
ORIGINAL	II-5-1 Thru II-5-2	ORIGINAL	X-29-1 Thru X-29-19 (Reverse Blank)
ORIGINAL	63 (Reverse Blank)	ORIGINAL	79 (Reverse Blank)
ORIGINAL	III-6-1 Thru III-6-3 (Reverse Blank)	ORIGINAL	A-1 Thru A-2
ORIGINAL	III-7-1 Thru III-7-39 (Reverse Blank)	ORIGINAL	Index-1 Thru Index-27 (Reverse Blank)
ORIGINAL	III-8-1 Thru III-8-18	ORIGINAL	FO-1 (Reverse Blank)
ORIGINAL	III-9-1 Thru III-9-17 (Reverse Blank)	ORIGINAL	FO-3 (Reverse Blank)
ORIGINAL	III-10-1 Thru III-10-48	ORIGINAL	FO-5 (Reverse Blank)
ORIGINAL	65 (Reverse Blank)	ORIGINAL	FO-7 (Reverse Blank)
ORIGINAL	IV-11-1 Thru IV-11-33 (Reverse Blank)	ORIGINAL	FO-9 (Reverse Blank)
ORIGINAL	67 (Reverse Blank)	ORIGINAL	FO-11 (Reverse Blank)
ORIGINAL	Em-Index-1 Thru Em-Index-4	ORIGINAL	FO-13 (Reverse Blank)
ORIGINAL	V-12-1 Thru V-12-54	ORIGINAL	FO-15 (Reverse Blank)
ORIGINAL	V-13-1 Thru V-13-4	ORIGINAL	FO-17 (Reverse Blank)
ORIGINAL	V-14-1 Thru V-14-7 (Reverse Blank)	ORIGINAL	FO-19 (Reverse Blank)
ORIGINAL	V-15-1 Thru V-15-65 (Reverse Blank)	ORIGINAL	FO-21 (Reverse Blank)
ORIGINAL	V-16-1 Thru V-16-21 (Reverse Blank)	ORIGINAL	FO-23 (Reverse Blank)
ORIGINAL	V-17-1 Thru V-17-39 (Reverse Blank)	ORIGINAL	FO-25 (Reverse Blank)
ORIGINAL	V-18-1 Thru V-18-5 (Reverse Blank)	ORIGINAL	FO-27 (Reverse Blank)
ORIGINAL	69 (Reverse Blank)	ORIGINAL	FO-29 (Reverse Blank)
ORIGINAL	VI-19-1 Thru VI-19-2	ORIGINAL	FO-31 (Reverse Blank)
		ORIGINAL	FO-33 (Reverse Blank)
		ORIGINAL	FO-35 (Reverse Blank)
		ORIGINAL	FO-37 (Reverse Blank)
		ORIGINAL	FO-39 (Reverse Blank)

LIST OF EFFECTIVE PAGES

Effective Pages	Page Numbers
ORIGINAL	FO-41 (Reverse Blank)
ORIGINAL	FO-43 (Reverse Blank)

Effective Pages	Page Numbers
ORIGINAL	LEP-1 (Reverse Blank)
ORIGINAL	LEP-3 (Reverse Blank)

