



NATOPS FLIGHT MANUAL

NAVY MODEL

F/A-18E/F

165533 AND UP

AIRCRAFT

THIS PUBLICATION SUPERSEDES A1-F18EA-NFM-000
DATED 1 DECEMBER 2004 CHANGED 1 AUGUST 2006

THIS PUBLICATION IS INCOMPLETE WITHOUT
A1-F18EA-NFM-200

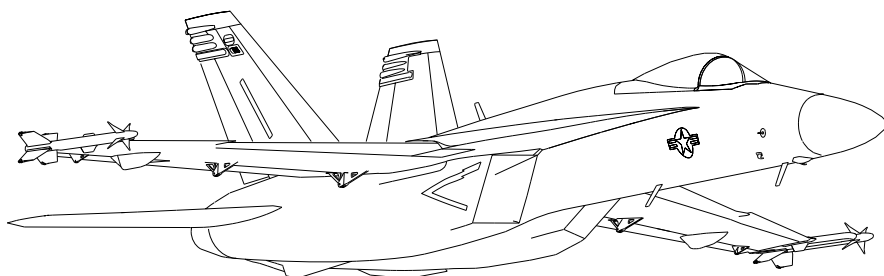

EFN520-1-1-001

DISTRIBUTION STATEMENT C. Distribution authorized to U.S. Government agencies only and their contractors to protect publications required for official use or for administrative or operational purposes only, determined on 15 September 2008. Other requests for this document shall be referred to Commander, Naval Air Systems Command (PMA-265), RADM William A. Moffett Bldg, 47123 Buse Rd, Bldg 2272, Patuxent River, MD 20670-1547.

DESTRUCTION NOTICE - For unclassified, limited documents, destroy by any method that will prevent disclosure of contents or reconstruction of the document.

ISSUED BY AUTHORITY OF THE CHIEF OF NAVAL OPERATIONS AND
UNDER THE DIRECTION OF THE COMMANDER
NAVAL AIR SYSTEMS COMMAND.

THE AIRCRAFT	1
INDOCTRINATION	2
NORMAL PROCEDURES	3
FLIGHT CHARACTERISTICS	4
EMERGENCY PROCEDURES	5
ALL - WEATHER OPERATION	6
COMMUNICATION PROCEDURES	7
WEAPONS SYSTEMS	8
FLIGHT CREW COORDINATION	9
NATOPS EVALUATION	10
PERFORMANCE DATA	11
INDEX & FOLDOUTS	



DEPARTMENT OF THE NAVY
NAVAL AIR SYSTEMS COMMAND
RADM WILLIAM A. MOFFETT BUILDING
47123 BUSE ROAD, BLDG 2272
PATUXENT RIVER, MD 20670-1547

15 September 2008

LETTER OF PROMULGATION

1. The Naval Air Training and Operating Procedures Standardization (NATOPS) Program is a positive approach toward improving combat readiness and achieving a substantial reduction in the aircraft mishap rate. Standardization, based on professional knowledge and experience, provides the basis for development of an efficient and sound operational procedure. The standardization program is not planned to stifle individual initiative, but rather to aid the Commanding Officer in increasing the unit's combat potential without reducing command prestige or responsibility.
2. This manual standardizes ground and flight procedures but does not include tactical doctrine. Compliance with the stipulated manual requirements and procedures is mandatory except as authorized herein. In order to remain effective, NATOPS must be dynamic and stimulate rather than suppress individual thinking. Since aviation is a continuing, progressive profession, it is both desirable and necessary that new ideas and new techniques be expeditiously evaluated and incorporated if proven to be sound. To this end, Commanding Officers of aviation units are authorized to modify procedures contained herein, in accordance with the waiver provisions established by OPNAV Instruction 3710.7, for the purpose of assessing new ideas prior to initiating recommendations for permanent changes. This manual is prepared and kept current by the users in order to achieve maximum readiness and safety in the most efficient and economical manner. Should conflict exist between the training and operating procedures found in this manual and those found in other publications, this manual will govern.
3. Checklists and other pertinent extracts from this publication necessary to normal operations and training should be made and carried for use in naval aircraft.

A handwritten signature in black ink, appearing to read "S. R. Eastburg", written over the typed name and title.

S. R. EASTBURG
Rear Admiral, United States Navy
By direction of
Commander, Naval Air Systems Command

NATOPS Flight Manual

CONTENTS

		Page No.
PART I	THE AIRCRAFT	
CHAPTER 1	The Aircraft	
1.1	AIRCRAFT DESCRIPTION	I-1-1
1.1.1	Meet The Super Hornet.	I-1-1
1.1.2	Aircraft Gross Weight.....	I-1-2
1.1.3	F/A-18F.	I-1-2
1.1.4	Radar Cross Section (RCS) Reduction.	I-1-3
1.2	BLOCK NUMBERS	I-1-4
CHAPTER 2	Systems	
2.1	POWER PLANT SYSTEMS	I-2-1
2.1.1	Engines.....	I-2-1
2.1.2	ATC - Automatic Throttle Control.....	I-2-10
2.2	FUEL SYSTEM	I-2-11
2.2.1	Engine Feed System.	I-2-12
2.2.2	Fuel Transfer System.....	I-2-13
2.2.3	Fuel Tank Pressurization and Vent.	I-2-16
2.2.4	Thermal Management System.	I-2-17
2.2.5	Refueling System.	I-2-18
2.2.6	Fuel Dump System.	I-2-18
2.2.7	Fuel Quantity Indicating System.....	I-2-19
2.2.8	Fuel Low Level Indicating System.	I-2-23
2.2.9	Fuel System Related Cautions.	I-2-24
2.3	FPAS - FLIGHT PERFORMANCE ADVISORY SYSTEM	I-2-24
2.3.1	FPAS Display.	I-2-24
2.3.2	FPAS CLIMB Option.....	I-2-25
2.3.3	FPAS HOME Waypoint Selection.	I-2-25
2.3.4	FPAS HOME FUEL Caution.	I-2-25
2.4	SECONDARY POWER SYSTEM.....	I-2-27
2.4.1	AMAD - Airframe Mounted Accessory Drive.....	I-2-27
2.4.2	APU - Auxiliary Power Unit.	I-2-28
2.4.3	APU Switch.	I-2-28
2.4.4	ATS Air Sources.....	I-2-28
2.4.5	AUG PULL.....	I-2-29
2.4.6	AMAD Related Cautions.....	I-2-29

2.5	ELECTRICAL POWER SUPPLY SYSTEM	I-2-30
2.5.1	Electrical RESET Button.....	I-2-30
2.5.2	AC Electrical Power.....	I-2-30
2.5.3	DC Electrical Power.....	I-2-32
2.5.4	External Electrical Power.....	I-2-34
2.5.5	Circuit Breakers.....	I-2-36
2.5.6	Electrical System Cautions and Caution Lights.....	I-2-36
2.6	LIGHTING	I-2-36
2.6.1	Exterior Lighting.....	I-2-36
2.6.2	Interior Lighting.....	I-2-40
2.6.3	Interior Lighting (F/A-18F).....	I-2-42
2.7	HYDRAULIC POWER SUPPLY SYSTEM.....	I-2-42
2.7.1	Hydraulic System.....	I-2-42
2.7.2	Hydraulic Accumulators.....	I-2-45
2.7.3	Hydraulic System Related Cautions and Caution Light.....	I-2-46
2.8	UTILITY HYDRAULIC FUNCTIONS	I-2-46
2.8.1	Landing Gear System.....	I-2-46
2.8.2	Nosewheel Steering System (NWS).....	I-2-49
2.8.3	Wheel Brake System.....	I-2-50
2.8.4	Launch Bar System.....	I-2-56
2.8.5	Arresting Hook System.....	I-2-58
2.9	WING FOLD SYSTEM	I-2-59
2.9.1	Wingfold Mechanism.....	I-2-59
2.9.2	Wingfold Operation.....	I-2-59
2.9.3	WINGFOLD Switch.....	I-2-60
2.9.4	Wingfold Overheat Cutout Protection.....	I-2-60
2.10	FCS - FLIGHT CONTROL SYSTEM	I-2-60
2.10.1	Flight Control Surfaces.....	I-2-61
2.10.2	FCCs - Flight Control Computers.....	I-2-61
2.10.3	FCS Redundancy and Survivability.....	I-2-63
2.10.4	CAS Operating Modes.....	I-2-64
2.10.5	Control Augmentation System (CAS).....	I-2-65
2.10.6	Speedbrake Function.....	I-2-67
2.10.7	G-Limiter Considerations.....	I-2-69
2.10.8	Air Data Function.....	I-2-72
2.10.9	Flight Controls.....	I-2-73
2.10.10	Yaw Rate Warning Tone.....	I-2-76
2.10.11	AOA Warning Tone.....	I-2-76
2.10.12	Spin Recovery System.....	I-2-76
2.10.13	Stabilator Failure Control Law Reconfiguration.....	I-2-78
2.10.14	GAIN ORIDE.....	I-2-78

		Page No.
2.10.15	FCS Failures.....	I-2-79
2.10.16	FCS Status Display.....	I-2-82
2.11	AFCS - AUTOMATIC FLIGHT CONTROL SYSTEM	I-2-84
2.11.1	AFCS Mode Selection.....	I-2-84
2.11.2	Basic Autopilot.	I-2-86
2.11.3	AFCS Mode Deselection.	I-2-86
2.11.4	Pitch-Axis Pilot Relief Modes.....	I-2-86
2.11.5	Roll-Axis Pilot Relief Modes.....	I-2-86
2.11.6	CPL - Coupled Steering Modes.	I-2-87
2.11.7	Coupled Data Link Modes.	I-2-87
2.11.8	AFCS Related Caution and Advisories.	I-2-87
2.12	WEAPON SYSTEMS CONTROLS	I-2-87
2.12.1	Stick Grip Switches/Controls (Front Cockpit).....	I-2-88
2.12.2	Stick Grip Switches/Controls (Trainer Configured F/A-18F).....	I-2-90
2.12.3	Throttle Grip Switches/Controls (Front Cockpit).....	I-2-90
2.12.4	Throttle Grip Switches/Controls (Trainer Configured Rear Cockpit). I-2-91	
2.12.5	Hand Controllers (Missionized Rear Cockpit Lots 21 thru 25).....	I-2-91
2.12.6	Hand Controllers (Rear Cockpit LOT 26 AND UP).	I-2-95
2.12.7	ALE-47 DISP Switch.	I-2-95
2.12.8	Grab Handle Chaff/Flare Dispense Switches (Rear Cockpit LOTs 21 thru 25).....	I-2-95
2.12.9	Grab Handle Chaff/Flare Dispense Switches (Rear Cockpit LOT 26 and up).....	I-2-95
2.13	ECS - ENVIRONMENTAL CONTROL SYSTEM	I-2-95
2.13.1	Bleed Air Shutoff Valves.....	I-2-95
2.13.2	Bleed Air Subsystem.....	I-2-96
2.13.3	Primary Heat Exchanger.....	I-2-97
2.13.4	Warm Air Subsystems.	I-2-97
2.13.5	Air Conditioning System (ACS) Pack.	I-2-97
2.13.6	Secondary Heat Exchanger.	I-2-98
2.13.7	Avionics Cooling Fans.	I-2-98
2.13.8	ECS Operating Modes.	I-2-99
2.13.9	Cabin Pressurization.....	I-2-103
2.13.10	Windshield Anti-ice and Rain Removal.	I-2-104
2.13.11	Anti-g System.	I-2-104
2.13.12	ECS RESET and AV COOL Switch.....	I-2-105
2.13.13	LCS - Liquid Cooling System.	I-2-105
2.13.14	ECS Related Warnings, Cautions, and Advisories.	I-2-106
2.14	OXYGEN SYSTEMS	I-2-107
2.14.1	On Board Oxygen Generating System (OBOGS).....	I-2-107
2.14.2	Emergency Oxygen.	I-2-110

2.15	FIRE DETECTION, FIRE EXTINGUISHING, AND BLEED AIR LEAK DETECTION SYSTEMS	I-2-111
2.15.1	FIRE Lights.....	I-2-111
2.15.2	APU FIRE Light.....	I-2-112
2.15.3	FIRE Warning Voice Alerts.....	I-2-112
2.15.4	FIRE EXTGH READY/DISCH Light.....	I-2-112
2.15.5	APU Fire Extinguishing System.....	I-2-113
2.15.6	Engine/AMAD Fire Extinguishing System.....	I-2-113
2.15.7	FIRE Detection System Test.....	I-2-113
2.15.8	Bleed Air Leak Detection (BALD) System.....	I-2-114
2.15.9	DBFS - Dry Bay Fire Suppression System.....	I-2-115
2.16	ENTRANCE/EGRESS SYSTEMS	I-2-115
2.16.1	Canopy System.....	I-2-115
2.16.2	Boarding Ladder.....	I-2-118
2.16.3	Ejection Seat.....	I-2-119
2.16.4	Ejection Seat System (F/A-18F).....	I-2-126
2.17	EMERGENCY EQUIPMENT	I-2-127
2.17.1	Jettison Systems.....	I-2-127
2.17.2	Warnings/Cautions/Advisories.....	I-2-129
2.17.3	Voice Alert System.....	I-2-130
2.17.4	Terrain Awareness Warning System (TAWS) (MC OFP 18E+ and H2E AND UP).....	I-2-131
2.17.5	GPWS - Ground Proximity Warning System.....	I-2-135
2.18	INSTRUMENTS	I-2-140
2.18.1	Standby Attitude Reference Indicator.....	I-2-140
2.18.2	Standby Airspeed Indicator.....	I-2-140
2.18.3	Standby Altimeter.....	I-2-140
2.18.4	Standby Rate of Climb Indicator.....	I-2-141
2.18.5	Standby Magnetic Compass.....	I-2-141
2.18.6	Angle Of Attack Indexer.....	I-2-141
2.19	AVIONICS SUBSYSTEM	I-2-142
2.19.1	Mission Computer System.....	I-2-142
2.19.2	Master Modes.....	I-2-146
2.19.3	Cockpit Controls and Displays.....	I-2-146
2.19.4	Multipurpose Display Group.....	I-2-146
2.19.5	Up Front Control Display (UFCD).....	I-2-166
2.19.6	SDC - Signal Data Computer.....	I-2-171
2.19.7	CVRS - Cockpit Video Recording System.....	I-2-171
2.19.8	Fast Tactical Imaging Set (FTI-II).....	I-2-178
2.20	TACTICAL AIRCRAFT MOVING MAP CAPABILITY (TAMMAC).....	I-2-178

2.20.1	TAMMAC Status Monitoring.....	I-2-179
2.20.2	AMU Maintenance Format Options and Display Information.	I-2-181
2.20.3	Map Theater Data Loading.....	I-2-181
2.20.4	Map Loading Format Options.....	I-2-181
2.20.5	Map Loading Format Status Information.	I-2-182
2.20.6	Map Loading Interruptions.	I-2-183
2.20.7	AMU/PC Cards Cautions and Advisories.....	I-2-184
2.21	COUNTERMEASURES DISPENSING SYSTEM	I-2-185
2.21.1	ALE-47 Countermeasures Dispensing Set.	I-2-185
2.21.2	ALE-50 Decoy Dispensing Set.	I-2-185
2.22	BIT-STATUS MONITORING SUBSYSTEM	I-2-186
2.22.1	FIRAMS - Flight Incident Recorder and Aircraft Monitoring Set. ...	I-2-186
2.22.2	DFIRS - Deployable Flight Incident Recorder Set.....	I-2-186
2.22.3	Avionics BIT.	I-2-186
2.22.4	Non-Avionic BIT.	I-2-201
2.22.5	Status Monitoring Backup.	I-2-201
2.22.6	Non-BIT Status.	I-2-202
2.23	JOINT HELMET MOUNTED CUEING SYSTEM (JHMCS)	I-2-205
2.23.1	Helmet Mounted Display (HMD)/Aft Helmet Mounted Display (AHMD).....	I-2-205
2.23.2	Electronics Unit (EU).....	I-2-208
2.23.3	Cockpit Unit (CU).....	I-2-208
2.23.4	Magnetic Transmitter Unit (MTU).	I-2-208
2.23.5	Boresight Reference Unit (BRU).....	I-2-208
2.23.6	Seat Position Sensor (SPS).	I-2-208
2.23.7	HMD/AHMD OFF/BRT Knobs.	I-2-208
2.23.8	HUD Video Record Panel.....	I-2-208
2.23.9	Cautions/Advisories.....	I-2-208
2.23.10	Configuration Check.	I-2-211
2.23.11	Built-In Test (BIT).....	I-2-211
2.23.12	JHMCS Alignment.	I-2-213
2.23.13	HMD/AHMD Symbology.	I-2-214
2.23.14	Navigation Master Mode.....	I-2-215
2.23.15	Mission Computer Failure.	I-2-218
2.23.16	Electronic Unit Failure.	I-2-218
2.23.17	Helmet Tracker Failure.....	I-2-221
2.23.18	Helmet Not Installed.	I-2-221

CHAPTER 3	Servicing and Handling	
3.1	SERVICING	I-3-1
CHAPTER 4	Operating Limitations	
4.1	LIMITATIONS OF THE BASIC AIRCRAFT	I-4-1
4.1.1	Engine Operation Limitations.	I-4-1
4.1.2	CG Limitations.	I-4-1
4.1.3	Airspeed Limitations.	I-4-1
4.1.4	Gross Weight and Lateral Weight Asymmetry Limitations.	I-4-3
4.1.5	AOA Limitations - Flaps AUTO.	I-4-5
4.1.6	Acceleration Limitations.	I-4-5
4.1.7	Limitations with Flaps HALF or FULL.	I-4-9
4.1.8	Refueling Limitation.	I-4-9
4.1.9	Prohibited Maneuvers.	I-4-9
4.2	EXTERNAL STORES LIMITATIONS	I-4-13
4.2.1	ARS Limitations	I-4-17
4.2.2	ATFLIR Limitations	I-4-19
4.3	OPERATING LIMITATIONS (LOT 21)	I-4-19
4.3.1	Prohibited Maneuvers	I-4-19
PART II	INDOCTRINATION	
CHAPTER 5	Indoctrination	
5.1	INITIAL QUALIFICATION	II-5-1
5.1.1	Minimum Ground Training Requirements.	II-5-1
5.1.2	Minimum Flight Training Requirements.	II-5-1
5.2	FOLLOW-ON TRAINING	II-5-1
5.3	CURRENCY REQUIREMENTS	II-5-2
5.3.1	Regaining Currency.	II-5-2
5.4	REQUIREMENTS FOR VARIOUS FLIGHT PHASES	II-5-2
5.4.1	Instrument Evaluation Flights.	II-5-2
5.4.2	Instrument Qualification.	II-5-2
5.4.3	Ceiling/Visibility Requirements.	II-5-3
5.5	WAIVERS	II-5-4
5.6	PERSONAL FLYING EQUIPMENT	II-5-4

PART III NORMAL PROCEDURES**CHAPTER 6 Flight Preparation**

6.1	MISSION PLANNING	III-6-1
6.1.1	General.....	III-6-1
6.1.2	Flight Codes.....	III-6-1
6.2	BRIEFING/DEBRIEFING	III-6-1
6.2.1	Briefing.....	III-6-1
6.2.2	Debriefing.....	III-6-4

CHAPTER 7 Shore-Based Procedures

7.1	PREFLIGHT CHECKS	III-7-1
7.1.1	In Maintenance Control.....	III-7-1
7.1.2	Inspection of RCS Reduction Features.....	III-7-1
7.1.3	Exterior Inspection.....	III-7-2
7.1.4	Before Entering Cockpit.....	III-7-8
7.1.5	Interior Checks - Pilot.....	III-7-11
7.1.6	Interior Checks - WSO.....	III-7-16
7.2	ENGINE START	III-7-18
7.2.1	Intercockpit Communications (F/A-18F).....	III-7-19
7.2.2	Engine Start Checks.....	III-7-19
7.3	BEFORE TAXI CHECKS	III-7-23
7.4	TAXI CHECKS	III-7-30
7.5	TAKEOFF	III-7-30
7.5.1	Before Takeoff Checks.....	III-7-30
7.5.2	Normal Takeoff.....	III-7-32
7.5.3	Crosswind Takeoff.....	III-7-34
7.5.4	After Takeoff Checks.....	III-7-34
7.6	AIRBORNE CHECKS	III-7-34
7.6.1	Climb.....	III-7-34
7.6.2	10,000 Foot Checks.....	III-7-34
7.6.3	Cruise.....	III-7-35
7.7	LANDING CHECKS	III-7-36
7.7.1	Descent/Penetration.....	III-7-36
7.7.2	VFR Landing Pattern Entry.....	III-7-39
7.7.3	VFR Landing Pattern and Approach.....	III-7-39
7.7.4	Pattern Adjustments.....	III-7-40
7.7.5	Final Approach.....	III-7-40

**Page
No.**

7.7.6	ATC Approaches.....	III-7-40
7.7.7	FPAH/ROLL - ATC Approaches.....	III-7-40
7.7.8	Full Stop Landings.	III-7-41
7.7.9	Braking Technique.	III-7-42
7.7.10	Heavy Gross Weight Landings.....	III-7-43
7.7.11	Crosswind Landings.	III-7-44
7.7.12	Wet Runway Landings.....	III-7-45
7.7.13	Asymmetric Stores Landings.....	III-7-45
7.8	POST-FLIGHT CHECKS	III-7-45
7.8.1	After Landing.	III-7-45
7.8.2	Hot Refueling.....	III-7-47
7.8.3	Before Engine Shutdown Checks.	III-7-47
7.8.4	Engine Shutdown Checks.	III-7-49
CHAPTER 8	Carrier-Based Procedures	
8.1	GENERAL.....	III-8-1
8.2	DAY OPERATIONS	III-8-1
8.2.1	Preflight Checks.....	III-8-1
8.2.2	Hangar Deck Operation.....	III-8-1
8.2.3	Engine Start.....	III-8-2
8.2.4	Catapult Trim.	III-8-3
8.2.5	Taxi.	III-8-9
8.2.6	Takeoff Checks.	III-8-9
8.2.7	Catapult Launch.	III-8-10
8.2.8	Landing Pattern.	III-8-12
8.3	ACL MODE 1 AND 1A APPROACHES.....	III-8-15
8.4	ACL MODE 2 APPROACH.....	III-8-18
8.5	ARRESTED LANDING AND EXIT FROM THE LANDING AREA.....	III-8-20
8.6	SECTION CCA	III-8-21
8.7	NIGHT OPERATIONS	III-8-21
8.7.1	General.....	III-8-21
8.7.2	Preflight.....	III-8-21
8.7.3	Before Taxi.....	III-8-21
8.7.4	Taxi.	III-8-21
8.7.5	Catapult Hook-Up.....	III-8-21
8.7.6	Catapult Launch.....	III-8-21
8.7.7	Catapult Suspend.....	III-8-23
8.7.8	Night Landings.....	III-8-23

8.7.9 Arrestment and Exit From the Landing Area. III-8-23

CHAPTER 9 Special Procedures

9.1 FORMATION FLIGHT III-9-1

9.1.1 Formation Taxi/Takeoff. III-9-1

9.1.2 Aborted Takeoff. III-9-1

9.1.3 Parade..... III-9-1

9.1.4 Balanced Cruise Formation. III-9-4

9.1.5 Section Approaches/Landing..... III-9-4

9.2 AIR REFUELING (RECEIVER)..... III-9-5

9.2.1 Air Refueling Checklist. III-9-5

9.2.2 Refueling Technique..... III-9-6

9.3 AIR REFUELING (TANKER)..... III-9-9

9.3.1 Air Refueling Store (ARS). III-9-9

9.3.2 ARS (Tanker) Procedures. III-9-12

9.3.3 ARS Jettison. III-9-18

9.3.4 ARS Limitations..... III-9-18

9.4 NIGHT VISION DEVICE (NVD) OPERATIONS III-9-18

9.4.1 Effects on Vision. III-9-18

9.4.2 Effects of Light..... III-9-18

9.4.3 Weather Conditions..... III-9-19

9.4.4 Object/Target Detection. III-9-19

9.4.5 Flight Preparation. III-9-19

9.5 SHORT AIRFIELD FOR TACTICAL SUPPORT (SATS) PROCEDURES III-9-19

9.5.1 Landing Pattern. III-9-19

9.5.2 Approach. III-9-19

9.5.3 Waveoff. III-9-19

9.5.4 Arrested Landing. III-9-19

9.5.5 Bolter. III-9-20

9.6 HOT SEAT PROCEDURE..... III-9-20

9.7 ALERT SCRAMBLE LAUNCH PROCEDURES..... III-9-20

9.7.1 Setting the Alert..... III-9-20

9.7.2 Alert Five Launch. III-9-21

9.8 AIRBORNE HMD ACCURACY CHECKS III-9-22

9.8.1 HMD Alignment..... III-9-22

9.8.2 Airborne HMD Accuracy Check with Radar. III-9-23

9.8.3 Airborne HMD Accuracy Check with CATM/AIM-9X. III-9-23

CHAPTER 10 Functional Checkflight Procedures

10.1	GENERAL	III-10-1
10.1.1	Engine Functional Checks.	III-10-1
10.1.2	Flight Control System Functional Checks.	III-10-1
10.1.3	Landing Gear Functional Checks.....	III-10-2
10.2	FCF REQUIREMENTS.....	III-10-2
10.3	FCF QUALIFICATIONS.....	III-10-2
10.4	FCF PROCEDURES	III-10-2
10.5	FCF CHECKLIST - PROFILE A	III-10-4
10.5.1	Plane Captain Brief.....	III-10-4
10.5.2	Preflight Checks.....	III-10-4
10.5.3	Pre-Start Checks.	III-10-5
10.5.4	Engine Start Checks.	III-10-6
10.5.5	Post-Start Checks.	III-10-7
10.5.6	Before Taxi Checks.	III-10-15
10.5.7	Taxi Checks.	III-10-19
10.5.8	Shipboard Taxi/Takeoff Checks.	III-10-20
10.5.9	Shorebased Takeoff Checks.	III-10-21
10.5.10	After Takeoff Checks.	III-10-21
10.5.11	Medium Altitude Checks (above 10,000 feet).....	III-10-22
10.5.12	10,000 Feet Checks.	III-10-24
10.5.13	High Altitude (above 30,000 feet).	III-10-27
10.5.14	10,000 Feet to Landing.	III-10-28
10.5.15	Landing Checks.	III-10-29
10.5.16	After Landing Checks.	III-10-29
10.5.17	Before Engine Shutdown Checks.	III-10-29
10.5.18	Engine Shutdown Checks.	III-10-30
10.6	FCF CHECKLIST - PROFILE C	III-10-31
10.6.1	10,000 Feet Checks.	III-10-31
10.7	FCF CHECKLIST - PROFILE D (REAR COCKPIT).....	III-10-32
10.7.1	Preflight Checks.....	III-10-32
10.7.2	Before Taxi Checks.	III-10-32
10.7.3	Taxi Checks.	III-10-32
10.7.4	Medium Altitude Checks (above 10,000 feet).	III-10-33
10.8	FCF CHECKLIST - PROFILE E	III-10-34
10.8.1	10,000 Feet Checks.	III-10-34

PART IV FLIGHT CHARACTERISTICS

CHAPTER 11 Flight Characteristics

11.1	HANDLING QUALITIES.	IV-11-1
11.1.1	Flight Control Mode Effects on Handling Qualities.	IV-11-1
11.1.2	Handling Qualities with Flaps HALF or FULL.....	IV-11-1
11.1.3	Flaps AUTO Handling Qualities.	IV-11-2
11.1.4	FLIR Carriage Handling Qualities.	IV-11-5
11.1.5	5-Wet (4-EFT and ARS) Loading Handling Qualities.	IV-11-6
11.1.6	Dual Midboard with Outboard Stores Handling Qualities.	IV-11-7
11.2	AIR COMBAT MANEUVERING.	IV-11-7
11.2.1	Air-to-Air Gun Tracking.	IV-11-7
11.2.2	Over-the-Top Maneuvering.	IV-11-7
11.2.3	Slow Speed Maneuvering.	IV-11-7
11.3	OUT-OF-CONTROL FLIGHT (OCF)	IV-11-8
11.3.1	Departure Resistance.	IV-11-8
11.3.2	Departure Characteristics.....	IV-11-8
11.3.3	Spin Characteristics.....	IV-11-9
11.4	DEGRADED MODE HANDLING QUALITIES.....	IV-11-10
11.4.1	Single Engine Operation.	IV-11-10
11.4.2	Leading Edge Flap Asymmetry.	IV-11-11
11.4.3	Trailing Edge Flap Failure.....	IV-11-13
11.4.4	Stabilator Failure.....	IV-11-14
11.4.5	GAIN ORIDE.	IV-11-15
11.4.6	AHRS Failure Flying Qualities.....	IV-11-16

PART V EMERGENCY PROCEDURES

EMERGENCY INDEX

CHAPTER 12 General Emergencies

12.1	GENERAL.....	V-12-1
12.1.1	Immediate Action Items.	V-12-1
12.1.2	Warnings, Cautions, and Advisories.	V-12-1

CHAPTER 13 Ground Emergencies

13.1	LOSS OF DC ESSENTIAL BUS.....	V-13-1
13.2	ENGINE FAILS TO START/HUNG START	V-13-1
13.3	HOT START	V-13-1

**Page
No.**

13.4	GROUND FIRE	V-13-2
13.4.1	HOT BRAKES/BRAKE FIRE.	V-13-2
13.5	EMERGENCY EGRESS	V-13-3
13.6	BRAKE FAILURE/EMERGENCY BRAKES	V-13-4
CHAPTER 14	Takeoff Emergencies	
14.1	EMERGENCY CATAPULT FLYAWAY	V-14-1
14.2	ABORT	V-14-2
14.3	GO AROUND	V-14-3
14.4	LOSS OF DIRECTIONAL CONTROL DURING TAKEOFF OR LANDING (BLOWN TIRE, NWS FAILURE)	V-14-4
14.5	LANDING GEAR FAILS TO RETRACT	V-14-5
CHAPTER 15	Inflight Emergencies	
15.1	AFTERBURNER FAILURE.....	V-15-1
15.2	RESTART	V-15-1
15.3	FUSELAGE FUEL LEAK	V-15-4
15.4	HYDRAULIC FAILURES	V-15-5
15.5	DOUBLE TRANSFORMER-RECTIFIER FAILURE	V-15-10
15.6	COCKPIT TEMPERATURE HIGH	V-15-15
15.7	COCKPIT SMOKE, FUMES, OR FIRE.....	V-15-16
15.8	HYPOXIA/LOW MASK FLOW/NO MASK FLOW	V-15-17
15.9	LOSS OF CABIN PRESSURIZATION.....	V-15-18
15.10	DISPLAY MALFUNCTION - NON-AMCD AIRCRAFT	V-15-18
15.11	DISPLAY MALFUNCTION - AMCD AIRCRAFT	V-15-19
15.12	DUAL MISSION COMPUTER (MC) FAILURE - AMCD AIRCRAFT	V-15-19
15.13	OUT-OF-CONTROL FLIGHT (OCF)	V-15-19

**Page
No.**

15.13.1	Departure from Controlled Flight.....	V-15-19
15.13.2	Spin.....	V-15-20
15.13.3	OCF Recovery Procedures.....	V-15-20
15.13.4	Post Departure Dive Recovery.....	V-15-21
15.14	CONTROLLABILITY CHECK	V-15-22
15.15	EXTERNAL STORES JETTISON	V-15-23
15.16	ARS MALFUNCTIONS.....	V-15-25
15.16.1	ARS Hose Fails to Retract.....	V-15-25
15.16.2	ARS Refueling Hose Jettison.....	V-15-25
15.16.3	ARS Hydraulic Pressure Light.....	V-15-25
15.16.4	No RDY Light.....	V-15-26
15.17	EMERGENCY TANKER DISENGAGEMENT	V-15-26
15.18	FCS FAILURE INDICATIONS AND EFFECTS.....	V-15-27
15.19	ANGLE OF ATTACK (AOA) FAILURE	V-15-44
15.19.1	AOA PROBE DAMAGE OR BINDING.....	V-15-45
15.19.2	AOA PROBE SELECTION	V-15-46
15.19.3	SINGLE AOA FAILURE ON TAKEOFF	V-15-46
15.19.4	DUAL AOA FAILURE ON TAKEOFF.	V-15-47
15.20	AILERON HINGE FAILURE - SUSPECTED, INBOARD.	V-15-47
15.20.1	Suspected Inboard Aileron Hinge Failure Corrective Action.....	V-15-48
CHAPTER 16	Landing Emergencies	
16.1	SINGLE ENGINE FAILURE IN LANDING CONFIGURATION ..	V-16-1
16.2	SINGLE ENGINE APPROACH AND LANDING.....	V-16-1
16.3	SINGLE ENGINE WAVEOFF/BOLTER	V-16-3
16.4	FORCED LANDING	V-16-4
16.5	LANDING GEAR UNSAFE/FAILS TO EXTEND.....	V-16-4
16.6	LANDING GEAR EMERGENCY EXTENSION	V-16-5
16.7	PLANING LINK FAILURE	V-16-12
16.8	ARRESTMENT - FIELD	V-16-13
16.8.1	Arresting Gear Types.....	V-16-13
16.8.2	Arrestment Decision.....	V-16-14

**Page
No.**

16.8.3	Arrestment - Short Field.....	V-16-14
16.8.4	Arrestment - Long Field.....	V-16-14
16.9	BARRICADE ARRESTMENT	V-16-14
16.10	CV RECOVERY MATRIX.....	V-16-15
CHAPTER 17	Ejection	
17.1	EJECTION	V-17-1
17.1.1	Ejection Seat Restrictions.....	V-17-1
17.1.2	Low Altitude Ejection.....	V-17-3
17.1.3	High Altitude Ejection.....	V-17-4
17.1.4	Ejection Procedures.....	V-17-4
17.2	DITCHING	V-17-4
17.3	SEAWATER ENTRY	V-17-4
CHAPTER 18	Immediate Action	
18.1	GENERAL.....	V-18-1
18.2	APU FIRE LIGHT	V-18-1
18.3	DUAL L BLEED and R BLEED WARNING LIGHTS//L/R ATS CAUTION	V-18-1
18.4	SINGLE L BLEED or R BLEED WARNING LIGHT	V-18-1
18.5	FIRE LIGHT	V-18-2
18.6	ENGINE CAUTIONS	V-18-2
18.7	L/R FUEL INLT CAUTION	V-18-2
18.8	HYD1 (2) HOT CAUTION	V-18-2
18.9	OBOGS DEGD CAUTION//HYPOXIA/LOW MASK FLOW/NO MASK FLOW//LOSS OF CABIN PRESSURIZATION/CABIN CAUTION LIGHT BELOW 47,000 FEET.....	V-18-2
18.10	HOT START	V-18-3
18.11	BRAKE FAILURE/EMERGENCY BRAKES	V-18-3
18.12	EMERGENCY CATAPULT FLYAWAY.....	V-18-3

**Page
No.**

18.13	ABORT	V-18-3
18.14	LOSS OF DIRECTIONAL CONTROL DURING TAKEOFF OR LANDING/ PLANING LINK FAILURE.....	V-18-3
18.15	COCKPIT SMOKE, FUMES, OR FIRE	V-18-4
18.16	OCF RECOVERY	V-18-4
18.17	SINGLE ENGINE FAILURE IN LANDING CONFIGURATION ..	V-18-4

PART VI ALL WEATHER PROCEDURES

CHAPTER 19 Instrument Flight

19.1	INSTRUMENT FLIGHT	VI-19-1
19.1.1	Before Takeoff.....	VI-19-1
19.1.2	Inflight.	VI-19-1
19.1.3	Approaches.	VI-19-2
19.2	DEGRADED SYSTEMS	VI-19-2

CHAPTER 20 Extreme Weather Procedures

20.1	ICE AND RAIN.....	VI-20-1
20.1.1	Ground Operation.	VI-20-1
20.1.2	In Flight.	VI-20-1
20.1.3	Landing in Heavy Rain.	VI-20-3
20.2	TURBULENT AIR AND THUNDERSTORM OPERATION	VI-20-4

CHAPTER 21 Hot Weather Procedures

21.1	GENERAL	VI-21-1
21.2	GROUND OPERATIONS	VI-21-1
21.3	IN FLIGHT	VI-21-1
21.4	DESCENT/RECOVERY	VI-21-2
21.5	AFTER LANDING	VI-21-2

CHAPTER 22 Cold Weather Procedures

22.1	EXTERIOR INSPECTION	VI-22-1
------	---------------------------	---------

**Page
No.**

22.2	BEFORE ENTERING COCKPIT	VI-22-1
22.3	INTERIOR CHECK	VI-22-1
22.4	ENGINE START	VI-22-1
22.5	BEFORE TAXI	VI-22-1
22.6	TAKEOFF	VI-22-2

PART VII COMM-NAV EQUIPMENT AND PROCEDURES

CHAPTER 23 Communication-Identification Equipment

23.1	MULTIFUNCTION INFORMATION DISTRIBUTION SYSTEM (MIDS)	VII-23-1
23.2	ICS - INTERCOM SYSTEM	VII-23-1
23.2.1	ICS Function Selector Switch (F/A-18F).....	VII-23-2
23.3	VHF/UHF COMMUNICATION SYSTEM	VII-23-2
23.3.1	VHF/UHF Controls and Indicators.	VII-23-3
23.3.2	COMM 1 and 2 Operation.	VII-23-8
23.3.3	Anti-Jam Operation.....	VII-23-13
23.4	HAVE QUICK SYSTEM	VII-23-14
23.4.1	Have Quick Menu From AJ Menu Fixed Frequency COMM Sublevel.	VII-23-14
23.4.2	SINGGARS Menu From AJ Menu Fixed Frequency COMM Sublevel.	VII-23-17
23.4.3	COMM Sublevel - Presets 1 Thru 20 (Anti-Jam).....	VII-23-18
23.4.4	AJ MENU From Have Quick COMM Sublevel.....	VII-23-20
23.5	SINGGARS SYSTEM	VII-23-20
23.5.1	AJ MENU From SINGGARS COMM Sublevel.	VII-23-21
23.5.2	Guard Transmit on Top Level CNI Format.	VII-23-23
23.6	KY-58 - SECURE SPEECH SYSTEM	VII-23-23
23.6.1	KY-58 Control Panel Assembly.	VII-23-23
23.6.2	KY-58 Controls and Indicators.....	VII-23-25
23.6.3	KY-58 Operation.	VII-23-25
23.7	DIGITAL COMMUNICATION SYSTEM (DCS).....	VII-23-27
23.7.1	VHF/UHF Communication System - DCS.	VII-23-27
23.7.2	DCS COMSEC (Communications Security).	VII-23-28
23.7.3	UFCD - DCS.	VII-23-29

**Page
No.**

23.7.4	Relay Mode Of Operation.....	VII-23-29
23.7.5	DCS - Avionics Subsystem.....	VII-23-31
23.8	IDENTIFICATION FRIEND OR FOE (IFF)/COMBINED INTERROGATOR TRANSPONDER (CIT)	VII-23-32
23.8.1	IFF Transponder.	VII-23-32
23.8.2	IFF Interrogator.	VII-23-43
23.8.3	IFF BIT.	VII-23-43
23.8.4	IFF Programming (IFF PROG) Page.....	VII-23-43
23.8.5	IFF Controls.....	VII-23-46
23.8.6	IFF Related Cautions and Advisories.	VII-23-48
23.9	COMMUNICATION-NAVIGATION-IDENTIFICATION INTERFACE	VII-23-48
CHAPTER 24	Navigation Equipment	
24.1	NAVIGATION CONTROLS AND INDICATORS.....	VII-24-1
24.1.1	UFCD Navigation Controls.	VII-24-1
24.1.2	Moving Map - Digital Map Set (DMS).....	VII-24-1
24.1.3	HSI Format.	VII-24-2
24.1.4	HSI Format on a DDI.	VII-24-9
24.1.5	HUD - Navigation Information.	VII-24-9
24.1.6	CRS Select Switch.....	VII-24-10
24.1.7	IFF Control Panel.	VII-24-10
24.2	INERTIAL NAVIGATION SYSTEM (INS)/GLOBAL POSITIONING SYSTEM (GPS)	VII-24-10
24.2.1	Inertial Navigation System (INS).	VII-24-11
24.2.2	Global Positioning System (GPS).....	VII-24-11
24.2.3	Inertial Alignment Modes.....	VII-24-11
24.2.4	24.2.4 Navigation System BIT.	VII-24-23
24.2.5	NAVCK Display.	VII-24-23
24.2.6	GPS Page.	VII-24-24
24.2.7	INS Knob.	VII-24-25
24.2.8	INS/GPS Related Cautions and Advisories.	VII-24-25
24.2.9	Waypoints, Offset Aimpoints (OAP), and Offsets.....	VII-24-26
24.2.10	Aircraft (A/C) Programming.	VII-24-35
24.2.11	Position Keeping.	VII-24-37
24.2.12	Position Updating.	VII-24-38
24.2.13	NAV/TAC Bank Limit Options.	VII-24-39
24.2.14	Steering.	VII-24-39
24.2.15	Designation.....	VII-24-47
24.2.16	INS Updates (not available in AINS).	VII-24-50
24.3	ADF (AUTOMATIC DIRECTION FINDER)	VII-24-51

24.4	TACAN (TACTICAL AIR NAVIGATION).....	VII-24-52
24.4.1	TACAN BIT.....	VII-24-53
24.4.2	TACAN Mode Selection.....	VII-24-53
24.4.3	TACAN Programming.....	VII-24-53
24.4.4	TACAN Position Keeping.....	VII-24-54
24.4.5	TACAN Position Updating.....	VII-24-54
24.5	INSTRUMENT CARRIER LANDING SYSTEM (ICLS)	VII-24-54
24.5.1	ICLS Receiver.....	VII-24-54
24.5.2	ICLS Decoder.....	VII-24-58
24.5.3	ICLS BIT.....	VII-24-58
24.5.4	ICLS Initialization.....	VII-24-58
24.5.5	ICLS Steering.....	VII-24-59
24.6	DATA LINK SYSTEM	VII-24-59
24.6.1	Automatic Carrier Landing Mode.....	VII-24-59
24.7	NAVIGATION DATA ENTRY	VII-24-70
24.7.1	Standard Data Entry.....	VII-24-78
24.7.2	Fast Data Entry.....	VII-24-78
24.7.3	Data Entry Using the Shifted Keypad.....	VII-24-78
CHAPTER 25	Backup/Degraded Operations	
25.1	MISSION COMPUTER FAILURE	VII-25-1
25.1.1	Mission Computer Failure (Non-AMCD Aircraft).....	VII-25-1
25.1.2	Mission Computer Failure (AMCD Aircraft).....	VII-25-1
25.2	BACKUP ATTITUDE AND NAVIGATION SYSTEM	VII-25-2
25.2.1	Standby Attitude Reference Indicator.....	VII-25-2
25.2.2	Static Power Inverter.....	VII-25-3
25.2.3	Magnetic Azimuth Detector.....	VII-25-3
25.2.4	Backup Attitude and Navigation System Controls and Indicators. ...	VII-25-3
25.3	NAVIGATION BACKUP	VII-25-4
25.3.1	Navigation Controls and Indicators.....	VII-25-5
25.3.2	Backup Heading Mode Control.....	VII-25-5
25.4	BACKUP FREQUENCY CONTROL	VII-25-6
CHAPTER 26	Visual Communications	
CHAPTER 27	Deck/Ground Handling Signals	
PART VIII	WEAPONS SYSTEMS	
PART IX	FLIGHT CREW COORDINATION	

CHAPTER 28	Aircrew Coordination	
28.1	DEFINITION	IX-28-1
28.2	CRITICAL SKILLS OF AIRCREW COORDINATION	IX-28-1
28.2.1	Situation Awareness.	IX-28-1
28.2.2	Assertiveness.	IX-28-1
28.2.3	Decision-Making.....	IX-28-1
28.2.4	Communication.....	IX-28-1
28.2.5	Leadership.....	IX-28-1
28.2.6	Adaptability/Flexibility.....	IX-28-1
28.2.7	Mission Analysis.....	IX-28-2
28.2.8	Factors That Degrade Aircrew Coordination.	IX-28-2
28.3	FLIGHT MEMBER POSITIONS	IX-28-2
28.3.1	Mission Commander.	IX-28-2
28.3.2	Pilot In Command.....	IX-28-2
28.3.3	Formation Leader.....	IX-28-2
28.3.4	Weapon Systems Operator (WSO).	IX-28-3
28.4	AIRCREW RESPONSIBILITIES BY FLIGHT PHASE.....	IX-28-3
28.4.1	Mission Planning and Briefing.....	IX-28-3
28.4.2	Pretakeoff.	IX-28-3
28.4.3	Takeoff/Departure.....	IX-28-3
28.4.4	Enroute.....	IX-28-3
28.4.5	Recovery.....	IX-28-4
28.4.6	Mission Critique.....	IX-28-4
28.5	SPECIAL CONSIDERATIONS	IX-28-4
28.5.1	Functional Checkflights.....	IX-28-4
28.5.2	Formation Flights.....	IX-28-4
28.6	EMERGENCIES	IX-28-4
CHAPTER 29	Crew Coordination Standards	
29.1	PHILOSOPHY	IX-29-1
29.2	MISSION PLANNING	IX-29-1
29.3	CREW BRIEFING	IX-29-1
29.4	COMMUNICATIONS	IX-29-1
29.4.1	Intra-Cockpit Communications (ICS).	IX-29-1
29.4.2	Guidelines for Effective Communications.	IX-29-2
29.5	PRE-FLIGHT	IX-29-2

**Page
No.**

29.6	FLIGHT PHASES	IX-29-2
29.6.1	Start/Taxi/Takeoff.	IX-29-2
29.6.2	Departure.	IX-29-3
29.6.3	Rendezvous and Formation.	IX-29-3
29.6.4	Cruise.	IX-29-4
29.6.5	Inflight Refueling.	IX-29-4
29.6.6	Approach.	IX-29-5
29.6.7	Landing.	IX-29-6
29.6.8	Post Flight.	IX-29-7
29.7	DEBRIEFING	IX-29-7
29.8	SPECIAL CONSIDERATIONS	IX-29-7
29.8.1	Functional Check Flights	IX-29-7
29.8.2	Emergencies.	IX-29-7
29.9	STANDARD ICS TERMS	IX-29-8
 PART X NATOPS EVALUATION		
 CHAPTER 30 NATOPS Evaluation		
30.1	CONCEPT	X-30-1
30.1.1	Implementation.....	X-30-1
30.1.2	Definitions.....	X-30-1
30.2	GROUND EVALUATION	X-30-2
30.2.1	General.....	X-30-2
30.3	FLIGHT EVALUATION	X-30-3
30.3.1	Mission Planning/Briefing.	X-30-3
30.3.2	Preflight/Line Operations.....	X-30-3
30.3.3	Taxi.	X-30-4
30.3.4	Takeoff (*).	X-30-4
30.3.5	Climb/Cruise.	X-30-4
30.3.6	Approach/Landing (*).	X-30-4
30.3.7	Communications.....	X-30-4
30.3.8	Emergency/Malfunction Procedures (*).	X-30-4
30.3.9	Post Flight Procedures.....	X-30-4
30.3.10	Mission Evaluation.	X-30-4
30.3.11	Applicable Publications.....	X-30-4
30.3.12	Flight Evaluation Grading Criteria.....	X-30-5
30.3.13	Flight Evaluation Grade Determination.....	X-30-5
30.4	NATOPS EVALUATION QUESTION BANK	X-30-6

PART XI PERFORMANCE DATA

APPENDIX A

APPENDIX B

Aircraft Differences(LOTs 21 - 22 Aircraft)

FOLDOUTS

LIST OF ILLUSTRATIONS

	Page No.
PART I	THE AIRCRAFT
CHAPTER 1	The Aircraft
Figure 1-1	General Arrangement..... I-1-1
Figure 1-2	Approximate Dimensions I-1-2
Figure 1-3	Radar Cross Section (RCS) Reduction I-1-3
Figure 1-4	LOT NUMBER/BUNO I-1-5
CHAPTER 2	Systems
Figure 2-1	Throttle Grips (Front Cockpit) I-2-7
Figure 2-2	Engine Fuel Display (EFD) - Engine Parameters I-2-8
Figure 2-3	Engine Display I-2-10
Figure 2-4	Tank 1 and 4 Fuel CG Control and FUEL XFER Caution Schedule . I-2-15
Figure 2-5	Fuel Quantity I-2-20
Figure 2-6	Engine Fuel Display (EFD) - Fuel Parameters..... I-2-22
Figure 2-7	FUEL Display..... I-2-23
Figure 2-8	FPAS Displays I-2-26
Figure 2-9	Secondary Power Supply I-2-27
Figure 2-10	Simplified Electrical Schematic..... I-2-31
Figure 2-11	FCC Electrical Redundancy I-2-34
Figure 2-12	Ground Power Panel and Placard I-2-35
Figure 2-13	Circuit Breaker Panels I-2-36
Figure 2-14	Exterior Lights..... I-2-37
Figure 2-15	ID Strobe Patterns I-2-39
Figure 2-16	Hydraulic Flow..... I-2-43
Figure 2-17	Wheel Brake and Anti-skid System..... I-2-52
Figure 2-18	Emergency/Parking Brake Handle..... I-2-55
Figure 2-20	Flight Control System Functional Diagram I-2-62
Figure 2-21	Flap Schedules I-2-67
Figure 2-22	G-Limiter G-Bucket Reductions in Maximum Commandable G-Level I-2-71
Figure 2-23	Stick and Pedal Travel Limits I-2-73
Figure 2-24	Stick Grip FCS Controls..... I-2-75
Figure 2-25	SPIN Recovery Display..... I-2-77
Figure 2-26	GAIN ORIDE Flap Positions and Gain Schedules I-2-79
Figure 2-27	FCS Related Cautions and Cockpit Indications I-2-81
Figure 2-28	FCS Status Display..... I-2-82
Figure 2-29	AFCS Controls and Indicators..... I-2-85
Figure 2-30	Stick Grip Switches/Controls I-2-88
Figure 2-31	Throttle Grip Switches/Controls (Front Cockpit) I-2-90
Figure 2-32	Hand Controllers..... I-2-93

Figure 2-33	OBOGS Monitor	I-2-108
Figure 2-34	Canopy Controls	I-2-117
Figure 2-35	Boarding Ladder	I-2-120
Figure 2-36	SJU-17 and SJU-17A Ejection Modes	I-2-121
Figure 2-37	Leg Restraint System.....	I-2-123
Figure 2-38	Survival Kit	I-2-124
Figure 2-39	HSI-DATA-A/C Controls.....	I-2-132
Figure 2-40	TAWS HUD Visual Recovery Warning - Pull Up (VRT).....	I-2-134
Figure 2-41	TAWS HUD Visual Recovery Warning - Pull Up (ORT).....	I-2-135
Figure 2-42	TAWS HUD Visual Recovery Warning (VRT).....	I-2-136
Figure 2-43	GPWS HUD Roll Warning Cues.....	I-2-138
Figure 2-44	GPWS Aural Cues.....	I-2-139
Figure 2-45	Angle of Attack Indexer	I-2-141
Figure 2-46	MUMI Display	I-2-144
Figure 2-47	MENU Format.....	I-2-149
Figure 2-48	Electronic Attitude Display Indicator.....	I-2-150
Figure 2-49	8 x 10 Display	I-2-152
Figure 2-50	MPCD Controls and HSI Symbology	I-2-154
Figure 2-51	HUD Controls.....	I-2-156
Figure 2-52	HUD Symbology	I-2-159
Figure 2-53	HUD Symbology Degrades	I-2-164
Figure 2-54	Alphanumeric Entry Format.....	I-2-168
Figure 2-55	Up Front Control Display (UFCD)	I-2-169
Figure 2-56	Forward CVRS Control Panel (LOTs 21-22)	I-2-173
Figure 2-57	Forward CVRS Control Panel (LOTs 23-25 Before AFC 445)	I-2-174
Figure 2-58	Aft CVRS Control Panel (LOTs 21-22) and LOTs 23-25 Before AFC 445.	I-2-174
Figure 2-59	Forward CVRS Control Panel (LOTs 23-24 After AFC 445).....	I-2-175
Figure 2-60	Forward CVRS Control Panel (LOT 25 After AFC 445	I-2-175
Figure 2-61	Aft CVRS Control Panel (LOT 23-25 After AFC 445).....	I-2-176
Figure 2-62	Fwd CVRS Control Panel (LOT 26 AND UP)	I-2-176
Figure 2-63	Aft CVRS Control Panel (LOTs 26-29 Before AFC 445)	I-2-177
Figure 2-64	Aft CVRS Control Panel (LOTs 26-29 After AFC 445 AND LOT 30 AND UP)	I-2-177
Figure 2-65	Video Display Routing	I-2-180
Figure 2-66	AMU Maintenance Format	I-2-181
Figure 2-67	Map Loading Format.....	I-2-182
Figure 2-68	Flight Aids Reversion Mechanization	I-2-187
Figure 2-69	Equipment Status Messages	I-2-189
Figure 2-70	Caution/Advisory Displays	I-2-190
Figure 2-71	BIT Control Display.....	I-2-191
Figure 2-72	MPCD and UFCD Test Patterns	I-2-198
Figure 2-73	EFD Test Pattern	I-2-199
Figure 2-74	UFCD Test Pattern	I-2-200
Figure 2-75	CONFIG Display (Sample)	I-2-202
Figure 2-76	INS Postflight Data Display.....	I-2-204

**Page
No.**

Figure 2-77	JHMCS Upper HVI Routing	I-2-207
Figure 2-78	HMD Controls	I-2-209
Figure 2-79	Boresight Reference Unit	I-2-210
Figure 2-80	Displays BIT Sublevel	I-2-211
Figure 2-81	HMD/AHMD Test Patterns	I-2-212
Figure 2-82	Coarse Alignment	I-2-216
Figure 2-83	Fine Alignment	I-2-219
Figure 2-84	Alignment Verification	I-2-221

CHAPTER 4 Operating Limitations

Figure 4-1	Engine Operation Limitations	I-4-1
Figure 4-2	Basic Aircraft Airspeed Limitations	I-4-2
Figure 4-3	Subsystem Airspeed Limitations	I-4-2
Figure 4-4	Gross Weight and Lateral Weight Asymmetry Limitations	I-4-3
Figure 4-5	Asymmetric Stores Limitations	I-4-4
Figure 4-6	AOA Limitations - Flaps AUTO	I-4-5
Figure 4-7	Acceleration Limitations - Basic Aircraft (with or without empty pylons)	I-4-6
Figure 4-8	Limitations with Flaps HALF or FULL	I-4-9
Figure 4-9	Station 6 480-Gal External Fuel Tank Carriage Limits E	I-4-13
Figure 4-10	Station 4/8 480-Gal External Fuel Tank Carriage Limits (Rev B Pylons)	I-4-14
Figure 4-11	Station 4/8 480-Gal External Fuel Tank Carriage Limits (Rev A Pylons)	I-4-15
Figure 4-12	Air Refueling Store Carriage Limits	I-4-16
Figure 4-13	ARS Operating Limitations	I-4-17
Figure 4-14	ATFLIR Limitations	I-4-19

PART II INDOCTRINATION

CHAPTER 5 Indoctrination

Figure 5-1	Requirements for Various Flight Phases During Initial Training	II-5-2
Figure 5-2	Pilot Ceiling and Visibility Restrictions Prior to Instrument Qualification	II-5-3

PART III NORMAL PROCEDURES

CHAPTER 7 Shore-Based Procedures

Figure 7-1	Exterior Inspection	III-7-2
Figure 7-2	Checklist Display	III-7-31
Figure 7-3	Typical Field Landing Pattern	III-7-38

CHAPTER 8	Carrier-Based Procedures	
Figure 8-1	Launch Trim	III-8-4
Figure 8-2	Carrier Landing Pattern	III-8-13
Figure 8-3	Carrier Controlled Approach	III-8-17
Figure 8-4	ACL Mode 1 and 1A Approaches	III-8-19
Figure 8-5	ACL Mode 2 Approach	III-8-22
CHAPTER 9	Special Procedures	
Figure 9-1	Formation Takeoff Runway Alignments	III-9-2
Figure 9-2	Formations	III-9-3
Figure 9-3	ARS Control Panel	III-9-9
CHAPTER 10	Functional Checkflight Procedures	
Figure 10-1	Functional Checkflight Requirements	III-10-3
PART IV	FLIGHT CHARACTERISTICS	
CHAPTER 11	Flight Characteristics	
Figure 11-1	AHRS Channel Failure Indication and Effects	IV-11-17
PART V	EMERGENCY PROCEDURES	
CHAPTER 12	General Emergencies	
Figure 12-1	Warning/Caution/Advisory Displays	V-12-3
CHAPTER 14	Takeoff Emergencies	
Figure 14-1	Maximum Weight for 100 fpm Single Engine Rate of Climb	V-14-4
CHAPTER 15	Inflight Emergencies	
Figure 15-1	Spooldown Restart Envelope	V-15-2
Figure 15-2	Windmill Restart Envelope	V-15-2
Figure 15-3	Crossbleed Restart Envelope	V-15-3
Figure 15-4	APU Restart Envelope	V-15-3
Figure 15-5	Hydraulic Flow Diagram (Aircraft on Deck)	V-15-6
Figure 15-6	Hydraulic Subsystems Malfunction Guide	V-15-7
Figure 15-7	Flight Control Effects Due To Hydraulic Failure	V-15-8
Figure 15-8	Emergency Power Distribution	V-15-11
Figure 15-9	External Stores Jettison Chart	V-15-24
Figure 15-10	FCS Failure Indications and Effects	V-15-27
Figure 15-11	FCS Failure Indications and Effects - Channel 2	V-15-28

**Page
No.**

Figure 15-12	FCS Failure Indications and Effects - Channel 3.....	V-15-28
Figure 15-13	FCS Failure Indications and Effects - Channel 4.....	V-15-29
Figure 15-14	FCS Failure Indications and Effects - Channels 1 and 2	V-15-29
Figure 15-15	FCS Failure Indications and Effects - Channels 1 and 3	V-15-30
Figure 15-16	FCS Failure Indications and Effects - Channels 1 and 4	V-15-30
Figure 15-17	FCS Failure Indications and Effects - Channels 2 and 3	V-15-31
Figure 15-18	FCS Failure Indications and Effects - Channels 2 and 4	V-15-32
Figure 15-19	FCS Failure Indications and Effects	V-15-33
Figure 15-20	FCS Failure Indications and Effects	V-15-33
Figure 15-21	FCS Failure Indications and Effects	V-15-34
Figure 15-22	FCS Failure Indications and Effects	V-15-34
Figure 15-23	FCS Failure Indications and Effects	V-15-35
Figure 15-24	FCS Failure Indications and Effects	V-15-35
Figure 15-25	FCS Failure Indications and Effects	V-15-36
Figure 15-26	FCS Failure Indications and Effects	V-15-36
Figure 15-27	FCS Failure Indications and Effects	V-15-37
Figure 15-28	FCS Failure Indications and Effects	V-15-37
Figure 15-29	FCS Failure Indications and Effects	V-15-38
Figure 15-30	FCS Failure Indications and Effects	V-15-38
Figure 15-31	FCS Failure Indications and Effects - Aileron Channels 1 and 2 or 3 and 4.....	V-15-39
Figure 15-32	FCS Failure Indications and Effects - Aileron Channels 1 and 4 or 2 and 3.....	V-15-39
Figure 15-33	FCS Failure Indications and Effects - LEF Channels 1 and 4 or 2 and 3.....	V-15-40
Figure 15-34	FCS Failure Indications and Effects - AOA Channel 4	V-15-40
Figure 15-35	FCS Failure Indications and Effects	V-15-41
Figure 15-36	FCS Failure Indications and Effects	V-15-41
Figure 15-37	FCS Failure Indications and Effects	V-15-42
Figure 15-38	FCS Failure Indications and Effects	V-15-42
Figure 15-39	FCS Failure Indications and Effects	V-15-43
Figure 15-40	FCS Failure Indications and Effects	V-15-43
Figure 15-41	FCS Failure Indications and Effects	V-15-44

CHAPTER 16 Landing Emergencies

Figure 16-1	Maximum Single Engine Recovery Weight - Military Thrust.....	V-16-7
Figure 16-2	Maximum Single Engine Recovery Weight - Maximum Thrust.....	V-16-8
Figure 16-3	Landing Gear Emergency Flow Chart.....	V-16-9
Figure 16-4	Landing Gear Malfunction – Landing Guide.....	V-16-10
Figure 16-5	Field Arresting Gear Data	V-16-16
Figure 16-6	CV Recovery Matrix.....	V-16-18

CHAPTER 17 Ejection

Figure 17-1	Sink Rate Effects on Minimum Ejection Altitude.....	V-17-5
-------------	---	--------

**Page
No.**

Figure 17-2	Airspeed and Bank Angle Effects on Minimum Ejection Altitude	V-17-7
Figure 17-3	Airspeed and Dive Angle Effects on Minimum Ejection Altitude	V-17-9
Figure 17-4	Ejection Procedures	V-17-11
Figure 17-5	Ditching Procedures	V-17-24

PART VI ALL WEATHER PROCEDURES

CHAPTER 20 Extreme Weather Procedures

Figure 20-1	Icing Danger Zone	VI-20-2
-------------	-----------------------------	---------

PART VII COMM-NAV EQUIPMENT AND PROCEDURES

CHAPTER 23 Communication-Identification Equipment

Figure 23-1	Aft Cockpit Rudder Pedal Switches - Lot 26 and up	VII-23-3
Figure 23-2	Top Level CNI Format on Up Front Control Display (UFCD)	VII-23-5
Figure 23-3	COMM Sublevel - Ship Maritime Preset	VII-23-9
Figure 23-4	COMM Sublevel - Guard and Cue Presets	VII-23-10
Figure 23-5	COMM Sublevel - Manual Preset	VII-23-11
Figure 23-6	COMM Sublevel - Presets 1 Thru 20 (Fixed Frequency)	VII-23-12
Figure 23-7	AJ MENU From Fixed Frequency COMM Sublevel	VII-23-13
Figure 23-8	Have Quick Fixed Frequency Sublevel	VII-23-15
Figure 23-9	Have Quick WOD Loading	VII-23-16
Figure 23-10	Have Quick TNET Loading	VII-23-17
Figure 23-11	Single Channel Ground and Airborne Radio System (SINCGARS) MENU Fixed Frequency Sublevel	VII-23-18
Figure 23-12	COMM Sublevel - Presets 1 to 20 (Anti-Jam)	VII-23-19
Figure 23-13	AJ MENU From Have Quick COMM Sublevel	VII-23-20
Figure 23-14	AJ Have Quick Menu Sublevel	VII-23-21
Figure 23-15	AJ MENU From SINCGARS COMM Sublevel	VII-23-22
Figure 23-16	AJ SINCGARS ERF Sublevel	VII-23-22
Figure 23-17	Guard Transmit on Top Level CNI Format	VII-23-24
Figure 23-18	Guard Transmit on COMM Sublevel	VII-23-24
Figure 23-19	KY-58 Control Panel Assembly	VII-23-25
Figure 23-20	DCS Frequencies Conversions	VII-23-27
Figure 23-21	DCS KEY Display	VII-23-30
Figure 23-22	Relay Bandwidth Limitations	VII-23-31
Figure 23-23	MUMI Displays	VII-23-33
Figure 23-24	BIT Displays	VII-23-34
Figure 23-25	IFF Transponder UFCD Sublevel	VII-23-36
Figure 23-26	Mode 3 and Mode C Selection	VII-23-37
Figure 23-27	Electronic Boresight Constant (EBC) Display with W on W	VII-23-39
Figure 23-28	XPOND Format Selection to Enable Mode S Enhanced and Squitter	VII-23-40

**Page
No.**

Figure 23-29	Return to XPOND Format with Squitter Disabled	VII-23-41
Figure 23-30	Mode S UFCD Sublevel	VII-23-42
Figure 23-31	Mode S Address Not Available on XPOND Sublevel	VII-23-43
Figure 23-32	Mode S A/C Call Sign Sublevel.....	VII-23-45
Figure 23-33	IFF PROG EDIT Sublevel - POS Data.....	VII-23-46

CHAPTER 24 Navigation Equipment

Figure 24-1	Navigation Controls and Indicators.....	VII-24-3
Figure 24-2	TAMMAC Mode Selections	VII-24-5
Figure 24-3	GPS Page	VII-24-12
Figure 24-4	INS CV Align	VII-24-15
Figure 24-5	INS Ground Align.....	VII-24-16
Figure 24-6	INS In-Flight Align	VII-24-21
Figure 24-7	NAVCK Display.....	VII-24-24
Figure 24-8	GPS Waypoint Display.....	VII-24-27
Figure 24-9	INS Programming.....	VII-24-31
Figure 24-10	Position Keeping.....	VII-24-37
Figure 24-11	Position Updating Displays.....	VII-24-40
Figure 24-12	Waypoint/OAP Direct Great Circle Steering.....	VII-24-42
Figure 24-13	Waypoint/OAP Course Line Steering	VII-24-43
Figure 24-14	AUTO Sequential Steering	VII-24-46
Figure 24-15	Navigation Designation (WYPT DSG).....	VII-24-48
Figure 24-16	Overfly Designation	VII-24-49
Figure 24-17	TACAN Mode Selection.....	VII-24-53
Figure 24-18	TACAN Programming.....	VII-24-55
Figure 24-19	TACAN Direct Great Circle Steering	VII-24-56
Figure 24-20	TACAN Course Line Steering	VII-24-57
Figure 24-21	ICLS Initialization	VII-24-58
Figure 24-22	ICLS Steering.....	VII-24-60
Figure 24-23	DDI SA ACL Display.....	VII-24-62
Figure 24-24	HUD ACL Display	VII-24-65
Figure 24-25	Traffic Control Couple Display	VII-24-67
Figure 24-26	ACL Mode 1 Display	VII-24-68
Figure 24-27	ACL Mode 2 Steering Display	VII-24-70
Figure 24-28	T/C Guidance to Marshal	VII-24-71
Figure 24-29	ACL Control - Marshal to Touchdown.....	VII-24-74

CHAPTER 25 Backup/Degraded Operations

Figure 25-1	SDC Backup HUD Display (AMCD Aircraft).....	VII-25-2
Figure 25-2	Standby Attitude Reference Indicator	VII-25-4

CHAPTER 26 Visual Communications

Figure 26-1	Visual Communications.....	VII-26-1
-------------	----------------------------	----------

CHAPTER 27	Deck/Ground Handling Signals	
Figure 27-1	Deck Ground Handling Signals	VII-27-2
PART VIII	WEAPONS SYSTEMS	
PART IX	FLIGHT CREW COORDINATION	
CHAPTER 29	Crew Coordination Standards	
Figure 29-1	Approach Briefs	IX-29-6
Figure 29-2	Standard ICS Terms	IX-29-8
PART X	NATOPS EVALUATION	
PART XI	PERFORMANCE DATA	
Figure B2-41	CFIT Conditions, Voice Warning, and Repetition Rates	B-3
Figure B2-60	HMD Controls	B-4
Figure B15-37	FCS Failure Indications and Effects	B-7
Figure B15-38	FCS Failure Indications and Effects	B-7
Figure B15-39	FCS Failure Indications and Effects	B-8
Figure B15-40	FCS Failure Indications and Effects	B-8
Figure B15-43	FCS Failure Indications and Effects	B-9
Figure B15-44	FCS Failure Indications and Effects	B-9
Figure B-FO-1	Cockpit F/A-18E/F	B-10
Figure B-FO-2	Rear Cockpit F/A-18F	B-12
FOLDOUTS		
Figure FO-1	Cockpit F/A-18E/F (Lots 21 thru 25)	FO-3
Figure FO-2	Rear Cockpit F/A-18F (Lots 21 thru 25)	FO-7
Figure FO-3	Cockpit F/A-18E/F (Lot 26 AND UP)	FO-11
Figure FO-4	Rear Cockpit F/A-18F (Lot 26 AND UP)	FO-15
Figure FO-5	Electrical Bus Power	FO-19
Figure FO-6	Ejection Seat	FO-21
Figure FO-7	Fuel System	FO-25
Figure FO-8	Environmental Control System	FO-29

RECORD OF CHANGES

Change No. and Date of Change	Date of Entry	Page Count Verified by (Signature)

INTERIM CHANGE SUMMARY

The following Interim Changes have been canceled or previously incorporated in this manual:

INTERIM CHANGE NUMBER	REMARKS/PURPOSE
1 thru 27	Previously Incorporated or Canceled

The following Interim Changes have been incorporated in this Change/Revision:

INTERIM CHANGE NUMBER	REMARKS/PURPOSE
28	Cockpit Smoke and Fumes/Single GEN FAIL
29	AOA FCS Procedures, Cabin Smoke and Fumes Boldface
30	Aerobraking Technique
31	FCC S/W Update/CPWS FCF Fix
32	Multi-subject IC

Interim Changes Outstanding - To be maintained by the custodian of this manual:

INTERIM CHANGE NUMBER	ORIGINATOR/DATE (or DATE/TIME GROUP)	PAGES AFFECTED	REMARKS/PURPOSE
33	082001Z JUN 09	I-4-20, I-4-21, III-8-23, VI-19-2	AESA Radar Limitations and Considerations
34	262001Z AUG 09	I-2-83 I-4-10/11, III-7-39	FCC Memory Inspect Warning

P 262001Z AUG 09
 FM COMNAVAIRSYS COM PATUXENT RIVER MD//4.0P//
 TO ALL HORNET AIRCRAFT ACTIVITIES
 INFO COMNAVAIRSYS COM PATUXENT RIVER MD//5.0F/4.1//
 COMNAVAIRFOR SAN DIEGO CA//N455/N421B//
 COMNAVSAFECEN NORFOLK VA//11//
 PEOTACAIR PATUXENT RIVER MD//PMA265//
 FLTREADCEN SOUTHWEST SAN DIEGO CA//6.2//
 FLTREADCEN SOUTHEAST JACKSONVILLE FL//3.3.3//
 STRKFITRON ONE TWO TWO
 DCMA BOEING ST. LOUIS//RDOAA/RDDF/RDDP//
 SECINFO/U/-//
 MSGID/GENADMIN,USMTF,2008/COMNAVAIRSYS COM AIR-4.0P//
 SUBJ/FA-18EF AIRCRAFT NATOPS PUBLICATIONS INTERIM CHANGE//
 REF/A/DESC:EML/COMNAVAIRFOR/20AUG2009/-/NOTAL//
 REF/B/DESC:DOC/COMNAVAIRSYS COM/20AUG2009/-/NOTAL//
 REF/C/DESC:A1-F18EA-NFM-000/COMNAVAIRSYS COM/15SEP2008//
 REF/D/DESC:A1-F18EA-NFM-500/COMNAVAIRSYS COM/15SEP2008//
 NARR/REF A IS COG CONCURRENCE.
 REF B IS AIRS 2009-184.
 REF C IS NATOPS FLIGHT MANUAL NAVY MODEL F/A-18E/F 165533 AND UP
 AIRCRAFT, DTD 15 SEP 2008.
 REF D IS NATOPS POCKET CHECKLIST F/A-18E/F AIRCRAFT, DTD 15 SEP 2008.//
 POC/THOMAS ELLIS/FC FACILITATOR/UNIT:PMA-265/NAME:PATUXENT RIVER MD
 /TEL:301-342-3149/TEL:DSN 342-3149/EMAIL:THOMAS.ELLIS@NAVY.MIL//
 GENTEXT/REMARKS/1. THIS MESSAGE IS ISSUED IN RESPONSE TO REFS A AND
 B. THIS MESSAGE ISSUES INTERIM CHANGE (IC) NUMBER 34 TO REF C AND
 IC NUMBER 27 TO REF D.

2. SUMMARY.

A. THESE CHANGES TO REFS C AND D ADD WARNINGS FOR IN-FLIGHT
 MEMORY INSPECT (MI) OF FLIGHT CONTROL COMPUTER (FCC).

B. REPLACEMENT PAGES CONTAINING THESE CHANGES FOR DOWNLOADING
 AND INSERTION INTO REFS C AND D WILL BE ATTACHED TO THIS
 INTERIM CHANGE MESSAGE WHEN IT IS POSTED ON THE NATEC AND
 AIRWORTHINESS WEBSITES (SEE LAST PARA BELOW).

3. THE REPLACEMENT PAGES IMPACT THE FOLLOWING NATOPS FLIGHT
 MANUAL AND ASSOCIATED CHECKLIST. THE REPLACEMENT PAGE PACKAGE
 INCLUDES THE FOLLOWING PAGES:

A. REF C (F/A-18E/F NFM), PAGES: 37(REVERSE BLANK), I-2-83,
 I-2-84, I-4-9 THRU I-4-12, III-7-39 AND III-7-40.

B. REF D (F/A-18E/F PCL), PAGES: B/(C BLANK), 35 AND 36.

C. TO ENSURE THE PDF PAGES PRINT TO SCALE: SELECT PRINT
 AND VIEWING PRINT SETUP WINDOW, ENSURE 'NONE' IS
 SELECTED IN THE PAGE SCALING DROPDOWN.

4. POINTS OF CONTACT:

A. LT DAMON LOVELESS, VFA-122,NATOPS PROGRAM MANAGER,TEL DSN
 949-1960 OR COMM (559)998-1960,EMAIL:DAMON.LOVELESS@NAVY.MIL.

B. NAVAIR POCs:

(1) MARTY SCANLON, NATOPS IC COORDINATOR, TEL DSN 757-6045
 OR COMM (301) 757-6045, EMAIL: MARTIN.SCANLON@NAVY.MIL

(2) ED HOVANESIAN, F/A-18E/F CLASS DESK, TEL DSN 757-7573 OR
 COMM (301)757-7573, EMAIL:EDWIN.HOVANESIAN(AT)NAVY.MIL.

(3) KRISTIN SWIFT, AIR-4.0P NATOPS CHIEF ENGINEER,TEL DSN
 995-4193 OR (301)995-4193,EMAIL:KRISTIN.SWIFT(AT)NAVY.MIL.

(4) LCDR BEN KELSEY, 4.0P NATOPS OFFICER, TEL DSN 995-2502
 OR COMM (301) 995-2502, EMAIL:BEN.KELSEY@NAVY.MIL.

(5) AIRWORTHINESS GLOBAL CUSTOMER SUPPORT TEAM,
TEL: 301-757-0187, E-MAIL: AIRWORTHINESS(AT)NAVY.MIL.

5. THIS MESSAGE WILL BE POSTED ON THE NATEC WEBSITE,
WWW.MYNATEC.NAVY.MIL WITHIN 48 HOURS OF RELEASE. NEW NATOPS IC
MESSAGES MAY BE FOUND IN TWO PLACES ON THIS WEBSITE:

- A. IN THE NATOPS IC DATABASE FOUND UNDER THE TMAPS OPTION.
- B. IN THE AFFECTED PUBLICATIONS(S) JUST AFTER THE IC SUMMARY
PAGE. IF THE IC MESSAGE INCLUDES REPLACEMENT PAGES, THEY
WILL BE ADDITIONALLY PLACED WITHIN THE MANUAL AND REPLACED
PAGES DELETED. MESSAGES ARE NORMALLY POSTED IN THE DATABASE
BEFORE APPEARING IN THE PUBLICATION. THIS MESSAGE WILL ALSO
BE POSTED ON THE AIRWORTHINESS WEBSITE,
AIRWORTHINESS.NAVAIR.NAVY.MIL. IF UNABLE TO VIEW THIS MESSAGE ON
EITHER THE NATEC OR AIRWORTHINESS WEBSITES, INFORM THE NATOPS
GLOBAL CUSTOMER SUPPORT TEAM AT (301) 342-0870, DSN 342-0870, OR
BY EMAIL AT NATOPS(AT)NAVY.MIL.
- C. INFORMATION REGARDING THE AIRWORTHINESS PROCESS, INCLUDING
A LISTING OF ALL CURRENT INTERIM FLIGHT CLEARANCES, NATOPS
AND NATIP PRODUCTS ISSUED BY NAVAIR 4.0P, CAN BE FOUND AT
OUR WEBSITE: AIRWORTHINESS.NAVAIR.NAVY.MIL.
- D. E-POWER FOLDER NUMBER 874764. AIRWORTHINESS TRACKING NUMBER
35317.//

BT
#0001
NNNN

KRISTIN SWIFT, NATOPS CHIEF ENGINEER, 4.0P, 08/26/2009

P 082001Z JUN 09
 FROM COMNAVAIRSYS COM PATUXENT RIVER MD//4.0P//
 TO ALL HORNET AIRCRAFT ACTIVITIES
 INFO COMNAVAIRSYS COM PATUXENT RIVER MD//5.0F/4.1//
 COMNAVAIRFOR SAN DIEGO CA//N455/N421B//
 COMNAVSAFECEN NORFOLK VA//11//
 PEOTACAIR PATUXENT RIVER MD//PMA265//
 FLTREADCEN SOUTHWEST SAN DIEGO CA//6.2//
 FLTREADCENSOUTHEAST JACKSONVILLE FL//3.3.3//
 STRKFITRON ONE TWO TWO
 DCMA BOEING ST. LOUIS OPS//RDOAA/RDDF/RDDP//
 SECINFO/U/-//
 MSGID/GENADMIN,USMTF,2008/COMNAVAIRSYS COM AIR-4.0P//
 SUBJ/FA-18EF AIRCRAFT NATOPS PUBLICATIONS INTERIM CHANGE//
 REF/A/DESC:EML/COMNAVAIRFOR/01JUN2009//
 REF/B/DESC:DOC/COMNAVAIRSYS COM/25MAY2009//
 REF/C/DESC:A1-F18EA-NFM-000/COMNAVAIRSYS COM/15SEP2008//
 REF/D/DESC:A1-F18EA-NFM-500/COMNAVAIRSYS COM/15SEP2008//
 NARR/REF A IS COG CONCURRENCE.
 REF B IS AIRS 2009-113.
 REF C IS NATOPS FLIGHT MANUAL, A1-F18EA-NFM-000, DTD 15 SEP 2008.
 REF D IS NATOPS POCKET CHECKLIST (PCL), A1-F18EA-NFM-500, DTD
 15 SEP 2008.//
 POC/THOMAS ELLIS/FC FACILITATOR/UNIT:PMA-265/NAME:PATUXENT RIVER MD
 /TEL:301-342-3149/TEL:DSN 342-3149/EMAIL:THOMAS.ELLIS@NAVY.MIL//
 GENTEXT/REMARKS/1. THIS MESSAGE IS ISSUED IN RESPONSE TO REFS A AND
 B. THIS MESSAGE ISSUES INTERIM CHANGE (IC) NUMBER 33 TO REF C, AND
 IC NUMBER 26 TO REF D.
 2. SUMMARY.
 A. THESE CHANGES TO REFS C AND D INCORPORATE AESA RADAR
 LIMITATIONS.
 B. REPLACEMENT PAGES CONTAINING THESE CHANGES FOR DOWNLOADING
 AND INSERTION INTO REFS C AND D WILL BE ATTACHED TO THIS
 INTERIM CHANGE MESSAGE WHEN IT IS POSTED ON THE NATEC AND
 AIRWORTHINESS WEBSITES (SEE LAST PARA BELOW).
 3. THE REPLACEMENT PAGES IMPACT THE FOLLOWING NATOPS FLIGHT
 MANUAL AND ASSOCIATED CHECKLIST. THE REPLACEMENT PAGE PACKAGE
 INCLUDES THE FOLLOWING PAGES:
 A. REF C (F/A-18E/F NFM), PAGES: 37(REVERSE BLANK), I-4-19,
 I-4-20, I-4-21(REVERSE BLANK) III-8-23(REVERSE BLANK),
 VI-19-1 AND VI-19-2.
 B. REF D (F/A-18E/F PCL), PAGES: B/(C BLANK), 44A AND 44B.
 C. TO ENSURE THE PDF PAGES PRINT TO SCALE: SELECT PRINT
 AND VIEWING PRINT SETUP WINDOW, ENSURE "NONE" IS
 SELECTED IN THE PAGE SCALING DROPDOWN.
 4. POINTS OF CONTACT:
 A. LT DAMON LOVELESS, VFA-122, NATOPS PROGRAM MANAGER, TEL
 DSN 949-1960 OR COMM (559) 998-1960, EMAIL:
 DAMON.LOVELESS@NAVY.MIL.
 B. NAVAIR POCs:
 (1) MARTY SCANLON, NATOPS IC COORDINATOR, TEL DSN 757-6045
 OR COMM (301) 757-6045, EMAIL: MARTIN.SCANLON@NAVY.MIL
 (2) ED HOVANESIAN, F/A-18E/F CLASS DESK, TEL DSN
 757-7573 OR COMM (301) 757-7573, EMAIL:
 EDWIN.HOVANESIAN@NAVY.MIL.
 (3) KRISTIN SWIFT, AIR-4.0P NATOPS CHIEF ENGINEER, TEL
 DSN 995-4193 OR COMM (301) 995-4193,

EMAIL: KRISTIN.SWIFT@NAVY.MIL.

(5) LCDR BEN KELSEY, 4.0P NATOPS OFFICER,
DSN 995-2502, COM 301-995-2505, EMAIL:
BEN.KELSEY@NAVY.MIL.

(4) AIRWORTHINESS GLOBAL CUSTOMER SUPPORT TEAM,
COMM (301) 757-0187, E-MAIL: AIRWORTHINESS@NAVY.MIL.

5. THIS MESSAGE WILL BE POSTED ON THE NATEC WEBSITE,
WWW.MYNATEC.NAVY.MIL WITHIN 48 HOURS OF RELEASE. NEW NATOPS IC
MESSAGES MAY BE FOUND IN TWO PLACES ON THIS WEBSITE:

- A. IN THE NATOPS IC DATABASE FOUND UNDER THE TMAPS OPTION.
- B. IN THE AFFECTED PUBLICATION(S) JUST AFTER THE IC SUMMARY
PAGE. IF THE IC MESSAGE INCLUDES REPLACEMENT PAGES, THEY
WILL BE ADDITIONALLY PLACED WITHIN THE MANUAL AND REPLACED
PAGES DELETED. MESSAGES ARE NORMALLY POSTED IN THE DATABASE
BEFORE APPEARING IN THE PUBLICATION. THIS MESSAGE WILL ALSO
BE POSTED ON THE AIRWORTHINESS WEBSITE, AIRWORTHINESS.NAVAIR.
NAVY.MIL. IF UNABLE TO VIEW THIS MESSAGE ON EITHER THE NATEC
OR AIRWORTHINESS WEBSITES, INFORM THE NATOPS GLOBAL CUSTOMER
SUPPORT TEAM AT (301) 342-0870, DSN 342-0870, OR BY EMAIL AT
NATOPS@NAVY.MIL.
- C. INFORMATION REGARDING THE AIRWORTHINESS PROCESS, INCLUDING
A LISTING OF ALL CURRENT INTERIM FLIGHT CLEARANCES, NATOPS
AND NATIP PRODUCTS ISSUED BY NAVAIR 4.0P, CAN BE FOUND AT OUR
WEBSITE: AIRWORTHINESS.NAVAIR.NAVY.MIL.
- D. E-POWER FOLDER NUMBER 860893. AIRWORTHINESS TRACKING NUMBER
34551.//

KRISTIN SWIFT, NATOPS CHIEF ENGINEER, 4.0P 06/08/2009

SUMMARY OF APPLICABLE TECHNICAL DIRECTIVES

Information relating to the following technical directives has been incorporated in this manual

Change Number	ECP Number	Description	Visual Identification	Effectivity
	0577R3	Multifunctional Information Distribution System (MIDS) updates for F/A-18E/F aircraft	Comm switch change on throttle	(R) LOT 22 - LOT 23 (P) LOT 24 & UP
	6061	Automatic Direction Finder (ADF) replacement	None	(P) F/A-18E 165867 & UP (P) F/A-18F 165883 & UP
	6022	Incorporation of Advanced Mission Computers and Displays	DDIs with Contrast Rocker Switch.	(P) LOT 25 & UP
	6038R1	Lot 26 Structural and System Provisions for Block 2	Front cockpit Video Record Panel, Rear cockpit Hand Controllers.	(P) LOT 16 & UP
	6038R2	Lot 26 Avionics Installation Provisions for Block 2	TAMMAC Digital Video Map Computer (DVMC), Rear cockpit 8 x 10 Display.	(R) LOT 26 - LOT 27 (P) LOT 28 & UP
	6176R2	Omnibus Software Update	DDI Configuration Display: MC1/MC2 H2E+	(R) LOT 25 & UP
AFC 443	6212	Solid State Recorder	Secure Erase button on right hand forward vertical console.	(R) LOT 26 - LOT 28 (P) LOT 29 & UP
AFC 365 AFC 366	6165	Canopy Switch Guard, Boarding Ladder Switch	Switches inside Door 9	(R) LOT 21 - LOT 25
	6217	Cabin Pressurization Warning System	Caution Lights Panel	(P) F/A-18E 166784 & UP (P) F/A-18F 166804 & UP

(R) Retrofit (P) Production

Change Number	ECP Number	Description	Visual Identification	Effectivity
	6201	ANAV	None	(P) LOT 30 & UP
	6272	Omnibus Software Update	DDI Configuration Display: MC1/MC2 H4E	(P) LOT 30 & UP
	570R4	Aft Seat JHMCS	BRU mounted on aft UFCD	(P) LOT 30 & UP (R) LOT 23 - 29
AFC 395	960	AN/AVX-4 Fast Tactical Imaging Set	Digital Imaging Processor on RH console	(R) LOT 24

Information relating to the following recent technical directives will be incorporated in the future change.

Change Number	ECP Number	Description	Visual Identification	Effectivity

LIST OF ABBREVIATIONS/ACRONYMS

A

A/A	air-to-air
AACQ	automatic acquisition mode
AB	afterburner
AB LIM	afterburner limiting
A/C	aircraft
ac	alternating current
ACCUM	accumulator
ACI	amplifier control intercommunication
ACLS	automatic carrier landing system
ACM	air combat maneuvering
ACNTR	aft center (8 x 10) display
ADB	aircraft discrepancy book
ADF	automatic direction finding
ADV	advisory
AFCS	automatic flight control system
A/G	air-to-ground
AGI	armament gas ingestion
AGL	above ground level
AHRS	attitude heading reference set
AIL	aileron
AIM	air intercept missile
AINS	aided INS
ALDDI	aft left digital display indicator
ALR-67	radar warning receiver
ALT	altitude
AMAD	airframe mounted accessory drive
AMCD	advanced mission computers and displays
AMPCD	aft multipurpose color display
AMPD	advanced multipurpose display
AMU	advanced memory unit
AN/ALE-47	countermeasures dispensing set
AN/APN-194	radar altimeter set
AN/ASN-139	inertial navigation system
AOA	angle of attack
AOB	angle of bank
A/P	autopilot
APU	auxiliary power unit
AQ	align quality
ARDDI	aft right digital display indicator
ARI	attitude reference indicator
ARS	air refueling store
ASL	azimuth steering line
ASRM	automatic spin recovery mode

ATARS	advanced tactical air reconnaissance system
ATS	air turbine starter
ATSCV	air turbine starter control valve
ATTH	attitude hold
AUFCD	aft upfront control display
AUG	augment
AUR	aural
AUTO	automatic
AVMUX	avionics multiplex

B

BALT	barometric altimeter
BCN	beacon
BINGO	minimum fuel required to return to base
BIT	built in test
BLD	bleed
BLIM	bank limit
BLIN	BIT logic inspection
BNK	bank
BRG	bearing
BRK	brake
BRT	bright
BST	boresight acquisition mode

C

°C	degrees Celsius
CAS	control augmentation system
CAUT	caution
CB	circuit breaker
CCW	counterclockwise
CD	countdown
CDP	compressor discharge pressure
C/F	chaff/flare
CFIT	controlled flight into terrain
CG	center of gravity
CH or CHAN	channel
CHKLST	checklist
CIT	combined interrogator /transponder
CK	check
CKPT	cockpit
CLR	clear
CNI	communication, navigation, and identification
COMM	communication radio
CONT PVU	continuous precision velocity update
CPL	couple
CPLD	coupled
CPWS	cabin pressurization warning system
CRS	course
CSC	communication system control
CSEL	course select
CV	carrier

CVRS cockpit video recording system

D

DA density altitude
 DBS doppler beam sharpening
 DBFS dry bay fire suppression
 DC designator controller
 dc direct current
 DCS decompression sickness
 DDI digital display indicator
 DECD digital expandable color display
 DEGD degraded
 Δ P (Delta P) hydraulic filter indicator
 DF direction finding
 DISCH discharge
 D/L data link
 DME distance measuring equipment
 DMS digital map set
 DN down
 DSU data storage unit
 DTED digital terrain elevation data
 DT2 second designated target
 DVMC digital video map computer

E

EADI electronic attitude display indicator
 EBB essential bus backup
 ECS environmental control system
 EFD engine fuel display
 EFT external fuel tank
 EGT exhaust gas temperature
 EMCON emission control
 EMIS electro magnetic interference shield
 ENG engine
 ENT enter
 EPR engine pressure ratio
 ERF electronic fill remote
 EST estimated
 ET elapsed time
 EXT external
 EXTD extend

F

°F degrees Fahrenheit
 FADEC full authority digital engine control
 FCC flight control computer
 FCCA flight control computer A
 FCCB flight control computer B
 FCES flight control electronic system
 FCF functional checkflight
 FCCLP field carrier landing practice

FCNS	fiber channel network switch
FCS	flight control system
FE	fighter escort configuration
FF	fuel flow
FIP	form-in-place
FIRAMS	fight incident recording and monitoring system
FLBIT	fuel low BIT
FLIR	forward looking infrared
FO	foldout
FOD	foreign object damage
FOV	field of view
FPAH	flight path attitude hold
FPAS	flight performance advisory system
fpm	feet per minute
FPT	first pilot time
F-QTY	fuel quantity
FRS	fleet replacement squadron
ft	foot, feet
FUS	fuselage

G

G or g	gravity
GACQ	gun acquisition mode
GB	gyro bias
GCU	generator converter unit
GEN	generator
GEN TIE	generator tie
G-LIM	g-limiter
G-LOC	g-induced loss of consciousness
GND	ground
GPS	global positioning system
GPWS	ground proximity warning system
GRCV	guard receive
GW	gross weight
GXMT	guard transmit

H

HDG	heading
HDG/SLV	heading slaved
HI	high
HMD	helmet mounted display
HOBS	high off-boresight
HOTAS	hands on throttle and stick
HQ	have quick
HRC	helmet release connector
HSEL	heading select
HSI	horizontal situation indicator
HSIB	high speed interface bus
HSVN	high speed video network
HUD	head-up display

HYD	hydraulic, hydraulic system
HYD1	hydraulic system 1
HYD2	hydraulic system 2
I	
IAF	initial approach fix
IBIT	initiated built in test
ICLS	instrument carrier landing system
ICS	intercockpit communication system
ID	identification
IDECM	integrated defensive electronic countermeasures
IFA	inflight alignment
IFF	identification friend or foe
IFR	instrument flight rules
ILS	instrument landing system
IMC	instrument meteorological conditions
IMN	indicated mach number
IMU	inertial measurement unit
INOP	inoperative
INS	inertial navigation system
INST	instrument
INV	invalid
IP	instructor pilot
I/P (IDENT)	identification of position
IR	infrared
IRC	in-line release connector
ISOL	isolate
ITB	image transfer bus
IWSO	instructor WSO
J	
JETT	jettison
K	
KCAS	knots calibrated air speed
KGS	knots ground speed
KIAS	knots indicated air speed
kt	knots
KTAS	knots true airspeed
L	
L	left
lb(s)	pound(s)
L&S	launch & steering target
L ACC	lateral accelerometer
LAMPD	left advanced multipurpose display
LATLN	latitude longitude
LBA	limit basic aircraft
L BAR	launch bar
LCS	liquid cooling system
LDC	left designator controller

LDDI	left digital display indicator
LDG	landing
LED	leading edge down
LEF	leading edge flaps
LEU	leading edge up
LEX	leading edge extension
LG	landing gear
LI	left inboard
LM	left midboard
LO	left outboard
LO	low
LON	limit of NATOPS
LPU	life preserver unit
LSO	landing signal officer
LT	light
LTOD	local time of day
M	
MAC	mean aerodynamic chord
MAD	magnetic azimuth detector
MAX	maximum afterburner thrust
MC	mission computer
MC1	mission computer 1
MC2	mission computer 2
MER	multiple ejector rack
MFS	multifunction switch
MIDS	multifunctional information distribution system
MIL	military thrust
min	minimum, minutes
MMP	maintenance monitor panel
MNTCD	maintenance card
MPCD	multipurpose color display
MSL	mean sea level
MSNCD	mission card
MSRM	manual spin recovery mode
MTRS or m	meters
MU	memory unit
MUMI	memory unit mission initialization
MUX	multiplex bus
MVAR	magnetic variation
N	
N ₁	fan rpm
N ₂	compressor rpm
N ACC	normal accelerometer
NACES	navy aircrew common ejection seat
NATOPS	naval air training and operations procedures standardization
NAV	navigation
ND	nose down
nm	nautical miles

NORM	normal
NOTAMS	notice(s) to airmen
NOZ	nozzle
NU	nose up
NVD	night vision devices
NVIS	night vision imaging system
NWS	nosewheel steering
Nz REF	reference load factor
O	
OAP	offset aim point
OAT	outside air temperature
OBOGS	onboard oxygen generating system
OCF	out of control flight
OPF	operational flight program
ORIDE	override guide
OVFLY	overfly
OVRSPD	overspeed
OXY	oxygen
P	
PA	powered approach
PBIT	periodic BIT
PC	plane captain
P CAS	pitch control augmentation system
PCL	pocket checklist
PIO	pilot induced oscillation
PLF	parachute landing fall
PMG	permanent magnet generator
PNL	panel
POS	position
pph	pounds per hour
ppm	pounds per minute
PR	pressure
PROC	processor
psi	pounds per square inch
PTS	power transmission shaft
PTS	pressure transmitter set
Q	
QDC	quick disconnect connector
QTY	quantity
R	
R	right
RALT	radar altimeter
RAM	radar absorbing material
RAMPD	right advanced multipurpose display
RAT	ram air turbine
RATS	reduced authority thrust system
R CAS	roll control augmentation system
RCDR	recorder
RCS	radar cross section

RCVY	recovery
RDC	right designator controller
RDDI	right digital display indicator
RDR	radar
REC	radar elevation control
REC	record or receive
RECCE	reconnaissance
REJ	reject
RI	right inboard
RLG	ring laser gyro
RLS	reservoir level sensing
R-LIM	roll rate limiter
RM	right midboard
RMM	removable memory module
RNG	range
RO	right outboard
ROE	rules of engagement
ROMA	removable optics module assembly
RP	replacement pilot
rpm	revolutions per minute
RSET	reset
RSRI	rolling-surface-to- rudder interconnect
R/T	receive/transmit
RUD	rudder
RVSM	reduced vertical separation minimum
RWR	radar warning receiver
RWSO	replacement WSO

S

SCT	special crew time
SDC	signal data computer
SDCR	signal data computer replacement
SEAWARS	seawater parachute release mechanism
SEC	source error correction
SEQ	sequence
SMS	stores management set
SOP	standard operating procedures
SPD	speed
SPD BRK	speedbrake
SPN	spin
SRM	spin recovery mode
SSR	solid state recorder
STAB	stabilator
STBY	standby
STD HDG	stored heading
STT	single target track
SUPT	support
S/W	software
SW	switch

T

T ₁	engine inlet temperature
TAC	tactical
TAMMAC	tactical aircraft moving map capability
TAS	true air speed
TAWS	terrain awareness warning system
TCN or TACAN	tactical air navigation
TCV	thermal control valve
TDC	throttle designator controller
TDP	turbine discharge pressure
TED	trailing edge down
TEF	trailing edge flaps
TEU	trailing edge up
TEMP	temperature
T&G	touch and go
THA	throttle handle angle
TK PRESS	fuel tank pressure
T/O	takeoff
TOT	time on target
TR	transformer rectifier
TTG	time to go

U

UA	up-AUTO
UFCD	upfront control display
UHF	ultra high frequency
UNLK	unlock
UPDT	update
UTM	universal transverse mercator

V

vac	volts alternating current
VACQ	vertical acquisition mode
vdc	volts direct current
VEL	velocity
VER	vertical ejector rack
VFR	visual flight rules
VHF	very high frequency
VIB	vibration
VMC	visual meteorological conditions
VOL	volume
VTR	video tape recorder
VVSLV	velocity vector slave

W

W	waterline symbol
WACQ	wide acquisition mode
W DIR	wind direction
W SPD	wind speed
WARN	warning
WDSHLD	windshield

WonW	weight on wheels	
WoffW	weight off wheels	
WSO	Weapon Systems Officer	
WYPT	waypoint	
		X
XFER	transfer	
		Y
Y CAS	yaw control augmentation system	
yd	yards	
		Z
ZTOD	zulu time of day	

PREFACE

SCOPE

The NATOPS Flight Manual is issued by the authority of the Chief of Naval Operations and under the direction of Commander, Naval Air Systems Command in conjunction with the Naval Air Training and Operating Procedures Standardization (NATOPS) Program. This manual contains information on all aircraft systems, performance data, and operating procedures required for safe and effective operations, however, it is not a substitute for sound judgement. Compound emergencies, available facilities, adverse weather or terrain, or considerations affecting the lives and property of others may require modification of the procedures contained herein. Read this manual from cover to cover as it is each aircrew's responsibility to have a complete knowledge of its contents.

APPLICABLE PUBLICATIONS

The following applicable publications complement this manual:

- A1-F18EA-NFM-200 (Performance Data)
- A1-F18EA-NFM-500 (Pocket Checklist)
- A1-F18EA-NFM-600 (Servicing Checklist)
- A1-F18EA-NFM-700 (Functional Checkflight Checklist)
- A1-F18EA-TAC-000 (Volume I Tactical Manual)
- A1-F18EA-TAC-010 (Volume II Tactical Manual)
- A1-F18EA-TAC-100 (Volume III Tactical Manual)
- A1-F18EA-TAC-020 (Volume IV Tactical Manual)
- A1-F18EA-TAC-300 (Tactical Manual Pocket Guide)

HOW TO GET COPIES

Additional copies of this manual and changes thereto may be procured through the local supply system from NAVICP Philadelphia via DAAS in accordance with NAVSUP P-409 (MILSTRIP/MILSTRAP), or a requisition can be submitted to Naval Supply Systems Command via the Naval Logistics Library (NLL) website, <https://nll.ahf.nmci.navy.mil>. This publication is also available to view and download from the Naval Air Technical Data and Engineering Service Command (NATEC) website, <https://www.natec.navy.mil> or at the NAVAIR Airworthiness website <https://airworthiness.navair.navy.mil>.

AUTOMATIC DISTRIBUTION (WITH UPDATES).

This publication and changes to it are automatically sent to activities that are established on the Automatic Distribution Requirements List (ADRL) maintained by Naval Air Technical Data and Engineering Service Command (NATEC), in San Diego, CA. If there is continuing need for this publication, each activity's Central Technical Publication Librarian must coordinate with the NATOPS Model Manager of this publication to ensure appropriate numbers of this and associated derivative manuals are included in the automatic mailing of updates to this publication.

NOTE

Activities not coordinating with the NATOPS Model Manager unit for more than 12 months may be dropped from distribution.

UPDATING THE MANUAL

To ensure that the manual contains the latest procedures and information, NATOPS review conferences are held in accordance with OPNAVINST 3710.7 series.

CHANGE RECOMMENDATIONS

Recommended changes to this manual or other NATOPS publications may be submitted by anyone in accordance with OPNAVINST 3710.7 series. Change recommendations of any nature, (URGENT/PRIORITY/ROUTINE) should be submitted directly to the Model Manager via the Airworthiness website (<https://airworthiness.navair.navy.mil>) into the AIRS (Airworthiness Issue Resolution System) database. The AIRS is an application that allows the Model Manager and the NATOPS Office, Naval Air Systems Command (NAVAIR) AIR-4.0P to track all change recommendations with regards to NATOPS products. The Model Manager will be automatically notified via email when a new recommendation is submitted. A classified side of the website is available to submit classified information via the SIPRNET. Routine change recommendations can also be submitted directly to the Model Manager (via your unit NATOPS Officer if applicable) on OPNAV Form 3710/6 shown on the next page.

The address of the Model Manager of this aircraft/publication is:

Commanding Officer
VFA-122
U. S. Naval Air Station
Lemoore, CA 93245-5122
Attn: F/A-18E/F Model Manager
DSN: 949-2341
Commercial: (559) 998-2341
Email: NATOPS_PM_F18EF@navy.mil

NATOPS CHANGE RECOMMENDATION
 OPNAV/FORM 3710/6(4-90) S/N 0107-LF-009-7900

DATE _____

TO BE FILLED IN BY ORIGINATOR AND FORWARDED TO MODEL MANAGER

FROM (originator)		Unit			
TO (Model Manager)		Unit			
Complete Name of Manual/Checklist	Revision Date	Change Date	Section/Chapter	Page	Paragraph

Recommendation (be specific)

CHECK IF CONTINUED ON BACK

Justification

Signature	Rank	Title
-----------	------	-------

Address of Unit of Command

TO BE FILLED IN BY MODEL MANAGER (Return to Originator)

FROM	Date
------	------

TO

Reference

(a) Your change Recommendation Dated _____

Your change recommendation dated _____ is acknowledged. It will be held for action of the review conference planned for _____ to be held at _____

Your change recommendation is reclassified URGENT and forwarded for approval to _____ by my DTG _____

/S/ _____
 MODEL MANAGER

_____ AIRCRAFT

YOUR RESPONSIBILITY

NATOPS Flight Manuals are kept current through an active manual change program. Any corrections, additions, or constructive suggestions for improvement of content of the manual should be submitted by routine or urgent change recommendation, as appropriate, at once.

NATOPS FLIGHT MANUAL INTERIM CHANGES

Interim changes are changes or corrections to NATOPS manuals promulgated by CNO or COMNAVAIRSYSCOM. Interim changes are issued either as printed pages, or as a Naval message. The Interim Change Summary page is provided as a record of all interim changes. Upon receipt of a change or revision, the custodian of the manual should check the updated Interim Change Summary to ascertain that all outstanding interim changes have been either incorporated or canceled; those not incorporated shall be recorded as outstanding in the section provided.

CHANGE SYMBOLS

Revised text is indicated by a black vertical line in either margin of the page, adjacent to the affected text, like the one printed next to this paragraph. The change symbol identifies the addition of either new information, a changed procedure, the correction of an error, or a rephrasing of the previous material.

WARNING, CAUTIONS, AND NOTES

The following definitions apply to “WARNINGS”, “CAUTIONS”, and “NOTES” found throughout the manual.

WARNING

An operating procedure, practice, or condition, etc., which may result in injury or death if not carefully observed or followed.

CAUTION

An operating procedure, practice, or condition, etc., which may result in damage to equipment if not carefully observed or followed.

NOTE

An operating procedure, practice, or condition, etc., which is essential to emphasize.

WORDING

The concept of word usage and intended meaning which has been adhered to in preparing this

manual is as follows:

“Land as soon as possible” means to land at the first site which a safe landing can be made.

“Land as soon as practical” means extended flight is not recommended. The landing site and duration of flight is at the discretion of the pilot in command.

“Shall” has been used only when application of a procedure is mandatory.

“Should” has been used only when application of a procedure is recommended.

“May” and “need not” have been used only when application of a procedure is optional.

“Will” has been used only to indicate futurity, never to indicate any degree of requirement for application of a procedure.

AIRSPPEED

All airspeeds in this manual are in knots calibrated airspeed (KCAS) unless stated in other terms.

TERMINOLOGY

To standardize terminology throughout this publication, the following guidelines should be followed:

- a. When specifying a switch, handle, or knob to be actuated in an emergency procedure, the name of the switch, handle or knob should be written as it is labeled in the cockpit (i.e. LDG GEAR handle).
- b. When referencing a position of a switch, handle, or knob, the label as shown in the cockpit should be used (i.e. ECS MODE switch – OFF/RAM).
- c. LOT numbers should be used vice BUNO numbers when the entire LOT is affected. For multiple LOTs use LOTs XX–XX or LOT XX and up as appropriate.
- d. For MC OFP’s use terminology such as “Prior to MC OFP 18E” or “MC OFP 18E and up” to avoid requiring a NATOPS change with each subsequent OFP release.
- e. Procedures which are nested in other procedures such as the Emergency Oxygen Procedure should contain only immediate action items.
- f. When emergency procedures are referenced in the PCL, page numbers should be included to facilitate quick location of the referenced procedure.

MANUAL DEVELOPMENT

This NATOPS Flight Manual was prepared using a concept that provides the aircrew with information for operation of the aircraft, but detailed operation and interaction is not provided. This concept was selected for a number of reasons: reader interest increases as the size of a technical publication decreases, comprehension increases as the technical complexity decreases, and accidents decrease as reader interest and comprehension increase. To implement this streamlined concept, observance of the following rules was attempted:

- a. Aircrew shall be considered to have above-average intelligence and normal (average) common sense.

- b. No values (pressure, temperature, quantity, etc.) which cannot be read in the cockpit are stated, except where such use provides the pilot with a value judgement. Only the information required to fly the airplane is provided.
- c. Notes, Cautions, and Warnings are held to an absolute minimum, since almost everything in the manual could be considered a subject for a Note, Caution, or Warning.
- d. No procedural data are contained in the Descriptive Section, and no abnormal procedures (Hot Starts, etc.) are contained in the Normal Procedures Section.
- e. Notes, Cautions and Warnings are not used to emphasize new data.
- f. Multiple failures (emergencies) are not covered.
- g. Simple words in preference to more complex or quasi-technical words are used and unnecessary and/or confusing word modifiers are avoided.

A careful study of the NATOPS Flight Manual will probably disclose a violation of each rule stated. In some cases this is the result of a conscious decision to make an exception to the rule. In many cases, it only demonstrates the constant attention and skill level that must be maintained to prevent slipping back into the old way of doing things.

In other words, the “Streamlined” look is not an accident, it takes constant attention for the NATOPS Flight Manual to keep the lean and simple concept and to provide the aircrew with the information required.

F/A-18E/F



Super Hornet

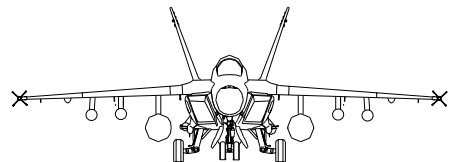
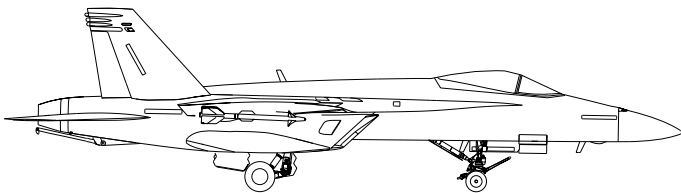
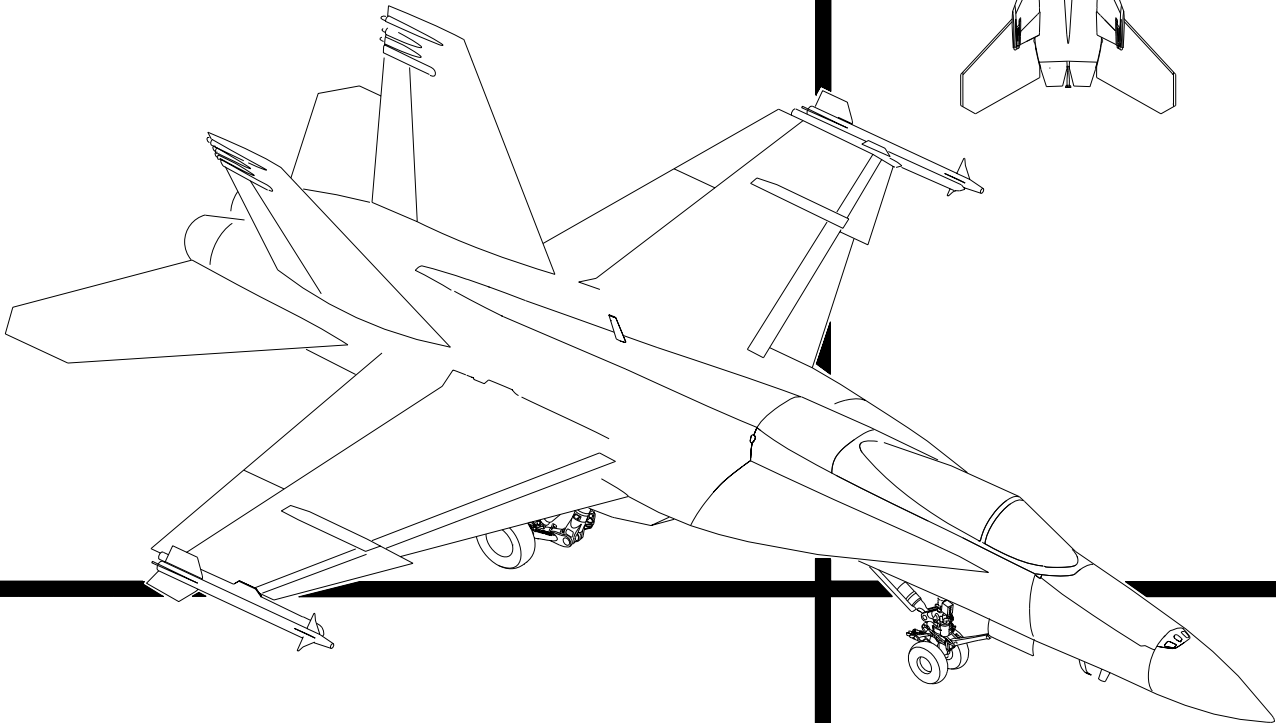
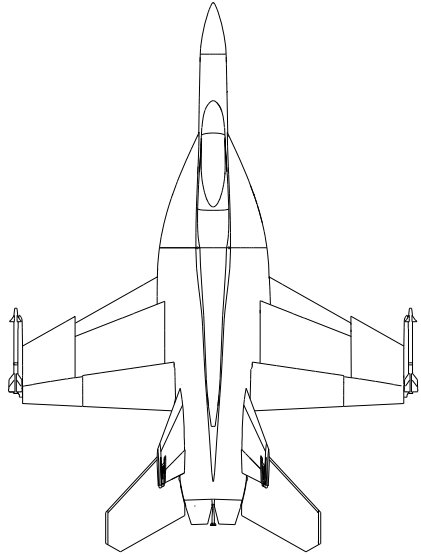

EFN520-217-1-001

PART I

THE AIRCRAFT

Chapter 1 - Aircraft

Chapter 2 - Systems

Chapter 3 - Servicing and Handling

Chapter 4 - Operating Limitations

CHAPTER 1

The Aircraft

1.1 AIRCRAFT DESCRIPTION

1.1.1 Meet The Super Hornet. The F/A-18E/F Super Hornet is a carrier based strike fighter aircraft built by McDonnell Douglas Corporation. The general arrangement, approximate dimensions, and cockpit layout are shown in Figure 1-1, Figure 1-2, and the Cockpit Foldout section, respectively. The multi-mission aircraft has an internal 20 mm gun and can carry AIM-7, AIM-9, and AIM-120 air-to-air missiles; and numerous air-to-ground weapons. The aircraft fuel load may be increased with the addition of up to five external fuel tanks. The aircraft can be configured as an airborne tanker by carrying a centerline mounted air refueling store.

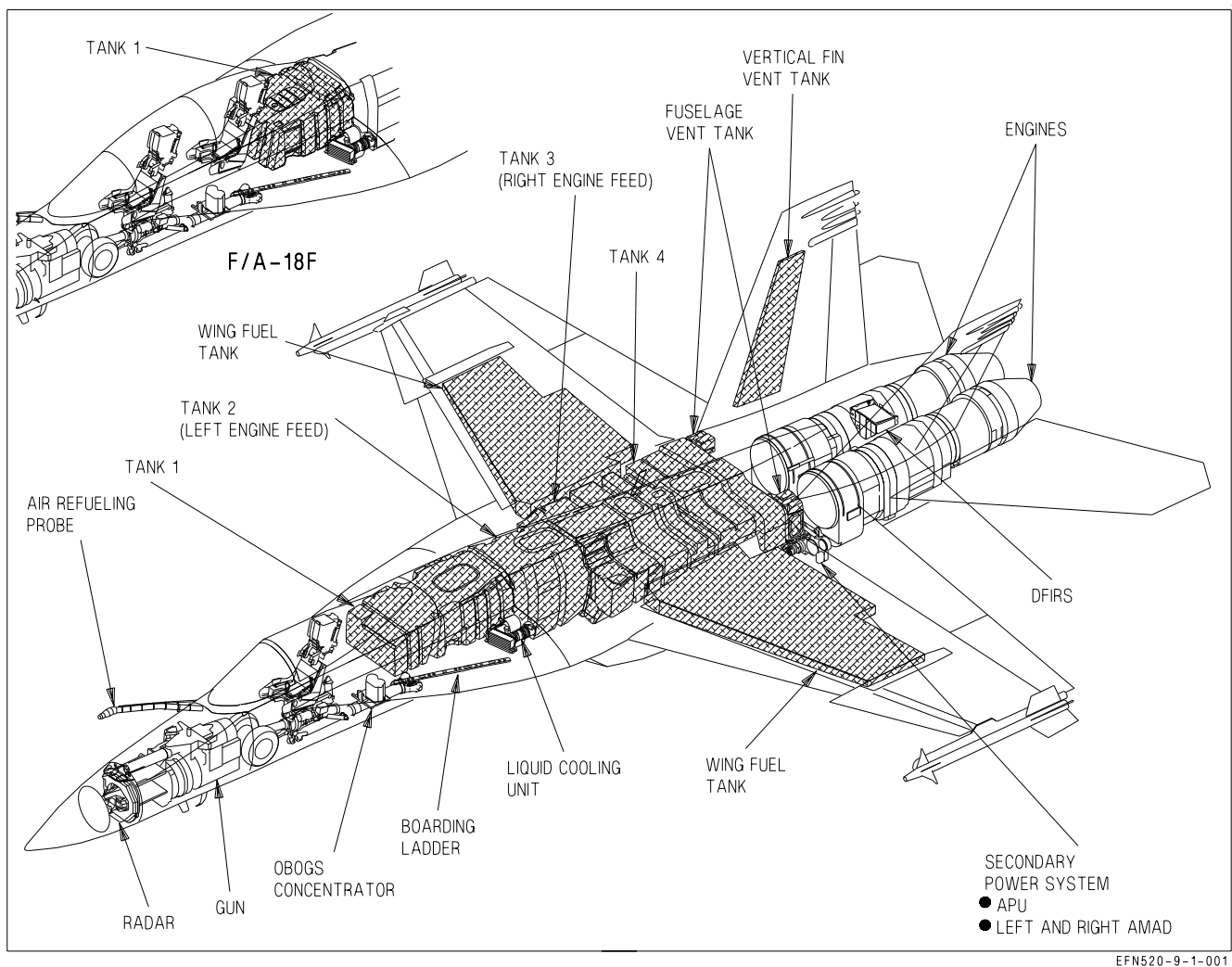
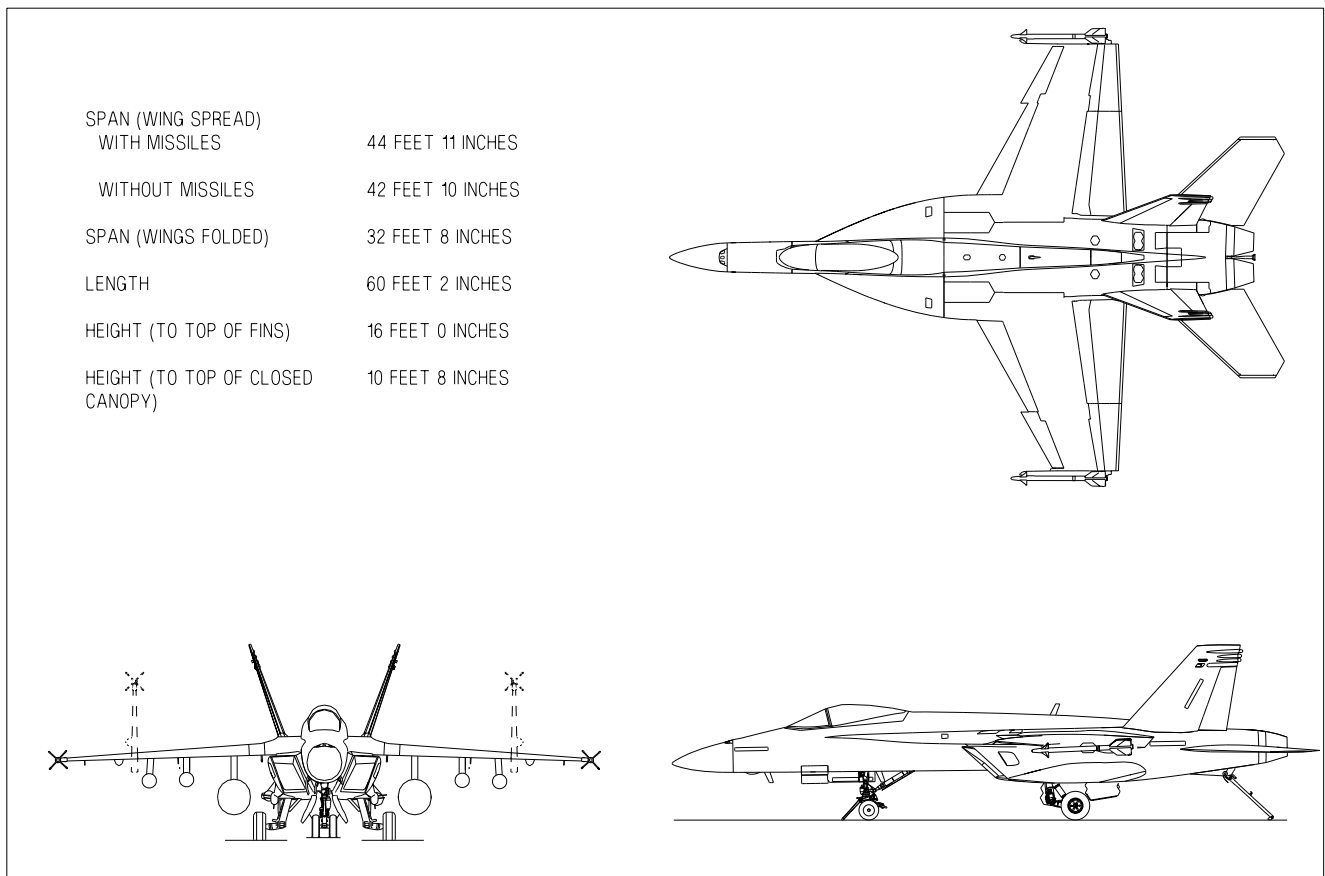

Figure 1-1. General Arrangement

The aircraft is powered by two General Electric F414-GE-400 turbofan engines utilizing Full Authority Digital Engine Control (FADEC). The aircraft features a variable camber mid-wing with



EFN520-331-1-004

Figure 1-2. Approximate Dimensions

leading edge extensions (LEX) mounted on each side of the fuselage. Twin vertical tails are angled outboard 20 degrees from the vertical.

The aircraft is designed with relaxed static stability to increase maneuverability and to reduce approach and landing speed. The aircraft is controlled by a digital fly-by-wire Flight Control System through hydraulically actuated flight control surfaces: ailerons, twin rudders, leading edge flaps, trailing edge flaps, LEX spoilers, and differential stabilators. The leading edge of the wing incorporates a “snag,” which increases outboard wing area and increases roll authority in the approach and landing configuration. A speed brake function is provided by differential deflection of the primary flight control surfaces.

The pressurized cockpit is enclosed by an electrically operated clamshell canopy. An aircraft mounted auxiliary power unit (APU) provides self-contained start capability for the engines.

1.1.2 Aircraft Gross Weight. Basic weight is approximately 31,500 pounds for the F/A-18E and 32,000 pounds for the F/A-18F. Refer to applicable DD 365-3 for accurate aircraft weight.

1.1.3 F/A-18F. The F/A-18F is the two seat model of the Super Hornet and is configured with tandem cockpits. The rear cockpit can be configured with a stick, throttles, and rudder pedals (trainer configuration); or with two hand controllers, a UFCF adapter, and foot-operated communication switches (missionized configuration). The rear cockpit controls and displays operate independently of those in the front cockpit.

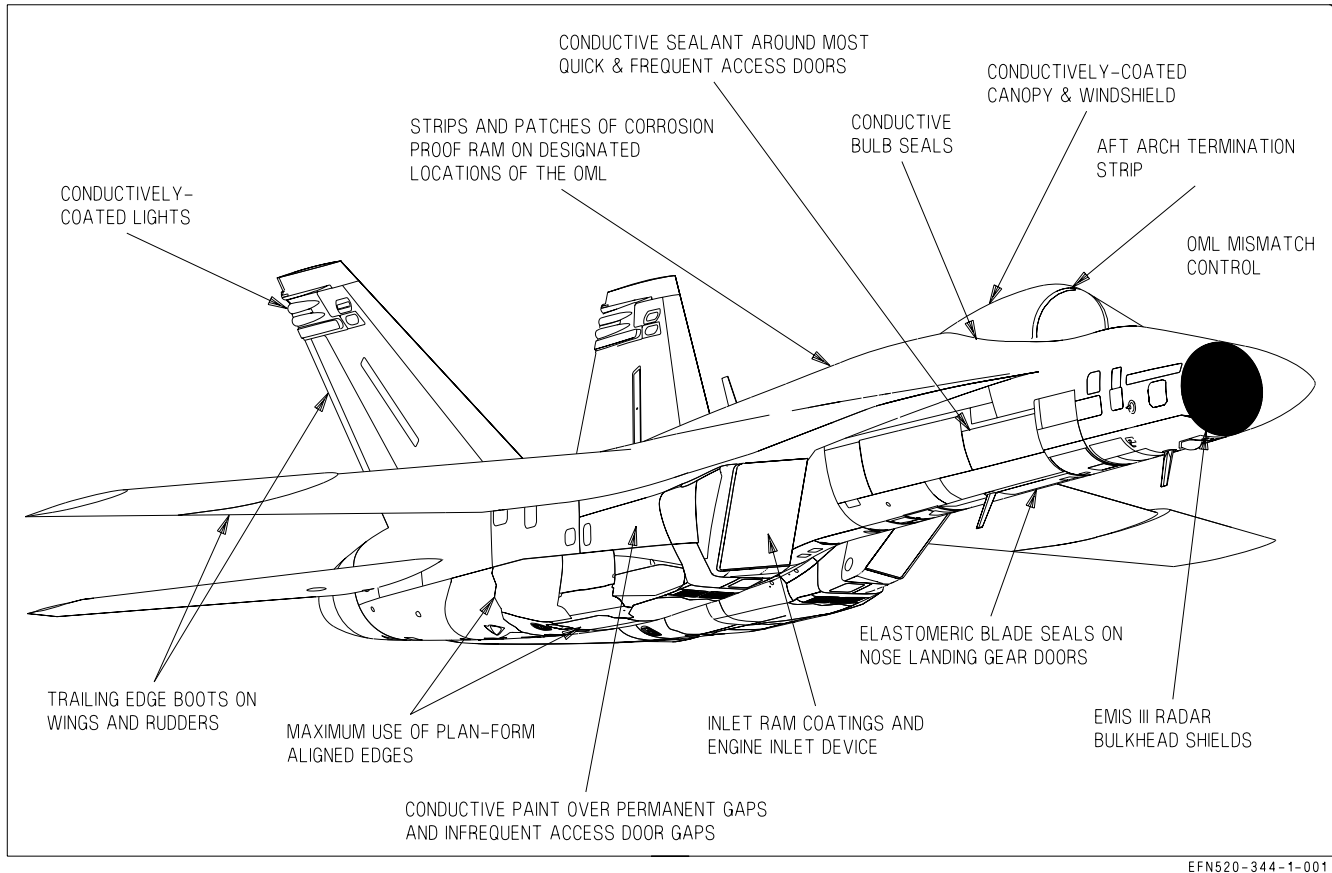

Figure 1-3. Radar Cross Section (RCS) Reduction

1.1.4 Radar Cross Section (RCS) Reduction. RCS reduction is a significant feature of the F/A-18E/F. While the maintenance community is tasked with maintaining the RCS features of the aircraft, it is in the best interests of the aircrew community to take an active role to ensure the survivability characteristics of the aircraft are retained.

RCS reduction is accomplished through numerous airframe design features. See figure 1-3. The baseline feature is planform alignment of as many surface edges as feasible. The outer moldline of the aircraft is treated to make it a smooth, conductive surface in order to reduce radar scattering.

Treatment entails metalizing the navigation lights, canopy, and windshield. Permanent joints and gaps around infrequently opened panels are filled with a form-in-place (FIP) sealant, which is blended flush and conductively painted. Gaps around frequently opened panels are filled with a conductive FIP (CFIP) sealant, which allows for easier repair. Conductive tape is applied to a few gaps where there is no substructure to support FIP material, such as along LEX edges. Conductive tape can also be used to quickly repair damaged FIP joints.

Since CFIP in the gaps around frequently opened panels will experience the most wear and tear, a corrosion-proof radar absorbing material (RAM) is applied in front of many of these gaps. RAM is also applied (1) on the inlet lip and duct, (2) as diamond-shaped patches around drain holes, and (3) in various locations that tend to highly scatter radar energy such as around pitot tubes, vertical tail openings, vents and screens, flap hinges and fairings, and portions of the pylons and external tanks. A multi-layer RAM is used in a few locations, such as around AOA probes and on the top, front surface of the pylons.

Gaps around landing gear doors are treated in two ways. Nose landing gear doors use flexible conductive blade seals on leading and trailing edges; main landing gear door edges are wrapped with RAM. Scattering from trailing edges (i.e., trailing edge flaps and rudders) is controlled by a radar absorbing boot which is bonded to the surface. Scattering from the back edge of the windshield is controlled by a gray, laminated material called the aft arch termination strip.

The engine inlet ducts incorporate a device to minimize engine front face scattering. The edge of the canopy incorporates a conductive bulb seal to block radar reflections from that joint. Conductive bulb seals are also used where there is significant structural flexure, such as at the wing-to-LEX interface.

Eleven electro magnetic interference shields (EMIS) III radar shields are permanently installed on the radar antenna hardware. To allow the aircraft to achieve its full RCS reduction potential, a missionized kit consisting of twelve more EMIS III radar bulkhead shields, are installed for combat missions only. Additionally, SUU-79 pylons can be fitted with a set of low observable (LO) hardware.

1.2 BLOCK NUMBERS

See figure 1-4 for block numbers and bureau numbers for each lot of aircraft. The baseline for this NATOPS manual is aircraft 165779 (Lot 23) and up. Differences from the baseline aircraft for aircraft 165533 thru 165679 (Lot 21 and Lot 22) are presented in Appendix B of this manual.

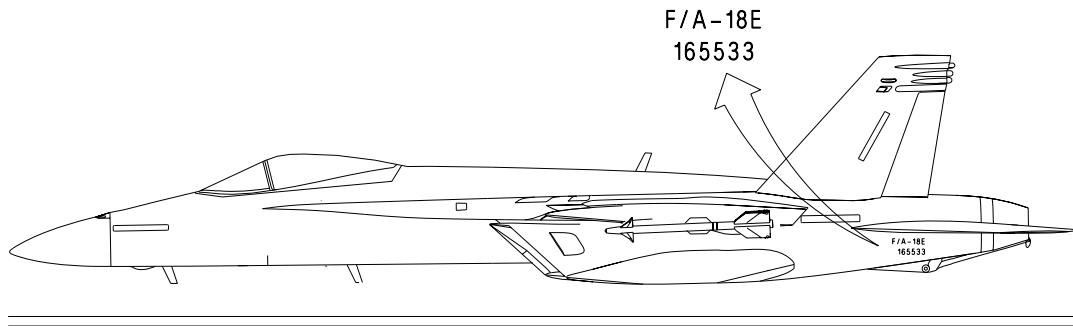

EFN520-210-1-001

LOT	F/A-18E	F/A-18F
LOT 21	165533 - 165540	165541 - 165544
LOT 22	165660 - 165667	165668 - 165679
LOT 23	165779 - 165792	165793 - 165808
LOT 24	165860 - 165874	165875 - 165895
LOT 25	165896 - 165909	165910 - 165934
LOT 26	166420 - 166448	166449 - 166467
LOT 27	166598 - 166609	166610 - 166642
LOT 28	166643 - 166657	166658 - 166684
LOT 29	166775 - 166789	166790 - 166816
LOT 30	166817 - 166841	166842 - 166854

Figure 1-4. LOT NUMBER/BUNO

CHAPTER 2

Systems

2.1 POWER PLANT SYSTEMS

2.1.1 Engines. The aircraft is powered by two General Electric F414-GE-400 engines. The engines are low bypass, axial-flow, twin-spool turboprops with afterburner. The three stage fan (low pressure compressor) and the seven stage high pressure compressor are each driven by a single stage turbine. The basic functions are supported by the engine driven accessory gearbox which drives the engine fuel pump, variable exhaust nozzle (VEN/start) fuel pump, lubrication and oil scavenge pump, engine fuel control, and alternator. Fuel flow from the VEN/start pump is used to drive the VEN actuator and to provide initial fuel pressure for main engine start.

The uninstalled military thrust (MIL) of each F414-GE-400 engine is approximately 13,900 pounds with maximum afterburner thrust (MAX) in the 20,700 pound class.

An inlet device is installed in each engine intake to reduce the aircraft radar signature and to improve survivability.

2.1.1.1 FADEC - Full Authority Digital Engine Control. Engine operation is controlled by a full authority digital engine control (FADEC), mounted on the engine casing. Each FADEC computer has two central processor units, channel A (CH A) and channel B (CH B), and is integrated with the Mission Computers (MCs), flight control computers (FCCs), and throttles. Normally, both FADEC channels monitor engine and control system operation with one channel in control and the other in standby. The channel currently in control is boxed on the SUPT MENU/ENG display.

In the event of a control system failure, the FADEC automatically selects the channel with better capability. Manual FADEC channel transfer can be commanded by selecting the CH A or CH B pushbutton on the ENG display. When the throttle is at or above IDLE, the FADEC transfers control to the other channel only if the requested channel's health is no worse than the channel in control.

FADEC software implements the engine control schedules by modulating fuel flow and engine geometry for the current flight conditions and the "requested" throttle setting. With the throttles matched, engine parameters may vary significantly between the engines as control schedules are adjusted for optimum performance. Therefore, a mismatch between engine parameters is not a sign of degraded performance as long as ENG STATUS is NORM. FADEC cooling is provided by the fuel system.

2.1.1.1.1 FADEC Power Sources. Prior to first engine start, the battery is used to power CH A of both FADECs. When N_2 reaches 10 % rpm during start, the engine driven alternator comes online and powers both channels of its corresponding FADEC. When an aircraft generator comes online (N_2 greater than 60 %), the aircraft's electrical system provides power to both channels of the other FADEC as well. With both engines operating, each engine driven alternator is the primary source of FADEC power with the aircraft's 28 vdc essential bus as backup. When both channels of a FADEC are powered after initial start, the FADEC automatically switches operation to the channel which was not in control during the last flight/engine run.

Ten seconds after reaching idle power, the FADEC attempts to switch to the 28 vdc essential bus to verify that backup power is available. If backup power is inadequate/inoperative, the FADEC declares a channel degrade (dual channel lineout) and sets a 6A8 or 6C8 MSP code (L or R FADEC/aircraft 28V fail). These degrade indications appear if the first engine is started with the corresponding GEN switch OFF, and requires a FADEC reset to restore normal engine indications.

2.1.1.1.2 Engine Status. Engine status is reported by the FADEC and appears on the ENG STATUS line of the ENG display. The levels of engine performance capability, listed in descending order, are:

NORM	Engine performance is normal
PERF90	10 % or less thrust loss and/or slower engine transients. Afterburner is not inhibited
AB FAIL	No afterburner capability
THRUST	Engine thrust is limited to between 40 % and 90 % and significantly slower transients
IDLE	Engine is limited to idle power only
SHUTDOWN	Engine automatically shut down

2.1.1.1.3 FADEC/Engine Degrades. FADEC/engine degrades fall into two categories: minor failures which do not affect engine operability and significant failures that do affect engine operability.

Due to a high level of FADEC redundancy, most minor control system failures do not cause any degradation in engine performance (ENG STATUS remains NORM). Cockpit indications for these types of failures are slightly different depending on whether the aircraft is inflight or on the ground.

Inflight -

- a. FADEC and BIT advisories.
- b. ENG STATUS - NORM.
- c. OP GO indication for the affected engine channel on the BIT/HYDRO MECH display.

On the ground or below 80 KCAS after landing -

- a. FADEC and BIT advisories.
- b. ENG STATUS - NORM.
- c. DEGD replaces OP GO for the affected engine channel on the BIT/HYDRO MECH display.
- d. Both CH A and CH B lined out on the ENG display.

A FADEC OP GO or DEGD with an ENG STATUS of NORM is an indication of a loss of control system redundancy and not of a loss of engine operability. Therefore, a FADEC OP GO inflight should be considered informative and should not mandate a mission abort. However, on the ground, the

FADEC DEGD and dual channel lineout indications are intended to prevent takeoff with a known loss of redundancy and maintenance action is required. Therefore, takeoff with a FADEC DEGD indication (dual channel line out) is prohibited.

Significant failures which do cause degradation in engine performance have the following indications both inflight and on the ground:

- a. L or R ENG caution and voice alert.
- b. FADEC and BIT advisories.
- c. ENG STATUS change on the ENG display.
- d. DEGD indication for the affected engine channel on the BIT/HYDRO MECH display.
- e. Both CH A and CH B lined out on the ENG display.

2.1.1.1.4 FADEC Reset. When a throttle is OFF, the corresponding FADEC uses a channel change request as a FADEC software reset. FADEC reset capability is provided to clear a DEGD indication which was caused by a momentary FADEC fault (e.g., startup power transient). A FADEC reset should only be performed for DEGD indications which occur on the ground and which do not result in a change of ENG STATUS. For a FADEC OP GO inflight, engine shutdown and FADEC reset is not recommended as the engine is functioning normally. In all other circumstances, a FADEC reset should not be attempted, particularly airborne, as any degrade in ENG STATUS is most likely indicative of the failure of a mechanical component. Under these conditions, the engine may fail to restart following a shutdown and FADEC reset attempt.

2.1.1.1.5 Ignition System. The FADEC provides simultaneous control of the main and afterburner igniters via the engine driven alternator and ignition exciter. Ignition (both main engine and afterburner) is commanded whenever:

- a. N_2 rpm is between 10 % and 45 % during engine start.
- b. Flameout occurs.
- c. Throttle is advanced into afterburner, remaining on until afterburner light off is sensed.
- d. The gun is fired, or any wing pylon mounted A/A or forward firing A/G weapon is launched. Ignition remains on for 5 seconds.

2.1.1.1.6 Oil Pressure Sensing System. The oil pressure sensing system utilizes an oil pressure transducer and a separate oil pressure switch. The transducer provides an oil pressure value for display in the cockpit. The oil pressure switch provides an additional source to confirm the presence of oil pressure if the oil pressure transducer fails.

If a L or R OIL PR caution is set with a valid cockpit readout, actual engine oil pressure is below scheduled limits. If the cockpit readout is zero with no caution set, the oil pressure transducer has failed and the pressure switch is inhibiting the caution.

2.1.1.1.7 Engine Idle Schedules. Each FADEC modifies engine idle schedules based on weight on wheels (WonW) status, aircraft flight condition, engine bleed demand, and environmental control system (ECS) mode of operation. The purpose of idle scheduling is to ensure that engine bleed output

is always sufficient to run the ECS, particularly the aircrew onboard oxygen generating system (OBOGS).

Baseline idle schedules are used during normal engine operation and moderate environmental conditions, and are set as a function of pressure altitude and WonW status. With WonW and airspeed below 80 knots, the FADEC commands ground idle by reducing the engine compressor discharge pressure (CDP) (typically a slight decrease in N_2 rpm) from the inflight idle setting. The throttle handle angle (THA) for ground and inflight idle are identical.

In LOT 26 and up, with WoffW, spin recovery mode not engaged, and inflight refueling probe and landing gear (and hook in LOT 24 and below) retracted, baseline flight idle thrust LOT 26 and up is higher than in LOT 25 and below. Ground idle thrust is not affected.

Alternate idle schedules are used when engine bleed demands are high (e.g., hot ambient temperatures, high ECS output, RECCE configuration, engine or windshield anti-ice operation, or ECS OFF/RAM mode). When an alternate idle schedule is requested, the FADEC increases the minimum CDP that is commanded at idle power (typically a slight increase in N_2 rpm), which may also result in a noticeable decrease in throttle response at the lower end of the throttle range. With the throttles near flight idle, a small engine transient may be noticed when an alternate idle schedule is activated or when a transition between alternate idle schedules occurs.

In LOT 26 and up, when an alternate idle schedule is activated flight idle thrust can be double that for LOT 25 and below aircraft.

Alternate idle schedules are deactivated with WonW, when spin recovery mode is engaged, or when the inflight refueling probe or landing gear (or hook in LOT 24 and below) are extended. When alternate idle schedules are deactivated in LOT 26 and up, a small noticeable engine transient may occur with the throttle near flight idle, and the resulting flight idle thrust is identical to LOT 25 and below baseline flight idle thrust.

2.1.1.1.8 Fan Speed Lockup. The fan speed lockup system prevents inlet instability (buzz) at high Mach by holding engine speed and airflow at military power levels when the throttle(s) are retarded below MIL. Speed lockup is activated when the aircraft accelerates above Mach 1.23 and deactivated when the aircraft decelerates below Mach 1.18.

2.1.1.1.9 SETLIM - Supersonic Engine Thrust Limiting. SETLIM minimizes the potential for an aircraft departure due to asymmetric thrust following an engine stall or flameout at certain supersonic (Mach greater than 1.8) or high-q conditions equivalent to approximately 700 KCAS at sea level or 750 KCAS at 25,000 feet. If the FADEC detects a stall or flameout condition, this function terminates afterburner operation in both engines. Normal afterburner operation is restored 12 seconds after engine recovery or immediately when airspeed drops below Mach 1.7 and q-conditions are equivalent to approximately 650 KCAS at sea level or 710 KCAS at 25,000 feet.

2.1.1.1.10 RATS - Reduced Authority Thrust System. The reduced authority thrust system (RATS) reduces the wind-over-deck required for carrier landings by rapidly reducing thrust at the beginning of a successful arrestment, reducing the energy absorbed by the arresting gear. RATS logic, only resident in MC1, declares a successful arrestment if the landing gear and arresting hook are down and longitudinal deceleration is more than 1.0g (a typical arrestment is approximately 3g). MC1 sends a "set RATS on" signal to the FADECs, which reduce thrust to approximately 70 % of MIL power. RATS logic also senses WonW, wheel speed (less than 20 knots), and THA to prevent the engines from spooling back to MIL power at the end of cable pullout. RATS operation is canceled when the throttles are reduced to IDLE (THA less than 10°). RATS operation is inhibited during single engine operation.

RATS operation can be overridden by advancing the throttles to full afterburner (THA within 2° of the MAX stop). With RATS enabled, afterburner operation is inhibited if the throttles are subsequently advanced to afterburner (below the MAX stop). If the throttles are in afterburner (below the MAX stop) during an arrested landing, RATS functions normally, rolling back both the main engine and the afterburner.

2.1.1.1.11 AGI (Armament Gas Ingestion) Protection. AGI protection provides preemptive engine ignition in case armament gas ingestion causes an engine flameout. As mechanized, AGI protection is a backup to the FADEC's inherent flameout detection and relight logic. While flight test data indicates that the system may not be needed, AGI protection remains functional.

The AGI signal is sent by the Stores Management Set (SMS) to the FADECs and is used to initiate engine ignition (both engines) for 5 seconds. The signal is sent when the gun is fired, or any wing pylon mounted A/A or forward firing A/G weapon is launched. AGI is functional in the SIM mode as well as the tactical mode.

2.1.1.1.12 IBU (Increased Bleed Usage) Signal In LOT 26 and up, during high bleed flow rates, the mission computers may send the FADECs an IBU signal to prevent engine turbine overheating. When IBU scheduling is active, hot day MIL and MAX thrust may be reduced by up to 1.5 % compared to LOT 25 and below aircraft.

2.1.1.1.13 ABLIM - Afterburner Limiting Function. The ABLIM function limits engine power to half afterburner with the throttles at MAX to prevent engine stalls due to exhaust gas ingestion. The system is only to be used during carrier-based operations. The function is pilot selectable with WonW. The system defaults to disabled (unboxed) after engine start. The ABLIM function is activated by selecting (boxing) the ABLIM option on the CHKLIST format with the FLAP switch in HALF or FULL. The ABLIM advisory is set to confirm that the function has been activated on both engines.

With the function activated, only half afterburner power is available with the throttles at MAX. Indicated fuel flows are reduced from 35,000 to 45,000 pph to about 25,000 pph. The function is automatically deactivated with acceleration due to a catapult launch, at 80 KCAS, or with WoffW. The ABLIM function is disabled with a FCC CH 1, FCC CH 2, FCC CH 4, MC1, or FADEC failure.

2.1.1.2 Engine Related Cautions and Advisories. The following engine related cautions and advisories are described in the Warning/Caution/Advisory Displays in Part V:

- L or R EGT HIGH
- L or R ENG
- L or R ENG VIB
- FADEC HOT (ground only)
- L or R FLAMEOUT
- NO RATS
- L or R OIL HOT (engine or AMAD)
- L or R OIL PR
- L or R OVRSPD
- L or R STALL
- ABLIM advisory
- FADEC advisory

2.1.1.3 Engine Anti Ice. Each engine supplies its own bleed air for engine and inlet device anti-ice. The engine anti-ice system is normally controlled by the ENG ANTI ICE switch. However, after engine start (initial FADEC power-up or following a FADEC reset), the engine anti-ice system automatically turns on 45 seconds after the engine reaches idle power and remains on for 30 seconds, provided the throttle remains at IDLE. The appropriate LHEAT or RHEAT advisory is displayed during this anti-ice functional test.

With the ENG ANTI ICE switch ON, anti-ice air flows as long as INLET TEMP is between -40 and +15°C. Outside of these limits, anti-ice airflow is terminated immediately if airborne, or after 60 seconds with WonW. When anti-ice air is flowing, N₂ rpm increases approximately 2 %, and EGT increases approximately 5°C.

The inlet device has an anti-ice leak detection system. The system detects hot air leaks from the device air manifold or in the cavity between the device and the airframe and sets the L or R DEVC BLD caution. A hot air leak into the cavity reduces device anti-ice capability and may structurally damage the device and surrounding structure.

2.1.1.3.1 ENG ANTI ICE Switch. The ENG ANTI ICE switch is located on the ECS panel on the right console.

- | | |
|------|---|
| ON | Activates the engine anti-ice system |
| OFF | Deactivates the engine anti-ice system |
| TEST | Checks ice detector operation and displays the INLET ICE caution (indicating proper operation). |

2.1.1.3.2 Engine Anti-Ice Advisories. The L HEAT and R HEAT advisories are displayed when the engine anti-ice system is activated (ENG ANTI ICE switch ON or anti-ice functional test) and no system failures are detected. If an engine anti-ice failure occurs with the system turned on, the HEAT FAIL caution is displayed and the corresponding L HEAT or R HEAT advisory is removed.

If an engine anti-ice failure occurs with the ENG ANTI ICE switch OFF, the ~~HEAT~~ advisory is displayed. This advisory indicates that anti-ice operation is degraded or not available if selected.

2.1.1.3.3 Engine Anti-Ice Related Cautions and Advisories. The following engine anti-ice related cautions and advisories are described in the Warning/Caution/Advisory Displays in Part V:

- | | |
|---------------------------|-----------------------------|
| • L or R ANTI ICE caution | • INLET ICE caution |
| • L or R DEVC BLD caution | • L HEAT or R HEAT advisory |
| • HEAT FAIL caution | • HEAT advisory |

2.1.1.4 Engine Controls and Displays.

2.1.1.4.1 ENG CRANK Switch. The ENG CRANK switch is described in the Secondary Power System section.

2.1.1.4.2 Throttles. Two throttles, one for each engine, are located on the left console. Throttle movement is transmitted electrically to the corresponding FADEC for thrust modulation and to the FCCs for autothrottle operation. There is no mechanical linkage between the throttles and the engines. During engine start, advancing the throttles from OFF to IDLE opens the engine fuel control shutoff valves and, when commanded by the FADEC, provides fuel flow to the engines.

Afterburner operation is initiated by advancing the throttles through the MIL detent into the afterburner range. During catapult launch or carrier touchdown (WonW and launch bar or arresting hook extended), an afterburner lockout mechanism extends to preclude inadvertent afterburner selection. In such cases, the throttles can be moved to the afterburner range by raising the finger lifts on the front of each throttle or by applying a force of approximately 30 pounds.

During engine shutdown, the finger lifts must be raised to move the throttles to OFF, closing the engine fuel control shutoff valves. The throttle grips (figure 2-1) contain switches that allow control of various systems without moving the hand from the throttles.

2.1.1.4.3 Throttles (Trainer Configured F/A-18F). The rear cockpit of the trainer configured F/A-18F contains an additional set of flight controls: control stick, throttles, and rudder pedals. The rear cockpit throttles, located on the left console, are mechanically connected to those in the front cockpit and provide thrust modulation from IDLE to MAX. The rear throttles do not contain finger lifts, so the engines cannot be secured from the rear cockpit. The rear throttle grips are slightly different than those in the front cockpit. The ATC engage/disengage switch is not functional; the

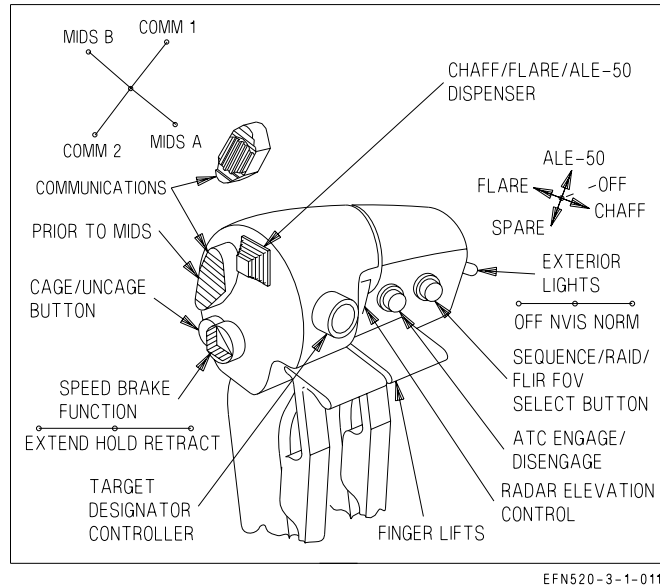

Figure 2-1. Throttle Grips (Front Cockpit)

chaff/flare/ALE-50 switch is not installed; and the speed brake switch is momentary action only. In general, systems controlled by throttle switches respond to the last crewmember action taken from either cockpit.

2.1.1.4.4 EFD - Engine Fuel Display, Engine Parameters. The EFD, located on the main instrument panel below the left digital display indicator (LDDI), is a night vision imaging system (NVIS) compatible, monochromatic, liquid-crystal, grey/black display powered by the Signal Data Computer (SDC).

The EFD normally displays critical engine parameters in the bottom half of the display and fuel quantities in the top half. The fuel portion of the EFD is described in the Fuel System section. Invalid parameters are usually displayed as 999 or 9999 in inverse video; out of limit parameters are always highlighted by inverse video. Nozzle position is displayed both graphically and digitally in percent open.

On battery power prior to APU start, the EFD either displays only RPM and TEMP or the entire top level format (figure 2-2). If the entire top level format is not displayed on battery power, it will be displayed when the APU switch is selected ON. When the APU switch is selected ON, only RPM, TEMP, and OIL pressure are valid. When the first engine alternator comes online at 10 % N_2 rpm, the FF parameter also becomes valid. When the first generator comes online at 60 % N_2 rpm, all parameters for both engines become valid. If the EFD locks up or blanks completely during engine start power transients, the display can be reset by selecting the SDC RESET option from the SUPT MENU/FUEL display.

The EFD displays the following engine parameters within the listed display tolerances:

RPM	Compressor rpm (N_2) (0 to 127 %) - Displays RPM in inverse video format above 102 %
-----	--

- TEMP Compensated turbine exhaust gas temperature (EGT) (186 to 1,088°C) - Displays 9999 in inverse video above 1,100°C
- FF Total commanded fuel flow including afterburner (0 or 400 to 65,000 pph in 100 pph increments).

NOTE

Engine fuel flow is calculated from commanded engine fuel metering valve position. In failure modes, fuel flow can be indicated on the EFD even though no actual fuel is flowing.

- OIL Oil pressure (0 to 200 psi)
- NOZ VEN position (0 to 101 % open)

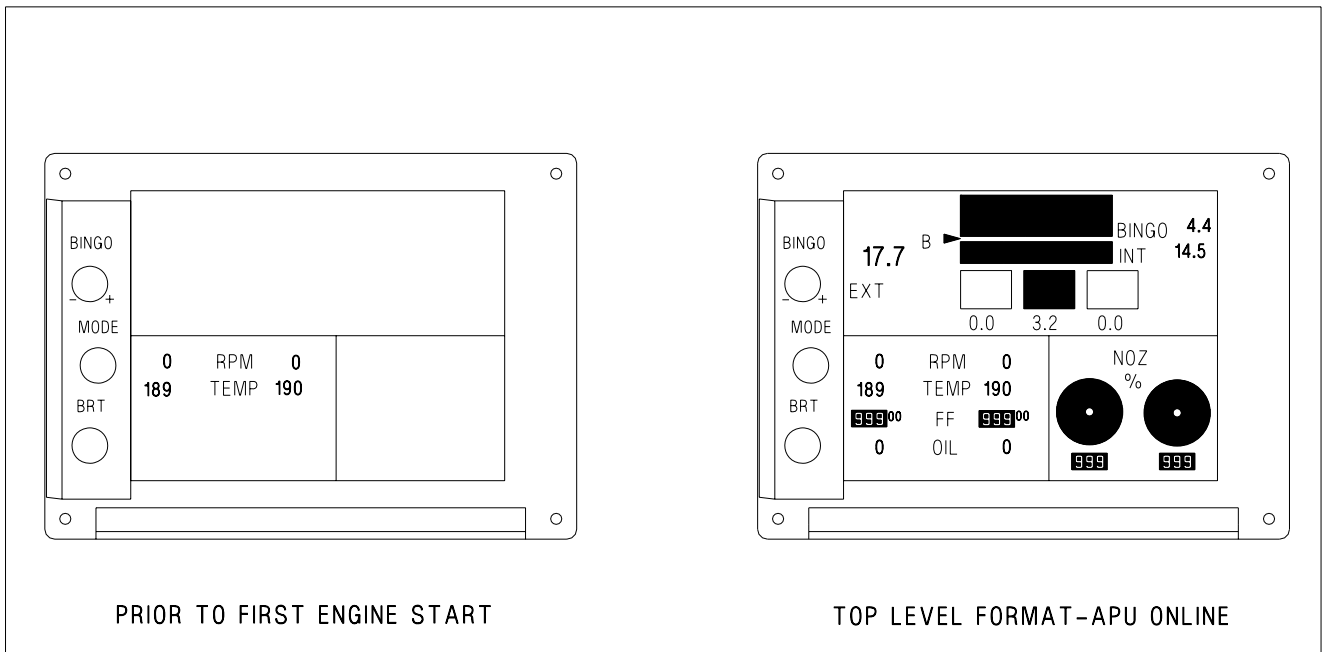

EFN520-337-1-001

Figure 2-2. Engine Fuel Display (EFD) - Engine Parameters

During first engine battery start, the EFD RPM indication typically jumps from 0 to either 5 % or 10 %, and lightoff is indicated by TEMP rising from a minimum reported value of approximately 190°C. Each engine has three sources of N₂ rpm: two engine alternator sensors and one accessory gearbox sensor. The accessory gearbox sensor can provide rpm readings down to only 5 % and is the initial source of engine RPM. Readings from the alternator sensors are not available until the alternator comes online above 10 % N₂ rpm. Input for the TEMP parameter is provided by a compensated EGT algorithm in the FADEC. When actual EGT is below accuracy tolerances (e.g., engine shutdown), the FADEC limits the minimum reported TEMP (approximately 190°C). The FF parameter is a calculated number based on metering valve position, not an actual measurement of fuel flow. Consequently, an indication of fuel flow may be present when there is no flow, such as when the throttle is above IDLE with the engine off.

2.1.1.4.5 ENG Display. The ENG display (figure 2-3) is selected by pushing the ENG option from the SUPT MENU. The ENG display shows the following engine and thermal management system parameters:

ENG STATUS	The current level of engine performance provided by the control system
INLET TEMP	Engine inlet temperature (°C)
N1 RPM	Fan speed (% rpm)
N2 RPM	Compressor speed (% rpm)
EGT	Exhaust gas temperature (°C)
FF	Total commanded fuel flow (pph)
NOZ POS	Nozzle position (% open)
OIL PRESS	Engine oil pressure (psi)
THRUST	Takeoff thrust (%), referenced to hot day MIL power (blanked inflight)
FAN VIB	Fan vibration (inches/second)
CORE VIB	Core vibration (inches/second)
EPR	Engine pressure ratio (exhaust pressure to engine inlet pressure).
CDP	Compressor discharge pressure (psia)
CPR	Compressor pressure ratio
THA	Throttle handle angle (deg)
AMAD OIL TEMP	AMAD oil temperature (°C)
ENG OIL TEMP	Engine oil temperature (°C)
FUEL INLET TEMP	Engine inlet fuel temperature (°C)
FUEL NOZ TEMP	Engine nozzle fuel temperature (°C)
FEED TANK TEMP	Feed tank fuel temperature (°C)

When an engine or thermal management system related caution appears, the MENU option at the bottom of each DDI is replaced with the ENG option, providing one pushbutton access to the ENG display. The value of the out of limit parameter which triggered the caution is displayed in red and highlighted by carets on either side. The CH A and CH B options at the top of the display are used to command a manual FADEC channel transfer, and the active FADEC channel for each engine is boxed.

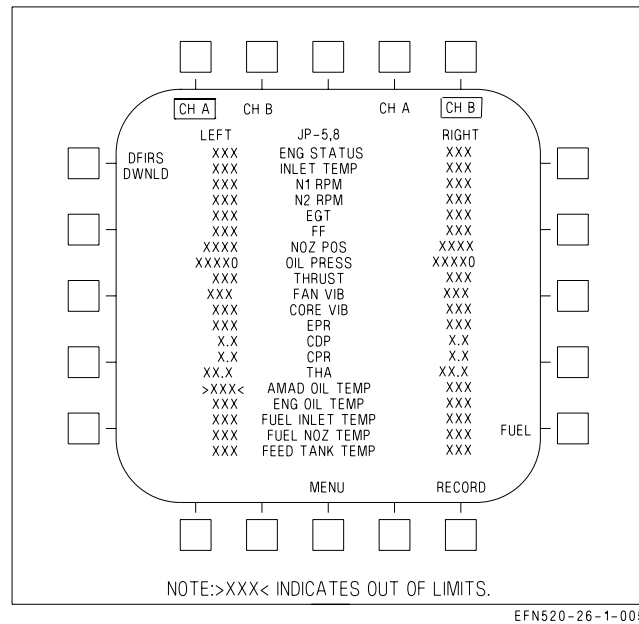

Figure 2-3. Engine Display

The selected fuel grade is displayed top center and also on the takeoff side of the CHKLIST display. The FUEL option enables the JP-5, 8, and JP-4 options, each of which must be selected twice to change the fuel grade. The fuel grade selected should reflect the majority of fuel in the aircraft. JP-5, -8 should be selected when using JET-A, A+, or A1. The engines can be started and operated at ground idle with either fuel grade selected; however, for operations above IDLE, the correct fuel grade must be selected to ensure proper engine operation and to avoid engine combustor rumble. The fuel grade selected is also used by the FADEC to control the thermal control valve (TCV) setting and determines the maximum fuel temperature to be sent to the engines. Incorrect fuel grade selection can adversely impact the fuel thermal management system and result in a premature FUEL HOT caution. The RECORD option, boxed when selected, saves a 30 second record of display and engine data (15 seconds pre- and 15 seconds post-event) to the memory unit (MU). The DFIRS DWNLD option downloads DFIRS data to the MU.

2.1.2 ATC - Automatic Throttle Control. The ATC system has two operating modes: approach and cruise. The system automatically modulates engine thrust between flight IDLE and MIL power in order to maintain on-speed angle of attack (AOA) in the approach mode or calibrated airspeed (existing at the time of engagement) in the cruise mode.

During ATC operation, engine commands are sent to the FADEC directly from the FCCs instead of the throttles. FCC generated engine commands are limited to a range slightly above idle to slightly below MIL. The throttles are continuously positioned by an FCC commanded backdrive unit to match the throttles with the current engine command and to provide feedback to the pilot.

2.1.2.1 ATC Engagement. Pressing and releasing the ATC button on the left throttle engages the approach mode with the FLAP switch in HALF or FULL and the cruise mode with the FLAP switch in AUTO. When either mode is engaged, an ATC advisory is displayed on the HUD. Because ATC mode engagement and ATC HUD advisories are not commanded until release of the ATC button, the pilot may need to deliberately pause after press and release to avoid inadvertent ATC disengagement/re-engagement. Automatic transition between the two modes or engagement during single engine operation is not possible. Engaging ATC with the friction lever in the full aft position and with the

throttles at mid-range power provides optimum pilot feedback with the smallest engagement power transients.

2.1.2.2 ATC Disengagement. If either mode does not engage when selected, or automatically disengages after engagement, the ATC advisory flashes for 10 seconds and is removed from the HUD. Disengagement for any reason requires reengagement to restore ATC operation. Normal disengagement is accomplished by re-actuation of the ATC button or by applying a force of approximately 12 pounds (friction off) to either throttle for greater than 0.20 seconds. This force is sufficient to permit the pilot's hand to follow throttle movement without causing disengagement. Holding the throttles against the MIL or IDLE stop during ATC disengagement commands a rapid acceleration or deceleration to the commanded power setting instead of a smooth transition.

2.1.2.3 ATC Automatic Disengagement. The ATC system automatically disengages for the following reasons:

Either mode -

- Any ATC system internal failure
- ATC button failure
- FADEC failure
- FCC CH 2 or CH 4 failure
- Backdrive failure
- THA split greater than 3° for more than 1 second
- FLAP switch position change between AUTO and HALF or FULL

Approach mode only -

- AOA, pitch rate, or Nz sensor failure
- Bank angle in excess of 70°
- Flap blowup at 250 KCAS
- Gain ORIDE selection
- Weight on wheels

Cruise mode only -

- FCC calibrated airspeed failure

2.1.2.4 ATC Related Cautions. The ATC FAIL caution is described in the Warning/Caution/Advisory Displays in Part V.

2.2 FUEL SYSTEM

The aircraft is fitted with four internal fuselage tanks (Tanks 1 through 4), two internal wing tanks (left and right), two fuselage vent tanks, and two vertical vent tanks. Tanks 2 and 3 are engine feed tanks while Tanks 1, 4, and the wing tanks are transfer tanks. Total fuel can be increased by the carriage of up to four 480 gallon external fuel tanks on the centerline, inboard, and midboard pylons. The aircraft can also be configured as an airborne tanker with the carriage of a centerline mounted air refueling store (ARS). All tanks, internal and external, may be refueled on the ground through a single-point refueling receptacle or inflight through the inflight refueling probe.

The aircraft's fuel system is composed of the following subsystems: engine feed, motive flow, fuel transfer, tank pressurization and vent, thermal management, refueling, fuel dump, fuel quantity indicating, and fuel low level indicating. Refer to Fuel System, Foldout Section, for simplified schematics.

2.2.1 Engine Feed System. Each engine feed system contains an airframe mounted accessory drive (AMAD) driven motive flow/boost pump, a feed tank with an internal motive flow powered turbo pump, and an engine feed shutoff valve. For survivability, the left and right feed systems are normally separated but can be interconnected by a normally closed crossfeed valve and a normally closed feed tank interconnect valve.

2.2.1.1 Motive Flow/Boost Pumps. Each AMAD drives a two-stage motive flow/boost pump. The first stage supplies low pressure fuel to its respective engine mounted fuel pump, while the second stage supplies high pressure fuel to the motive flow system. Fuel from the motive flow system is used to cool accessories, power the feed tank turbo pumps and certain transfer/scavenge pumps, and control certain transfer valves.

2.2.1.2 Feed Tanks. During normal operation, each engine receives fuel from separate fuel feed lines. Tank 2 supplies fuel to the left engine; Tank 3 to the right. A motive flow powered turbo pump in each feed tank supplies fuel to its respective motive flow/boost pump.

Each feed tank has a horizontal baffle which traps fuel, providing a minimum of 10 seconds of negative g flight at MAX power. No sustained zero g capability is provided, and prolonged transitions through zero g (greater than 2 seconds) may produce a L and/or R BOOST LO caution.

If a feed tank turbo pump fails, fuel is suction fed to the motive flow/boost pump. In this case, flight at high altitude with high feed tank fuel temperatures may not supply enough fuel for high power settings.

2.2.1.3 Feed Shutoff Valves. In the event of a fire or fuselage fuel leak, engine feed shutoff valves provide the capability to isolate a fuel feed system immediately downstream of the feed tank. Pressing the L or R FIRE warning light electrically closes the corresponding engine feed shutoff valve, isolating that fuel feed system.

2.2.1.4 Crossfeed Valve. The crossfeed valve, normally closed, allows a single motive flow/boost pump to feed both engines when boost pressure is lost on one side (e.g., single engine shutdown, a leak, motive flow/boost pump failure, or feed tank depletion). A loss of boost pressure downstream of the motive flow/boost pump sets the L or R BOOST LO caution and opens the crossfeed valve. An open crossfeed valve allows the output from the good motive flow/boost pump to supply fuel to the opposite engine at rates sufficient for at least MIL power.

Pressing the L or R FIRE warning light electrically closes (inhibits opening) the crossfeed valve, isolating the two fuel feed systems.

2.2.1.5 Interconnect Valve. A feed tank interconnect valve, installed between Tanks 2 and 3, is used to control gravity transfer/balancing between the two feed tanks. During normal operation, the dual flapper-type valve is held closed by motive flow pressure on either side (left motive flow on the Tank 2 side and right motive flow on the Tank 3 side), and no fuel gravity transfers.

If motive flow is lost on one side (e.g., single engine shutdown), the valve opens to make sure that feed tank fuel is available to the opposite engine. For instance, if motive flow is lost on the right side, the Tank 3 side of the valve opens, allowing fuel to gravity transfer to Tank 2 anytime the Tank 3 fuel

level is higher. If Tank 3 has a fuel leak (e.g., battle damage), motive flow pressure on the Tank 2 side of the valve prevents Tank 2 fuel from gravity transferring into the leak.

2.2.1.6 Feed Tank Balancing. The SDC incorporates feed tank balancing logic, designed to keep Tanks 2 and 3 within 100 lb of each other. With a normally operating fuel system, balancing begins after Tank 4 is effectively empty (less than about 300 lb) and the feed tanks begin to deplete below full. If a feed tank imbalance reaches 100 lb, the SDC shuts off the corresponding Tank 4 scavenge pump until the imbalance is 50 lb in the opposite direction. With WoffW, feed tank balancing continues until either feed tank reaches FUEL LO level (approximately 1,125 lb). Feed tank balancing stops at FUEL LO to make sure tank 4 fuel is transferred to both feed tanks in case one feed tank is damaged and is leaking. After transitioning to WonW, balancing is reinitiated and continues until either feed tank is below 300 lb.

In the event of a fuel transfer failure (e.g., a feed tank begins to deplete with fuel in Tank 4), feed tank balancing begins when either feed tank drops below approximately 2,100 lb for 1 minute. This mechanization attempts to minimize the effect of the fuel transfer failure by reducing the resulting feed tank split.

2.2.1.7 Feed Tank Imbalance with One Engine at Idle. If one engine is intentionally reduced to idle/low power or is commanded to IDLE by the FADEC, a higher rate of fuel depletion can be expected from the "good" engine's feed tank. At internal fuel weights below approximately 4,900 lb (transfer fuel depleted), a fuel split can be expected to develop between the feed tanks (interconnect valve is closed). If fuel burn continues to approximately 2,450 lb, the good engine feed tank depletes and runs dry. The motive flow/boost pump output pressure on the good side drops, sets the L or R BOOST LO caution, and opens the crossfeed valve. The good engine feeds from the opposite feed tank through the crossfeed valve.

When driven by an idling engine, a motive flow/boost pump can support fuel flow up to 28,000 pph through the crossfeed valve (MIL power fuel flow is approximately 12,000 pph at sea level, standard day). If the fuel flow demand on the usable engine exceeds 28,000 pph (midrange afterburner), motive flow/boost pump output pressure drops, setting the other BOOST LO caution, closing the crossfeed valve, and starving the good engine. MAX power, single engine fuel flow is approximately 38,500 pph at sea level, 0.2M, standard day (approach conditions).

WARNING

Selecting afterburner on the good engine with its feed tank reading empty results in engine flameout if fuel flow exceeds 28,000 pph.

The only way to balance a growing feed tank split is to shutdown the idling engine. This opens both the interconnect and crossfeed valves. The risk of balancing is a loss of hydraulic and electrical redundancy provided from the engine if left at idle.

2.2.2 Fuel Transfer System. The fuel transfer system, controlled by the SDC, is designed to keep the feed tanks full or near full during normal engine operation. Fuel is routed from Tanks 1 and 4, the internal wing tanks, and external fuel tanks, if installed, through three independent sets of transfer lines. Additionally, the SDC schedules Tank 1 and 4 transfer to control fuel center of gravity (CG).

2.2.2.1 Fuel Transfer - Tanks 1 and 4. Fuel is transferred from Tanks 1 and 4 to the feed tanks by two dual-speed electric transfer pumps, one in each tank. The low speed setting is used for normal

transfer. The high speed setting is used during high fuel flow conditions such as afterburner operation, ARS replenishment, or fuel dump. The one exception to this is that the Tank 1 transfer pump remains in low speed setting during afterburner operation. During normal operation, each pump pressurizes the Tank 1 and 4 transfer line as long as its tank has transfer fuel available. The SDC shuts down the electric transfer pumps when the respective tanks are dry (Tank 1 empty, Tank 4 approximately 300 lb).

Jet level sensors (JLS) in the feed tanks control the flow of transfer fuel from the Tank 1 and 4 transfer line. For instance, Tank 2 does not accept fuel until its fuel quantity drops to approximately 2,100 lb, uncovering the JLS and opening the transfer valve. Tank 2 accepts fuel until its fuel quantity reaches approximately 2,450 lb, covering the JLS and closing the transfer valve. Therefore, during normal operation, Tank 2 fuel level cycles between 2,100 and 2,450 lb as long as transfer fuel is available (JLS cycling).

Flapper valves in Tanks 1 and 4 provide a backup gravity transfer capability in certain circumstances. The flapper valve in Tank 4 is free flowing, gravity transferring to Tank 3 any time the Tank 4 fuel level is higher. Therefore, Tank 4 tends to keep Tank 3 full (near 2,600 lb) until the Tank 4 fuel level drops below that of Tank 3 (wing tank fuel depleted). The flapper valve in Tank 1 is controlled by left motive flow. The valve can be opened by the SDC following a Tank 1 transfer pump failure or by loss of motive flow (left engine shutdown).

Since the Tank 4 transfer pump is not located on the bottom level of the tank, two motive flow powered scavenge pumps, one routed to Tank 2 and the other to Tank 3, are installed to transfer the last 300 lb of Tank 4. With empty transfer tanks, an excessive feed tank fuel split following symmetric engine operation may indicate a Tank 4 scavenge pump failure. There is no SDC monitoring of the Tank 4 scavenge pumps.

The Tank 1 and 4 transfer pumps are also used to dump fuel through the dump valve and to transfer fuel to the ARS through the ARS replenishment valve.

2.2.2.1.1 Fuel Transfer Schedule/CG Control. The SDC implements a fuel transfer schedule (figure 2-4) designed to keep aircraft CG at an optimum location. The system periodically shuts off the Tank 1 transfer pump to keep Tank 1 and Tank 4 properly balanced. Fuel transfer scheduling operates until Tank 4 drops below 300 lb or the FUEL LO caution comes on. When Tank 4 reaches 300 lb, Tank 1 should indicate 250 lb or below.

The FUEL XFER caution is set when Tank 1 and 4 fuel is not scheduling properly or wing tank imbalance exceeds 350 lb. The caution is inhibited when the inflight refueling probe is extended.

2.2.2.2 Fuel Transfer - Internal Wing Tanks. Fuel is transferred from the wing tanks to Tank 4 by two motive flow powered ejector pumps, one in each tank. When Tank 4 is less than full, the SDC opens both wing motive flow control valves, which direct motive flow to the ejector pumps and transfer fuel from the wing tanks to Tank 4. When Tank 4 is full, the motive flow control valves are closed and normal wing transfer is inhibited.

If motive flow is lost on one side (single engine shutdown), the cross-motive shutoff valve opens so that one motive flow system can power the ejector pumps in both wing tanks. If both motive flow systems are lost, the wing tanks gravity transfer to Tank 4. Bank angle changes or a steady sideslip may be required to gravity transfer all available wing fuel.

2.2.2.2.1 Wing Tank Balancing. The SDC incorporates wing tank balancing logic designed to keep wing tank asymmetry below 200 lb. If wing tank asymmetry exceeds 200 lb, the SDC shuts off fuel

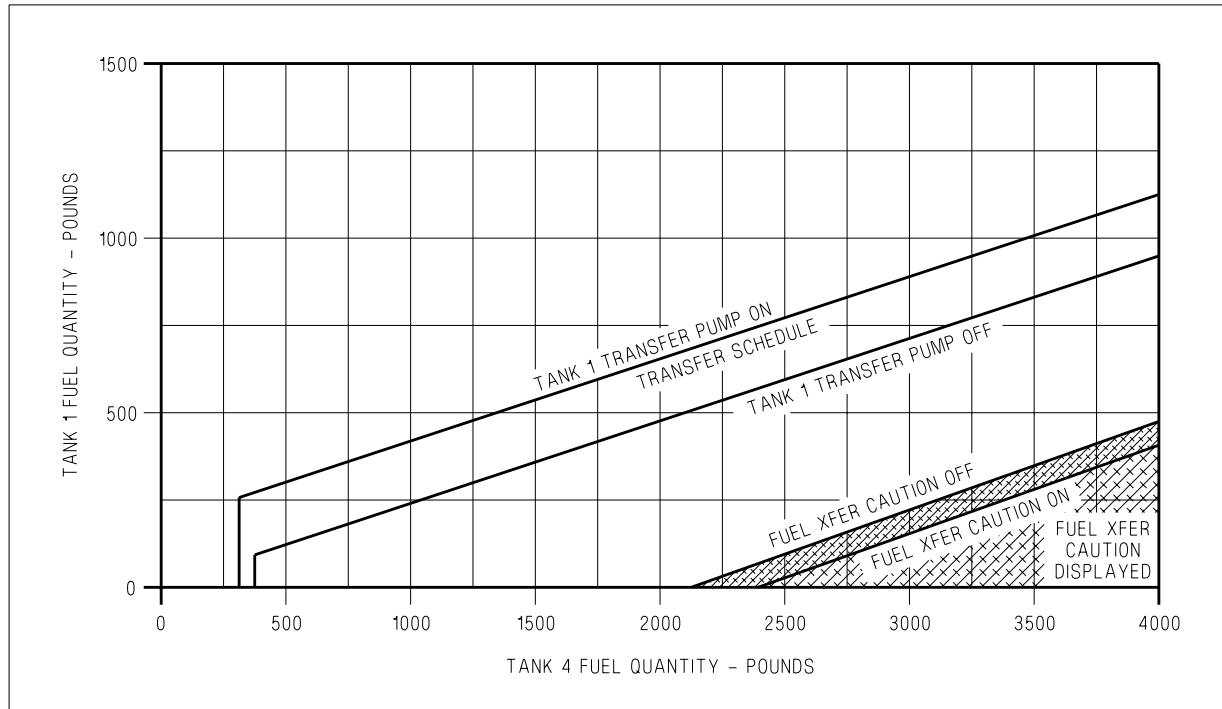

EFN520-46-1-001

Figure 2-4. Tank 1 and 4 Fuel CG Control and FUEL XFER Caution Schedule

transfer from the lower tank by closing its wing motive flow control valve. If wing tank asymmetry exceeds 350 lb for 15 seconds, the FUEL XFER caution appears.

Wing tank balancing also occurs during refueling, where the SDC alternately opens/closes the wing refuel valves attempting to keep the wing tanks within 200 lb. The FUEL XFER caution is not set during refueling. If SDC balancing logic cannot keep the wings from refueling asymmetrically (greater than 350 lb), the FUEL XFER caution is set when the inflight refueling probe is retracted.

2.2.2.2 INTR WING Control Switch. The INTR WING control switch, located on the EXT LT panel on the left console, is used to isolate the wing tanks (e.g., following battle damage).

INHIBIT Prevents normal transfer and refueling of the wing tanks (closes both wing motive control valves, both wing refuel valves, and switches both diverter valves, located in Tank 3, from the wing tanks to the feed tanks).

NORM Permits normal transfer and refueling of the internal wing tanks.

2.2.2.3 External Fuel Transfer. External fuel is transferred by regulated engine bleed air pressure applied to all installed external tanks with WoffW. External tank pressurization is terminated for inflight refueling (PROBE switch in EXTEND) and for arrested landing (both HOOK and LDG GEAR handles down). With pressurization applied, external fuel transfer is controlled by the three EXT TANKS transfer switches.

During external transfer, fuel is routed through the aircraft's refuel/defuel line. Refuel valves in each tank open only if commanded by the SDC and space is available. At MIL power and below, the SDC

only allows external fuel to transfer to Tank 1 and the wing tanks. In afterburner, the SDC allows external fuel to transfer to any internal tank that can accept it.

NOTE

In Lots 21 - 25, SDC CG control logic (CG Restart) inhibits external fuel transfer in flight and on deck with ORIDE selected until Tank 1 fuel quantity depletes to approximately 900 lbs. After external fuel transfer begins, erroneous empty (<200 lbs) external fuel quantity readings, which may occur during climbs/dives, can reinitiate CG Restart logic inhibiting external fuel transfer until Tank 1 fuel quantity depletes again to approximately 900 lbs. To initiate immediate external fuel transfer in flight or to check external fuel transfer on deck (i.e., override CG Restart logic), the IFR probe must be extended for at least 25 seconds prior to retraction with at least one EXT TANKS switch in ORIDE.

2.2.2.3.1 EXT TANKS Transfer Switches. The three EXT TANKS transfer switches are located on the FUEL panel on the left console and are labeled LM/RM, LI/RI, and CTR (left and right midboard, left and right inboard, and centerline tanks, respectively). With the external tanks pressurized, fuel transfers when the FUEL LO caution is displayed regardless of the position of the EXT TANKS transfer switches.

- ORIDE Applies pressurization and transfers fuel from all external tanks whose switches are not in STOP. May be used to transfer external fuel during extended ground operations (EXT TANK caution). Overrides any SDC stop transfer command.
- NORM Permits normal transfer and refueling of controlled external tank(s).
- STOP Prevents transfer and refueling of controlled external tank(s) except with a FUEL LO caution.

NOTE

- For ARS configured aircraft: If fueling of the ARS is not desired during aerial refueling, as the receiver, CTR ORIDE must be selected since CTR STOP will not prevent fuel from entering the ARS. Selecting CTR ORIDE will pressurize all external fuel tanks and significantly reduce refueling rate.
- If the ARS control panel is installed, centerline external tank transfer is inhibited unless the STORE switch is in FROM. ORIDE on the CTR EXT TANKS switch will have no effect.

2.2.3 Fuel Tank Pressurization and Vent. In Lots 21 thru 23, the internal fuel tank pressurization system provides regulated engine bleed air pressure to all internal tanks to prevent fuel boil-off at altitude. Bleed air pressure is applied to all internal tanks with WoffW. Pressurization is terminated for inflight refueling (PROBE switch in EXTEND) and for arrested landing (both HOOK and LDG GEAR handles down). In Lots 24 and up, internal tank pressurization is supplied by ram air only from the vertical tail vents and no longer augmented by engine bleed.

The vent system provides over-pressure and over-fill relief for the internal tanks. Pressurization is applied to the vent lines in the two fuselage vent tanks. The vent lines connect all internal tanks and are ported through the fuselage and vertical tail vent tanks to outlets located on the side of the vertical tail. Normally, the vent lines contain only pressurized air; however, if a refuel valve failure overfills an internal tank, fuel flows through the vent lines to the fuselage vent tanks. Two motive flow powered vent tank scavenge pumps return this fuel from the fuselage vent tanks to the feed tanks.

Additionally, the vent system provides pressure relief of the internal fuel tanks during climbs and vacuum relief during descents, if the pressurization system fails.

2.2.4 Thermal Management System. The thermal management system uses fuel from the high pressure fuel stage of the motive flow/boost pump to cool the FADECs, liquid coolant, and AMAD and hydraulic oils. The high pressure motive flow output of the pump has four branches.

The first branch is used to run motive flow powered pumps and valves in the fuel system. The second branch directs cooling flow to the FADEC and exits into the fuel recirculation return line.

The third branch runs through the liquid coolant/fuel heat exchanger and the combined AMAD oil and hydraulic oil/fuel heat exchanger in order to cool those fluids. A hot fuel diverter valve in the third branch either directs fuel away from the engine and into the fuel recirculation return line or directs fuel to the engines where it is combined with fuel feed from the motive flow/boost pump and burned.

Recirculated fuel first passes through a fuel/air heat exchanger bypass valve, which either directs the fuel through or around the fuel/air heat exchanger. When sufficient recirculation fuel flow is present, the SDC may open the heat exchanger bypass valve (Mach greater than approximately 0.35) to direct hot fuel through the fuel/air heat exchanger. Then, the fuel passes through a diverter valve, located in Tank 3, which either directs the fuel to the wing tanks or the feed tanks. Fuel directed to the wing tanks then flows to Tank 4 for additional cooling. When Tank 4 is below 300 lb, recirculation fuel is returned to the feed tanks by the Tank 4 scavenge pumps. When recirculation fuel is diverted to the wing tanks, modulation of wing fuel quantities on cockpit fuel displays is noticeable at lower wing fuel levels.

The engine thermal control valve (TCV), located in the engine fuel control unit, maintains engine combustor nozzle, engine lube oil, and aircraft accessories within their temperature limits. When the system determines that more cooling is required (typically due to hot weather or low fuel levels), the TCV opens, directing feed fuel into the recirculation return line. With the TCV open, greater cooling flow is induced through the engine lube oil and aircraft accessory heat exchangers, and the FADEC, ultimately reducing system temperatures.

The fourth branch runs to the cross cooling valve which opens following a motive flow system failure, allowing one motive flow system to cool both FADECs and both engines' accessories.

During ground operations, when temperatures exceed 40°C (30°C in LOT 26 and up), the liquid coolant pump and Liquid Cooling System (LCS) ground cooling fan may be commanded on (if not already on) to provide LCS cooling of the fuel system. In LOT 25 and below, the bypass valve, which allows liquid coolant to the liquid coolant/fuel heat exchangers, is solely controlled by the liquid coolant temperature, so the amount of fuel cooling provided (if any) depends on the temperature of each fluid. In LOT 26 and up, the bypass valve is controlled by the ECS controller and will only direct liquid coolant to the liquid coolant/fuel heat exchanger if the RADAR knob is in OFF.

NOTE

In LOT 26 and up, the RADAR knob must be in OFF in order to provide any postflight LCS fuel cooling.

In either case, placing the RADAR knob to OFF removes the radar as a heat source and should extend ground operating time.

2.2.4.1 Fuel/Air Heat Exchanger. A fuel/air heat exchanger is located above each engine inlet, near the leading edge. When the heat exchanger bypass valve is open, the heat exchanger uses inlet air to provide additional fuel cooling. Air is drawn from the inlet through several banks of small pin holes (bleed plates) and is exhausted through the spoiler opening on the upper surface of the LEX/fuselage.

2.2.4.2 Fuel/Air Heat Exchanger Leak Detection. Since a leak in the fuel/air heat exchanger can result in engine fuel ingestion through the bleed plates, a leak detection system is incorporated. If a fuel leak is detected during fuel/air heat exchanger operation, the SDC closes the heat exchanger bypass valve and isolates the heat exchanger.

Leak detection logic is only capable of detecting a leak greater than approximately 400 pph in the fuel air heat exchanger. Fuel flow through the heat exchangers is inhibited below approximately Mach 0.35 and anytime the ECS auxiliary scoops are deployed to guard against potential for engine inlet fuel ingestion.

A leak of less than 400 pph can, however, be discovered during the post-flight switching valve checks. Following engine shutdown, the SDC opens the cross cooling valve and the heat exchanger bypass valve on the non-operating side for 20 seconds. If ground crew observe fuel exiting from the fuel/air heat exchanger drainage ports (bottom, inboard edge of the inlet), a leak exists.

2.2.5 Refueling System. The aircraft can be refueled on deck through a single point refueling receptacle or inflight through a hydraulically actuated inflight refueling probe. The refueling receptacle is located behind door 8R on the forward right fuselage. The refueling probe is located on the upper right side of the fuselage forward of the windscreen. A fuel pressure regulator/surge suppressor is installed downstream of the refueling probe in order to control pressure spikes associated with inflight refueling. Fuel from the single point receptacle or the refueling probe enters the refuel/defuel line and is routed to all internal and external tanks. During refueling, the SDC opens all refuel valves, allowing fuel to transfer into all internal tanks. External tank pressurization is terminated when the probe is extended, allowing the refuel/defuel line to fill all installed external tanks (EXT TANKS switch(es) not in STOP).

2.2.5.1 PROBE Switch. The guarded PROBE switch, located on the FUEL panel on the left console, is used to extend and retract the inflight refueling probe.

EXTEND Extends the inflight refueling probe using HYD 2A pressure, energizes the probe light (external lights master switch in NORM), and depressurizes all internal and external tanks.

RETRACT Retracts the inflight refueling probe using HYD 2A pressure, deenergizes the probe light, and repressurizes the internal and external tanks. The probe cannot be retracted if HYD 2A pressure is not available.

**EMERG
EXTD** Emergency extends the inflight refueling probe using either HYD 2B or APU accumulator pressure, energizes the probe light (external lights master switch in NORM), and depressurizes all internal and external tanks.

2.2.6 Fuel Dump System. The fuel dump system allows all fuel except feed tank fuel to be dumped overboard. The dump valve, controlled by the DUMP switch, is located in the Tank 1 and 4 transfer line. With the dump valve open, the Tank 1 and 4 transfer pumps (high-speed setting) force fuel out

the dump outlet, located on the trailing edge of each vertical tail. Wing tank fuel is dumped by transferring to Tank 4 with the INTR WING switch in NORM. External fuel is dumped by transferring to Tanks 1 and 4 only with the EXT TANKS switch(es) in NORM or ORIDE.

NOTE

Anytime four external fuel tanks are loaded on wing stations (3, 4, 8, and 9), selecting ORIDE on LI/RI external transfer switch will improve dump performance and external transfer rate by commanding simultaneous transfer of all external tanks vs. normal transfer sequence (tanks on Stations 3/9 must be empty prior to tanks on Stations 4/8 transferring). Performing this function imposes airspeed limitations defined in Figure 4-12.

Dump rate is typically in excess of two engine MAX power fuel flow, approximately 1,300 lb per minute (78,000 pph). Fuel dumping continues until:

- a. The DUMP switch is placed to OFF.
- b. The BINGO caution comes on.
- c. Tanks 1 and 4 are empty and all available fuel from internal wing and external tanks has been depleted.
- d. The FUEL LO caution comes on.



Simultaneous selection of fuel dump and afterburner during high AOA maneuvering may ignite fuel and cause fuselage damage.

2.2.6.1 Fuel DUMP Switch. The lever locked fuel DUMP switch, located on the FUEL panel on the left console, is spring loaded to the OFF position and electrically held in the ON position.

- ON Opens the dump valve, allowing transfer tank and external tank fuel to be dumped. The switch reverts to OFF with a BINGO or FUEL LO caution. With either caution, holding the switch in the ON position with Tank 1 and/or 4 fuel available reinitiates fuel dump.
- OFF Dump valve closed

2.2.7 Fuel Quantity Indicating System. The fuel quantity indicating system measures the individual fuel quantities in all internal and external fuel tanks and provides cockpit readouts for individual tanks, total internal fuel, and total fuel onboard. Quantities are displayed on the EFD and the FUEL display, rounded to the nearest 10 pounds (figure 2-5). Actual fuel tank probe readings are displayed on the FUEL QTY display selected from the SUPT MENU/BIT/STATUS MONITOR display.

While the volume of fuel with full tanks does not change, the fuel quantities listed in pounds vary with changes in temperature and fuel density. Full internal fuel quantity can vary from 13,250 to 15,960 lb for the F/A-18E or from 12,410 to 14,940 lb for the F/A-18F at fuel temperatures of 100° and -40° F, respectively. Figure 2-5 lists standard day fuel quantities for JP-5, JP-8, and JP-4.

INTERNAL TANKS

TANK		USABLE FUEL			
		GALLONS	POUNDS JP-5	POUNDS JP-8	POUNDS JP-4
TANK 1	F/A-18E	350	2380	2340	2280
	F/A-18F	212	1440	1410	1380
TANK 2 (LEFT ENGINE FEED)		383	2600	2560	2490
TANK 3 (RIGHT ENGINE FEED)		385	2620	2580	2500
TANK 4		555	3780	3720	3610
TOTAL FUSELAGE	F/A-18E	1673	11,380	11,200	10,870
	F/A-18F	1535	10,440	10,280	9980
LEFT WING/RIGHT WING		244/244	1660/1660	1640/1640	1590/1590
TOTAL INTERNAL WING		489	3320	3280	3180
TOTAL INTERNAL	F/A-18E	2162	14,700	14,480	14,050
	F/A-18F	2024	13,760	13,560	13,160

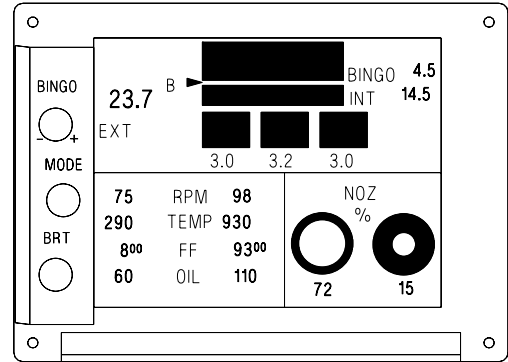

NOTE

- FUEL WEIGHTS ARE BASED ON JP-5 AT 6.8 POUNDS PER GALLON (LBS/GAL), JP-8 AT 6.7 LBS/GAL OR JP-4 AT 6.5 LBS/GAL AND A TEMPERATURE OF 15 °C (59 °F).
- FUEL QUANTITIES, IN POUNDS, ARE ROUNDED TO THE NEAREST 10 POUNDS. THE ACTUAL GALLONS TIMES 6.8, 6.7 OR 6.5 WILL NOT NECESSARILY AGREE WITH THE POUNDS COLUMN.

EXTERNAL TANKS

480 GAL. TANK	WING	480	3260	3210	3120
	CENTERLINE	473	3220	3170	3070

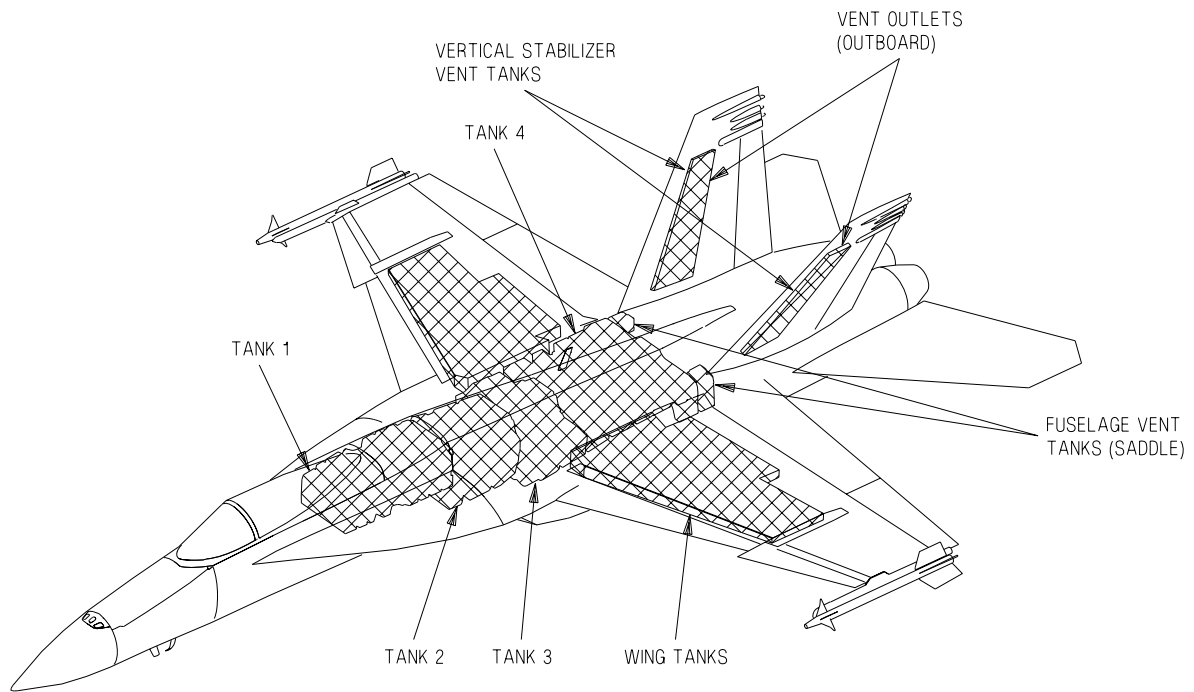

EFN520-53-1-005

Figure 2-5. Fuel Quantity

2.2.7.1 EFD - Engine Fuel Display, Fuel Parameters. The EFD displays fuel, maintenance code, and consumables information in green digits on a black background (figure 2-6). The top level EFD format graphically displays total internal fuel, bingo level, and fuel quantities for up to five external fuel tanks. The shaded regions of each graphic display the ratio of fuel available to fuel capacity. Digital readouts of total fuel (large numbers), total INT fuel, external fuel tank quantities, and current BINGO setting are also provided but are truncated to 100 lb increments.

The internal fuel format graphically displays only internal fuel tank quantities. Digital readouts of feed tank fuel quantities are also provided, truncated to 100 lb increments.

During battery start of the engines, the EFD displays either three or five external fuel tanks if one or more external fuel tanks are installed. For instance, if a full centerline tank is installed, the EFD displays a full centerline graphic and 3.2 lb fuel. The inboard/midboard tanks appear empty reading 0.0 lb fuel. When the SMS completes startup BIT and initial inventory, the EFD displays only the installed tank(s).

The aircraft fuel load can be checked on battery power by placing the ENG CRANK switch to L or R, by starting the APU, or by resetting the MSP codes in the nose wheelwell. In the F/A-18F, the total fuel load and the tank one fuel ratio will be in error, since the SDC defaults to F/A-18E settings while on battery power. The total fuel load will appear 200 to 400 lb high, and the Tank 1 graphic (as displayed on the internal format) will indicate approximately two-thirds when Tank 1 is, in fact, full. When the MCs become operative with ac power applied, the total fuel load will be correct, and the EFD will show the correct Tank 1 fuel ratio.

Bingo level is adjusted in hundred pound increments by rotation of the BINGO knob and thousand pound increments by pull and rotation (clockwise is increasing). The MODE button toggles the EFD between the top level and internal fuel formats. Pressing the MODE button for greater than 1.5 seconds selects the MSP format. With the MSP format displayed, the BINGO knob cycles between MSP code pages if more than one is present. Pressing the MODE button again for greater than 1.5 seconds runs and displays the results of a consumables test. Subsequent actuation for less than 1.5 seconds returns to the last displayed top level or internal fuel format. Clockwise rotation of the BRT knob increases the display's brightness.

In the F/A-18F, the formats can be displayed on the aft EFD independently from the front EFD.

2.2.7.2 FUEL Display. The FUEL display (figure 2-7) is selected by the FUEL option on the SUPT MENU. The FUEL display lists TOTAL fuel (internal and external), total INTERNAL fuel, the available fuel in each tank, and the current BINGO setting. A moving caret is shown on the right side of each tank, indicating the ratio of fuel available to tank capacity.

The SDC continuously monitors the validity of the fuel probes installed in each tank. If all probes in a tank (except the feed tanks) are declared invalid, the SDC displays 0 lb fuel and the INV (invalid) cue next to the tank. If one or more probes in a multi-probe tank are declared invalid, the SDC displays the total of the valid probes only and the EST (estimated) cue next to the tank. If a feed tank fuel probe is invalid, the SDC displays 1,125 lb (0 lb if the FUEL LO caution is set) and the EST cue. The TOTAL and INTERNAL fuel values indicate the sum of all valid and estimated tank quantities with EST cues (INV cues if any tank is INV).

The FLBIT option on the FUEL display is used to initiate a BIT of the fuel low level indicating system. The FLBIT option remains boxed during BIT. A satisfactory test results in a FUEL LO caution and voice alert within 13 seconds of BIT initiation. FLBIT cannot be initiated with a FUEL

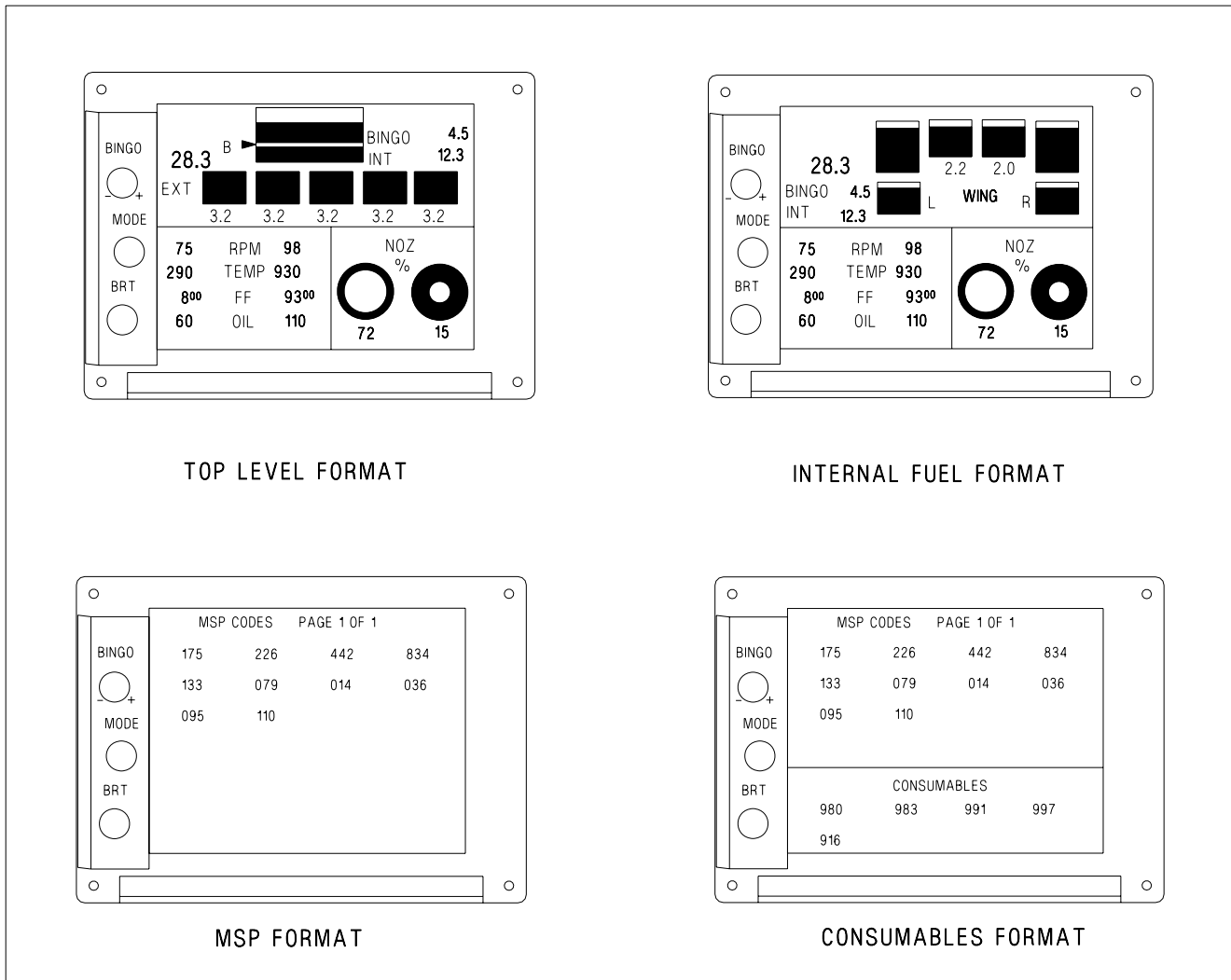

Figure 2-6. Engine Fuel Display (EFD) - Fuel Parameters

EFN520-4-1-001

LO caution set or an SDC failure. An SDC RESET option is provided to command an SDC software reset.

2.2.7.3 F-QTY Advisory. The F-QTY advisory indicates an SDC or fuel quantity indicating system failure which affects the accurate display of fuel quantity or CG information. The advisory is activated when:

- a. The MC loses communication with the SDC.
- b. The SDC reports an internal or gauging system failure.
- c. Any tank quantity is INV.
- d. The SDC reports its output discretes are not working.

If a F-QTY advisory results from loss of MC communication with the SDC or the SDC reporting an internal or gauging system failure, the MC is unable to report actual fuel quantities and the following are displayed on the FUEL display (GLIM 7.5G caution):

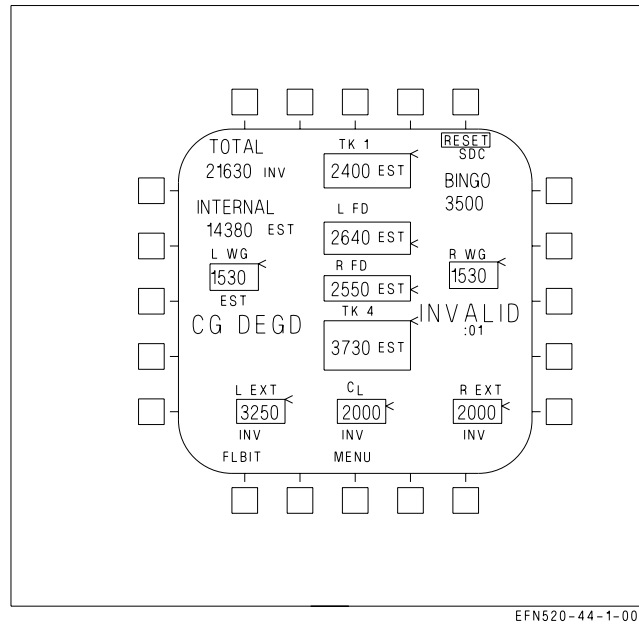

Figure 2-7. FUEL Display

- All fuel quantities (except TOTAL) are held at their last displayed value.
- TOTAL fuel is estimated by the MC based on the last valid fuel quantity and engine fuel flow.
- A flashing ESTIMATED cue is displayed along with a minutes and seconds (XX:XX) timer which indicates the duration since the displayed fuel quantities were last updated.

2.2.8 Fuel Low Level Indicating System. The fuel low level indicating system is completely independent of the fuel quantity indicating system. When the fuel level in either feed tank drops to approximately 1,125 lb, a FUEL LO caution, caution light, and voice alert are activated, and the affected fuel tank quantity is displayed in inverse video on the EFD. If a low level indication was set by a transient condition, such as prolonged negative g flight, the cautions remain on for 1 minute after the low level indication is removed.

WARNING

If the FUEL LO cautions are set, assume that at least one feed tank is below approximately 1,125 lb regardless of displayed fuel quantity indications.

2.2.9 Fuel System Related Cautions. The following fuel system related cautions are described in the Warning/Caution/Advisory Displays in Part V:

- L or R BOOST LO
- L or R FUEL HOT
- L or R FUEL INLT
- FUEL XFER
- EXT XFER
- EXT TANK
- TK PRES LO
- TK PRES HI
- L or R THERMAL
- FADEC HOT (WonW, IDLE or above)
- PROBE UNLK
- REFUEL DR
- DUMP OPEN
- FUEL LO caution, caution light, and voice alert
- BINGO caution and voice alert

2.3 FPAS - FLIGHT PERFORMANCE ADVISORY SYSTEM

NOTE

FPAS is functional in MC OFP H1E AND UP.

The flight performance advisory system (FPAS) is provided to aid the pilot in making time, fuel, and distance calculations. Readouts for maximum range and maximum endurance are provided for three flight conditions: current Mach and altitude, optimum Mach at the current altitude, and optimum Mach and altitude. These three readouts can be used to adjust the aircraft flight profile to meet mission requirements. Additionally, FPAS provides fuel remaining at arrival and recommended distance to begin descent from the selected waypoint or TACAN station. Range, time, altitude, Mach, and fuel are calculated by the FPAS algorithm and appear on the FPAS display.

2.3.1 FPAS Display. The FPAS display (figure 2-8) appears when the FPAS option is selected from the SUPT MENU. The display is divided into five areas: the current range and endurance area, the waypoint/TACAN steering area, the fuel flow area, the optimum range and endurance area, and the default area. With engines running and WonW, only the optimum and default areas are valid. With WoffW, all five areas are valid. Waypoint/TACAN steering information is provided with WoffW and waypoint or TACAN steering selected (boxed) on the HSI display.

2.3.1.1 FPAS CURRENT RANGE and ENDURANCE. The CURRENT RANGE area displays three calculations: the range in nautical miles TO 2000 LB fuel remaining at the current altitude and Mach, the BEST MACH to fly at the current altitude to maximize range, and the range TO 2000 LB fuel remaining if the BEST MACH is flown. If parameters used to calculate current range become invalid, X's replace the current range value, and an FPAS advisory replaces the current endurance value.

The CURRENT ENDURANCE area displays three calculations: the time in hours and minutes TO 2000 LB fuel remaining at the current altitude and Mach, the BEST MACH to fly at the current altitude to maximize endurance, and the endurance TO 2000 LB fuel remaining if the BEST MACH is flown. If parameters used to calculate current endurance become invalid, X's replace the current endurance value.

If IMN exceeds Mach 0.9, a MACH advisory replaces the current range value, and a LIM advisory replaces the current endurance value. When total fuel drops below 2,500 lbs, the FPAS calculations shift to 0 lbs remaining, and the TO 2000 LB legend changes to TO 0 LB.

2.3.1.2 FPAS Waypoint/Tacan Steering and the HSI Display. If waypoint or TACAN steering is selected (boxed) on the HSI display, the selected waypoint or TACAN station is displayed under the NAV TO legend, and the arrival time and fuel remaining at arrival (at the current flight conditions) are displayed under the TIME and FUEL REMAIN legends, respectively.

Fuel remaining at arrival and recommended distance to begin descent from the selected steering source are displayed on the HSI display. If the recommended distance to begin descent is greater than 99 miles, 99 is displayed.

If FPAS waypoint/TACAN steering parameters become invalid, X's replace the fuel remaining and descent distance values. If IMN exceeds Mach 0.9, fuel remaining values are blanked. If fuel remaining at the selected steering source is less than the TO 2000 LB or TO 0 LB legend, the WYPT number, the TO 2000 (0) LB legend, and the fuel remaining value flash on the FPAS display and the fuel remaining value flashes on the HSI display. If fuel remaining is calculated to be less than 0 lbs, 0 is displayed.

2.3.1.3 FPAS Fuel Flow. The total fuel flow rate (both engines) is displayed in pounds per nautical mile under the LB/NM legend whenever the engines are running.

2.3.1.4 FPAS OPTIMUM RANGE and ENDURANCE. The OPTIMUM RANGE area displays three calculations: the optimum ALTITUDE and MACH to fly to achieve the displayed maximum range TO 2000 LB. If parameters used to calculate optimum range become invalid, X's replace the altitude, Mach, and range values.

The OPTIMUM ENDURANCE area displays three calculations: the optimum ALTITUDE and MACH to fly to achieve the displayed maximum endurance time TO 2000 LB. If parameters used to calculate optimum range or optimum endurance become invalid, X's replace the altitude, Mach, range, and time values.

When total fuel onboard drops below 2,500 lbs, the FPAS calculations shift to 0 lbs remaining, and the TO 2000 LB legend changes to TO 0 LB.

2.3.1.5 FPAS Default Area. If outside air temperature, stores drag, or fuel flow become invalid, the TEMP, DRAG, or FF advisories are displayed next to the DEFAULT legend. These parameters, if invalid, do not have a fatal impact on FPAS calculations.

2.3.2 FPAS CLIMB Option. The CLIMB option is available for selection in the NAV master mode. Pressing the CLIMB option on the FPAS display enables the climb airspeed prompt, displayed above the airspeed box in the HUD (HUD reject switch in the NORM position). When selected, CLIMB is boxed and the climb airspeed prompt indicates the desired calibrated airspeed for an optimum climb profile.

2.3.3 FPAS HOME Waypoint Selection. The HOME option arrows are used to increment/decrement the home waypoint for use in FPAS fuel-on-deck (HOME FUEL caution) calculations. The selected home waypoint is displayed above the HOME legend on the FPAS display. The home waypoint defaults to 0 at power up and must be changed if another waypoint is desired (0 to 59). Decrementing the home waypoint from 0 selects 59. If invalid parameters prevent FPAS from calculating the HOME FUEL caution, the FPAS DDI advisory is displayed, the home waypoint is X'd, and the option arrows are removed.

2.3.4 FPAS HOME FUEL Caution. When FPAS calculated fuel remaining at the selected home waypoint reaches 2,000 lbs, the HOME FUEL caution is displayed. HOME FUEL caution logic is disabled with WonW, the refueling probe extended, the landing gear cycled down then up, or within 5 seconds after a home waypoint change.

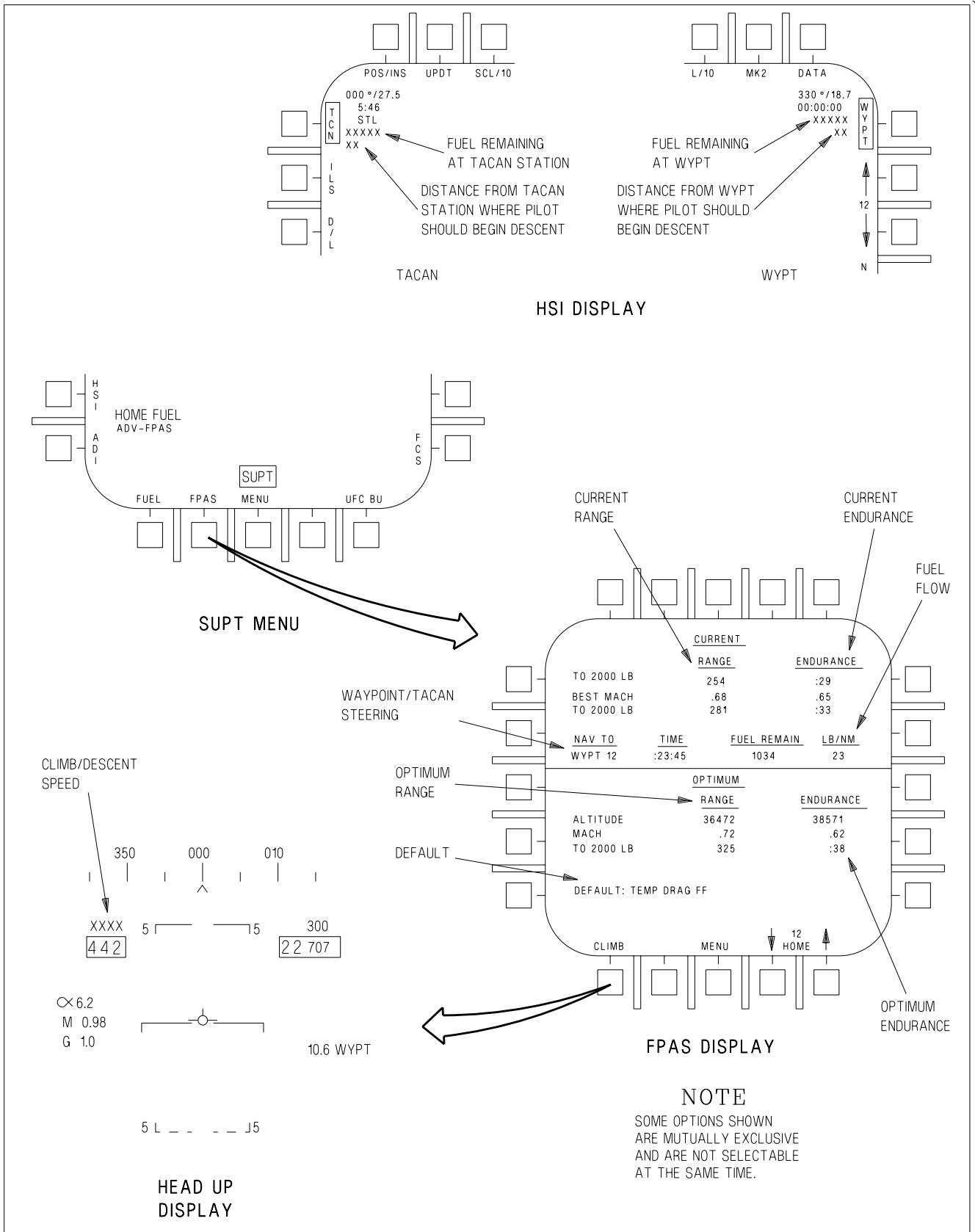
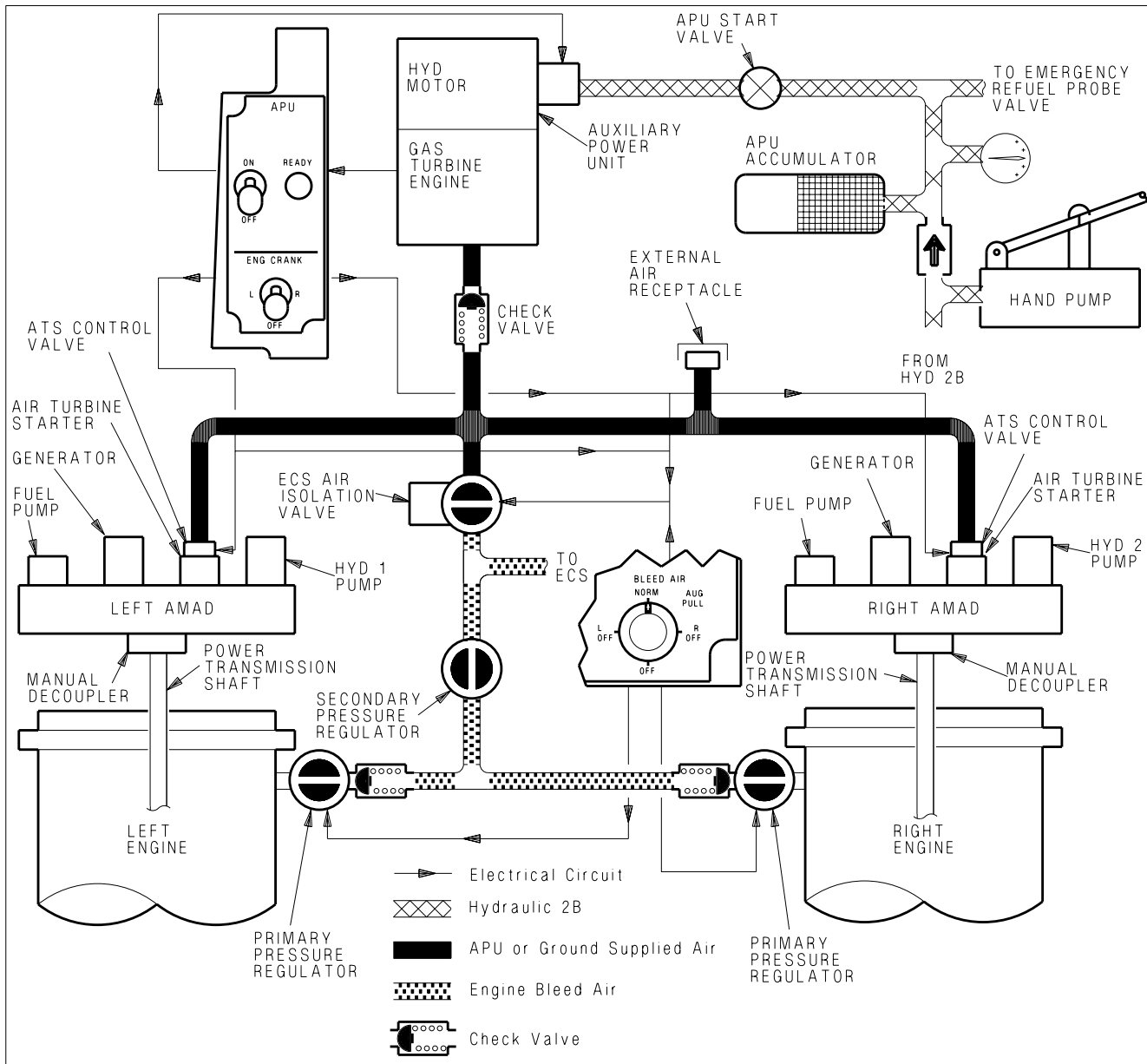

Figure 2-8. FPAS Displays

EFN520-49-1-001



EFN520-48-1-007

Figure 2-9. Secondary Power Supply

2.4 SECONDARY POWER SYSTEM

The aircraft secondary power system contains two airframe mounted accessory drives (AMAD) and a single auxiliary power unit (APU). Figure 2-9 shows the major components of the secondary power system.

2.4.1 AMAD - Airframe Mounted Accessory Drive. During normal operation, each AMAD is mechanically driven by its corresponding engine through a power transmission shaft and is used to drive a fuel boost/motive flow pump, an ac/dc electrical generator, and a 3000/5000 psi hydraulic pump. Pneumatic pressure is used to rotate an air turbine starter (ATS) on each AMAD for engine crank/start capability.

For ground maintenance use, either AMAD can be decoupled from its engine, allowing pneumatic pressure to drive the AMAD and its accessories.

NOTE

Failure of the power transmission shaft (PTS) results in the display of the associated GEN, BOOST LO, and both HYD circuit cautions.

2.4.2 APU - Auxiliary Power Unit. The APU is a small gas turbine engine used to generate a source of air to power the ATS for normal engine start or to provide an alternate air source for the environmental control system (ECS). The APU is located between the engines, with intake and exhaust facing downwards.

The aircraft battery provides electrical power for APU ignition and start. A hydraulic motor powered by the APU accumulator is used to start the APU. The APU receives fuel from the left engine feed line upstream of the left engine feed shutoff valve. During normal operation, the APU shaft turns a separate compressor which supplies air for main engine start or alternate ECS operation.

If an APU fire or overheat condition is detected on the ground, the APU fire extinguishing system automatically shuts the APU down and, after 10 seconds, discharges the extinguisher bottle.

2.4.3 APU Switch. The APU switch, located on the left console, is spring loaded to the OFF position and is electrically held in the ON position.

- | | |
|-----|---|
| ON | Automatic start and normal APU operation. The switch returns to OFF 1 minute after the second aircraft generator comes online (BLEED AIR knob not in AUG PULL). |
| OFF | Manual APU shutdown |



To prevent an APU running engagement and to prevent APU exhaust torching, a minimum of 2 minutes must elapse between APU shutdown and another APU start.

2.4.3.1 APU READY Light. The APU READY light, located on the left console adjacent to the APU switch, comes on when the APU has completed the start cycle and is capable of supporting engine crank.

2.4.4 ATS Air Sources. Pneumatic pressure from one of three sources can be used to power the ATS for engine crank/start: APU compressor air, opposite engine bleed air (crossbleed), or external air.

The APU compressor is the primary engine crank air source. With the APU online, the ECS air isolation valve is closed and the ENG CRANK switch opens the desired air turbine starter control valve (ATSCV), allowing APU compressor output to turn the ATS, AMAD, and engine core.

A crossbleed start can be utilized when one engine is operating and the APU is shutdown. The operating engine should be set to a minimum of 80 % N₂ rpm to make sure bleed air output is sufficient to crank the opposite engine. For a crossbleed start, the ENG CRANK switch opens the ECS air isolation valve and the ATSCV, allowing compressor bleed air pressure to turn the ATS, AMAD, and engine core. If one engine fails inflight and the engine core is rotating freely, crossbleed air may be used

to rotate the AMAD and retain some fuel, electrical, and hydraulic system output.



ATS exhaust may blister paint and cause possible door damage on the aft underside of the fuselage during extended crossbleed operation of a failed engine.

An external air source may also be used to start one or both engines. External air is applied to the aircraft through a connection in the right main wheelwell. Both engine bleed air valves must be closed (BLEED AIR knob OFF) to make sure that external air is the sole air source for engine start. For an external air start, the ENG CRANK switch opens the ATSCV, allowing external air pressure to turn the ATS, AMAD, and engine core.

2.4.4.1 ATS Protection. Each ATS has two sources of overspeed cutout protection. The primary source is the corresponding generator, and the backup source is the frequency sensing relay (FSR). The FSR monitors ATS speed and provides the signal which electrically holds the ENG CRANK switch. When the generator comes on the line at 60 % N₂ rpm, it removes power from the ATSCV and the FSR, which releases the ENG CRANK switch. If the primary cutout does not function (GEN switch OFF or major generator malfunction), the FSR releases the ENG CRANK switch when it senses 63 % N₂ rpm.



Regardless of the engine start air source utilized, the corresponding GEN switch should be ON, as the generator provides primary overspeed cutout protection for the ATS.

2.4.4.2 ENG CRANK Switch. The ENG CRANK switch, located on the left console, is spring loaded to the OFF position and is electrically held in the L or R position.

- L Opens the left ATSCV and/or the ECS air isolation valve to direct pneumatic pressure to the ATS for left engine crank.
- OFF Closes both ATSCVs and the ECS air isolation valve. When the left or right generator comes online following engine start, the switch automatically returns from L or R to the OFF position.
- R Opens the right ATSCV and/or the ECS air isolation valve to direct pneumatic pressure to the ATS for right engine crank.

2.4.5 AUG PULL. During extended ground operations, APU compressor air may be used instead of engine bleed air to run the ECS and cool the avionics (BLEED AIR knob in AUG PULL). AUG PULL operation is discussed in the ECS section.

2.4.6 AMAD Related Cautions. The following AMAD related cautions are described in the Warning/Caution/Advisory Displays in Part V:

- L or R OIL HOT
- L or R AMAD PR
- L or R ATS

2.5 ELECTRICAL POWER SUPPLY SYSTEM

The electrical power supply system consists of two generators, two transformer-rectifiers (TR), one battery with dedicated battery charger, and a power distribution (bus) system (figure 2-10). Each generator provides a primary ac source and three isolated dc sources from a permanent magnet generator (PMG). During normal operation, the left generator powers only the left buses while the right generator powers only the right buses. If one generator fails, the other generator is capable of carrying the entire electrical load of the aircraft. Battery power is provided for normal engine start. External electrical power can be applied to power the entire system on the ground. The bus system consists of the left and right 115 vac buses, right 26 vac bus, left and right 28 vdc buses, 28 vdc essential bus and a 28 vdc maintenance bus. See figure 2-10 for a simplified schematic and Electrical System, foldout section, for the specific systems powered by each bus.

2.5.1 Electrical RESET Button. The electrical system RESET button is located on the electrical power panel on the right console. This button provides master reset capability for any failed generator or electrical system relay without interrupting operational circuits.

2.5.2 AC Electrical Power. The two generators are the primary source of ac electrical power. With the GEN switch in NORM, each generator comes online at approximately 60 % N_2 rpm as long as voltage and frequency are within limits. Each generator supplies ac power to an independent 115 vac bus. In addition, the right 115 vac bus powers a 26 vac bus through a dedicated transformer.

2.5.2.1 GEN Switches. Two generator control switches, labeled L GEN and R GEN, are located on the electrical power panel on the right console.

NORM	Provides normal generator operation.
OFF	Removes the generator ac source from the bus system.

2.5.2.2 Electrical Fault Protection Circuitry. The electrical system provides fault protection with generator isolation, bus tie, generator automatic reset, and ac bus isolation circuitry.

If a generator fault occurs, generator isolation circuitry removes the affected generator from its buses (L or R GEN caution and caution light). All generator faults except N_2 underspeed require manual generator reset (GEN switch cycled to OFF then NORM or RESET button pressed). Generator reset is successful only if the out-of-tolerance or fault condition has cleared. If the generator fault remains, bus tie circuitry allows the remaining generator to power all electrical buses. During an N_2 underspeed condition, the affected generator is automatically restored when rpm returns to normal range.

If a short or overload condition (bus or equipment fault) occurs on a bus (the R 115 vac bus, for instance), the following sequence is initiated. The right generator attempts to power through the short and, if unsuccessful, trips offline. The left generator is then connected to the right buses by the bus tie circuitry, attempts to power through the short, and, if unsuccessful, also trips offline. Approximately 1 second after the dual generator outage, the generator automatic reset logic resets both generators. If the bus or equipment fault has cleared, both generators remain online to power their respective buses. If the bus or equipment fault remains, the right generator trips offline again, but bus isolation circuitry now prevents the left generator from picking up the right buses (GEN TIE caution light). The left generator remains online to power the left buses and the R 28 vdc bus. The R 115 vac bus, R 26 vac bus, and battery charger are unpowered, and the battery runs the maintenance bus. This entire process may take as long as 16 seconds.

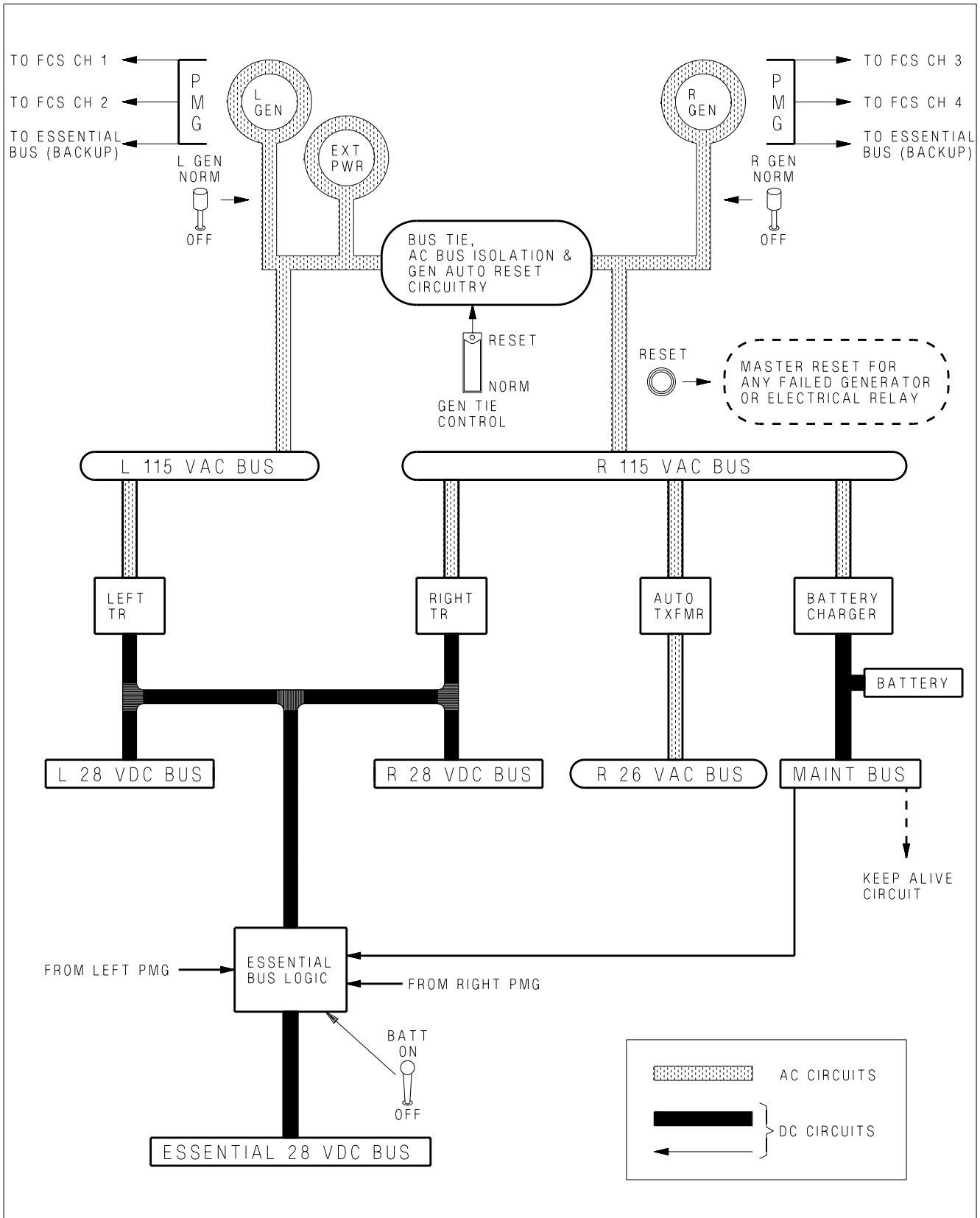

EFN520-335-1-007

Figure 2-10. Simplified Electrical Schematic

For the ac bus isolation and generator automatic reset circuits to operate, the GEN TIE switch must be in NORM, the BATT switch must be ON and the PARK BRAKE handle must not be set. With the PARK BRAKE handle set, the generators do not reset following a dual outage.

2.5.2.3 GEN TIE Caution Light. During initial engine start (battery or external power) GEN TIE circuitry requires a set PARK BRAKE handle to properly function. If the PARK BRAKE handle is not set during right (first) engine start, a GEN TIE caution light comes on when the right generator comes online. For a battery start, setting the PARK BRAKE handle and cycling the R GEN switch reties the left and right buses and clears any avionics faults that would otherwise occur. For an external power start, setting the PARK BRAKE handle, disconnecting external power, and cycling the GEN TIE switch reties the left and right buses.

2.5.2.4 GEN TIE Switch. The red-guarded GEN TIE switch is located on the left console outboard of the exterior lights panel.

- | | |
|-------|--|
| RESET | Resets the bus tie circuitry. Reset is accomplished by cycling the switch to RESET then NORM. |
| NORM | With the BATT switch ON, enables the bus tie, ac bus isolation and generator automatic reset circuits. |



If the left and right buses are isolated because of a detected fault (e.g., R GEN caution and GEN TIE caution light), cycling the GEN TIE switch reenergizes the faulty bus/equipment and may cause further damage or loss of the remaining generator.

2.5.3 DC Electrical Power. DC electrical power is provided by two TRs, three dc outputs from each PMG, the battery, and the battery charger.

2.5.3.1 TR - Transformer-rectifiers. While each TR is powered by its respective 115 vac bus, the output of each TR is connected in parallel, powering both the left and right 28 vdc buses and providing primary power for the essential bus. If one TR fails, the other powers the entire dc system. There is no cockpit warning of a single TR failure (no caution and no MSP code). TR operation is checked on maintenance phase inspections.

2.5.3.2 PMG - Permanent Magnet Generator. The PMG in each generator provides three dc sources, two for FCC channels and one for essential bus backup. The left PMG provides the primary power source for FCC A (channels 1 and 2), while the right PMG provides the primary power source for FCC B (channels 3 and 4). Regardless of generator control switch position, the PMGs come online when the engine reaches approximately 50 % N₂ rpm on spool up and remain on until 20 % N₂ rpm on spool down.

2.5.3.3 Battery. The primary operational use of the battery is engine start. The battery powers the maintenance bus directly, allowing operation of the canopy, ladder, and maintenance monitor in the absence of ac electrical power. With the BATT switch ON (first engine start), the battery also powers the essential bus. In the unlikely event of a total ac/dc failure inflight, the battery provides the last level of essential bus backup capability, providing about 5 to 10 minutes of power for the FCCs, after which aircraft control is lost.

Regardless of BATT switch position, the battery charger supplies charging power to the battery anytime the right 115 vac bus is energized.

2.5.3.4 FCC Electrical Redundancy. FCC electrical redundancy is provided by several sources of dc power (figure 2-11). The primary dc source for each FCC channel is its respective PMG output. If a PMG output should fail, that FCC channel is powered by the essential bus, which also has several sources of redundancy (the TRs, the PMGs, and the battery). The BATT switch must be ON for either a PMG or the battery to power the essential bus. Additionally, “keep alive” circuits connected directly to the maintenance bus provide each FCC channel with an uninterrupted backup power source during normal bus power transients.

2.5.3.5 BATT Switch. The BATT switch is located on the electrical power panel on the right console.

ON	Allows the battery or either PMG to power the essential bus when TR power is not available.
OFF	Prevents the battery or either PMG from powering the essential bus when TR power is not available.

2.5.3.6 Automatic Battery Cutoff. The automatic battery cutoff circuit is provided to conserve battery power. On the ground with the BATT switch ON, the circuit disconnects the battery from the essential bus and returns the BATT switch to OFF 2 minutes after ac power is removed from the aircraft. When battery cutoff is activated, the battery can be reconnected to the essential bus by reselecting the BATT switch ON. The automatic battery cutoff circuit is disabled when the APU comes online.

2.5.3.7 Battery Gauge. A battery gauge is installed on the electrical power panel on the forward right console in the front cockpit only. Depending on generator status, the battery gauge provides an indication of either essential bus voltage (both GENs offline) or maintenance bus voltage (either GEN online).

With both GENs offline and the BATT switch ON (e.g., prior to first engine start), the battery gauge is connected to the essential bus and indicates battery voltage. Nominal voltage for a “good” battery should be 23 to 24 vdc. Minimum battery voltage is that which provides a successful engine start (e.g., APU remains online and the EFD remains powered to provide indications of RPM and TEMP). EFD blanking and/or uncommanded APU shutdown should be anticipated with battery voltage at or below 18 vdc.

With at least one GEN online, the battery gauge is connected to the maintenance bus and indicates 28 vdc output of the battery charger. If the battery gauge fails to jump to approximately 28 vdc with one GEN online, a battery charger malfunction has occurred which requires maintenance action prior to flight.

If a dual GEN failure occurs, the battery gauge is reconnected to the essential bus and must be referenced to determine the essential bus power source. If the battery gauge remains at approximately 28 vdc, an EBB PMG is powering the essential bus, and FCC operating time is not limited. However, if the battery gauge indicates 24 vdc or below, the battery is powering the essential bus, and FCC operating time is limited to about 5 to 10 minutes. The FCCs should continue to operate down to a battery gauge voltage of approximately 18 vdc.

2.5.3.8 BATT SW Caution and Caution Light. The BATT SW caution and caution light are only set to alert the aircrew of an improperly placed BATT switch. The battery gauge must be referenced to

determine whether an EBB PMG or the battery is powering the essential bus following a dual GEN failure. These cautions are set in only two circumstances.

1. The BATT switch is ON on the ground in the absence of ac power (e.g., first engine start). The battery is depleting and the switch should be placed to OFF unless APU start is about to be made.
2. The BATT switch is OFF inflight and should be placed to ON to provide essential bus backup capability from the PMGs and the battery.

2.5.4 External Electrical Power. External electrical power may be connected to the aircraft bus system through an external power receptacle located on the left forward fuselage. If external power is not of the proper quality, the external power monitor prevents application of power to the aircraft. Actuation of 1 to 4 ground power switches is required to energize certain aircraft systems following application of external power.

The aircraft buses are energized by external power in the same manner as if a generator were operating provided the BATT switch is OFF or the PARKING BRAKE is set.

2.5.4.1 External Power Switch. The external power switch, located on the ground power panel on the left console, is spring loaded to the NORM position (figure 2-12).

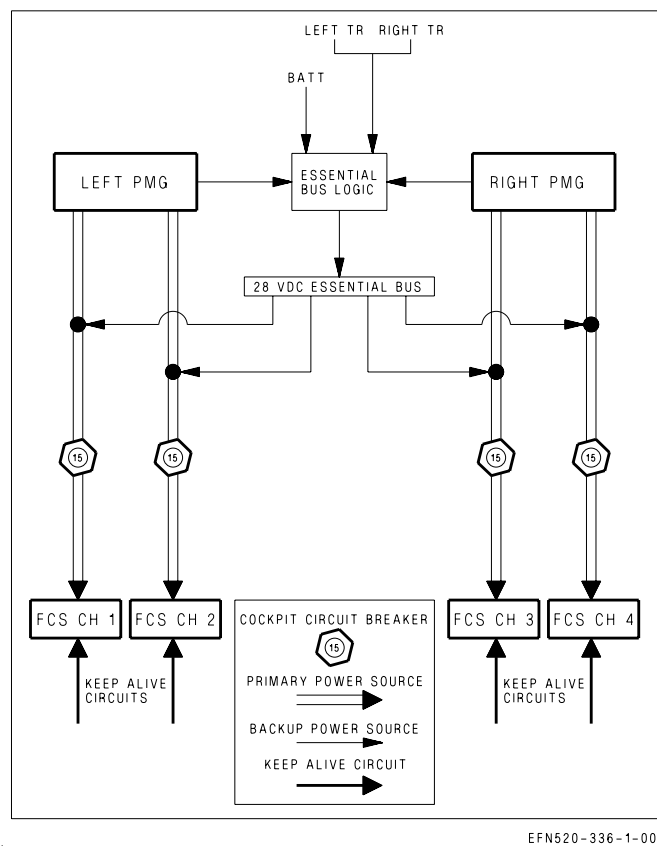
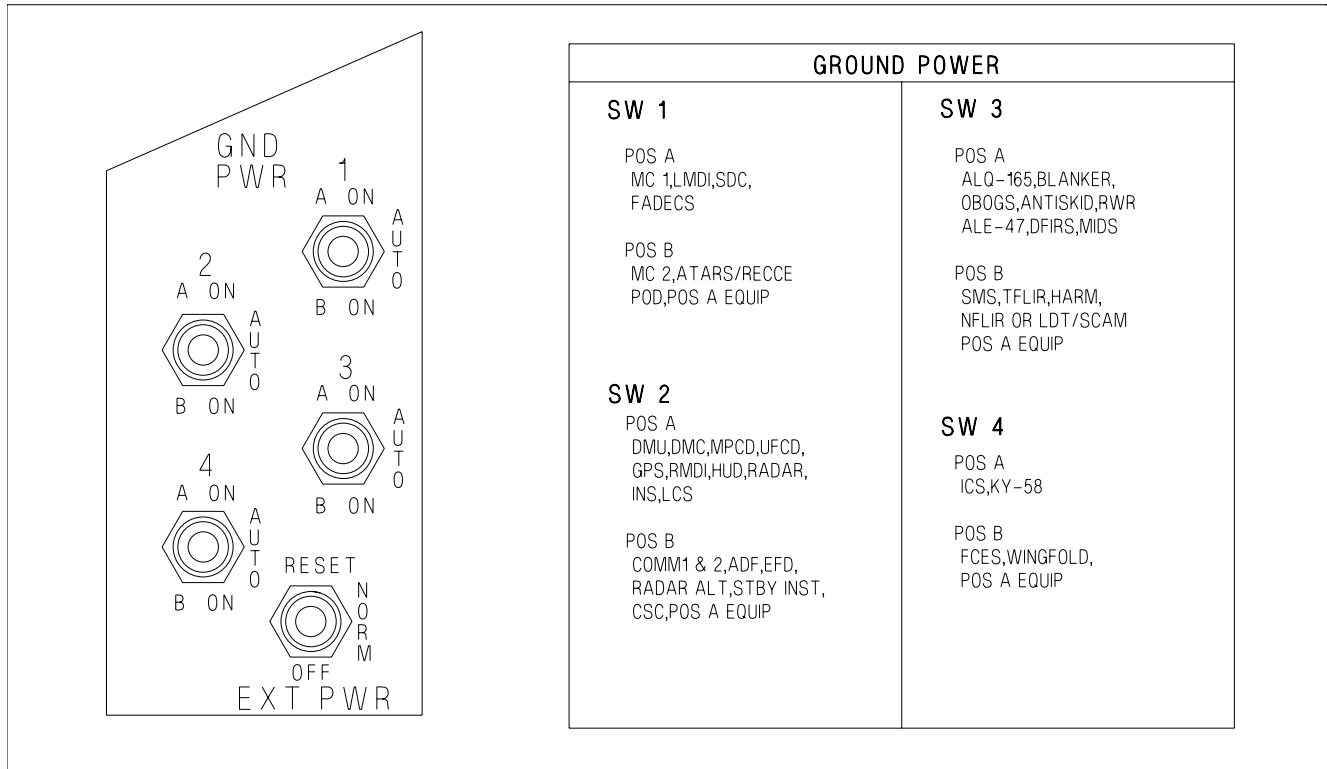

Figure 2-11. FCC Electrical Redundancy



EFN520-21-1-005

Figure 2-12. Ground Power Panel and Placard

- RESET** Momentary actuation allows external power to be applied.
- NORM** Aircraft buses are energized by external power, provided the switch was first positioned to RESET. The switch returns to OFF when external power is disconnected.
- OFF** Disconnects external power from the aircraft.

2.5.4.2 Ground Power Switches. The four ground power switches are located on the ground power panel on the left console (figure 2-12). Each switch controls a group of systems and/or instruments, as listed on a placard above the panel.

- A ON** Only systems/instruments listed for the A position are energized by external power.
- AUTO** All controlled systems/instruments are deenergized with external power on the aircraft. When a generator comes online, the switch(es) automatically revert to AUTO.
- B ON** All controlled systems/instruments (both A and B) are energized by external power.

The first ground power switch placed to ON must be held for 3 seconds to complete an avionics overheat BIT. If an avionics overheat condition is present, the switch(es) revert to AUTO and cannot be returned to ON until the condition is corrected.

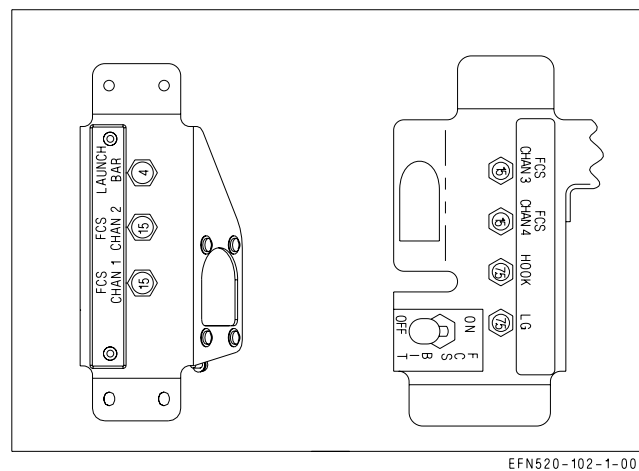

Figure 2-13. Circuit Breaker Panels

2.5.5 Circuit Breakers. The circuit breaker panels (figure 2-13), located under each side of the canopy sill outboard of the left and right consoles, contain the following circuit breakers:

Left Side

LAUNCH BAR
FCS CHAN 2
FCS CHAN 1

Right Side

FCS CHAN 3
FCS CHAN 4
HOOK
LG

2.5.6 Electrical System Cautions and Caution Lights. The following electrical system cautions and caution lights are described in the Warning/Caution/Advisory Displays in Part V:

- L or R GEN caution and caution light
- GEN TIE caution light
- BATT SW caution and caution light
- L or R DC FAIL caution

2.6 LIGHTING

2.6.1 Exterior Lighting. Exterior lighting is utilized to highlight aircraft position and aspect to other aircraft, to provide AOA indications to a landing signal officer (LSO), to light the aircraft path for in-flight refueling, landing or taxi, and to distinguish the F/A-18E/F from other F/A-18 models. The following exterior lights are provided: strobe lights, position lights, formation lights, approach lights, refueling probe light, and landing/taxi light (figure 2-14).

Strobe lights and formation lights have two operating modes, normal and NVIS.

2.6.1.1 Exterior Lights Master Switch. The exterior lights master switch, located on the outboard side of the left throttle grip, provides master control of all exterior lighting except the approach and landing/taxi lights.

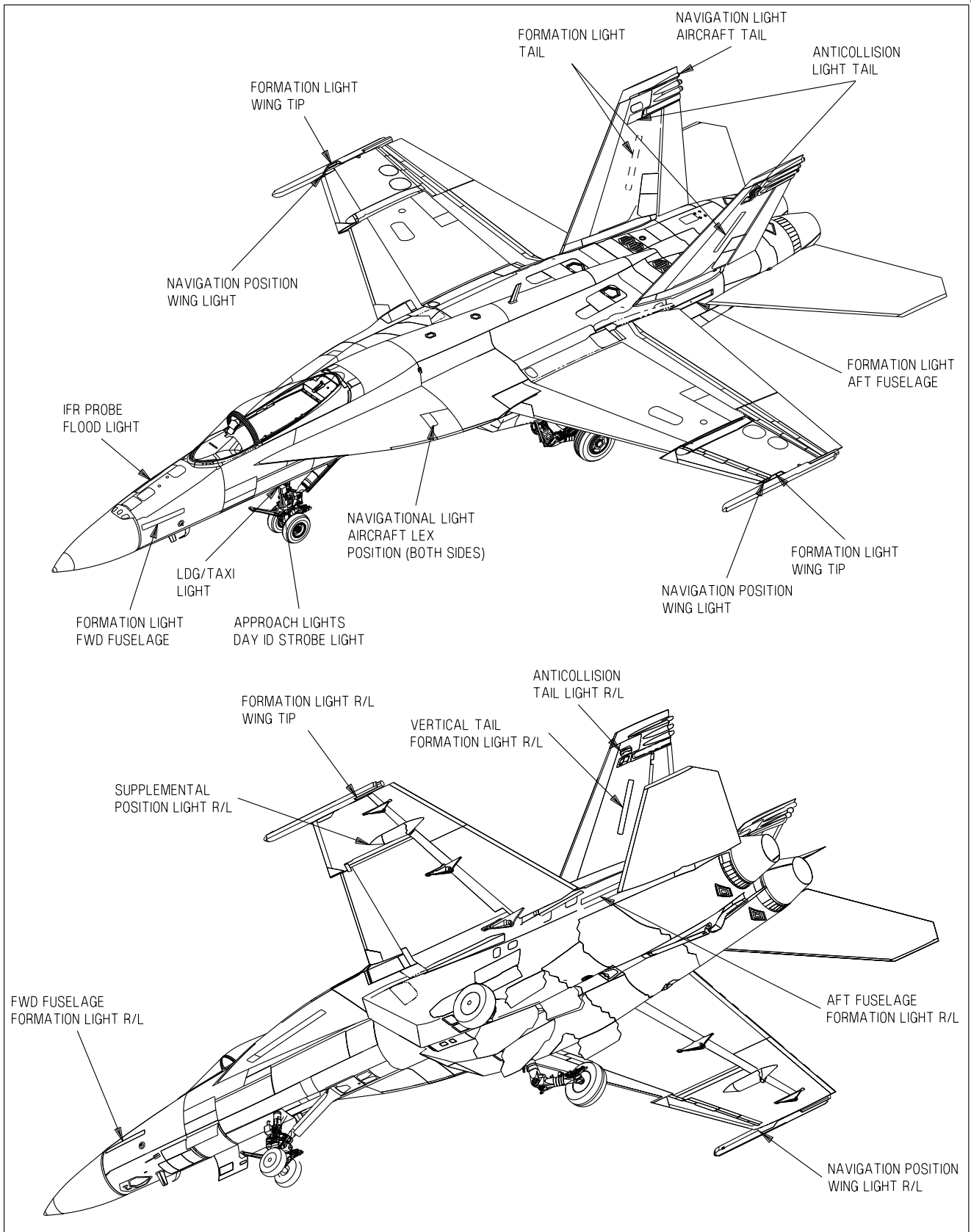

EFN520-333-1-015

Figure 2-14. Exterior Lights

NORM (Forward)	Power is available for controlled lighting (strobe and formation lights in normal mode)
NVIS (Center)	Power is available only to the strobe and formation lights in NVIS mode
OFF (Aft)	Power is removed from all controlled lighting. Required position for Day ID light strobe power ON.

2.6.1.2 Pattern Strobe Lights. Two red anti-collision strobe lights, one on each outboard vertical tail, are provided to highlight aircraft position during both day and night operations. Each strobe light contains two bulbs, one normal and one infrared (IR). The external lights master switch determines which pair of bulbs are powered by the STROBE switch.

2.6.1.2.1 STROBE Switch. The STROBE switch, located on the EXT LT panel on the left console, is used to apply power and control the brightness of the strobe lights.

BRT	Strobe lights on at full intensity (normal or NVIS mode)
OFF	Strobe lights off
DIM	Strobe lights on at reduced intensity (normal or NVIS mode)

2.6.1.2.2 IDENT Knob. Pattern selection is controlled by the IDENT knob on the exterior lights panel. The IDENT knob can be set to select strobe patterns of NORM, or A thru F. For night carrier landings the IDENT knob should be in the NORM position. Refer to figure 2-15 for possible strobe patterns. Possible strobe patterns are as follows:

NORM	Strobe light flashes three times, pauses for 2.44 seconds, then repeats pattern
A	Strobe light flashes two times, pauses 1.92 seconds, then repeats pattern
B	Strobe light flashes once, pauses 0.64 seconds, flashes two times, pauses 2.56 seconds, then repeats pattern
C	Strobe light flashes two times, pauses 0.64 seconds, flashes once, pauses 2.56 seconds, then repeats pattern
D	Strobe light flashes three times, pauses 2.88 seconds, flashes once, pauses 0.64 seconds, then repeats pattern
E	Strobe light flashes three times, pauses 0.64 seconds, flashes two times, pauses 3.2 seconds, then repeats pattern
F	Strobe light flashes two times, pauses 0.64 seconds, flashes two times, pauses 2.88 seconds, then repeats pattern

2.6.1.3 Position Lights. The position lights are provided to highlight the aircraft aspect during night or reduced visibility operation. There are seven position lights, three red, three green, and one white. The white position light is on the tail. Three red position lights are installed on the left side. One on

the wingtip, one on the LEX just forward of the wing root and one under the wing at the aileron hinge. Green position lights are installed at the same locations on the right side.

2.6.1.3.1 POSITION Lights Knob. The POSITION lights knob, located on the EXT LT panel on the left console, is used to apply power and control the brightness of the position lights (external lights master switch NORM). The knob provides variable lighting intensity between the OFF and BRT positions.

2.6.1.4 Formation Lights. Ten formation "strip" lights, five on each side of the aircraft, are provided to highlight the aircraft aspect during night or low visibility formation flight. Strip lights are located on the forward fuselage forward of the LEX, on the wingtip above the missile rail, on the wingtip below the missile rail, on the aft fuselage below the vertical tail, and on the vertical tail. Each formation light contains two lighting strips, one normal and one IR. The external lights master switch determines which set of strips are powered by the FORMATION lights knob.

2.6.1.4.1 FORMATION Lights Knob. The FORMATION lights knob, located on the EXT LT panel on the left console, is used to apply power and control the brightness of the formation strip lights. The knob provides variable lighting intensity between the OFF and BRT positions in either the normal or NVIS mode.

2.6.1.5 Approach Lights. The approach lights, located on the nose gear strut, provide AOA indications to an LSO during carrier landings. Three approach lights are provided to indicate a fast (red), on-speed (amber), or slow (green) AOA condition. The approach lights are powered with WoffW and all landing gear down and locked. Therefore, the approach lights are an external indication that the

ID STROBE PATTERNS

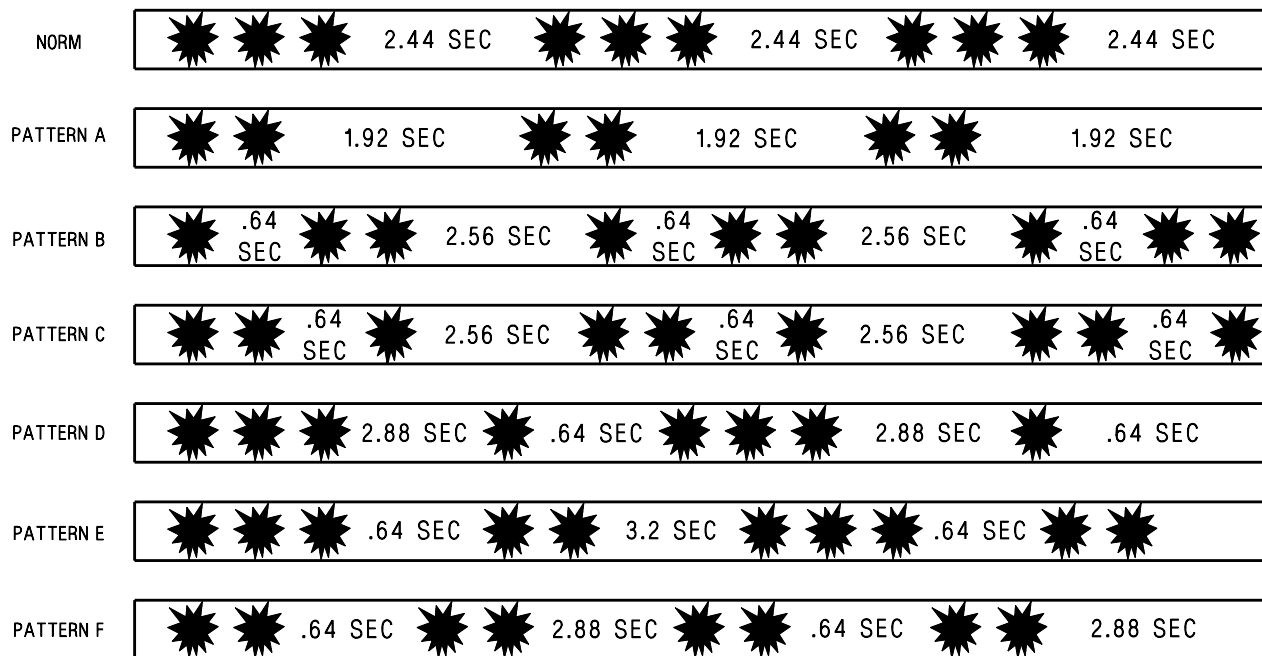

EFN520-367-1-004

Figure 2-15. ID Strobe Patterns

landing gear are down and locked. The approach lights flash when the HOOK BYPASS switch is in the CARRIER position and the arresting hook is not down, indicating to an LSO that the hook must be lowered for a carrier arrestment. The approach lights are dimmed by the WARN/CAUT lights knob.

2.6.1.6 HOOK BYPASS Switch. The HOOK BYPASS switch, located on the lower left main instrument panel, is spring loaded to the CARRIER position and is electrically held in the FIELD position.

FIELD Approach lights and AOA indexers do not flash regardless of hook position. The switch reverts to the CARRIER position if the hook is lowered.

CARRIER Approach lights and AOA indexers flash if the hook is not down

2.6.1.7 Landing/Taxi Light. A landing/taxi light, located on the nose gear strut, is used to light the flightpath during landing or a taxiway/runway during ground operations.

2.6.1.7.1 LDG/TAXI Light Switch. The LDG/TAXI light switch is located on the lower left main instrument panel.

ON Landing/taxi light on with the LDG GEAR handle DN **and** the nose gear down and locked

OFF Landing/taxi light off

2.6.1.8 Day ID Light. A high intensity white strobe light is mounted below the approach light on the nose gear strut. The strobe light operates with the landing gear down and locked, WoffW, and the exterior lights master switch in the OFF (aft) position.

2.6.1.8.1 Day ID Test Switch. A day ID test switch, located in the nose wheel on frame 233, is provided to test the day ID strobe light. The switch operates only with ac power applied to the aircraft.

TEST The day ID strobe light comes on, ID LT is displayed on the LDDI, and the master caution light and aural tone come on.

OFF The switch is spring loaded to the OFF position.

2.6.2 Interior Lighting. Interior lighting is utilized to provide adjustable cockpit lighting for the main instrument panel and consoles during night or low light operations. All controls for interior lighting are located on the INTR LT panel on the right console, except for the utility flood light, the AOA indexers, and the five cockpit displays.

2.6.2.1 MODE Switch. The MODE switch, located on the INTR LT panel, is used to select one of three cockpit lighting modes; allowing the pilot to optimize interior lighting for current ambient light conditions.

NVG	Reduces the brightness range for the warning, caution, and advisory lights, the UFCD, MPCD, EFD, (LOT 25 AND UP) AMPD, and (LOT 26 AND UP) 8 x 10 display. This disables the integral console lights and the white floodlights; and enables six NVG compatible floodlights to illuminate the consoles.
NITE	Reduces the brightness range for the warning, caution, and advisory lights, the UFCD, MPCD, EFD, (LOT 25 AND UP) AMPD, and (LOT 26 AND UP) 8 x 10 display.
DAY	Provides the maximum brightness range for all interior lighting.

The UFCDs, MPCD, EFD, (LOT 25 AND UP) AMPD, and (LOT 26 AND UP) 8 x 10 display reset to DAY mode brightness after aircraft shutdown. Following electrical power interruption, these displays reset to DAY mode brightness with the mode switch in DAY or NITE positions, and to NITE mode brightness with the mode switch in NVG position.

2.6.2.2 CONSOLES Lighting Knob. The CONSOLES lighting knob, located on the INTR LT panel, is used to control the brightness of the integral lighting for the left and right consoles, the hydraulic pressure gauge, and both circuit breaker panels. Clockwise rotation of the knob increases console lighting intensity from the OFF to BRT positions. The CONSOLES knob and integral console lighting are disabled in the NVG mode.

2.6.2.3 INST PNL Lighting Knob. The INST PNL lighting knob, located on the INTR LT panel, is used to control the brightness of the integral lighting for the main instrument panel and the standby magnetic compass. Clockwise rotation of the knob increases main instrument panel lighting intensity from the OFF to BRT positions. The strobe function of the SHOOT light is disabled when the instrument lights are on.

2.6.2.4 FLOOD Lights Knob. The FLOOD knob, located on the INTR LT panel, is used to control the brightness of the white cockpit floodlights. Eight floodlights are provided for secondary lighting; three above each console and one on either side of the main instrument panel. Clockwise rotation of the knob increases floodlight intensity from the OFF to BRT positions. The FLOOD knob and all white floodlights are disabled in the NVG mode. There is no brightness control for the six NVG floodlights.

2.6.2.5 CHART Light Knob. The CHART light knob, located on the INTR LT panel, is used to control the brightness of the NVG compatible chart light. The chart light is located on the canopy bow at the 10:30 position and rotates in two axes. Clockwise rotation of the knob increases chart light intensity from the OFF to BRT positions.

2.6.2.6 Utility Floodlight. The utility floodlight, normally stowed above the right console, provides a portable source of secondary lighting. An attached alligator clip allows the light to be fastened at various locations in the cockpit. The light contains a knob which provides variable lighting intensity from off to bright and a button which, when pressed, illuminates the light at full intensity. The light also contains a rotary selector for white or NVG compatible green lighting.

2.6.2.7 Emergency Instrument Lights. The emergency instrument lights, located on the left and right sides of the main instrument panel, illuminate the EFD and standby flight instruments in the absence of ac electrical power. The lights come on anytime the PMGs or the battery are powering the essential bus. There is no separate cockpit control for the emergency instrument lights.

2.6.2.8 Engine Instrument Light. The engine instrument light, located on the left side of the main instrument panel, provides lighting for the EFD during battery start of the first engine. The light comes on when the APU switch is placed to ON.

2.6.2.9 WARN/CAUT Lights Knob. The WARN/CAUT knob, located on the INTR LT panel, is used to control the brightness of the warning, caution, and advisory lights in the reduced brightness range. Clockwise rotation of the knob increases warning, caution, and advisory light intensity from the OFF to BRT positions. The brightness is maximum in the DAY mode and in the reduced brightness range in the NITE and NVG modes.

Following a power interruption in either the DAY or NITE mode, the warning, caution, and advisory lights default to the maximum brightness range. Following a power interruption in the NVG mode, the warning, caution, and advisory lights remain in the reduced brightness range.

2.6.2.10 LT TEST Switch. The LT TEST switch, located on the INTR LT panel, is spring loaded to the OFF position. The switch is used to test important cockpit lighting to verify bulb integrity prior to flight. The switch requires ac electrical power to operate.

TEST Powers all operating warning, caution, and advisory lights, the AOA indexer lights, the integral background lighting on the EFD (BINGO, MODE, and BRT), changes MENU to ENG on the DDIs, provides a CHECK SEAT caution in the F/A-18E, and annunciates the landing gear warning tone.

OFF Lights test off

2.6.3 Interior Lighting (F/A-18F). All controls for the interior lights of the rear cockpit are located on the INTR LT panel on the right console. The controls operate in the same manner as those in the front cockpit with two exceptions. There is no MODE switch on the rear cockpit INTR LT panel, and the rear cockpit LT TEST switch does not illuminate the AOA indexer lights or annunciates the landing gear warning tone.

2.7 HYDRAULIC POWER SUPPLY SYSTEM

The hydraulic power supply system is a dual pressure system (3,000 and 5,000 psi). The aircraft uses hydraulic power to actuate primary flight control surfaces and to run the following utility hydraulic functions: landing gear, wheel brakes and anti-skid, hook, launch bar, refueling probe, nosewheel steering (NWS), gun, and parking brake. Two hydraulic accumulators provide emergency hydraulic power for critical utility functions.

2.7.1 Hydraulic System. The hydraulic power supply system incorporates two independent hydraulic systems, HYD 1 and HYD 2 (figure 2-16). Each system is divided into two branches providing four independent hydraulic circuits identified as 1A and 1B for the left system and 2A and 2B for the right system. HYD 1 circuits are dedicated solely to flight controls. HYD 2A powers both flight controls and most utility hydraulic functions. HYD 2B powers the flight controls and arresting hook and pressurizes both the APU and emergency brake accumulators.

All flight control surface actuators are powered by one HYD 1 circuit and one HYD 2 circuit, either simultaneously or through hydraulic switching valves.

The utility system operates at 3,000 psi only. Two pressure reducers, one on HYD 2A and one on HYD 2B reduce utility circuit pressure to 3,000 psi when pump output is 5,000 psi.

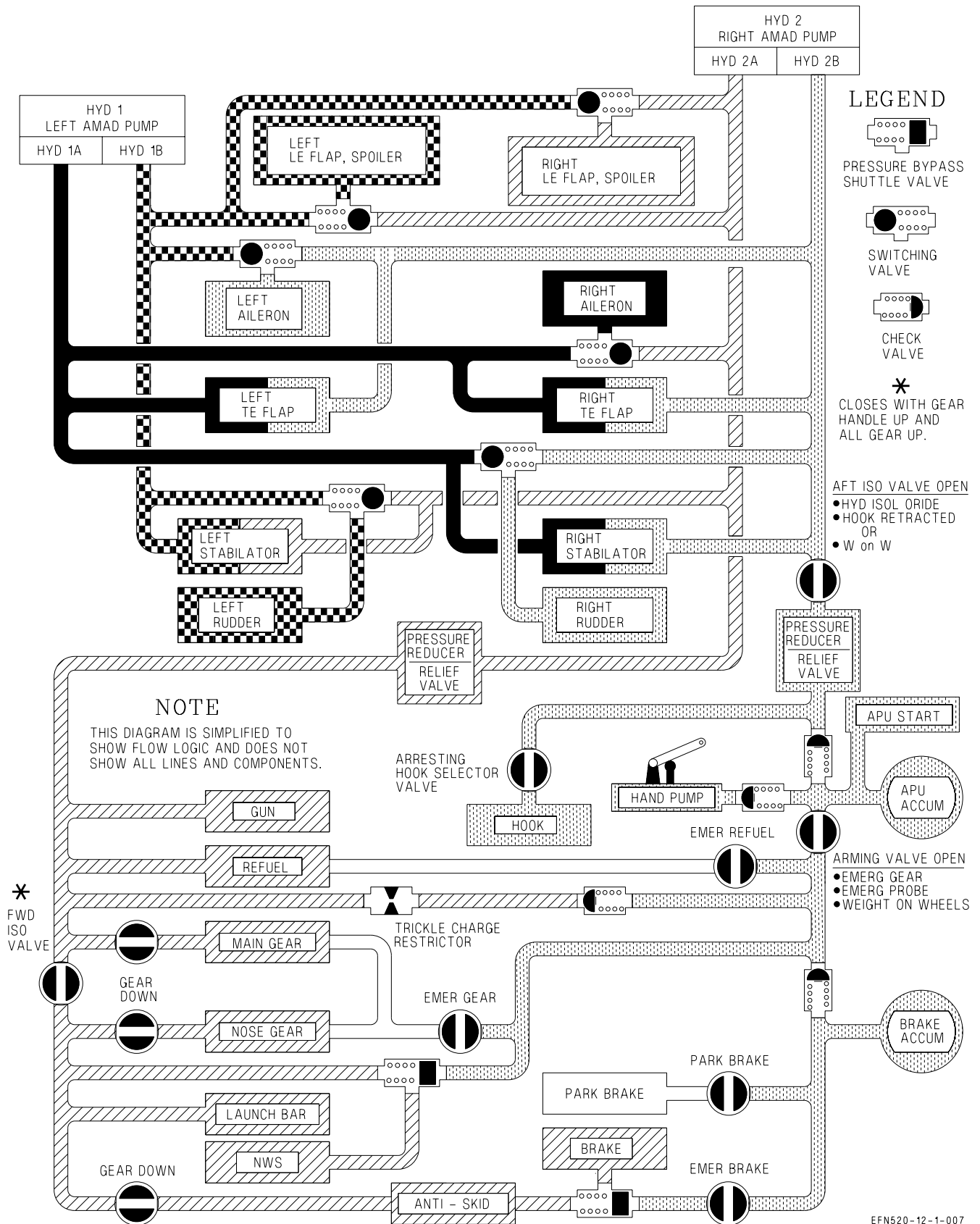

Figure 2-16. Hydraulic Flow

2.7.1.1 Hydraulic Pumps. Each system is pressurized by a single, dual pressure (3,000 and 5,000 psi), variable displacement pump mounted on an AMAD. Pump output pressure is commanded by the FCCs based on aircraft flight condition; with 5,000 psi utilized during high-speed flight when air loads are high. One pump is capable of powering the entire flight control system in the event of a single system failure. A hydraulic pressure transducer relays system pressure to a hydraulic pressure gauge in the cockpit. Hydraulic cautions (HYD 1A, HYD 1B, HYD 2A, HYD 2B) are set when individual hydraulic pressure switches detect circuit pressure below 1,400 psi.

2.7.1.1.1 Hydraulic Pressure Gauge. The hydraulic pressure gauge is located on the lower right main instrument panel. The gauge has individual needles for indicating HYD 1 and HYD 2 system pressure. Tick marks for 3,000 and 5,000 psi are provided. Two white bands indicate the range of acceptable operation pressure (2,600 to 3,300 psi and 4,500 to 5,400 psi). Since the gauge is ac powered, actual hydraulic readings are not provided until the first generator is online following engine start. During shutdown, pressure readings freeze when the last generator drops offline.

2.7.1.2 Hydraulic Reservoirs. Hydraulic fluid is supplied to each system by a separate hydraulic reservoir. The HYD 2 reservoir is larger than the HYD 1 reservoir in order to accommodate the utility system.

2.7.1.2.1 Reservoir Level Sensing (RLS) System. Each reservoir incorporates an RLS system, designed to isolate a leak in either system circuit. When reservoir fluid level drops to approximately 50 %, RLS shuts off circuit A (HYD 1A or HYD 2A caution). If fluid level continues to deplete to approximately 30 %, RLS restores circuit A and shuts off circuit B (HYD 1B or HYD 2B caution). If alternate circuit shutdown fails to isolate the leak, RLS restores circuit B (no cautions) at approximately 15 %, providing hydraulic pressure to both systems until fluid depletion (both cautions).

2.7.1.3 Switching Valves. Hydraulic switching valves are utilized to provide backup hydraulic power to actuators that are not powered simultaneously by both systems. Two hydraulic circuits, a primary and a backup, provide power to each switching valve.

2.7.1.3.1 Switching Valve Operation. Following a drop in primary circuit pressure (less than 900 (± 100 psi)), the switching valve automatically shuts off the primary circuit and tests downstream pressure to make sure its actuator(s) was not the leakage source which caused the primary circuit loss. Concurrently, FCC monitoring detects the pressure loss and inhibits FCC actuator failure detection logic for 10 seconds to allow the switching valve time to function.

If the actuator(s) passes this leak detection test, the switching valve allows the backup circuit to provide hydraulic power. If the actuator(s) fails the test, the switching valve isolates both circuits to prevent additional loss of the backup circuit. At the expiration of the 10 second timer, the FCCs no longer inhibit actuator failure detection logic. With both circuits isolated, this logic Xs LEF actuators immediately and rudder or aileron actuators **only when** the actuator is subsequently commanded to move. It is for this reason that the FLAP switch is cycled during the post-flight switching valve check.

Switching valve operation is completely hydro-mechanical, separate from electrical inputs or FCS reset commands. As mechanized, there is no hazard associated with multiple reset attempts to regain an Xd surface **following a hydraulic circuit failure**.

Preference is given to the primary circuit at all times. The switching valve transfers to the primary circuit any time primary circuit pressure recovers above 2,000 psi, regardless of the valve position or the backup circuit pressure level.

NOTE

If the leak detection test failed due to cavitation in the actuator, the switching valve resets, runs another test, and completes the switch to the backup circuit. This self-resetting feature may require several minutes to complete depending on surface loading, hydraulic system pressure, and system temperature. In this case, an FCS reset restores an X'd surface if and when the switching valve successfully transfers to the backup circuit.

2.7.1.4 Hydraulic Isolation Valves. HYD 2 utility functions that are required only during takeoff, landing, and ground operations are downstream of isolation valves. The forward isolation valve is closed when the LDG GEAR handle is UP and all three landing gear are up and locked; isolating the nose gear, NWS, launch bar, wheel brakes, and anti-skid. The aft isolation valve and the arming valve are open with WonW and are normally closed inflight; isolating arresting hook retraction, parking brakes, and emergency brakes. The aft isolation valve is manually opened inflight by hook retraction or by holding the HYD ISOL switch in ORIDE. The arming valve is manually opened inflight by emergency gear or emergency probe extension.

2.7.2 Hydraulic Accumulators. Two hydraulic accumulators are provided in the HYD 2B circuit; the auxiliary power unit (APU) accumulator and the brake accumulator.

The APU accumulator provides hydraulic pressure to start the APU. With a HYD 2 failure, pressure from the APU accumulator can be used to:

- a. Emergency extend the landing gear or refueling probe inflight.
- b. Provide emergency nosewheel steering on the ground.
- c. Aid the brake accumulator with emergency braking.

On the ground with engines shutdown, the brake accumulator provides hydraulic pressure to set the parking brake. With a HYD 2 failure, pressure from the brake accumulator can be used to provide emergency braking. A fully charged brake accumulator provides a minimum of ten full brake applications.

The APU and brake accumulator charges are maintained against normal leakage and temperature fluctuations by a trickle-charge restrictor connected to HYD 2A. Additionally, both accumulators may be manually recharged inflight using HYD 2B pressure by placing the HYD ISOL switch to ORIDE. This procedure recharges the brake accumulator if and only if the arming valve is open (emergency gear or emergency probe extension previously selected). Both accumulators can be charged on the ground by a hand pump located in the right main landing gear wheelwell.

2.7.2.1 Brake Accumulator Pressure Gauge. The brake accumulator pressure gauge is located on the lower left main instrument panel and is redlined to indicate pressure below 2,000 psi. The BRK ACCUM caution is displayed when brake accumulator pressure drops below 2,000 psi. The caution and redlined pressure indication are warnings that approximately five full brake applications remain before the brake accumulator is empty. When ac power is not applied, power to the gauge is controlled by the BRK PRESS switch.

2.7.2.1.1 BRK PRESS Switch. The BRK PRESS switch, located on the forward left console, is spring loaded to the aft position.

Forward (unmarked)	Applies maintenance bus power to the brake accumulator pressure gauge when ac power is not applied.
Aft (unmarked)	Brake accumulator pressure gauge unpowered when ac power is not applied.

2.7.2.2 HYD ISOL Switch. The HYD ISOL switch, located on the aft left console, is spring loaded to the NORM position.

ORIDE	Opens the aft isolation valve in flight allowing HYD 2B pressure to recharge the brake and/or APU accumulators. Following emergency landing gear extension, the switch may need to be held for up to 20 seconds to remove the APU ACCUM caution and provide a full charge (up to 40 seconds following an in-flight APU start).
NORM	Allows normal aft isolation valve functioning.



If an APU ACCUM caution appears in flight and is not related to emergency gear/probe extension or APU start, it may indicate a possible leak in the isolated HYD 2B system. A BRK ACCUM caution in flight is not normal and may indicate a possible leak in the isolated HYD 2B system.

2.7.3 Hydraulic System Related Cautions and Caution Light. The following hydraulic system related cautions and caution light are described in the Warning/Caution/Advisory Displays in Part V:

- HYD 1A, HYD 1B, HYD 2A, HYD 2B
- HYD 5000
- HYD 1 HOT, HYD 2 HOT
- BRK ACCUM
- APU ACCUM caution and caution light

2.8 UTILITY HYDRAULIC FUNCTIONS

The utility hydraulic functions are powered by HYD 2 and include landing gear extension and retraction, nosewheel steering, wheel braking and anti-skid, launch bar extension, arresting hook retraction, and in-flight refueling probe extension and retraction. Operation of the in-flight refueling probe is described in the Fuel System section.

2.8.1 Landing Gear System. The landing gear is a tricycle design and includes a nose landing gear with steerable nosewheel and two fixed main landing gear. The nose landing gear retracts forward, while the main landing gear retract aft and inwards. When the landing gear is extended, all landing gear doors remain open.

2.8.1.1 Planing Links. Each main landing gear assembly incorporates a planing link, which is designed to properly align the main wheels after landing gear extension. The joint which connects the wheel to the main landing gear lever is designed to rotate off-axis, so that the wheel fits properly into the main landing gear wheelwell. The planing link rotates the main wheel from its stowed orientation, aligns it with the longitudinal axis of the aircraft, and locks over-center. A planing link proximity switch is used to verify proper planing link position and thereby proper wheel alignment. A flashing main landing gear position light is used to provide an indication of a planing link failure.

2.8.1.2 Normal Landing Gear Extension and Retraction. Normal landing gear extension and retraction is electrically controlled by the LDG GEAR handle and uses hydraulic pressure from HYD 2A. With weight off the nose gear **and** the launch bar retracted, moving the LDG GEAR handle to the UP position sends an electrical signal to the landing gear selector valves to initiate normal landing gear retraction. Likewise, moving the LDG GEAR handle to the DN position sends an electrical signal to the landing gear selector valves to initiate normal landing gear extension

If the launch bar does not return to the up and locked position after catapult launch **or** the nose gear indicates WonW, the nose landing gear cannot be retracted. In either case, placing the LDG GEAR handle UP will raise the main landing gear and leave the nose landing gear extended.

2.8.1.3 Emergency Landing Gear Extension. Emergency landing gear extension is mechanically controlled by the LDG GEAR handle (front cockpit) or the EMERG LDG GEAR handle (rear cockpit Lots 21 thru 25) and uses hydraulic pressure provided by the APU accumulator. Both handles are mechanically connected to the landing gear emergency selector valves by a series of levers and cables. Emergency extension is mechanically activated by rotating the LDG GEAR handle 90° clockwise and pulling to detent (approximately 1.5 inches) or by pulling the EMERG LDG GEAR handle to the detent.

Emergency landing gear extension opens the hydraulic arming valve and directs APU accumulator pressure to the emergency selector valves. APU accumulator pressure is used to unlock the doors, release the landing gear uplocks, and is applied to the drag brace locking actuator and sidebrace downlock actuator. The nose landing gear extends by freefall aided by airloads and the drag brace locking actuator. The main landing gear extends by freefall aided by the sidebrace downlock actuator. Emergency extension can be performed with the LDG GEAR handle either UP or DN (DN is recommended).

2.8.1.4 LDG GEAR Handle. The wheel-shaped LDG GEAR handle, located on the lower left main instrument panel in the front cockpit, is used to control landing gear extension and retraction. A downlock solenoid in the LDG GEAR handle assembly prevents gear retraction with WonW by preventing movement of the handle from the DN position.

UP	With WoffW and the launch bar retracted, electrically initiates normal landing gear retraction.
DN	Electrically initiates normal landing gear extension.
Emergency (Rotate handle 90° clockwise and pull to the detent)	Mechanically initiates emergency landing gear extension.

2.8.1.5 DOWNLOCK ORIDE Button. The DOWNLOCK ORIDE button, located on the lower left main instrument panel outboard of the LDG GEAR handle, is used to override the downlock solenoid. If the downlock solenoid does not retract with WoffW (LDG GEAR handle cannot be moved from the DN position), a failure has occurred in the downlock circuitry (Landing Gear Control Unit). If the landing gear indicate three down and locked, cycling the landing gear handle is not recommended, as proper landing gear functioning is questionable. However, if dictated by an emergency situation, pressing and holding the DOWNLOCK ORIDE button will retract the mechanical stop and allow the LDG GEAR handle to be moved to the UP position.

The LDG GEAR handle must be in the full down position for the mechanical stop to properly engage after landing (WonW).



If the DOWNLOCK ORIDE button is pressed or the mechanical stop is not fully engaged, the LDG GEAR handle can be raised on the ground, and the main landing gear will retract. The nose gear will not retract with weight on the nose gear.

2.8.1.6 EMERG LDG GEAR Handle (F/A-18F). The EMERG LDG GEAR handle is located on the lower left main instrument panel in the rear cockpit. Pulling the handle to the detent mechanically initiates emergency landing gear extension.

2.8.1.7 Landing Gear Control Unit (LGCU). The LGCU monitors the position of the landing gear and launch bar systems, provides cockpit indications of gear/launch bar position, and provides outputs to various aircraft systems which are dependent on gear position (e.g., FCC A and B, the SMS, and the SDC). The LGCU does not control landing gear extension and retraction.

The LGCU receives inputs from the LDG GEAR handle, the LAUNCH BAR switch, and the following proximity switches: launch bar, landing gear uplocks, landing gear downlocks, planing links, and WonW. The LGCU controls the red and green L BAR warning/advisory lights, the landing gear position lights, the light in the gear handle, the landing gear warning tone, the downlock solenoid, and all inputs to the FCCs and the SMS. The LGCU also performs a self-BIT and a functional check of all proximity switches, providing MSP code input to the SDC.

2.8.1.8 Landing Gear Warning Light and Warning Tone. The landing gear warning light is a red light located inside the LDG GEAR handle. The landing gear warning tone is a beeping tone heard in the headset. The landing gear warning light and warning tone serve three purposes: to indicate a mismatch between LDG GEAR handle position and actual gear position, to warn of a planing link failure, and to provide a "wheels warning."

A steady warning light comes on whenever the landing gear is in transit and remains on until all three gear are down and locked (LDG GEAR handle DN) or all gear doors are closed and locked (LDG GEAR handle UP). If the landing gear is unsafe, the landing gear warning light remains on. The warning tone is inhibited for 15 seconds to allow for normal landing gear extension and retraction. If the warning light remains on for 15 seconds, the warning tone is annunciated to provide an aural indication of unsafe landing gear position.

If a left or right planing link failure occurs with the landing gear down and locked (planing link proximity switch not properly activated), the landing gear warning light will come on immediately accompanied by the warning tone.

Lastly, when the LDG GEAR handle is UP, a flashing warning light accompanied by the warning tone will be activated when airspeed is below 175 KCAS, altitude is less than 7,500 feet, and rate of descent is greater than 250 fpm. This "wheels warning" is provided as a cue to check the position of the landing gear at flight conditions where the LDG GEAR handle should normally be DN. The wheels warning is also activated if calibrated airspeed and/or barometric altitude data are lost. In this case, the standby airspeed and/or altitude indicators should be referenced prior to silencing the warning tone.

2.8.1.8.1 WARN TONE SIL Button. The WARN TONE SIL button, located to the left of the LDG GEAR handle, is used to silence the landing gear warning tone.

2.8.1.8.2 Landing Gear UNSAFE Light (F/A-18F). The landing gear UNSAFE light is a red light located on the upper left main instrument panel in the rear cockpit. The light indicates a mismatch between LDG GEAR handle position and actual gear position (e.g., gear in transit). The light does not illuminate for a planing link failure, wheels warning, or loss of air data.

2.8.1.9 Landing Gear Position Lights. Three green landing gear position lights, located on the lower left main instrument panel, are labeled NOSE, LEFT, and RIGHT. When the LDG GEAR handle is DN, steady lights indicate that the corresponding landing gear is down and locked. The LEFT and RIGHT landing gear position lights are also used to indicate a planing link failure. If the main landing gear are down and locked but a planing link proximity switch is not properly activated, the corresponding position light will flash.

A landing gear position of three down and locked is indicated by three steady green position lights with the landing gear warning light out. Additionally, when illuminated in flight, the approach lights provide an external indication that the landing gear is down and locked.

If a landing gear position light is out with the LDG GEAR handle DN and the landing gear warning light out, a LT TEST should be performed to test the integrity of the position light bulb. If the bulb tests bad, it is safe to assume that the gear is down and locked. During day operations, if all three position lights appear to be out/dim, make sure the interior lights MODE switch is in the DAY position.

A landing gear position of three up and locked is indicated by the landing gear warning light out with all three position lights out.



If one or more landing gear indicates unsafe, a visual inspection can only confirm general position and obvious damage. There is no external indication of a locked landing gear.

2.8.1.9.1 Landing Gear Position Lights (F/A-18F). Three green landing gear position lights, labeled NOSE, LEFT, and RIGHT, are located on the upper left main instrument panel in the rear cockpit. These lights have the same functionality as those in the front cockpit.

2.8.2 Nosewheel Steering System (NWS). The NWS system is used to provide directional control and shimmy damping during ground operations. The NWS hydraulic power unit, attached to the nose landing gear strut, is electrically controlled by commands from the FCCs and is hydraulically actuated by pressure from HYD 2A (primary) or HYD 2B/ APU accumulator (backup). In the event of a HYD 2A failure, a pressure-biased shuttle valve routes HYD 2B pressure (if available), or APU accumulator pressure to the NWS unit for backup operation. The FCCs accept input from the rudder pedals to provide NWS commands.

The NWS system has two modes, NWS (low) and NWS HI. In the low mode (NWS cue in the HUD), full rudder pedal deflection commands approximately 22.5° of nosewheel deflection. In the high mode (NWS HI cue in the HUD), full rudder pedal deflection commands approximately 75° of nosewheel deflection. The NWS system (low gain) incorporates a yaw rate feedback input from the FCCs, which

is designed to suppress directional PIO tendencies by increasing directional damping during takeoff and landing roll.



With loss of yaw rate information to the FCCs, directional PIO may occur during aggressive ground tracking.

If the NWS system fails, the NWS caution is displayed and the NWS or NWS HI cue is removed from the HUD. When failed, the NWS system reverts to a 360° free-swiveling mode.

2.8.2.1 NWS Engagement/Disengagement. With WonW, manual NWS engagement is provided by actuation of the NWS/undesignate button. The method required to engage each of the two NWS modes (low and high) is dependent on wing lock/unlock status.

With the wings spread and locked and NWS disengaged, the first momentary press and release of the NWS button engages full-time NWS (low). NWS HI is engaged by subsequent press and hold of the NWS button. With NWS disengaged, press and hold for greater than 1 second also engages NWS HI. If the NWS button is released, the system reverts to NWS (low).

With the wings unlocked and NWS disengaged, the first momentary press and release of the NWS button still engages full-time NWS (low). However, subsequent press and release engages full-time NWS HI, providing hands-free NWS HI capability for operations in the carrier environment. If the wings are subsequently spread and locked, NWS reverts to the low mode.

During landing, full-time NWS (low) is automatically engaged when the nose landing gear and at least one main landing gear transition to WonW. If NWS is engaged with both HYD 2A and 2B failures, the NWS or NWS HI cue will flash in the HUD as an indication that APU accumulator pressure is depleting.

NWS is manually disengaged by pressing the paddle switch. NWS is automatically disengaged for catapult launch, when the launch bar is extended. With the launch bar extended, NWS (low) can be momentarily engaged to position the launch bar by press and hold of the NWS button. Additionally, NWS is automatically disengaged when the nose landing gear transitions to WoffW during takeoff or when power is removed from the FCCs.

2.8.2.2 Emergency High Gain NWS. With a FCS CH 2 or FCS CH 4 failure, normal nosewheel steering is lost. Emergency high gain NWS can be regained by pulling the failed channel circuit breaker, unlocking the wings, and momentarily pressing the nosewheel steering button.



When emergency high gain NWS mode is entered, NWS indications may not be displayed on the HUD. As a result, inadvertent nosewheel steering actuation may injure ground personnel.

2.8.3 Wheel Brake System. The aircraft's wheel brake system provides normal braking, anti-skid, emergency braking, a parking brake, and main wheel anti-spin. Normal braking utilizes HYD 2A pressure and is capable of functioning with a separate anti-skid system. The anti-skid system, when enabled, provides maximum braking effectiveness on wet runways or during heavy braking by

preventing wheel skid. When selected, emergency braking utilizes HYD 2B pressure, if available, or brake and APU accumulator pressure to provide backup braking capability following a HYD 2A failure. The anti-spin function stops main landing gear wheel rotation prior to landing gear retraction.

2.8.3.1 Wheel Brake Assembly. Each main landing gear wheel is fitted with hydraulically actuated multiple disk brakes. There are two independent sets of brake lines running to each wheel brake assembly: the normal brake line pressurized by HYD 2A and the emergency brake line pressurized by HYD 2B or the brake and APU accumulators. See figure 2-17. Only one set of brake lines can be pressurized at any given time. A shuttle valve on each wheel brake assembly switches from normal to emergency brake pressure, depending on which is applied.

Each wheel brake assembly has a brake wear indicator pin, located on the inboard side of the wheel. When the brakes are applied and the indicator pin is flush or below flush with the brake housing, the brake pads require changing.

Each wheel assembly incorporates a fuse plug which is designed to melt and deflate the tire at temperatures below those which would result in a catastrophic tire blowout.

2.8.3.2 Wheel Brake Operation. Each main wheel brake is controlled by a separate brake pedal, integrated into the rudder/brake pedal mechanism. Pilot applied force to the top of each brake pedal is transmitted by a series of cables and pulleys directly to the brake control hydraulic servovalves, located in the nose wheelwell. The amount of hydraulic pressure applied to the wheel brakes by the servovalves is directly proportional to brake pedal force. Dual brake pedal action provides symmetric braking, while individual brake pedal action provides differential braking. In the F/A-18F (trainer configuration), a second set of cables are routed to the servovalves from the rear cockpit brake pedals. The servovalves are controlled by the pilot applying the most brake pedal force.

2.8.3.3 Normal Braking. Normal braking is enabled when HYD 2A is operable and the EMERG BRK handle(s) are in the stowed position. The emergency brake valve is closed and the emergency brake lines are unpressurized. During normal braking, HYD 2A pressure is applied through the left and right servovalves proportional to the amount of pilot applied brake pedal force and is routed to the main wheel brakes. When the ANTI SKID switch is ON, the anti-skid system modulates pilot applied brake pressure in order to prevent wheel skid. When the ANTI SKID switch is OFF, the pilot must regulate brake pedal force to prevent wheel skid.

2.8.3.4 Anti-skid System. The anti-skid system performs 4 basic functions which are designed to maximize braking effectiveness during landing rollout: touchdown protection, wheel spin-up override, skid control, and locked wheel protection. The anti-skid system is enabled when the ANTI SKID switch is ON **and** the LDG GEAR handle is DN.

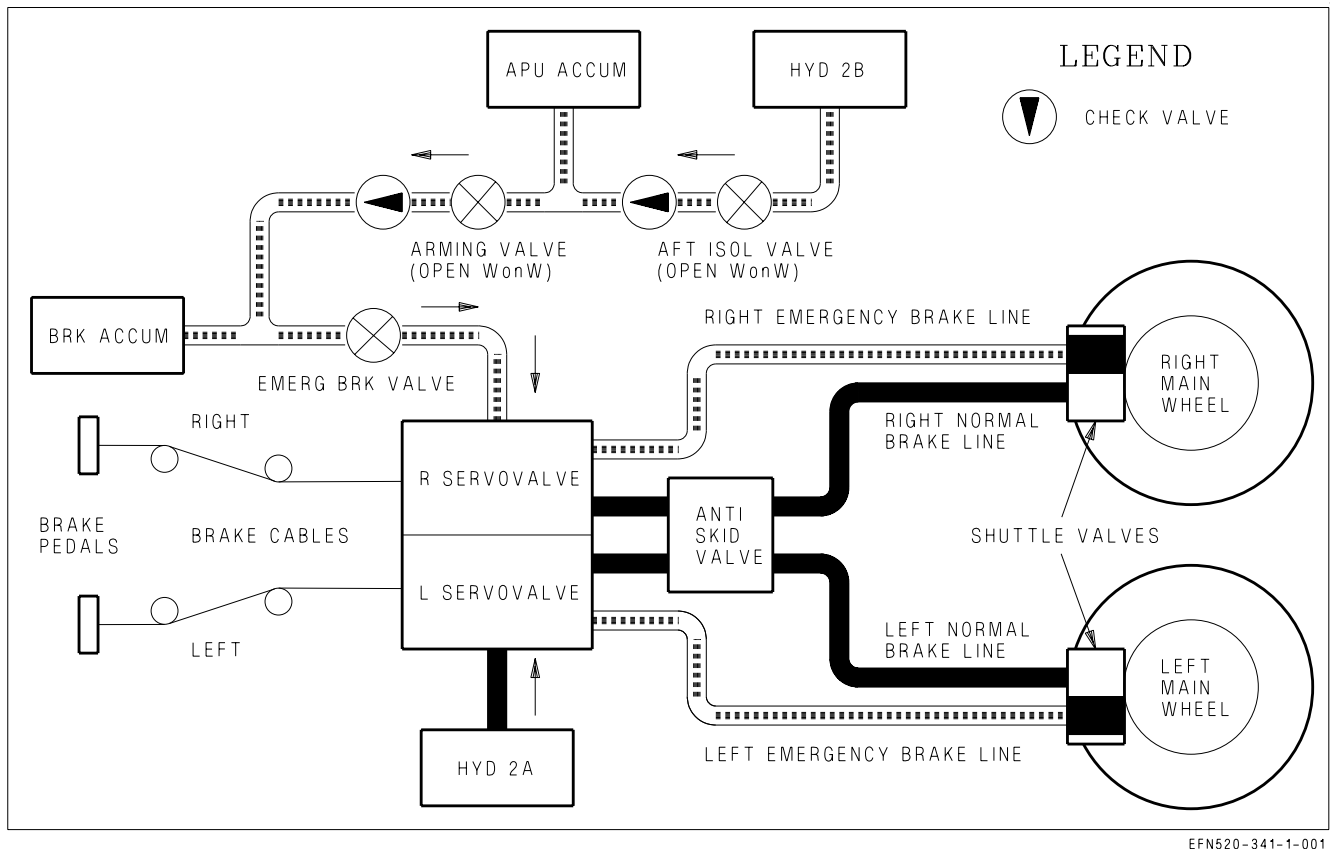

Figure 2-17. Wheel Brake and Anti-skid System

WARNING

Failure of either wheel speed sensor can lead to an anti-skid failure, resulting in a complete loss of brakes. Placing the ANTI SKID switch to the OFF position or pulling the EMERG BRK handle will bypass the faulty system and restore braking ability. Judicious braking must be used, as the anti-skid system is not available. Refer to the BRAKE FAILURE/EMERGENCY BRAKES procedure.

The system contains two wheel speed sensors, an anti-skid control unit, and an anti-skid control valve. The anti-skid control unit senses wheel speed and operates by electronically limiting the amount of HYD 2A pressure that is applied to the wheel brakes through the anti-skid control valve and the normal brake lines. Anti-skid is not available when emergency brakes are selected.

Touchdown protection delays initial brake application on landing by completely dumping brake pressure until (1) weight is on the right main landing gear **and** wheel speed is over 50 knots or (2), if a wet runway delays wheel spin-up, for 3 seconds after landing. This function prevents landing with locked main wheels (tire blowouts) even if full brake pedal force is applied at touchdown.

Wheel spin-up override is activated at 50 knots wheel speed to allow normal braking if the right WonW switch fails.

Skid control is enabled when sensed wheel speed differs from what the anti-skid control unit determines it should be (e.g., hydroplaning is detected). If the system detects wheel skid, anti-skid limits the amount of HYD 2A pressure applied to **both** brakes as required to prevent skidding. If no skid exists, full pilot-applied brake pressure is routed to the brakes.

If the speed of one wheel drops 40 % below the other wheel, locked wheel protection dumps brake pressure to **both** wheels until the speed of the slower wheel returns above 40 % of the other. Locked wheel protection is removed below 35 knots, so that full braking performance (including locking a tire) is available for taxi and turning operations. Below 14 knots, anti-skid is completely disabled. Below 35 knots, judicious braking is required to avoid flat spotting tires.

Anti-skid protection is bypassed when the ANTI SKID switch is OFF. Normally limited by the anti-skid system, 3,000 psi hydraulic brake pressure is available and regulated only by pilot brake pedal forces. When using brakes at high speed without anti-skid protection, there is a very small margin between effective braking and blown tires. Any force greater than approximately 55 to 60 lbs applied to the pedals (6° to 7° of pedal rotation) will likely result in blown tires with either the ANTI SKID switch OFF or emergency brakes selected. The use of normal (anti-skid off) brakes at high speed should be done with extreme caution. If braking without anti-skid is needed at high speeds, initially apply very light brake pedal pressure and gradually increase as required.

WARNING

Use of brakes without anti-skid at high speed can result in blown tires resulting in loss of directional control. If practical, rollout speed should be as slow as possible before applying brake pedal pressure.

NOTE

Hot brakes and/or melted wheel assembly fuze plugs can be expected any time maximum effort braking is used at heavy gross weights with or without anti-skid, e.g., aborted takeoff or heavy weight landing (above 46,000 lb GW) with high taxi brake usage.

2.8.3.4.1 ANTI SKID Switch. The ANTI SKID switch, located on the lower left main instrument panel, is used to manually disable the anti-skid system, e.g., for carrier operations or following an anti-skid failure (ANTISKID caution displayed). The switch is lever-locked in the OFF position.

ON	Anti-skid system enabled for use with normal braking.
OFF	Anti-skid system disabled (SKID advisory displayed when the landing gear is down).

2.8.3.4.2 Anti-skid BIT and the ANTISKID Caution. The anti-skid control unit performs two types of BIT: initiated and periodic. IBIT is performed when power is initially applied to the anti-skid system: (1) when the landing gear is lowered, (2) when the ANTI SKID switch is selected from OFF to ON inflight, or (3) on the ground with the parking brake set. IBIT performs a complete test of the anti-skid system 9 seconds after power is applied and runs for 4.5 seconds. With WonW, IBIT is inhibited with the parking brake released, as wheel motion will cause a false BIT failure and brake pressure would be dumped if brakes were applied. PBIT only performs a partial anti-skid test and runs whenever power is applied and IBIT is not running.

If an anti-skid failure is detected by either BIT, the ANTISKID caution will be displayed at BIT completion. If an anti-skid failure is detected by PBIT, cycling the ANTI SKID switch will command an IBIT and a more complete test of the system. When IBIT is running, the ANTISKID caution is inhibited or is removed if previously displayed. If the ANTISKID caution returns after IBIT, the ANTI SKID switch must be placed to OFF in order to isolate the failure and make sure that normal braking (without anti-skid) is available.

For instance, assume the right wheel speed sensor has failed and an ANTISKID caution is displayed. If the ANTI SKID switch is left ON during landing, touchdown protection circuitry will dump and never restore brake pressure to both wheels. Normal braking will be lost. In this case, placing the ANTI SKID switch to OFF will restore normal braking (without anti-skid), or pulling the EMERG BRK handle will enable emergency braking (bypassing anti-skid).

WARNING

- Do not cycle the ANTI SKID switch in response to an ANTISKID caution immediately prior to landing. Cycling the ANTI SKID switch removes the ANTISKID caution for up to 13.5 seconds as the system performs IBIT even though the anti-skid system may still be failed and, if the system is not failed, wheel motion at touchdown may cause a false BIT failure and a dump of normal brake pressure when brakes are applied.
- If the ANTI SKID switch is not placed to OFF with an ANTISKID caution displayed, normal braking capability may be lost completely.

2.8.3.5 Emergency Braking. Emergency braking is enabled when either EMERG BRK handle is pulled to detent. This action opens the emergency brake valve and applies backup hydraulic pressure to the hydraulic servovalves. If available, backup pressure from HYD 2B is utilized through the aft isolation and arming valves, which are open with WonW. If HYD 2 is failed completely, backup pressure from both the brake and APU accumulators is used. Check valves are incorporated to prevent the loss of accumulator pressure if HYD 2B is failed. With backup pressure applied, the servovalves isolate HYD 2A pressure, if still available, so that the normal brake lines are unpressurized.

During emergency braking, backup pressure is applied through the left and right servovalves proportional to the amount of pilot applied brake pedal force and is routed to the main wheel brakes through the emergency brake lines. These lines bypass the anti-skid control valve, so the pilot must regulate brake pedal force to prevent wheel skid.

Hydraulic accumulators and the brake accumulator pressure gauge are discussed in the Hydraulic Power Supply System section.

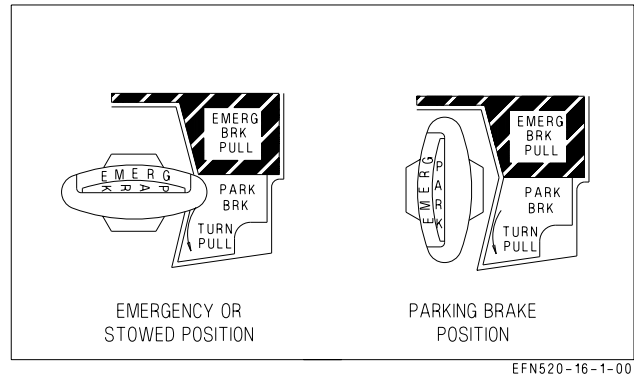

Figure 2-18. Emergency/Parking Brake Handle

2.8.3.5.1 EMERG BRK Handle (Front Cockpit). The EMERG BRK handle is combined with the PARK BRK handle and is located on the lower left main instrument panel in the front cockpit. When the handle is in the stowed, emergency position (horizontal), the “EMERG” label appears upright. See figure 2-18. To select emergency brakes, the handle must be pulled to the detent while in the horizontal position.

Stowed (unmarked)	Emergency brake valve closed. Normal braking selected.
PULL (to detent)	Emergency brake valve open. Emergency braking selected.

WARNING

The position of the EMERG BRK handle is the only indication that emergency braking is selected: no warning or caution is displayed. The EMERG BRK handle(s) must be fully stowed in both cockpits to make sure that normal braking with anti-skid is available.

CAUTION

Due to friction in the EMERG BRK handle mechanism, the handle may not return to the fully stowed position unless positively pushed.

2.8.3.5.2 EMERG BRK Handle (Rear Cockpit Lots 21 thru 25). The EMERG BRK handle, located on the lower left main instrument panel in the rear cockpit, is used to select emergency braking from the rear cockpit. When stowed, the handle is oriented vertically.

Stowed (unmarked)	Emergency brake valve closed. Normal braking selected.
PULL	Emergency brake valve open (to detent). Emergency braking selected.

WARNING

The position of the EMERG BRK handle is the only indication that emergency braking is selected: no warning or caution is displayed. The EMERG BRK handle(s) must be fully stowed in both cockpits to make sure that normal braking with anti-skid is available.

CAUTION

Due to friction in the EMERG BRK handle mechanism, the handle may not return to the fully stowed position unless positively pushed.

2.8.3.6 Parking Brake System. The parking brake is used to lock the main landing gear wheels when the aircraft is parked. The parking brake is activated when the PARK BRK handle is rotated and pulled to the locked position. This action places the emergency brake valve in the parking brake mode. Backup hydraulic pressure from HYD 2B or the brake and APU accumulators is applied to the wheel brake hydraulic servovalves and routed to the main wheel brakes through the emergency brake lines.

The PARK BRK caution will come on to alert the pilot that the parking brake is still set when both throttles are advanced above about 80 % N_2 rpm (INS on).

2.8.3.6.1 PARK BRK Handle. The PARK BRK handle is combined with the EMERG BRK handle and is located on the lower left main instrument panel in the front cockpit. From the stowed (horizontal) position, the handle must be rotated 90° counterclockwise and pulled to the locked position, in order to activate the parking brake. When the handle is in the vertical position, the “PARK” label appears upright. See figure 2-18. If emergency brakes are selected, the handle must be returned to the stowed position before the parking brake can be activated. Rotating the handle 45° counterclockwise releases the lock and allows the handle to return to the stowed (horizontal) position.

Stowed (unmarked) Parking brake released. Normal braking selected.

TURN/
PULL Parking brake set.

Several aircraft systems utilize parking brake activation to enable or disable logic. A set parking brake is used to enable anti-skid BIT logic, GEN TIE logic, and INS alignment and is used to trigger the PARK BRAKE caution.

2.8.3.7 Main Wheel Anti-Spin. The anti-spin function stops main landing gear wheel rotation prior to landing gear retraction. When the LDG GEAR handle is moved to the UP position, main landing gear retract pressure is supplied to the anti-skid control valve. Normal brake pressure is blocked and this anti-spin pressure is routed to the wheel brakes through the normal brake lines. Unlock and retraction of the main landing gear is delayed until anti-spin pressure is applied and main wheel rotation has stopped.

2.8.4 Launch Bar System. The launch bar is electrically controlled, hydraulically extended, and mechanically retracted. With weight on the nose gear, placing the LAUNCH BAR switch to EXTEND

energizes the launch bar control valve and routes HYD 2A pressure to unlock, lower, and hold down the launch bar. The green L BAR advisory light indicates that the launch bar has been extended.

With the launch bar extended, returning the LAUNCH BAR switch to RETRACT deenergizes the launch bar control valve, isolates HYD 2A pressure, and allows dual retract springs to mechanically return the launch bar to the up and locked position. A launch bar proximity switch is energized when the launch bar is fully retracted.

When the launch bar is fully extended it is held against the deck by HYD 2A pressure. Deck load springs allow vertical movement of the launch bar during taxi over the catapult shuttle. When the aircraft is placed in tension on the catapult, the launch bar is held captive in the extended position by the shuttle. Once in tension, the LAUNCH BAR switch should be placed to RETRACT in order to remove HYD 2A pressure from the launch bar. When the LAUNCH BAR switch is placed to RETRACT, the green L BAR light should go out.



Failure to place the LAUNCH BAR switch to RETRACT prior to catapult launch may result in launch bar hydraulic seal failure and possible loss of HYD 2A.

At the end of the catapult stroke, launch bar/shuttle separation occurs and allows the retract springs to return the launch bar to the up and locked position. When engaged, the launch bar uplock prevents the launch bar from dropping to the deck due to g-loads during landing.

If the launch bar does not return to the up and locked position after catapult launch (launch bar proximity switch not energized), the nose landing gear cannot be retracted. In this case, placing the LDG GEAR handle UP will raise the main landing gear and leave the nose landing gear extended.

2.8.4.1 LAUNCH BAR Switch. The LAUNCH BAR switch, located on the lower left main instrument panel in the front cockpit, is used to control the position of the aircraft's launch bar. The switch is spring loaded to the RETRACT position and is electrically held in the EXTEND position only if weight is on the nose gear.

RETRACT Launch bar control valve deenergized. Launch bar up.

EXTEND Launch bar control valve energized. Launch bar unlocked and extended by HYD 2A pressure. Green L BAR advisory light on.

2.8.4.2 LB Circuit Breaker. The LB circuit breaker is located on the left-hand circuit breaker panel above the left console. The LB circuit breaker provides a secondary means to raise the launch bar following a launch bar malfunction. When pulled, the circuit breaker manually deenergizes the launch bar control valve, removing HYD 2A pressure and allowing the retract springs to raise the launch bar.

Typically, this action would be required only if (1) the LAUNCH BAR switch failed in the EXTEND position with weight on the nose gear or (2) the nose gear failed WonW after launch **and** the pilot failed to place the LAUNCH BAR switch to RETRACT.

2.8.4.3 L BAR Warning/Advisory Lights. Two L BAR lights, one green and one red, are located on the left warning, caution, and advisory lights panel. Both lights are controlled by the landing gear

control unit (LGCU), based on inputs from the LAUNCH BAR switch, the launch bar proximity switch, and various landing gear proximity switches.

The green L BAR advisory light is used to indicate that the launch bar has been extended. The LGCU illuminates the green L BAR light when all of the following conditions are met: weight on the nose gear, the LAUNCH BAR switch in EXTEND, the launch bar not up (launch bar proximity switch not energized), and the red L BAR warning light not on.

The red L BAR warning light is used to indicate failure of the launch bar to retract after catapult launch or a failure in the launch bar control system (proximity switch failure). The LGCU illuminates the red L BAR light when one of the following sets of conditions are met:

1. Launch bar not up **and** weight off the left main gear.
2. Launch bar not up **and** left main gear not down.
3. LAUNCH BAR switch in EXTEND **and** weight off the left main gear.
4. LAUNCH BAR switch in EXTEND **and** left main gear not down.

The first set of conditions is the primary L BAR warning, e.g., the launch bar does not retract fully after catapult launch. The other three sets of conditions provide a backup L BAR warning if one or more of the proximity switches which control launch bar functioning fail.

2.8.5 Arresting Hook System. The arresting hook is always down-loaded by a nitrogen-charged accumulator (arresting hook snubber) contained in the arresting hook retract actuator. Arresting hook extension is therefore accomplished by mechanically releasing the arresting hook uplatch mechanism (HOOK handle down) and allowing snubber pressure and gravity to extend the hook. The hook should extend in less than 2 seconds. At touchdown, the arresting hook snubber controls hook bounce and provides a hold down force for arresting cable engagement.

Arresting hook retraction is accomplished by raising the HOOK handle. This electrically opens the aft isolation valve and the arresting hook selector valve, routing HYD 2B pressure to the arresting hook retract actuator. HYD 2B pressure overcomes the snubber down-load pressure and raises the hook. The arresting hook uplatch mechanism captures and locks the hook in the up position. The hook should retract in less than 4 seconds. If HYD 2B pressure is lost, the arresting hook cannot be retracted.

2.8.5.1 HOOK Handle. The HOOK handle, located on the lower right main instrument panel in the front cockpit, is used to control arresting hook extension and retraction.

Up
(unmarked) Retracts the arresting hook utilizing HYD 2B pressure.

Down
(unmarked) Unlocks the arresting hook uplatch mechanism and allows arresting hook snubber pressure and gravity to extend the hook.

2.8.5.2 HOOK Light. The red HOOK light is located on the lower right main instrument panel directly above the HOOK handle. The HOOK light comes on any time hook position does not agree with HOOK handle position. The light comes on when the hook leaves the up and locked position and remains on until the hook is fully extended (hook proximity switch energized). With WonW, the hook will strike the ground before it reaches full extension, so the HOOK light will remain on.

In Lot 26 AND UP, there is a green HOOK light in the rear cockpit on the left warning, caution, and advisory panel. This HOOK light illuminates when the hook is down.

2.9 WING FOLD SYSTEM

The aircraft's outer wing panels are designed to fold vertically to reduce the amount of deck space occupied by the aircraft in the carrier environment. Each wing contains an independent wingfold mechanism, which consists of two electric motors (one to lock/unlock the wings and one to spread/fold the wings). During normal operation, the wings are spread, locked, unlocked, and folded in unison.

2.9.1 Wingfold Mechanism. Each wingfold mechanism contains a dc electric motor, which locks and unlocks the wings, and an ac electric drive unit, which spreads and folds the wings. When the wings are spread and locked, a locking bolt is electrically driven through the wingfold hinge, holding it in place. When the wings are unlocked, a wing unlock flag (commonly called a beer can) protrudes from the upper surface of the wing near the leading edge of the wingfold hinge, indicating that the locking bolt is unstowed. The shaft of each beer can is painted red for easy identification. When the wings are locked, the top of the beer can should be flush or near flush with the upper surface of the wing, and no red should be showing.

Additionally, when the wings are folded, the ailerons are mechanically locked in the faired position by a hook on the inboard aileron hinge, which engages an aileron locking pin. The aileron locking pin is mechanically extended as the wings fold. The hook and locking pin are designed to prevent the ailerons from blowing inboard over the TEFs when hydraulic power is not applied. If an aileron locking pin should break, it is possible for the aileron to blow inward over the TEF. If this condition exists during engine start, the TEF will retract into the aileron, damaging both surfaces.



If the wings are folded, note the position of the ailerons during the preflight walk-around. If the aileron locking pins do not restrain the ailerons in the faired position, make sure the ailerons are moved to a faired or outboard position prior to engine start to preclude damaging the ailerons and TEFs.

Each wingfold mechanism also contains a wing safety switch, which electrically prevents wingfold movement. The safety switch is activated by a "remove before flight" pin inserted in the underside of the wing near the wingfold hinge.

For ground crew operations (such as loading wingtip missiles), each wing can be manually unlocked, folded, or spread. The beer cans can be manually extended by inserting a screwdriver into the wing unlock motor (underside, leading edge). Once unlocked, the wings can be folded or spread by inserting a speed handle into the electric drive unit (underside, trailing edge).

2.9.2 Wingfold Operation. With the wings folded, wing spread and lock is commanded by placing the WINGFOLD switch to SPREAD. The SPREAD command is sent directly to the electric drive units to spread the wings (there are no WonW or FCC interlocks). When each wing reaches the completely spread position, power is removed to that electric drive unit, and that wing is automatically commanded to lock. The WING UNLK caution will not be removed until both wings are locked (both beer cans down). Once the wings are spread and locked, the ailerons will droop to the position scheduled by the FCCs based on FLAP switch position.

The wings can be stopped in an intermediate position by placing the WINGFOLD switch to HOLD. If the wings are spread, selecting HOLD unlocks the wings without folding, allowing full time NWS HI

to be engaged for operations in the carrier environment. This function is useful when NWS HI is desired but wingfold is not, e.g., dearming wingtip missiles after carrier arrestment.

With the wings spread and locked, wingfold is commanded by placing the WINGFOLD switch to FOLD. In order for the wings to unlock, ground power must be applied **or** the aircraft must be WonW (left main). The initial FOLD command electrically unlocks the wings (beer cans extended, WING UNLK caution displayed) and fairs the ailerons. When the FCCs determine that (1) weight is on wheels, (2) airspeed is less than 100 KCAS accelerating or 66 KCAS decelerating, (3) the ailerons are faired, and (4) both wings are unlocked, the FOLD command is sent to the electric drive units to fold the wings. When each wing reaches the completely folded position, power is removed to that electric drive unit

2.9.3 WINGFOLD Switch. The WINGFOLD switch, located on the lower right main instrument panel, is lever-locked in all three positions. The switch has a barrier guard to prevent inadvertent actuation.

FOLD (& unlock)	Unlocks the wings (WING UNLK caution displayed), fairs the ailerons, and, when allowed by the FCCs, folds the wings.
HOLD (& unlock)	Stops wing movement in an intermediate position. If spread, unlocks the wings.
SPREAD (& lock)	Spreads and locks the wings. (WING UNLK caution removed when both wings are locked).

WARNING

Ensure the WINGFOLD switch is lever-locked in the SPREAD position during takeoff checks. If the wings are commanded to unlock or fold during a catapult shot, the wings will unlock, the ailerons will fair, the wings may fold partially, and the aircraft will settle.

2.9.4 Wingfold Overheat Cutout Protection. The wingfold electric drive units are designed to meet the following duty cycle requirements: two (2) fold-spread cycles followed by a twelve (12) minute cooldown period. If wingfold operation exceeds this duty cycle, overheat cutout protection may shutdown wingfold operation to prevent actuator damage. Once overheat cutout protection has been activated, normal wingfold operation is not restored until actuator temperature drops within limits; however, the wings can still be unlocked, folded, or spread manually.

2.10 FCS - FLIGHT CONTROL SYSTEM

The flight control system (FCS) is a fly-by-wire, full authority control augmentation system (CAS). The FCS provides four basic functions: aircraft stability, aircraft control, departure resistance, and structural loads management. Since the basic airframe is statically neutral to slightly unstable, a primary function of the FCS is to maintain aircraft stability at all flight conditions. The FCS also provides full authority control of the aircraft by implementing the basic flight control laws which determine aircraft response to pilot inputs. Pilot inputs from the stick and rudder pedals send electrical commands to two quad-redundant, digital flight control computers (FCC A and FCC B). There is no mechanical linkage between the stick and rudder pedals and the flight control surfaces. FCC software determines what commands are sent to the various flight control surfaces to exercise

pitch, roll, and yaw control of the aircraft. Additionally, the FCS provides departure resistance by either refusing to accept or by tailoring pilot inputs that would otherwise lead to an aircraft departure. Lastly, the FCS provides structural loads management by limiting g-available to prevent an aircraft overstress or by retracting flight control surfaces at airspeeds that would otherwise exceed the structural limits of the airframe. See figure 2-19 for a functional diagram of the flight control system.

2.10.1 Flight Control Surfaces. The aircraft has 12 primary flight control surfaces including leading edge flaps (LEFs), trailing edge flaps (TEFs), ailerons, twin rudders, horizontal stabilators, and spoilers. LEFs, TEFs, ailerons, and stabilators can be moved both symmetrically or differentially for pitch and roll control. Flight control surface deflection limits are shown in figure 2-20.

Pitch control is accomplished with symmetric stabilators and, in some conditions, with rudder toe-in or rudder flare. Roll control is accomplished with combinations of ailerons, differential stabilators, differential LEFs, and differential TEFs dependent on flight condition and CAS operating mode. The twin rudders deflect symmetrically for directional control. There is no dedicated speedbrake surface. Instead, a "speedbrake function" is provided by partial deflection of several of the primary flight control surfaces.

Hydraulic power to all flight control surface actuators is supplied by HYD 1 and HYD 2. Stabilator and TEF actuators are powered simultaneously by one HYD circuit from each system. All other actuators are powered by a single primary HYD circuit, with backup hydraulic power available through a hydro-mechanical switching valve. See the Hydraulic System section, specifically the Hydraulic Flow Diagram, to determine which HYD circuits power each flight control surface actuator.

Surface	Deflection limits *
Aileron	25° TEU to 42° TED
Rudder	40° left or right
Stabilator	24° TEU to 20° TED
LEF	5° LEU to 34° LED
TEF	8° TEU to 40° TED
LEX Spoilers	0° or 60° TEU
* Tolerance $\pm 1^\circ$, or $\pm 3^\circ$ for spoilers.	

Figure 2-19. FCS Surface Deflections

2.10.1.1 Spoilers. The spoilers are mounted on top of the fuselage near the aft end of the LEX. The spoilers are controlled by the FCCs and have two fixed positions: 0° (down) or 60° TEU. The 60° TEU position is activated by the speedbrake function or when more than 15° TED stabilator is commanded (forward stick) above 22° AOA to aid in recovery from high AOA.

2.10.2 FCCs - Flight Control Computers. Two flight control computers (FCC A and FCC B) provide the computations which implement the aircraft's flight control laws. A four-channel architecture is used to provide FCS redundancy. Each FCC contains two individual central processing units (CPUs), which each run one channel of the FCS. CH 1 and CH 2 are resident in FCC A, with CH 3 and CH 4 in FCC B.

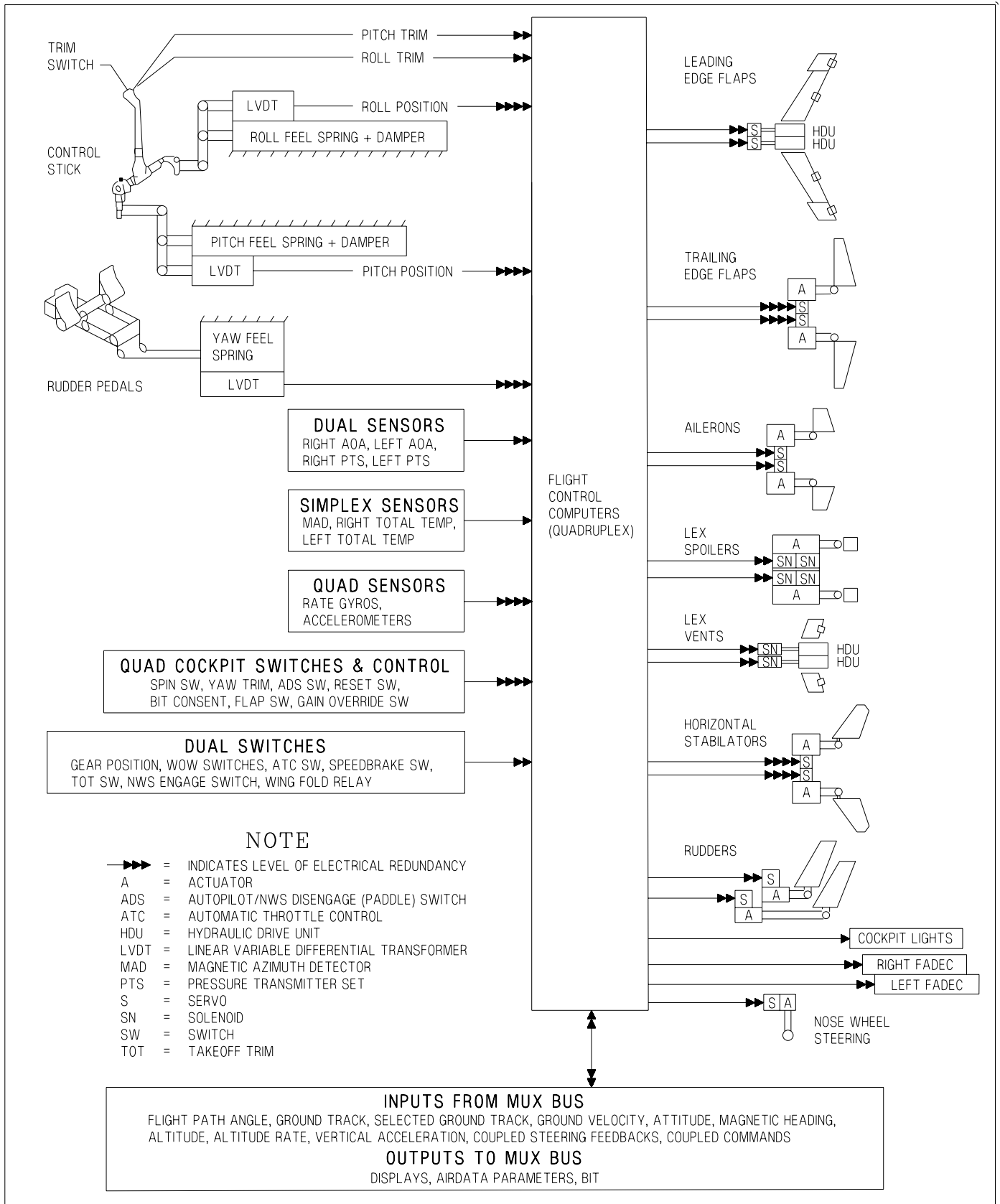

Figure 2-20. Flight Control System Functional Diagram

Most inputs to the FCCs (rate gyros, accelerometers, air data sensors, stick and rudder pedal position sensors) are quad-redundant, one input for each channel. Each of the four CPUs runs independent and parallel flight control computations. Sensor inputs as well as CPU outputs are continuously monitored by the FCCs for agreement. When there is disagreement, the erroneous signal is discarded, if possible.

Rate and acceleration data are provided by two independent Attitude and Heading Reference Sets (AHRS), one for each FCC. Each AHRS has two sets of ring laser rate gyros and two sets of accelerometers, which provide four independent sources of pitch, roll, and yaw rate information, and four independent sources of normal and lateral acceleration. The AHRS units have the capability to provide attitude, heading, and longitudinal acceleration data, but it is not currently utilized. The physical rate and acceleration sensors in each AHRS channel are not aligned with the aircraft's pitch, roll, and yaw axis. This raw sensor data is converted to the aircraft's pitch, roll, and yaw axis by microprocessors internal to each AHRS. As a result of this architecture, a single rate gyro failure in one channel results in all three axis rates being unusable in that same channel (CAS P, R, Y in one channel Xd out). Similarly, if any of the accelerometers fail, all acceleration data from that AHRS channel is unusable (N ACC and L ACC in one channel will both be Xd out).

FCC channel outputs are transmitted to the appropriate flight control actuators and to other aircraft systems such as the MCs. While FCC computations run in all four channels, all flight control actuators are not commanded in all four channels. The stabilators and TEF actuators do receive command signals from all four FCC channels. However, each aileron, rudder, spoiler, and LEF actuator only receives command signals from two FCC channels, one from FCC A and one from FCC B. The 2-channel actuators on the left side of the aircraft receive inputs from CH 1 and CH 4 while the 2-channel actuators on the right side receive inputs from CH 2 and CH 3. This channel distribution can be seen on the FCS format.

2.10.2.1 FCC Temperature Monitoring. FCC A contains a thermocouple which monitors the temperature within the computer and provides a signal to FCC CH 1 and CH 2. If an over-temperature condition is detected, the FCS HOT caution and caution light come on, and the "Flight computer hot, Flight computer hot" voice alert annunciates. Additionally, FCC A indicates OVRHT on the BIT status line. In this case, placing the AV COOL switch to EMERG provides emergency ram air cooling to FCC A and the right TR via a dedicated FCS ram air scoop. FCC B also contains a thermocouple, but does not set the FCS HOT cautions. The only indication of an over-temperature condition in FCC B is a BIT status indication of OVRHT.

2.10.2.2 AV COOL Switch. The AV COOL switch is located on the lower right main instrument panel outboard of the caution light panel.

NORM	FCS ram air scoop retracted.
EMERG	Deploys the FCS ram air scoop for emergency ram air cooling of FCC A, the right TR, and other essential avionics.

Once deployed, the FCS ram air scoop cannot be retracted in flight.

2.10.3 FCS Redundancy and Survivability. Hydraulic redundancy is provided by distributing flight control actuators among the four HYD circuits. This arrangement minimizes the probability of losing multiple actuators due to catastrophic damage to any single actuator or its hydraulic lines. Following a single HYD system failure, the other HYD system is capable of powering the entire FCS. Loss of HYD 1 or HYD 2 in up and away flight does not affect aircraft control. However, in the takeoff and

landing configuration, small but controllable roll and/or yaw excursions may be expected as hydraulic switching valves cycle to their backup circuits.

The primary electrical power source for each FCC channel is a dedicated output from one of two permanent magnet generators (PMGs). See the Electrical System section for FCC Electrical Redundancy. Should a power interruption occur to any single FCC channel, the FCC power supply automatically switches to a "keep alive" circuit connected directly to the maintenance bus for 7 to 10 seconds. This makes sure that the FCCs have uninterrupted power to maintain full operation during all predictable electrical bus switching transients.

For survivability, wiring for one channel from each computer is routed through the upper part of the aircraft with wiring for the other through the lower part of the aircraft. This routing minimizes the possibility of loss of any one flight control surface due to system failures or battle damage. If a stabilator actuator fails due to multiple FCS or hydraulic failures, the FCS automatically reconfigures to maintain 3-axis control and acceptable handling qualities by using the remaining surfaces. There is no mechanical FCS reversion mode.

2.10.4 CAS Operating Modes. The control augmentation system (CAS) operates in two basic modes: Powered Approach (PA) and Up-AUTO (UA). Mode selection is controlled by FLAP switch position and airspeed. With the FLAP switch in HALF or FULL and with airspeed below approximately 240 KCAS, CAS implements flight control laws tailored for the takeoff and landing configuration (PA). With the FLAP switch in AUTO, CAS implements flight control laws tailored for up and away flight (UA). If the FLAP switch is left in HALF or FULL, the aircraft automatically transitions from PA to UA when airspeed increases above approximately 240 KCAS. This is known as "auto flap retract." In this case, the amber FLAPS light comes on to alert the pilot to check FLAP switch position. The flight control laws utilized in each mode are tailored to provide maximum maneuverability while maintaining predictable handling qualities and departure resistance.

2.10.4.1 FLAP Switch. The FLAP switch, located on the lower left main instrument panel, is used to select the CAS operating mode and to position the TEFs and aileron droop for takeoff and landing.

AUTO	Selects UA operating mode for up and away flight.
HALF	Selects PA operating mode for the takeoff and landing configuration. Sets TEF deflection and aileron droop to 30° TED (WonW or at approach speed).
FULL	Selects PA operating mode for the takeoff and landing configuration. Sets TEF deflection and aileron droop to 40° TED (WonW or at approach speed).

2.10.4.2 Flap Position Lights. Three flap position lights, two green and one amber, are located on the lower left main instrument panel. The green HALF and FULL flap lights are used to indicate FLAP switch position and are not indications of actual TEF/aileron position. The FCS format should be referenced to determine actual LEF, TEF, and aileron position.

FLAPS (amber)	FLAP switch in HALF or FULL and airspeed above 240 KCAS (auto flap retract), abnormal flap condition (any flap is off or lacks hydraulic pressure), spin detected by Spin Recovery System, or GAIN switch in ORIDE.
HALF (green)	FLAP switch in HALF and airspeed below 240 KCAS.
FULL (green)	FLAP switch in FULL and airspeed below 240 KCAS.

2.10.5 Control Augmentation System (CAS).

2.10.5.1 Pitch CAS. Pitch CAS (P CAS) utilizes normal acceleration, pitch rate, and AOA feedback, each scheduled based on aircraft flight conditions, to tailor aircraft response to pilot stick inputs and to provide stabilator actuator commands. P CAS operates by comparing aircraft response to the pilot's longitudinal stick input, driving the stabilator actuators symmetrically until the difference is reduced to zero.

In UA, with neutral longitudinal stick, comparing pilot input to aircraft response has the effect of constantly trimming the aircraft to steady-state, hands-off 1g flight, essentially removing the requirement for manual trim. In maneuvering flight, P CAS modifies aircraft response to stick inputs creating the effect of changing stick forces to provide pilot cueing. Actual stick forces for a given stick displacement do not change with flight condition. At high airspeeds, P CAS is a g-command system requiring 3.5 pounds of stick-force-per-g. At medium airspeeds, P CAS acts as a hybrid pitch rate and g-command system. Pitch rate feedback is used to increase apparent stick-force-per-g (heavier stick forces) to cue the pilot that airspeed is decreasing and less g is available. At low airspeed, P CAS is primarily an AOA command system using AOA feedback above 22° AOA to provide increasing stick forces with increasing AOA. With large forward stick inputs, P CAS augments nose-down pitch rates by flaring the rudders and raising the spoilers.

In PA, AOA and pitch rate feedbacks are used to augment inherent airframe pitch damping and stability. P CAS nulls the difference between the commanded AOA and actual AOA. With neutral longitudinal stick, P CAS maintains trim AOA. Unlike UA, pitch trim is required in PA to trim the aircraft on-speed. Rudder toe-in is used to improve longitudinal stability and to aid aircraft rotation during takeoff or bolter. Rudder toe-in is a function of AOA. At 0° AOA or with WonW, the rudders are toed-in 40°. Rudder toe-in decreases linearly to 0° of toe at 12° AOA. Additional AOA feedback is provided above 12° AOA which increases stick forces with increasing AOA to provide stall warning. Pitch rate feedback helps maintain tight pitch attitude control during turns.

2.10.5.2 Roll CAS. Roll CAS (R CAS) schedules aileron, differential LEF, differential TEF, and differential stabilator commands in response to lateral stick inputs to achieve the desired roll characteristics. Roll rate feedback, scheduled based on aircraft flight conditions, is used to augment inherent airframe roll damping. Differential LEFs and TEFs are only used in UA. The LEFs deflect differentially up to 5° when below 25,000 feet and above Mach 0.6. Differential TEFs are not used above 10° AOA or below -5° AOA. At high airspeeds, aileron, differential stabilator and differential TEF travel are reduced to provide consistent roll rate response and to aid in preventing structural loads exceedances. At low airspeeds, aileron and differential stabilator travel are reduced with increasing AOA to minimize adverse yaw. Differential stabilator may also be limited due to pitch commands which have priority over lateral commands.

With clean wing or A/A missile loadings (no wing tanks), maximum roll rate is limited to approximately 225°/second. With A/G store or external fuel tank codes set in the armament computer for any wing station and the pylon rack hooks closed for those stations, maximum roll rate is limited to approximately 150°/second to avoid exceeding pylon structural load limits. If all stores are shown as HUNG, roll rate limiting is removed; however, an R-LIM OFF caution appears on the DDI.

R CAS incorporates two features to reduce pitch-roll inertial coupling induced departures. Based on pitch rate and Mach number, the first feature reduces the roll command when the pilot applies an

excessive combined lateral/longitudinal stick input. The second feature limits the roll command when the aircraft is already rolling and longitudinal stick is moved rapidly. This second feature is removed at low altitude and high speed since available pitch rate does not result in significant pitch-roll inertial coupling.

2.10.5.3 Yaw CAS. Yaw CAS (Y CAS) uses yaw rate and lateral acceleration feedback to provide directional axis damping and to augment pilot commands to the twin rudder actuators. A rolling-surface-to-rudder interconnect (RSRI) adjusted by roll-rate-to-rudder crossfeed (scheduled with AOA), and lateral acceleration feedback are used to minimize sideslip for roll coordination. To provide departure resistance and enhanced maneuverability at high AOA, directional stability is augmented utilizing INS pitch and roll attitudes along with the FCS sensors to synthesize sideslip and sideslip rate feedback to the ailerons and differential stabilators. These lateral surfaces are used in this sense as directional controllers by taking advantage of the strong yawing moments they produce at high AOA.

Below 13° AOA, rudder pedal deflections provide yaw by symmetric rudder deflection. At 25° AOA and above, rudder pedal deflections no longer provide yaw control inputs but instead act entirely as a roll controller (identical to lateral stick input) by commanding aileron and differential stabilator with the RSRI commanding the required rudder deflection for roll coordination. Rudder pedal inputs are summed with lateral stick inputs and this combined input is limited to a value equal to a maximum lateral stick input. Therefore, applying pedal opposite to lateral stick cancels lateral stick inputs proportional to the pedal input, e.g., full opposite pedal cancels a full lateral stick command resulting in zero roll rate. Between 13° and 25° AOA, rudder pedal deflection gradually changes from pure yaw control to pure roll control. This method of control provides enhanced departure resistance at high AOA.

Some traditional directional control capability is returned at low airspeed and high AOA only when the pilot applies lateral stick and rudder in the same direction. This feature starts becoming effective only at airspeeds below approximately 225 KCAS, from 20° to 40° AOA, but is most effective at approximately 170 KCAS and 34° AOA. Enabling this feature outside of these conditions would compromise departure resistance. When this feature is enabled, the sum of lateral stick and rudder pedal command is no longer limited to a value equal to a full lateral stick input. The excess roll command is fed to the directional axis to command sideslip. For example, adding full rudder pedal with a full lateral stick input provides a maximum roll and yaw command. Alternatively, adding lateral stick to an existing full rudder pedal input has the same effect. The resulting aircraft motion is a highly controllable nose-high to nose-low reversal.

At high airspeeds, symmetric rudder deflection is reduced and the rudders are toed in to avoid exceeding vertical tail structural limits.

In PA mode, synthesized sideslip rate feedback augments aerodynamic directional damping and stability.

2.10.5.4 Flap Scheduling. In UA, LEFs, TEFs, and aileron droop are scheduled as a function of AOA and air data to optimize cruise and turn performance, to improve high AOA characteristics, and to provide load alleviation (when required). In general, LEFs start to deflect as AOA increases above approximately 3°, reaching full deflection (34° LED) by about 25° AOA. In general, TEFs start to deflect above 2 to 3° AOA, are at full scheduled deflection (approximately 10 to 12° TED) from approximately 6 to 15° AOA, and begin to retract as AOA increases further. In other words, TEFs are deflected in the heart of the maneuvering envelope to produce more lift and are retracted at high AOA. In UA, aileron droop is scheduled to 50 % of TEF deflection at low AOA and to 0° at high AOA.

In UA, flap scheduling is altered slightly based on the presence of wing tanks. With wing tanks installed, TEF deflection is slightly lower at most flight conditions. LEFs and TEFs typically begin to deflect at slightly slower Mach but follow the same trends as those mentioned above.

In PA, LEFs are scheduled as a function of AOA to maximize lift. TEFs are scheduled as a function of airspeed for load alleviation but should be at maximum scheduled deflection at approach speed. In PA, aileron droop is scheduled with TEF deflection. Following field takeoff or catapult launch, TEF/aileron droop is latched for 10 seconds after the transition to WoffW. This feature is designed to improve catapult launch characteristics by ensuring the flaps do not retract immediately after launch. However, if approximately 190 KCAS is exceeded prior to expiration of the 10 second timer, the TEFs and aileron droop do begin to retract for loads alleviation. LEF, TEF, and aileron droop scheduling are shown in figure 2-21.

FCS Mode	Configuration	Status	LEF Position	TEF Position	AIL Droop
UA	No Wing Tanks	WonW	3° LED	2° TED	1° TED
		WoffW	Scheduled with M, AOA, Alt	Scheduled with M, AOA	50% of TEF (<10° AOA), 0° (>15° AOA)
	Wing Tanks	WonW	3° LED	4° TED	2° TED
		WoffW	Scheduled with M, AOA, Alt	Scheduled with M, AOA	50% of TEF (<10° AOA), 0° (>15° AOA)
PA	Flaps HALF	WonW	15° LED	30° TED	30° TED
		WoffW	Scheduled with AOA	30° TED (on-speed)	30° TED (on-speed)
	Flaps FULL	WonW	15° LED	40° TED	40° TED
		WoffW	Scheduled with AOA	40° TED (on-speed)	40° TED (on-speed)

Figure 2-21. Flap Schedules

2.10.6 Speedbrake Function. The aircraft is not fitted with independent speedbrake surfaces. A "speedbrake function" is provided to increase drag by partial deflection of several of the aircraft's primary flight control surfaces: ailerons, rudders, TEFs, and spoilers. The stabilators are commanded to counter pitch transients during speedbrake extension and retraction. The full speedbrake function can only be commanded in UA.

At subsonic speeds in UA, the speedbrake function flares the rudders and symmetrically raises the ailerons TEU to approximately 95% of the capability of each surface at the given flight conditions. This makes sure approximately 5% of surface authority is available for yaw and roll control. If needed, rudder and aileron priority is given to yaw and roll commands. TEFs are also symmetrically lowered to further increase drag and to counter the loss of lift caused by deflecting the ailerons TEU. The spoilers are raised to the full up 60° position only when the speedbrake command reaches 75%. At subsonic speeds, the stabilator is used to offset any pitch transients that occur due to the deflection of all speedbrake surfaces except the spoiler. Delaying spoiler deflection until 75% allows the pilot to use partial speedbrakes for speed modulation, while avoiding minor spoiler induced pitch transients.

At supersonic speeds in UA, speedbrake surface deflections are changed. The rudders are not deflected above 1.05 M due to vertical tail loads. The ailerons and TEFs are not deflected above 1.1 M due to a lack of effectiveness. The spoilers are therefore deflected immediately upon speedbrake actuation, since they are the only effective surface at these conditions. At supersonic speeds, the stabilator is used to counter spoiler deployment. The speedbrake function is completely disabled above 1.5 IMN.

In UA, the speedbrake function is ramped out above 16° AOA or below -9° AOA to preserve lateral-directional stability and between -3.0 to -1.5g for airframe loads.

In PA, the speedbrake function is disabled with WoffW. With WonW and the FLAP switch in HALF or FULL, the speedbrake function only deploys the spoilers. While the spoilers can be deployed during landing rollout or aborted takeoff, the drag increase is minimal, and rollout distance is not appreciably decreased. With WonW and the FLAP switch in AUTO, full extension of the speedbrake function commands 20° of rudder flare, 23° of TEU aileron, 7° of TED TEF, 60° of spoiler, and a 2° TED stabilator change.

2.10.6.1 Speedbrake Switch. The speedbrake switch, located on the inboard side of the right throttle grip, is used to enable/disable the speedbrake function, e.g., extend/retract the speedbrake surfaces. The forward and center positions are detented, while the aft position is spring-loaded back to center and must be held. In the F/A-18F (trainer configuration), the rear cockpit speedbrake switch has override priority over the front cockpit switch.

Forward (unmarked)	Retracts speedbrake surfaces (full retraction in 2 seconds).
Center (unmarked)	Stops speedbrake surfaces at an intermediate position.
Aft (unmarked)	Extends speedbrake surfaces (full extension in 2 seconds).

NOTE

- If the speedbrake switch is held or fails in the aft position for more than 5 minutes, the speedbrake switch is declared failed, and the FCS caution is set. If the switch is failed or is held in the aft position when the FCS RESET button is pushed, the speedbrake surfaces are retracted, Xs are set on the DEGD row of the FCS page, and the speedbrake function is disabled for the remainder of the flight.
- If the front cockpit switch is held in the aft position during any FCS RESET attempt, the speedbrake switch is declared failed; the speedbrake surfaces are retracted; and the speedbrake function is disabled for the remainder of the flight. This allows the speedbrake surfaces to be retracted before the 5 minute timer expires, if the front cockpit switch is stuck in the aft position.
- In the F/A-18F (trainer configuration), if the rear cockpit switch fails in the aft position, the 5 minute timer must expire before the speedbrake surfaces can be retracted with the FCS RESET button.

2.10.6.2 SPD BRK Light. The green SPD BRK light is located on the left warning, caution, and advisory panel on the main instrument panel. The SPD BRK light comes on anytime the speedbrake surfaces are not fully retracted.

2.10.7 G-Limiter Considerations. In order to understand what protection the aircraft's g-limiter provides, pilots must understand the difference between "design limit-g" and "reference load factor (Nz REF)." See the Acceleration Limitations chart in the Operating Limitations chapter for a plot of Nz REF versus gross weight, for g-limiter specifics, and for gross weight related g-restrictions.

2.10.7.1 Design Limit-g. The aircraft was designed to sustain a limit-g of +7.5g or -3.0g (symmetric) only at or below its fighter design gross weight of 42,097 lb. At higher gross weights, design limit-g is reduced to keep from exceeding the structural limitations of the airframe. An "overstress" is defined as a g-level that exceeds the design limit-g at the aircraft's current gross weight. Above 42,097 lb gross weight, design limit-g is reduced by the aircraft's relative gross weight (42,097/GW), such that the positive design limit is $+7.5g * (42,097/GW)$ and the negative design limit is $-0.4 * (\text{positive limit-g})$. At the aircraft's maximum gross weight (66,000 lb), design limit-g is only +4.8g or -1.9g.

Due to the increased airframe and pylon loads that accompany high-g rolling maneuvers, the aircraft also has a design limit-g for abrupt full-stick rolls (FSR). Abrupt FSRs are defined as full lateral stick in less than 1 second. The positive design FSR limit is +6.0g below 42,097 lb GW and 80 % of the symmetric design limit-g above 42,097 lb. The negative design FSR limit is -1.0g at all gross weights. At 66,000 lb GW, the positive design FSR limit is only +3.8g.

2.10.7.2 Reference Load Factor (Nz REF). Reference load factor (Nz REF) is the value that the MC uses to set the g-limiter when outside of the transonic g-bucket (described below). With increasing gross weight, Nz REF is the same as design limit-g until the gross weight where +5.5g (-2.2g) is available (57,405 lb GW). Above 57,405 lb GW, Nz REF is held fixed at +5.5g (-2.2g) in order to assure that the pilot always has those g-levels available even if they would result in an overstress. Since the g-limiter may not prevent an overstress at gross weights above 57,405 lb, the pilot must be responsible for preventing an overstress in this gross weight region.

2.10.7.3 G-Limiter. The g-limiter essentially limits the amount of positive and negative g that can be commanded by the pilot at a particular gross weight in order to prevent an aircraft overstress. Once the pilot reaches the stick displacement required to attain the Nz REF g-limit, further stick inputs do not increase g. This is commonly called "being on the limiter." Once the stick is relaxed to the limit displacement, g-control below Nz REF is regained. The g-limiter functions to maintain both the positive and negative Nz REF limits.

During abrupt longitudinal stick inputs, g-limiter overshoots are not uncommon. G-limiter overshoots of up to +0.5g or -0.2g are allowed and do not constitute an over-g. An "over-g" is defined as a g-level which exceeds the overshoot thresholds and sets MSP code 811 (positive exceedance) or 925 (negative exceedance). An over-g condition requires a postflight inspection to determine if an "overstress" occurred.

For rolling maneuvers commenced above the positive FSR limit, the g-limiter also provides some protection. In this region, the g-limiter attempts to reduce commanded-g towards the positive FSR limit to prevent an overstress. However, if the rate of lateral stick input exceeds the capability of the g-limiter, an actual rolling overstress may result without setting an 811 MSP code (set only if the symmetric over-g threshold is exceeded). The g-limiter treats rolling maneuvers with less than $\frac{3}{4}$ inch lateral stick as symmetric maneuvers.

A G-LIM 7.5G caution, accompanied by the FLIGHT CONTROLS, FLIGHT CONTROLS voice alert, is set for any of the following: FUEL XFER, CAUT DEGD, MC2, SMS failure, or an invalid fuel quantity. A G-LIM 7.5G caution indicates that the positive symmetrical command limit has been set to +7.5g regardless of gross weight or stores loading. If the G-LIM 7.5G caution is set, the pilot must limit commanded g-level to prevent an overstress.

WARNING

Very high g-onset rates are possible with rapid aft stick movement, with or without g-limiter override. A very high g-onset rate can cause immediate loss of consciousness (G-LOC) without the usual warning symptoms of tunnel vision, greyout, and blackout. The effects of G-LOC may last 20 seconds or longer after the g level is reduced to near 1.0g.

2.10.7.4 G-Bucket. Due to the aerodynamic phenomenon known as transonic pitch-up, the g-limiter incorporates a g-bucket designed to prevent an aircraft positive over-g during transonic deceleration. In the g-bucket, the g-limiter reduces the positive command g-limit below Nz REF (figure 2-22). This reduction is a maximum of 1.0g above 20,000 feet, and 1.7g below 15,000 feet. For example, if Nz REF is +7.5g and altitude is $\leq 15,000$ feet, the g-limiter only allows +5.8g to be commanded while in the g-bucket. The symmetrical command limit is never reduced below +4.5g.

NOTE

- G-bucket reduction reduces maximum commandable-g.
- Magnitude of transonic pitch-up increases as rate of Mach change increases. High drag loadings with idle power settings generally have the largest transonic pitch-ups. High drag loadings (e.g., A/G stores) have a g-bucket that extends into a lower Mach range.
- Largest measured transonic pitch-up was 2.2g for $< 15,000$ feet. This magnitude pitch-up was seen on both A/A and A/G loadings.

The 0.2g deep mini-g-bucket extension in the Mach 0.85 to Mach 0.94 range was added in the FCC OFP to protect against over-g in that region.

The Mach range for the deeper part of the g-bucket is dependent on external stores configuration. The deeper part of the g-bucket is entered at Mach 0.905 accelerating (with at least one wing tank or A/G wing store) or at Mach 0.941 accelerating with no wing tanks or A/G stores. Regardless of stores loading, when decelerating, the g-bucket is entered at Mach 1.045 and is exited at Mach 0.83.

Full stick roll (FSR) limits are reduced in the g-bucket to 80 % of (Nz REF minus no more than a 1.0g reduction). For example, if Nz REF is +7.5g, Mach is 0.95, and altitude is $\leq 15,000$ feet, the g-limiter sets the FSR limit to 80 % of (Nz REF minus 1.0) even though the bucket depth is 1.7g.

If the pilot wants to have maximum-g available during a turning maneuver (e.g., the merge), or avoid the deeper part of the g-bucket, IMN should be 0.90 or less (with at least one wing tank or A/G store), or 0.93 or less (clean or with A/A stores). Note that even though the 0.2g mini-g-bucket might be active, flight testing has shown the g-level will be at or slightly above Nz REF.

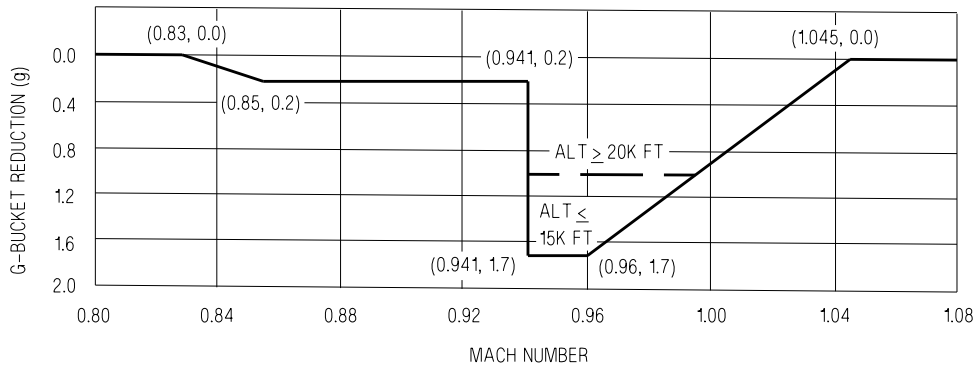

1. G-BUCKET WHILE ACCELERATING WITHOUT ANY WING TANKS OR A/G STORES

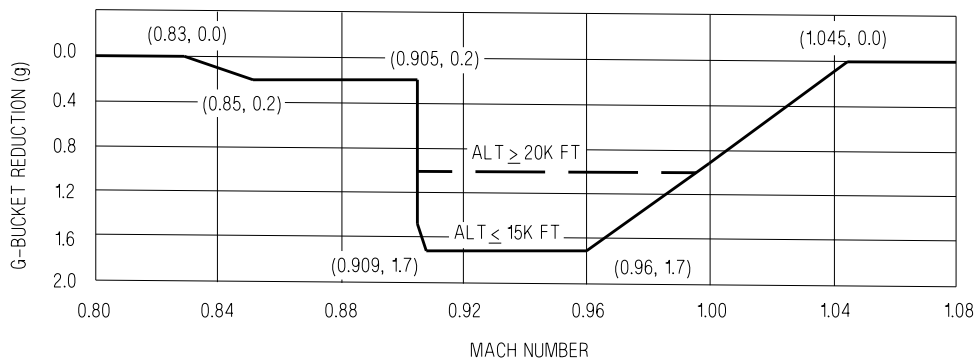

2. G-BUCKET WHILE ACCELERATING WITH AT LEAST ONE WING TANK OR A/G WING STORE

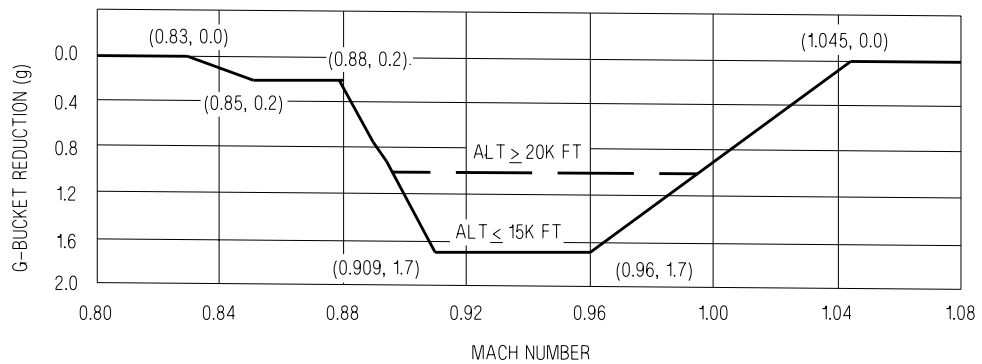

3. G-BUCKET DURING DECELERATIONS FOR ALL LOADINGS

Figure 2-22. G-Limiter G-Bucket Reductions in Maximum Commandable G-Level

2.10.7.5 G-Limiter Override. A g-limiter override feature can be enabled to allow a 33% increase in the command g-limit for emergency use (allows a 10g command at 7.5g Nz REF). G-limiter override is selected by momentarily pressing the paddle switch when the stick is near the full aft limit. When g-limiter override is selected, a G-LIM OVRD caution is set along with a 927 MSP code. Override is not disengaged until the stick is returned to near the neutral position.

2.10.7.6 Roll Rate Limiting. Roll rate limiting is enabled in R CAS when external wing tanks or A/G stores are mounted on wing pylons (hooks closed). If any A/G store indicates HUNG, a R-LIM OFF caution is set and roll rate limiting is removed. In this case, higher than normal roll rates are possible and may exceed the structural limitations of the airframe/pylons if pilot-imposed lateral stick limits are not applied.

2.10.8 Air Data Function. The air data function is provided by the FCCs and not a separate computer. The FCCs receive input from pitot-static sensors, total temperature sensors, the angle of attack probes, the standby altimeter barometric setting, and the mission computers. The FCC air data function applies appropriate source error corrections to the air data sensor inputs and calculates accurate true altitude, airspeed, Mach number, AOA, and outside air temperature (OAT). Computed air data is used internally by the FCC control augmentation system (CAS) and is also supplied to the MCs for IFF altitude reporting, weapon system calculations, and landing gear wheels warning, to the FADECs for engine control, and to the ECS controller for ECS scheduling and fuel tank pressurization and vent.

2.10.8.1 Pitot-Static/Total Temperature Probes. Two combined pitot-static/total temperature probes are mounted on the left and right forward fuselage. Each probe contains one pitot pressure source, two static pressure sources, and a total temperature sensor. One of the static pressure sources from each probe is connected together and pneumatically averaged. This average static source is provided to the left and right pressure transmitter sets along with the corresponding pitot pressure source. The left pressure transmitter set provides pitot-static input to FCC CH 1 and 4 with the right providing input to FCC CH 2 and 3. The FCC air data function corrects sensed pitot and static pressures for position error to provide accurate true air data for FCC calculations, MC calculations, and display in the HUD. The pitot pressure source and the second static pressure source from the left probe are used to drive the standby flight instruments (altitude, airspeed, and VSI). The second static pressure source from the right probe is unused.

Each pitot-static probe also contains an integral total temperature sensor. Each total temperature sensor converts sensed temperature to an electrical signal. The output of the left total temperature sensor is sent to FCC CH 2, with the right to FCC CH 4. The FCCs use total temperature to calculate OAT. Each pitot-static/total temperature probe is electrically heated to prevent icing.

2.10.8.2 AOA Probes. Two AOA probes are mounted on the left and right forward fuselage. Each probe mechanically measures local AOA by aligning with the airstream. An integral AOA transmitter set converts the mechanical input to a two-channel electrical signal which is sent to the FCCs. The left AOA transmitter set provides input to FCC CH 1 and 4 with the right to FCC CH 2 and 3. The FCC air data function corrects the sensed local AOA to a true AOA and provides the output to the MC for display on the HUD. FCC CH 4 supplies the AOA signal which drives the AOA indexer lights and the approach lights.

It is possible to damage and jam an AOA probe such that it continues to send signals to the FCCs. FCC software is designed to minimize flying qualities degradation in the event of a stuck/jammed AOA probe. The FCCs incorporate an AOA estimator which is used to identify the good AOA probe if one is damaged. If an AOA probe split is transient, the estimator is used to identify the good probe and no

cautions are set. If the AOA probe split persists, an FCS caution is set, AOA is Xd in all four channels, and the estimator is used for FCC calculations. See the HUD Symbology Degrades with Air Data Function Failure paragraph and Part V for more details on AOA failures. Each AOA probe and AOA probe cover are electrically heated to prevent icing.

2.10.8.3 PITOT ANTI ICE Switch. The PITOT ANTI ICE switch is located on the ECS panel on the right console. This switch is used to power the electric heaters for the pitot-static/total temperature probes, the AOA probes, and the AOA probe covers. All heaters are thermostatically controlled to prevent damage to their corresponding sensors. With WonW, the thermostat set points are reduced to prevent damage when cooling airflow is not provided.

- ON Pitot and AOA heaters on manually (WonW or WoffW).
- AUTO Pitot and AOA heaters on automatically with WoffW. Heaters off with WonW.

WARNING

Failure of both AOA probe heaters in icing conditions may cause a sharp uncommanded nose down attitude, uncontrollable by normal stick forces or paddle switch actuation.

2.10.9 Flight Controls.

2.10.9.1 Stick. A traditional center mounted control stick is used to provide pitch and roll inputs to the FCS. Since there is no mechanical linkage between the stick and the FCCs or the flight control surfaces, stick feel is provided by two feel-spring assemblies and two eddy current dampers. The feel spring assemblies provide a linear stick force versus stick displacement gradient in each axis. Two 4-channel position sensors, one in each axis, measure stick displacement and send longitudinal and lateral stick commands to the FCCs proportional to stick displacement. Stick force and displacement are listed in figure 2-23 for full stick travel. The eddy current dampers provide stick motion damping in each axis. Additionally, the control stick is mass balanced to minimize longitudinal stick movement resulting from accelerations normally experienced during catapult launch.

In the F/A-18F (trainer configuration), a control stick is also fitted in the rear cockpit and is mechanically linked to the one in the front cockpit.

	Direction	Displacement (in)	Force (lbs)
Stick	Forward	2.5	20
	Aft	5.0	37
	Left/Right	3.0	13
Pedal	Left/Right	1.0	100

Figure 2-23. Stick and Pedal Travel Limits

2.10.9.2 Rudder Pedals. Two rudder pedals (left and right) are used to provide directional inputs to the FCS for yaw/roll control inflight or NWS control with WonW. Since there is no mechanical linkage

between the rudder pedals and the FCCs or the flight control surfaces, rudder pedal feel is provided by two feel-spring assemblies. The feel spring assemblies provide a linear pedal force versus displacement gradient. Two 4-channel position sensors, one on each pedal, measure pedal displacement and send directional commands to the FCCs proportional to pedal displacement. Rudder force and displacement are listed in figure 2-23 for full pedal travel. The rudder pedals are also used to provide NWS commands and to actuate toe-operated wheel brakes.

In the F/A-18F (trainer configuration), two rudder pedals are also fitted in the rear cockpit but are not mechanically linked to the rudder pedals in the front cockpit. Pedal inputs from either cockpit are summed together and transmitted to the FCCs. A half pedal input from the front cockpit and a half pedal input from the rear cockpit results in a full rudder pedal command to the FCCs. Similarly, opposing rudder pedal inputs in each cockpit cancel each other.

2.10.9.2.1 RUD PED ADJ Lever. A RUD PED ADJ lever, located on the center pedestal in each cockpit, is spring loaded to the up and locked position. When the lever is held down, the rudder pedals are unlocked and can be moved forward and aft in ½ inch increments. Both pedals are spring loaded to move aft and must be pushed forward to the desired position. Releasing the RUD PED ADJ lever locks the pedals in the new position.



- Restrain the rudder pedals during adjustment. Unrestrained rudder pedals may damage the rudder pedal mechanism.
- Ensure the rudder pedals are locked in position after adjustment. Failure to lock the rudder pedals may result in uncommanded forward rudder pedal movement inflight.

2.10.9.3 Stick Grip FCS Controls. The FCS controls located on the stick grip include the pitch and roll trim switch, the NWS button, and the autopilot/NWS disengage switch. See figure 2-24. In the F/A-18F (trainer configuration), the FCS controls on the rear cockpit stick grip are identical to those in the front cockpit.

2.10.9.3.1 Pitch and Roll Trim Switch. The pitch and roll trim switch is located on the top right of the stick grip. Movement of the pitch and roll trim switch electrically biases the FCCs and does not reposition the stick.

Forward	Trims nose-down.
Aft	Trims nose-up.
Left	Trims left-wing-down.
Right	Trims right-wing-down.

Pitch and roll trim inputs can be made incrementally or held for faster trim rates. In UA, little if any pitch trim is required due to the automatic trimming function provided by P CAS. In PA, pitch trim is required to trim for on-speed AOA. Lateral trim is typically only required immediately after takeoff or following changes in lateral weight asymmetry (fuel and/or stores). Pitch trim is not monitored for

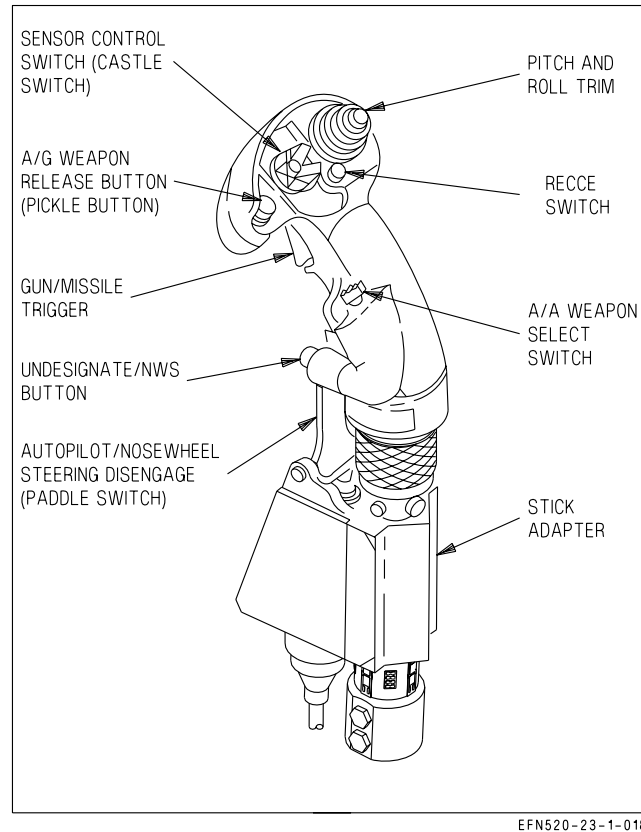

Figure 2-24. Stick Grip FCS Controls

runaway trim. However, roll trim is monitored for a stuck switch. If the trim switch is held or is stuck in the left or right position for more than 40 seconds, the FCS caution is set and the roll trim function of the switch is disabled for the remainder of the flight. Roll trim can be faded to zero by pushing and holding the FCS RESET button or TO/TRIM button for approximately 4 seconds.

2.10.9.3.2 NWS Button. The undesignate/nosewheel steering button is located on the front of the stick grip. The NWS button is used to engage NWS modes, as described in the NWS System paragraphs in the Utility Hydraulic Functions section. The undesignate function of the NWS button is described in the Weapon Systems Controls section.

2.10.9.3.3 Paddle Switch. The autopilot/NWS disengage switch, commonly called the “paddle switch,” is located on the lower front of the stick grip. The paddle switch is used to disengage NWS with WonW, to disengage all autopilot modes with WoffW, and to enable g-limiter override with WoffW. To enable g-limiter override, the paddle switch must be momentarily pressed with the stick near the aft limit.

2.10.9.4 RUD TRIM Knob. The RUD TRIM knob is located on the FCS panel on the left console in the front cockpit only. Movement of the RUD TRIM knob electrically biases the FCCs and does not reposition the rudder pedals. Rudder trim authority is $\pm 10^\circ$ and $\pm 22.5^\circ$ of rudder surface deflection in UA and PA, respectively. PA rudder trim authority is set to allow zero pedal forces during a HALF flap, single engine approach. Yaw trim is zeroed by mechanically centering the RUD TRIM knob when the T/O TRIM button is pushed with either WonW or WoffW.

2.10.9.5 T/O TRIM Button. The T/O trim button is located in the center of the RUD TRIM knob on the FCS panel on the left console. With WonW, holding the T/O TRIM button pressed drives pitch trim to 4° TEU stabilator, roll trim to neutral, and yaw trim to neutral by mechanically centering the RUD TRIM knob. Depending on initial trim position the T/O TRIM button may need to be pressed for up to 4 seconds. When these takeoff trim settings are reached, the TRIM advisory is displayed on the LDDI for as long as the T/O TRIM button is held depressed. With WoffW, pressing the T/O TRIM button for as long as 4 seconds drives roll trim to neutral, centers the RUD TRIM knob, but does not affect pitch trim.

2.10.10 Yaw Rate Warning Tone. In UA (flaps AUTO), a yaw rate warning tone is provided to alert the pilot of excessive yaw rate that may lead to an aircraft departure. The yaw rate warning tone is generated by the FCCs and is initiated at 40°/second yaw rate with a 1 Hz pulse rate. The tone pulse rate increases linearly as yaw rate approaches 60°/second, where the pulse rate remains constant at 10 Hz. There is no yaw rate warning tone in PA.

2.10.11 AOA Warning Tone. An AOA warning tone is provided to alert the pilot of excessive AOA that may lead to aircraft settle and/or departure.

With flaps HALF or FULL, the AOA warning tone is triggered at 14° AOA with a 1 Hz pulse rate. The tone pulse rate increases linearly as AOA approaches 35°, where the pulse rate remains constant at 10 Hz.

With MC OFP H3E AND UP, with flaps AUTO, the AOA warning tone is triggered when the AOA limits corresponding to the FLY lateral weight asymmetry are exceeded. A 500 ft-lb buffer is applied to the lateral weight asymmetry threshold when triggering the tone to account for fuel slosh. If there is an AOA failure, or more than one fuel quantity is invalid and/or weapon station indicates HUNG on stations 2 – 10 (FLY value removed), the tone will not be triggered and the AOA TONE caution will be displayed.

2.10.12 Spin Recovery System. The aircraft incorporates an automatic spin detection and recovery system. A spin is declared when both of the following conditions are met: (1) airspeed is below approximately 120 ±15 KCAS and (2) the yaw rate threshold is exceeded. The yaw rate threshold is exceeded, for example, if a 15 to 20°/second yaw rate persists for approximately 15 seconds or a 50 to 60°/second yaw rate persists for approximately 2 seconds. For cases where the pilot is intentionally commanding a high AOA roll (e.g., pirouette) the yaw rate threshold persistence is increased from 15 seconds to 25 seconds.

Immediately following a low-speed maneuver less than 77 KCAS (e.g., tail-slide), airspeed limits for SPIN logic are opened to 180 KCAS or 12 seconds, whichever comes first. During this time, the normal acceleration feedback gain is removed to avoid excess coupling, and spin mode arrows will be displayed to aid recovery if yaw rate exceeds the threshold.

Once a spin has been detected, the spin recovery system places the SPIN MODE recovery displays on both DDIs (figure 2-25), illuminates the amber FLAPS light, and drives the LEFs to 34° LED and the TEFs to 4° TED. The displayed spin recovery arrow always indicates the proper direction for anti-spin lateral stick inputs whether the spin is upright or inverted. Anti-spin lateral stick inputs are aileron-into for upright spins and aileron-opposite for inverted spins. When lateral stick is placed with the arrow, automatic spin recovery mode (ASRM) is engaged. With ASRM engaged, all CAS feedback and control surface interconnects are removed, providing full aileron, rudder, and stabilator authority for spin recovery. If the stick is neutral or is moved in the wrong direction, the SPIN MODE formats remain displayed, the LEFs and TEFs remain deflected, but the FCS remains in CAS, and ASRM is not engaged.

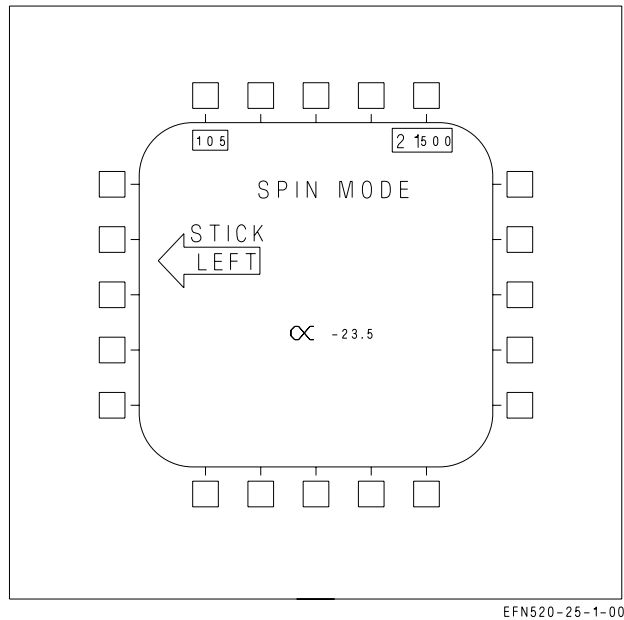

Figure 2-25. SPIN Recovery Display

If ASRM is engaged during spin recovery, the spin arrow is removed and the FCS automatically reverts to CAS when either of the following conditions are met: (1) airspeed is above approximately 245 KCAS or (2) the yaw rate threshold is no longer exceeded. After recovery, LEFs and TEFs return to normal scheduling, and the SPIN MODE formats are replaced with the MENU page after 2 seconds.

NOTE

During highly oscillatory spins or spins that transition from upright to inverted or from inverted to upright, the SPIN MODE displays may disappear momentarily.

2.10.12.1 Spin Recovery Displays. When the spin recovery system detects an upright left spin or an inverted right spin, a left spin arrow appears on both DDIs to indicate the proper direction of the anti-spin lateral stick input.



When the spin recovery system detects an upright right spin or an inverted left spin, a right spin arrow appears on both DDIs to indicate the proper direction of the anti-spin lateral stick input.

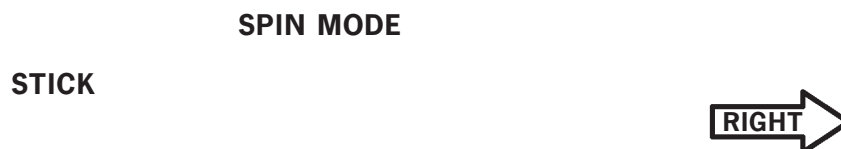

When lateral stick is placed in the direction of the arrow, the word "ENGAGED" appears below the words "SPIN MODE" on both DDIs to indicate that ASRM has been successfully engaged.

SPIN MODE

is replaced by

SPIN MODE ENGAGED

When the SPIN MODE formats appear on the DDIs, airspeed is always displayed in the upper left corner, with altitude in the upper right and AOA in the lower center. See figure 2-23.

2.10.12.2 SPIN Switch. The SPIN switch is located on the right side of the main instrument panel. The switch is guarded to prevent actuation. The SPIN switch was designed to allow for activation of a manual spin recovery mode (MSRM). However, with all CAS feedback and control surface interconnects removed, flight in MSRM will result in a departure and, once departed, will prevent departure and/or spin recovery. SPIN arrow logic and ASRM functionality have been optimized and thoroughly flight tested to produce accurate spin mode detection and positive spin recovery.

RCVY	Prohibited.
NORM	ASRM available when a spin is detected.

WARNING

Selection of manual spin recovery mode (SPIN switch in RCVY) seriously degrades controllability, will prevent recovery from any departure or spin, and is prohibited.

2.10.13 Stabilator Failure Control Law Reconfiguration. Stabilator reconfiguration consists of additional control laws which augment baseline CAS control laws to compensate for the complete loss of a single stabilator. Stabilator reconfiguration is automatically enabled following the detection of a complete stabilator failure (3 or more FCS Xs in a single stabilator or a dual HYD circuit failure - HYD 1B/2A or 1A/2B). If hydraulics are intact, the failed stabilator is driven to 2° TEU and locked. Following a dual HYD circuit failure, the failed stabilator must be driven to the locked position by aiding airloads. If unaiding airloads are applied, actuator mechanization prevents the stabilator from moving further away from the locked position.

The reconfigured control laws are designed to compensate for the loss of the pitch and roll contribution of the failed stabilator. In the pitch axis, pitch commands to the remaining stabilator are doubled to produce more pitching moment. In PA, rudder toe-in and rudder flare are also used to aid the pitching moment capability of the remaining stabilator. In the roll axis, differential stabilator commands are disabled. A stabilator-to-rolling-surface interconnect is used to compensate for the roll generated by single stabilator movement. In PA, this interconnect is stabilator to aileron. In UA, it is stabilator to aileron and differential TEF. At high airspeed in UA, differential LEFs are also used. In the yaw axis, the baseline differential stabilator portion of the RSRI continues to be used to counter the yaw generated by single stabilator movement.

2.10.14 GAIN ORIDE. GAIN ORIDE allows the pilot to select a set of fixed CAS gains when an FCS malfunction prevents normal CAS gain scheduling (e.g., loss of AOA or pitot-static data). With the GAIN switch in ORIDE, the FCCs use fixed values for speed, altitude, and AOA depending on the position of the FLAP switch. These fixed gains cause the LEFs, TEFs, and aileron droop to be driven

to the fixed positions shown in figure 2-26. GAIN ORIDE should generally provide acceptable handling qualities at flight conditions which approximate the fixed gains. At flight conditions that deviate from the fixed gains, a slight degradation in handling qualities should be expected. Refer to chapter 11 for details. The aircraft stalls at a lower than nominal AOA since the LEFs are fixed. Transition to or from the landing configuration should be performed at 180 KCAS. For best results, maintain on-speed AOA during the approach and landing.

Flight with GAIN ORIDE selected is prohibited above 10° AOA or above 350 KCAS (flaps AUTO), 200 KCAS (flaps HALF), or 190 KCAS (flaps FULL) to ensure control system stability and to reduce the potential for departure. When GAIN ORIDE is selected, the amber FLAPS light comes on along with either the CRUIS advisory (flaps AUTO) or the LAND advisory (flaps HALF or FULL). Alpha tone is disabled in GAIN ORIDE.

FLAP Switch	LEF (°LED)	TEF (°TED)	AIL Droop (°TED)	Fixed Gains			
				Mach	KTAS	Feet	°AOA
AUTO	5	4	2	0.80	459	39,000	3.5
HALF	21	30	30	0.23	151	500	8.1
FULL	21	40	40	0.21	139	500	8.1

Figure 2-26. GAIN ORIDE Flap Positions and Gain Schedules

2.10.14.1 GAIN Switch. The GAIN switch, located on the FCS panel on the left console, is used to select GAIN ORIDE. The switch is guarded in the NORM position to prevent inadvertent actuation.

ORIDE Selects fixed CAS gains according to FLAP switch position.

NORM Selects normal CAS gain scheduling.

2.10.15 FCS Failures. The FCS detects failures through three types of BIT: initiated (IBIT), periodic (PBIT), and maintenance (MBIT). FCS IBIT is performed during Before Taxi Checks to run a thorough test of the system prior to flight. PBIT is a less thorough test of the FCS and runs continuously when other BITs are not running. MBIT is typically run by maintenance personnel and is the most comprehensive test of the FCS.

FCS failures are annunciated by any or all of the following indications: the FCS caution, the FCES caution light, the "Flight controls, Flight controls" voice alert, FCS format Xs, and/or BIT Logic Inspection (BLIN) codes. FCS format Xs and BLIN codes identify the location and type of failure. However, not all FCS related components/functions are covered by Xs on the FCS format matrix. For such components/functions, valid BLIN codes may be the only indication of the location of the failure. Therefore, until the nature of the failure is determined, BLIN codes that appear without Xs should be treated with the same level of concern as those that do.

Typically, BLIN codes that have three digits or less are generated by PBIT, e.g., 341. Four digit and five digit BLIN codes are generated by FCS IBIT, e.g., 4573 and 10165.

2.10.15.1 FCES Caution Light. The Flight Control Electronic Set (FCES) caution light is located on the lower right caution lights panel. The primary purpose of the FCES caution light is to alert aircrew

of critical FCS related failures when MC1 is failed. When MC1 is failed, the normal DDI FCS related cautions are not generated and the FCS format is not available for troubleshooting. When MC1 is operative, the FCES caution light is merely a secondary indication of an FCS related failure. The specific FCS cautions which also trigger the FCES caution light are listed in figure 2-27.

2.10.15.2 FCS RESET Button. The FCS RESET button is located on the FCS panel on the left console. This button is used to perform several FCS related functions. Following detection of FCS related hardware and/or software failures (e.g., FCS Xs and/or BLIN codes), pressing the FCS RESET button commands a reset of FCC failure detection circuitry. If the FCS related failure was momentary and no longer exists, an FCS RESET (a) restores the failed actuator/component, (b) removes all FCS failure indications (FCS caution, FCES caution light, and Xs; preflight BLIN codes only), and (c) displays the RSET advisory for 10 seconds to indicate a successful reset. If the failure remains (a) the failed actuator/component is not restored, (b) the FCS failure indications return, and (c) the ~~RSET~~ advisory is displayed for 10 seconds to indicate an unsuccessful reset. In other words, **the FCS RESET button does not fix a detected failure; it merely allows components to be restored and failure indications to be removed, if and only if the failure no longer exists.**

Prior to takeoff (cycle to WoffW), a successful FCS RESET automatically clears all BLIN codes. Inflight or post-flight, however, BLIN codes are not automatically cleared with a successful FCS RESET in order to preserve this data for maintenance troubleshooting. Inflight and post-flight BLIN codes can be cleared, if desired, by pushing the FCS RESET button simultaneously with the paddle switch.

Additionally, the FCS RESET button is used in conjunction with the FCS BIT consent switch to enter the FCS exerciser mode.

2.10.15.3 FCS Exerciser Mode. The FCS exerciser mode is incorporated to aid hydraulic system warming during cold weather starts. The exerciser mode allows hydraulic fluid and hydraulic seals to warm towards normal operating temperatures without making large surface movements. Large surface movements with a cold hydraulic system can result in hydraulic seal damage, leaks, and loss of fluid. On the ground, the FCS exerciser mode is initiated by simultaneously holding the FCS BIT consent switch in the ON position while pressing the FCS RESET button. When initiated, the mode cycles the stabilators, flaps, ailerons, and rudders through 20% of full travel for 10 cycles in 20 seconds. The operation can be stopped prior to 20 seconds by pressing the paddle switch.

During cold weather starts, avoid activating any hydraulic actuated system for two minutes after both engines are online. This allows hydraulic fluid to warm both systems and prevents hydraulic seal damage and potential hydraulic leaks. If the aircraft has not flown within 4 hours with ambient temperatures below -18°C (0°F), up to three selections of the FCS exerciser mode may be required in order to obtain a successful FCS RESET (after the initial 2 minute warmup).



In standard or warm conditions, do not initiate the FCS exerciser mode multiple times in an attempt to get a successful FCS RESET. In such conditions, multiple initiations may excessively elevate hydraulic system temperatures, increasing actuator and hydraulic pump seal wear and potentially decreasing component life.

2.10.15.4 FCS BIT Consent Switch. The FCS BIT consent switch is located above the right console beneath the right canopy sill. The switch is used in conjunction with the FCS BIT option or the FCS RESET button to initiate FCS IBIT or the FCS exerciser mode, respectively. See the FCS Initiated BIT (IBIT) section at the end of chapter 2 for details.

- ON When held (for at least 2 seconds) during selection of the FCS option, initiates FCS IBIT. When held during a press of the FCS RESET button, initiates FCS exerciser mode.
- OFF FCS IBIT and FCS exerciser mode not selected.

2.10.15.5 FCS Related Cautions. FCS related cautions shown in figure 2-27 are described in the Warning/Caution/Advisory Displays in Part V.

Caution	Associated Cockpit Indications			
	Master Caution Light	Master Caution Tone	FCES Light	"Flight Controls, Flight Controls" Voice Alert
AOA	X		X	X
Air Data	X	X		
ATC Fail	X	X	X	
AUTO PILOT	X	X		
P CAS	X		X	X
R CAS	X		X	X
Y CAS	X		X	X
CHECK TRIM	X	X		
CK FLAPS	X	X		
FC AIR DAT	X	X	X	
FCS	X	X	X	Note 2
FCS HOT	X		Note 1	Note 1
FLAPS OFF	X		X	X
FLAP SCHED	X		X	X
G-LIM 7.5G	X			X
G-LIM OVRD	X	X		
HYD 5000	X	X	X	
NWS	X	X	X	
R-LIM OFF	X	X		
RIG	X			
S/W CONFIG	X	X		

NOTES

1. The FLIGHT COMPUTER HOT, FLIGHT COMPUTER HOT voice alert and FCS HOT light on the caution lights panel are activated when the FCS HOT caution is set.
2. Also displayed when any aileron, stabilator, or rudder actuator failed off (Xd out and a "bold X" over the surface position on FCS Status Display).

Figure 2-27. FCS Related Cautions and Cockpit Indications

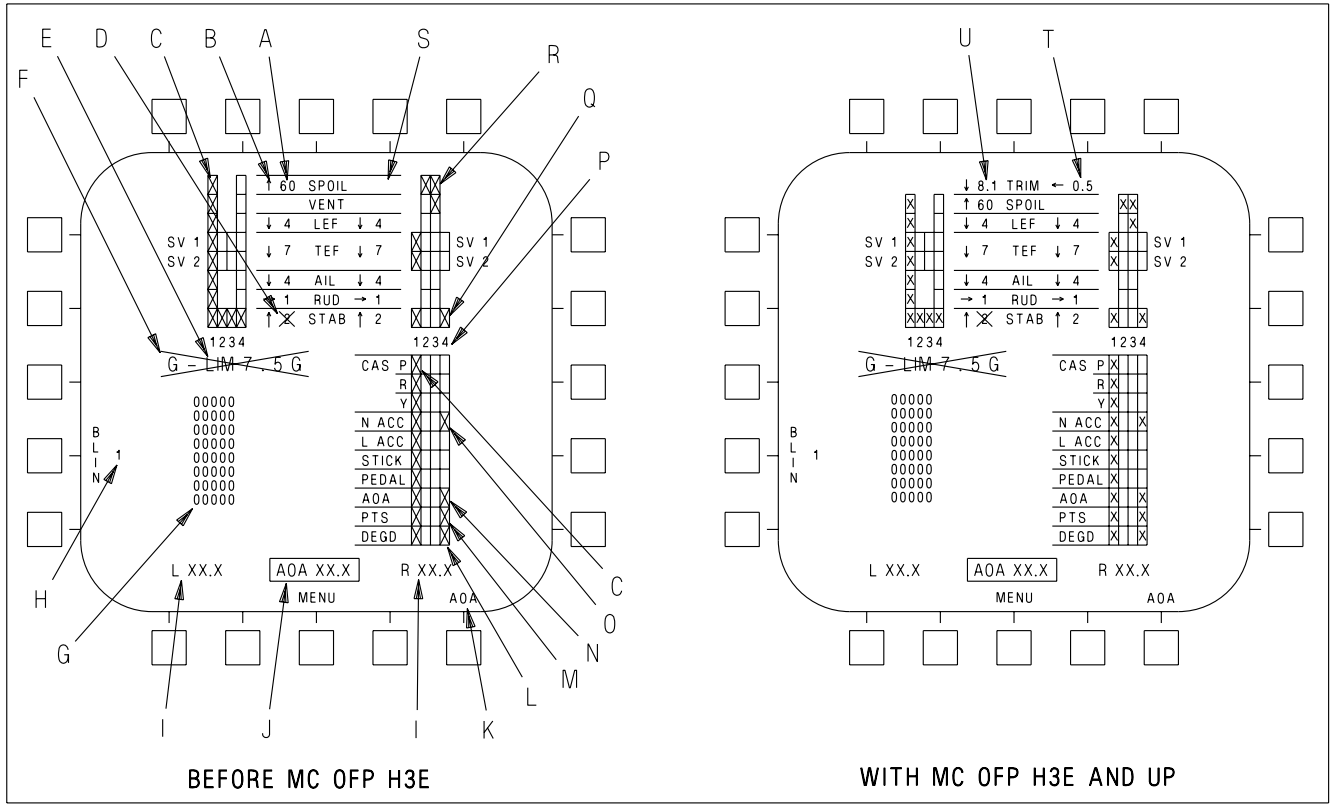

EFN520-433-1-018

Figure 2-28. FCS Status Display

2.10.16 FCS Status Display. When an FCS failure has occurred, the FCS status display (figure 2-28) can be used to determine the location and type of failure. The FCS status display is selected by the FCS option on the SUPT MENU. For FCS components/functions which are displayed in the matrix, an "X" is displayed in the failed channel(s) along with a corresponding BLIN code. For FCS components/functions which are not displayed in the matrix, BLIN codes are the only indication of failure location.

- A. **Surface Position:** In degrees from streamline for all surfaces. Tolerance is $\pm 1^\circ$ for all surfaces.
- B. **Surface Arrow:** Direction of surface deflection relative to the surface hinge point except for stabilators. For stabilators, surface arrow indicates trailing edge position.
- C. **Column of Xs:** An entire FCC channel is failed due to a processor fault or loss of power.
- D. **Bold X across surface position:** Surface failed; FCCs are no longer commanding movement of that surface in any channel.
- E. **G-LIMX.XG:** "X.X" is the current Nz REF value as calculated by the MC. This value is decremented if in the transonic g-bucket. INVALID is displayed in this position if the interface between FCC CH 1, FCC CH 3, and the MC is invalid. In this case, all data on the display is invalid. During FCS IBIT, G-LIM0.0G is displayed in this position.
- F. **Bold X over G-LIMX.XG:** Nz REF data from the MC is invalid or out of range, and Nz REF has defaulted to +7.5g. This X also appears when gross weight is above 57,405 lb, indicating that Nz REF has been set to +5.5g even though this may result in an overstress.

G. **BLIN Codes.** Up to eight FCC BLIN codes are displayed in octal format for each channel. The codes are displayed in the order of occurrence. If the list exceeds eight, additional codes may be viewed with a memory inspect of unit 14 or 15 with address 2253.

WARNING

In-flight Memory Inspect (MI) of FCC (UNIT 14 or 15) addresses (ADDR) greater than six digits long is prohibited since it may cause all four FCC channels to shut down which will result in loss of aircraft control.

H. **BLIN Code Channel:** The FCC channel corresponding to the list of BLIN codes. The channel is incremented from 1 thru 4 and back to 1 by selecting the BLIN option.

I. **L/R XX.X:** FCC air data function corrected true AOA for the left and right AOA probes (see AOA Select in paragraph K below).

J. **AOA XX.X:** True AOA based on INS data. INS true AOA is displayed for reference only to aid the pilot in determining which AOA probe is valid when one is damaged. INS true AOA is normally boxed, indicating that an average of the left and right probes has been selected for display in the HUD and for use by the AOA indexer lights and approach lights.

K. **AOA Select:** The AOA option is displayed only when GAIN ORIDE is selected. If one AOA probe is damaged, the AOA option can be used to select output from the good probe for display in the HUD and for use by the AOA indexer lights and approach lights. AOA probe selection does not affect the fixed gains used by the FCCs in GAIN ORIDE.

NOTE

If a single probe is declared invalid (a two channel AOA failure), and that probe is selected, the AOA indexer lights and the HUD AOA are blanked immediately.

L. **DEGD Xs:** An FCC failure has occurred in the Xd channel that is not covered by other matrix Xs. BLIN codes should be used to determine the degraded FCC channel function.

M. **PTS Xs:** The static or total pressure data is failed in the Xd channel. If a three channel PTS failure occurs (three Xs), the FCC control laws use data from the remaining PTS channel. If a total PTS failure occurs (four Xs), the FCCs use fixed PTS values. If a PTS failure clears, PTS Xs are removed automatically with or without an FCS RESET attempt.

NOTE

With a four channel PTS failure, HUD airspeed and altitude are blanked.

N. **AOA Xs:** AOA data failed in the Xd channel. A three or four channel AOA failure sets four Xs (AOA Four Channel failure). In UA, P CAS uses the AOA estimator for control law scheduling. If a UA failure clears, AOA Xs are removed automatically with or without an FCS RESET attempt. In PA, P CAS uses a fixed 8.1° AOA value, and R CAS uses the AOA estimator for control law scheduling. If a PA failure clears, AOA Xs are not removed until an FCS RESET is attempted.

O. **Sensor Xs (CAS P, R, or Y; N ACC, L ACC, STICK, or PEDAL):** The corresponding sensor (rate gyros, normal or lateral accelerometers, stick or pedal position) is failed in the Xd channel. A three or four channel sensor failure sets four Xs (total sensor failure). However, for a three channel failure, the FCCs average the remaining channel with the last channel that failed. For N ACC and L ACC only, the FCCs use a single channel if the signal from the third failed channel exceeds 90 % of full range. A single X for CAS P, CAS R, or CAS Y is not possible. Any single gyro failure in P, R, or Y sets Xs in CAS P, CAS R, and CAS Y for that channel. Similarly, an AHRS acceleration failure sets Xs in the N ACC and L ACC for that channel. A failed AHRS sets Xs in all five rows for that channel.

P. **1 2 3 4:** Column legends for each FCC channel. FCC A contains channels 1 and 2 while FCC B contains channels 3 and 4.

Q. **Actuator Xs:** The actuator is no longer commanded by the FCC in the Xd channel due to a detected failure (for all actuators except spoilers). The actuator is still commanded by the other operating channel(s).

R. **SPOIL Xs:** A single X is caused by a difference between commanded and actual position or by a SOV over-current. If a two channel failure (two Xs) was caused by a difference between commanded and actual position, the FCCs will continue to command the spoilers in both channels. This condition is indicated by two Xs, a blanked surface position, and no bold surface position X. The vent surface position value is always blanked.

S. **Blank Surface Position:** FCCs and/or MCs unable to report actuator position.

T. **ROLL TRIM:** With MC OFP H3E AND UP, roll trim is displayed in the right column with WoffW. Arrows indicate trim direction. The roll trim value is dimensionless. Roll trim effects for the same trim value are different at different airspeeds. The roll trim value provides a quantitative measure of how much roll trim has been commanded.

U. **PITCH TRIM:** With MC OFP H3E AND UP, pitch trim is displayed in the left column with WoffW. Arrows indicate trim direction. The pitch trim value is degrees AOA with flaps in HALF or FULL and g-level with flaps in AUTO.

2.11 AFCS - AUTOMATIC FLIGHT CONTROL SYSTEM

The AFCS or autopilot provides three basic functions: pilot relief, coupled steering, and data link control.

Different pilot relief modes are provided for the pitch and roll axes. Pitch-axis pilot relief modes include barometric altitude hold (BALT), radar altitude hold (RALT), and flight path attitude hold (FPAH). Roll-axis pilot relief modes include roll attitude hold (ROLL), ground track hold (GTRK), ground track select (GSEL), heading hold (HDG), and heading select (HSEL).

Coupled steering modes allow the roll-axis to be coupled to a TACAN station (CPL TCN), to a waypoint (CPL WYPT), to the azimuth steering line (CPL ASL), or to bank angle (CPL BNK).

Data link control modes include automatic carrier landing (ACL) and vector (VEC).

2.11.1 AFCS Mode Selection. Selection of the various autopilot (A/P) modes is accomplished from the A/P sublevel of the CNI format on the UFCF. Before any autopilot mode can be selected, bank angle must be less than 70°, pitch attitude must be less than 45°, and the A/P sublevel must be displayed on the UFCF. The left column of the A/P sublevel displays the couple (CPL) option and the pitch-axis pilot relief mode options: BALT, RALT, and FPAH. The right column displays the roll-axis pilot relief mode options: ROLL, GTRK, and HDG. See figure 2-29.

An autopilot mode is enabled by selecting the corresponding option on the UFCF. Once selected, a highlighted box appears around the option and the corresponding autopilot advisory appears on the LDDI. If an option is not available, it is not displayed.

Once in the GTRK mode, subsequent selection of the GTRK option enables the GSEL mode (GSEL replaces GTRK on the UFCF). Once in the HDG mode, subsequent selection of the HDG option enables the HSEL mode (HSEL replaces HDG on the UFCF).

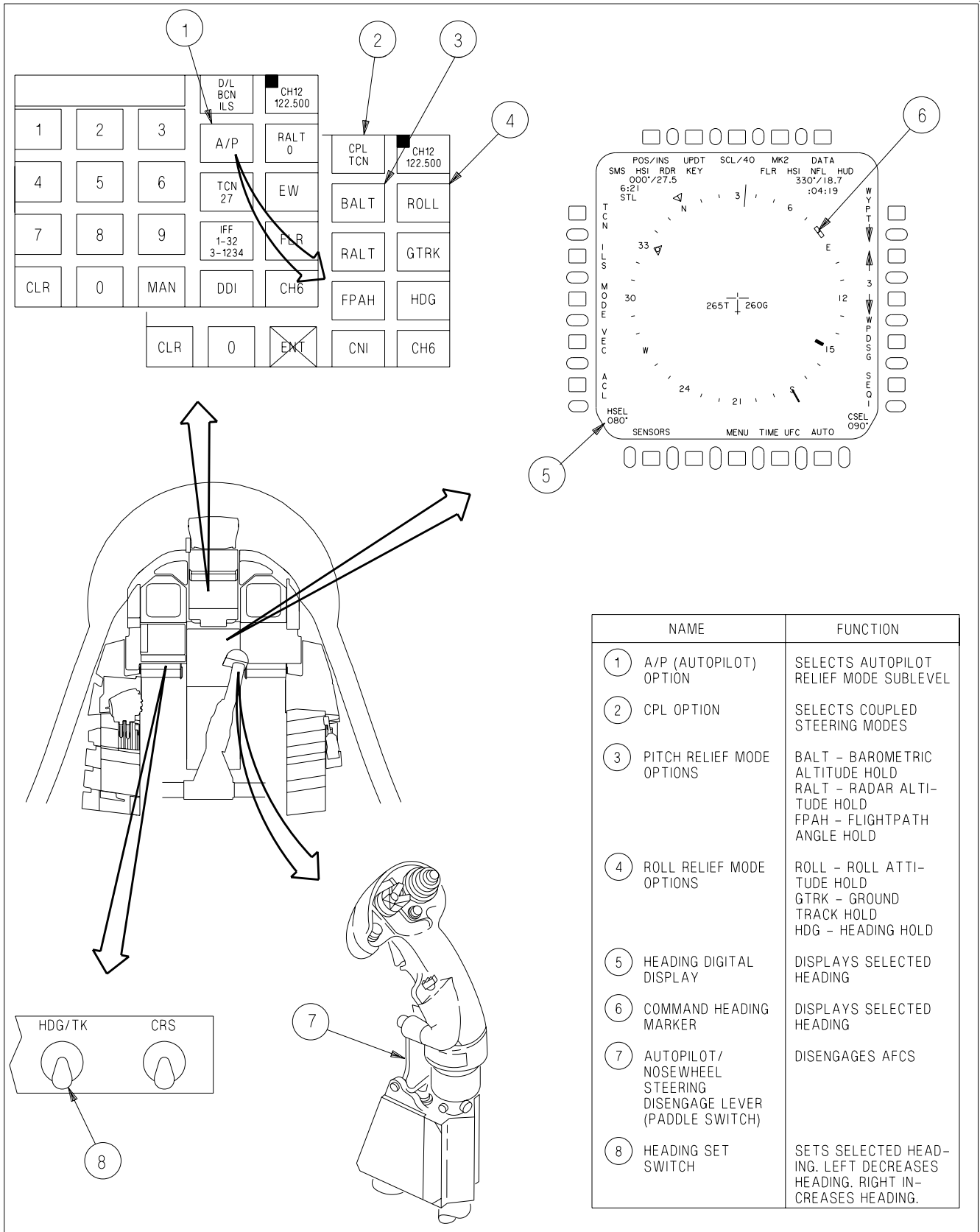

EFN520-51-1-010

Figure 2-29. AFCS Controls and Indicators

2.11.2 Basic Autopilot. The basic or default autopilot mode is FPAH/HDG. When any autopilot mode is requested from the UFCED, the AFCS first engages FPAH/HDG and then engages the requested mode. This makes sure that the AFCS is controlling both the pitch and roll axis whenever an autopilot mode is engaged.

2.11.3 AFCS Mode Deselection. Autopilot modes can be disengaged by either reselecting (unboxing) the UFCED option or by actuating the paddle switch. If an autopilot mode is unboxed on the UFCED, the AFCS reverts to the basic autopilot mode in that axis and the AUTO PILOT caution illuminates. If the stick is moved longitudinally with BALT or RALT engaged or laterally with CPL engaged, the AFCS reverts to the basic autopilot mode in that axis as the AUTO PILOT caution illuminates. The basic autopilot mode, however, cannot be disengaged (unboxed) from the UFCED and must, therefore, be disengaged with the paddle switch. Paddle switch actuation is the only means to make sure that all autopilot modes have been completely disengaged.

2.11.4 Pitch-Axis Pilot Relief Modes. Any of the pitch-axis pilot relief modes can be engaged in conjunction with any coupled steering mode (except ACL) or with any roll-axis pilot relief mode. However, only one pitch-axis mode can be selected at a time. If one pitch-axis mode is requested while another is engaged, the AFCS switches to the requested mode.

2.11.4.1 BALT - Barometric Altitude Hold. When BALT is engaged, the baro-inertial altitude at the time of engagement is captured and maintained. While the mode is engaged, this reference altitude cannot be changed. Longitudinal stick inputs or trim changes disengage BALT, and the AFCS reverts to FPAH and the selected roll-axis mode.

2.11.4.2 RALT - Radar Altitude Hold. RALT is not available above 5,000 feet AGL. When RALT is engaged, the radar altitude at the time of engagement is captured and maintained. While the mode is engaged, this reference altitude cannot be changed. Longitudinal stick inputs or trim changes disengage RALT, and the AFCS reverts to FPAH and the selected roll-axis mode.

2.11.4.3 FPAH - Flight Path Angle Hold. When FPAH is engaged, the flight path angle at the time of engagement is captured and maintained. This reference flight path angle can be changed by longitudinal stick inputs (stick sensitivity similar to CAS) or by pitch trim changes (2°/sec in flaps AUTO or 0.5°/second in flaps HALF or FULL). When pilot inputs cease, the flight path attitude at release is captured and maintained.

2.11.5 Roll-Axis Pilot Relief Modes. Any of the roll-axis pilot relief modes can be engaged in conjunction with any pitch-axis pilot relief mode. However, only one roll-axis mode can be engaged at a time. If one roll-axis mode is requested while another is engaged, the AFCS switches to the requested mode.

2.11.5.1 ROLL - Roll Attitude Hold. When ROLL is engaged, the roll attitude at the time of engagement is captured and maintained. This reference roll attitude can be changed by lateral stick inputs or roll trim changes (stick and trim sensitivity similar to CAS). When pilot inputs cease, the roll attitude at release is captured and maintained.

2.11.5.2 GTRK - Ground Track Hold. When GTRK is engaged, aircraft response depends on the roll attitude at the time of engagement. If roll attitude is less than $\pm 5^\circ$, ground track is captured and maintained. If roll attitude is greater than or equal to $\pm 5^\circ$, roll attitude is captured and maintained. While in GTRK, the aircraft responds to lateral stick or roll trim inputs (stick and trim sensitivity similar to CAS). When pilot inputs cease, GTRK holds roll attitude (if greater than or equal to $\pm 5^\circ$) or ground track (if less than $\pm 5^\circ$).

2.11.5.3 GSEL - Ground Track Select. The desired ground track angle is selected by slewing the command heading marker with the HDG/TK switch, located to the left of the MPCD. When GSEL is engaged, the aircraft turns from the existing ground track through the smallest angle to the selected ground track. While in GSEL, the aircraft responds to lateral stick inputs. However, the selected ground track angle is not changed by stick inputs, so the aircraft returns to the selected ground track angle upon stick release.

2.11.5.4 HDG - Heading Hold. When HDG is engaged, aircraft response depends on the roll attitude at the time of engagement. If roll attitude is less than $\pm 5^\circ$, magnetic heading is captured and maintained. If roll attitude is greater than or equal to $\pm 5^\circ$, roll attitude is captured and maintained. While in HDG, the aircraft responds to lateral stick or roll trim inputs (stick and trim sensitivity similar to CAS). When pilot inputs cease, HDG holds roll attitude (if greater than or equal to $\pm 5^\circ$) or magnetic heading (if less than $\pm 5^\circ$).

2.11.5.5 HSEL - Heading Select. The desired heading is selected by slewing the command heading marker with the HDG/TK switch, located to the left of the MPCD. When HSEL is engaged, the aircraft turns from the existing heading through the smallest angle to the selected heading. While in HSEL, the aircraft responds to lateral stick inputs. However, the selected heading is not changed by stick inputs, so the aircraft returns to the selected heading upon stick release.

2.11.6 CPL - Coupled Steering Modes. The coupled steering modes couple the aircraft in the roll-axis only. If the CPL option is selected, the AFCS disengages any currently engaged roll-axis pilot relief mode. The AFCS has the ability to couple to the following sources: a waypoint, waypoint courseline, or offset aimpoint (CPL WYPT); to a TACAN station or TACAN courseline (CPL TCN); or to an auto sequence (CPL SEQ#). Refer to chapter 24 for detailed navigation steering information on waypoint/OAP, auto sequential, and TACAN steering.

2.11.7 Coupled Data Link Modes. The AFCS can couple to data link commands in one of two modes: ACL and VEC. With ACL boxed on the HSI format, the CPL P/R option appears on the A/P sublevel when pitch/roll couple capability is available. Selecting the CPL P/R option couples the aircraft to pitch and roll commands for a Mode 1 carrier approach. With VEC boxed on the HSI format, selecting the CPL option couples the aircraft (roll-axis only) to data link steering commands. Refer to chapter 24 and the Tactical Manual for detailed information on the ACL and VEC modes.

2.11.8 AFCS Related Caution and Advisories. The AUTO PILOT caution and the following AFCS related advisories are described in the Warning/Caution/Advisory Displays in Part V:

- BALT
- CPLD
- FPAH
- GSEL
- GTRK
- HDG
- HSEL
- RALT
- ROLL

2.12 WEAPON SYSTEMS CONTROLS

All of the primary controls for the aircraft's weapon systems (weapons, sensors, and displays) are located on the front cockpit throttles and stick, the rear cockpit throttles and stick (trainer configured F/A-18F), or the rear cockpit hand controllers (missionized F/A-18F). This concept, hands on throttles and stick (HOTAS), allows the aircrew to manipulate the weapon systems without removing the hands from the aircraft's primary flight controls. Additionally, the canopy sill DISP switch(es) and the rear cockpit grab handle switches provide secondary controls for dispensing expendables from the ALE-47 self-protect system.

Detailed descriptions of the functionality of the weapon systems controls are contained in the Tactical Manual, F/A-18EA-TAC Series.

2.12.1 Stick Grip Switches/Controls (Front Cockpit). The weapon systems controls located on the front cockpit stick grip are the A/A weapon select switch, the sensor control switch, the gun/missile trigger, the A/G weapon release button, and the undesignate/NWS button. See figure 2-30.

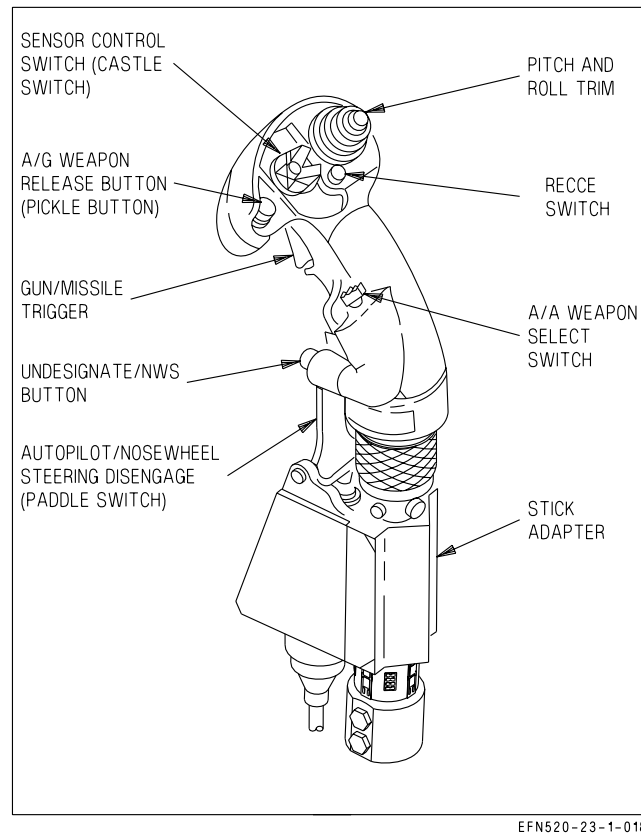

Figure 2-30. Stick Grip Switches/Controls

2.12.1.1 A/A Weapon Select Switch. The A/A weapon select switch, located on the left side of the stick grip, is spring loaded to the center/up position. The weapon select switch is used to select the desired A/A weapon and can be used to enter A/A master mode. When the weapon select switch is actuated while in NAV or A/G master mode, the A/A master mode is automatically entered, the RDR ATTK format is automatically displayed on the RDDI, and the appropriate A/A weapon/radar format is selected. Once in the A/A master mode, actuating the weapon select switch merely changes the selected A/A weapon/radar format.

Center	Neutral
Forward	Selects AIM-7 and the corresponding radar format.
Down	Selects AIM-9 and the corresponding radar format.
Aft	Selects A/A GUN and the gun acquisition mode (GACG).
Inward	Selects AIM-120 and the corresponding radar format.

Selection of an A/A missile initiates launch preparation of the priority missile, if more than one is carried and brings up the corresponding radar format (e.g., scan volume presets). Subsequent selection steps to the next available missile in the priority sequence.

2.12.1.2 Sensor Control Switch. The sensor control switch, commonly called the "castle" switch, is located on the top center of the stick grip and is spring loaded to the center/up position. The castle switch is used to assign throttle designator controller (TDC) priority to a particular cockpit display or, once air combat maneuvering (ACM) mode functionality is enabled, to select a particular ACM mode.

Center	Neutral
Forward	Assigns TDC priority to the HUD in NAV or A/G master mode. In A/A master mode, selects the boresight acquisition mode (BST) and enables ACM mode functionality.
Forward (twice within 0.5 seconds)	Selects/deselects EMCON.
Depress/release then forward (within 1 second)	Assigns TDC priority to the UFCDD in all master modes. If the top level CNI, a CNI sublevel, or a data entry format is displayed, selects the last displayed DDI format.
Left	Assigns the TDC to the LDDI in all master modes. With ACM mode functionality enabled in A/A master mode, selects the wide acquisition mode (WACQ).
Right	Assigns the TDC to the RDDI in all master modes. With ACM mode functionality enabled in A/A master mode, selects the automatic acquisition mode (AACQ).
Aft	Assigns the TDC to the MPCDD in all master modes. With ACM mode functionality enabled in A/A master mode, selects the vertical acquisition mode (VACQ).

When the TDC is assigned to a display which cannot accept TDC priority, automatic format initialization occurs, typically selecting the format which is most commonly used on that particular display (e.g., RDR ATTK on the RDDI). With TDC assignment, certain displays (e.g., RDR ATTK, FLIR, etc.) perform a specific action (e.g., track, break track, etc.) when the castle switch is subsequently bumped toward that display.

2.12.1.3 Trigger. The gun/missile trigger, located on the front of the stick grip, has two detented positions.

First Detent	Initiates strike camera automatic mode operation (based on the selected A/G weapon) and if CVRS is running, commands HUD recording.
Second Detent	In A/A master mode, fires the gun or selected A/A missile. Activates AGI protection. In A/G master mode, fires the gun or the laser, if either is selected. Commands the HUD event marker.

2.12.1.4 A/G Weapon Release Button. The A/G weapon release button, commonly called the “pickle”, is located on the top center of the stick grip to the left of the castle switch. The pickle is used to command weapon release while in A/G master mode. The pickle also initiates AGI protection, strike camera automatic mode operation, and, if CVRS is running, commands HUD recording and the HUD event marker.

2.12.1.5 Undesignate/NWS Button. The undesignate/NWS button is located on the lower front of the stick grip. In NAV or A/G master mode, the undesignate button undesignates all A/G designated targets and commands the radar and FLIR to break lock, if either is tracking. If TDC priority is assigned to the FLIR format, pressing the button twice in 1 second selects/deselects FLIR velocity vector slave (VVSLV) pointing mode. In A/A master mode, the undesignate button creates a launch and steering (L&S) target designation. Subsequent actuation steps target designation to the next priority trackfile or to a second designated trackfile (DT2), if one exists. If ACM mode functionality is enabled, the undesignate button exits the ACM mode and returns the radar to the previous search mode.

2.12.2 Stick Grip Switches/Controls (Trainer Configured F/A-18F). In the F/A-18F (trainer configuration), the front and rear cockpit stick grips are identical. However, the rear cockpit trigger and A/G weapon release button are not functional. The rear cockpit A/A weapon select switch does not automatically select A/A master mode. From the rear cockpit, A/A master mode must be entered by actuation of the A/A master mode light. The front and rear cockpit control sensor switches are functionally identical, including ACM mode selection. However, the rear cockpit TDC can be assigned to a sensor different from the front cockpit TDC. The systems controlled by the stick grip switches/controls respond to the last crewmember action taken from either cockpit.

2.12.3 Throttle Grip Switches/Controls (Front Cockpit). The weapon systems controls located on the front cockpit throttle grips are the chaff/flare/ALE-50 dispense switch, the cage/uncage button, the throttle designator controller (TDC), the radar elevation control, and the raid button. See figure 2-31.

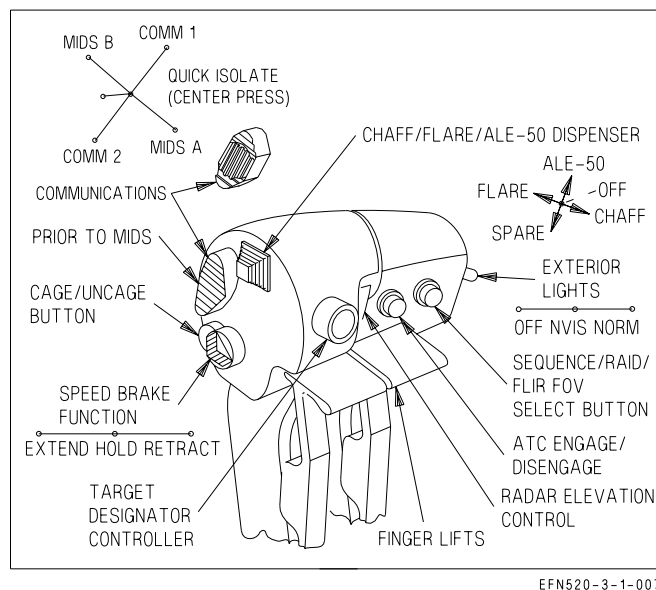

Figure 2-31. Throttle Grip Switches/Controls (Front Cockpit)

2.12.3.1 Chaff/Flare/ALE-50 Dispense Switch. The chaff/flare/ALE-50 dispense switch is located on the top inboard side of the right throttle. The switch is used to dispense expendables from the ALE-47 and ALE-50 self-protect systems.

Forward	Provides semi-automatic consent. Dispenses chaff singles (C/F mode).
Aft	Initiates the selected manual program. Dispenses flare singles (C/F mode).
Up	Dispenses a single ALE-50 decoy and provides transmit enable.
Down	Not functional

2.12.3.2 Cage/Uncage Button. The cage/uncage button is located on the rear inboard side of the right throttle. In NAV master mode and A/G master mode (AUTO delivery), the cage/uncage button is used to cage and uncage the velocity vector. Depending on master mode and TDC priority assignment, the cage/uncage button can be used to (1) cage/uncage weapons, (2) command a radar STT, (3) toggle between weapon modes, or (4) reset sequenced HARM targets.

(18E OFP) With the velocity vector caged, data such as the flight path/pitch ladder and steering information is displayed near the center of the HUD despite large yaw rates and/or crosswind angles.

2.12.3.3 TDC - Throttle Designator Controller. The TDC is located on the front right side of the right throttle. It is used to control the positioning of the acquisition cursor or the slewing of a particular sensor or weapon (e.g., FLIR or Maverick). The TDC can be pressed for target designation. When held pressed (action slew) or released (no-action slew), the fore-aft and left-right movement of the TDC sends X-Y slew commands to the display or to the sensor/weapon to which TDC priority is assigned.

2.12.3.4 Radar Elevation Control. The radar elevation control is located on the front left side of the right throttle. Momentary actuation changes the elevation of the radar antenna in 1,000 foot increments at the range where the cursor is positioned on the RDR ATTK format. Press and hold produces a faster elevation change.

Up	Raises the radar antenna/scan volume.
Center	Neutral
Down	Lowers the radar antenna/scan volume.

2.12.3.5 RAID Button. The RAID button is located on the left side of the left throttle. Depending on master mode and TDC priority assignment, the RAID button can be used to (1) sequence between available HARM targets, (2) toggle between narrow and wide field of view (FOV) for the FLIR or Maverick, or (3) select/deselect the STT RAID or SCAN RAID radar modes.

2.12.4 Throttle Grip Switches/Controls (Trainer Configured Rear Cockpit). The rear cockpit throttle grips contain the same weapon systems controls as those in the front cockpit, except no chaff/flare/ALE-50 switch is installed. The systems controlled by the throttle grip switches/controls respond to the last crewmember action taken from either cockpit.

2.12.5 Hand Controllers (Missionized Rear Cockpit Lots 21 thru 25). Two hand controllers are installed in the rear cockpit, one on the front inboard section of each console. With the exception of weapons release, the hand controllers are used to provide the same weapon systems control as stick and throttle switches/controls do in the front cockpit. The right hand controller is a mirror image of the left hand controller. Each contains a multi-function switch (MFS), a designator controller (DC) assignment switch, a designator controller (DC), a radar elevation control, a chaff/flare dispense switch, and an

undesignate button. Except for the chaff/flare dispense switches, the functions of the left and right hand controllers are identical. See figure 2-32.

2.12.5.1 Multi-Function Switch (MFS). The MFS is located on the lower inboard side of each hand controller. The MFS provides the same functionality as the front cockpit RAID and cage/uncage buttons.

Forward	Sequences between available HARM targets.
Aft	Cages/uncages an A/G weapon.
Down	Selects RAID or changes FLIR/Maverick FOV.
Forward	Not functional

2.12.5.2 Designator Controller (DC) Assignment Switch. The DC assignment switch is located on the top inboard side of each hand controller. It is used to assign left and right DC priority to the displays in the rear cockpit. ACM modes cannot be selected by the rear cockpit DC assignment switches.

Forward	Commands FLIR track/break lock if opposite DC is assigned to the FLIR format.
Aft	Assigns DC priority to the AUFCD.
Inboard	Assigns DC priority to the AMPCD
Outboard	Assigns DC priority to the outboard ADDI. Following DC assignment, commands track/break lock on the outboard format.

Each DC is initially assigned to its corresponding ADDI. One but not both DCs can be assigned to one of the center displays, AUFCD or AMPCD. If one DC is assigned to the AMPCD, the other is forced back to its corresponding ADDI.

2.12.5.3 Designator Controller (DC). The DC is located on the top center of each hand controller. The track and slew functions of the rear cockpit DCs are identical to the front cockpit TDC. While only one hand controller DC can be used to designate at a time, both DCs may be used simultaneously on their assigned formats.

If the front cockpit TDC and the rear cockpit DC are both assigned to the same format, control is captured by the first controller actuated. If one controller is active when another is selected, the second input is ignored. If both front and rear TDC/DCs are pressed simultaneously, the TDC/DC assignment diamond, located in the upper right corner of the specific format, flashes. If both front and rear TDC/DCs are being slewed simultaneously, the SLEW cue is displayed and flashed.

2.12.5.4 Radar Elevation Control. The radar elevation control is located on the top outboard side of each hand controller. The front and rear cockpit radar elevation controls are functionally identical. Control of the radar antenna is captured by the first elevation control actuated from either cockpit. If one control is active when another is selected, the second input is ignored.

LOTS 21 THRU 25

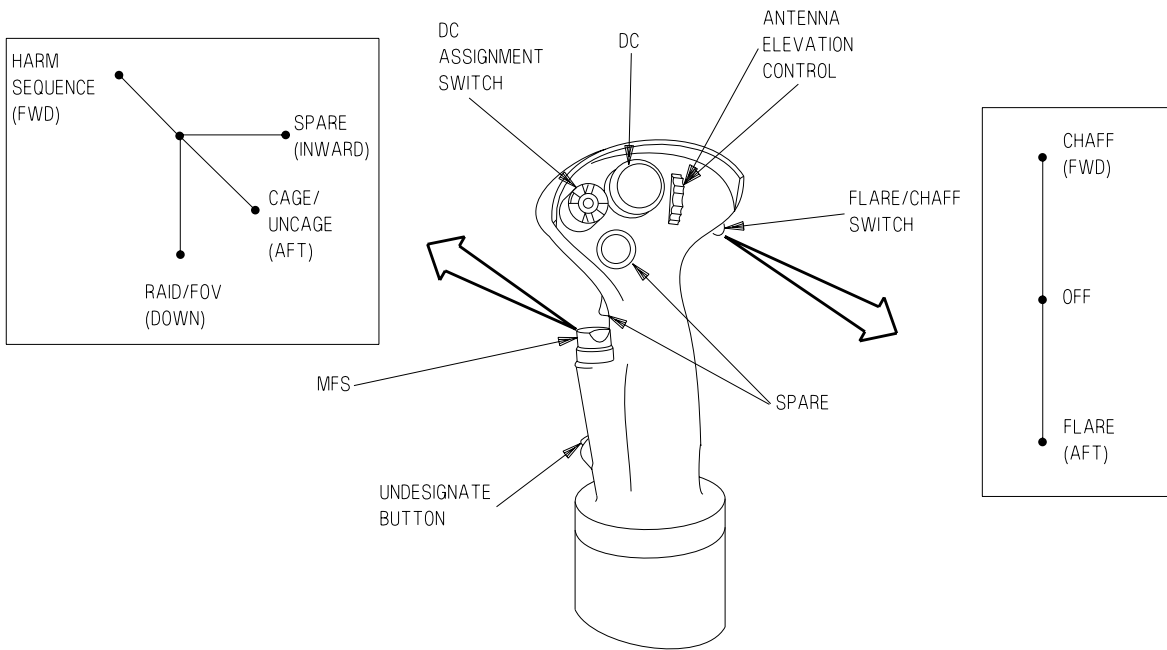

RIGHT HAND CONTROLLER

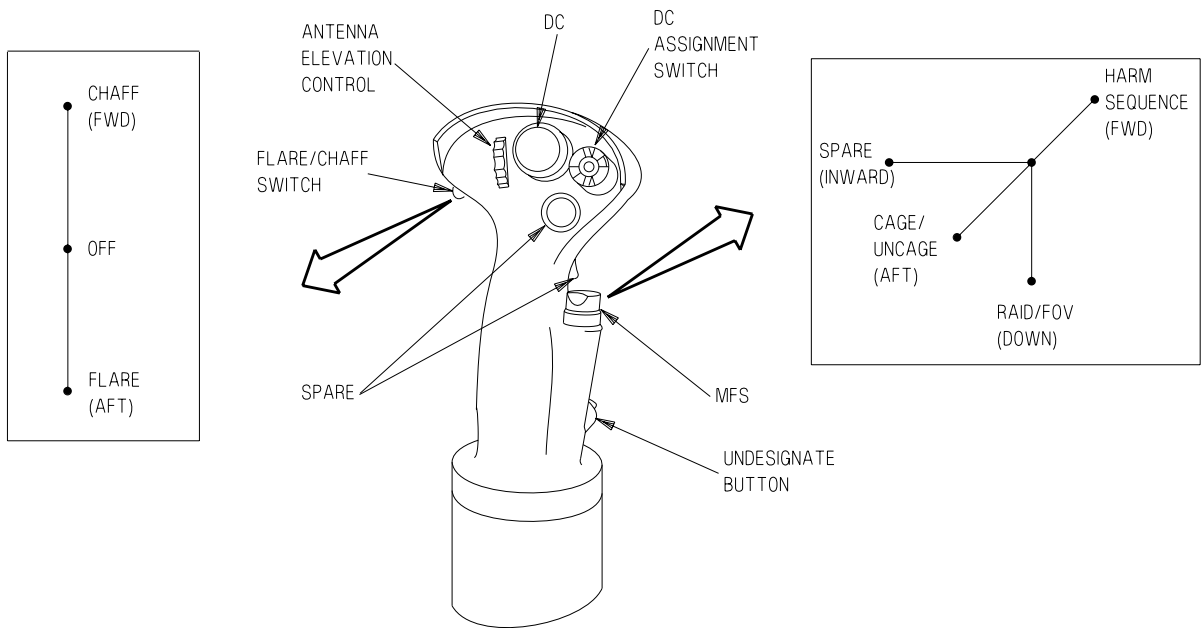

LEFT HAND CONTROLLER

Figure 2-32. Hand Controllers (Sheet 1 of 2)

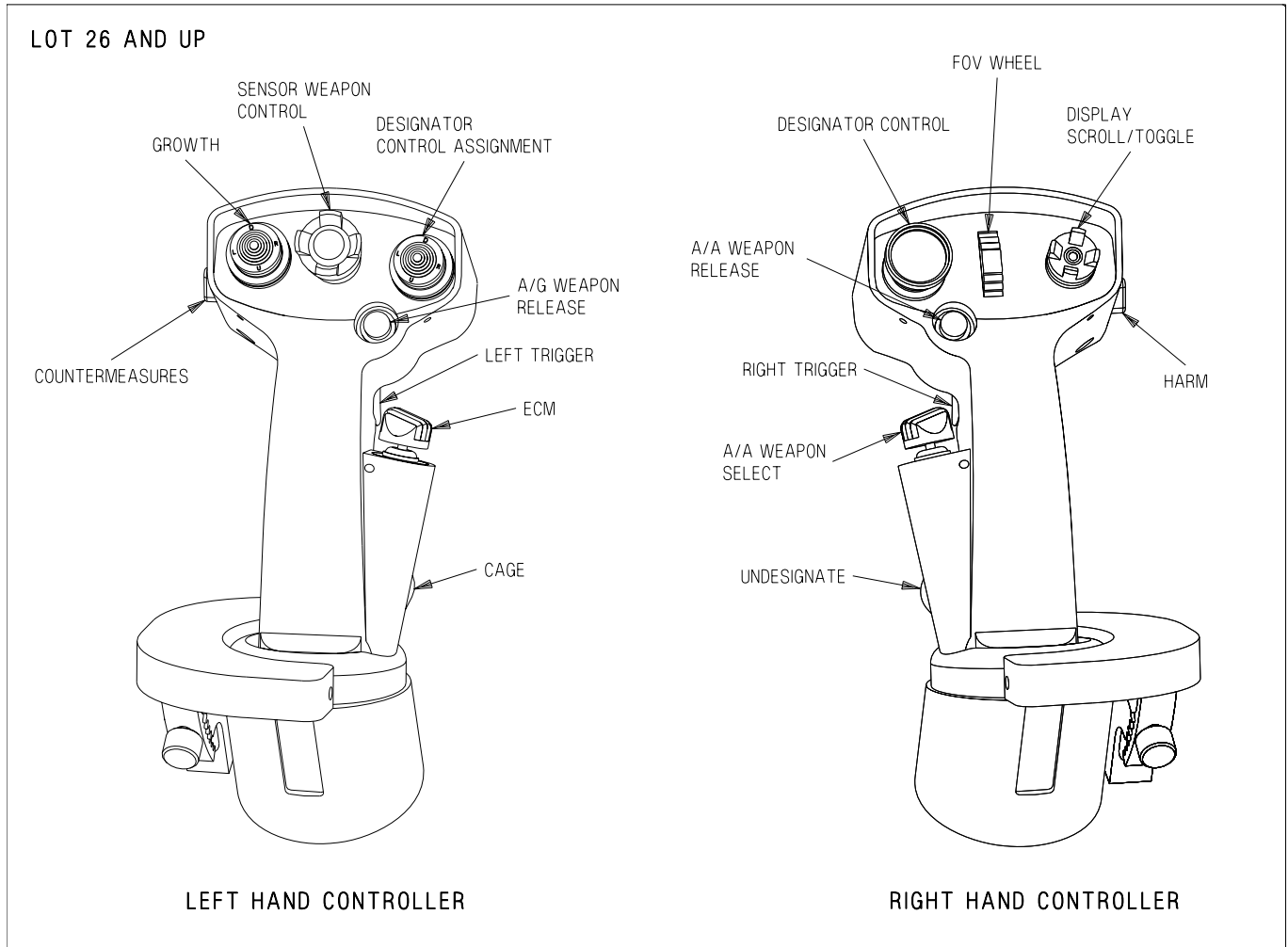

EFN520-173-2-010

Figure 2-32. Hand Controllers (Sheet 2 of 2)

2.12.5.5 Chaff/Flare Dispense Switch. The chaff/flare dispense switch is located on the outboard side of each hand controller. Dispense switch functionality differs between the left and right hand controllers.

Left Hand Controller -

- Forward Initiates manual program 6. Dispenses chaff and flare singles (C/F mode)
- Aft Initiates manual program 6. Dispenses chaff and flare singles (C/F mode)

Right Hand Controller -

- Forward Provides semi-automatic consent. Dispenses chaff singles (C/F mode)
- Aft Initiates the selected manual program. Dispenses flare singles (C/F mode)

2.12.5.6 Undesignate Button. The undesignate button is located on the lower front of each hand controller. The front and rear undesignate buttons are functionally identical, except the rear cockpit buttons do not command NWS.

2.12.6 Hand Controllers (Rear Cockpit LOT 26 AND UP). The functions of the left and right hand controllers are not identical. The left hand controller contains the following switches: Countermeasures, Growth, Sensor Weapons Control, Designator Control Assignment, A/G Weapon Release, Left Trigger, ECM, and Cage. The right hand controller contains the following switches: HARM, Display Scroll/Toggle, FOV Wheel, Designator Control, A/A Weapon Release, A/A Weapon Select, Undesignate, and Right Trigger. See figure 2-32 Sheet 2. Refer to Tactical Manuals for complete Hand controller Switch description.

2.12.7 ALE-47 DISP Switch. An ALE-47 DISP switch is located on the left canopy sill in both front and rear cockpits. Either switch can be used to initiate manual program 6 or to dispense chaff and flare singles (C/F mode).

2.12.8 Grab Handle Chaff/Flare Dispense Switches (Rear Cockpit LOTs 21 thru 25). The grab handle dispense switches are located on the left and right ends of the center grab handle in the rear cockpit. These switches provide a secondary means to dispense expendables from the ALE-47 self-protect system.

Forward	Provides semi-automatic consent. Dispenses flare singles (C/F mode)
Aft	Initiates the selected manual program. Dispenses flare singles (C/F mode)
Inboard	Initiates manual program 6. Dispenses chaff and flare singles (C/F mode)
Outboard	Initiates manual program 6. Dispenses chaff and flare singles (C/F mode)

2.12.9 Grab Handle Chaff/Flare Dispense Switches (Rear Cockpit LOT 26 and up). The grab handle dispense switches are located on the left end of the left grab handle and the right end of the right grab handle in the rear cockpit. Switch function is the same as described above.

2.13 ECS - ENVIRONMENTAL CONTROL SYSTEM

The environmental control system (ECS) utilizes engine bleed air to provide pressurization, heating and cooling air to various aircraft systems. Warm air is provided for internal fuel tank pressurization (LOT 23 and below), external fuel tank pressurization, canopy seal inflation, g-suit operation, radar waveguide pressurization, windshield anti-ice and rain removal, gun gas purge, RECCE bay heating, and on-board oxygen generating system (OBOGS) operation. Cold, dry conditioned air is provided for avionics cooling. Warm and cold air are mixed to provide temperature controlled air for cabin heating, cooling, and pressurization and windshield defog.

A liquid cooling system (LCS) is used to cool the radar transmitter. A digital ECS controller is used to schedule ECS output, regulate system temperatures, monitor system health, and detect and isolate faults. See foldout section for a schematic of the ECS. Items numbers, listed in () next to ECS valves, are maintenance and MSP code nomenclature.

2.13.1 Bleed Air Shutoff Valves. Engine bleed air is tapped from the final (seventh) stage of the engine high pressure compressor. A primary bleed air pressure regulator and shutoff valve (Item 1), one

on each engine, is used to regulate bleed air output pressure as well as to control flow application/shutoff.

Both valves are electrically controlled by the BLEED AIR knob and are pneumatically actuated. The primary bleed air shutoff valves fail-safe to the closed position if either electrical power or air pressure is lost. If an engine is shut down before placing the BLEED AIR knob to OFF, the corresponding primary bleed air shutoff valve may not fully close, resulting in residual engine fumes in the cabin on subsequent start of that engine.

Bleed air from each engine passes through a check valve, which prevents reverse flow, and is mixed through a Y-junction prior to the secondary bleed air pressure regulator and shutoff valve (Item 2). This valve is electrically controlled by the OFF and AUG PULL positions of the BLEED AIR knob and is pneumatically actuated. The secondary bleed air shutoff valve fails to the open (safe) position if either electrical power or air pressure is lost.

All three valves can be automatically commanded to the closed position by the bleed air leak detection (BALD) system.

2.13.1.1 BLEED AIR Knob. The BLEED AIR knob, located on the ECS panel on the right console, is used to select the engine bleed air source for the ECS system.

- NORM Commands both primary bleed air shutoff valves open, selecting bleed air from both engines.
- L OFF Commands the left primary bleed air shutoff valve closed, selecting bleed air from the right engine only.
- R OFF Commands the right primary bleed air shutoff valve closed, selecting bleed air from the left engine only.
- OFF Commands all three bleed air shutoff valves closed, isolating the ECS. Closes the ECS auxiliary duct doors.
- AUG PULL Commands the secondary bleed air shutoff valve closed, opens the ECS air isolation valve, and allows APU compressor air to operate the ECS.

2.13.1.2 L or R BLD OFF Cautions. The L or R BLD OFF cautions indicate that the corresponding primary bleed air shutoff valve(s) are commanded closed. The cautions are not an indication of actual valve position. The L and/or R BLD OFF cautions are displayed in the following circumstances:

- a. BLEED AIR knob in L OFF, R OFF, or OFF (L, R, or both cautions).
- b. ENG CRANK switch in L or R (L or R caution, respectively).
- c. BALD system detects a leak in one or both bleed air systems (L, R, or both cautions).
- d. FIRE switch in TEST A or TEST B (both cautions).
- e. Over pressurization in one or both bleed air systems (both cautions).

If a bleed air shutoff valve has been commanded closed other than by ENG CRANK, the BLEED AIR knob must be cycled to OFF and back to NORM to reopen the valve(s).

2.13.2 Bleed Air Subsystem. Engine bleed air downstream of the secondary bleed air shutoff valve is routed to the primary heat exchanger and three valves. The primary heat exchanger is used for first stage cooling of hot engine bleed air. The ECS air isolation valve directs bleed air to the air turbine

starter control valves (ATSCV) for crossbleed start and accepts air from the APU compressor for alternate (AUG PULL) ECS operation. On the ground and during slow speed flight, the ejector shutoff valve is opened to direct bleed air to the ram air ejectors to induce cooling airflow through the primary and secondary heat exchangers. The warm air temperature control valve is used to mix uncooled engine bleed air with primary heat exchanger output air to regulate the temperature of air in the warm air manifold.

2.13.3 Primary Heat Exchanger. The primary heat exchanger is located near the base of the right vertical tail and is used to reject heat from engine bleed air to ram air from one of two inlets.

During medium to high speed flight, ram air cooling is provided by the main ram inlet which draws air from the engine intake. During slow speed flight and ground operations, ram air cooling is provided by an auxiliary ram inlet which draws free stream air from the top of the fuselage. A ram air ejector in the ram air exhaust duct is used to induce more airflow when required, such as on the the ground, during slow speed flight, and during windshield anti-ice operation with either throttle above IDLE.

2.13.3.1 ECS Auxiliary Duct Doors. Two ECS auxiliary duct doors are located on the upper surface of the fuselage forward of the base of the vertical tails and immediately in front of the primary and secondary heat exchangers. The ECS auxiliary duct doors are electrically actuated and open into the free stream, closing the main ram air inlets and exposing the auxiliary ram air inlets.

On the ground, the ECS auxiliary duct doors are open with the BLEED AIR knob in any position except OFF. Inflight, the doors are positioned based on Mach number and throttle setting. The doors are always open below Mach 0.33 and are always closed above Mach 0.40. Between Mach 0.35 and Mach 0.40, the doors are open if either throttle is near MIL (THA greater than 25°).

The ECS auxiliary duct doors should operate symmetrically. If either ECS auxiliary duct door is not in the commanded position for greater than 8 seconds, an ECS DR advisory is displayed along with an ECS BIT indication of DEGD. If the door(s) return to the commanded position, the ECS DR advisory is removed.

2.13.3.2 Ram Air Exhausts. The ECS ram air exhausts are located on the upper fuselage just aft of the leading edge of the vertical tails. There is one exhaust for the primary heat exchanger (right side) and one for the secondary heat exchanger (left side). These exhausts discharge the heated ram air overboard. The exhausts have been redesigned to a five swept stack configuration to prevent overheating of the aft fuselage structure.

2.13.4 Warm Air Subsystems. Air leaves the primary heat exchanger at a greatly reduced temperature. Warm air from the primary heat exchanger is routed directly to the following systems: internal fuel tank pressurization (LOT 23 and below), external fuel tank pressurization, canopy seal, g-suit, radar waveguide pressurization, and OBOGS.

The ECS controller modulates the warm air temperature control valve (Item 21) to mix air from the primary heat exchanger with uncooled engine bleed air to regulate the temperature in the warm air manifold. The warm air manifold supplies air for windshield anti-ice and rain removal, gun gas purge, RECCE bay heating, ECS turbine anti-ice, and cabin heating.

2.13.5 Air Conditioning System (ACS) Pack. The ACS pack provides cold, dry conditioned air for cabin, FLIR, and avionics cooling. The primary components of the ACS pack are a compressor, turbine, condenser, reheater and water extractor.

The ECS controller modulates airflow through the ECS flow modulator valve (Item 4) to control ECS flow and the speed of the ECS compressor and turbine. Compressor discharge air is directed to the secondary heat exchanger for additional cooling. Cooled air from the secondary heat exchanger is directed to the ECS turbine and is used as another source of OBOGS air inflight.

Expansion through the ECS turbine drives the compressor and greatly reduces the temperature of the airflow, typically to below freezing. The ECS controller regulates the ECS turbine output temperature and prevents ECS icing by adding warm air through the anti-ice add heat valve (Item 51). Output temperature is regulated during low altitude operations where ECS icing would be likely.

The condenser, reheater and water extractor remove water from the cold conditioned air. With the large heat load of the APG-79 radar, the condenser can run at sub-freezing conditions. During prolonged operation of the APG-79 in high humidity conditions with warm fuel temperatures, periodic automatic deicing of the condenser occurs. During de-icing, a short term increase in cabin supply air temperature may be noticed.

In LOT 26 and up, at altitudes above 40,000 feet the water removal system may be bypassed by opening the water extractor bypass valve (Item 171) in order to improve ECS operating efficiency. If this valve fails to close after descending below 37,000 feet, water removal capability is degraded. Water or ice pellets may be blown into the cabin and erratic system behavior (flow/pressure surges) may result. An ECS ICING caution may also occur.

2.13.6 Secondary Heat Exchanger. The secondary heat exchanger is located near the base of the left vertical tail and is used to reject heat from ECS compressor air to ram air. Operation of the secondary heat exchanger is identical to operation of the primary heat exchanger. However, excess ECS system moisture is sprayed onto the secondary heat exchanger to increase system cooling. This moisture may be seen exiting the secondary heat exchanger exhaust duct when the throttles are advanced during ground operations.

2.13.7 Avionics Cooling Fans. Two avionic cooling fans augment ECS cooling of avionics. The avionics ground cooling fan is located in the nosewheel well. The aft avionics cooling fan is located in door 108. These fans normally provide primary avionics cooling on deck, and also provide contingency avionics cooling in flight. Fan activation is a function of bleed air pressure, which varies with engine N2 rpm (i.e. throttle position). Fan operation is described in the individual ECS mode descriptions.

2.13.7.1 Aft Cooling Fan Shutoff Valve. The aft cooling fan shutoff valve, when closed, secures flow from the aft avionics cooling fan into the ECS and also prevents ECS backflow to the aft avionics cooling fan. If this valve fails (indicated by MSP 863) while in the open position then, depending on system pressure, ECS backflow can overspeed the fan in the wrong direction. This may cause a structural failure of the fan and result in collateral fragment damage to adjacent systems. ECS backflow is most likely to occur when ECS MAN mode is selected and ECS flow is commanded by default to maximum.

WARNING

Selection of ECS MAN mode is prohibited. Selecting ECS MAN mode while the aft cooling fan shutoff valve is open may cause the fan to overspeed, resulting in a catastrophic fan failure and potential loss of OBOGS.

2.13.8 ECS Operating Modes. The ECS has three operating modes: AUTO, MAN (manual) (PROHIBITED), and OFF/RAM. Each mode is selected by the corresponding position of the ECS MODE switch. On the ground only, APU compressor air may be used instead of engine bleed air to run the ECS and cool the avionics (BLEED AIR knob in AUG PULL).

2.13.8.1 ECS AUTO Mode. ECS AUTO mode is the normal operating mode of the ECS. The ECS controller modulates ECS output to provide the required airflow to the cabin and the avionics. Cabin airflow is scheduled as a function of ram air temperature and throttle setting, with the highest flow delivered at hot and cold temperature extremes. Cabin flow may decrease at IDLE. ECS flow to the avionics is dependent on WonW status, throttle setting, Lot number, and radar configuration. For all aircraft configurations, more air is provided to avionics inflight.

With APG-73 radar installed, WonW and both throttles at IDLE, the avionics ground cooling fan and the aft avionics cooling fan energize. With APG-79 radar installed, WonW and both throttles at IDLE, only the avionics ground cooling fan energizes. The fan(s) provide the primary source of avionics cooling on deck. The ECS provides a second source of ground avionics cooling but at a fixed, low flow rate with the remainder of the flow going to the cabin.

With WonW and at least one throttle advanced to approximately 74 % N2 rpm, or with WoffW, the fan(s) secure. Once secured, the fan(s) will not reenergize until both throttles are retarded below approximately 70 % N2 rpm. With WonW and fans secured, the ECS provides all avionics cooling and controls to the cabin and avionics airflow schedules. The ECS controller schedules avionics airflow based on the temperature of the air being delivered (warmer air requires higher flow to maintain constant cooling).

The ECS controller modulates airflow output to meet scheduled airflow requirements. ECS output temperature is scheduled by the ECS controller to meet avionics cooling requirements and to prevent ECS turbine icing. Temperature is regulated by adding warm air as required. The controller divides the airflow between the cabin and avionics. Inflight, if ECS output is inadequate for demand, cabin airflow is normally given priority. The avionics typically receive that portion of the ECS output which is not used by the cabin or FLIR cooling systems.

Cabin temperature is controlled by gradually mixing warm air with cold conditioned air, according to the position of the CABIN TEMP knob. Cabin temperature is normally selectable in the range of 35 to 135° F between the CABIN TEMP knob positions of COLD and HOT, respectively (60 to 160° F with the DEFOG handle in the HIGH position).

NOTE

In ECS AUTO mode, cabin temperature may take 1 to 2 minutes to stabilize following a large movement of the CABIN TEMP knob.

2.13.8.2 ECS MAN Mode.

WARNING

Selection of ECS MAN mode is prohibited. Selecting ECS MAN mode while the aft cooling fan shutoff valve is open may cause the fan to overspeed, resulting in a catastrophic fan failure and potential loss of OBOGS.

2.13.8.3 ECS OFF/RAM Mode. ECS OFF/RAM mode is used to terminate normal ECS operation following a major ECS malfunction. Conditioned ECS air is terminated, the cabin ram air scoop is deployed, and if inflight the aft avionics cooling fan energizes.

NOTE

If ECS OFF/RAM mode is selected inflight, the AV COOL switch should be placed in EMERG to deploy the FCS emergency ram air scoop and maximize the emergency avionics cooling available.

Partial cabin pressurization is provided, but only if the CABIN TEMP knob is above the full COLD position. Cabin airflow and pressurization is provided by ram air from the cabin ram air scoop. Ram air supply varies with inflight dynamic conditions (airspeed and altitude), and cabin airflow and pressurization vary similarly.

CAUTION

In ECS OFF/RAM mode, avoid operations above 25,000 feet MSL in order to prevent decompression sickness (DCS). Normal cabin pressurization is not provided. Partial cabin pressurization is available under certain circumstances, but may be lost insidiously without warning.

Inflight, cabin temperature is no longer automatically controlled. The CABIN TEMP knob manually controls addition of heated air according to the CABIN TEMP knob. Temperature control in between the full COLD and full HOT positions is difficult and imprecise, and ECS response to commanded temperature changes is slow and nonlinear.

NOTE

In ECS OFF/RAM mode, changes in the position of the CABIN TEMP knob should be held for 30 seconds due to a slower temperature response.

With the CABIN TEMP knob not in full COLD, cabin temperature varies with throttle position and flight condition. System flow/temperature cycling can be expected with the CABIN TEMP knob in full HOT since overtemperature protection operates intermittently.

With WonW and both throttles at IDLE, the avionics ground cooling fan and the aft avionics cooling fan provide the only source of avionics cooling. Above approximately 74% N2 rpm, both fans secure, and avionics equipment is deprived of all cooling (AV AIR HOT caution).

NOTE

During ground operations in the ECS OFF/RAM mode, the throttles should be kept below 70% N2 rpm whenever possible in order to preserve avionics cooling. If either throttle must be advanced above approximately 74% N2 rpm more than momentarily or if an AV AIR HOT caution is present, placing the BLEED AIR knob to OFF reenergizes both fans and provides avionics cooling.

Inflight, the aft avionics cooling fan and the FCS emergency ram air scoop (with AV COOL in EMERG) provide emergency avionics cooling.

NOTE

With the FCS emergency ram air scoop extended, avionics cooling inflight is maximized by maintaining altitude below 25,000 feet MSL and airspeed between 200 to 300 KCAS.

2.13.8.4 AUG PULL. With both generators online and the APU running, selecting AUG PULL (up on the BLEED AIR knob):

- a. overrides APU automatic shutdown
- b. closes the secondary bleed air shutoff valve.
- c. opens the ECS air isolation valve.
- d. shuts down the aft avionics cooling fans.
- e. and directs APU air to the ECS for cabin and avionics cooling.

2.13.8.5 ECS MODE Switch. The ECS MODE switch, located on the ECS panel on the right console, is used to select the ECS operating mode.

AUTO	Selects ECS AUTO mode, the normal ECS operating mode. Provides automatic cabin and avionics airflow, automatic temperature scheduling, and full cabin pressurization.
MAN	PROHIBITED



Selection of ECS MAN mode is prohibited. Selecting ECS MAN mode while the aft cooling fan shutoff valve is open may cause the fan to overspeed, resulting in a catastrophic fan failure and potential loss of OBOGS.

OFF/RAM Selects ECS OFF/RAM mode, which terminates conditioned ECS airflow. Provides ram air for cabin airflow and pressurization depending on flight conditions, and manual temperature control.

2.13.8.6 CABIN TEMP knob. The CABIN TEMP knob, located on the ECS panel on the right console, is used to control the temperature of air delivered to the cabin. In ECS AUTO mode, clockwise rotation of the CABIN TEMP knob linearly increases cabin temperature. In ECS OFF/RAM mode, the CABIN TEMP knob controls the cabin add heat valve directly, producing a nonlinear temperature response.

NOTE

- In ECS AUTO mode, cabin temperature may take 1 to 2 minutes to stabilize following a large movement of the CABIN TEMP knob.
- In ECS OFF/RAM mode, changes in the position of the CABIN TEMP knob should be held for 30 seconds due to a slower temperature response.

2.13.8.7 Cabin Louvers/Foot Air Outlet. Three sets of louvers are provided to direct airflow within the cabin, one on either side of the main instrument panel and one at the base of the center console behind the control stick. The left and right louvers have controls for elevation and azimuth. The center louver has a single control for elevation and can be closed completely by moving the lever to the full aft position. When the center louver is closed, airflow through the left and right louvers is increased.

Maximum aircrew cooling is provided by pulling the DEFOG HANDLE full aft, closing the center louver, and directing the side louvers towards the body. A fixed foot air outlet directs airflow to the base of the cabin.

2.13.8.8 Windshield Defog Outlets Fixed windshield defog outlets direct cabin air onto the inner windshield to remove and inhibit fog. Windshield fogging can occur during rapid environmental changes, such as high rates of descent and high humidity.

2.13.8.9 DEFOG Handle. The DEFOG handle, located on the right console outboard of the ECS panel, controls the division of airflow between the windshield defog outlets, the three cockpit louvers, and the foot air outlet. The DEFOG handle mechanically controls the position of the cabin air/defog diverter valve.

HIGH Directs all cabin airflow to the windshield defog outlets to maximize defog, and increases the temperature range controlled by the CABIN TEMP knob in ECS AUTO mode.

NORM Equally divides cabin airflow between the cabin louvers/foot air outlet and the windshield defog outlets. Provides adequate windshield defog for most conditions.

LOW Directs all cabin airflow to the cabin louvers and the foot air outlet to maximize cabin cooling.

2.13.9 Cabin Pressurization. The cabin is pressurized using airflow from the cabin heating and cooling system. Cabin pressurization is controlled by the CABIN PRESS switch and automatic operation of the cabin pressure regulator. Cabin pressure altitude is displayed on a cabin pressure altimeter.

Cabin pressure is controlled by the cabin pressure regulator which regulates exit airflow to maintain a pressure/altitude schedule. The cabin is unpressurized from sea level to an aircraft altitude of 8,000 feet. Between 8,000 and 24,500 feet aircraft altitude, cabin pressure is maintained at a constant 8,000 feet. Above 24,500 feet, cabin altitude increases slowly to approximately 14,500 feet at 35,000 feet aircraft altitude and 20,000 feet at 50,000 feet aircraft altitude. A rule of thumb for cabin altitude above 24,500 feet aircraft altitude is aircraft altitude x 0.4.

A cabin safety and dump valve is incorporated to limit cabin pressure if the pressure regulator fails. When the CABIN PRESS switch is placed to DUMP or RAM/DUMP, the cabin safety and dump valve opens to release pressure to the cabin pressure regulator, reducing cabin pressure to ambient.

WARNING

In ECS OFF/RAM mode, avoid operations above 25,000 feet MSL in order to prevent decompression sickness (DCS). Normal cabin pressurization is not provided. Partial cabin pressurization is available under certain circumstances, but may be lost insidiously without warning.

2.13.9.1 CABIN PRESS Switch. The CABIN PRESS switch, located on the ECS panel on the right console, is used to control cabin pressurization. The switch is lever-locked in the NORM position.

NORM Automatically regulates cabin pressurization according to the cabin pressure schedule using the cabin pressure regulator (ECS AUTO mode).

DUMP Dumps cabin pressurization. Normal ECS airflow to the cabin and the avionics is not affected.

RAM/DUMP Dumps cabin pressurization. Terminates all ECS airflow to the cabin by closing the cabin flow valve (Item 9). Cabin airflow is provided by the cabin ram air scoop. Avionics airflow is provided by a simplified control scheme.

2.13.9.2 Cabin Pressure Altimeter. A cabin pressure altimeter, located on the center console in the front cockpit and the lower left instrument panel in the rear cockpit, displays the current cabin pressure altitude.

2.13.9.3 Cabin Pressurization Warning System (CPWS). The CPWS pressure switch monitors cabin pressure and aircraft relays monitor related controls to warn aircrew of potentially hazardous cabin pressurization conditions.

2.13.9.3.1 CABIN Caution Light. The yellow CABIN caution light is located on the lower right caution lights panel. The light illuminates when cabin pressure altitude is above 21,000 +/- 1,100 feet. The light may not extinguish until cabin pressure altitude is below 16,500 feet.

WARNING

- CABIN light may appear with normal cabin pressurization when aircraft altitude is above 47,000 feet MSL. If altitude is maintained, aircrew should continuously monitor physiological condition.
- DCS may be experienced when operating with cabin pressure altitude above 25,000 feet even with a working oxygen system. Symptoms of DCS include pain in joints, tingling sensations, dizziness, paralysis, choking, and/or loss of consciousness.

NOTE

There is no corresponding DDI caution for the CABIN caution light.

2.13.9.3.2 CK ECS Caution Light. The yellow CK ECS caution light is located on the lower right caution lights panel. The light illuminates when the position of cabin pressurization related controls will inhibit cabin pressurization.

NOTE

There is no corresponding DDI caution for the CK ECS caution light.

2.13.10 Windshield Anti-ice and Rain Removal. The windshield anti-ice and rain removal systems use the same air nozzle to direct warm air over the external windshield in order to improve pilot forward visibility in icing/raining conditions. Warm air is provided by mixing engine bleed air with output from the primary heat exchanger. Windshield air nozzle orientation is intended to affect (in flight) an area roughly 20 inches to the left and 9 inches to the right of centerline at design eye level and below. System operation is controlled by the WINDSHIELD switch.

2.13.10.1 WINDSHIELD Switch. The WINDSHIELD switch, located on the right console outboard of the ECS panel, is used to select either windshield anti-ice or rain removal. The switch is lever-locked to the OFF position.

ANTI ICE Delivers a high flow rate of 290 ±20° F air to the external surface of the windshield.

OFF Terminates anti-ice/rain removal airflow.

RAIN Delivers a low flow rate of 270 ±20° F air to the external surface of the windshield.

2.13.11 Anti-g System. The anti-g system delivers air pressure to the g-suit proportional to sensed load factor. A button in the anti-g valve allows the aircrew to test system operation by manually inflating the anti-g suit. The system incorporates a pressure relief valve to prevent over-pressurization.

2.13.12 ECS RESET and AV COOL Switch.

2.13.12.1 ECS RESET. If the ECS is DEGD, selecting the ECS RESET option from the BIT/HYDRO-MECH display commands an ECS controller software reset and may restore normal functionality following a transient fault.

WARNING

Resetting the ECS controller at mid to high power settings may cause uncomfortable cabin pressure surges and ear pain.

CAUTION

Resetting the ECS controller results in the loss of system over-temperature protection for 10 to 70 seconds.

2.13.12.2 AV COOL Switch. The AV COOL switch, located on the lower right instrument panel, extends the spring-loaded FCS ram air scoop located on the right side of the forward fuselage for emergency cooling of FCC A, the right TR, and one AHRS unit. The AV COOL switch should be placed in EMERG if an FCS HOT caution is displayed or during ECS OFF/RAM mode operation as a preventative measure. Once extended, the FCS emergency ram air scoop cannot be retracted in flight.

EMERG Extends the FCS emergency ram air scoop to provide direct ram air cooling of FCC A, the right TR, and one AHRS unit, and supplemental cooling to other avionics.

NORM FCS emergency ram air scoop not extended. The switch is spring-loaded to the NORM position.

2.13.13 LCS - Liquid Cooling System. The LCS is a closed loop system normally used to transfer heat from the radar transmitter to fuel and/or ambient air. When fuel temperatures are warmer than the liquid coolant (typically at low fuel levels and high ambient temperatures), the LCS is used to transfer heat from the fuel to ambient air. The LCS contains a liquid coolant pump, a liquid coolant/air heat exchanger, and an LCS ground cooling fan (all three located in the left LEX) and two liquid coolant/fuel heat exchangers, and in LOT 26 and up, two liquid coolant/ECS air heat exchangers.

The LEX liquid coolant/air heat exchanger has one air inlet located on the bottom of the LEX, and two air exhausts. Only one exhaust path is commanded open at any given time. During LCS ground cooling fan operation, the exhaust on the bottom of the LEX is commanded open. Inflight, only the air exhaust on the top of the LEX can be commanded open.

LCS ground cooling fan air is the primary cooling source for liquid coolant on deck. During ground operations, the liquid coolant pump and LCS ground cooling fan are commanded on when power is applied to the radar (RADAR knob in STBY, OPR, or EMERG).

During ground operations, when feed tank fuel temperatures exceed 40°C (30°C in LOT 26 and up), the liquid coolant pump and LCS ground cooling fan may also be commanded on if the RADAR knob is in OFF in order to provide LCS cooling of the fuel system. In LOT 25 and below, the bypass valve, which allows liquid coolant to the liquid coolant /fuel heat exchangers, is solely controlled by the liquid coolant temperature, so the amount of fuel cooling provided (if any) depends on the temperature of

each fluid. In LOT 26 and up, the bypass valve is controlled by the ECS controller and will only allow liquid coolant to the liquid coolant/fuel heat exchanger with the RADAR knob in OFF.

NOTE

In LOT 26 and up, the RADAR knob must be in OFF in order to provide any postflight LCS fuel cooling.

In either case, placing the RADAR knob to OFF removes the radar as a heat source and should extend ground operating time.

Inflight, the LCS ground cooling fan secures, the lower air exhaust path closes, and the upper air exhaust path is controlled by the mission computer. The upper air exhaust path opens when feed tank fuel temperatures exceed 40°C (30°C in LOT 26 and up), ram air is cooler than fuel, and AOA is below 15°C. In LOT 25 and below, heat not removed by the LEX liquid coolant/air heat exchanger is removed by the fuel system through the liquid coolant/fuel heat exchangers. In LOT 26 and up, heat not removed by the LEX liquid coolant/air heat exchanger is removed by a combination of the liquid coolant/fuel and liquid coolant/ECS air heat exchangers.

In LOT 26 and up, provisions have been incorporated to limit the risk of fire following a major liquid coolant leak. When LCS low pressure is detected, the liquid coolant pump secures and check valves limit coolant leakage. Since the SDC controls the liquid coolant pump, an SDC reset secures the pump, resulting in a radar OVRHT (APG-73) or LOFLOW (APG-79) indication, and the radar stops transmitting.

NOTE

In LOT 26 and up, an SDC reset temporarily secures the liquid coolant pump. Before selecting SDC RESET, the RADAR knob should be set to STBY until the SDC reset is complete and normal radar cooling capability is restored.

2.13.14 ECS Related Warnings, Cautions, and Advisories. The following ECS related warnings, cautions, and advisories are described in the Warning/Caution/Advisory Displays in Part V:

- L BLEED and R BLEED warning lights
- BLEED AIR LEFT (RIGHT) voice alert
- AV AIR HOT caution
- L or R BLD OFF cautions
- CABIN caution light
- CK ECS caution light
- ECS ICING caution
- EXT TANK caution
- FCS HOT caution
- FLIR OVRHT caution
- GUN GAS caution
- TK PRES LO caution
- TK PRES HI caution
- WDSHLD HOT caution
- ECSDR advisory

WARNING

If ECS troubleshooting has been done while on deck, check for an 8A6 MSP code after takeoff. An 8A6 MSP code is set by a system flow modulating regulating valve failure. This failure can potentially lead to an unexpected loss of cabin pressurization.

2.14 OXYGEN SYSTEMS

2.14.1 On Board Oxygen Generating System (OBOGS). OBOGS provides oxygen rich breathing gas to the aircrew while either engine is operating. Engine bleed air is cooled and routed through the OBOGS inlet air shutoff valve to the OBOGS concentrator. The breathing gas is routed from the concentrator to a cockpit plenum, where the temperature is stabilized and a limited supply is stored for peak flow demands. From the plenum, the breathing gas flows through the pilot services panel oxygen disconnect, through the seat survival kit, to the aircrew regulators and masks.

WARNING

A leak or break in the breathing gas system anywhere from the pilot services panel oxygen disconnect to the mask will prevent either normal OBOGS breathing gas or emergency oxygen from being delivered to the mask in its intended concentration. Leaks and breaks may be difficult to locate and/or verify. If hypoxic symptoms are experienced or an OBOGS system degrade occurs, immediate descent below 10,000 feet cabin altitude is required to prevent severe or incapacitating hypoxia.

The OBOGS concentrator is powered by the left 115 volt ac bus. Two molecular sieve beds in the OBOGS concentrator remove most of the nitrogen from the engine bleed air. The nitrogen is dumped overboard while the remaining output of oxygen rich breathing gas is supplied to the aircrew.

2.14.1.1 OBOGS Monitor. The CRU-99/A solid state oxygen monitor is located on the left side of the seat bulkhead in the front cockpit and is powered by the left 28 volt dc bus. The monitor continuously measures oxygen concentration in the OBOGS breathing gas and provides a discrete signal to activate the OBOGS DEGD caution if the oxygen concentration falls below a predetermined level.

WARNING

Loss of electrical power to the OBOGS monitor prevents reporting of OBOGS DEGD conditions.

The monitor performs a power-up BIT during a 2 minute warm-up period and conducts a periodic BIT every 60 seconds. No indication is provided if power-up or periodic BIT pass.

Preflight BIT of the monitor is accomplished by using either the pneumatic BIT plunger or the electronic BIT pushbutton. Refer to figure 2-33. Pressing up and holding the pneumatic BIT plunger for 15 to 65 seconds tests the operation of the OBOGS monitor by diverting cabin air into the monitor to create a low oxygen concentration condition.

WARNING

After initiating OBOGS pneumatic BIT, failure to ensure plunger is fully extended may result in contamination of OBOGS plenum which may lead to hypoxic conditions.

Momentarily pressing and releasing the electronic BIT pushbutton tests the monitor electronically. Successful completion of either test activates the OBOGS DEGD caution, which clears automatically

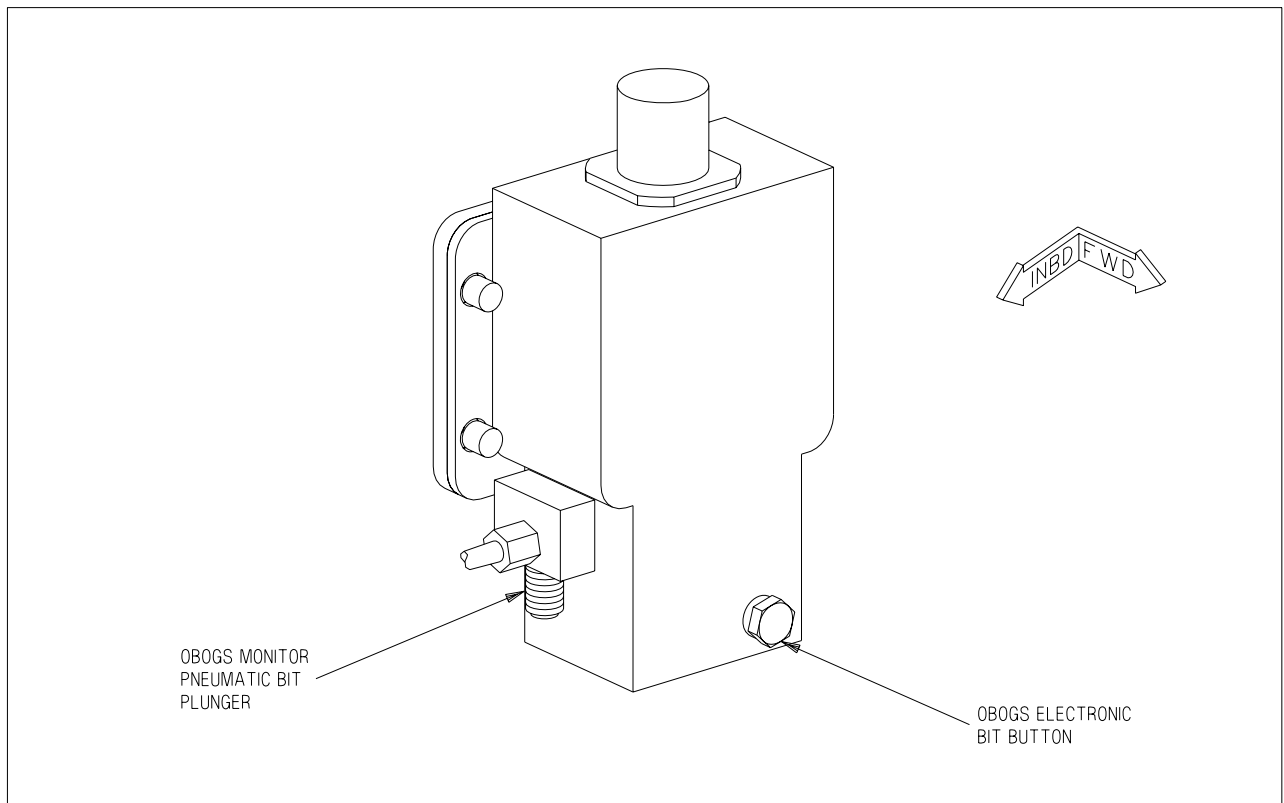

EFN520-368-1-004

Figure 2-33. OBOGS Monitor

after BIT is complete and OBOGS resets to normal operation.

WARNING

Successful OBOGS monitor BIT is required prior to flight. A BIT failure indicates that there is no protection against inadequate oxygen concentration or hypoxia due to a degraded OBOGS monitor. Good breathing gas flow alone does not ensure adequate oxygen concentration.

2.14.1.1.1 OBOGS DEGD Caution. An OBOGS DEGD caution is set by the OBOGS monitor when oxygen concentration is below a predetermined level. The OBOGS DEGD caution threshold is always above cabin air conditions, in order to provide a physiological safety margin.

NOTE

Oxygen concentration may drop below the predetermined OBOGS DEGD level if breathing gas flow is unlimited. Removing the mask without placing the OXY flow knob to OFF, system leaks, and/or loose aircrew hose connections can overwhelm system capacity and may result in an OBOGS DEGD caution.

After a total loss of bleed air, OBOGS breathing gas flow will be available until the residual gas within the system is depleted. The residual oxygen concentration may be sufficient to keep the OBOGS

DEGD caution from illuminating, but loss of system pressure will ultimately lead to inadequate pressure and an abrupt inability to breathe.

Low mask flow or increased breathing resistance may occur without an accompanying OBOGS DEGD caution, which indicates a potential system degradation that may result in oxygen levels below physiological requirements.

WARNING

When cabin altitude is above 10,000 feet, OBOGS DEGD caution procedures shall be executed for low mask flow, increased breathing resistance, or OBOGS DEGD cautions of any duration.

A single brief appearance of the OBOGS DEGD caution immediately following placing the OBOGS control switch to ON, turning the OXY FLOW knob to ON, or after donning or removing the mask is normal. Certain malfunctions affecting the OBOGS system also may momentarily cause OBOGS DEGD cautions. A momentary OBOGS DEGD caution may clear from the DDI so rapidly that the aircrew may be unable to determine the cause of the MASTER CAUTION light/tone.

CAUTION

Repeated unexplained MASTER CAUTION lights/tones may be an indication of OBOGS system degradation.

Even with the OBOGS DEGD caution displayed, OBOGS breathing gas under normal flow is of higher quality (i.e., oxygen concentration, partial pressure and purity) than cabin air. Once cabin altitude is below 10,000 feet, aircrew may elect to conserve emergency oxygen by resetting the emergency oxygen release tab, then either removing the mask and breathing cabin air, or returning the OXY FLOW knob and the OBOGS control switch to ON and breathing through the mask.

WARNING

Pure oxygen accelerates recovery from hypoxia. Emergency oxygen shall be used whenever hypoxic symptoms are recognized.

2.14.1.2 Breathing Regulator. The aircrew torso mounted breathing regulator reduces both normal and emergency oxygen system operating pressures to breathing pressure levels. The regulator delivers undiluted OBOGS breathing gas or emergency oxygen to the aircrew at positive pressure, the limits of which increase automatically with altitude. It interfaces with the hose assembly, which connects with the seat survival kit oxygen disconnect.

2.14.1.3 OBOGS Control Switch. The OBOGS control switch, located on the left console in the front cockpit, is used to control electrical power to the OBOGS concentrator and the OBOGS inlet air shutoff valve.

- ON Supplies electrical power and engine bleed air to the OBOGS concentrator.
- OFF OBOGS system off.

2.14.1.4 OXY FLOW Knob. The OXY FLOW knob, located on the left console in both cockpits, is used to control the supply of OBOGS breathing gas to each aircrew's mask.

- ON OBOGS flow supplied to the mask.
- OFF OBOGS flow secured.



It is possible to place the OXY FLOW knob in an intermediate position between the ON and OFF detents, which may result in a reduced flow of breathing gas. The OXY FLOW knob should always be fully rotated to the ON or OFF detent position.

2.14.2 Emergency Oxygen. Emergency gaseous oxygen is contained in a bottle in the seat survival kit. The bottle is connected into the OBOGS supply hose as it passes through the kit. From this point, the emergency oxygen and OBOGS breathing gas share a common path to the aircrew mask.



A leak or break in the breathing gas system anywhere from the pilot services panel oxygen disconnect to the mask will prevent either normal OBOGS breathing gas or emergency oxygen from being delivered to the mask in its intended concentration. Leaks and breaks may be difficult to locate and/or verify. If hypoxic symptoms are experienced or an OBOGS system degrade occurs, immediate descent below 10,000 feet cabin altitude is required to prevent severe or incapacitating hypoxia.

A pressure gauge is visible on the inside left front of the survival kit. The bottle provides approximately 10–20 minutes of oxygen. Oxygen duration decreases with lower altitude.



Under less than optimum conditions (low altitude, heavy breathing, loose-fitting mask, etc.), as few as 3 minutes of emergency oxygen may be available.

The emergency oxygen supply is activated automatically upon ejection. The emergency oxygen supply may be activated manually by pulling the emergency oxygen green ring on the outside of the left thigh. The emergency oxygen supply may be deactivated at aircrew discretion by pushing down on the release tab immediately forward of the green ring.

WARNING

With emergency oxygen selected, the OXY FLOW knob(s) shall be placed to OFF. If not secured, OBOGS system pressure may prevent emergency oxygen from reaching the breathing regulator. Additionally, the OBOGS control switch should be placed to OFF to backup the OXY FLOW knob.

2.15 FIRE DETECTION, FIRE EXTINGUISHING, AND BLEED AIR LEAK DETECTION SYSTEMS

The fire detection system contains dual-loop fire detectors and three FIRE warning lights. The fire extinguishing system contains a READY/DISCH light and a fire extinguisher bottle. The two systems provide engine bay, AMAD bay, and APU bay fire warning, engine and APU emergency shutdown, and selective fire extinguishing capability. The fire extinguisher bottle is located in the aft fuselage between the engines. The bottle contains a nontoxic gaseous agent which provides a one-shot extinguishing capability.

Electrical power from the 28 vdc essential bus is required to operate the fire detection and extinguishing systems. The systems can operate on battery power alone with the BATT switch ON.

A separate dry bay fire suppression (DBFS) system is incorporated to automatically detect and extinguish a fire or explosion in the dry bays below fuel tanks 2, 3, and 4.

2.15.1 FIRE Lights. Two FIRE warning lights, one for each engine/AMAD bay, are located on the upper left and right sides of the main instrument panel. The warning lights come on when a fire condition is detected in the respective engine/AMAD bay. The left FIRE light indicates a fire condition in the left engine/AMAD bay. The right FIRE light indicates a fire condition in the right engine/AMAD bay.

Each light is a pushbutton, which is guarded to prevent inadvertent actuation. Pushing the left or right FIRE light arms the fire extinguisher bottle (FIRE EXTGCH READY light on) and closes the corresponding engine feed shutoff valve, the crossfeed valve, and the crosscooling valve.



Because the engine VEN/start pumps are fuel lubricated, pushing a FIRE light prior to throttle OFF may damage the corresponding pump. To reduce the likelihood of damage, FIRE lights should only be pressed as directed by NATOPS (following throttle OFF for actual emergencies or as specifically delineated for an FCF A profile).

If a FIRE light is pressed, the pushbutton stays in and approximately 1/8 inch of yellow and black stripes is visible around the outer edges of the light.

2.15.2 APU FIRE Light. The APU FIRE warning light is located on the main instrument panel inboard of the right FIRE light. The APU FIRE light comes on when a fire condition is detected in the APU bay. The APU FIRE light is also a pushbutton. Pushing the APU FIRE light arms the fire extinguisher bottle (FIRE EXTGCH READY light on) and secures fuel to the APU. If the APU FIRE light is depressed, the pushbutton stays in and approximately 1/8 inch of yellow and black stripes is visible around the outer edges of the light.

2.15.3 FIRE Warning Voice Alerts. When the left, right, and/or APU FIRE lights are illuminated, the ENGINE FIRE LEFT, ENGINE FIRE RIGHT, or APU FIRE voice alerts, respectively, are also activated. If more than one FIRE light comes on at the same time, the voice alert priority is LEFT, RIGHT, then APU.

2.15.3.1 FIRE Warning Lights (F/A-18F). The rear cockpit left, right, and APU FIRE warning lights are advisory only. These lights are not pushbuttons, and they do not arm the fire extinguisher bottle or shut down the engines or APU.

2.15.4 FIRE EXTGCH READY/DISCH Light. The FIRE EXTGCH READY/DISCH light is located on the MASTER ARM panel on the left side of the main instrument panel. The top half of the light is yellow and is labeled READY. The bottom half of the light is green and is labeled DISCH. When the fire extinguisher bottle is armed (left, right, or APU FIRE light pressed), the yellow READY light is illuminated.

The FIRE EXTGCH READY/DISCH light is also a pushbutton. When the READY light is on, pushing the light discharges the fire extinguisher bottle into the selected engine/AMAD/APU bay(s). The FIRE EXTGCH READY/DISCH light does not latch like the FIRE lights, which means a signal is sent to discharge the fire extinguisher bottle ONLY when the light is held in the fully pressed position. When the fire extinguisher bottle has discharged or pressure has been lost, the green DISCH light comes on. Therefore, it is good practice with an engine/AMAD bay fire to hold the READY/DISCH light pressed until the green DISCH light comes on. The fire extinguisher bottle should discharge within 5 seconds.

For an inflight APU fire, discharge of the fire extinguisher bottle is delayed approximately 10 seconds from when the APU FIRE light is pushed. It is not necessary to hold the READY/DISCH light for those 10 seconds. However, if the DISCH light does not come on 10 seconds after the APU FIRE

and READY/DISCH lights have been pushed, the READY/DISCH light should be pushed and held until the DISCH light does come on.

If more than one FIRE light is pressed, the fire extinguisher bottle may not discharge and, if it does, the concentration of the extinguishing agent sent to the selected bays may be insufficient to extinguish both fires.

2.15.5 APU Fire Extinguishing System. The APU fire extinguishing system is automatically activated with WonW and must be manually activated with WoffW. If an APU fire condition is detected with WonW, the automatic function secures fuel to the APU, arms the fire extinguisher bottle, and after 10 seconds discharges the fire bottle. Discharge of the bottle is delayed for 10 seconds to allow the APU time to spool down before extinguishing agent is introduced.

Manual activation is accomplished by pushing the APU FIRE light and then the FIRE EXTGH READY light. Like automatic activation, discharge of the bottle is delayed for 10 seconds after the APU FIRE light is pushed. If an APU FIRE condition is detected with WonW, manual activation should be performed to backup the automatic system.

WARNING

Since the fire extinguishing system requires 28 vdc essential bus power, the fire extinguisher bottle may not be discharged if the BATT switch is turned off during the 10 second delay time.

2.15.6 Engine/AMAD Fire Extinguishing System. The engine/AMAD fire extinguishing system must be manually activated. Manual activation is accomplished by lifting the guard and pressing the corresponding FIRE light and then the FIRE EXTGH READY light. Pushing the FIRE light secures fuel to the engine at the engine feed shutoff valve and isolates the left and right fuel systems by closing the crossfeed and crosscooling valves. When the FIRE EXTGH READY light is pushed, the fire extinguisher bottle is discharged without delay into the corresponding engine/AMAD bay.

WARNING

Fire testing indicates that the probability of extinguishing a fire and preventing relights is greatly increased by immediately discharging the fire extinguisher.

2.15.7 FIRE Detection System Test. Each of the three FIRE warning lights contains four individual light bulbs. Light bulb integrity can be tested during a LT TEST with ac power applied. If a malfunction exists in a fire detection loop associated with the APU FIRE light, the APU FIRE voice alert does not annunciate and none of the four individual bulbs in the light illuminate. If a malfunction exists in a fire detection loop associated with either FIRE light, the corresponding ENGINE FIRE LEFT/RIGHT voice alert does not annunciate and only the individual bulb (or bulbs) associated with the malfunctioning sensor does not come on. Care must be taken to detect bulbs that are not on in the FIRE lights during the loop test.

A successful test of the FIRE detection system should illuminate all four bulbs in each of the three FIRE lights and should annunciate the ENGINE FIRE LEFT, ENGINE FIRE RIGHT, and APU FIRE voice alerts.

2.15.8 Bleed Air Leak Detection (BALD) System. The BALD system is designed to protect the aircraft from damage resulting from a bleed air leak. The system contains a BALD controller and 11 detector sensing elements routed along the bleed air distribution lines (ducts, valves, and heat exchangers). If a bleed air leak is detected, the system attempts to isolate the affected ducting by automatically closing the appropriate bleed air shutoff valve(s). A leak detected upstream of the secondary bleed air shutoff valve closes only the appropriate primary bleed air shutoff valve. A leak detected downstream of the secondary bleed air shutoff valve closes all three valves (secondary and both primaries).

When a leak is detected, the BALD system sends commands directly to the appropriate bleed air shutoff valves, to the BLEED warning lights, and to the ACI, triggering the BLEED AIR LEFT (RIGHT) voice alerts. When the bleed air shutoff valve(s) are commanded closed, the appropriate L and/or R BLD OFF caution is displayed. The L BLEED and/or R BLEED warning lights extinguish as soon as bleed air is removed from the leaking duct and may not be on long enough to be recognized by the aircrew.

WARNING

Automatic functioning of the BALD system may extinguish the L(R) BLEED warning lights prior to aircrew recognition and may not trigger the appropriate voice alerts. In this case, cycling the BLEED AIR knob to remove the L and/or R BLD OFF cautions reintroduces hot bleed air to the leaking duct. If the sensing element was damaged by the leak, automatic shutdown and isolation capability may be lost. Extensive damage and/or fire may result.

The BALD controller also sends a separate command to the SDC which sets an MSP code for the appropriate sensing element.

A bleed air leak can be verified by MSP codes 953, 954, 955, 956, 957, 958, 959, 960 or 961 (code determines leak location). An overpressure condition is indicated by MSP code 833 with no bleed air leak codes.

CAUTION

Sustained high power, high speed operation at low to medium altitude may result in dual BLEED warnings and loss of OBOGS, cabin pressurization, and g-suit due to secondary bleed air pressure regulator bay overheating.

2.15.8.1 Bleed Air Leak Detection System Test. The BALD system is tested by the FIRE test switch in conjunction with the FIRE detection system. Actuation of the FIRE test switch tests the BALD system sensors and circuitry. The BALD controller turns on the L and R BLEED warning lights, annunciates the BLEED AIR LEFT/RIGHT voice alerts, and commands the bleed air shutoff valves closed setting the L and R BLD OFF cautions. The warnings and cautions indicate that the test has successfully passed.

The L BLEED and R BLEED warning lights go out when the FIRE test switch is released to NORM, but the L and R BLD OFF cautions remain until the BLEED AIR knob is cycled through OFF to NORM with ac power applied.

2.15.8.2 FIRE Test Switch. The FIRE test switch, located on the forward left console, is used to initiate a test of the FIRE detection and BALD systems. Operation of the FIRE test switch requires 28 vdc essential bus power. The switch is spring-loaded to the NORM position.

- TEST A Initiates a test of loop A of the fire detection and BALD systems.
- NORM Provides normal fire and bleed air leak detection.
- TEST B Initiates a test of loop B of the fire detection and BALD systems.

A successful test of the FIRE detection and BALD systems should illuminate all four bulbs in the left, right, and APU FIRE lights, both L BLEED and R BLEED warning lights, and should annunciate all of the following voice alerts in order: "ENGINE FIRE LEFT, ENGINE FIRE RIGHT, APU FIRE, BLEED AIR LEFT, BLEED AIR RIGHT" (each repeated twice).

The BALD controller is sensitive to the duration of FIRE test switch actuation. If the switch is not held in the TEST A or TEST B position for at least 2 seconds, the BALD controller may set a false MSP code. Additionally, the BALD controller requires 3 seconds between TEST A and TEST B to successfully reset. If the switch does not remain in NORM for at least 3 seconds, the BALD controller may not successfully initiate the bleed air warnings and may set a false MSP code.

2.15.9 DBFS - Dry Bay Fire Suppression System. An active DBFS system is incorporated in the center dry bays under fuel tanks 2, 3, and 4 to automatically extinguish any fires or explosions which are detected in these areas. The system consists of fourteen optical fire detectors, seven extinguishing units and a control unit. The control unit integrates system operation and performs BIT. If the DBFS system fails BIT, a BIT advisory appears, and DBFS BIT status indicates DEGD.

The DBFS system is totally automatic and requires no aircrew action. The system is armed and capable of suppressing a fire/explosion in the dry bays when the LDG GEAR handle is up and at least one generator is on line. If a fire/explosion is detected, the controller discharges all extinguishers, flooding all dry bays with an inert gas (BAY DISCH caution set). If a fire condition is still detected after 3 seconds, a BAY FIRE caution is set to alert the aircrew that the fire was not extinguished. If the fire condition ceases, the BAY FIRE caution resets. With the LDG GEAR handle down, the system still gives a fire warning (BAY FIRE caution) but is not capable of extinguishing a dry bay fire.

2.16 ENTRANCE/EGRESS SYSTEMS

2.16.1 Canopy System. The cockpit is enclosed by a clamshell type canopy. The main components of the canopy system are an electromechanical actuator, which provides powered and manual operation of the canopy, and a cartridge actuated thruster with associated rocket motors, which provides emergency jettison. When closed, the canopy is latched in place by three hooks on the bottom of each side of the canopy frame and two forward indexer pins on the lower leading edge of the canopy frame. When the canopy is closed, the latch hooks and indexer pins engage fittings along the canopy sill, and the canopy actuator rotates the canopy actuation link over-center, locking the canopy. A mechanical brake in the canopy actuator motor provides a redundant lock. An inflatable seal, installed around the edge of the canopy frame, retains cockpit pressure when the canopy is locked. A rain seal is installed outboard of the pressure seal to divert rain water away from the cockpit. See figure 2-34.

WARNING

A high voltage (100,000 volt) static electrical charge may build up in flight and be stored in the canopy. If possible, make sure that ground crew discharge the static electricity prior to egress. Otherwise, avoid direct contact with the outside of the windscreen and canopy to prevent electrical shock.

CAUTION

Taxiing with the canopy at an intermediate position can result in canopy attach point damage and failure. Do not open or close the canopy with the aircraft in motion.

2.16.1.1 Canopy Operation. During normal operation, the canopy is electrically actuated using either the internal CANOPY switch or external canopy switch. The canopy actuator is powered by the maintenance bus, which is powered directly by the battery in the absence of ac power (BATT switch ON or OFF). On battery power, at least five open/close cycles should be available. With the canopy open, the CANOPY switch must be held to lower the canopy to the rails, slide it approximately 1.5 inches forward, and lock it in place. With the canopy closed and locked, selecting OPEN on the CANOPY switch (WonW) automatically unlocks and opens the canopy to the full up position. The switch does not have to be held. Whether the canopy is opening or closing, selecting HOLD stops the canopy at its present position.

If electrical power is not available, the canopy can be manually operated using either an internal or external crank system. The canopy can be jettisoned using one of the internal CANOPY JETT handles.

2.16.1.1.1 CANOPY Switch (Internal). The internal CANOPY switch is located beneath the right canopy sill in the front cockpit. In LOT 26 and up, the rear cockpit CANOPY switch is located on the lower right portion of the instrument panel. The CANOPY switch is spring loaded to the HOLD position and is solenoid-held in the OPEN position only with WonW. The solenoid can be overridden at any time by placing the switch to HOLD. With WoffW, the switch must be held in the OPEN position to raise the canopy. Opposing position control commands between the front cockpit and rear cockpit switches result in a fail-safe OPEN command.

OPEN	Unlocks and/or raises the canopy.
HOLD	Stops the canopy at any point during the open or close cycle.
CLOSE	Lowers and, if held, closes and locks the canopy (CANOPY caution out when closed and locked).

2.16.1.1.2 Canopy Switch (External). The external canopy switch is located inside the external power receptacle door (door 9) on the left side of the aircraft below the canopy and LEX. The switch provides electrical operation of the canopy from outside the cockpit. The switch has the same positions and operates identically to the internal CANOPY switch, except that the OPEN position is not solenoid held. After AFC 366, the switch is guarded to prevent inadvertent actuation.

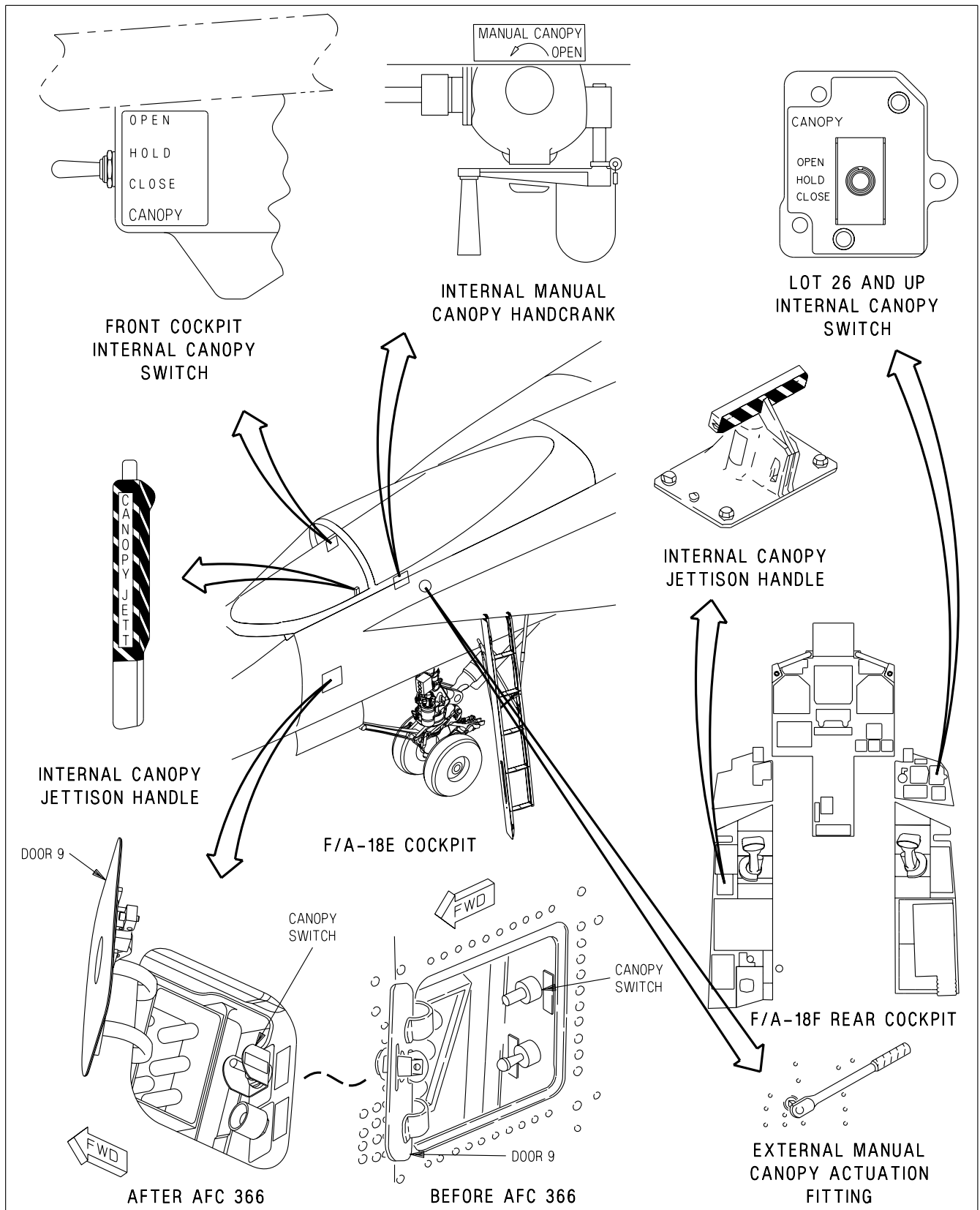

EFN520-47-1-015

Figure 2-34. Canopy Controls

2.16.1.1.3 Manual Canopy Handcrank (Internal). The internal manual canopy handcrank is stowed in a clip beneath the left canopy sill. The canopy can be manually opened or closed by inserting the handcrank into the crank socket immediately above the stowage clip. Approximately 70 counterclockwise turns are required to fully open the canopy. Clockwise cranking closes the canopy. A cable is provided to prevent loss of the handle if dropped.

2.16.1.1.4 Manual Canopy Actuation Fitting (External). The external manual canopy actuation fitting, a 3/8 inch drive socket on the left side of the aircraft below the canopy, is used to manually operate the canopy. Inserting a 3/8 inch drive tool in the socket and then turning counterclockwise approximately 35 turns opens the canopy. Turning the drive tool clockwise closes the canopy.

2.16.1.2 Canopy Jettison System. For canopy jettison, a cartridge initiated thruster is utilized to unlatch the canopy by moving it 1.5 inches rearward, after which two canopy frame mounted rocket motors fire to rotate the canopy up and aft, clear of the ejection seat path. The thruster, which provides attachment for the canopy actuator link during normal canopy operation, is activated by pulling the ejection seat firing handle or internal canopy jettison handle(s) (figure 2-34). The canopy can be jettisoned closed, open, or in any intermediate position.

2.16.1.2.1 CANOPY JETT Handle. The CANOPY JETT handle is black and yellow striped and is located on the left inboard canopy sill just aft of the instrument panel in the front cockpit. Pressing the button on the tip of the handle unlocks the handle. Pulling the handle aft initiates the canopy jettison sequence. A “remove before flight” pin is used to manually secure the CANOPY JETT handle between flights.

2.16.1.2.2 CANOPY JETT Handle (F/A-18F). The rear cockpit CANOPY JETT handle is black and yellow striped and is located on the left console. Pressing the button on the forward tip of the handle unlocks the handle. Pulling the handle up initiates the canopy jettison sequence. A REMOVE BEFORE FLIGHT pin is used to manually secure the CANOPY JETT handle between flights.

2.16.2 Boarding Ladder. A five-step boarding ladder (figure 2-35), stowed under the left LEX, provides access to the cockpit and the top of the aircraft. Ladder extension and retraction can be accomplished only from outside the cockpit, either manually or by the ladder remote release button (after AFC 366) or switch (before AFC 366).

The ladder is extended manually by releasing the latch on the stow assist handle on the ladder’s left rail (allowing it to drop slightly) and while supporting the ladder, rotating the stow assist handle to vertical (releasing the remaining two mechanical uplocks on the underside of the LEX). The ladder rotates down to the extended position. The stow assist handle is then secured. The drag brace locks when extended to its full length to provide longitudinal stability for the ladder. Lateral stability is provided by the V-shaped side brace attached to the side of the fuselage.

WARNING

The LEX is narrow and highly sloped. Use caution to avoid loss of footing.

NOTE

The ladder is not visible from the cockpit.

Normal cockpit egress is accomplished by grasping the canopy sill firmly with both hands, leaning outboard and, using the ladder marking decals as a guide, stepping over the LEX toward the ladder. The first step is approximately 15 inches below the leading edge of the LEX.

The ladder is stowed by detaching the rigid side brace connection from the fuselage. Pulling the collar on the drag brace down permits the telescoping drag brace to unlock and compress as the boarding ladder is rotated up and aft to the stowed position. The latches are manually engaged and locked by pushing them full up until locked flush with the forward beam. If necessary, the stow assist handle can be used to assist in stowing the ladder by releasing the handle and pushing the ladder to the stowed position and pushing the stow assist handle to the closed (stowed) position and releasing it. With electrical power on the aircraft, a LADDER caution comes on whenever the proximity switch in the aft portion of the ladder well is not actuated. With the ladder stowed and the 3 latches locked, the LADDER caution goes out.

The ladder is extended remotely by opening the ground power receptacle door and holding the ladder remote release switch (lower switch) to the down (DEPLOY) position. The three latches are opened by a battery powered actuator. The ladder drops to the open position while being restrained from free falling by a dampening strut (drop time approximately 3 to 4 seconds). All other procedures for securing the ladder are the same as manual opening.

2.16.2.1 Ladder Remote Release Switch (Before AFC 366). The external ladder remote release switch is located inside the external power receptacle (door 9) on the left side of the aircraft below the canopy and LEX. The switch is lever locked and spring loaded to the UP position. Switch positions are:

UP	Removes electrical power from the unlock actuators which allows the ladder to lock when it is manually stowed.
DEPLOY	Applies electrical power to the three unlock actuators which unlocks the actuators so the ladder can free fall. The switch must be pulled out and down and held in DEPLOY until the actuators are unlocked.

WARNING

Due to the close proximity of the ladder remote release switch and the external canopy switch, positive switch identification is required to prevent inadvertently lowering the canopy and injuring personnel egressing the aircraft.

2.16.2.2 Ladder Remote Release Button (After AFC 366). The guarded external ladder remote release button is located inside the external power receptacle (door 9) on the left side of the aircraft below the canopy and LEX. Pressing and holding the button applies electrical power to the three unlock actuators which unlocks the actuators so the ladder can free fall.

2.16.3 Ejection Seat. The SJU-17 (V)1/A, 2/A, and 9/A, and SJU-17A (V)1/A, 2/A, and 9/A NACES (Navy Aircrew Common Ejection Seat) are ballistic catapult/rocket systems that provide the pilot with a quick, safe, and positive means of escape from the aircraft. See Ejection Seat, foldout section, for ejection seat illustrations. The seat system includes an initiation system which, after jettisoning the canopy and positioning the occupant for ejection, fires the telescopic seat catapult. Canopy breakers on the top of the seat give capability of ejecting through the canopy. As the seat departs the aircraft and the catapult reaches the end of the stroke a rocket motor on the bottom of the seat is fired. The thrust

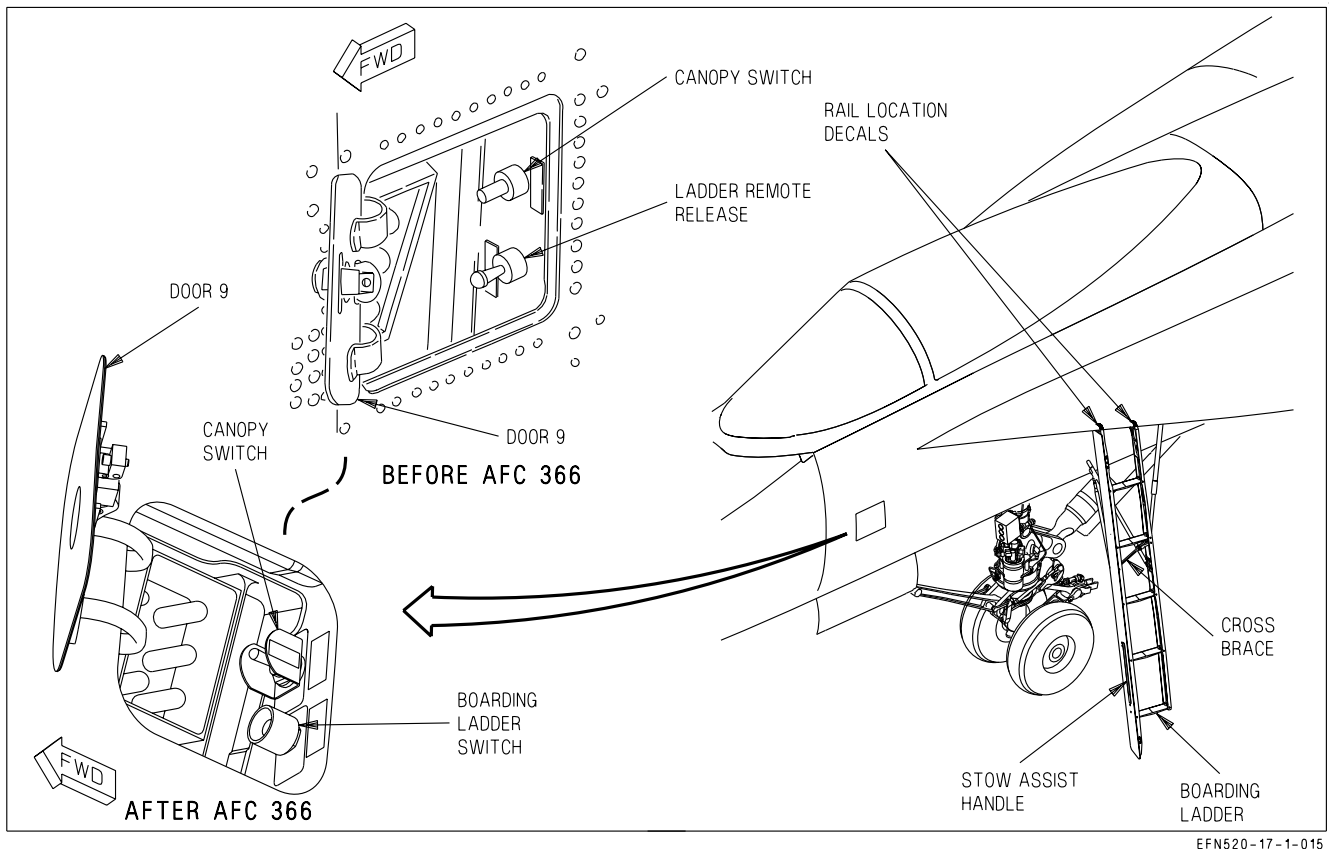

Figure 2-35. Boarding Ladder

of the rocket motor sustains the thrust of the catapult to eject the seat to a height sufficient for parachute deployment even if ejection is initiated at zero speed, zero altitude in a substantially level attitude.

NOTE

Safe escape is provided for most combinations of aircraft altitude, speed, attitude, and flight path within the envelope of 0 to 600 KCAS airspeed and 0 to 50,000 feet.

2.16.3.1 SJU-17(V) 1/A, 2/A, and 9/A, and SJU-17A (V)1/A, 2/A, and 9/A NACES Seat. Timing of all events after rocket motor initiation is controlled by the electronic sequencer which utilizes altitude, acceleration, and airspeed information to automatically control drogue and parachute deployment and seat/man separation throughout the ejection seat's operational envelope. In the event of partial or total failure of the electronic sequencer, a 4-second mechanical delay initiates a barostatic release unit which frees the occupant from the seat and deploys the parachute between 14,000 and 16,000 feet MSL if the ejection occurred in or above this altitude range. The emergency barostatic release unit operates immediately after the 4-second delay if the ejection occurred below 14,000 feet MSL. An emergency restraint release (manual override) system provides a backup in the event of failure of the barostatic release unit. The seat is stabilized and the forward speed retarded by a drogue chute attached to the top and bottom of the seat. The parachute deployment rocket is automatically fired to withdraw the parachute from deployment bag. Full canopy inflation is inhibited until the g forces are sufficiently reduced to minimize opening shock. There are 5 modes of operation. See figure 2-36 for parameters that determine the mode of operation and the corresponding parachute deployment and drogue chute

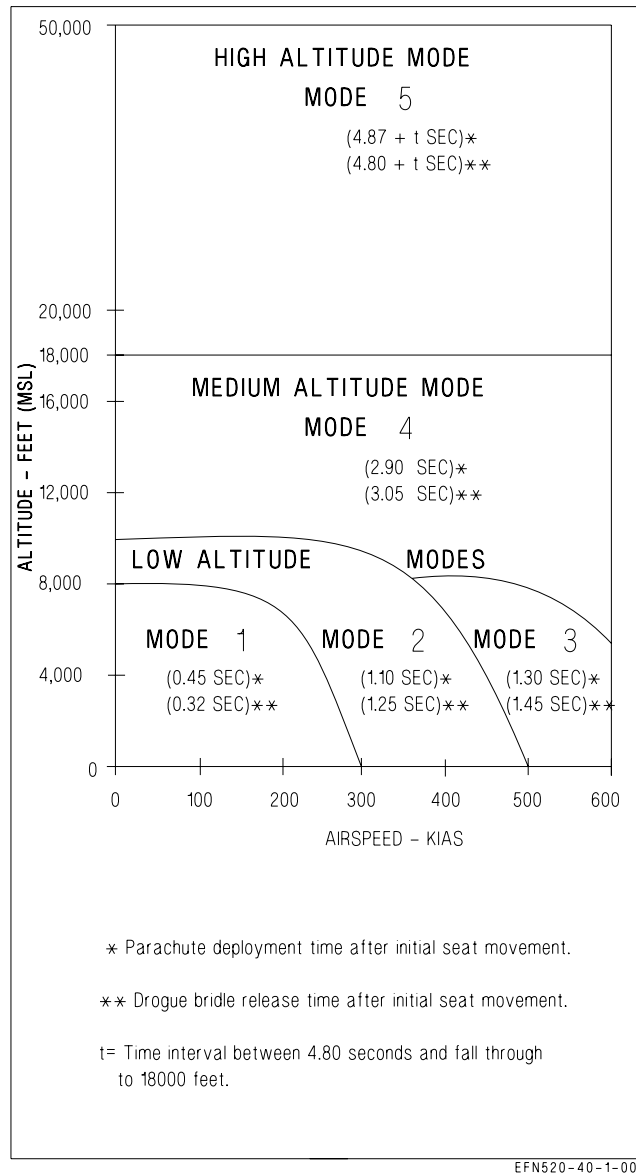

Figure 2-36. SJU-17 and SJU-17A Ejection Modes

release times. At high altitude the drogue chute deploys to decelerate and stabilize the seat. The seat falls drogue retarded to 18,000 feet MSL where the drogue is released, the main parachute is deployed, and seat/man separation occurs. At medium altitude, (between 18,000 and 8,000 feet MSL), and at low altitude (below 8,000 feet MSL) parachute deployment is automatically delayed from 0.45 to 2.90 seconds (depending upon airspeed and altitude) after first seat motion to allow the drogue chute to decelerate and stabilize the seat.

The main parachute is a 21 foot aeroconical canopy type, stored in a headbox container on top of the ejection seat. The parachute is steerable and contains water deflation pockets which aid in dumping air from the canopy after landing in water. The seat drogue chute is stored in a separate container on top of the drogue deployment catapult. The seat contains controls for adjusting seat height and for locking and unlocking the inertia reel shoulder restraint straps. A survival kit is installed in the seat pan.

2.16.3.2 SEAWARS - SEAWATER Activated Release System. SEAWARS is a seawater activated system that automatically releases the parachute from the crew member. When the sensing-release units are immersed in seawater, cartridges are fired which allow the crew member to separate from the parachute.

2.16.3.3 Ejection Control Handle. The ejection control handle, located between the crewman's legs on the front of the seat pan, is the only means by which ejection is initiated. The handle, molded in the shape of a loop, can be grasped by one or two hands. To initiate ejection, a 20 to 40 pound pull removes the handle from its housing, and a continued pull of 30 to 60 pounds is required to pull both sears from the dual initiators. Either of the initiators can fire the seat. After ejection, the handle remains attached to the seat. The ejection control handle safes the ejection seat safe/armed handle.

2.16.3.4 Ejection Seat SAFE/ARMED Handle. To prevent inadvertant seat ejection, an ejection seat safe/armed handle is provided. The handle, forward on the right seat armrest, safeties the seat when rotated up and forward, and arms the seat when it is rotated aft and down. The safe/armed handle is locked when placed to either of these two positions and the handle must be unlocked by squeezing a locking lever within the handle cutout before changing positions. When in the armed position the visible portion of the handle (from the occupant's vantage point) is colored yellow and black with the word ARMED showing. In the safe position, the visible portion is colored white with the word SAFE showing. The seat is safe only when the word **SAFE** is entirely visible on the inboard side of the SAFE/ARM handle and the handle is locked in the detent. Placing the handle to the SAFE position causes a pin to be inserted into the ejection firing mechanism to prevent withdrawal of the sears from the dual seat initiators.

2.16.3.4.1 CK SEAT Caution. The CK SEAT caution light is located on the caution light panel and repeats the DDI CHECK SEAT caution. The caution comes on when the right throttle is at MIL or above, weight is on wheels, and the ejection seat is not armed.

2.16.3.5 Shoulder Harness Inertia Reel. Pilot shoulder harness restraint is provided by a dual strap shoulder harness inertia reel mounted in the seat below the parachute container. The dual inertia reel shoulder straps connect to the parachute risers which in turn are buckled to the seat occupant's upper harness. The inertia reel locks when the reel senses excessive strap velocity. Manual locking and unlocking of the reel is controlled by the shoulder harness lock/unlock handle on the left side of the seat bucket. During ejection a pyrotechnic cartridge is fired to retract the shoulder harness to position the seat occupant for ejection.

2.16.3.6 Shoulder Harness Lock/Unlock Handle. The shoulder harness lock/unlock handle on the left side of the seat bucket has two positions. To operate, the handle must be pulled up against spring pressure, moved to the desired position, and released.

FORWARD (locked) The inertia reel prevents the reel straps from being extended and ratchets any slack in the straps back into the reel.

AFT (unlocked) The reel allows the pilot to lean forward, but the inertia portion of the reel continues to protect by locking the reel when it senses excessive strap velocity. Once locked, the pilot can normally lean forward again after a slight release in pressure on the reel straps.

2.16.3.7 Leg Restraint System. A leg restraint system is located on the front of the ejection seat. The function of the system is to secure the occupant's legs to the seat during ejection. The system consists of two adjustable leg garters, a restraint line, and a snubber box for each leg. One garter is worn on the

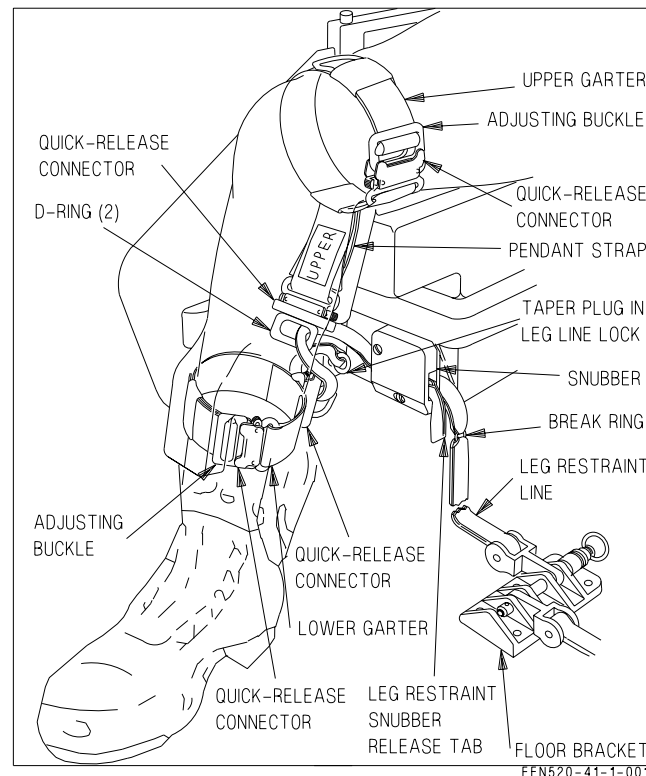

Figure 2-37. Leg Restraint System

thigh and one on the lower leg. The restraint lines are routed through the garter rings and the snubber box as shown in figure 2-37. One end of each restraint line is secured to the cockpit floor and the other, after being routed through the snubber box and both garter rings, is secured to the seat just outboard of the snubber box by a releaseable pin. During ejection, the slack in each line is taken up and the tension builds up to finally separate the lines at the tension rings in the leg lines. At man/seat separation, the pins on the other end of the lines are released by the time release mechanism. The pins are also released when the manual override handle is pulled. Both the lower garter and thigh garter contain a quick release buckle which disconnects the ring through which the leg restraint line runs, permitting the pilot to egress from the aircraft wearing both upper and lower garters. In addition, toe clips are installed on the tops of the rudder pedals to prevent contact between the toes and the instrument panel during ejection.

2.16.3.7.1 Leg Restraint Snubber Release Tabs. The leg restraint lines are adjusted to give the pilot more leg movement by pulling inboard the leg restraint snubber release tabs (figure 2-37) and simultaneously pulling the leg restraint lines forward through the snubber box.

2.16.3.8 Seat Survival Kit (SKU-10/A). The SKU-10/A survival kit is used with the SJU-17 and SJU-17A ejection seats. This survival kit, which fits into the seat bucket, is a contoured rigid platform which contains an emergency oxygen system and a fabric survival rucksack (figure 2-38). A cushion on top of the platform provides a seat for the aircrew.

The rigid platform forms a hard protective cover to the survival package and oxygen system and is retained in position in the seat bucket by brackets at the front and lugs secured in the lower harness locks at the rear. Attached to the lugs are two adjustable lap belts with integral quick release fittings. A flexible oxygen and communication hose is installed in the left aft side of the upper kit to provide a connection to the aircrew for aircraft oxygen and communication. An emergency oxygen cylinder,

SKU-10/A

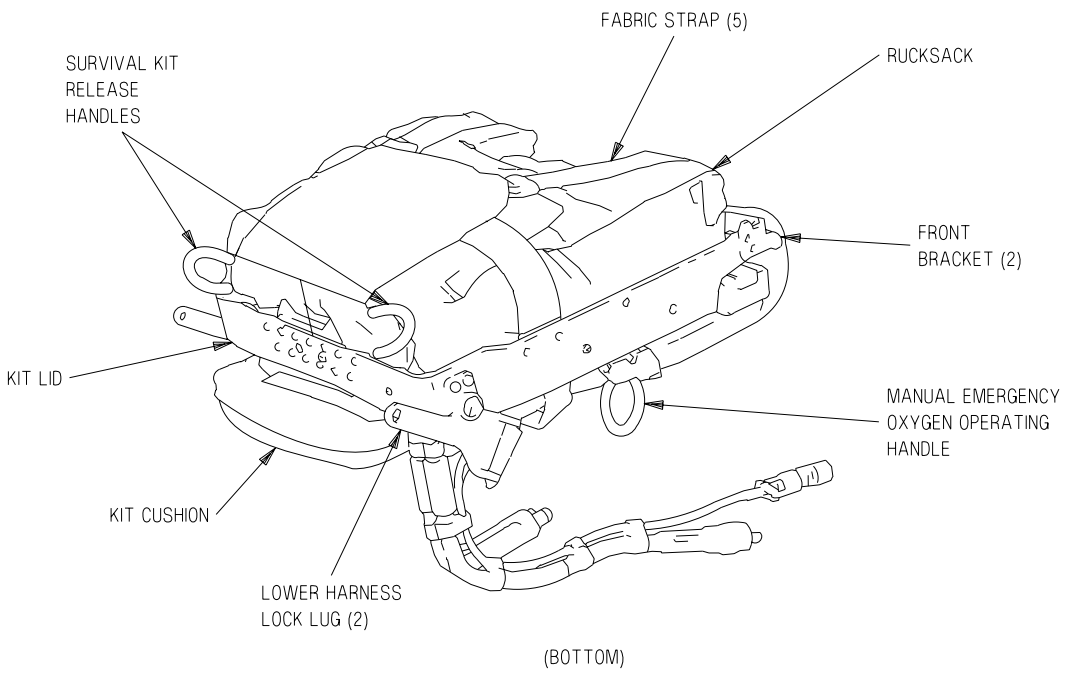
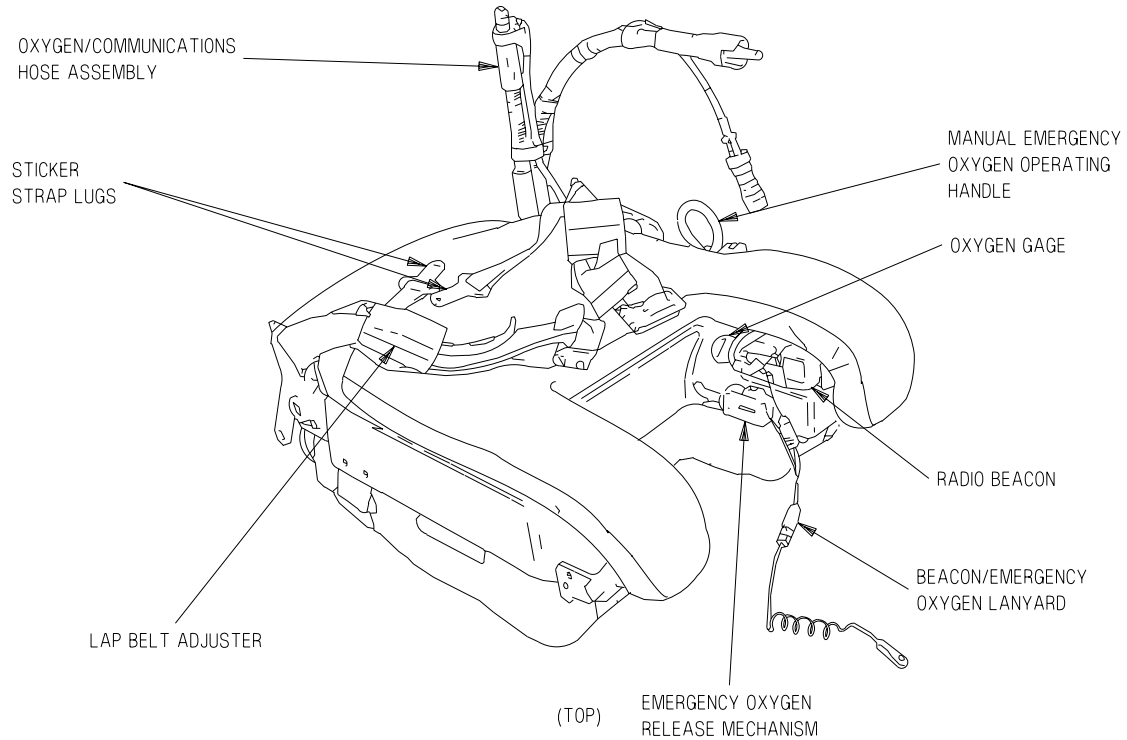

EFN520-42-1-001

Figure 2-38. Survival Kit

pressure reducer, and associated pipe work are mounted on the underside of the platform. A green manual emergency oxygen operating handle is mounted on the left side of the platform and a pressure gage is on the inside face of the left leg support. The emergency oxygen can be activated manually by pulling the green emergency oxygen handle upwards. The green emergency oxygen handle can be reset, shutting off the flow of emergency oxygen, by pushing downward on the button on the front end of the emergency oxygen handle assembly. The emergency oxygen is automatically activated during ejection by a lanyard connected between the floor and the survival kit. An AN/URT-33A locator beacon is located in a cutout in the left leg support. The beacon is actuated during ejection by a lanyard connected to the emergency oxygen lanyard.

The survival rucksack is retained to the underside of the rigid platform by 5 fabric straps and a double cone and pin release system. The package accommodates a life raft and survival aids. Two yellow manual deployment handles are mounted on the aft surface of the kit. Pulling either handle enables the aircrew to deploy the raft and survival package after man/seat separation. The life raft inflates automatically on survival package deployment and is attached to the survival package with a line. If the survival kit must be deployed after water entry, a snatch pull on the red manual activation handle near the CO₂ bottle is required to inflate the life raft.

2.16.3.9 Manual Override Handle. A manual override handle permits releasing the pilot's lower harness restraints and the leg restraint lines for emergency egress and permits resuming part of the ejection sequence (man/seat separation and main parachute deployment) in the event of sequencing failure during ejection. The manual override handle, on the right side of seat bucket and just aft of the ejection seat safe/arm handle, is actuated by pressing a thumb button on the forward part of the handle and rotating the handle up and aft. If the manual override handle is actuated on the ground or in the air before ejection, survival kit attachment lugs and leg restraint lines are released, the inertia reel is unlocked, and the ejection seat safe/armed handle automatically rotates to the SAFE position. During ground emergency egress, after the manual override handle is pulled and the parachute riser fittings are released, the pilot is free to evacuate the aircraft with the survival kit still attached. If the manual override handle is actuated after ejection but before man/seat separation occurs, the following events take place: release of survival kit attachment lugs, negative-g strap (SJU-17 (V)1/A, 2/A, and 9/A only), leg restraint lines, and inertia reel straps; firing of the manual override initiator cartridge; firing of the barostatic release unit; and firing of the parachute deployment rocket, which deploys the parachute. The ejection seat safe/armed handle automatically rotates to the SAFE position whenever the manual override handle is actuated.

WARNING

Pulling the manual override handle automatically rotates the ejection seat safe/armed handle to the SAFE position, releases the survival kit attachment lugs and leg restraint lines, and unlocks the inertia reel. If this is done inflight, the aircrew will be unable to eject.

2.16.3.10 Seat Bucket Position Switch. The seat bucket position switch is on the left side of the seat bucket, forward of the shoulder harness lock/unlock handle. The forward switch position lowers the seat bucket, the aft position raises the seat bucket. The center off position, to which the switch is spring loaded, stops the seat bucket. The maximum vertical travel of the seat bucket is 5.1 inches for the

SJU-17 (V)1/A, 2/A, and 9/A, and 6.1 inches for the SJU-17A (V)1/A, 2/A, and 9/A. The actuator should not be operated over 1 minute during any 8 minute period.

WARNING

- To prevent increased risk of thigh slap or leg contact injuries, aircrew with a buttock-to-knee length greater than 25.5 inches should not use either of the two forward backpad positions. Aircrew with buttock-to-knee length between 24.6 and 25.5 inches should not use the full forward backpad position.
- Actuation of the seat bucket position switch with the leg restraints under the seat bucket may result in an inadvertent ejection.

CAUTION

Actuation of seat bucket position switch with lap belts, shoulder harness, and/or leg restraints outside or under seat bucket may damage ejection seat, leg restraints, and/or Koch fittings.

2.16.3.11 Backpad Adjustment Mechanism (SJU-17A (V)1/A, 2/A, and 9/A). The backpad adjustment mechanism handle is on the seat bucket adjacent to the top left hand side of the backpad and is connected to the backpad by a linkage. The backpad has three positions, full-forward, middle, and full-aft, which give a total forward/aft adjustment of 1.6 inches. When the handle is in the full-up position, the backpad is full-aft, and when the handle is full-down, the backpad is full-forward. To move the backpad, the adjustment handle is moved within a quadrant until a spring-loaded plunger engages in one of the three detent positions in the quadrant. Set the backpad for personal comfort and best access to flight controls during initial strap-in and prior to flight.

2.16.4 Ejection Seat System (F/A-18F). The ejection seats in the F/A-18F are ejected at opposite divergent angles to one another. The rear seat diverges to the left while the forward seat diverges to the right. The amount of divergence is influenced by the weight of the aircrew and the speed of the ejection. The heavier the aircrew and the faster the speed the less the resulting divergent angle. In addition, a sequencing system is installed to allow dual ejection initiated from either cockpit or single (aft) seat ejection initiated from the rear cockpit. A command selector valve is installed in the rear cockpit to control whether ejection from the rear cockpit is dual or single.

2.16.4.1 EJECTION MODE Handle (F/A-18F). The EJECTION MODE handle is located on the right side of the main instrument panel in the rear cockpit. The EJECTION MODE handle is used to select the desired ejection sequence to be initiated from the rear cockpit, or provide for single ejection for solo flight. Positioning is accomplished by pulling out while turning to the desired position. The SOLO position requires the use of a collar to hold the handle in that position. To release from AFT INITIATE, pull then turn clockwise.

NORM (vertical)	Single rear seat ejection when initiated from the rear cockpit. Dual ejection (rear seat first) when initiated from the front cockpit.
--------------------	--

AFT INITIATE (horizontal)	Dual ejection (rear seat first) when initiated from either cockpit.
SOLO (45° CCW)	Front seat ejection only when initiated from the front cockpit. Front seat ejection is immediate. Rear seat ejection only when initiated from the rear seat. Rear seat ejection is immediate.

WARNING

- SOLO mode shall NOT be selected when both seats are occupied. If SOLO mode is selected when both seats are occupied, simultaneous ejection initiation may result in a collision between seats.
- SOLO mode shall be selected when the aircraft is being flown solo. Alternate selection when flying solo results in ejection of unoccupied seat and possible collision with the front cockpit seat.

CAUTION

When selecting NORM or SOLO from AFT INITIATE, the handle must be pulled before rotation or damage to the command selector valve may result.

2.16.4.2 SEAT CAUT MODE Switch (F/A-18F). The SEAT CAUT MODE switch is located in the rear cockpit above the command selector valve. The switch position changes the operation of the CK SEAT caution for solo or dual flight.

NORM	CK SEAT caution is activated by either seat remaining safed. Switch is spring loaded to this position.
SOLO	CK SEAT caution is activated only by the front seat remaining safed. Switch must be pinned to remain in this position.

2.16.4.3 CK SEAT Caution (F/A-18F). The CK SEAT caution light is located on the caution light panel, and repeats the DDI CHECK SEAT caution display. The caution is displayed when the right throttle is at MIL or above, weight is on wheels, and the cockpit ejection seat is not armed with the rear cockpit NORM/SOLO switch set to SOLO or either ejection seat is not armed with the NORM/SOLO switch set to NORM.

2.17 EMERGENCY EQUIPMENT

2.17.1 Jettison Systems. The jettison systems consist of the emergency jettison system and the selective jettison system.

2.17.1.1 Emergency Jettison. Emergency jettison is performed by pushing the EMERG JETT button with either the LDG GEAR handle UP or with WoffW. When activated, the emergency jettison system jettisons all stores, launchers, and racks from the BRU-32 racks on the six wing pylon stations

(2, 3, 4, 8, 9, and 10) and the centerline station (6). Emergency jettison is sequential by station pairs: 3 and 9, 2 and 10, 4 and 8, then 6. There is a 100 msec, ± 25 msec, delay before the first set of stations is jettisoned and in between each subsequent set.

2.17.1.2 EMERG JETT Button. The EMERG JETT button is located on the left side of the main instrument panel and is black and yellow striped. The button must be pressed and held during the entire jettison sequence. The EMERG JETT button is used to initiate emergency jettison with the LDG GEAR handle UP or with WoffW.

WARNING

The EMERG JETT button must be pressed for 500 msec to make sure all stores are jettisoned.

CAUTION

If the EMERG JETT button has been pushed on the ground prior to takeoff and remains stuck in, emergency jettison is activated as soon as the aircraft goes WoffW. The only cockpit indication of this condition is SMS BIT status DEGD and MSP 082 (Emergency Jettison Switch Failed On).

2.17.1.3 Selective Jettison. Selective jettison is performed using the SELECT JETT knob, in conjunction with the JETT STATION SELECT buttons, and jettisons stores in a safe condition. The stores or the launchers/racks (with any attached stores) can be jettisoned from the centerline and wing stations, and the missiles can be jettisoned from the fuselage stations.

Selective jettison requires ARM conditions satisfied and all the landing gear up and locked. ARM conditions are satisfied with WoffW, LDG GEAR handle UP, MASTER ARM switch in ARM, and SIM mode unboxed. ARM status can be confirmed on the STORES page. All the landing gear up and locked can be confirmed by the absence of the LDG GEAR handle warning light/landing gear warning tone with the LDG GEAR handle UP.

Selective jettison of the centerline and wing stations requires station(s) selection by the JETT STATION SELECT buttons and STORES or RACK/LCHR selection by the SELECT JETT knob. Selective jettison of a fuselage station missile requires R FUS MSL or L FUS MSL selection by the SELECT JETT knob.

With all the requirements met, selective jettison is performed by pressing the JETT center pushbutton in the SELECT JETT knob.

2.17.1.3.1 JETT STATION SELECT Buttons. The JETT STATION SELECT buttons are on the left edge of the instrument panel below the emergency jettison button. The buttons are labeled CTR, LI, RI, LM, RM, LO and RO. Pressing a button turns on an internal light and selects a weapon station for jettison. The JETT STATION SELECT buttons are also used in the backup A/G weapon delivery modes for weapon selection; refer to A1-F/A-18EA-TAC (Series).

2.17.1.3.2 SELECT JETT Knob. The SELECT JETT knob on the left vertical panel has rotary positions L FUS MSL, SAFE, R FUS MSL, RACK/LCHR, and STORES. L FUS MSL and R FUS MSL select either fuselage missile for jettison. The RACK/LCHR and STORES positions select what

is to be jettisoned from the weapon station(s) selected by the JETT STATION SELECT buttons. The JETT center pushbutton activates the jettison circuits provided ARM conditions are satisfied and all the landing gear are up and locked. The SAFE position prevents any selective jettison.

2.17.1.3.3 AUX REL Switch. The AUX REL switch, on the lower instrument panel, is used to enable jettison of hung stores or store and rack/launcher combinations from BRU-32 racks on stations 2, 3, 4, 6, 8, 9, and 10. A need to use the AUX REL switch is indicated by a hung indication on the DDI after a selective jettison or a normal weapons release is attempted. Placing the switch to ENABLE selects the auxiliary release function. AUX RELEASE has the same requirements as those listed above for selective jettison. Jettison is initiated by selecting RACK/LCHR or STORES on the selective jettison knob, selecting the hung store station by pressing the appropriate station jettison select button, and pressing the JETT center pushbutton of the selective jettison knob. The SMS provides a jettison signal to fire the auxiliary cartridge in the BRU-32 rack on which the hung store or store and rack/launcher combination is loaded. After the cartridge is fired, the store or rack/launcher is gravity dropped with the store in a safe condition. This switch is also used with some weapons for a second normal release attempt after these weapons have been hung during a first normal release attempt. Refer to A1-F18EA-TAC-Series for these weapons and procedures.

2.17.2 Warnings/Cautions/Advisories. The warning/caution/advisory system provides visual indications of normal aircraft operation and system malfunctions affecting safe operation of the aircraft. The lights are on various system instruments and control panels in the cockpit. The red warning lights normally indicate a systems malfunction that could be a severe hazard to further flight, and may require immediate action. Caution lights and displays normally, but not always, indicate malfunctions that require attention but not immediate action. After the malfunction has been corrected, warning and caution lights and caution displays go out. Advisory lights and displays indicate safe or normal conditions and supply information for routine purposes. Warning, caution and advisory displays are NVG compatible. Caution and advisory displays appear on the left or right DDI and the MPCD, depending on the number of displays in operation. The advisory displays start at the bottom of the display and are preceded by ADV. The caution displays, in larger characters than the advisory displays, appear immediately above the advisory displays. The caution lights, located on the caution lights panel and the instrument panel, are yellow lights. The advisory lights, scattered throughout the cockpit(s), are green. Lights that have been lit on the caution lights panel flash when overheated to prevent light damage.

2.17.2.1 MASTER CAUTION Light. A yellow MASTER CAUTION light, on the upper left part of the instrument panel, comes on when any of the caution lights or caution displays come on. The MASTER CAUTION light goes out when it is pressed (reset). An audio tone is initiated whenever the MASTER CAUTION light comes on. The tone is of 0.8 second duration and consists of a 0.25 second sound followed by a 0.15 second sound of higher pitch, followed by one repetition of these sounds. The tone does not repeat unless the original condition causing the tone clears and recurs 5 seconds after the first tone, regardless of whether or not the MASTER CAUTION is reset. Additional cautions sound the tone, regardless of whether or not the MASTER CAUTION is reset, providing about 5 seconds have elapsed since the previous caution. Pressing the MASTER CAUTION when it is unlighted causes the uncorrected caution and advisory displays to reposition to the left and to a lower level, provided there is available space vacated by corrected caution and advisory displays. To restack the cautions and advisories when the MASTER CAUTION is lighted, the MASTER CAUTION must be pressed twice: first, to turn off the MASTER CAUTION light and second, to reposition the caution and advisory displays. A reset MASTER CAUTION light (and tone) comes on if there is at least one uncorrected caution present when weight is on the wheels and both throttles are moved beyond approximately 80 % rpm if both throttles were below 80 % for at least 60 seconds.

2.17.2.2 MASTER CAUTION Light (F/A-18F). A yellow MASTER CAUTION light, on the upper instrument panel comes on whenever the MASTER CAUTION light in the front cockpit comes on. The rear cockpit MASTER CAUTION light goes out whenever the front cockpit MASTER CAUTION is reset.

2.17.2.3 Dimming and Test Functions. There are no provisions for testing the caution and advisory displays and each DDI contains its own display dimming controls. The warning/caution/advisory lights are dimmed by the warning/caution lights knob and are tested by the lights test switch. The following lights can be dimmed by the warning/caution lights knob, but once in the dimmed lighting range cannot be varied in intensity: MASTER CAUTION light, landing gear handle warning, L BAR warning, HOOK warning, L BLEED warning, R BLEED warning, APU FIRE warning, left and right engine FIRE warning.

2.17.3 Voice Alert System. For certain critical warnings and cautions, voice alert transmissions are sent to the aircrew's headset. The message is repeated twice; for example, APU FIRE, APU FIRE. The voice alert requires no reset action on the pilot's part and the alert is not repeated unless the original condition ceases for 5 seconds or more and then recurs. For cautions with voice alert, the voice alert replaces the master caution tone; however, the master caution tone backs up the voice alert system and provides a tone if the voice alert system malfunctions. FIRE, APU FIRE, L BLEED, and R BLEED warning lights are not backed up by the master caution tone. Voice alert is the only audio warning for these problems. With dual generator failure, the following voice alert warnings operate from battery power: APU FIRE, ENGINE FIRE LEFT (RIGHT), and BLEED AIR LEFT (RIGHT). All voice alert cautions, and the master caution tone are inoperative on battery power during dual generator failure.

Once a voice alert has been activated, it cannot be interrupted by a higher priority voice alert. All voice alerts play until completed. The primary radar low altitude warning (WHOO, WHOO), is repeated at the lowest priority until reset or disabled by the pilot. With MC OFP 20X AND UP OR H3E AND UP, the BINGO voice alert is repeated every 30 seconds until the BINGO setting is adjusted.

NOTE

With an MC1 failure (LOTs 21-24), the voice alert does not sound when the aircraft descends below the altitude set by the primary low altitude warning setting.

CAUTION	VOICE ALERT
IFF 4	MODE 4 REPLY
FCS FCS HOT	FLIGHT CONTROLS FLIGHT COMPUTER HOT
L (R) OVRSPD L (R) EGT HIGH L (R) FLAMEOUT L (R) OIL PR L (R) STALL L (R) ENG L (R) ENG VIB	ENGINE LEFT (RIGHT)
FUEL LO	FUEL LOW
BINGO	BINGO
WARNING	VOICE ALERT
ALTITUDE	ALTITUDE
L (R) BLEED AIR	BLEED AIR LEFT (RIGHT)
L (R) FIRE	ENGINE FIRE LEFT (RIGHT)
APU FIRE	APU FIRE

2.17.4 Terrain Awareness Warning System (TAWS) (MC OFP 18E+ and H2E AND UP). The terrain awareness warning system alerts the aircrew of a controlled flight into terrain (CFIT) condition during all mission phases. The system operates any time that the navigation mission computer (MC1) and TAMMAC digital mapping set (DMS) are functional. TAWS functions as a safety backup system and not as a performance aid. TAWS has been designed to eliminate false warnings, minimize nuisance warnings, and generate consistent aircrew response in all aircraft master modes. Five possible voice warnings are provided to indicate the correct initial response to an impending CFIT condition, and a visual cue is provided to indicate the recovery direction of pull, or in some instances, to command an increase in turn rate. All TAWS warnings should be treated as though an imminent flight into terrain condition exists. Pilot response to a TAWS warning should be instinctive and immediate.

TAWS uses data from the following inputs: FCC, INS, RADALT, GPS, and digital terrain elevation data (DTED). DTED resides in the DMS as part of TAMMAC and is used to provide the forward-prediction capability that protects against flight into rising terrain. The TAWS option is reached by pressing MENU-HSI-DATA-A/C as shown in figure 2-39. The TAWS option boxes automatically at start-up.

When a DMS is not installed in the aircraft or is not operational, protection from CFIT events is provided by the Ground Proximity Warning System (GPWS). BIT may be initiated on the DMS by pressing the appropriate pushtile of the BIT display. The BIT can take up to 185 seconds to complete. During the BIT, TAWS is not operational. Therefore, the GPWS algorithm is used to determine the presence of possible CFIT events. There is no capability for pilot selection of GPWS if DMS is

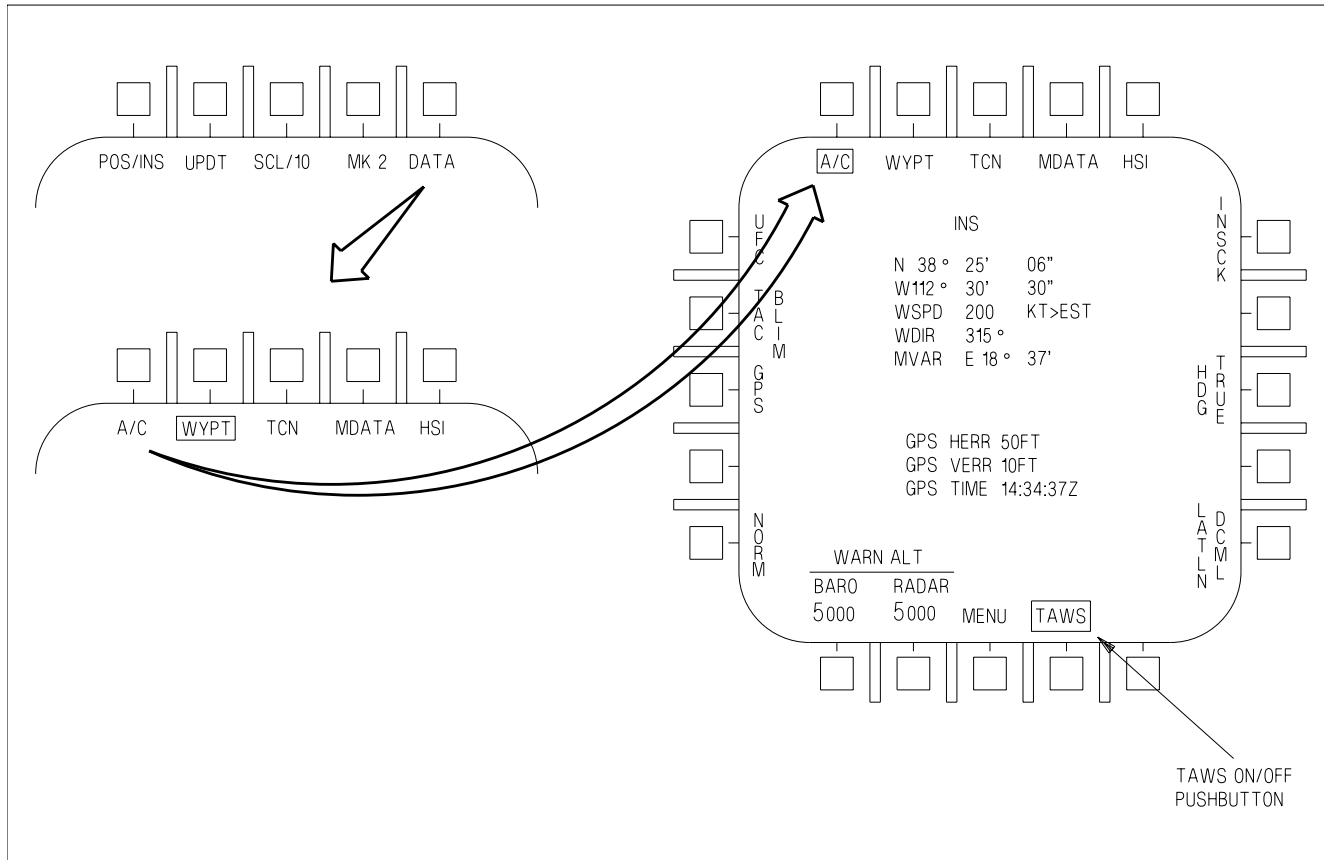

Figure 2-39. HSI-DATA-A/C Controls

EFN520-406-1-009

operational. The GPWS algorithm runs continuously with outputs being overwritten if TAWS is operational. This prevents erroneous values during an unexpected transition from TAWS to GPWS.

2.17.4.1 TAWS Modes. TAWS has two operational modes: TAWS-with-DTED, and TAWS-without-DTED. These modes switch automatically depending upon the available sensor data and flight phase. When the aircraft position (latitude and longitude) is accurately known and DTED for the local area has been loaded onto the DMS (during the theater load process), TAWS is in the TAWS-with-DTED mode and provides protection against varying terrain ahead of the aircraft. When the aircraft position is not accurately known, DTED for the local area is unavailable, or TAWS determines the aircraft is in a landing phase, TAWS transitions to the TAWS-without-DTED mode and provides protection against flight into level or descending terrain as GPWS does.

When operating over the ocean, DTED does not exist and TAWS will be in the TAWS-without-DTED mode. However, there is no degradation in protection because the ocean is relatively flat. As the aircraft approaches the coast or islands, DTED may be available (depending upon the theater load) and TAWS will automatically switch back to the TAWS-with-DTED mode.

Operation of TAWS in the TAWS-without-DTED mode is still an improvement over GPWS as TAWS incorporates a more robust performance model and additional input sensor redundancy.

2.17.4.2 TAWS Operation. TAWS incorporates signal processing that determines a best estimate of aircraft position and altitude (AGL and MSL). TAWS protection algorithm continuously computes two recovery trajectories: Vertical Recovery Trajectory (VRT) and Oblique Recovery Trajectory (ORT). VRT is the standard GPWS-like recovery: roll to wings-level, if needed, and pull to recover.

ORT assumes that you maintain the current bank angle and pull to recover (increase turn rate). Both computed trajectories include the following assumptions:

- a. Pilot Response Time is the time from issuance of a TAWS warning to the time that the pilot actually initiates recovery. Pilot Response Time is set at 1.3 seconds.
- b. Roll Recovery Phase is the time necessary to roll the aircraft to near wings-level. This assumes at least $\frac{1}{2}$ lateral stick will be used for bank angles less than 70° and at least $\frac{3}{4}$ lateral stick will be used for bank angles $\geq 70^\circ$.
- c. G-Onset Phase is the time required to pull to the target recovery g. The target recovery g is 80 % of the instantaneous g available, or 5g, whichever is less. The g-onset phase assumes that rapid aft stick motion will be used (full deflection within $\frac{3}{4}$ second). In addition, TAWS assumes that throttles will be moved to MAX if below corner speed and to IDLE if above corner speed.
- d. Dive Recovery Phase is the remainder of the trajectory until terrain clearance is achieved. TAWS assumes a terrain clearance of 50 ft.

When TAWS senses that the aircraft is in the landing configuration, the recovery assumptions must change since the desire is to land. TAWS defines the landing phase as below 500 ft AGL, less than 200 KCAS, landing gear down and locked, and more than one minute since a waveoff or takeoff. In the landing phase, TAWS protects against landings of greater than the structural limit of the landing gear (1584 fpm). To allow this, TAWS switches to TAWS-without-DTED and provides a warning when the landing is predicted to exceed the structural limit of the landing gear.

TAWS provides protection against gear-up landings. When the aircraft is below 200 KCAS, below 150 ft AGL, more than one minute since waveoff or takeoff, and the landing gear is not down and locked, a TAWS warning is provided.

2.17.4.3 TAWS Warnings. TAWS provides clear, unambiguous, and directive aural and visual cues to the aircrew. Aural warnings provide the aircrew with a wake-up call and correct initial response while visual warnings provide the aircrew with correct follow-on recovery information.

2.17.4.3.1 Voice Warnings. TAWS uses the ACI to provide aural cues to the aircrew. The aural cues are distinct from any other cues that the aircrew may receive. The TAWS voice alert warnings are: "Roll-Left...Roll-Left", "Roll-Right....Roll-Right", "Pull-Up...Pull-Up", "Power...Power", and "Check Gear". Each of these warnings is issued at a level 3-6 dB above the present voice alerts. The TAWS voice warnings provide a wake-up call to the aircrew and indicate the most appropriate initial response for the given aircraft state, not necessarily the only required response. The aural cue repeats until the warning condition is cleared. TAWS aural warnings have priority over all current aural tones. Note that TAWS requires a -1018 or greater ACI load (or MIDS equivalent) which is capable of generating the "Roll Left/Right" warnings. Earlier ACI loads were only capable of generating "Roll Out" warnings and are not desired for use with TAWS.

A "Roll Right...Roll Right" warning is issued when a roll to the right is the correct initial response.

A "Roll Left...Roll Left" warning is issued when a roll to the left is the correct initial response.

A "Power...Power" warning is issued when the roll requirement conditions have not been met and adding power is the correct initial response. This occurs when the aircraft is below 200 KCAS, the AOA

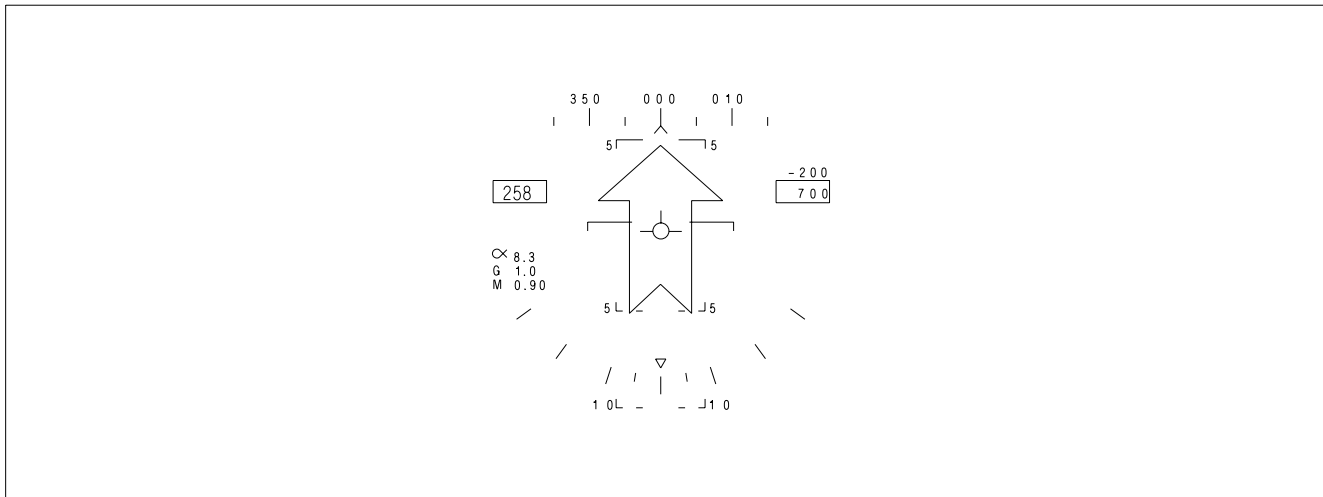

EFN520-404-1-009

Figure 2-40. TAWS HUD Visual Recovery Warning - Pull Up (VRT)

is above 8.5° for PA configuration (or 18° AOA for up and away configuration) and the throttle is not already at MAX. The correct response to this warning is to select MAX afterburner.

A "Pull Up...Pull Up" warning is issued when the above conditions have not been met and pulling up is the correct response or when the ORT is the recovery trajectory.

When a warning is given to protect against a gear-up landing, the following aural cues may be heard:

"Pull Up...Pull Up" followed two seconds later by "Check Gear" when the gear handle is in the UP position and a gear-up landing condition has been assessed (repeated every 4 seconds).

"Check Gear" repeated every 8 seconds when the gear handle is down and a gear up landing condition has been assessed.

2.17.4.3.2 Visual Warnings. A visual recovery arrow is provided in the center of the HUD and HUD format on the DDI. The recovery arrow indicates the direction of recovery. The visual warning is displayed when a CFIT condition is present and is removed when the CFIT condition is cleared.

TAWS visual recovery cues are designed to be used in conjunction with TAWS voice warnings. There are several voice warning/visual recovery cue combinations. When the arrow points UP in the HUD (i.e., along the lift vector), a longitudinal pull is the correct response and an aural "Pull Up...Pull Up" is heard. This is a VRT recovery if the aircraft is close to wings level, or it is an ORT (increased turn rate) recovery if the aircraft is banked such that the TAWS algorithm assessed that an increased turn rate would provide the quickest recovery from an impending CFIT condition. Figures 2-40 and 2-41 depict these two situations. Both situations require a longitudinal pull as the correct response, however, the first case (VRT) depicts a dive recovery while the second case (ORT) depicts a recovery requiring an increase in turn rate by increasing g when already in an established angle of bank.

When the arrow points anywhere other than UP in the HUD (i.e., not along the lift vector, but perpendicular to the horizon), it may be accompanied by either a "Roll Left (Right)"..."Roll Left (Right)" or "Pull Up...Pull Up" voice warning. The voice warning indicates the correct initial response, then the aircrew should roll or pull as required to place or maintain the TAWS recovery arrow straight up in the HUD (i.e., along the lift vector). For example, if a "Roll Left...Roll Left" voice warning is issued with an accompanying HUD recovery arrow displayed in the HUD that is perpendicular to the

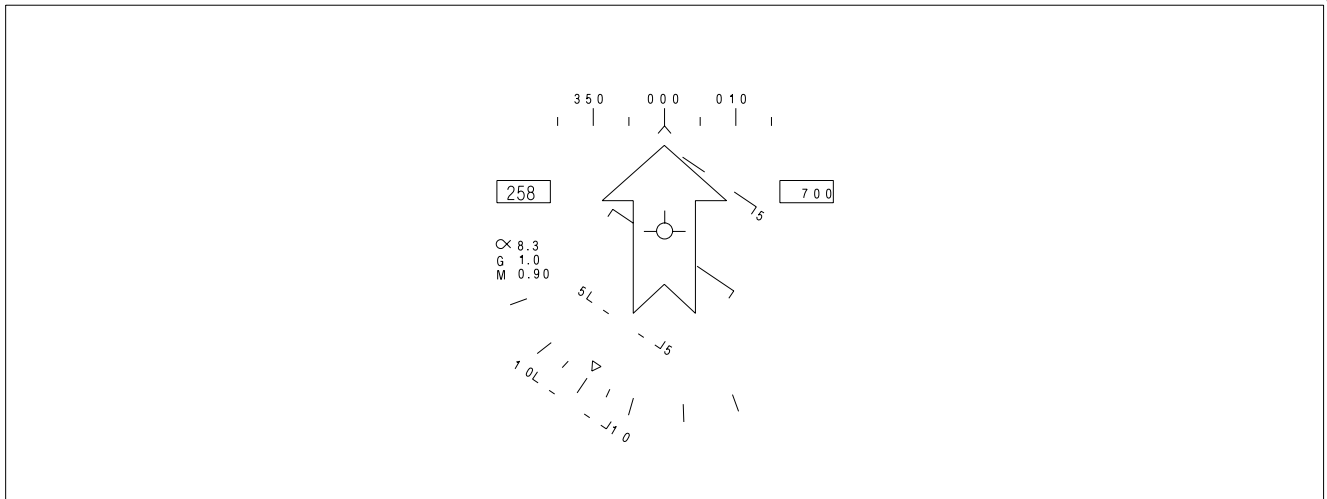

EFN520-405-1-009

Figure 2-41. TAWS HUD Visual Recovery Warning - Pull Up (ORT)

horizon, the correct response is to roll left to align the lift vector with the HUD recovery arrow and then perform a dive recovery. If a "Pull Up...Pull Up" voice warning is issued with an accompanying HUD recovery arrow displayed in the HUD that is perpendicular to the horizon, the correct response is to apply g along the current lift vector and then, referencing the HUD recovery arrow, roll to align the lift vector with the HUD recovery arrow and perform a dive recovery. Figure 2-41 depicts a situation in which a Roll or Pull Up aural warning could be issued. If a "Roll Right...Roll Right" aural warning was issued, a roll to the right would be the correct initial response and then a dive recovery would be continued with a longitudinal pull. If a "Pull Up...Pull Up" aural warning was issued, a longitudinal pull would be the correct initial response and then a roll to the right to align the lift vector with the HUD recovery arrow followed by a longitudinal pull for a dive recovery would be the follow-on recovery procedure.

2.17.4.4 ACI Configuration Check. There are different ACI configurations in the F/A-18 aircraft. Two TAWS software loads exist: -1016 and -1018. The -1016 ACIs can command these four aural cues: "Roll Out...Roll Out", "Pull Up...Pull Up", "Check Gear", and "Power...Power". The -1018 and greater ACIs added logic for replacing the "Roll Out...Roll Out" aural cue with "Roll Left...Roll Left" and "Roll Right...Roll Right". Due to the variety of possible combinations, on cold start power-up, the MC commands a "Roll Left...Roll Left" to the ACI to determine if it is in the -1018 configuration. If there is no response, the MC commands a "Roll Out...Roll Out" to the ACI to determine if the ACI is in the -1016 configuration. If no response is received the second time the MC attempts to command a "Roll Out...Roll Out", the TAWS/GPWS voice warnings will not be heard, however the visual arrow will still be present when a warning is issued.

2.17.5 GPWS - Ground Proximity Warning System. GPWS is designed to backup the pilot by providing an alert of impending controlled flight into terrain (CFIT). GPWS provides warnings of potentially unsafe maneuvering flight conditions such as excessive bank angles, excessive sink rates, gear up landings, floor altitude violations, and altitude loss during recovery. The system is operational as long as MC1, radar altimeter, and air data systems are ON and functional. The GPWS algorithm operates in the background of the OFP with no cockpit indications until an actual CFIT warning is required. The system provides distinctive aural and visual warning cues only, to alert and direct recovery from an impending CFIT condition. The pilot maintains full control of the aircraft for recovery.

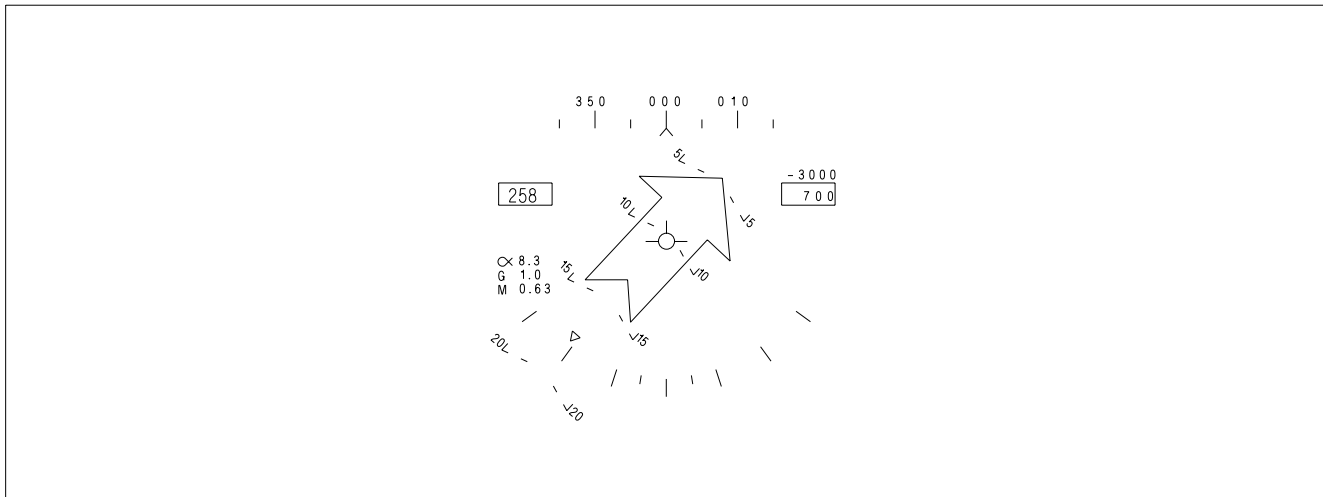

EFN520-403-1-009

Figure 2-42. TAWS HUD Visual Recovery Warning (VRT)

2.17.5.1 GPWS Sensors/Modes. GPWS is a look-down system with no forward-looking capability. GPWS uses the radar altimeter as the primary source of terrain clearance information and the FCC air data function, GPS, and INS as backup altitude sources when radar altitude is invalid. Radar altitude is considered invalid by GPWS above 4,950 feet AGL or at a pitch or angle of bank greater than 50°. With valid radar altitude data, GPWS calculates terrain slope from inputs from the INS and the radar altimeter. Over descending terrain, GPWS assumes the terrain descends indefinitely (until the system senses a change in terrain slope). This mechanization allows for maximum protection while minimizing nuisance warnings.

For the first 5 seconds after radar altitude becomes invalid (as indicated by a flashing "B" in the HUD or RALT Xd out on the UFCD), GPWS provides no CFIT protection. After 5 seconds, the system enters "COAST" mode for a period of up to 2 minutes. While in COAST mode, GPWS calculates an estimate of the aircraft current height above terrain. COAST mode can only be enabled while the aircraft is not transonic and was over flat terrain (defined as slope less than 2°). CFIT warnings can still be generated while in COAST mode. If the aircraft was transonic or was not over flat terrain when radar altitude data was lost, GPWS transitions into the BYPASS mode. In the BYPASS mode, no CFIT warnings are generated. Full protection is resumed from both modes when valid radar altitude data is restored.

2.17.5.2 Altitude Required For Recovery Calculations. GPWS calculations for altitude required for recovery include the loss of altitude due to persistency timers, pilot reaction time, time to roll wings level, target g-onset rate, and steady state dive recovery time. GPWS pilot reaction time varies depending on flight conditions but is a minimum of 0.5 second in the GPWS LAT envelope ($\pm 30^\circ$ AOB, 0 to 30° dive, 450 to 560 KCAS). Pilot reaction time is reduced in the GPWS LAT envelope, where pilot situational awareness is typically good, in order to reduce false warnings. Time to roll wings level is based on a $\frac{1}{2}$ to $\frac{3}{4}$ lateral stick displacement roll at 1g. Target g-onset rate is 80% of the available g-onset rate up to (1) 5g/sec (less than 400 KCAS or greater than 30° AOB) or (2) 6g/sec (greater than 400 KCAS and less than 30° AOB). Steady state dive recovery time is based on a target sustained-g of 80% of g-available up to (1) 5g (less than 400 KCAS or greater than 30° AOB) or (2) 6g (greater than

400 KCAS and less than 30° AOB). **Regardless of which category applies, these g-onset rates and sustained-g levels require an aggressive pilot response.**

2.17.5.3 CFIT Protection Provided.

Above 150 feet AGL -

Above 150 feet AGL, GPWS continuously calculates the altitude required to recover. A CFIT warning is issued if the altitude required to recover plus a variable safety buffer and an added terrain clearance altitude is greater than the current altitude above terrain. The terrain clearance altitude varies between 30, 50, and 90 feet, depending on flight conditions.

Below 150 feet AGL -

Below 150 feet AGL, GPWS transitions to provide warnings of CFIT conditions related to takeoff and landing. These warnings are based on (1) the time since a WoffW transition (takeoff or T&G) or a waveoff and then (2) a combination of landing gear position, airspeed, altitude, and sink rate. GPWS defines a waveoff as 1000 fpm rate of climb for more than 5 seconds while below both 500 feet AGL and 200 KCAS. If the following sets of conditions are valid for greater than 0.3 seconds when the aircraft altitude is less than 150 feet, a CFIT warning is provided. The CFIT warning is cancelled when the condition no longer exists for 0.3 seconds.

1. Less than 60 seconds after WoffW or a waveoff:
 - a. Floor Altitude - less than 90 feet AGL and greater than 250 KCAS.
 - b. Takeoff Sink Rate - less than 150 feet AGL, less than 250 KCAS, greater than 300 fpm sink.
2. More than 60 seconds after WoffW or a waveoff:
 - a. Floor Altitude - less than 90 feet AGL and greater than 200 KCAS.
 - b. Check Gear - less than 150 feet AGL, less than 200 KCAS, descending, and landing gear not down.
 - c. Landing Sink Rate - less than 150 feet AGL, less than 200 KCAS, landing gear down, and an excessive sink rate. The allowable sink schedule varies from a maximum of 2,040 fpm to a minimum of 1,488 fpm based on altitude and GW.
 - d. Bank Angle - less than 150 feet AGL, less than 200 KCAS, greater than 45° AOB for one second.

WARNING

Below 150 feet AGL, GPWS does not directly account for the recovery capabilities of the aircraft. Therefore, recovery may not be possible following a warning under extreme flight conditions.

2.17.5.4 GPWS Warning Cues. GPWS provides distinctive, clear, unambiguous and directive visual and aural cues to the aircrew for each potential CFIT condition.

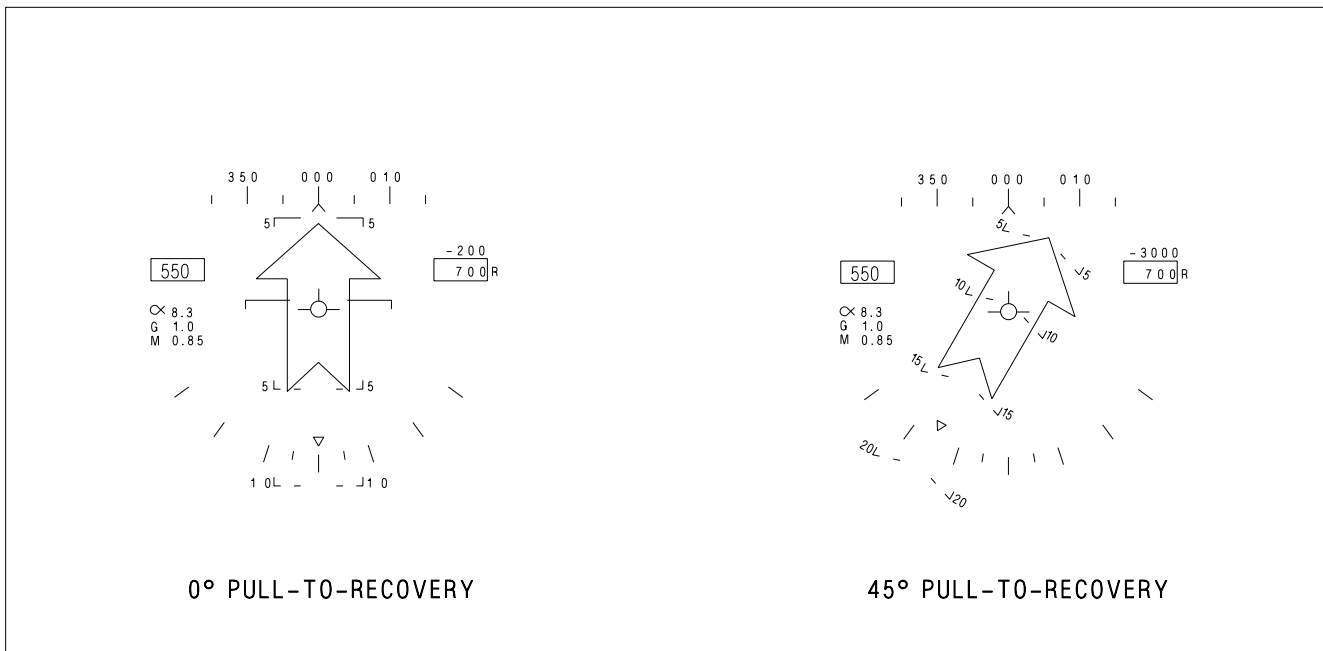

EFN520-8-1-009

Figure 2-43. GPWS HUD Roll Warning Cues

2.17.5.4.1 GPWS HUD Recovery Arrow. The GPWS visual warning cue is a steady arrow located in the center of the HUD. See figure 2-43. The HUD recovery arrow is always perpendicular to the horizon and points in the direction of pull required for recovery. The HUD recovery cue is displayed simultaneously with all voice warnings except CHECK GEAR. The HUD recovery arrow remains displayed until GPWS calculates that a CFIT condition no longer exists.

2.17.5.4.2 GPWS Voice Commands. Refer to figure 2-44 for GPWS aural warning cues.

Voice commands automatically transition to the appropriate command for the current stage of recovery (e.g., ROLL OUT transitions to PULL UP when AOB becomes less than 45°). The voice commands are terminated when the appropriate recovery maneuver is initiated (e.g., a PULL UP is initiated within 0.5 g of the GPWS calculated target-g).

WARNING

- In addition to following the voice commands, additional pilot action may be required to avoid an unrecoverable situation (e.g., aft stick with a POWER call or power addition/subtraction with a PULL UP call.)
- GPWS voice alerts are delayed if other voice alerts are currently being transmitted.

GPWS Warning Condition	Aural Cue	Repetition Rate
Excessive bank angle	"ROLL LEFT (RIGHT), ROLL LEFT (RIGHT)"	2 seconds
Excessive take-off sink rate	"POWER, POWER"	2 seconds
Excessive landing sink rate	"POWER, POWER"	2 seconds
Gear-up landing	"CHECK GEAR"	8 seconds
ALDR or floor altitude	"POWER, POWER" for airspeed <210 KCAS and AOB $\leq 45^\circ$	2 seconds
	"ROLL LEFT (RIGHT), ROLL LEFT (RIGHT)" for AOB $>45^\circ$	2 seconds
	"PULL UP, PULL UP" for all other flight conditions	2 seconds

Figure 2-44. GPWS Aural Cues

2.17.5.5 Areas of Limited CFIT Protection. Areas where CFIT protection is considered limited are as follows:

1. In the COAST mode (5 to 120 seconds outside the valid RALT envelope).
2. Over rising terrain of greater than 2° slope (GPWS is inhibited to prevent nuisance warnings).
3. Within the GPWS LAT envelope where allowable pilot reaction times have been reduced ($\pm 30^\circ$ AOB, 0 to 30° dive, 450 to 560 KCAS).
4. Below 150 feet AGL in the landing phase (less than 200 KCAS) where warnings are designed only to prevent hard landings.

WARNING

At certain high speed, high gross weight conditions, overriding the g-limiter may be required for recovery from dives greater than 50° and will likely be required for dives between 10 and 25° .

2.17.5.6 Areas of No CFIT Protection. Areas of no protection are as follows:

1. Loss of air data or RALT, INS, or MC1 failed or off (non-AMCD aircraft), or either MC1 or MC2 failed or off (AMCD aircraft).
2. Less than 6 seconds after WonW.
3. Less than 5 seconds or greater than 120 seconds outside the valid RALT envelope.
4. Transonic flight (0.95 to Mach 1.04) outside the valid RALT envelope.
5. For 1.5 seconds after a break X is displayed.
6. After a waveoff until exceeding 1,000 fpm for 5 seconds.
7. Dives greater than 50° after 2 minutes above 5,000 feet AGL.



2.18 INSTRUMENTS

Refer to foldout section for cockpit instrument panel illustration. For instruments that are an integral part of an aircraft system, refer to that system description in this section.

2.18.1 Standby Attitude Reference Indicator. The standby attitude reference indicator is a self-contained electrically driven gyro-horizon type instrument. It is normally powered by the right 115 volts ac bus. If this power fails it is automatically powered by an inverter operating off the essential 28 volts dc bus. An OFF flag appears if both power sources fail or the gyro is caged. During caging the gyro initially cages to 4° pitch and 0° roll regardless of aircraft attitude. After 3 to 5 minutes, the indicator reads 0° pitch and 0° roll. Power should be applied for at least 1 minute before caging. The indicator displays roll through 360°. Pitch display is limited by mechanical stops at approximately 90° climb and 80° dive. As the aircraft reaches either stop, the gyro tumbles 180° in roll. A needle and ball are at the bottom of the instrument. A one needle width turn is 90° per minute.

2.18.2 Standby Airspeed Indicator. The standby airspeed indicator displays airspeed from 60 to 850 KIAS. It operates directly from left pitot and static pressure.

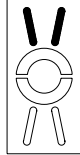
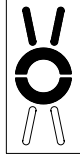
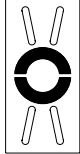
2.18.3 Standby Altimeter. The standby altimeter is a counter-pointer type. The counter drum indicates altitude in thousands of feet from 00 to 99. The long pointer indicates altitude in 50-foot increments with one full revolution each 1,000 feet. A knob and window permit setting the altimeter

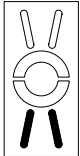
SYMBOL	AIRSPPEED	AOA
	SLOW	9.3 ° TO 90.0 °
	SLIGHTLY SLOW	8.8 ° TO 9.3 °
	ON SPEED	7.4 ° TO 8.8 °
	SLIGHTLY FAST	6.9 ° TO 7.4 °
	FAST	0 ° TO 6.9 °

SHADED INDICATES ILLUMINATED

EFN520-142-1-001

Figure 2-45. Angle of Attack Indexer

to the desired barometric setting. This setting is also used by the flight control computers. The standby altimeter operates directly from left static pressure.

2.18.4 Standby Rate of Climb Indicator. The standby rate of climb indicator displays vertical speed on a scale from 0 to $\pm 6,000$ fpm and operates directly from left static pressure.

2.18.5 Standby Magnetic Compass. A conventional aircraft magnetic compass is mounted on the right windshield arch in the front cockpit and in the rear cockpit in Lots 21 thru 25.

2.18.6 Angle Of Attack Indexer. The angle of attack indexer is mounted to the left of the HUD. It displays approach angle of attack (AOA) with lighted symbols; corresponding AOA indications are shown on the HUD (see figure 2-45). The indexer operates with the landing gear down and locked and weight off the gear. The lighted symbol(s) flash if the arresting hook is up and the hook bypass switch, on the left vertical panel, is in CARRIER. The symbols will not flash with the arresting hook up and the hook bypass switch in FIELD. The switch is solenoid held to FIELD and automatically goes to CARRIER when the arresting hook is lowered or aircraft power is removed. The AOA indexer knob on the HUD controls dimming of the symbols. All symbols light when the lights test switch on the interior lights control panel is held to TEST.

2.19 AVIONICS SUBSYSTEM

The avionics subsystem combines the integration and automation needed for operability with the redundancy required to ensure flight safety and mission success. Key features of the system include highly integrated controls and displays, inertial navigation set with carrier alignment capability, and extensive built in test capability. The avionics subsystems operate under the control of two mission computers with primary data transfer between the mission computers and the other avionics equipment via the mux buses.

2.19.1 Mission Computer System. The mission computer system consists of two digital computers (MC1 and MC2) which are high speed, stored program, programmable, general purpose computers with core memory. Computer de-selection is made with the MC switch on the MC/HYD ISOL panel.

With non-AMCD aircraft, the two mission computers interconnect with the primary avionics equipment on the avionics multiplex (mux) buses. MC1, referred to as the navigation computer, performs processing for navigation, control/display management, aircraft built in test (BIT), status monitoring operations and backup for MC2. MC2, referred to as the weapon delivery computer, performs processing for air-to-air combat, air-to-ground attack, and tactical control/display.

There are six avionics mux bus channels with redundant paths (X and Y) for each channel.

The mission computer:

1. Computes and controls the data sent to the cockpit displays,
2. Computes missile launch and weapon release commands,
3. Provides mode control and options for various avionics systems,
4. Generates BIT initiate signals to and equipment operational status from various avionics systems.

With AMCD aircraft, the front and rear DDIs are driven directly by the MC over a high speed interface bus, not by avionics mux bus commands. The HUD is driven directly by redundant connection to either MC. MC1 drives the front and rear LDDIs and HUD while MC2 drives the front and rear RDDIs and HUD. When an MC is off or non-functional, the displays driven by that MC show a green square in the center of the display. Each MC provides the same level of functionality in the single MC backup mode of operation.

On AMCD aircraft, with both MCs inoperative and the left generator operative, the SDC provides a limited HUD format on the front MPCD/UFCD, prevents the FADEC and ECS controller from going into default mode operation, and provides left/right ATS cautions when necessary. See Chapter 25 Backup/Degraded Operations for a description of SDC Backup Mode.

AMCD II mission computers are used on aircraft with the aft cockpit 8 x 10 display installed. The 8 x 10 display receives its primary signal through MC2, and is inoperative with computers prior to AMCDII. The AMCD II computer provides digital video color capability to the 8 x 10 display via the Fiber Channel Network Switch (FCNS) and High Speed Video Network (HSVN).

The computers receive inputs for navigational data and steering command computations from the inertial navigation system, electronic flight control system, multipurpose display group, TACAN, and backup attitude and the navigation system. The computers control display symbology and information presented to the pilot by the multipurpose display group.

2.19.1.1 MC Switch. The MC switch, located on the outboard edge of the aft left console, is used to manually turn OFF either of the two mission computers, MC1 or MC2.

1 OFF Removes power to MC1.

NORM Both MC1 and MC2 are powered with ac electrical power available.

2 OFF Removes power to MC2.

On non-AMCD aircraft with WonW, both engines will spool up from ground idle to flight idle, if power is removed from MC1 (MC1 switch in 1 OFF).

2.19.1.2 Mission Data Entry. Mission data (date and flight number) can be manually loaded into the mission computer for data recorder documentation. Data is entered by performing the following:

1. On the DDI - Press MENU, MUMI, then ID.
2. On the UFCD - Enter Julian Date (DATE).
3. On the UFCD - Enter Flight Information (FLT).

Mission data can be manually loaded into the mission computer through the Memory Unit Mission Initialization (MUMI) display or automatically loaded into the mission computer through the Data Storage Set (DSS). The DSS consists of the Memory Unit (MU) and the Memory Unit Mount (MUM) and provides memory storage for aircraft parameters, maintenance data, and avionics initialization data. The DSS receives, stores, retrieves, and transmits data with the mission computer.

2.19.1.2.1 Mission Initialization. The MU provides the capability to load the following mission initialization files: HARM, RADAR, MU ID, TACAN, WYPT/OAP, Combined Interrogator Transponder (CIT), Sequential Steering (S/S), data link/ID, Overlay Controlled Stores (OCS), bomb wind data, and ALR-67 display resets. The S/S file can have a 15 point sequence consisting of Geographic Reference Points (GEOREF), GPS waypoints, and almanac data initialization files. Loading is done at aircraft power up or when MUX communication is lost for more than 1 second and regained. If MUX communication is not regained, a MU LOAD caution is displayed and an AV MUX error message is displayed on the MUMI display. Manual loading may be done using the MUMI display.

2.19.1.2.2 MUMI - Memory Unit Mission Initialization Format. The MUMI format (see figure 2-46) is accessible from the SUPT MENU and with WonW provides a visual indication of mission initialization files loaded from the MU. If the MU directory indicates that no user files are present, the MU ID displays NO IDENT. When the MU directory indicates a user file is present, MC1 displays the option. When the option is selected and the file is being read by MC1, the option is boxed. If the read is successful, the file is loaded and the option is unboxed. When a file is present and errors have resulted from reading the file, the following occurs:

1. The MU ID displays NO IDENT.
2. The applicable load error is displayed (HARM, RDR, TCN, WYPT, S/S, OCS, GPS WYPT, GPS ALM, ALR 67, WIND, DL13, or CIT).
3. MC1 sends the appropriate maintenance code to the SDC.

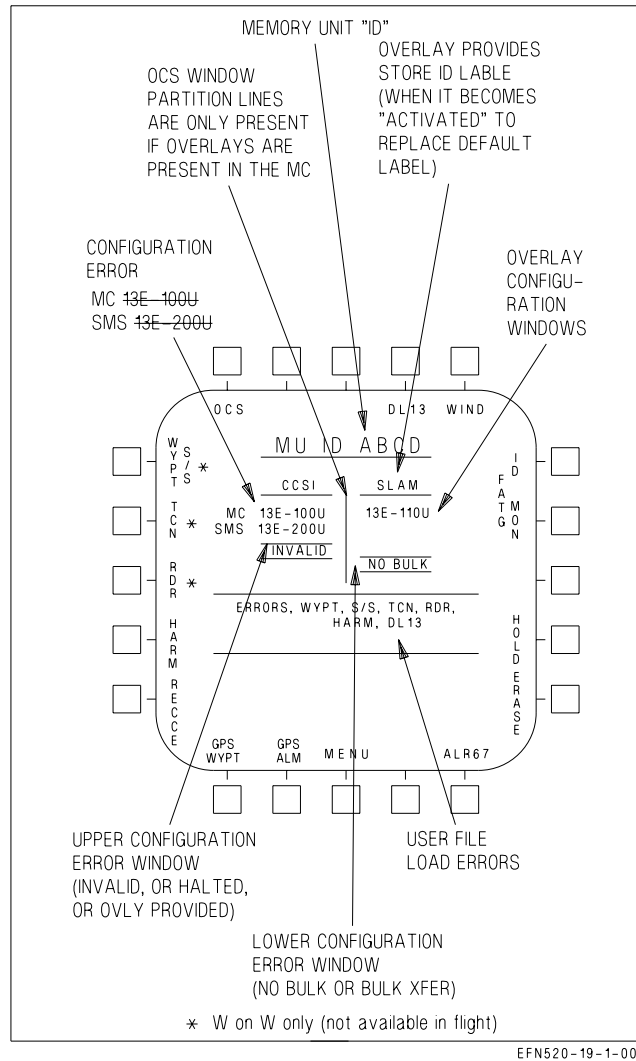

Figure 2-46. MUMI Display

4. If WonW, an MU LOAD caution is displayed on the DDI.

2.19.1.2.3 CRYPTO Switch. Setting the intercommunications amplifier control CRYPTO switch to the ZERO position sends an erase signal to the MU. This causes the MU to erase all data stored between predetermined memory locations.

2.19.1.2.4 Erase and Hold Data. The erase controller (EC) within MC1 provides the capability to automatically or manually erase, or inhibit erasing, of classified data contained in the MU, SMS, MC1, and MC2.

NOTE

With AMCD aircraft, during an ERASE, the DDI controlled by the MC undergoing the erase will flash STANDBY, then briefly display a green square, then flash STANDBY until the erase is complete.

When the EC determines classified mission initialization files have been read from the MU, the EC classified data management system is activated. When activated, MC1:

1. Displays the HOLD and ERASE options on the MUMI display.
2. Displays the CDATE advisory.
3. Sends applicable maintenance code(s) to the SDC.

2.19.1.2.5 Automatic Erase. The MU, SMS, MC1, and MC2 automatically erase classified data when all of the following criteria are met.

1. Airspeed is less than 80 KCAS.
2. Left and right engine THA less than 29°.
3. Transition from WoffW to WonW.
4. Pilot does not select erase inhibit (HOLD) or MC SUSPEND options.

NOTE

Automatic erase can be inhibited by selecting the HOLD pushbutton option.

5. HOLD boxed with MU displayed prevents automatic erase of the MU.
6. HOLD boxed with ALL displayed prevents automatic erase of all units (MU, armament computer, MC1, and MC2).

The EC commands the MU and the armament computer, then MC1 and MC2 to erase. The MC ERASE IN XX SEC countdown timer starts (60 seconds). During the countdown, an MC SUSPEND pushbutton option is displayed. The MC SUSPEND option may be toggled between boxed (selected) and unboxed (deselected). When the timer reaches zero and the MU and armament computer have finished erasing, the decision to continue erasing the remainder of MC1 and MC2 depends on the MC SUSPEND option being deselected (unboxed); when deselected, the remaining erase of MC2 and MC1 is completed.

NOTE

With AMCD aircraft, during an ERASE, the DDI controlled by the MC undergoing the erase will flash STANDBY, then briefly display a green square, then flash STANDBY until the erase is complete.

Automatic erase is also initiated by pilot ejection. The state of the HOLD options is ignored during pilot ejection.

2.19.1.2.6 Manual Erase. Manual erase is a two pushbutton process and is initiated by pressing the ERASE pushbutton on the MUMI display. When the ERASE pushbutton is pressed, the option to proceed with the erasure (ERASE) and the option to cancel the erase (CNX) replaces the HOLD and ERASE options. Selecting the second ERASE option initiates erasure. While erase is in progress, ERASE is boxed and erasing proceeds the same as automatic erase. When erasing is complete, the ERASE pushbutton unboxes. While erase is in progress one of the following is displayed on the MUMI display:

1. ERASING - erasing of unit is in progress.
2. COMPLETE - erasing of unit is complete.
3. FAILED - unit failed to erase.

NOTE

With AMCD aircraft, during an ERASE, the DDI controlled by the MC undergoing the erase will flash STANDBY, then briefly display a green square, then flash STANDBY until the erase is complete.

When erase fails, the MC1 retains the MUMI ERASE and HOLD pushbutton options and displays the ERASE FAIL caution on the DDI. When erasing is complete, MC1 removes the ERASE, HOLD, and MC SUSPEND pushbutton options from the MUMI display, removes the CDATA advisory from the display, and resets the applicable maintenance code(s).

2.19.1.2.7 Backup Erase Controller. If MC1 fails, backup erase capability is provided by MC2 by providing an ERASE option on the HSI format. When the ERASE pushbutton is depressed, the option to proceed with the erasure (ERASE) and the option to cancel the erasure (CNX) are provided. Selecting the second ERASE option initiates erasure. While ERASE is in progress, the ERASE option is boxed; however, additional cuing is not provided. In backup mode, pilot ejection is the only automatic erase provided. With AMCD aircraft, the MUMI display for the MC being erased disappears while the erase is in progress.

2.19.2 Master Modes. There are three master modes of operation: navigation (NAV), air-to-air (A/A), and air-to-ground (A/G). Controls, displays, and the avionics equipment operation are tailored as a function of the master mode selected. The navigation master mode is entered automatically when power is applied to the aircraft, when the air-to-air or air-to-ground modes are deselected, when the landing gear is lowered, when the SPIN mode activates, or when the aircraft has WonW and the THA is greater than 27°. The A/A master mode is entered either by pressing the A/A master mode button alongside the left DDI or by selecting an A/A weapon with the A/A weapon select switch on the control stick. The A/G master mode is selected by pressing the A/G master mode button. The selection is performed by the stores management set (SMS), and the SMS identifies the selected master mode to the mission computer.

2.19.2.1 Steering Information. The sources of steering information available in the NAV master mode are waypoint, TACAN, instrument landing system, and data link. The data link modes available in the NAV master mode are vector and automatic carrier landing. TACAN and waypoint steering are mutually exclusive; selecting one automatically deselects the other. Data link, ILS, and TACAN (or waypoint) steering can be provided simultaneously. The ACL mode is selectable only in the NAV master mode and the vector mode is available in all master modes. Steering information is used by the Automatic Flight Control System to provide coupled steering options.

2.19.3 Cockpit Controls and Displays. The cockpit controls and displays which are used for navigation operation are on the multipurpose display group.

2.19.4 Multipurpose Display Group. The multipurpose display group consists of the right and left digital display indicators (DDIs), the multipurpose color display (MPCD), 8 x 10 display, the digital map set (DMS), the head-up display (HUD), the CRS (course) set switch, the up front control display (UFCD) and the HDG/TK (heading/ground track) set switch. The multipurpose display group

presents navigation, attack, and aircraft attitude displays to the pilot. The multipurpose display group converts information received from the mission computer system to symbology for display on the DDIs, the MPCD, the UFCD, and the HUD. The HUD camera records the outside world and HUD symbology. The left and right DDIs, 8 x 10 display and the MPCD contain pushbuttons for display selection and selection of various equipment operating modes. The UFCD is an active matrix liquid crystal display with an infrared (IR) touchscreen for operator inputs. Refer to Part VII for the operation of each component.

2.19.4.1 CRS Set Switch. The course set switch, located on the main instrument panel on the video record panel, manually sets the desired course on the HSI display.

2.19.4.2 HDG/TK Set Switch. The heading/ground track set switch located on the main instrument panel on the video record panel, manually sets the heading marker on the desired heading/ground track on the HSI display.

2.19.4.3 DDIs. The left and right DDI (LDDI/RDDI) are physically and functionally interchangeable, giving the ability to display desired information on either indicator. With non-AMCD aircraft, the DDIs also provide symbology to the HUD. The left indicator is used primarily for stores status, built in test status, engine monitor, caution, and advisory displays. The right indicator is normally used for radar and weapon video displays.

(Non-AMCD aircraft) The DDIs are NVG compatible and display three colors (red, yellow, and green) for stroke information. A monochrome version of the digital map can be selected on the left DDI. Either DDI can provide raster generation for the HUD.

NOTE

It is possible that a transient condition may cause the displays to blank or provide an erroneous display on the left or right DDI, or HUD. The problem may be cleared by manually cycling the power to the left or right DDI.

(AMCD Aircraft) The DDIs have full color capability in all display modes and are NVG compatible.

2.19.4.3.1 Brightness Selector Knob - Non-AMCD Aircraft. Placing this rotary knob to OFF prevents the DDI from operating. Placing the knob to NIGHT provides a lower brightness control range and no automatic contrast control. Turning the knob to DAY provides a higher brightness control range.

2.19.4.3.2 BRT Control Knob - Non-AMCD Aircraft. This knob varies the intensity of the DDI presentation.

2.19.4.3.3 Brightness Knob - AMCD Aircraft. Placing this rotary knob to OFF prevents the DDI from operating. When turned on, rotating the knob clockwise increases display brightness, while rotating the knob counterclockwise decreases display brightness.

2.19.4.3.4 GAIN Control - AMCD Aircraft. This three-position rocker switch affects the existing gray-scale, shifting the background brightness up or down, with no impact on displayed symbology. The center position is off, while the up arrow increases background brightness and the down arrow decreases background brightness. The up and down arrows have momentary and scroll functionality,

depending on how long they are held. Current values are temporarily displayed when switches are pressed.

2.19.4.3.5 CONT Control. This knob (non-AMCD aircraft), or three-position rocker switch (AMCD aircraft), varies the contrast between symbology and the dark background on any level of brightness. With AMCD aircraft, when the contrast rocker is pressed, a graphical and numeric representation of the current setting is momentarily displayed on the DDI.

2.19.4.3.6 DDI Pushbuttons. There are 20 pushbuttons on each DDI which are used to select the function and the mode for proper indicator display.

2.19.4.3.7 MENU Formats. There are two MENU formats (figure 2-47), TAC (tactical) and SUPT (support) through which display selections can be made. The two menu formats can appear on either the DDI, the UFC, 8 x 10 display or MPCD.

The TAC MENU is indicated by the word TAC appearing just above the MENU option. The TAC MENU is selected by actuating the MENU option on any format other than the TAC MENU format. The SUPT MENU is indicated by the word SUPT appearing just above the MENU option. The SUPT MENU is selected by actuating the MENU option on the TAC MENU. With MC OFP H2E AND UP, the current time of day, consisting of two minute digits and two second digits appear in place of the MENU legend (cold start default). Time of day is also turned on/off with the TISM option on the Engine Format. MENU pushbutton functionality is unchanged.

The TAC MENU allows selection of the following formats: AZ/EL, HUD, RDR ATTK, STORES, FLIR, NFLIR, DL13, HARM, A/G WPN, JSOW, SA, IMAGE, CAS, EW, and TGT DATA. The SUPT MENU allows selection of the following formats: ADI, HSI, HMD, NETS, GPS, MIDS, ROE/IFF PROG, BIT, CTT, MUMI, CHKLST, ENG, FCS, UFC BU, FPAS, and FUEL.

Some of the options on the MENU formats are conditional and are not always displayed. NFLR, FLIR, LST, and CAM are listed only if the equipment is communicating with the mission computer. HARM DSPLY is displayed when HARM is on board and CLC communicating. A/G missile display (WEDL DSPLY, MAV DSPLY, etc.) is displayed when the MC has determined from the armament control processor set that a weapon station has been selected which contains one of these weapons.

In Non-AMCD Aircraft, if the navigation computer (MC1) is not on, only HSI is displayed on the SUPT menu. If the weapon delivery computer (MC2) is not on, the SUPT menu remains unchanged and the TAC menu does not display the STORES, FLIR/LST/CAM or NFLR, AWW-13, HARM, or A/G displays. If both mission computers are off or not communicating with the display, the DDI, MPCD, and UFC display only a flashing STANDBY in the center of the screen.

In AMCD Aircraft, if either mission computer is off or failed (MC Backup Mode), the options available on the displays are the same regardless of which computer is failed. MC1 is no longer referred to as the navigation computer and MC2 is no longer referred to as the weapons computer. If MC1 is failed or not communicating, the left DDIs in both cockpits will either flash STANDBY or have a green square present in the middle of the displays. If MC2 is failed or not communicating with the display, the right DDIs in both cockpits will either flash STANDBY or have a green square present in the middle of the displays. The 8 x 10 display will not be capable of displaying format symbology or video.

The following options are available in MC Backup mode: HUD, EW, FCS, MIDS, MUMI, ENG, UFC BU, FUEL, ADI, and HSI. If A/A master mode is selected, the RDR ATTK, SA, and AZ/EL formats are available as well. No A/G displays are supported in MC Backup mode. If both mission computers are off or failed, a backup HUD format (driven by the SDC) is displayed on the UFC and MPCD in the front cockpit.

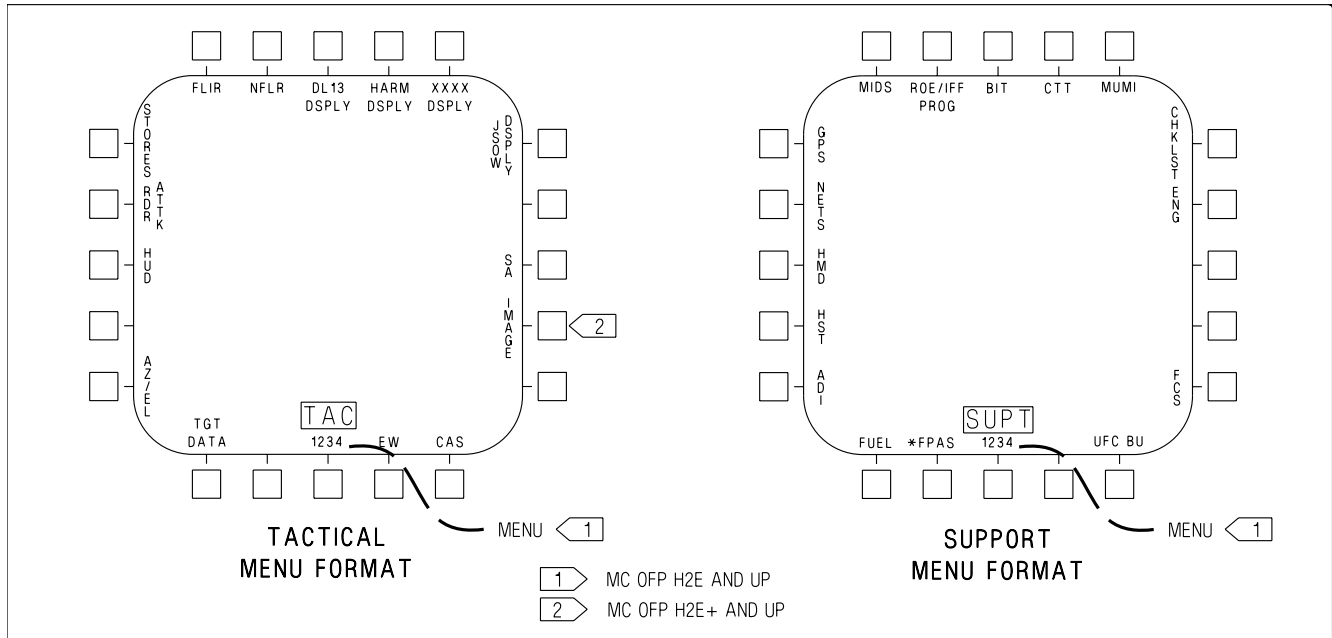

EFN520-143-1-014

Figure 2-47. MENU Format

2.19.4.3.8 Electronic Attitude Display Indicator (EADI). The electronic attitude display indicator is available for display on the left or right DDI as an alternative to the attitude display on the HUD (figure 2-48). The EADI display is selected by selecting the ADI option on the SUPT MENU. The pitch ladder is displayed in 10° increments. A small circle is displayed on the ball to represent the zenith and a circle with an inscribed cross is displayed to represent the nadir. A turn indicator which displays FCS yaw rate is provided below the ball. A standard rate turn (3°/second) is indicated when the lower box is displaced so that it is under one of the end boxes.

Selecting the INS or STBY options at the bottom of the display determines the source of attitude information used to generate the display. Upon power-up with WonW, the EADI attitude initializes to STBY (STBY boxed), thus using the standby attitude reference indicator for attitude source information. Selecting the INS option (INS boxed) uses attitude information provided by the INS. Selection of INS or STBY on the EADI does not change the source of attitude data for the HUD.

Airspeed and altitude are displayed in boxes at the top left and right. Altitude source is displayed to the right of the altitude box and the vertical velocity is displayed above the altitude box. When ILS is selected the deviation needles are displayed in reference to the waterline symbol. The ILS needles are yellow when COLOR is selected on the Attack display.

2.19.4.3.9 Shaped Attitude Display Indicator. When the ADI option is selected on the SUPT menu, a shaped attitude display indicator is available on the MPCD, UFCD, or DDI and 8 x 10 display (AMCD aircraft). The pitch ladder is displayed in 10° increments, with ±30° in pitch being displayed when the gear is up. With the gear down, the pitch ladder is displayed in 5° increments with ±15° in pitch being displayed. A turn indicator is provided below the ball. A standard rate turn (3°/second) is indicated when the lower box is displaced so that it is under one of the end boxes.

On the MPCD and 8 x 10 display, the shaped ADI is black above the horizon to represent sky, and green below the horizon to represent the ground. On the UFCD, the shaped ADI is unshaded above the horizon (sky) and shaded green below the horizon (ground).

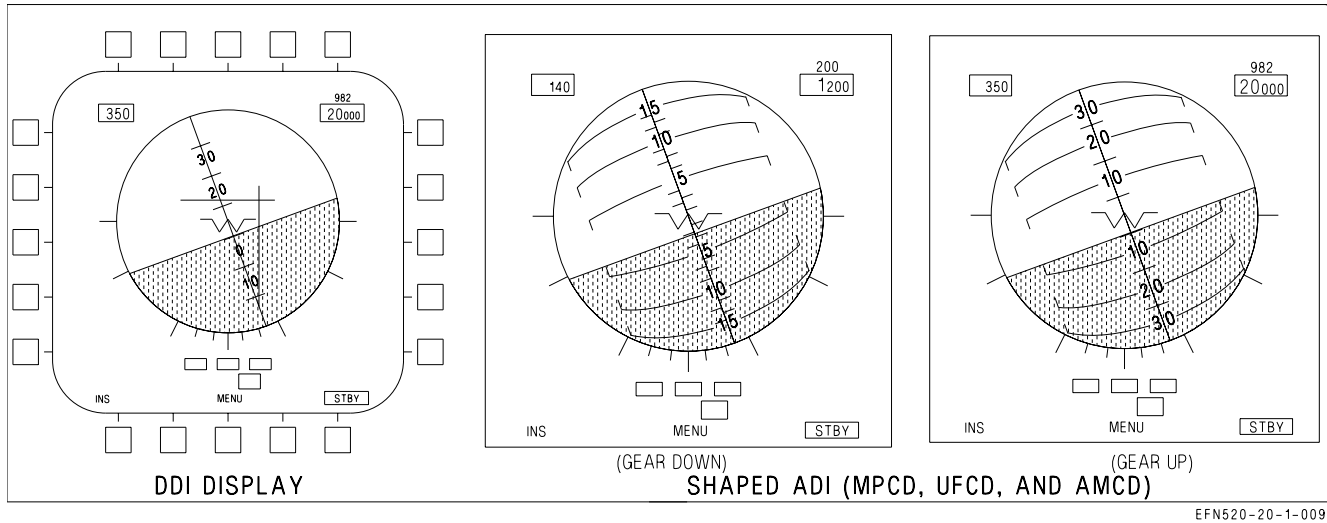

Figure 2-48. Electronic Attitude Display Indicator

Selecting the INS or STBY options at the bottom of the display determines the source of attitude information used to generate the display. Upon power-up with WonW, the ADI attitude initializes to STBY (STBY boxed), thus using the standby attitude reference indicator for attitude source information. Selecting the INS option (INS boxed) uses attitude information provided by the INS. Selection of INS or STBY on the ADI does not change the source of attitude data for the HUD.

Airspeed and altitude are displayed in boxes at the top, altitude source is displayed to the right of the altitude box and vertical velocity is displayed above the altitude box. When ILS is selected the deviation needles are displayed in reference to the waterline symbol. The ILS needles are yellow when COLOR is selected on the attack display.

2.19.4.4 MPCD - Multipurpose Color Display. The MPCD is an NVG compatible digital display capable of providing any MENU selectable format except the video on the A/G radar display (figure 2-50). The MPCD drives itself using information received on the MUX.

The BRT knob controls the overall video and symbology brightness and also acts as the power control for the MPCD and UFCD; a detented OFF position at the extreme counterclockwise position. The CONT knob adjusts the video contrast of the MPCD display. The day/night mode is controlled by the day/night/NVG switch on the interior lights panel.

2.19.4.4.1 Standby Indication. A flashing STANDBY indication is provided in the center of the display on initial power-up and when there is invalid mux communication with the MC. If the STANDBY condition persists for a few seconds, cycling power to the MPCD may return the MPCD and UFCD to normal operation.

2.19.4.4.2 Brightness and Contrast Controls. The brightness control is used to adjust the overall brightness of the MPCD display surface, allowing symbology and video to be adjusted. The full counterclockwise position of the brightness control knob shuts off power to both the MPCD and the UFCD. Selecting ON powers both the MPCD and the UFCD.

The contrast control is used to adjust video contrast.

2.19.4.4.3 Symbology Rocker Switch. The symbology (SYM) brightness rocker switch is used to adjust the brightness of the symbology without affecting the brightness of the MPCD video.

Symbology change feedback is provided in the left center of the display by a digit from 0 to 9. This feedback is provided while the rocker switch is pressed and for 5 seconds after the rocker switch is released.

2.19.4.4.4 DDI Formats on MPCD. Every display format is available on the L or R DDI. A/G radar symbology and monochrome video is available on the MPCD. A/G video is not available.

2.19.4.4.5 MPCD Formats. With non-AMCD aircraft, if two different map formats are provided in the front and rear cockpits, only one displays the map; the other provides only symbology. The priority of the format which displays the map is HSI, followed by SA.

With AMCD aircraft, if two different formats are requesting MAP video underlay, only one displays the video underlay; the other provides only symbology. MAP video display priority is determined by two things: 1) which display surface is requesting the MAP underlay and 2) which format is requesting the MAP underlay. Highest display surface priority is given to the MPCD followed by the DDIs. The SA format is given the highest priority, followed by the HSI format, for formats requesting the MAP underlay. Once the MAP is displayed for any format, (SA, HSI), any display surface with that same format selected will also have the MAP underlay displayed. The MAP underlay is only supported on the SA or HSI formats.

2.19.4.4.5A 8 x 10 Display. On aircraft LOT 26 AND UP, the 8 x 10 display replaces the aft MPCD. The 8 x 10 display has a full color Active Matrix Liquid Crystal Display surface and 30 pushbuttons used for operator inputs. Only 20 buttons are functional, and they duplicate the MPCD/DDI menu layouts. The top row outboard buttons and top four buttons on each side are not used. The brightness control switch adjusts the video brightness. The full counterclockwise position, a detented OFF position, removes power from the 8 x 10 display and the aft cockpit UFCD. Two rocker switches provide Gain and Contrast control. A numeric value displayed near the switches is used to adjust the gain and/or contrast to a desired level. Pushbuttons are backlit, controlled by the INST PNL knob on the aft cockpit interior lights panel. The following formats and related sublevel formats are available: TAC Menu, SUPT Menu, HSI, EW, SA, TFLIR and BIT. Figure 2-49 shows symbology placement and map coverage for the 8 x 10 display. See figure FO - 4, foldout section for aft cockpit arrangement with the 8 x 10 display installed.

The 8 x 10 display is connected directly to MC2. The computer recognizes whether an 8 x 10 display or an MPCD is installed and uses the corresponding software that matches the configuration at startup. This affects the UFCD controls and functions in addition to the 8 x 10 display. When MC2 is offline or during initialization, the 8 x 10 display does not show a format or process bezel inputs. A flashing STANDBY indication is provided in the center of the 8 x 10 display when MC2 is not communicating properly with the 8 x 10 display. A standby display pattern (approximately a 1- by 1-inch green square) is present when the Image Transfer Bus (ITB) has lost symbology, video, or a combination, and the selected format is affected. When interface between MC2 and 8 x 10 display is lost, only symbology is displayed (via ITB). There is no pushbutton feedback, video control, or BIT reporting when interface is degraded. The day/night mode of the 8 x 10 display (and rear UFCD) is set via the DAY/NITE/NVG switch on the forward cockpit interior lights panel through MC2.

In the Situational Awareness (SA) format, the cursor (captains bars) may be slewed over the entire 8 x 10 display surface. Because this area is larger than the DDIs/MPCD, if another display is showing the same format and the cursor on the 8 x 10 display is slewed beyond the center area, the cursor on the DDI/MPCD is limited. When this happens, the cursor on the DDI/MPCD displays flashes continuously. When a SA format has DC priority assigned, the initial cursor position is determined by the cockpit that initiates the slewing action.

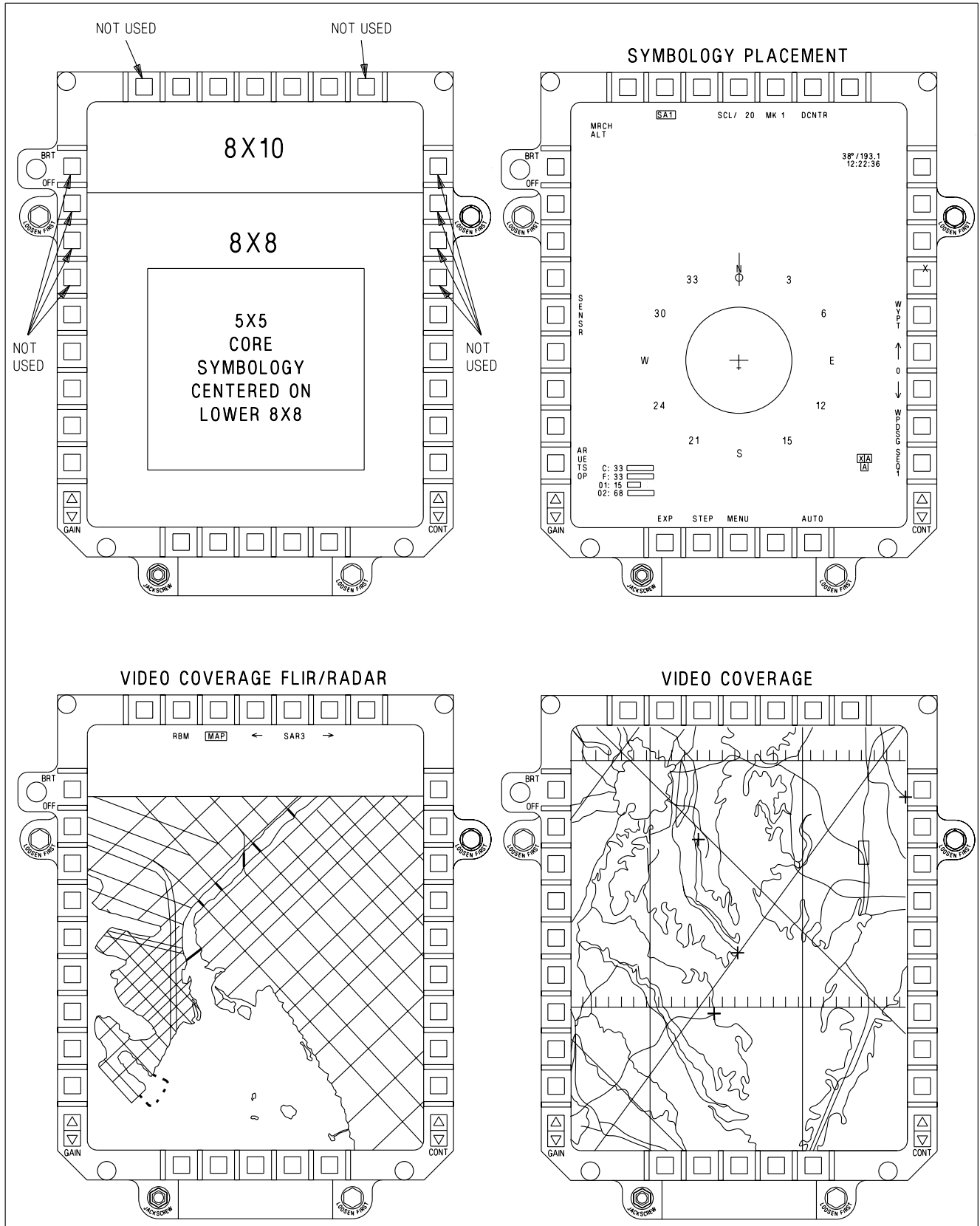

Figure 2-49. 8 x 10 Display

EFN520-417-1-013

2.19.4.5 HSI Display Symbology. Basic HSI symbology such as the compass rose, ground track pointer, lubber line (for magnetic heading), true airspeed readout, ADF bearing pointer, groundspeed readout, and aircraft symbol are not described. These symbols are shown in figure 2-50.

Display format lines, just below the top row of pushbutton labels, indicate the formats being displayed on the left, center, right and UFCD displays in both the cockpit (left side of HSI display) and rear cockpit (right side of HSI display).

Radar target and GEOREF symbols are described in A1-F18EA-TAC-Series. The following paragraphs describe unique navigation symbology. Refer to part VII for a description of how these symbols are integrated with the navigation system:

1. Waypoint/OAP data. Data for the current steer to waypoint/OAP is displayed on the upper right corner of the HSI. Waypoint/OAP data consists of bearing, range, and TTG (time-to-go) up to 8:59:59 based on distance and ground speed. When a waypoint/OAP or offset to the OAP is designated (becomes a target), this data relates to the target. When a waypoint is a waypoint that was transferred from the GPS, an ID code is displayed under the waypoint data.
2. TACAN data. TACAN data is displayed on the upper left corner of the HSI. TACAN data consists of bearing, range (slant range), TTG (based on distance and present ground speed), and the station identifier.
3. Waypoint/OAP symbology. Waypoint/OAP symbology consists of a waypoint/OAP symbol and a bearing pointer and tail. The waypoint/OAP symbol indicates the position of the selected waypoint/OAP relative to the aircraft symbol. The waypoint/OAP bearing pointer and tail are displayed inside the compass rose and indicate bearing to the selected waypoint/OAP. Waypoint/OAP symbology is displayed whether or not waypoint/OAP steering is selected. When the selected waypoint/OAP is outside the HSI range scale, the waypoint/OAP symbol does not appear, but the bearing pointer and tail appears. When a waypoint/OAP is designated, the waypoint/OAP symbol and circle inside the pointer change to a diamond shape. The offset symbol appears when steering is to an OAP. The offset symbol indicates the position of the offset relative to the OAP.
4. TACAN symbology. TACAN symbology consists of a TACAN symbol, and TACAN bearing pointer and tail. The TACAN symbol indicates the position of the TACAN station relative to the aircraft symbol. The TACAN bearing pointer and tail are located outside of the compass rose and indicate bearing to the TACAN station. When the TACAN station is outside the HSI range scale, the TACAN symbol does not appear but the bearing pointer and tail appear. When TACAN range becomes invalid the TACAN symbol is not displayed.

NOTE

TACAN symbology displayed inside of the compass rose is filtered to prevent excessive movement of TACAN symbols due to RF interference. However, the "fly-to" needle displayed in the HUD with TACAN steering selected is not filtered and represents the raw data received by the TACAN. As a result, for brief periods of time, the HUD and HSI may display conflicting information regarding aircraft position with respect to the selected TACAN course line. Aircrew should use HUD displayed TACAN information when conducting TACAN approaches.

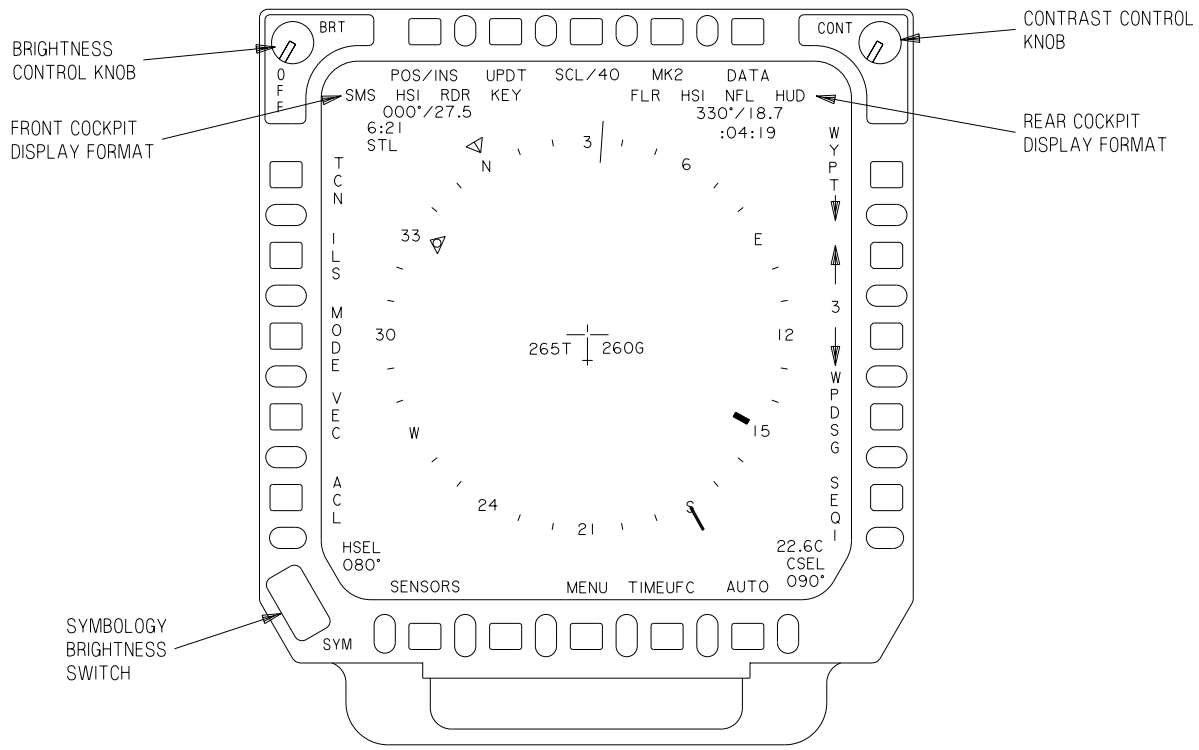

NOTE

THIS IS NOT A TYPICAL HSI DISPLAY

- | | | | |
|------------|--------------------------------------|-------------------------|---|
| ◇ | TDC ASSIGNMENT DIAMOND | ▣ | RADAR TARGET SYMBOL |
| ○ | WAYPOINT/OAP SYMBOL | ▢ | HEADING SELECT MARKER |
| ② | GEO REF POINT | ↖ | COURSE LINE |
| + | OFFSET SYMBOL | 258T 260G | AIRCRAFT DATA (TRUE AIRSPEED, AIRCRAFT SYMBOL, GROUNDSPED) |
| ◇ | DESIGNATED TARGET | 330° / 27.5
STL 5:46 | TACAN DATA (BEARING, RANGE, TTG, STATION ID) |
| △ | TACAN SYMBOL | 030° / 20.0
3.47 | WAYPOINT/OAP DATA (BEARING, RANGE, TTG) |
| ○ | ADF BEARING SYMBOL (BEFORE ECP 6061) | CPL — — WYPT | COUPLED TCN, SEQ, WYPT, P/R, HDG, ASL, OR BNK |
| ▽ | TACAN BEARING POINTER | HSEL 050° | HEADING SELECT READOUT |
| ▽ | WAYPOINT/OAP BEARING POINTER | 22.6C
CSEL 310° | PERPENDICULAR DISTANCE TO SELECTED COURSE, COURSE LINE READOUT |
| ▽ | DESIGNATED TARGET BEARING POINTER | ET 00:00 / CD 00:00 | ELAPSED TIME (ET)/COUNTDOWN (CD) TIME |
| ▢ | WAYPOINT/OAP BEARING POINTER TAIL | ◇ | BOTH COCKPITS HAVE TDC/DC PRIORITY ASSIGNED TO THE SAME FORMAT |
| ▬ | TACAN BEARING POINTER TAIL | ∨ | AFT COCKPIT HAS DC PRIORITY ASSIGNED TO THIS FORMAT |
| 00:00:00 Z | ZULU TIME OF DAY | ∧ | FRONT COCKPIT HAS DC PRIORITY ASSIGNED TO THIS FORMAT |
| 00:00:00 L | LOCAL TIME OF DAY | ↕ | SLEW MAP SLEW FUNCTION SELECTED IN THE BOTH COCKPITS |
| 400G REOD | GROUNDSPED REQUIRED | ↕ | SLEW MAP SLEW FUNCTION SELECTED IN THE AFT COCKPIT |
| TRUE | TRUE NORTH HEADING SELECTED | ↕ | SLEW MAP SLEW FUNCTION SELECTED IN THE FRONT COCKPIT |
| ↖ | SEQUENTIAL STEERING LINES | ← | DC PRIORITY ASSIGNED TO THIS FORMAT VIA THE LEFT HAND CONTROLLER |
| | LUBBER LINE (MAGNETIC HEADING) | → | DC PRIORITY ASSIGNED TO THIS FORMAT VIA THE RIGHT HAND CONTROLLER |
| | LUBBER LINE (TRUE HEADING) | | |
| ◇ | GROUND TRACK POINTER | | |

Figure 2-50. MPCD Controls and HSI Symbology

5. Heading select/ground select marker and readout. The heading select/ground select marker is maneuvered along the periphery of the compass rose using the HDG/TK switch. The digital readout of the selected heading is located on the lower left corner of the HSI. The heading select/ground select marker and digital readout are part of the heading select/ground track select mode of the autopilot.

Course line arrow and readout. The course line arrow indicates the selected course to the waypoint/OAP or TACAN station. The course is selected using the CRS switch. The digital readout of the selected course is displayed on the lower right corner of the HSI. The course line arrow is not displayed when TACAN range is invalid.

6. TDC assignment symbol. The TDC assignment diamond is displayed on the upper right corner of the HSI. This symbol indicates that the TDC is assigned to the HSI. The TDC assignment diamond indicates control is assigned to both cockpits. Other symbols indicate cockpit (^) or rear cockpit (v) TDC control and SLEW control. SLEW is done by actuating the sensor control switch AFT while in the NAV or A/G master mode. The word SLEW is displayed in the TDC assignment diamond position when the SLEW option is active.

7. Coupled steering symbology. CPL and the source of the steering information is displayed on either side of the aircraft symbol in the center of the HSI display whenever the flight control system is coupled in azimuth to a steering source. Steering source can be WYPT, TCN, or SEQ#. The couple cue flashes for 10 seconds and is removed if the steering signal is lost or becomes invalid.

8. Sequential steering lines. The sequential steering lines are displayed when a sequence is entered and when one of the sequence options (SEQ1, SEQ2, SEQ3, or SEQL) is boxed. The sequential steering lines are available for display in all HSI modes and range scales. Sequential steering lines are not displayed at power up with WonW and are removed when: magnetic heading is invalid, aircraft position is invalid, or map slew is selected.

9. Time of day. Zulu time of day (ZTOD) or local time of day (LTOD) are displayed on the lower left corner of the HSI. For aircraft that pass the FIRAMS real time clock power up BIT, ZTOD does not need to be entered. For aircraft that do not pass the FIRAMS real time clock power up BIT, ZTOD must be entered.

10. Groundspeed required. Groundspeed required appears below the current groundspeed readout. Groundspeed required indicates the groundspeed required to a target based on entered ZTOD, time on target (TOT), and the target.

11. Elapsed time (ET)/countdown (CD) time. ET and CD time are displayed on the lower right corner of the HSI, however, only one of the timers can be displayed at a time. ET or CD timer must be selected to be displayed. ET initializes to zero minutes and seconds and CD time initializes to six minutes and zero seconds.

12. Aircraft heading. Aircraft heading is indicated on the compass rose. Aircraft heading and bearing data can be selected as either magnetic or true. With true heading selected, the letter T appears below the lubber line and the word TRUE appears below the selected scale readout. There is no indication when magnetic heading is selected.

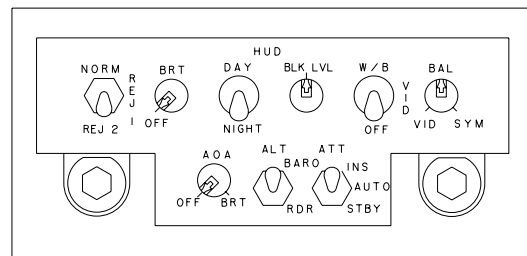

EFN520-22-1-001

Figure 2-51. HUD Controls

2.19.4.6 HUD - Head-Up Display. The HUD is on the center main instrument panel. The HUD is used as the primary flight instrument, weapon status, and weapon delivery display for the aircraft under all conditions. (Non-AMCD aircraft) The HUD receives attack, navigation, situation, and steering control information from the left or right DDI symbol generators (under mission computer control) and projects symbology on the combining glass for head-up viewing. (AMCD aircraft) The HUD receives all symbology from MC1 or MC2. The HUD is electrically interfaced with the UFCD. The HUD has NVG compatible raster display capability to allow it to display NFLR video. The controls for the HUD are below the UFCD and are described in the following paragraphs. See figure 2-51.

2.19.4.6.1 HUD Symbology Reject Switch. The HUD reject switch is located on the HUD control panel on the center main instrument panel. This switch is used to control the amount of symbology displayed on the HUD.

NORM Displays full HUD symbology.

REJ 1 Removes the Mach, g, and peak-g indications, the bank angle scale and pointer, the air-speed and altitude boxes, energy caret (landing gear down), and the ground speed required cue.

REJ 2 Removes REJ 1 symbology and the heading scale, current heading caret, command heading marker, NAV/TCN range, and the ET, CD, LTOD or ZTOD timer.

2.19.4.6.2 HUD Symbology BRT Control Knob. This knob is used to turn on the HUD and then varies the display intensity.

2.19.4.6.3 HUD Symbology Brightness Selector Switch. This is a two-position toggle switch with positions of DAY and NIGHT. Placing the switch to DAY provides maximum symbol brightness in conjunction with the HUD symbology brightness control. With the switch set to NIGHT, a reduced symbol brightness is provided in conjunction with the HUD symbology brightness control.

2.19.4.6.4 Black Level Control Knob. The black level control knob, located on the HUD control panel, adjusts the NFLR video plus or minus $\frac{1}{2}$ a shade of gray per increment when rotated.

2.19.4.6.5 HUD Video Control Switch. The video control switch, located on the HUD control panel, enables NFLR video display on the HUD with selectable polarity (white hot/black hot).

- W/B Selects white hot/black hot polarity.
- VID Displays NFLR video in the HUD, if available.
- OFF NFLR video off.

2.19.4.6.6 BAL Control Knob. The balance control, located on the HUD control panel, adjusts the stroke brightness relative to the raster brightness. Rotating the switch from 12 o'clock towards the VID position holds the brightness of the video (as set by the brightness control switch) and reduces the brightness of the stroke symbology. The opposite is true when rotating the switch toward the SYM position.

2.19.4.6.7 AOA Indexer Control Knob. This knob controls the brightness of the indexer lights.

2.19.4.6.8 ALT Selector Switch. The ALT selector switch, located on the HUD control panel, is used to select the primary altitude source for display on the HUD and for use in the mission computer (weapon systems calculations).

- BARO Selects barometric altitude.
- RDR Selects radar altitude.

2.19.4.6.9 ATT Selector Switch. The ATT selector switch, located on the HUD control panel, is used to select the primary attitude source used for display in the HUD and in MC and FCC computations.

- INS Functions identically to the AUTO position.
- AUTO Selects filtered INS data as the primary attitude source. The INS automatically reverts to gyro mode, using unfiltered data if its processor fails. The MC automatically selects the standby attitude reference indicator for attitude information if the INS fails completely.
- STBY Selects the standby attitude reference indicator. The FCCs no longer use INS data and the HIAOA advisory is displayed.

2.19.4.6.10 HUD Symbology. The following paragraphs describe HUD symbology as related to basic navigation, steering (direct, great circle, coursesline, and ILS), navigation target designation, advisories and landing, see figure 2-52. Refer to part VII for a description of how these symbols are integrated into the navigation system. Also, refer to section VII for unique ACL data link symbology. Refer to A1-F18EA-TAC-Series, for symbology concerning the A/A and A/G master modes, weapons, RWR and the data link vector mode.

1. Heading. The aircraft magnetic/true heading is indicated by the moving 30° heading scale. The actual aircraft heading is directly above the caret/T symbol. The moving heading scale provides trend information during turns. As the aircraft turns right, the scale moves from right to left. Magnetic or true heading may be selected. Magnetic heading is indicated by a caret below the heading scale. True heading selection is indicated by a T appearing below the current heading.

2. Airspeed. Calibrated airspeed from the FCC is provided in the box on the left side of the HUD. The tops of the airspeed and altitude boxes are positioned at the aircraft waterline, which is 4° up from the optical center of the HUD.



HUD airspeed should normally read less than 50 knots while sitting still on the ground. A reading of more than 50 knots on the ground may indicate an Air Data failure.

3. Altitude. The altitude presented in the box on the right side of the HUD may be either barometric altitude or radar altitude depending on the setting of the altitude switch on the HUD control panel. When the altitude switch is in the BARO position, barometric altitude is displayed. When the altitude switch is in the RDR position, radar altitude is displayed and is identified by an R next to the altitude. If the radar altitude is invalid, barometric altitude is displayed and a B next to the altitude flashes to indicate that barometric altitude is being displayed rather than radar altitude. An X displayed next to the barometric altitude indicates that the altitude value may be inaccurate. The ten thousand and thousand digits are 150% size numbers. The hundred, ten, and unit digits are 120% size numbers, except that below 1,000 feet they are 150% size.

4. Barometric setting. The barometric setting used by the air data function in the FCC is the value set in the standby altimeter. When the barometer setting is changed on the standby altimeter, the barometric setting is presented below the altitude on the HUD to provide a head-up baro-set capability. The display remains for 5 seconds after the change is made. In addition, the baro-set value is displayed and flashed for 5 seconds when the aircraft descends below 10,000 feet at an airspeed less than 300 KCAS.

5. Angle of Attack. True angle of attack in degrees is displayed at the left center of the HUD. AOA values displayed on the HUD are filtered and may slightly lag actual true AOA. Therefore, it may be possible to trigger the AOA tone slightly prior to seeing the applicable limit AOA in the HUD.

The HUD AOA is generally driven by the FCS using the AOA probes. However, around 42° AOA (and -9°), the HUD reverts to an MC-computed AOA based on INS data and winds. The HUD AOA flashes indicating that the displayed HUD AOA may be inaccurate because the INS computed winds have not been updated in the past three minutes. Low AOA, small bank angles, and small rates are required to update the wind. With MC OFP H3E AND UP, the pitch trim AOA value is displayed next to the ATC HUD advisory location while trimming and for two seconds after trimming with WoffW and flaps HALF or FULL. The value is displayed with or without ATC engaged but is not displayed with autopilot engaged.

6. Mach number. The aircraft Mach number is displayed immediately below the angle of attack.

7. Aircraft g. Normal acceleration of the aircraft is displayed immediately below the Mach number.

8. Peak aircraft g. A peak positive g indication is displayed on the HUD below the normal g when a threshold of 4.0g is exceeded. The peak positive g display can be removed by cycling the clutter reject switch to one of the reject positions.

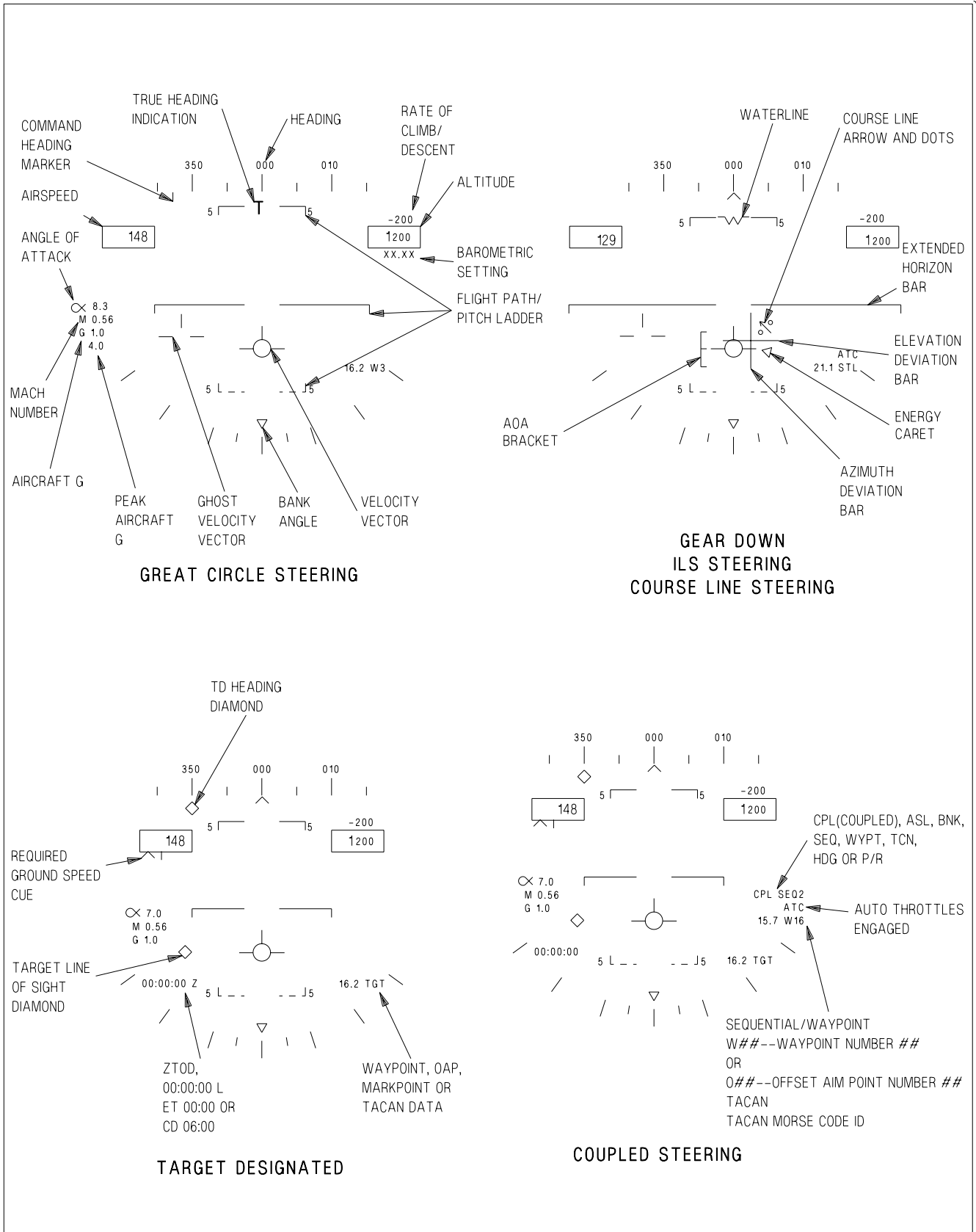

EFN520-39-1-004

Figure 2-52. HUD Symbology (Sheet 1 of 2)

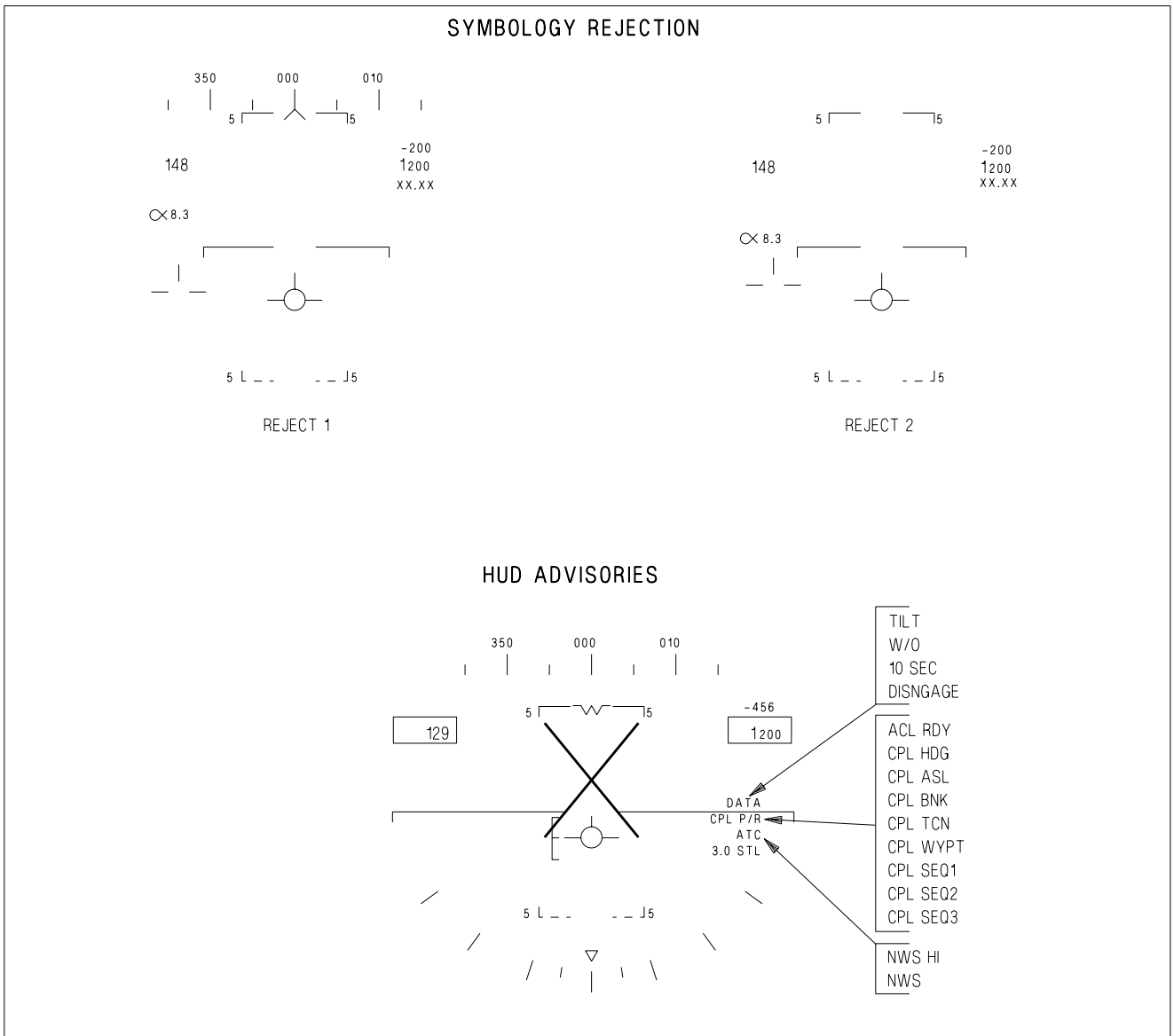

EFN520-39-2-001

Figure 2-52. HUD Symbology (Sheet 2 of 2)

9. Bank angle scale. A bank angle scale and pointer are displayed at the bottom of the HUD for bank angle reference up to 45°. At bank angles in excess of 47°, the bank angle scale pointer is limited at 45° and flashes.

10. Velocity vector. The velocity vector provides an outside world reference with regard to actual aircraft flight path. The velocity vector represents the point towards which the aircraft is flying (aircraft flight path). With a functioning INS, the velocity vector is driven by INS attitude and velocities. If GPS data is valid, a "hybrid" GPS vertical velocity correction is used to correct errors in the INS vertical velocity loop regardless of the INS mode switch position (CV, GND, NAV, or IFA). If GPS data is not available for use in the hybrid correction, a VVEL advisory is displayed.

WARNING

With a VVEL advisory displayed, sustained climbs and descents, such as penetration from the marshal stack, can result in uncued (no cautions) vertical velocity errors and a possible inaccurate velocity vector position. Error magnitudes increase at slower airspeeds and lower altitudes. Errors of up to 3° (actual flightpath 3° below the displayed velocity vector) have been observed in the landing configuration. Three minutes of level flight may be required to allow the INS to correct the vertical velocity errors.

NOTE

The VVEL advisory will be displayed if a GPS is not installed or if masking prevents GPS positioning of a sufficient quality to "aid" the INS vertical velocity loop.

The position of the velocity vector is limited to an 8° radius circle centered at the HUD optical center. If the velocity vector reaches this limit during high angle of attack flight or large yaw and/or drift angles, it flashes rapidly to indicate that it does not accurately indicate flight path (velocity vector is HUD limited).

With GPS operating, if the INS velocity data becomes unreliable, the mission computer utilizes GPS information. If INS velocity data becomes unreliable the mission computer utilizes FCC air data function information and the last available wind data to compute the velocity vector and this degraded velocity vector is indicated by a slow flashing of the symbol. In the NAV master mode, the velocity vector may be caged to the vertical center line of the HUD by the cage/uncage switch on the throttle. When it is caged, a ghost velocity vector is displayed at the true velocity vector position if that position is more than 2° from the caged position. The flight path/pitch ladder and steering information are referenced to the caged position. The ghost velocity vector flashes when limited. The flight path/pitch ladder is referenced to the waterline symbol when the velocity vector is caged.

The velocity vector is automatically fixed at the horizon with WonW and ground speed less than 80 knots, and its status cannot be changed until WoffW. However, the velocity vector's selected caged/uncaged status does not change during touch-and-go landings if the ground speed remains above 80 knots.

11. Flight path/pitch ladder. The vertical flight path angle of the aircraft is indicated by the position of the velocity vector on the flight path/pitch ladder. The horizon and flight path/pitch angle lines represent the horizon and each 5° of angle between ±90°. Positive pitch lines are solid and are above the horizon line. Negative pitch lines are dashed and are below the horizon line. The outer segments of the lines point toward the horizon. Each line is numbered and the numbers rotate with the lines so that inverted flight can easily be determined. To aid in determining flight path angle when it is changing rapidly, the pitch lines are angled toward the horizon at an angle half that of the flight path angle. For example, the 50° pitch line is angled 25° toward the horizon. In level flight, the pitch lines are not angled. The zenith is indicated by a circle and the nadir is indicated by a circle with an X in it. Aircraft pitch angle can be determined by comparing the tops of the altitude and airspeed boxes (which represent the aircraft waterline) with the pitch ladder when the wings are level, but the flight path/pitch ladder normally rotates about the velocity vector and determination of pitch angle may be difficult at high roll angles.

12. Vertical velocity readout. This value is displayed above the altitude box and indicates vertical velocity in feet per minute. This is displayed in the NAV master mode only. Descent is indicated by a minus sign.

13. HUD landing symbology. When any two landing gear are down, the Mach number, g, and peak g are deleted and an AOA bracket, extended horizon bar, waterline symbol, and energy caret appear. The center of the AOA bracket represents the optimum approach AOA. The bracket moves lower with respect to the velocity vector as AOA increases and moves higher as AOA decreases. When the energy state of the aircraft is in equilibrium, the energy caret points to the "right wing" of the velocity vector and the aircraft neither accelerates or decelerates. With an energy deficit, the energy caret moves lower with respect to the velocity vector and the aircraft decelerates; with excess energy, the energy caret moves higher and the aircraft accelerates.

14. Waypoint/OAP, mark point, TACAN, or target data. Waypoint/OAP and mark data consists of range (horizontal), and the steer-to point identifier (W, O, or M) and number located on the lower right corner of the HUD. TACAN data consists of slant range and a Morse code identifier located on the lower right corner of the HUD. When a steer-to point is designated, range remains displayed and the steer-to point identifier changes to TGT.

15. Coupled steering symbology. While coupled steering is engaged CPL SEQ#, CPL WYPT, CPL TCN, CPL BNK, CPL ASL, CPL HDG, or CPL P/R appears on the right side of the HUD display above the navigation data.

16. ILS symbology. When ILS steering is selected, an azimuth deviation bar (localizer) and elevation deviation bar (glideslope) appear on the HUD.

17. ZTOD, LTOD, ET, and CD time. The ZTOD, LTOD, ET, or CD time is displayed on the lower left corner of the HUD. These timers are mutually exclusive. Only one timer is available for display on the HUD at a time. When the FIRAMS real time clock power up BIT passes, ZTOD does not need to be entered, but when the FIRAMS real time clock power up BIT does not pass, ZTOD must be entered. ET initializes to zero minutes and seconds. CD initializes to 6 minutes and zero seconds.

18. Command heading marker. When waypoint/OAP or TACAN direct great circle steering is selected, the command heading marker is displayed just below the heading scale.

19. Steering arrow and dots. When waypoint/OAP or TACAN course line steering is selected, the steering arrow and dots appear on the HUD.

20. Required ground speed cue. When steering is engaged to the target in a sequence, the required ground speed cue appears under the airspeed box.

21. Target designation symbology. When a target is designated, a target designation symbol (diamond) appears below the heading scale indicating target heading. Another target designation symbol (diamond) appears indicating the target line of sight (LOS).

2.19.4.6.11 HUD Symbology Degrades. The avionics suite has built in redundancy with two mission computers for data management and two DDI's (LOTs 21-24), or two MCs (LOTs 25 and up), for symbol generation. Likewise, if the attitude select switch is in the AUTO or INS position, back up data

sources are automatically selected to provide HUD symbology when failures are detected. Refer to figure 2-53, for the HUD displays discussed below.

- a. **HUD Symbology Degrades with INS Failure.** When a failure occurs in the INS, HUD bank angle, velocity vector, pitch ladder, and heading indications can be expected to be impacted. With GPS operating, the mission computer utilizes GPS information for the velocity vector. If INS attitude is valid but INS velocities are not valid the mission computer automatically uses the INS attitude and GPS velocities to position a non-flashing velocity vector. With a degradation of the air data function (probe or pressure transmitter set damage or failure) calibrated airspeed, barometric altitude, indicated Mach number, and vertical velocity indications may be impacted.

When the INS experiences a total shutdown (dump) with the attitude select switch in AUTO or INS, or if the attitude switch is deliberately placed in standby, a stationary waterline symbol replaces the velocity vector indicating that the standby attitude reference indicator is now providing attitude data. This failure is normally accompanied by the MASTER CAUTION light, tone, and INS ATT caution. Place the attitude select switch in the STBY position, crosscheck the HUD against standby instruments, and attempt an in-flight alignment.

Due to the tendency of the standby attitude reference indicator to precess, it is suggested that flying in instrument meteorological conditions (IMC) using the ARI as a primary attitude reference be minimized. A partial IFA (In-Flight Alignment) is always recommended whenever possible to recover the INS attitude platform.

- b. **HUD Symbology Degrades with Air Data Function Failure.** An air data function failure in the FCC results in loss of associated data from the HUD display as shown in figure 2-53. Such a failure also inhibits operation of cruise flight Automatic Throttle Control and disables the altitude signal used for IFF altitude reporting. An air data function failure may affect cabin air flow and cabin air temperature.

The pressure transmitter set can produce erroneous signals without cautions or advisories if the pitot tube or AOA probes receive damage. As the air data function degrades, loss of some or all of the following data from the HUD may occur:

- (1) Calibrated airspeed or barometric altitude. The loss of calibrated airspeed and/or barometric altitude data results in activation of the landing gear handle warning light and tone with the gear UP. Aircrew action is to reference the applicable standby airspeed or altitude indicator and then silence the tone.
- (2) Angle of Attack. Loss of AOA in three or more FCC CHs causes AOA to be removed from the HUD.
- (3) Vertical velocity indicator. Pilot action on loss of the vertical velocity indication is to check that the aircraft is in the NAV master mode and to reference the standby vertical velocity indicator.
- (4) Mach number. Pilot action on loss of the Mach number indication is to reference the standby airspeed indicator.

If an AOA probe becomes jammed (does not move), the FCC continues to receive valid signals until the pilot executes a maneuver that causes the reading between the AOA probes to differ more than 15°

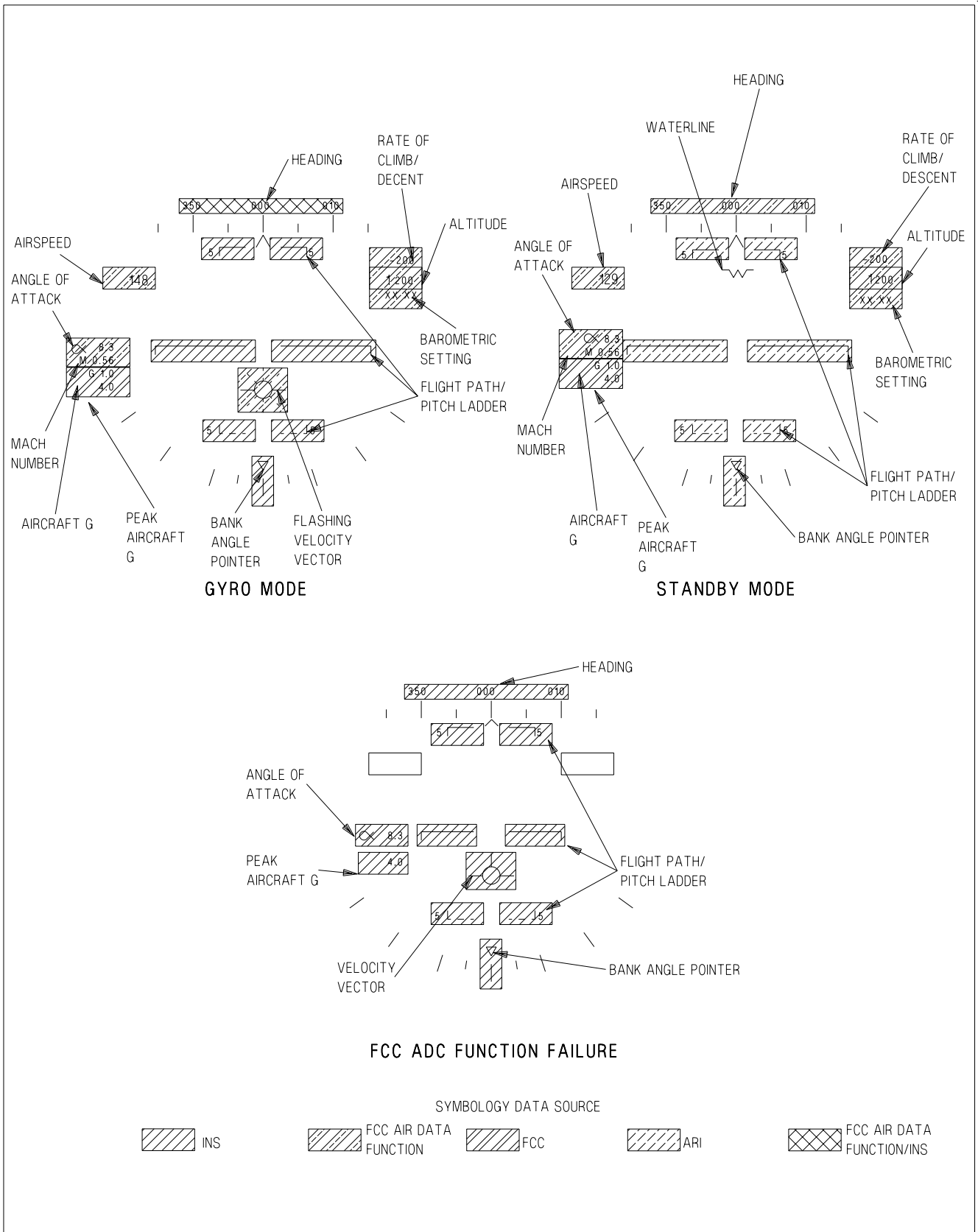

EFN520-58-1-001

Figure 2-53. HUD Symbology Degrades

in UA or 5.5 to 15° in PA, depending on sideslip. HUD displayed airspeed may be inaccurate without annunciation if a pitot tube is damaged.



A jammed, blocked, or damaged pitot tube/AOA probe may not be annunciated if system errors are not large enough to set a caution. Be alert for unannunciated pitot static and AOA errors during flight in icing conditions or if damage is suspected after a bird strike or IFR basket impact during inflight refueling.

Air data inputs from the MC are used by the INS to help smooth or dampen pitch ladder and velocity vector position. A complete air data function failure does not immediately affect the pitch ladder/velocity vector, but these displays eventually degrade. If subtle damage to the AOA probe is suspected, the pilot should make a crosscheck of airspeed with a wingman if possible. The standby airspeed indicator receives signals from the left pitot static probe, so it is accurate if only the right probe is damaged. AOA checks with a wingman should be made in landing configuration if a jammed AOA probe is suspected. Crosschecking in cruise configuration may give a satisfactory crosscheck, but the probe may be bent in such a way that AOA anomalies are accentuated on landing configuration. Landing with automatic throttle control (ATC) may be affected. If damage is suspected, ATC during landing is not recommended.

When AOA is declared invalid (e.g., AOA Four Channel failure), the HUD AOA display and AOA bracket are removed and the AOA indexer lights and approach lights are inoperative. GAIN ORIDE provides fixed gains to the FCS and allows the pilot to select, through the FCS status display, either the left or right probe. The center (INS) AOA value allows the pilot to compare AOA values to select the undamaged probe. Once selected, this probe drives the HUD AOA display, AOA bracket, AOA indexer, and approach lights. If the incorrect probe is selected, the information provided to the pilot and LSO may be in error but has no impact on the flight control system as the gains are fixed. Notify the LSO that a single probe has been selected.

2.19.4.6.12 HUD Advisory Data Symbology. The displays in figure 2-52 show some of the advisories that can appear on the HUD in the NAV master mode. The advisories are associated with nose wheel steering and approach power compensator. Although the advisories are shown on the gear down display, most of them can appear on the basic HUD display. Refer to Part VII for description of data link system and advisories.

The automatic throttle control/nosewheel steering advisories are displayed above the distance display whenever the ATC or the NWS is engaged. If the ATC is disengaged by any means other than actuation of the ATC engage/disengage switch, the advisory is flashed for 10 seconds before it is removed from the display or, if a pilot attempt to engage ATC is not successful, ATC is flashed for 10 seconds and removed.

2.19.4.6.13 HUD BIT Checks. The HUD has two methods of built-in tests: manually initiated and automatic test. Refer to BIT-Status Monitoring Subsystem for the procedures and displays used for the HUD BIT checks.

2.19.4.7 CRS Set Switch. The course set switch manually sets the desired course on the HSI display.

2.19.4.8 HDG/TK Set Switch. The heading/ground track set switch manually sets the heading marker on the desired heading/ground track on the HSI display.

2.19.5 Up Front Control Display (UFCD). The UFCD is on the main instrument panel below the HUD in the front cockpit. In the rear cockpit, the UFCD is located below the MPCD in LOTs 21 thru 25, and above the MPCD or 8 x 10 display in LOT 26 AND UP. The UFCD is an active matrix liquid crystal display with an IR touchscreen used for data entry inputs consisting of digits or NEWS, and control of the CNI systems (autopilot modes, IFF, TACAN, ILS, data link, radar beacon, UHF/VHF radios, and ADF), see figure 2-55. In addition, the touchscreen can be used as a multi-function display for display formats, including video. The UFCD is used in conjunction with the two DDIs, the 8 x 10 display and the MPCD to enter navigation, sensor, and weapon delivery data. UFCD option selections and inputs are transmitted directly to the MPCD and on to the mission computers. (The mission computers pass these inputs to the control converter (CC) for CNI equipment control). The UFCD is NVG compatible. In the F/A-18F, the front and rear cockpit UFCDs operate independently. When different formats are being displayed, the only data common to both UFCDs is radio channel and frequency information. Both cockpit UFCDs present the results of changes to radio channels or frequencies at the same time, regardless of which cockpit performed the change. The cockpit not performing data entry does not see touch highlights as the data is entered, only the result of the data entry. If both pilot and WSO enter digits on the keypad for the same option, both entries are accepted, with the second entry overwriting the first. When pilot and WSO are on the same data entry or CNI format, asterisks are provided in the top left and right of the scratch pad.

(LOT 26 AND UP) The aft UFCD is electrically controlled through the 8 x 10 display Off/On/Brightness knob when it is installed. The aft UFCD flashes STANDBY when the MC1 communication to the UFCD is disrupted. A standby display pattern in the center of the UFCD display surface, similar to the DDI pattern, indicates degraded image processing from MC1. When the Mono video connection from the 8 x 10 display is lost or degraded, the aft UFCD will not display anything. When video synchronization is lost or degraded, the aft UFCD may display symbology that is not coordinated with the video. If the interface between MC1 and the aft UFCD is lost, the touch screen capability and brightness/contrast control will not work. When MC1 is inoperative, the aft UFCD is not capable of displaying format symbology or analog video.

When the pilot or WSO touch a keypad option on the touch screen a highlight appears indicating that the option has been selected. Figure 2-55 shows an example of a selected option. When a new format is selected on the touchpad, the highlight does not remain on the new format.

Keypad options use a first finger in mechanization. Only one option can be selected at a time. If two or more selections are attempted at one time, none of them are considered valid.

Some formats initialize with data in the scratchpad, e.g., the COMM sublevel of the CNI format initializes with the comm frequency in the scratchpad. When data entry is started, the digits in the scratchpad are blanked, allowing data entry. If a comm frequency is being entered the decimal remains displayed, allowing frequency entry in relation to the decimal point to be viewed.

The UFCD uses a double clear mechanism. The first selection of the CLR keypad option removes the last digit that was entered in the scratchpad. The second selection of the CLR option removes all the digits which have been entered in the scratchpad. If the scratchpad is flashing due to the 10 second timer (no entries in the previous 10 seconds), pressing CLR stops the flashing and performs the previously described CLR function. If the scratchpad is flashing due to an error, pressing CLR stops the flashing and removes all digits from the scratchpad.

WARNING

Uncommanded option selections may occur with a malfunctioning UFCD. This can include uncommanded autopilot selection or deselection. In order to reduce the flight safety risk, a UFCD that self-selects uncommanded options should be secured in flight and only turned on if required for safety-of-flight functions (radio, IFF or navigation selections). The malfunction may or may not be present when turned back on, but can be expected to reoccur during flight if operational. In F/A-18F aircraft, an unaffected UFCD may remain on and in use with no adverse effect. A frozen unresponsive display is the result of another unrelated failure mode that may occur and can be corrected by cycling power to the MPCD/DECD.

NOTE

Securing the UFCD will reset the MPCD/DECD and cause a transitory display loss.

2.19.5.1 UFCD Data Entry. The UFCD has two data entry protocols, Standard Data Entry (SDE) and Fast Data Entry (FDE).

2.19.5.1.1 Standard Data Entry. With MC OFP 18E, SDE digits are entered using the keyboard followed by the enter (ENT) key. In many cases, the option for which the data is being entered must first be selected prior to entering digits. Selection of the ENT option causes the digits in the scratchpad to flash once, confirming that the ENT has been accepted. The majority of the data entry displays use SDE protocol and are recognized by the presence of the ENT key.

2.19.5.1.2 Fast Data Entry. With MC OFP 18E some data, and with MC OFP H1E AND UP all data are entered using the keyboard followed by selecting the option directly. This protocol does not use the enter (ENT) key. With MC OFP 18E, MAN replaces ENT. With MC OFP H1E AND UP, NEWS replaces ENT. See figure 2-54.

2.19.5.1.3 Data Entry Using the Shifted Keypad. The N-E-W-S option is provided on all UFCD data entry displays with MC OFP H1E AND UP. The shifted keypad provides the ability to enter a negative sign, a decimal point, degrees, minutes, and seconds symbols, and North (N), East (E), West (W), and South (S) entries for latitude and longitude entries. With MC OFP H2E+ AND UP, latitude and longitude can be entered to ten thousandths of a minute, or hundredths of a second for increased precision.

2.19.5.2 UFCD CNI Function. The aircraft powers up with all CNI systems off and the top level CNI format as the default UFCD display. See figure 2-55. This format is the central point for controlling all CNI systems. For Communication-Identification Equipment, see Chapter 23. For Navigation Equipment, see Chapter 24.

The following top level options are not related to CNI systems: DDI, EW, and FLR. The DDI option provides the last selected DDI display on the UFCD. The EW and FLR options provide the specified display format on the UFCD.

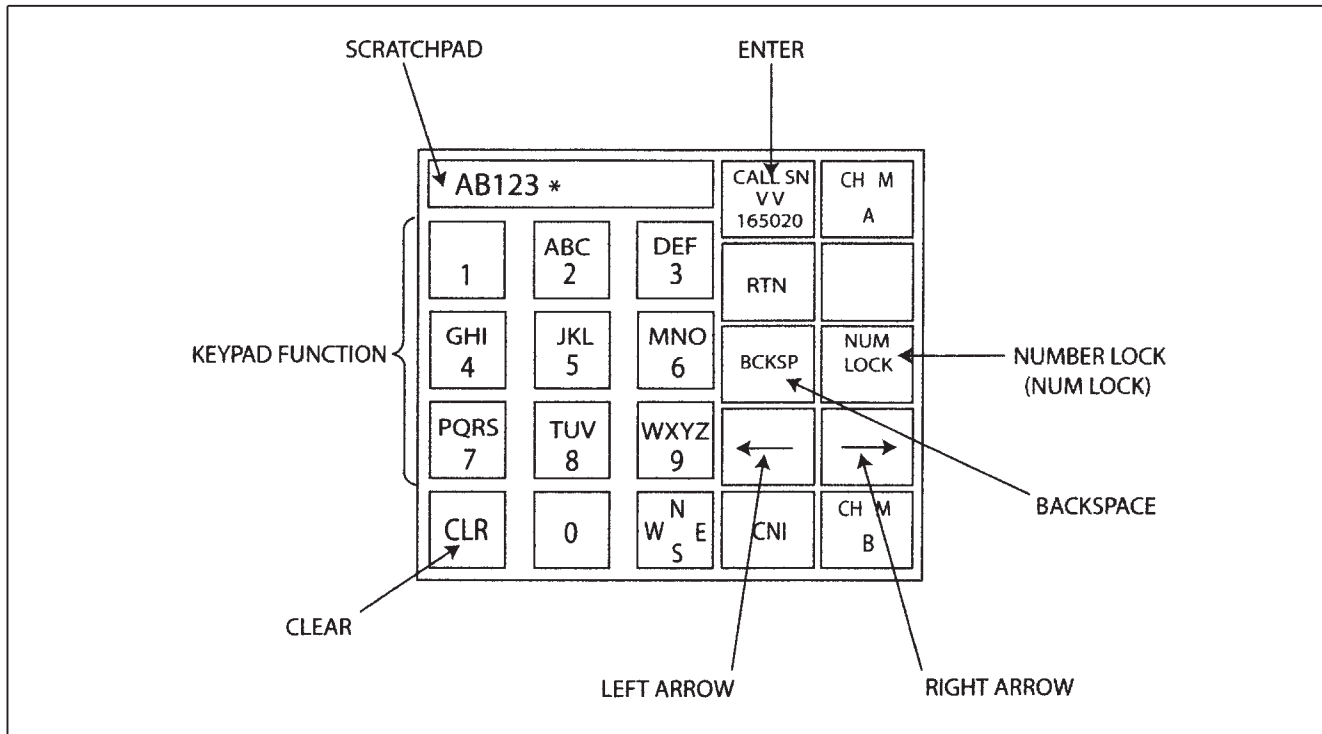

Figure 2-54. Alphanumeric Entry Format

EFN520-422-1-018

The top level CNI display does not use an ENT function, the MAN option is used to turn to a previously entered manual radio frequency.

2.19.5.3 UFCD STANDBY Indication. A flashing STANDBY indication is provided just above the center of the UFCD display surface when there is no valid mux communication between the MC and MPCD. The STANDBY indication is superimposed over any display format. When the STANDBY indication is displayed, power to the MPCD should be cycled to attempt a reset. If the STANDBY condition clears before power can be recycled, the UFCD screen blanks and the previously displayed format reappears.

2.19.5.3.1 Aft UFCD MUX FAIL. When the 8 x 10 display is installed, the aft UFCD generates a MUX FAIL BIT indication when MC1 loses communication with the UFCD. This message occurs only when the 8 x 10 display is turned on and powering the aft UFCD. Using periodic BIT monitoring, the MC1 tries to reset the aft UFCD through the 8 x 10 display communication if an error is detected.

2.19.5.4 RALT - Radar Altimeter Function. The RALT function indicates clearance over land or water from 0 to 5,000 feet. Operation is based on precise measurement of time required for an electromagnetic energy pulse to travel from the aircraft to the ground and return. A warning tone and visual warnings are activated when the aircraft is at or below a selectable primary or secondary low altitude limit. The primary/secondary radar low altitude warnings are reset by setting the low altitude index (primary), or UFCD selected altitude (secondary) to an altitude below the present altitude or by climbing above the previously set limit. The warning tone can be disabled in either cockpit by pressing the flashing RALT option on the UFCD Low Altitude Warnings format or UFCD DDI format, turning off the radar altimeter, setting the warning value below current radar altitude, or by climbing above the warning altitude. When disabled, the tone cannot be triggered until after being reset as described.

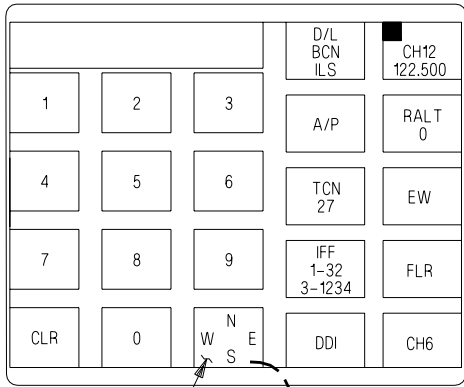

TOP LEVEL CNI FORMAT

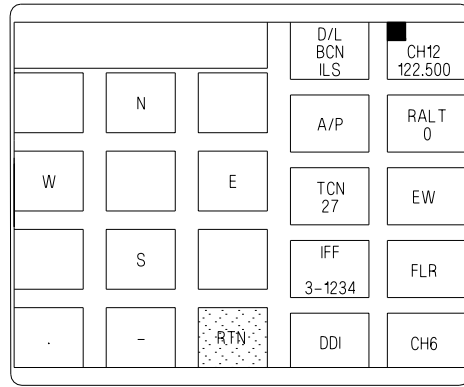

SHIFTED KEYPAD < 1

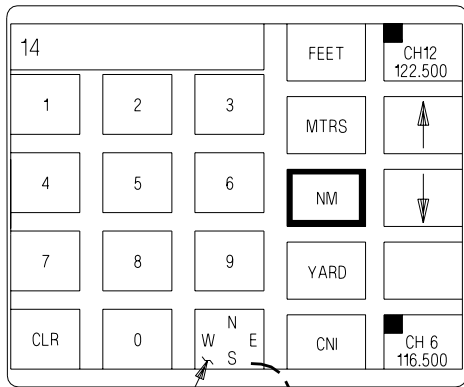

DATA ENTRY FORMAT

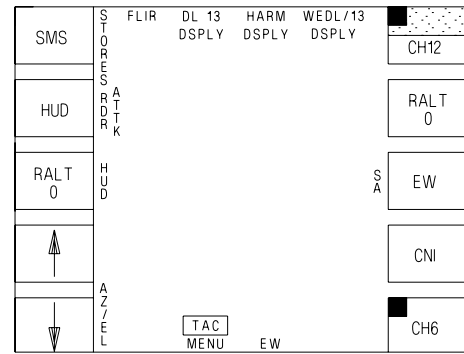

DDI DISPLAY ON UFCD

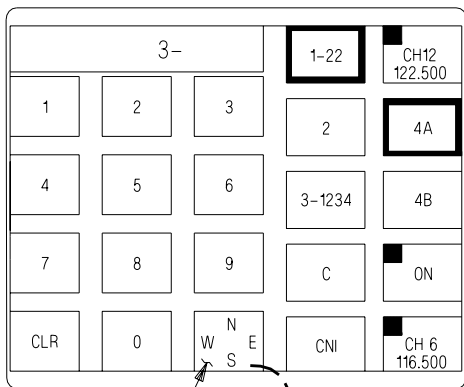

CNI SUBLEVEL

NOTES

- < 1 > MC OFP H1E
- < 2 > MC OFP 18E +
- < 3 > MC OFP 18E + SDE
- < 4 > MC OFP 18E + FDE

Figure 2-55. Up Front Control Display (UFCD)

The radar altimeter consists of a receiver-transmitter and individual transmitting and receiving antennas. The receiver-transmitter produces the energy pulses, transmits the energy to the ground, receives the reflected signal, and processes the data for display as altitude by the head-up display unit (HUD).

Indicators and controls used with the electronic altimeter set are the left or right DDI on the instrument panel (for BIT checks), the ALT switch, UFCD (for secondary low altitude warning), and the head-up display. Radar altimeter BIT is initiated from the BIT display.

Pressing the emission control (EMCON) switch on the UFCD inhibits operation of the radar altimeter. EMCON is toggled on or off each time the EMCON switch is pressed. When EMCON is on the letters E, M, C, O, N are displayed either in the left side option boxes (DDI display) or in the scratchpad of the top level CNI display and on the HUD.

2.19.5.4.1 Low Altitude Warning Tone. When the aircraft descends below the primary low altitude set in the UFCD, a “Whoop, Whoop” warning tone is heard in the aircrew’s headset and the word ALTITUDE is displayed on the HUD. The warning tone, when initiated by the primary radar low altitude warning, is repeated at the lowest priority until reset or disabled.

WARNING

Numbers ending in zero are valid entries for both the Low Altitude Warning and COMM 1. Due to the close proximity of the COMM 1 and RALT options, it is possible to inadvertently change the low altitude warning setting for the radar altimeter when attempting to use COMM 1 fast data entry.

A barometric low altitude and secondary radar low altitude warning function are enabled by entering the appropriate altitude, up to a maximum of 25,000 (BARO) and 5,000 (RADAR), on the UFCD. The barometric low altitude and secondary radar low altitude warning provide a single voice alert warning “ALTITUDE, ALTITUDE” when the aircraft descends through the selected altitude. Refer to Part VII for information on entering altitude. The barometric low altitude warning function does not affect the operation of the radar altimeter low altitude warning function.

2.19.5.5 UFCD Controls. A description of UFCD switches follows. Refer to Part VII for operating instructions for CNI equipment.

2.19.5.5.1 COMM 1 and 2 Channel Knobs. The COMM 1 and 2 channel knobs permit independent selection of up to 20 preset channels on radios 1 and 2. Guard (G), Manual (M), Ship Maritime (S), and SINCGARS Cue (C) channels are also available on the continuously rotatable knobs.

2.19.5.5.2 COMM VOL Knobs. The VOL knobs independently control radio volume for COMM 1 and 2. The OFF position (detent) is at the full counterclockwise position. In the F/A-18F, both sets of knobs must be in the OFF position for power to be removed from the radios. When a radio is powered, the respective COMM option is corner highlighted. When a radio is actively receiving, a half intensity highlight is shown on the upper half of the COMM option (figure 2-55).

2.19.5.5.3 ID (IDENT) Pushbutton. The ID pushbutton commands an IFF identification/position squawk (IDENT), for modes 1, 2, and 3 (if enabled).

2.19.5.5.4 UFCD BRT Knob. The BRT knob adjusts the overall brightness of the UFCD display, both symbology and video. Turning the knob counterclockwise to the OFF position removes power from the UFCD.

2.19.5.5.5 UFCD CONT Knob. The CONT knob adjusts video contrast on the UFCD.

2.19.5.5.6 UFCD SYM Knob. The SYM knob is used to adjust the brightness of the UFCD symbology without affecting the brightness of the UFCD video.

2.19.5.5.7 EMCON Pushbutton. If the UFCD is displaying a DDI format the letters E M C O N are displayed in the left side option boxes. If the UFCD is displaying the top level CNI format, EMCON is displayed in the scratch pad.

2.19.6 SDC - Signal Data Computer. The signal data computer (SDC) operates under mission computer control and records aircraft fatigue strain data, engine parameters when out of tolerance conditions occur, fuel information, and aircraft and target parameters when targets are designated and weapons are delivered. It includes fuel transfer controls and gaging capabilities, incorporates ground support equipment fuel transfer and gaging fault isolation functions, and provides interface for multiple sensors and controls. It provides analog-to-digital conversion of aircraft parameters. In addition, BIT fail indications are stored in the SDC to be displayed by the maintenance status panel (MSP) for readout by maintenance personnel after the flight, or on the EFD for readout during the flight.

The RESET SDC option is available from the SUPT MENU/FUEL format. This option is used to reset the SDC by momentarily removing power. When selected, the RESET portion of the option legend is boxed, and remains boxed until the SDC reestablishes AVMUX communication or 15 seconds after the option was selected. The RESET SDC option is removed from the FUEL format if the CSC is not communicating on the AVMUX.

With AMCD aircraft, the SDC is used to compensate for periods of blank cockpit displays and interrupted avionics multiplex (AVMUX) bus communication occurring when both advanced MCs are off-line or in initialization. The SDC will take temporary control of AVMUX busses 1 and 6 during the ground start and inflight conditions. While acting as the backup bus controller, the SDC transmits to the forward MPCD and forward UFCD a limited HUD display of essential flight information. Refer to chapter 25. Additional data transfers to the left and right Full Authority Digital Engine Controllers (FADECs) and the Environmental Control System (ECS) Controller sustains standard operation. The SDC also enables display of the Left and Right Air Turbine Starter (L ATS and R ATS) cautions.

2.19.7 CVRS - Cockpit Video Recording System. LOTs 21–24 CVRS contains two video tape recorders, a HUD camera, and two over the shoulder cameras. The system has the capability to record either front DDI, the MPCD, the HMD, the aft MPCD, the aft UFCD, or the HUD (in color), but in limited combinations. Headset audio is also recorded as long as the KY–58 encryption function is inactive. The switches used to operate CVRS are located on the VIDEO RECORD panel in each cockpit.

The CVRS in LOT 25 is identical to that for LOTS 21–24 with the exception of the two over-the-shoulder cameras which are removed and the DDIs are recorded using direct video outputs.

In LOTs 26 and up without the solid state recorder, the CVRS consists of two video tape recorders and a HUD camera. No over the shoulder cameras are installed. The system has the capability to direct record various combinations of either front DDI, aft DDI, MPCD, aft MPCD or 8 x 10 display, the

HMD, and the HUD in color. Headset audio is also recorded as long as the KY-58 encryption function is inactive. The switches to operate the CVRS are located on the VIDEO RECORD panel in each cockpit.

With AMCD aircraft with solid state recorder (SSR) installed (after AFC 443), the CVRS consists of one SSR with removable memory module (RMM). The system has the same record options and cockpit interface as the 8 mm CVRS.

2.19.7.1 CVRS Video Tape Recorders/Solid State Recorder (SSR). The two CVRS video tape recorders (VTRs) are located behind the ejection seat in the F/A-18E and behind the rear cockpit ejection seat in the F/A-18F. Each VTR provides a minimum of 2 hours recording time on removable 8 mm video tape cartridges.

The SSR is located in the avionics bay behind the ejection seat in the F/A-18E and behind the rear cockpit ejection seat in the F/A-18F. VTR1 and VTR2 record options are the same as CVRS. The SSR provides a minimum of 3 hours recording time on a removable memory module (RMM).

2.19.7.1.1 SECURE ERASE Button. The SECURE ERASE button is guarded and located on the right hand forward vertical console. Pressing the SECURE ERASE button erases the information stored in the RMM.

2.19.7.1.2 SSR Advisories. The following SSR related advisories are described in the Warning/Caution/Advisory Displays in part V: RMMCD, RMMFL.

2.19.7.2 HUD Camera. The HUD camera, positioned immediately in front of the HUD, records a color image similar to what the pilot sees through the HUD, e.g., symbology superimposed on a picture of the outside world. This combined image is made available for recording.

2.19.7.2.1 HUD Event Marker. The HUD event marker is a small black marker generated by the HUD camera and positioned in the upper left corner of the video signal sent to the VTR for recording. The event marker is displayed when the weapon release pickle button is pressed or the trigger is squeezed to the second detent and remains displayed until pickle button/trigger release. When reviewing CVRS video post-flight, the event marker is a useful training aid, used to determine the timing and duration of pickle button and trigger actuations (e.g., shot validation).

2.19.7.2.2 HUD Camera BIT Button. The BIT button, located on the front face of the HUD assembly, is used to initiate a BIT of the HUD camera. The GO and NO GO BIT status balls, normally black, are used to determine the BIT status of the HUD camera. When the BIT button is pressed, BIT status is indicated by a green GO ball or an orange NO GO ball.

2.19.7.3 Over the Shoulder Cameras (LOTs 21-24). Two over the shoulder cameras, one mounted on each side of the canopy frame approximately 30 inches from the instrument panel, are oriented to record a picture of the L and RDDIs. The image from each camera is made available to a VTR for recording.

2.19.7.3.1 Over the Shoulder Camera BIT Buttons (LOTs 21-24). Each camera contains a BIT button located on its front face. Press and hold of the BIT button initiates a BIT of that camera. BIT status is indicated by a green LED (go) or a red LED (fail).

2.19.7.4 CVRS Control Switches. The switches used to operate CVRS are located on the VIDEO RECORD panel on the lower left instrument panel in the forward cockpit, and the aft cockpit for LOTs

21–25 aircraft. (See figures 2-56 thru 2-64) They are located below the center display in the aft cockpit of LOT 26 AND UP aircraft. The aft cockpit switches override the front cockpit switches for any selection on LOT 26 AND UP aircraft. The VTR 1 and VTR 2 sources are grouped to nominally allow front cockpit recording on VTR 2 (includes HUD) and allow aft cockpit recording on VTR 1 (includes 8 x 10 display).

2.19.7.4.1 CVRS Mode Switch. The CVRS mode switch is used to select manual or automatic video recording.

- MAN CVRS records continuously (according to the inputs selected by the two VTR selector switches).
- OFF CVRS recording off.
- AUTO CVRS records automatically only when in the A/A or A/G master modes (according to the inputs selected by the two VTR selector switches).

NOTE

The MODE switch must be in the OFF position to remove power from the VTRs. Failure to place the MODE switch in the proper position prior loss of aircraft power will keep the 8mm tapes from dethreading and prevent the removal of the tapes from the VTRs until aircraft power is reapplied.

2.19.7.4.2 CVRS RDCR ON Light. The green RDCR ON light, located on the left warning/caution/advisory lights panel on the upper left instrument panel, comes on when CVRS power is on. An illuminated light does not mean that the VTR or SSR is recording.

2.19.7.4.3 VTR Selector Switches. The VTR selector switches are used to select the video input source for recording on the two VTRs.

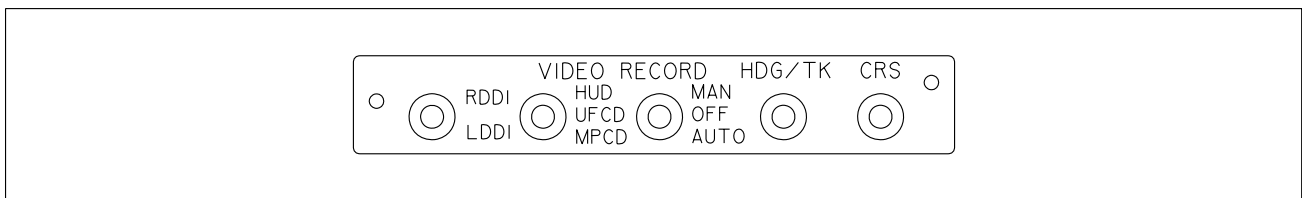

Figure 2-56. Forward CVRS Control Panel (LOTs 21-22)

EFN520-415-1-018

Forward CVRS (LOTs 21-22)

- RDDI Selects right over-the-shoulder camera video.
- LDDI Selects left over-the-shoulder camera video.
- HUD Selects HUD video camera.
- UFC D Selects aft UFC D direct video.
- MPC D Selects MPC D direct video.

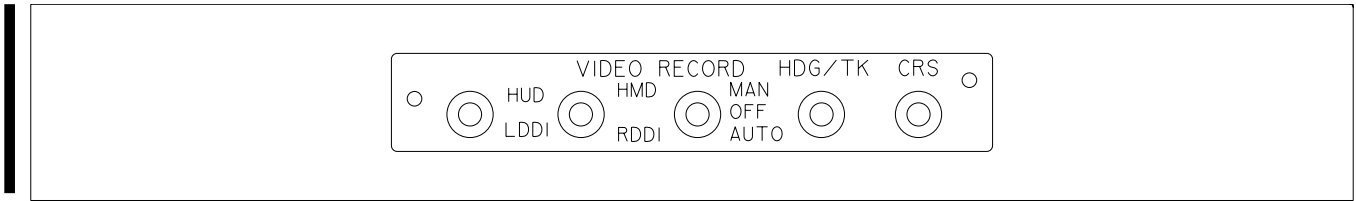

Figure 2-57. Forward CVRS Control Panel (LOTs 23-25 Before AFC 445)

EFN520-415-2-011

Forward CVRS (LOTs 23-25 Before AFC 445):

- HUD Selects HUD video camera.
- LDDI Selects left over-the-shoulder camera video.
- HMD Selects HMD camera video.
- RDDI Selects right over-the-shoulder camera video .

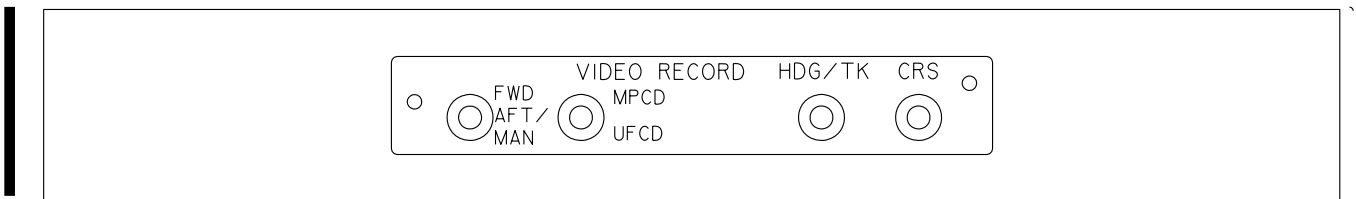

Figure 2-58. Aft CVRS Control Panel (LOTs 21-22) and LOTs 23-25 Before AFC 445.

EFN520-415-3-018

Aft CVRS (LOTs 21-22 and LOTs 23-25 Before AFC 445):

- FWD Selects front cockpit video. Default start-up position.
- AFT/ MAN Selects rear cockpit video. Turns CVRS on if system is off. Electrically held in this position.
- MPCD Selects aft MPCD direct video.
- UFCD Selects aft UFCD direct video.

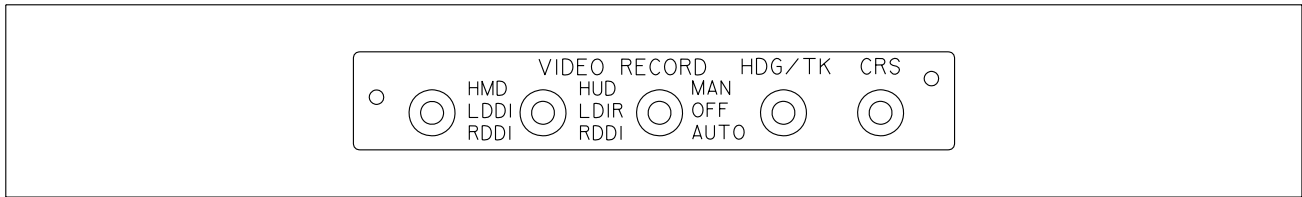

Figure 2-59. Forward CVRS Control Panel (LOTS 23-24 After AFC 445)

EFN520-415-6-018

Forward CVRS (LOTS 23-24 After AFC 445)

- HMD Selects HMD video camera.
- LDDI Selects left over-the-shoulder camera video.
- RDDI Selects right over-the-shoulder camera video.
- HUD Selects HUD video camera.
- LDIR Selects LDDI direct video.
- RDDI Selects right over-the-shoulder camera video.

NOTE

When both VTR 1 and VTR 2 have RDDI selected, the actual recording occurs on VTR 2 only.

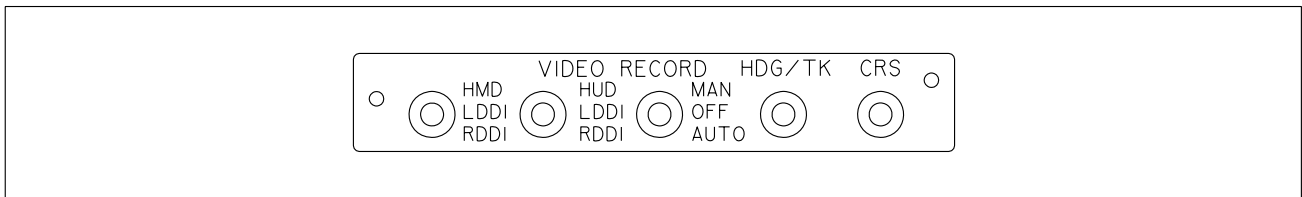

Figure 2-60. Forward CVRS Control Panel (LOT 25 After AFC 445)

EFN520-415-7-018

Forward CVRS (LOT 25 After AFC 445):

- HMD Selects HMD video camera.
- LDDI Selects LDDI direct video.
- RDDI Selects RDDI direct video.
- HUD Selects HUD video camera.
- LDDI Selects LDDI direct video.
- RDDI Selects RDDI direct video.

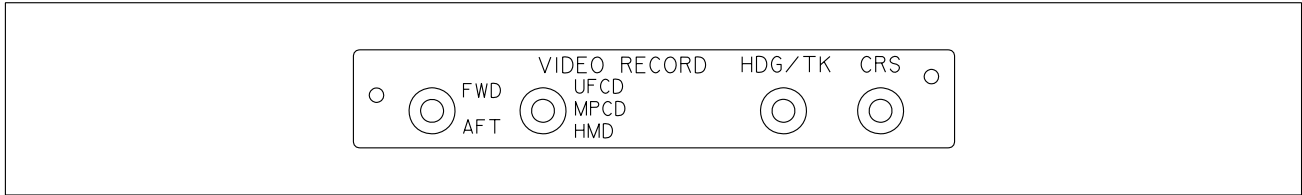

Figure 2-61. Aft CVRS Control Panel (LOT 23-25 After AFC 445)

EFN520-415-8-018

Aft CVRS Control Panel (LOT 23-25 AFTER AFC 445):

- FWD Selects front cockpit video. Default start-up position.
- AFT Selects rear cockpit video.
Electrically held in this position.
- UFCD Selects aft UFCD direct video.
- MPCD Selects aft MPCD direct video.
- HMD Selects HMD video camera.

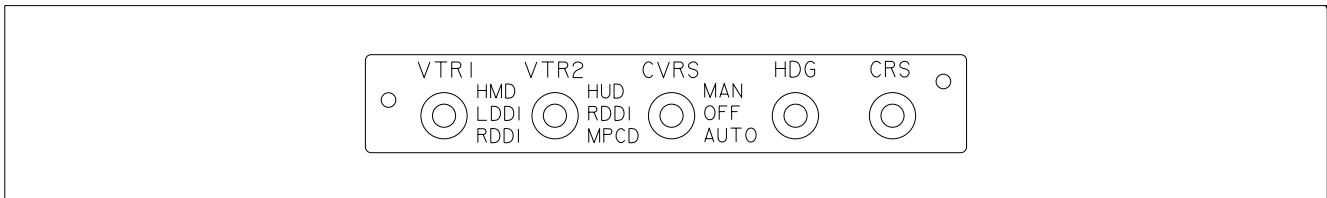

Figure 2-62. Fwd CVRS Control Panel (LOT 26 AND UP)

EFN520-415-4-011

Forward CVRS Control Panel (LOT 26 AND UP):

- HMD Selects HMD video camera.
- LDDI Selects LDDI direct video.
- RDDI Selects RDDI direct video.
- HUD Selects HUD video camera.
- RDDI Selects RDDI direct video.
- MPCD Selects MPCD direct video.

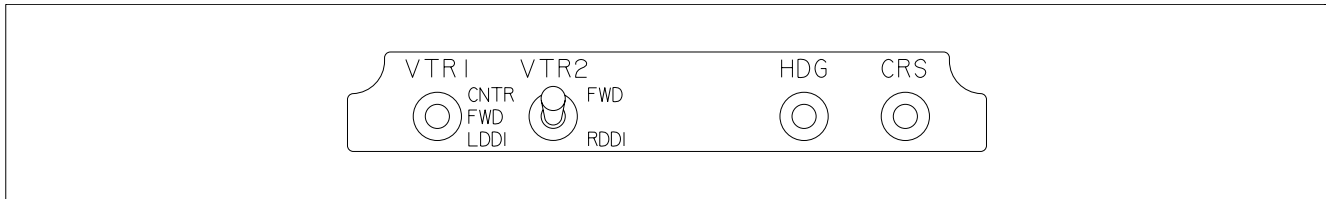

Figure 2-63. Aft CVRS Control Panel (LOTs 26-29 Before AFC 445)

EFN520-415-5-011

Aft CVRS Control Panel (LOTs 26-29 Before AFC 445):

- CNTR Selects center display direct video. Electrically held in this position.
- FWD Selects front cockpit video. Default start-up position.
- LDDI Selects LDDI direct video. Electrically held in this position.
- FWD Selects front cockpit video. Default start-up position.
- RDDI Selects RDDI direct video. Electrically held in this position.

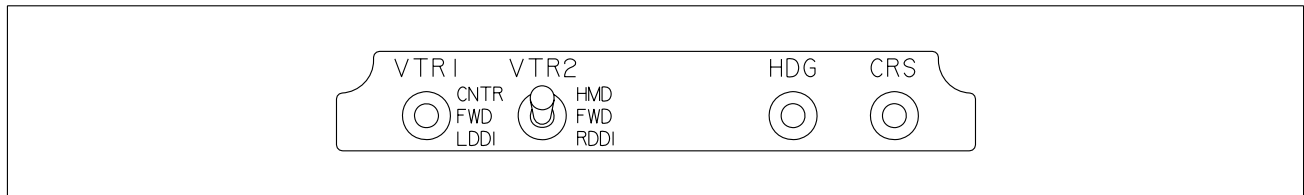

Figure 2-64. Aft CVRS Control Panel (LOTs 26-29 After AFC 445 AND LOT 30 AND UP)

EFN520-415-9-018

Aft CVRS Control Panel (LOTs 26-29 After AFC 445 AND LOT 30 AND UP):

- CNTR Selects center display direct video. Electrically held in this position.
- FWD Selects front cockpit video. Default start-up position.
- LDDI Selects LDDI direct video. Electrically held in this position.
- HMD Selects HMD video camera.
- FWD Selects front cockpit video. Default start-up position.
- RDDI Selects RDDI direct video. Electrically held in this position.

NOTE

In LOT 26 AND UP F-model aircraft both aft VTR switches must be in the FWD position AND the forward MODE switch must be in the OFF position to remove power from the VTRs. Failure to place all 3 switches in the proper position prior loss of aircraft power will keep the 8mm tapes from dethreading and prevent the removal of the tapes from the VTRs until aircraft power is reapplied.

2.19.7.5 VTR2 Override Function. CVRS incorporates a VTR2 override function designed to make sure that HUD camera video is recorded when an A/G weapon is released, the gun is fired, or an A/A missile is launched. In A/A or A/G master modes, when the pickle button is pressed or the trigger is squeezed to the second detent, VTR2 automatically switches from the selected VTR2 source to the HUD camera. VTR2 records HUD video from pickle button/trigger actuation to pickle button/trigger release plus a set overrun time before reverting to the video source selected by the VTR2 selector switch. Overrun times are 5 seconds for AIM-9 launch and gun firing and 10 seconds for AIM-7/ AIM-120 launch and A/G weapon release. In the A/G master mode, if FLIR video is displayed on a DDI, the UFCD, or the MPCD, VTR2 does not switch to record HUD camera video.

2.19.8 Fast Tactical Imaging Set (FTI-II). The FTI-II (AN/AVX-4) provides the F/A-18F (LOT 24 AFTER AFC 395) with near real-time capability to capture, view, send, and receive cockpit display information as still-frame images in either air-to-air or air-to-ground mode. FTI-II captures any of 5 single-source video inputs from one of the following displays: aft LDDI, aft RDDI, HUD, aft MPCD, and forward HMD. The system sends parallel video to the forward and aft DDIs for image viewing when the monochrome map is selected for display. An additional output signal is sent to VTR1 for recording. Transmitted and received imagery is encrypted using the KY-58 secure speech system and the ARC-210 radio.

2.19.8.1 FTI-II Major Components.

2.19.8.1.1 Remote Switching Control (RSC). The RSC is installed on the aft cockpit left hand console aft of the volume control panel. The RSC has two lines of 24 characters each and six buttons, and is used for programming the FTI-II and executing commands.

2.19.8.1.2 Digital Imaging Processor (DIP). The DIP is installed in the forward cockpit, right hand console just aft of the KY-58 control panel. The DIP has a removable compact flash card that stores full resolution images. The DIP contains a CPU, communications protocol, LPEG software, wavelet software, operating system software, frame grabber function, and a Merlin card for auto detection and down-scale conversion.

2.20 TACTICAL AIRCRAFT MOVING MAP CAPABILITY (TAMMAC)

The TAMMAC avionics subsystem provides a moving map capability to enhance operational effectiveness and survivability and addresses supportability/obsolescence issues facing existing moving map and data storage systems currently deployed.

TAMMAC effectively replaces 3 separate Weapons Replaceable Assemblies (WRAs), including the AN/ASQ-196 DVMS which consists of two WRAs; the Digital Map Computer (DMC) and the Digital Memory Unit (DMU), and the AN/ASQ-194 DSS which is a single WRA.

(LOT 26 AND UP) Independent maps and related formats are available in both cockpits with Digital Video Map Computer (DVMC) installed, allowing independent map functionality and video routing. The DVMC provides 5 outputs through two channels to various aircraft displays; however, each map channel output is not available on every display. DVMC Channel 1 (using MC1) has two analog video outputs. One output is viewable on the front LDDI, MPCD and rear LDDI. The other channel 1 output is used for the aft UFCF. DVMC Channel 2 (using MC2) has two analog video outputs and one digital color fiber optic output. One of the analog outputs is viewable on the front and rear RDDIs, and 8 x 10 display. The other analog output is used for Wrap-Around-Test (WAT) and removes video capability from the front UFCF. Channel 2 digital (fiber optic) is only available on the 8 x 10 display. When the Channel 2 digital output is in use on the 8 x 10 display, the analog outputs are disabled. The DVMC only produces digital or analog on Channel 2 at any time, not both simultaneously.

The 8 x 10 display processes analog video (via MC1 or MC2) or digital video, via Fiber Channel Network Switch (FCNS) 2 along with the symbology received from MC2 to create a composite format display image. FLIR mono video and map mono video (Wrap-Around-Test only) are the only analog videos routed to the 8 x 10 display. The aft UFCF video displays are routed through the 8 x 10 display for processing, and include sensor, weapon, and TAMMAC DVMC. Digital color map video on the 8 x 10 display is routed from the TAMMAC DVMC via the High Speed Video Network (HSVN) and FCNS2. If FCNS2 fails, no digital color video is available on the 8 x 10 display. Map video routing is shown in figure 2-65.

The TAMMAC subsystem consists of a new MU-1119/A Advanced Memory Unit (AMU), a new CP-2414/A digital map computer and a High Speed Interface Bus (HSIB) which connects the two. The DMC is a functional replacement for the existing DVMS. Data Transfer Devices (DTDs) used in conjunction with TAMMAC for transferring data to and from ground-based stations are Personal Computer Memory Card International Association (PCMCIA) cards or PC cards. Ground-based stations that process data for TAMMAC include the Joint Mission Planning System (JMPS) and the Automated Maintenance Environment (AME). Theater data is installed on the map loading card using JMPS.

The AMU is a functional replacement for the existing DSS, more commonly referred to as the Memory Unit (MU). The AMU contains two PC card receptacles, one for maintenance (ground support) operations and one for mission (pilot) operations. This unique configuration allows maintenance and mission data to be separated both pre- and post-flight which reduces logistics coordination and facilitates operational readiness. Three types of PC cards are used in the TAMMAC subsystem operation: 1) Mission Card, 2) Maintenance Card, and 3) Map Loading Card.

2.20.1 TAMMAC Status Monitoring. TAMMAC status monitoring functions are based on the existing MU and DVMS status monitoring functionality. Some of the existing cautions, advisories, BIT mechanizations, and MSP codes that satisfied the requirements for the MU and DVMS were not changed. However, additional status monitoring functionality was added to accommodate changes to

the MC/AMU/DMC interfaces including, but not limited to, the PC cards and the High Speed Interface Bus (HSIB).

All existing display references to the MU and DMC are unchanged. The TAMMAC AMU functionality discussed here equates to the MU nomenclature on all existing displays. The TAMMAC DMC equates to the DMC on all existing displays. The only operator change to the status monitoring BIT displays is the addition of the AMU MAINT option.

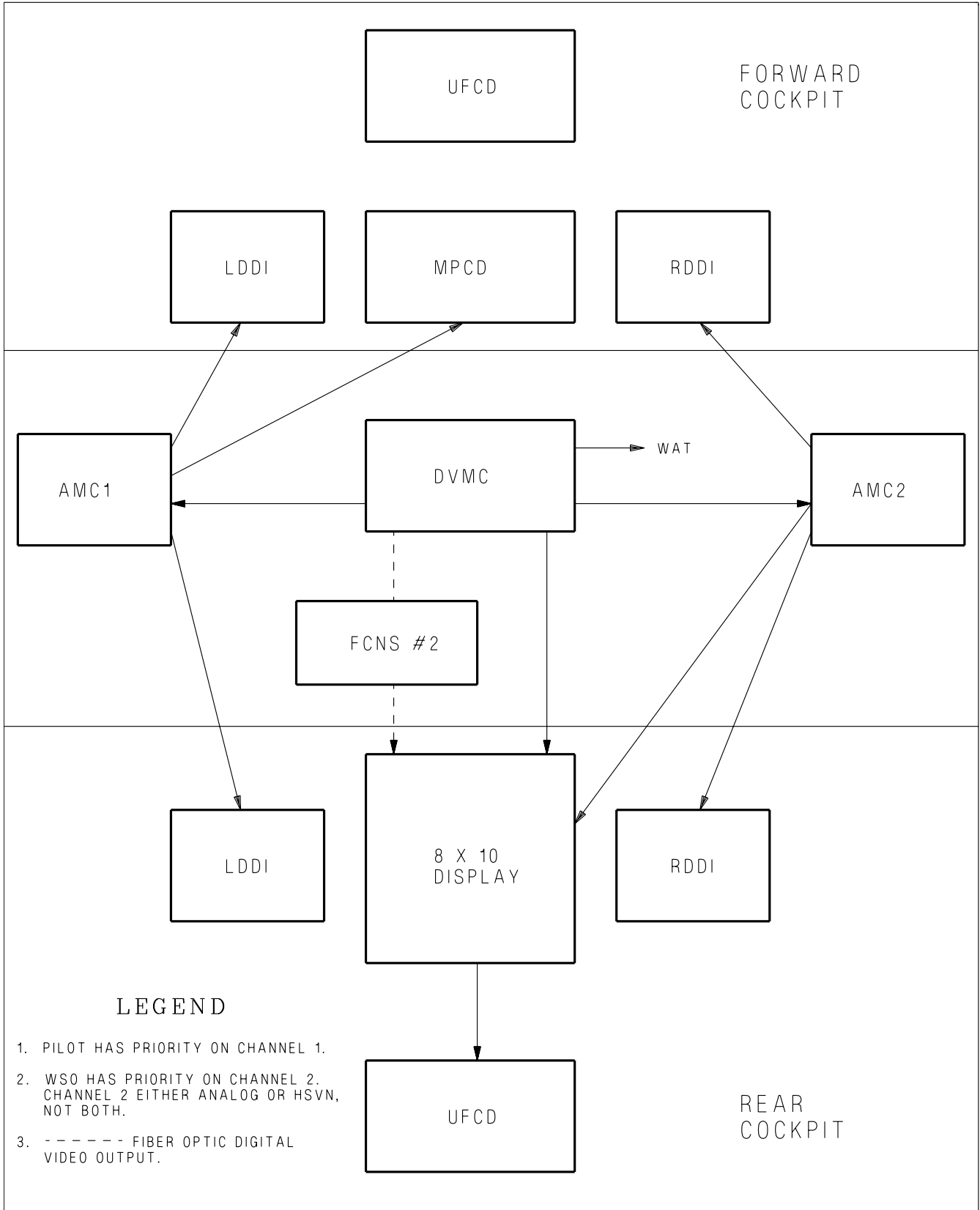
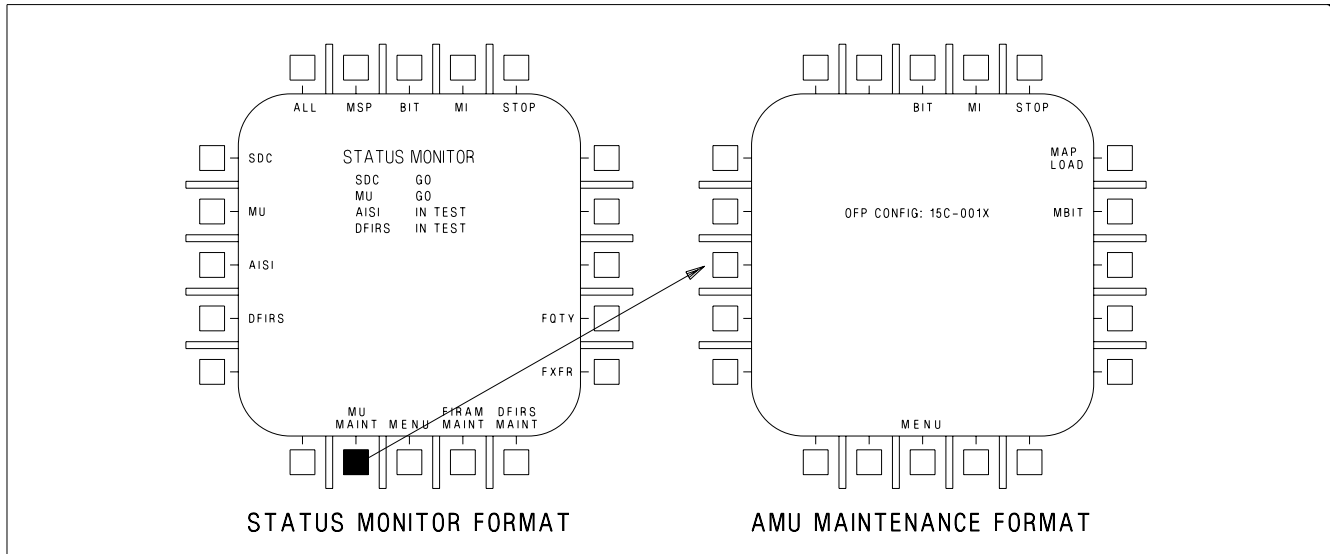

Figure 2-65. Video Display Routing

EFN520-418-1-013



EFN520-362-1-003

Figure 2-66. AMU Maintenance Format

The MC verifies the AMU and DMC software configuration IDs are compatible with the MC software.

2.20.2 AMU Maintenance Format Options and Display Information. The AMU maintenance format contains two relay mode options, MAP LOAD and MBIT. MAP LOAD provides access to sublevel formats used to upload map theater data to the DMC. MBIT is used for troubleshooting and fault isolation.

Information displayed on the AMU maintenance format is limited to the MU OFP configuration ID. The OFP CONFIG identifies the OFP version currently installed in the AMU. See figure 2-66.

2.20.3 Map Theater Data Loading. Map theater data loading can include either updates to an existing theater load or a new theater load. In both cases, the map loading cards are processed on JMPS and loaded in the DMC nonvolatile mass memory using the same procedure. The number of map loading cards is contingent on the size of the update or new theater load. The number of map loading cards can be as few as one or as many as seven.

Map theater data loading is controlled by the map loading format. The map loading format is accessed by selecting the MAP LOAD option (PB 11) on the AMU maintenance format as shown in figure 2-67. The map loading format contains 3 relay mode options; LOAD, ABORT, and RTN.

2.20.4 Map Loading Format Options. The LOAD option (PB 11) is used to initiate a theater load when a map loading card is installed in the AMU maintenance card receptacle and the AMU door is closed. Once the process is initiated, the LOAD option is removed from the format. Multiple card theater loads/updates require the insertion of another map card when prompted by the DDI display. Installing another map loading card and closing the AMU door continues the theater loading process. This procedure is repeated until all theater data is loaded. Map loading cards can be loaded in any sequence.

The ABORT option (PB 13) is used to abort a theater load in progress. It is removed from the display prior to and after completion of a load. To initiate an abort, the operator presses PB 13 which changes the option to ABORT ENABLE. Selection of ABORT ENABLE executes the abort process.

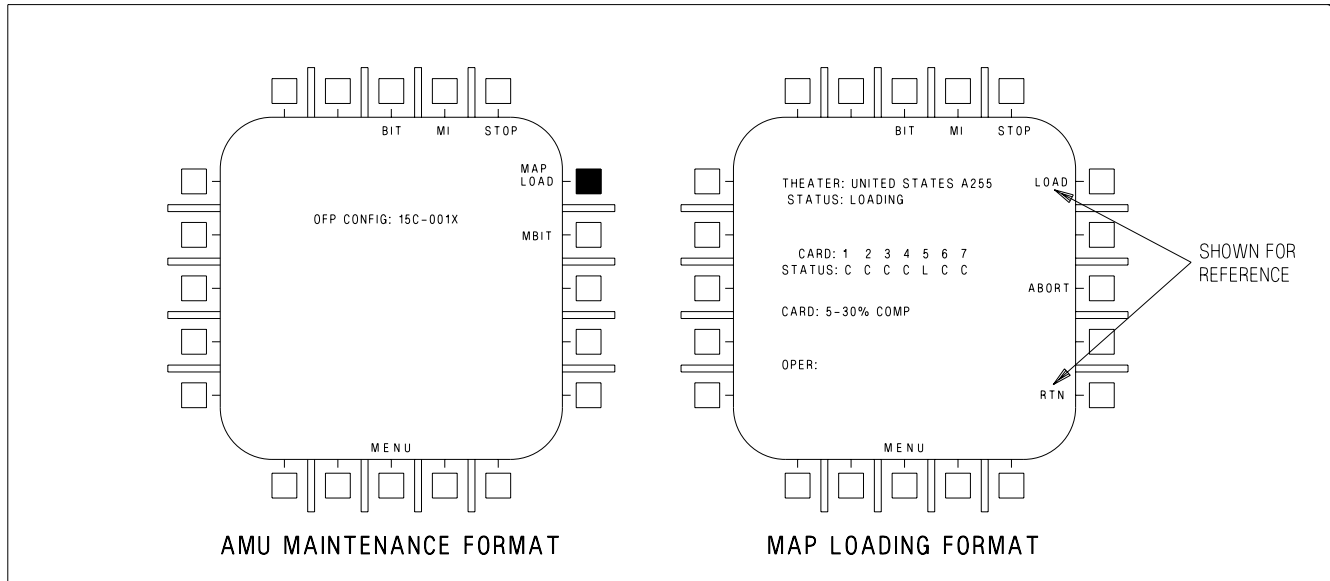

EFN520-363-1-003

Figure 2-67. Map Loading Format

The ABORT ENABLE legend is displayed for 3 seconds following selection of the ABORT option. If the operator does not select the ABORT ENABLE option within three seconds, the ABORT legend is redisplayed. The intent of this two-step abort process is to preclude any inadvertent operator initiated aborts from being performed. This abort process is permanent and the entire load process will be terminated.

Aborting a theater map load causes the aborted theater to be deleted. No maps in CHRT, DTED, or CIB will be available if a theater load is aborted. Previous theater maps are automatically deleted upon loading a new theater.

The RTN option (PB 15) is used to return the AMU maintenance format if a theater load is not in progress. If a theater load is in progress, the RTN option is removed from the display.

2.20.5 Map Loading Format Status Information. Status information displayed on the map loading format provides the operator with on-line instructions and associated feedback necessary to perform a successful theater load. The information presented is grouped into several status fields; THEATER, STATUS, CARD/STATUS, CARD, and OPER.

The THEATER status field contains; theater identification, theater update revision letter, and the theater update version number that is stored on the map loading card currently being loaded. If at least one card is not installed in the AMU (to initiate the load), the field is blank. After a map loading card is loaded the theater identification information remains displayed as other cards are loaded.

The status field below the THEATER status field contains the overall status of the loading process. This field contains one of the following status indications:

HALTED - Indicates the load process has been halted (between successive cards).

LOADING - Indicates the load process has been initiated and/or is in progress.

ABORTED - Indicates the load process has been aborted.

NO DMS COMM - Indicates HSIB communications with the DMC have failed.

DMS FULL - Indicates the DMC nonvolatile mass memory is full.

LOAD ERROR - Indicates the load process has failed.

WRONG CARD - Indicates the card installed in the AMU maintenance card receptacle is not a Map loading card.

COMPLETE - Indicates the load process has successfully been completed.

CARD/STATUS fields contain status information regarding the PC cards used in the loading process. The CARD field indicates the card ID number(s) in the theater load card set. The maximum number of card IDs that can be displayed is seven. The card ID number(s) displayed is dependent on which order the cards are loaded. The STATUS field below the CARD field contains the actual load status of the card number directly above it. Once the card is installed and the load process initiated, the field contains one of the following status indications:

L - Indicates the card is currently being loaded.

F - Indicates the card has failed to load properly.

C - Indicates the card has been successfully loaded.

If none of the above conditions exists, the STATUS field will be blank. If any card fails to load properly resulting in an "F" status, the operator has the option of reinserting the card in an attempt to obtain a successful load.

The CARD field contains the load status of the card that is currently installed. The card ID number will be displayed followed by the percent complete (%) for the card. The percentage will be displayed in 1 % increments.

The OPER field contains instructions for the operator. The field contains one of the following instructional status indications. If any card has yet to be installed for loading, the OPER field will be blank.

INIT LOAD - Indicates the AMU is ready to start the load process and the LOAD option needs to be selected.

CLOSE DOOR - Indicates the AMU door needs to be closed.

REMOVE CARD - Indicates the installed card has been successfully loaded and needs to be removed.

INSERT CARD - Indicates another card is required to complete the load process.

2.20.6 Map Loading Interruptions. Interruptions to the map theater data loading process can occur as a result of several events: loss of power to the MC, DMC, or AMU, operator aborts, or inadvertent transfers out of AMU relay mode.

If the AMU experiences a power loss greater than 5 seconds, or if the DMC experiences a power loss of any duration, or if the operator initiates an abort, the interruption in the loading process results in a nonrecoverable abort and the load process cannot be recovered without reloading all the cards.

If power is reapplied to the AMU within 5 seconds, then the load process can be recovered with minimum impacts. Once the operator reselects the map loading format, the status of the load prior to the interruption is reflected on the format status fields. If a card was in the process of being loaded when the interruption occurred, its status is blank indicating it has not been loaded. Selecting the LOAD option reinitializes the load process following this type of interruption.

2.20.7 AMU/PC Cards Cautions and Advisories. The AMU has the ability to trigger 3 caution and 5 advisory messages. The caution messages are: MU LOAD, ERASE FAIL, and S/W CONFIG. The advisory messages are: Maintenance Card Advisory (MNTCD), Mission Card Advisory (MSNCD), Classified Data Advisory (CDATA), AMU Full advisory (AMU FL), and the BIT advisory.

The MU LOAD caution is generated when the AMU door is open; if the AMU fails; if the AMU declares a card interface fail; if the AMU is mux fail or not ready; if the mission card is improperly formatted, not installed, or is declared failed by the AMU, if the initialization data is not downloaded, if an incorrect checksum is calculated. The MU LOAD caution is disabled while the AMU is in relay mode or the aircraft is in flight.

The ERASE FAIL caution is generated when the AMU has failed to erase its internal RAM memory buffer following a classified data transfer.

The S/W CONFIG caution is generated if the AMU and MC software are not compatible. When an AMU OFP checksum failure occurs, the AMU OFP software configuration ID displayed on the S/W configuration BIT sublevel format indicates XXXXXXXX.

The MNTCD advisory is generated when the AMU door is open, if the maintenance card is not installed or properly formatted, or if the AMU declares a maintenance card failure. The advisory only displays with WonW and clears in flight.

The MSNCD advisory is generated when the AMU door is open, or if there is an AMU/PC card interface fail, or if a down load of data is incorrect, or there is a checksum failure with the data downloaded, or if the mission card is not installed, or if the mission card is not properly formatted, or if there is a mission card failure. The advisory only displays with WonW and clears in flight.

The BIT advisory is generated when the AMU is degraded or an AMU RAM classified erase failure occurs.

The CDATA advisory is generated when the mission card contains classified data. It is removed when a successful classified data erase of all avionics has been performed, or a successful classified data erase of all avionics except the mission card is performed and the ERASE (MU HOLD) option has been selected on the MUMI format.

The MU FL advisory used for the existing MU is changed for the AMU. The MU FL advisory indicates a data wraparound has occurred on the maintenance card and the corresponding MSP code (809) is set. When the MC determines there is not enough memory on the maintenance card to perform the next sequential write operation, it begins overwriting previously recorded data.

DFIRS data download requests do not cause a data wraparound to occur. If there is insufficient memory available, based on the current sequential write address pointer, the DFIRS data download request is not executed.

2.21 COUNTERMEASURES DISPENSING SYSTEM

2.21.1 ALE-47 Countermeasures Dispensing Set. The ALE-47 countermeasures dispensing set can be manually actuated or can use information from various Electronic Warfare (EW) systems to generate countermeasures dispensing programs. Refer to A1-F18EA-TAC series for details on ALE-47 operation and displays.

2.21.1.1 DISPENSER Switch. The DISPENSER switch, located on the center pedestal, is used to control power to the ALE-47 system and to enable the BYPASS dispensing mode.

BYPASS	Selects the BYPASS mode for ALE-47 operation.
ON	Powers ALE-47. Enables the ALE-47 sublevel on the EW format.
OFF	ALE-47 off

2.21.1.2 ALE-47 Advisories. The D LOW advisory is displayed when expendable loadouts drop to the BINGO level set on the ALE-47 sublevel of the EW format. The D BAD advisory is displayed when a dispense misfire occurs.

2.21.2 ALE-50 Decoy Dispensing Set. The ALE-50 decoy dispensing set provides an expendable towed RF countermeasures capability. The system includes a multi-platform launch controller (MPLC) and a removable dispenser with 3 expendable decoys. Refer to A1-F18EA-TAC series for details on ALE-50 operation and displays.

2.21.2.1 JAMMER Switch. The JAMMER switch, located on the center pedestal, is used to control power to the ALE-50 system and to provide a secondary means to sever a deployed towline.

CUT	Severs a deployed towline.
ON	Powers ALE-50. With WonW, initiates start-up BIT. Enables the ALE-50 sublevel on the EW format.
OFF	ALE-50 off

2.21.2.2 ALE-50 BIT Anomalies. There are currently three anomalies related to ALE-50 BIT, which can corrupt decoy inventory or damage the MPLC. These anomalies have not yet been corrected, so care should be taken when ALE-50 BIT is run.

1. When a full ALE-50 dispenser has been installed between flights, a full ALE-50 start-up BIT must be run with WonW, in order to inventory all decoys. If ALE-50 BIT is not run WonW, the system defaults to the last known inventory (which is two if one was dispensed on the previous flight).
2. If the JAMMER switch is placed to OFF while the ALE-50 start-up BIT or IBIT is running, the decoy inventory can be corrupted and/or the SEVER caution can be inhibited (e.g., no cockpit indication of a failed decoy is provided).
3. If the ALE-50 BIT is run post-flight after one or more decoys has been dispensed in flight, the system may arc and damage the MPLC.

Therefore, to avoid the potential loss of ALE-50 operability, aircrew should perform the following procedures on flights where ALE-50 use is anticipated. Run the ALE-50 start-up BIT and/or IBIT

with WonW prior to flight. Do not place the JAMMER switch to OFF while ALE-50 BIT is running. If this occurs, place the JAMMER switch back to ON and run another start-up BIT. Turn the JAMMER switch OFF in flight prior to landing or, at a minimum, do not cycle the JAMMER switch OFF then ON or initiate ALE-50 IBIT when WonW post-flight.

2.21.2.3 SEVER Caution. The SEVER caution is set under the following conditions: (1) the hook or landing gear is lowered with an ALE-50 decoy deployed, (2) a deployed decoy fails (AUTO DEPLOY option not selected), or (3) the signal was sent to sever a towline but the squib did not fire.

2.22 BIT-STATUS MONITORING SUBSYSTEM

The BIT/status monitoring subsystem, provides the aircrew with a simple display of system status. Most information is derived from BIT mechanizations within the avionics sets and from non-avionic built in tests implemented in the computer software for other aircraft subsystems.

The subsystem monitors engine and airframe operational status for unit failures and caution/advisory conditions when the mission computer system is operating. When the mission computer system detects a caution/advisory condition, it commands display of the applicable caution or advisory message on one of the DDIs. If the mission computer system detects a unit failure, it commands the subsystem to store the applicable maintenance code. The mission computer displays the subsystem BIT results on one of the DDIs.

Non-BIT equipment status includes configuration ID numbers and INS terminal data.

2.22.1 FIRAMS - Flight Incident Recorder and Aircraft Monitoring Set. The FIRAMS consists of a signal data computer, a data storage set, an engine fuel display, and a maintenance status panel. The FIRAMS monitors selected engine, airframe, avionic, non-avionic, fuel gauging and consumable signals. It also performs conversion of sensed measurements, provides real time clock function, outputs discrete and analog data to associated equipment, communicates with the mission computer, displays fuel quantities and engine parameters, and performs fuel system health monitoring. FIRAMS also provides nonvolatile storage for flight incident, maintenance, tactical and fatigue data, and bulk data input of tactical mission planning data.

2.22.2 DFIRS - Deployable Flight Incident Recorder Set. The DFIRS system consists of the signal data recorder (SDR), the data transfer interface unit, and the pyrotechnic release system. The SDR consists of the flight incident recorder memory, beacon, battery, and antenna. DFIRS is contained in a deployable aerodynamic airfoil located on the top of the fuselage between the rudders. The DFIRS system stores up to 30 minutes of flight data and, when activated, deploys the SDR along with a rescue beacon in an airfoil. The SDR is deployed upon pilot ejection or on ground impact. The data stored on the flight incident recorder (FIR) is gathered by the mission computer from aircraft systems. DFIRS records flight data, cautions, advisories, and spin data. The FIR memory wraps around to the beginning when the end of memory is reached. Only the last 30 minutes of each flight is retained. The MC controls the rate and the type of data that is stored. DFIRS data recording starts when both throttles are advanced past the vertical, launch bar is lowered, ground speed exceeds 50 knots, or WoffW and airspeed is over 80 knots. DFIRS recording stops 1 minute after WonW, both throttles less than the vertical, and the ground speed less than 50 knots. All data with SPIN mode activated are automatically recorded. A DFIRS DWNLD option is available on the engine display with WonW. Selecting this option downloads the DFIRS data to the MU for easier retrieval.

2.22.3 Avionics BIT. In most instances, two types of BIT are mechanized, periodic and initiated. Periodic BIT begins functioning at equipment power application. It provides a failure detection

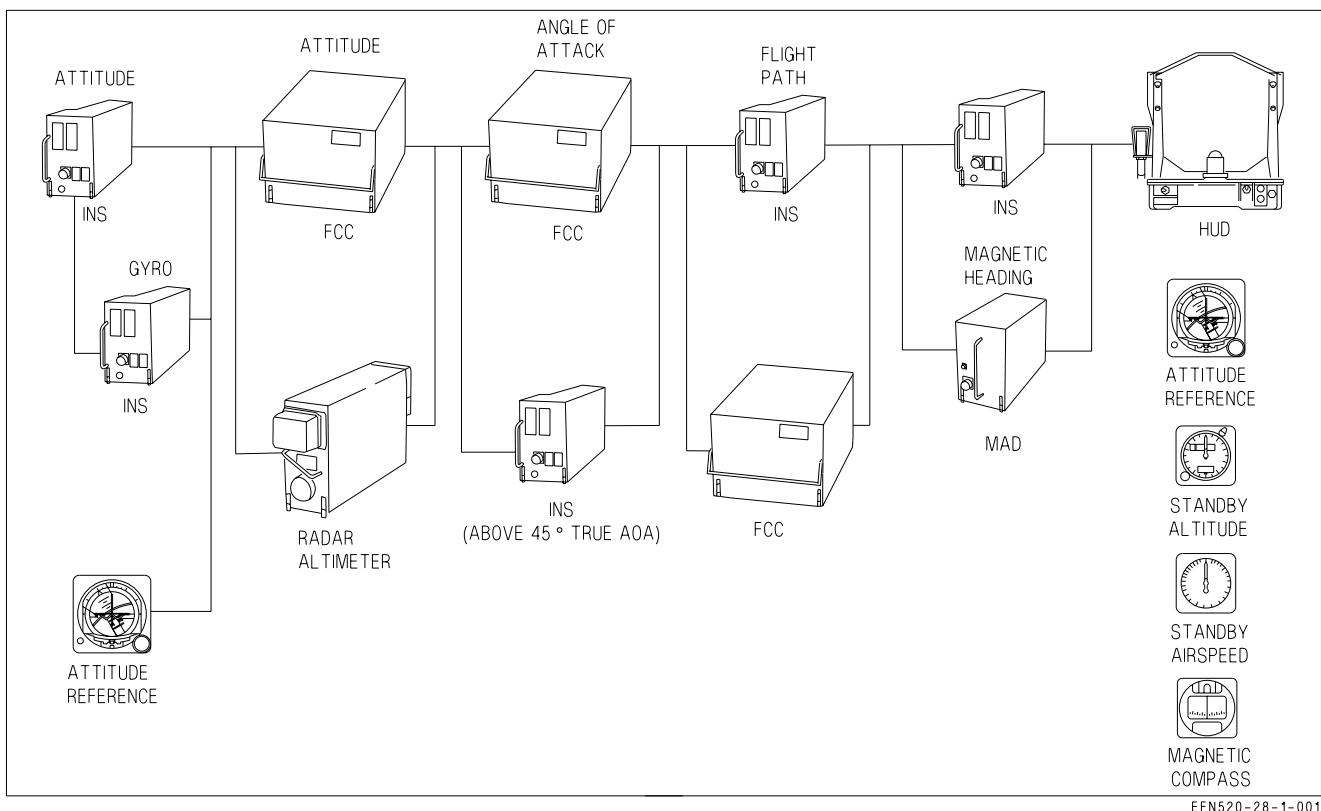

Figure 2-68. Flight Aids Reversion Mechanization

EFN520-28-1-001

capability that is somewhat less than that provided by initiated BIT in that it does not interfere with normal equipment operation.

Two forms of BIT derived data are supplied to the MC. One form is validity information associated with selected data. The second form is equipment failure information which identifies failed assemblies. The MC uses these two forms of BIT data to implement reversion operation and advisories for the aircrew as well as equipment status displays for both the aircrew and maintenance personnel.

2.22.3.1 Reversion. When the BIT equipment determines that a function has exceeded a predetermined threshold, the data derived from that function is immediately indicated as not valid. The MC, upon receiving this indication, reverts to the next best available source. This source is, in many cases, as accurate as the original source. This reversion is maintained as long as the data remains invalid from the primary source.

Figure 2-68 illustrates this concept for the flight aids. For each unit in the primary path, there is at least one alternate source of data for reversion. The aircrew is provided appropriate display cueing only when a reversion results in some loss of capability or performance. If the ALT switch is in RDR and the radar altimeter fails, the MC removes the displayed radar altitude, replaces it with barometric altitude, and replaces the "R" cue with a flashing "B" cue. If altitude is lost from the FCC and the altitude switch is in BARO, the MC removes the displayed altitude from the HUD. These examples illustrate 3 forms of degraded mode advisories: (1) reversion to an alternate data source of equivalent accuracy with no cueing; (2) reversion to an alternate data source of lesser accuracy with cueing; (3) and removal of displayed data when no acceptable alternate source is available. Refer to Part VIII for further discussion on weapon system reversions.

2.22.3.2 Equipment Status Displays. Equipment status displays (BIT, caution, and advisory) provide the aircrew with continuous status of the avionics equipment and weapons. A cue to check equipment BIT status is the appearance of the BIT advisory display on the caution/advisory. The display is normally on the left DDI. A MENU selectable top level BIT format displays the status of failed, NOT RDY, or OFF systems of all avionics equipment that interface with the MC. When the BIT control display is selected on another display, the BIT advisory is removed until another BIT failure occurs. For aircraft with the 8 x 10 display installed, messages appear as ACNTR. Messages displayed as a function of equipment status are listed in figure 2-69.

Weapon and stores status is displayed primarily on the stores display (selected from the menu display). When the BIT display indicates a stores management system (SMS) failure, the affected stations and degree of failure are identified on the stores display as described in A1-F18EA-TAC-series.

STATUS MESSAGE	APPLICABLE SYSTEM	MESSAGE DEFINITION
NOT RDY	All systems except MC1	Equipment OFF, not installed, or initializing.
OFF	RDR, MPCD, ACNTR, UFCD, CAM, IFF, RALT, BCN, ILS, TCN, COM1, COM2, D/L	Equipment OFF.
IN TEST	All systems except MC1, MC2, RWR	Initiated BIT in progress.
SF TEST	FLIR, NFLR, SMS, RDR, MPCD, ACNTR, UFCD, RALT, WPNS, LTDR, DFIRS, GPS ALE-47, ALE-50, DBFS, ECS, FADEC	Self test in progress (cannot be operator terminated).
GO	All systems	Initiated BIT completed without failure.
DEGD	All systems except MC1, MC2	Failure detected; equipment operation degraded.
DEGD + OVRHT	LDT, FLIR, NFLR, SMS, MPCD, ACNTR, UFCD, CAM, CSC, FCSA, FCSB, INS, ASPJ, RWR, LTDR, DFIRS, ALE-50, FADEC	Detected failure and overheat.
OVRHT	LDT, FLIR, NFLR, SMS, MPCD, ACNTR, UFCD, CAM, CSC, FCSA, FCSB, INS, ASPJ, RWR, LTDR, DFIRS, ALE-50, FADEC	Overheat.
MUX FAIL	CLC, FLIR, NFLR, SMS, RDR, LDDI, RDDI, MPCD, ACNTR, CSC, MC2, FCSA, FCSB, INS, COM1, COM2, D/L, ASPJ, AISI, SDC, MU, LTDR, DMC, DFIRS, GPS, ALE-47, ALE-50, ECS, FADEC, UFCD (Aft)	Equipment is not communicating on AVMUX and on/off discrete is set to on.
RESTRT	All systems except MC1, MC2, RWR, FADEC	Reinitiate BIT; equipment did not respond to BIT command, remained in BIT too long and was terminated by MC.
OP GO	NFLR, SMS, COM1, COM2, WPNS, MU, DFIRS, GPS, ALE-47, ALE-50, FADEC	Non critical BIT failure detected.
PBIT GO	All systems except MC1, MC2, RWR, FADEC	Initiated BIT has not been run since ground power-up and PBIT is not reporting any failures.
<p>No indication (blank) adjacent to the equipment legend indicates that initiated BIT has not been run on the equipment and that the periodic BIT has not detected any faults. LDDI, RDDI, MPCD, and EFD have unique degraded messages of ALDDI, ARDDI, AMPCD/ACNTR, AEFD, and AUFCD in the F/A-18F to allow distinguishing BIT status failures for aft cockpit displays.</p>		

Figure 2-69. Equipment Status Messages

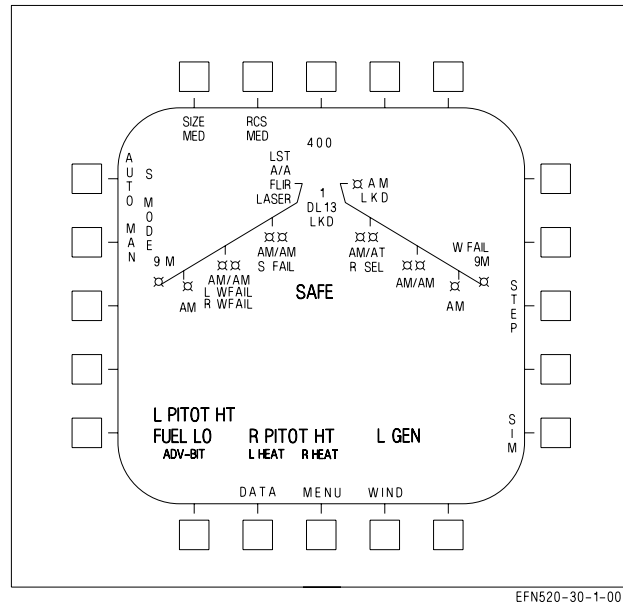

Figure 2-70. Caution/Advisory Displays

2.22.3.2.1 Cautions and Advisories. Cautions and advisories are displayed on the left DDI except when the left DDI is used for BIT display or weapon video (figure 2-70). When the left DDI is off or failed, or when the LDDI is used for BIT or weapon video, cautions and advisories are displayed on the center display. If the left and center displays fail or are turned off, the right DDI displays the cautions and advisories. Cautions and advisories automatically move to the center display when BIT is selected on the LDDI. Caution displays appear as 150 % -size letters compared to the normal message symbology size. Cautions are displayed as they occur beginning in the lower left portion of the DDI display and sequence to the right up to 3 displays across. The fourth caution reindexes to the left edge above the first caution. A dedicated caution display automatically replaces the HSI display if the number of cautions exceeds 3 lines. Advisory displays appear as 120 % -size letters on a single line beneath the caution displays. The advisories are preceded by an ADV- legend and the individual advisories are separated by commas. A caution or advisory is removed when the condition ceases. If there is a caution or advisory displayed to the right of the removed caution or advisory the display remains blank. Pressing the MASTER CAUTION light when the light is out repositions the remaining cautions and advisories to the left and down to fill the blank displays. When a caution occurs, the MASTER CAUTION light on the main instrument panel illuminates and the MASTER CAUTION tone or a voice alert is heard in the headset. The MASTER CAUTION light is extinguished by pressing the light. Refer to Warning/Caution/Advisory Displays in chapter 12 for the display implications and corrective action procedures.

2.22.3.3 BIT Initiation. In addition to displaying equipment BIT status, the BIT top level and nine sublevel displays (figure 2-71) are used to command initiated BIT. Those avionics set groups identified by the legends on the top level display periphery have an initiated BIT capability. BIT may be initiated for all operating units simultaneously except for some BIT that cannot be performed in flight. Figure 2-71 shows which initiated BIT are not allowed in flight. Additional steps are required to test the INS and FCS. BIT for individual units within groups may be initiated through the BIT sublevel displays.

Pressing BIT returns to the BIT top level display. Pressing STOP or MENU when BIT is in progress terminates initiated BIT. Performance of BIT assumes that the required electrical and hydraulic power is applied to the equipment tested.

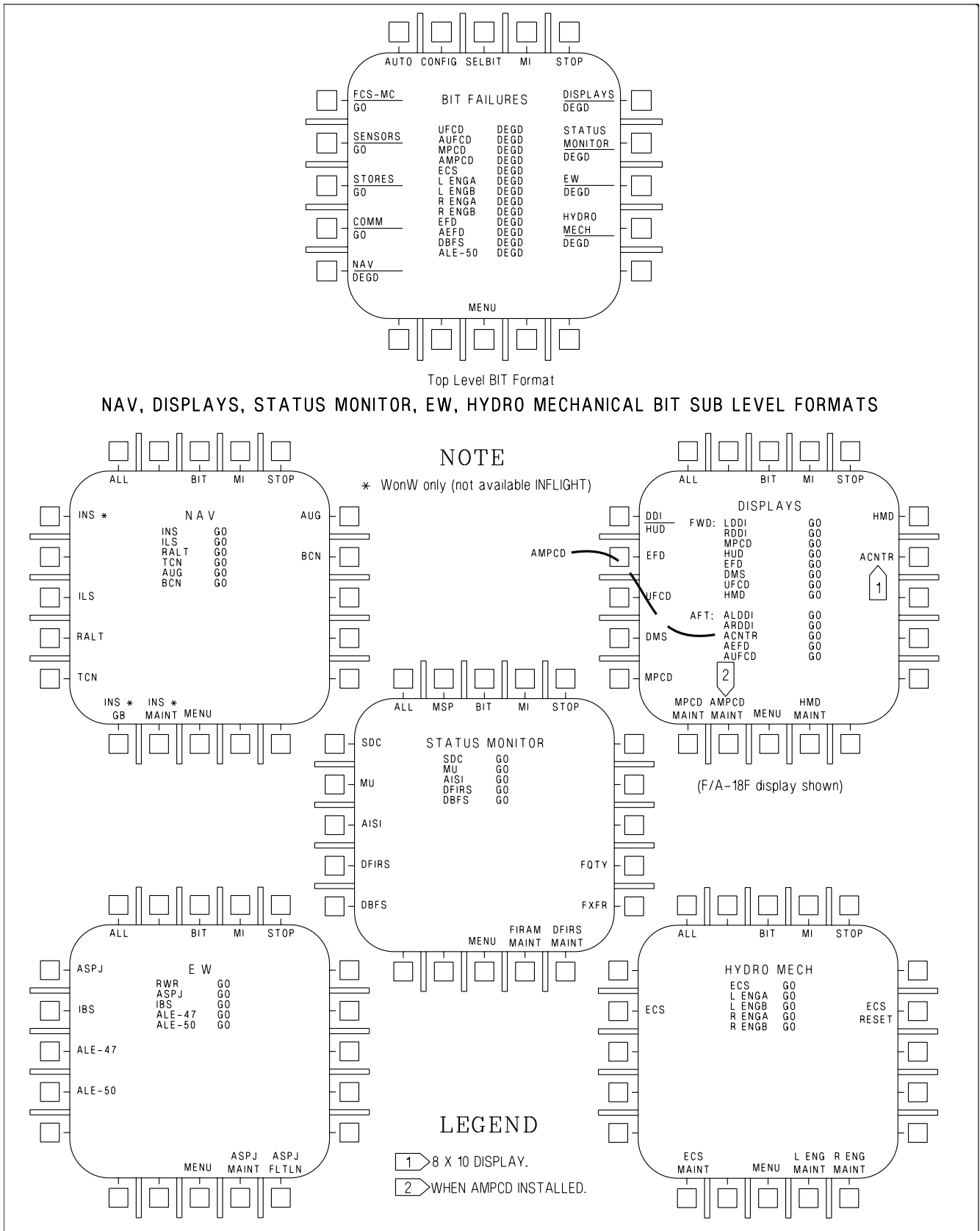

Figure 2-71. BIT Control Display (Sheet 1 of 2)

FCS-MC, SENSORS, STORES, COMM BIT SUB LEVEL FORMATS

NOTE

*W on W only (not available INFLIGHT)

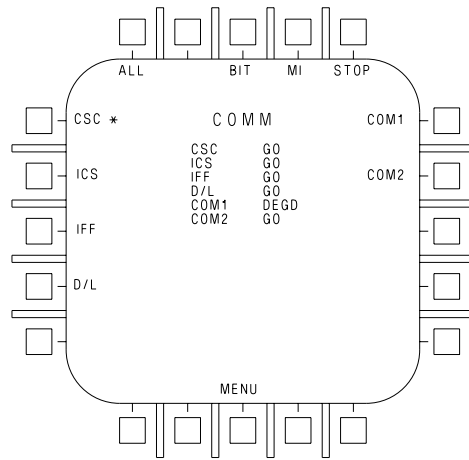
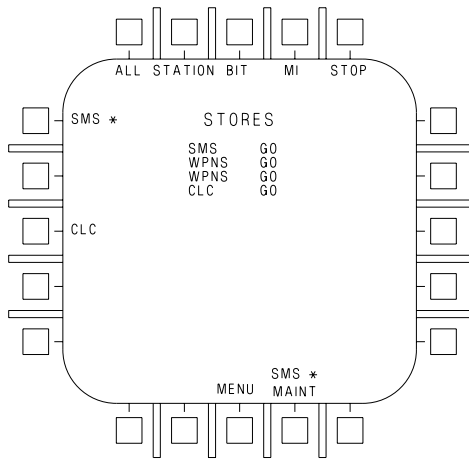
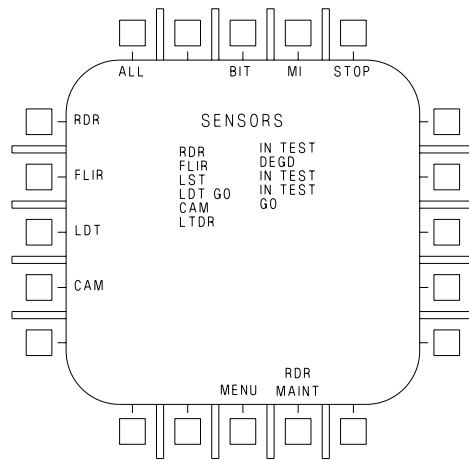
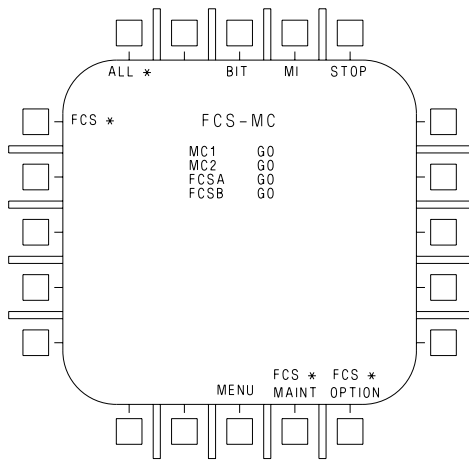

Figure 2-71. BIT Control Display (Sheet 2 of 2)

EFN520-31-2-001

2.22.3.3.1 All Equipment. Simultaneous initiated BIT of all equipment installed is performed by selecting AUTO on the BIT top level display. Equipment group, acronym and status are displayed at the display options. Equipment group status indicates the lowest operating status reported by any unit in the tested group. Individual system status results other than GO, PBIT GO, IN TEST, SF TEST, and OP GO are displayed with a system acronym in the center of the display. If the equipment list is too long to be displayed on one page, a PAGE pushbutton is displayed. Pressing PAGE displays the remainder of the list that is on page 2. Pressing PAGE when page 2 is displayed returns page 1.

2.22.3.3.2 Equipment Groups. Initiated BIT of entire equipment groups is performed by selecting SELBIT (SELBIT option becomes boxed) on the BIT top level display and the desired equipment group pushbutton. One or more groups can be selected. Another way to select a group is to press the group pushbutton (with the SELBIT option not boxed) on the BIT top level display and then ALL on the group sublevel display. See figure 2-71.

2.22.3.3.3 Individual Units. Initiated BIT of an individual unit is performed by pressing the equipment group pushbutton on the BIT top level display which contains the desired unit. The display changes to a group sublevel display. Individual units from the group can then be tested by pressing the pushbutton adjacent to the desired acronym. System status for all systems in the group is displayed on the center of the display. Some systems require additional aircrew BIT input.

2.22.3.4 System BIT Steps. The following includes certain initiated BIT which require steps in addition to pressing one of the buttons on the BIT display and reading the BIT status messages after the test is complete. Figure 2-71 shows which initiated BIT are not allowed in flight.

2.22.3.4.1 FCS Initiated BIT (IBIT). For the FCS to enter IBIT the FCS BIT consent switch must be held ON. This action prevents inadvertent IBIT initiation inflight for reasons of flight safety.

WARNING

Control surfaces move during FCS IBIT with hydraulic power applied. To prevent personnel injury or equipment damage, make sure personnel and equipment are kept clear of control surfaces.

NOTE

- With the wings folded, both ailerons are Xd out, but no aileron BLIN codes should be displayed. Even with wings folded, there are aileron functions tested that may reveal FCS failures via valid BLIN codes.
- For FCS IBIT to start, the FCS BIT consent switch must be held for at least 2 seconds. If not held for the required time, FCS A and FCS B will indicate RESTRT on the BIT status line. If RESTRT is displayed, select STOP on the FCS-MC sublevel display and then repeat the initiation procedure.
- The FCS will not enter IBIT if the throttles are above 14° THA or NWS is engaged.
- Do not operate any FCS related switches or move the stick or rudder pedals while FCS IBIT is running, as this may produce false failure indications

NOTE

- With the wings folded, a BIT status of GO will only be displayed for approximately 2 seconds before reverting to a DEGD indication. BIT status will return to GO when the wings are spread and locked.
- If the FCS IBIT fails, FCS A and FCS B will indicate DEGD on the BIT status line. Note surface Xs and/or BLIN codes and contact maintenance personnel for disposition.

1. Select MENU-SUPT/BIT/FCS-MC on right DDI.
2. While simultaneously holding FCS BIT consent switch to ON, select the FCS pushbutton on the FCS-MC sublevel display.
3. Release FCS button and FCS BIT consent switch when FCSA and FCSB BIT status indicates IN TEST. FCS IBIT requires approximately 1 minute.

NOTE

If IN TEST remains on the FCS BIT display longer than 2 minutes, select STOP and actuate the paddle switch to exit FCS IBIT.

2.22.3.4.2 Preflight FCS Initiated BIT. The fly-by-wire flight control system uses redundant hardware to provide continued safe operation after component failures. The level of redundancy designed into the system was set by component failure rates, failure mode effects, aircraft mission time, and survivability considerations. The ability to provide safe operation is fundamentally based on the principle that there are no undetected (e.g., latent) failures prior to flight which would compromise system redundancy. It is not possible to have an in-flight periodic BIT (PBIT) which can detect all degradations in a fly-by-wire system. Many redundant pathways can be tested only by setting system conditions that would be unsafe to establish in flight (e.g., verification of the ability to shut off an actuator). Preflight FCS initiated BIT was designed to provide those tests and ensure the full redundancy of the flight control system is available prior to flight. Without running preflight FCS initiated BIT and performing the necessary maintenance, latent failures present in the system can result in unsafe conditions should additional failures occur in flight.

2.22.3.4.3 Preflight FCS Initiated BIT Operation. Preflight FCS initiated BIT consists of a series of tests which verify the integrity of the flight control system processors, actuators, sensors, and cockpit interfaces.

Preflight FCS initiated BIT begins by testing lower level functions. If preflight FCS initiated BIT detects a fault at this level which affects higher level functions, it halts and reports the fault(s). If preflight FCS initiated BIT did not halt at this point, false BLIN codes would be generated on higher level functions which depend upon the failed lower level function for their operation. If preflight FCS initiated BIT detects a fault in a subsystem (e.g., left stabilator) testing of the failed subsystem is discontinued, and testing of unrelated subsystems (e.g., rudders, trailing edge flaps, etc.) continues. Since testing is not complete, preflight FCS initiated BIT must be run again after maintenance actions in order to complete all tests.

2.22.3.4.4 Preflight FCS Initiated BIT PASS/FAIL. A successful preflight FCS initiated BIT results in a GO indication on the DDI. An unsuccessful preflight FCS initiated BIT indicates a system

degradation. A preflight FCS initiated BIT never sets an X on the DDI FCS status page (MENU-FCS) since preflight FCS initiated BIT only sets BLIN codes. Launching in a degraded state (e.g., with BLIN codes) places the aircraft in a situation where a portion of the flight control system is operating without the normal redundancy.

2.22.3.4.5 Repetition of Preflight FCS Initiated BIT. If an aircraft fails preflight FCS initiated BIT (e.g., BLIN codes present after preflight FCS IBIT) maintenance should be called to troubleshoot the system. After completing troubleshooting, a successful preflight FCS IBIT is necessary to make sure the system is fully operational. Except for cold weather operation, preflight FCS IBIT failure is indicative of a component degradation, e.g., hydraulic or electrical components are out of tolerance, or a cable conductor is intermittent (broken wire, loose connector pin, etc.).

2.22.3.4.6 FCS Exerciser Mode. In cold weather, actuator components do not respond normally until hydraulic fluid temperature increases. Exerciser mode should be used to expedite system warm-up. During exerciser mode, a number of PBIT actuator monitors are ignored to prevent generation of nuisance BLIN codes. In cold weather it is appropriate to re-attempt preflight BIT after running exerciser mode. Exerciser mode should not be used as a method to clear BLIN codes in normal start-up temperature conditions. BLIN codes cleared in this manner could be associated with hydraulic contamination or sticking control valves which could appear again in flight with catastrophic results.



Repeatedly running exerciser mode in normal and hot weather environments may lead to hydraulic system overheat.

2.22.3.4.7 Running Preflight FCS Initiated BIT After Flight. A good (no codes) preflight FCS IBIT on the previous flight is no assurance against latent failures on the next flight. Electronic components have a propensity to fail on power application. Damage can occur during deck handling or maintenance activity not associated with the flight controls. The only insurance is to run preflight FCS initiated BIT prior to flight.

2.22.3.5 SMS Initiated BIT. Safeguards have been built into the weapon system mechanization to allow SMS initiated BIT to be performed on the ground with weapons loaded and cartridges installed. During initiated BIT, weapon release signals and associated circuitry are not exercised unless all of the following interlocks are satisfied simultaneously: MASTER ARM switch to ARM, armament safety override in override, weapon load codes on stores processor set to zero, and no weapon ID detected on any weapon station. SMS initiated BIT should not be attempted until the above interlocks are in a safe condition. The SMS initiated BIT should be successfully completed within 180 seconds of initiation.

2.22.3.6 INS Initiated BIT. To perform initiated BIT, the INS must be in the TEST mode and a ground/carrier selection must be made to indicate where the BIT is being accomplished. When the BIT/SELBIT/NAV/ALL, BIT/NAV/INS, or BIT/AUTO is actuated, a status message of GND/CV? appears next to the INS legend in the status display area. At the same time, GND and CV button labels appear along the bottom of the display. These options allow entry of where the initiated BIT is performed, e.g., on the ground or on a carrier. A third option, INS LONG (INS long test), identifies if the platform slew portion of the INS test is desired. The platform slew test, which adds an additional 26 minutes to the normal 12 minutes INS BIT time, is only performed when the INS exhibits degraded navigation performance during a flight and normal BIT routines do not detect any malfunction. This option should be selected prior to selecting the ground or carrier option.

1. Check parking brake set.
2. For ground initiated BIT insure waypoint zero is local latitude/longitude.
3. Select MENU/BIT/SELBIT/NAV or MENU/BIT/NAV/INS or MENU/BIT/AUTO or MENU/BIT/NAV/ALL on the right DDI and TEST on the INS mode switch.
4. Select INS LONG (if required) and GND or CV on DDI, and start clock. At successful completion of test BIT, display status message reads GO. Maximum time for INS initiated BIT is 12 minutes and maximum time for INS initiated BIT and platform slew test is 45 minutes.

2.22.3.7 AUTO BIT. If the AUTO button is pressed, BIT are initiated in parallel for all equipment turned ON and whose interlocks are satisfied. The test pattern associated with the DDI and HUD is not displayed when the AUTO option is used. Approximately 2.5 minutes are required for all AUTO BIT except FCS and INS.

1. Check power applied to all systems requiring BIT and check required interlocks in safe condition.
2. Select MENU/BIT/AUTO on DDI.
 - a. All systems read GO after required test period. GO indication is provided when system check is complete and OK. Other messages may be displayed if malfunctions are detected.
3. If FCS test required, perform FCS Initiated BIT above while substituting the AUTO button for the FCS button in the procedure. Insure the procedural warnings and notes are observed and that the AUTO button and FCS BIT consent switch are held simultaneously to initiate test.
4. If INS test required, perform INS initiated BIT above while substituting the AUTO button for the INS button in the INS Initiated BIT procedure.

2.22.3.8 Cockpit Displays Initiated BIT.

2.22.3.8.1 DDI/HUD Initiated BIT. Operator participation is required to detect failures and isolate faults in the display equipment. The BIT/DISPLAYS/DDI-HUD option starts the MC generated test patterns on the DDI and HUD immediately after each indicator BIT is concluded. The test pattern can be compared on the 3 displays for similarity and individually for concentricity, intensity level, and alphanumeric clarity. Options are tested by actuating all the buttons. A circle appears adjacent to the button when the functional test is successfully completed.

With AMCD aircraft, IBIT takes approximately 20 to 90 seconds to complete (MC allows a maximum of 200 seconds). During this interval, the displays cycle through a series of raster test patterns (i.e., small square of raster, full screen of raster, small square again, and then a larger square of raster). Immediately after the BIT for each display is concluded, the MC generated test pattern is displayed on each of the displays. See figure 2-72. The STOP option on the test pattern terminates the CRT test. The DDIs alternate color of the test pattern between green, red, and yellow.

Pressing DDI-HUD initiates BIT on two different equipment display groups. The following procedure can be used to test one or both of the display groups by performing the appropriate parts of the procedure.

1. Select BIT/DISPLAYS/DDI-HUD

- a. DDI and HUD displays go blank momentarily, flash IN TEST, and display a test pattern.
 - b. Check DDI test patterns are steady and in focus. See figure 2-72.
 - c. HUD test pattern flickers but remains on.
2. DDI and HUD displays - CHECK
- a. Display commonality
 - b. Display concentricity
 - c. Proper intensity
 - d. Check right DDI pushbuttons (20) starting with the top left button on the horizontal row. Circle is displayed next to each pushbutton after it is pressed.
 - e. Check BIT status messages for GO on the BIT displays. F/A-18F lists front and rear indicator results separately.

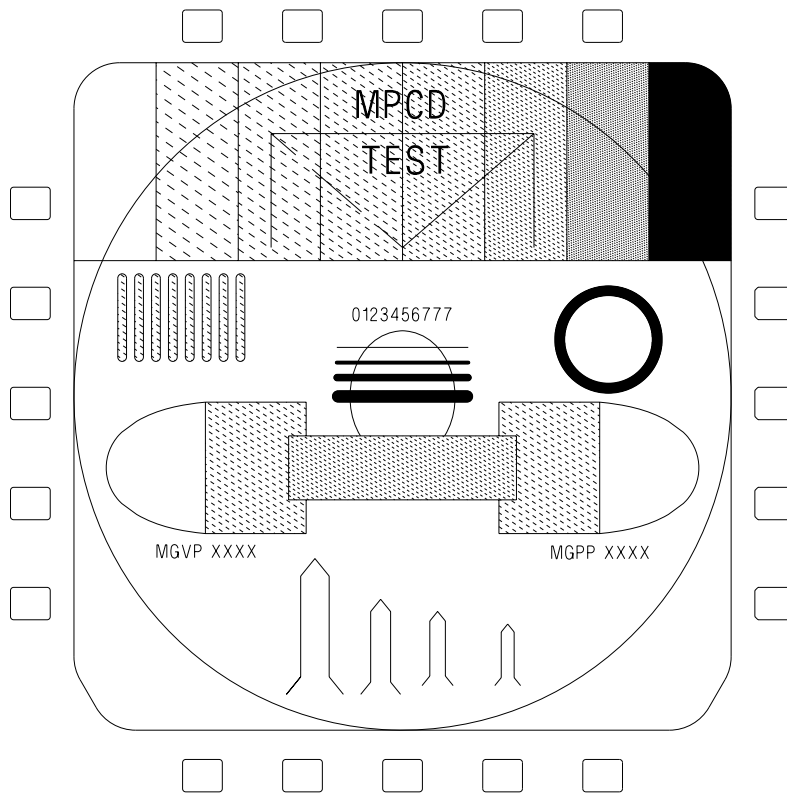
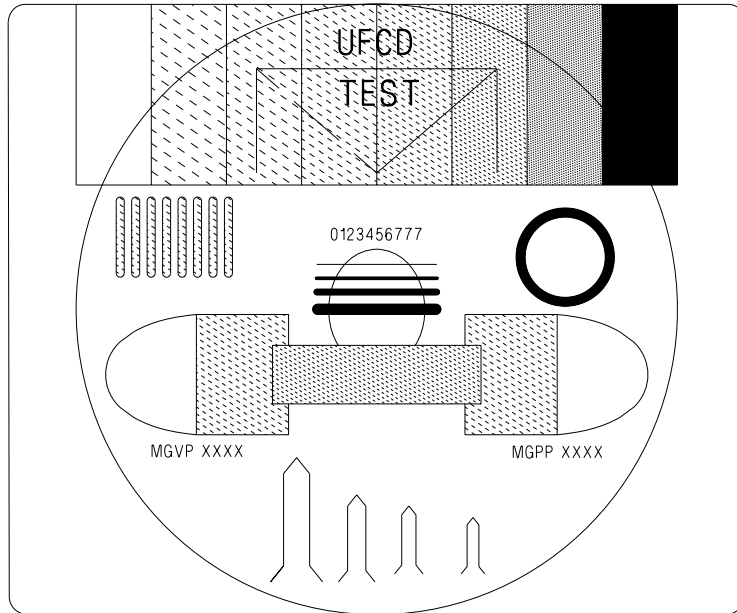

Figure 2-72. MPCD and UFCD Test Patterns

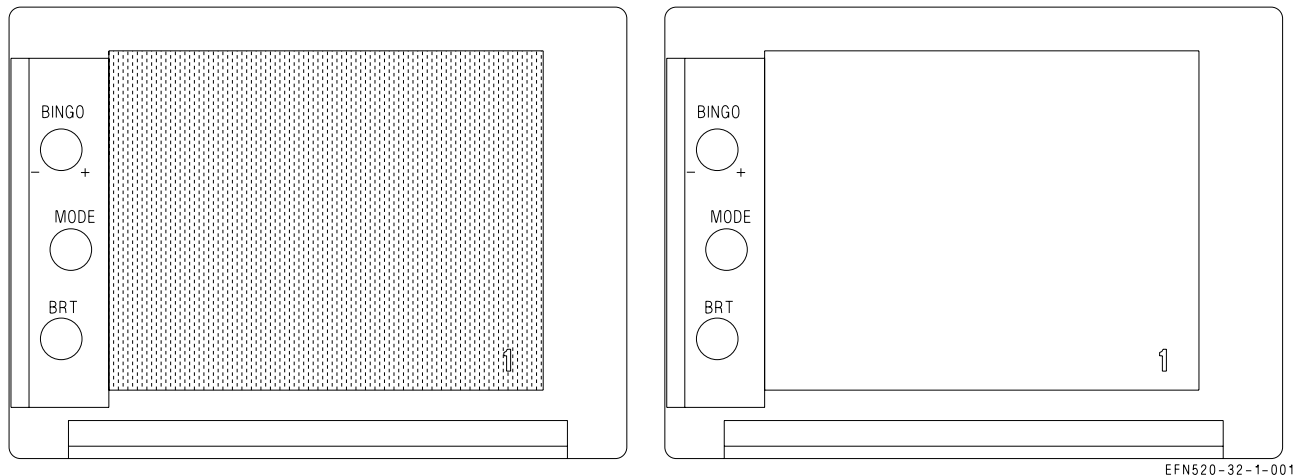

Figure 2-73. EFD Test Pattern

2.22.3.8.2 EFD Initiated BIT. The EFD test pattern is initiated by performing EFD BIT using pushbutton sequence BIT/DISPLAYS/EFD and observing the test pattern display following the completion of EFD BIT. The EFD test pattern may be observed using the following procedure.

1. Select BIT/DISPLAYS/EFD
2. EFD - observe test display
3. Select STOP or MENU to terminate test pattern

While the test pattern is displayed, selecting the MODE button or pulling the BINGO knob toggles between the two test patterns displayed in figure 2-73. Rotating the BRT knob does not change display intensity. Rotating the BINGO knob increments or decrements the number displayed in the lower right corner from 1 to 12, depending on the rotation direction (clockwise or counterclockwise).

2.22.3.8.3 MPCD Initiated BIT. The MPCD receives information directly from the MC for display and also processes the information provided for display on the UFC. The MPCD test pattern is initiated by doing MPCD BIT using pushbutton sequence BIT/DISPLAYS/MPCD and observing the test pattern display following the completion of MPCD BIT. The MPCD test pattern may be observed using the following procedure.

1. Select BIT/DISPLAYS/MPCD
2. MPCD and UFC - observe test displays
3. Select STOP or MENU to terminate test pattern

The BIT format can be displayed on the MPCD or UFC during DDI/HUD BIT and on the DDI during MPCD BIT. On F/A-18F, the MPCD option initiates BIT on both the cockpit and rear cockpit MPCD. During MPCD BIT the message MPCD IN TEST is displayed on both the MPCD and UFC. When IBIT is completed, the test pattern (figure 2-72) is displayed on both the MPCD and UFC.

2.22.3.8.4 8 x 10 Display Initiated BIT. The 8 x 10 display executes initiated BIT by selecting ACNTR on the Display BIT format. When selected, the 8 x 10 display completes IBIT and displays a

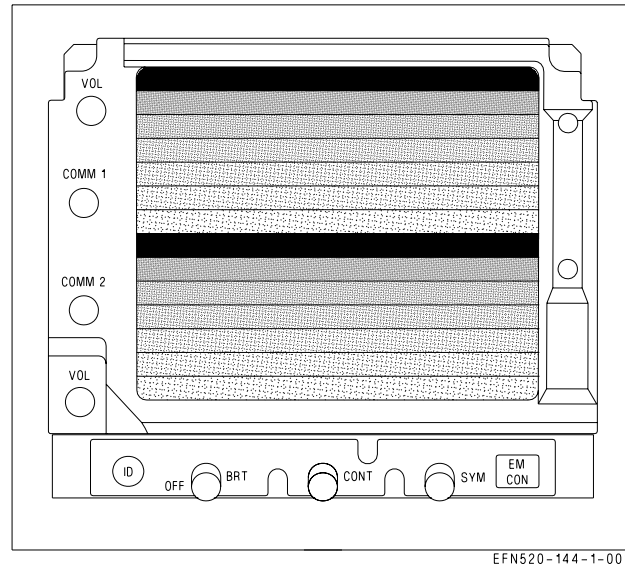

Figure 2-74. UFCD Test Pattern

test pattern on both the 8 x 10 display and the aft UFCD. The 8 x 10 display test pattern is the same as the DDI test pattern. The mission computer removes the IBIT command after 10 seconds to allow viewing of the test pattern on both displays.

2.22.3.8.5 UFCD Initiated BIT. UFCD test patterns are initiated by selecting BIT/DISPLAYS/UFCD and observing the test pattern display following the completion of UFCD BIT. The UFCD test pattern (figure 2-74) is obtained using the following procedure.

1. Select BIT/DISPLAYS/UFCD.
2. UFCD - Observe test display
3. Select STOP or MENU to terminate test pattern.

When BIT is initiated, UFCD IN TEST is displayed until BIT is completed. On F/A-18F, selecting UFCD initiates BIT on both cockpit and rear cockpit displays. The UFCD test pattern is not displayed if IBIT is not initiated on the UFCD option.

2.22.3.8.6 Radar Altimeter Initiated BIT. If BIT is initiated during RADALT time-in, the status on the BIT display is NOT READY. If the BIT is initiated after time-in is complete, the display is GO (indicating the radar altimeter is operating correctly), RESTRT (the BIT was not completed within the design time limits), or DEGD (a WRA fail signal exists).

2.22.3.8.7 STOP Button. The STOP button allows the aircrew to stop initiated BIT at any time. BIT is also stopped by pressing MENU, although MENU is not available with the DSPL/EPI/EFD/UFCD BIT test pattern displayed. When the STOP (or MENU) button is pressed, any test in progress stops and the equipment returns to normal operation. Exceptions to this are the radar and SMS power-on BIT and the COMM 1/2, D/L, and TACAN BIT. The radar and SMS power-on BIT cannot be terminated and indicate SF TEST when the MC detects the system is in BIT without having been commanded to do so. The same is true of the COMM 1/2, D/L, and TACAN equipment which does a canned non-interruptable BIT sequence. The mission computer terminates initiated BIT for any equipment that it determines has taken too long to complete the test.

2.22.3.9 Hydro-mechanical (HYDRO MECH) Initiated BIT. With SELBIT boxed on the top level BIT format, selecting HYDRO MECH initiates ECS BIT if aircraft is WonW.

FADEC status is also provided on the HYDRO MECH display by L and R ENG A and B status indications.

2.22.3.10 BLIN Codes. BIT Logic INspection (BLIN) codes are octal readouts identifying FCS failures and can be read from the FCS status display. The following procedures may be used to display and record BLIN codes. Channel 1 BLIN codes are displayed. Pressing the BLIN button displays the next channel (1, 2, 3 and 4) BLIN codes.

1. On DDI - PRESS MENU-SUPT/FCS/BLIN
2. DDI BLIN codes - RECORD BY CHANNEL
3. Press BLIN button to view next channel BLIN codes

2.22.4 Non-Avionic BIT. Non-Avionic BIT is implemented in selected hydro-mechanical subsystems primarily for the purpose of displaying subsystem status in the cockpit(s) (cautions and advisories) and/or providing fault detection and fault isolation information for maintenance personnel. This status data is provided to the status monitoring displays by the signal data computer which interfaces with the following hydro-mechanical areas:

1. Engine/Secondary Power
2. Electrical
3. Hydraulics and landing/arresting gear
4. Fuel
5. Environmental control system and liquid cooling system
6. Controls/mechanisms/miscellaneous

The hydraulic system pressure cautions are interfaced directly by both mission computers, providing redundancy for safety of flight.

2.22.4.1 Equipment Status Displays. NABIT cautions and advisories are displayed in the same manner as avionics cautions and advisories.

2.22.5 Status Monitoring Backup. MC2 provides backup status monitoring if MC1 fails. It provides an MC1 caution on the DDI indicating that MC1 has failed.

NOTE

With non-AMCD aircraft, if MC1 fails, all DDI cautions and advisories are lost except MC1, HYD 1A, HYD 1B, HYD 2A, and HYD 2B. TAC MENU loses the SA option and SUPT MENU displays only the HSI option.

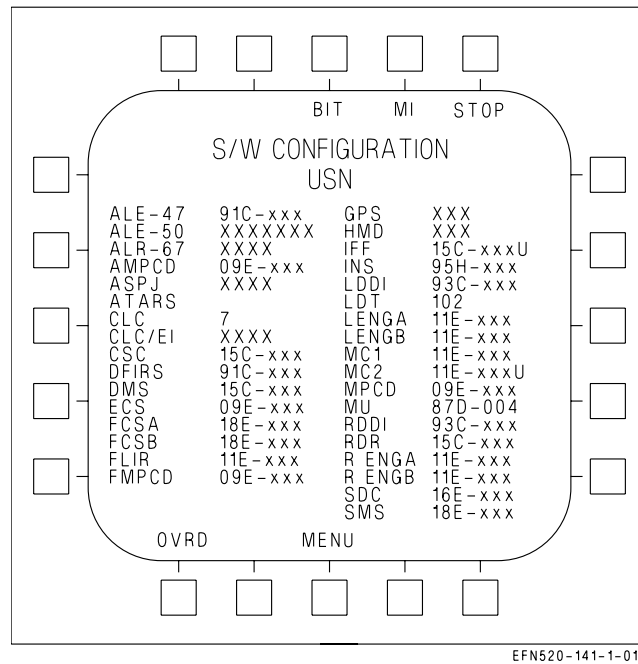

Figure 2-75. CONFIG Display (Sample)

NOTE

With AMCD aircraft, if MC1 fails, all DDI cautions and advisories are available.

2.22.6 Non-BIT Status. Equipment status derived by means other than BIT include DDI configuration display ID numbers and INS terminal data.

2.22.6.1 CONFIG Display Country ID Code. The country identifier code USN is displayed under the CONFIG legend.

2.22.6.2 CONFIG Display. The ID numbers of the current operational flight program (OFP) loads for the radar, stores management system, CLC, INS, mission computers, communication system control, flight control computer, FLIR, GPS, HMD, SDC, MU, LDT, DMC, MPCD, DDI, EW equipment, DFIRS, FADECs, and ECS controller can be determined by selecting the configuration display (see figure 2-75). The configuration display is selected by the following procedure:

1. Select BIT from the SUPT MENU.
2. Select CONFIG.

With the configuration display selected, the current ID numbers are displayed to the right of the equipment acronym. Refer to figure 2-75 for an example.

2.22.6.2.1 MC CONFIG Caution. An MC CONFIG caution indicates MC1 and MC2 OFP loads are incompatible.

2.22.6.2.2 S/W CONFIG Caution. With the exception of JHMCS, a S/W CONFIG caution indicates MC1 and MC2 OFP loads are not concurrent releases (incompatible) or an avionic equipment processor OFP is incompatible with MC OFPs. The incompatible OFP(s) are indicated by a line drawn through the OFP ident. If the MC OFPs are incompatible a line is drawn through both MC OFP idents. For JHMCS, a S/W CONFIG caution and a line through the HMD S/W configuration line on the configuration display indicates a mismatch in the BuNo in the Magnetic Compensation Data file and the BuNo in the MC, or failure to load the initialization file into the EU.

2.22.6.2.3 OVRD Button. The override option allows the pilot to override the software configuration logic when the software country ID codes do not agree with the aircraft country ID codes.

2.22.6.3 INS Terminal Data. INS terminal data can be obtained if at least one update has been performed after flight with the parking brake on. Terminal data is displayed by selecting the following options in sequence: MENU, BIT, MAINT, INS, and POST. Note the PER (performance error rate) and navigation time on the FLIGHT 1, POST 1 display (see figure 2-76). Select the POST option again and note the velocity on the FLIGHT 1, POST 2 display. Turn the INS mode selector knob to OFF. With GPS operating, if the aircraft is flown with IAF selected, the performance error rate does not include the time flown in the AINS mode.

POS = INS POSITION
 ALN TIME = TIME IN SECONDS
 A Q = ALIGN QUALITY
 A C = STATE COUNTER
 FOR ALIGN MODE
 NAV TIME = TIME IN SECONDS
 PER = INS PERFORMANCE (EQUALS RADIAL
 POSITION ERROR IN NAUTICAL MILES/HR)

 TO CHECK INS PERFORMANCE, DO AN UPDATE,
 OVFLY, TO WAYPOINT 0.

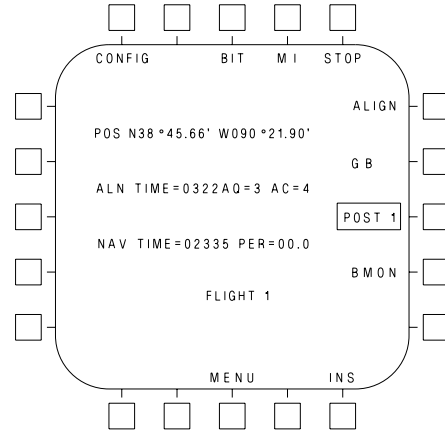

FLIGHT 1 THRU 5 (FLIGHT 1 SHOWN) - POST 1 DISPLAY

ERROR = IN N/S OR E/W, THE UPDATES
 ARE ADDED ALGEBRAICALLY
 CUM = ABSOLUTE VALUE OF UPDATES
 VEL = VELOCITY IN N/S OR E/W DIRECTION
 UPDATES = NUMBER OF UPDATES

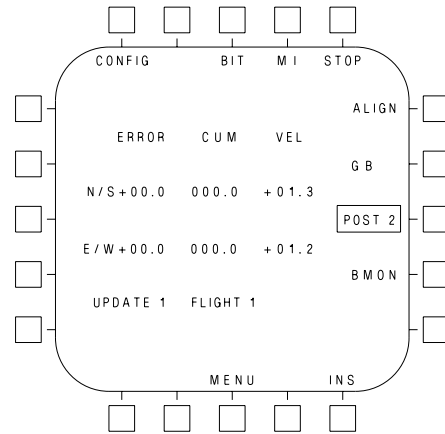

FLIGHT 1 THRU 5 (FLIGHT 1 SHOWN) - POST 2 DISPLAY

Figure 2-76. INS Postflight Data Display

2.23 JOINT HELMET MOUNTED CUEING SYSTEM (JHMCS)

The JHMCS allows the aircrew to target and employ existing short range missiles (SRMs) and High Off-Boresight (HOBS) weapons, such as the AIM-9X, and cue the radar, and other sensors. When using JHMCS to employ HOBS weapons, the aircrew can slave/acquire and shoot targets beyond the gimbal limits of the aircraft radar and designate ground targets. The main display provides a monocular 20° field of view that is visible in front of the pilot's right eye.

The main components of the JHMCS include the helmet mounted displays, electronics unit, HMD/AHMD off/brightness knobs, aft cockpit Boresight Reference Unit (BRU), cockpit units, magnetic transmitter units, and seat position sensors in each cockpit. The JHMCS aircraft-integrated components can be flown with or without the helmet system.

WARNING

Increased weight and forward CG of the helmet will increase neck strain during high or sustained g flight maneuvers.

NOTE

All aircrew shall receive simulator or dedicated ground training on JHMCS helmet controls and displays prior to flight with JHMCS.

2.23.1 Helmet Mounted Display (HMD)/Aft Helmet Mounted Display (AHMD). Each HMD consists of the helmet, Helmet Display Unit (HDU), Helmet-Vehicle Interface (HVI), and a universal connector which connects the HDU to the helmet.

2.23.1.1 Helmet Display Unit (HDU). The HDU includes a CRT, Magnetic Receiver Unit (MRU), camera, auto-brightness circuitry, uplook reticles, and visor. Aircrew can remove the HDU and configure the helmet to accommodate the AN/AVS-9 night vision goggle system.

Ensure the HMD/AHMD OFF/BRT knob(s) are OFF before removing the HDU, and store the HDU in the JHMCS stowage bag on the right bulkhead. See figure 2-78.

CAUTION

- To keep water out of the HDU on aircrew helmets and prevent the possibility of electric shock, ensure the HDU cover is installed on the helmet.
- To prevent damage to the HDU, do not expose the HDU to a temperature exceeding 50°C (122°F) operationally or in storage.

2.23.1.2 Helmet-Vehicle Interface (HVI) Connectors. The HDU is connected to the aircraft by the HVI, which consists of 3 connectors. These connectors are the Quick Disconnect Connector (QDC), In-Line Release Connector (IRC), and Helmet Release Connector (HRC). The upper HVI is the portion of the HVI from the helmet to the QDC. The lower HVI is the portion of the HVI below the QDC that is installed in the aircraft.

The upper HVI is routed under the survival vest (if worn) through the JHMCS bundle flue on the torso harness. The QDC is seated in a Quick Mounting Bracket (QMB) attached to the lower left hand leg strap of the torso harness. See figure 2-77.

WARNING

The JHMCS upper HVI (UHVI) must be properly routed through the JHMCS bundle flue under the survival vest and the QDC secured in the QMB to ensure that no entanglement exists with the oxygen hose. Misrouting of the JHMCS UHVI may allow the QDC to rub against the oxygen hose disconnect causing unintentional oxygen/communications disconnect in-flight.

The QDC is the primary disconnect for ejection, and both normal and emergency ground egress. The QDC can be manually disconnected for normal egress by pushing a button on top of the QDC and separating the top half. During an ejection or emergency egress the QDC is disconnected via an aircraft mounted lanyard when a force of 15 to 25 pounds is applied. When the QDC is not connected, the aircraft QDC should be properly stowed in its receptacle. When the QDC is not properly connected and the system is on, an HMD/AHMD advisory is generated.

WARNING

The JHMCS QDC must be properly attached to the aircrew torso harness QDC mounting bracket to avoid possible death or severe injury during ejection.

CAUTION

- Low voltage is present on the exposed QDC pins when the HMD/AHMD OFF/BRT knob(s) are not in OFF. To prevent a minor electrical shock from contact with exposed pins, ensure the HMD/AHMD OFF/BRT knobs are OFF whenever the QDC is disconnected or connected.
- To prevent damage to the QDC and aircraft components, ensure the aircraft QDC is properly stowed in its receptacle when not mated to the aircrew's QDC.

NOTE

Ambient cockpit temperatures at or below 0°C (32°F) may cause inadvertent HMD/AHMD advisories during preflight. Warming of the QDC and quick mount bracket should remove the failure indication if temperature is the cause.

The IRC is a back-up disconnect which functions in the event of QDC failure. The IRC is attached to the left aft console and requires a force of 80 to 120 pounds to disconnect.

The HRC allows the cable to disconnect should the helmet be lost during ejection. The HRC connects to the left shoulder harness and requires a force of 80 to 120 pounds to disconnect.

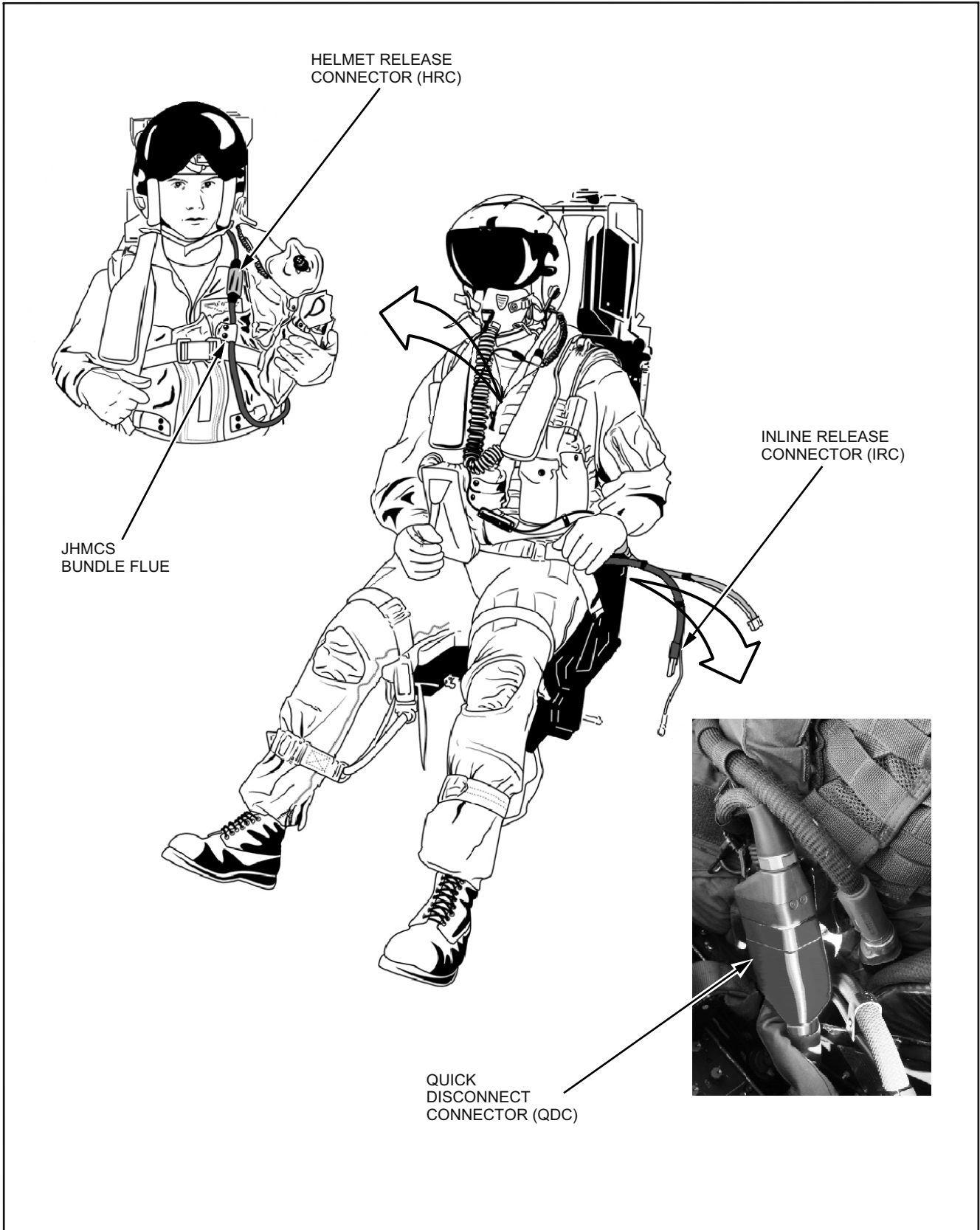

Figure 2-77. JHMCS Upper HVI Routing

EFN520-376-1-018

2.23.2 Electronics Unit (EU). The EU contains the main system CPU, LOS module, graphics processor/display drive (one for each HMD), and low voltage power supply. The CPU controls system bus interfacing, display list generation, BIT, and other system functions. The LOS module calculates helmet LOS while the graphics processor/display drive processes the display list and generates the helmet display. The MC interfaces with the EU via the MUX bus. It is located in the rear cockpit.

2.23.3 Cockpit Unit (CU). The CU contains the system high voltage power supply for helmet displays. On the F/A-18E, it is located in the upper equipment bay, and on the F/A-18F, both CUs are located in the aft crew station.

2.23.4 Magnetic Transmitter Unit (MTU). The MTU is used to generate a magnetic field used to determine HMD/AHMD position/orientation by the HMD MRU receiving the magnetic field and then sending the received signal to the EU. One MTU per cockpit is mounted on the canopy frame aft of the pilot/WSO's left shoulder.

The MTU is energized when the HMD/AHMD is turned on. Warm-up time for the MTU is 15 to 20 minutes. System accuracy may drift up to 0.5° if the HMD/AHMD is aligned before MTU warm-up is completed. An additional 5 to 10 minutes should be added to the MTU warm-up time if operating in extremely cold temperatures (e.g., -40°C).

NOTE

To maintain system accuracy, run initial HMD/AHMD alignment, or an additional HMD/AHMD alignment, after system is warmed-up.

2.23.5 Boresight Reference Unit (BRU). On the F/A-18F, the BRU is located on top of the instrument blast shield and dust cover. An alignment cross is provided inside the BRU to permit coarse and fine alignment of the AHMD to the aircraft reference. See figure 2-79.

2.23.6 Seat Position Sensor (SPS). The SPS is a linear potentiometer which indicates ejection seat height to the JHMCS. It is mounted to the aft right side of the ejection seat. There is one SPS for each ejection seat. This seat position information allows the JHMCS to compensate for disruption of the magnetic field in the cockpit as the metal in the seat changes position when the seat is raised or lowered.

2.23.7 HMD/AHMD OFF/BRT Knobs. The front cockpit HMD OFF/BRT knob is located on the spin recovery panel. This knob removes and applies power to the HMD, and adjusts HMD display brightness. See figure 2-78.

A BRU/HMD OFF/BRT stacked knob, located on the aft cockpit INTR LT control panel, removes and applies power to the BRU/AHMD, and adjusts BRU/AHMD display brightness. See figure 2-78.

2.23.8 HUD Video Record Panel. A switch has been added to the HUD video record panel so that HMD or LDDI can be selected while the other switch is used to select HUD or RDDI for video recording.

2.23.9 Cautions/Advisories. When the BuNo in the Magnetic Compensation Data file does not match the BuNo in the MC, or if the MC fails to download the initialization file to the EU, the MC sets the SW CONFIG caution and displays a line through the HMD S/W configuration line on the configuration display. An HMD/AHMD advisory is reported if the QDC is not properly secured to Quick Mounting Bracket (QMB) or is disconnected, the HDU is not properly connected, or the coarse alignment is invalid or has not been performed.

FORWARD COCKPIT

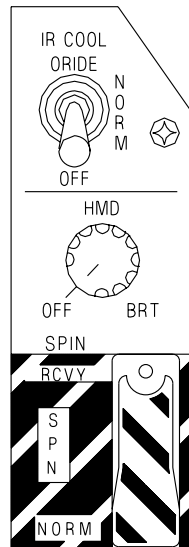

MAP GAIN/SPIN RECOVERY PANEL

REAR COCKPIT

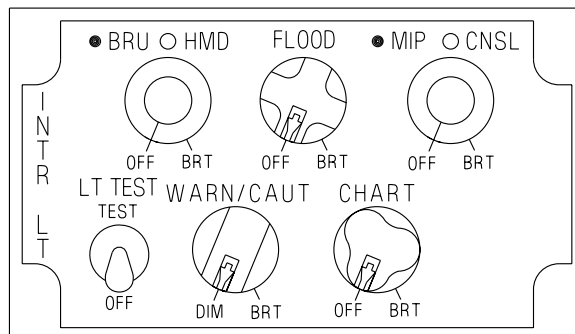

INTERIOR LIGHTS CONTROL PANEL

Figure 2-78. HMD Controls

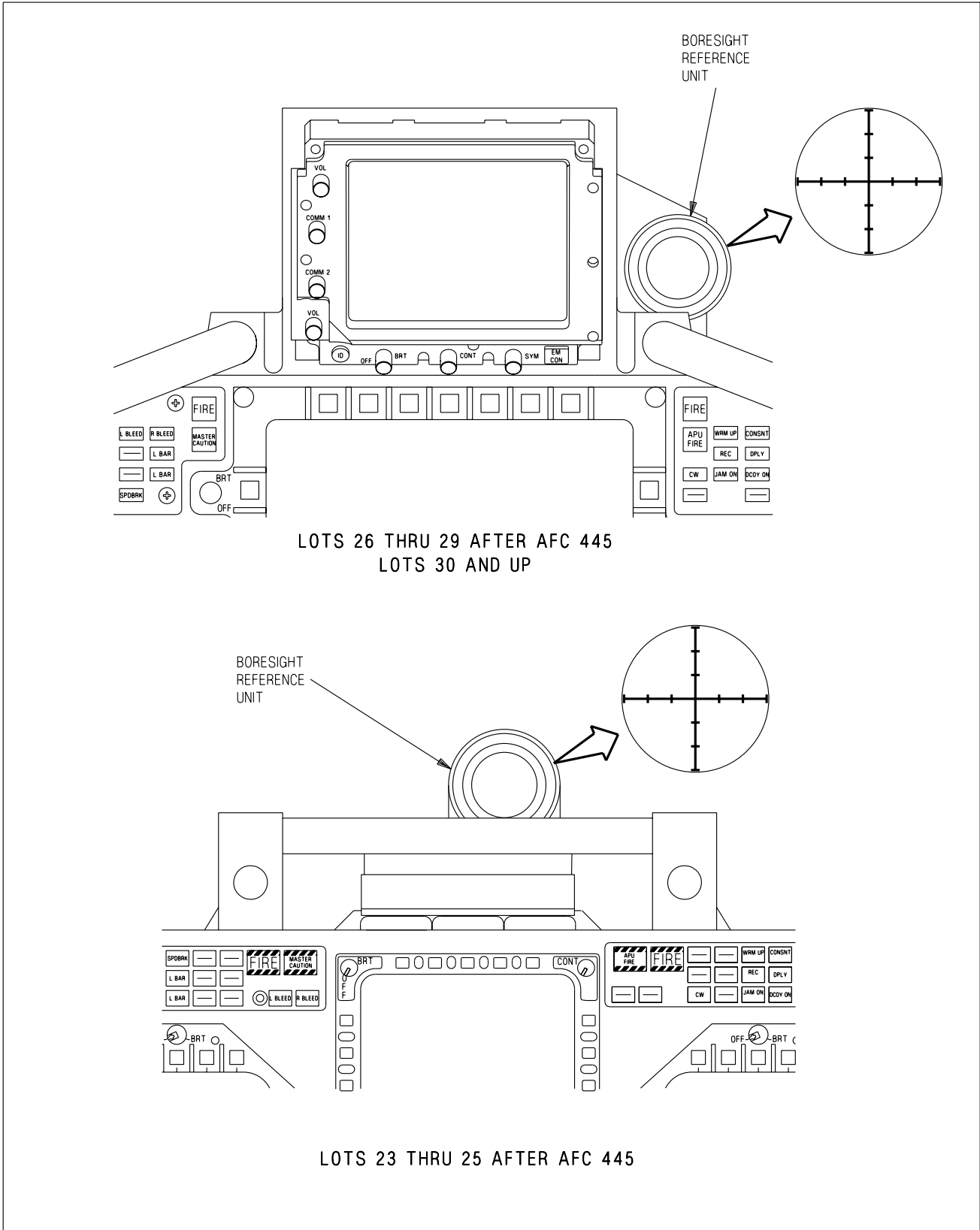

LOTS 26 THRU 29 AFTER AFC 445
LOTS 30 AND UP

LOTS 23 THRU 25 AFTER AFC 445

Figure 2-79. Boresight Reference Unit

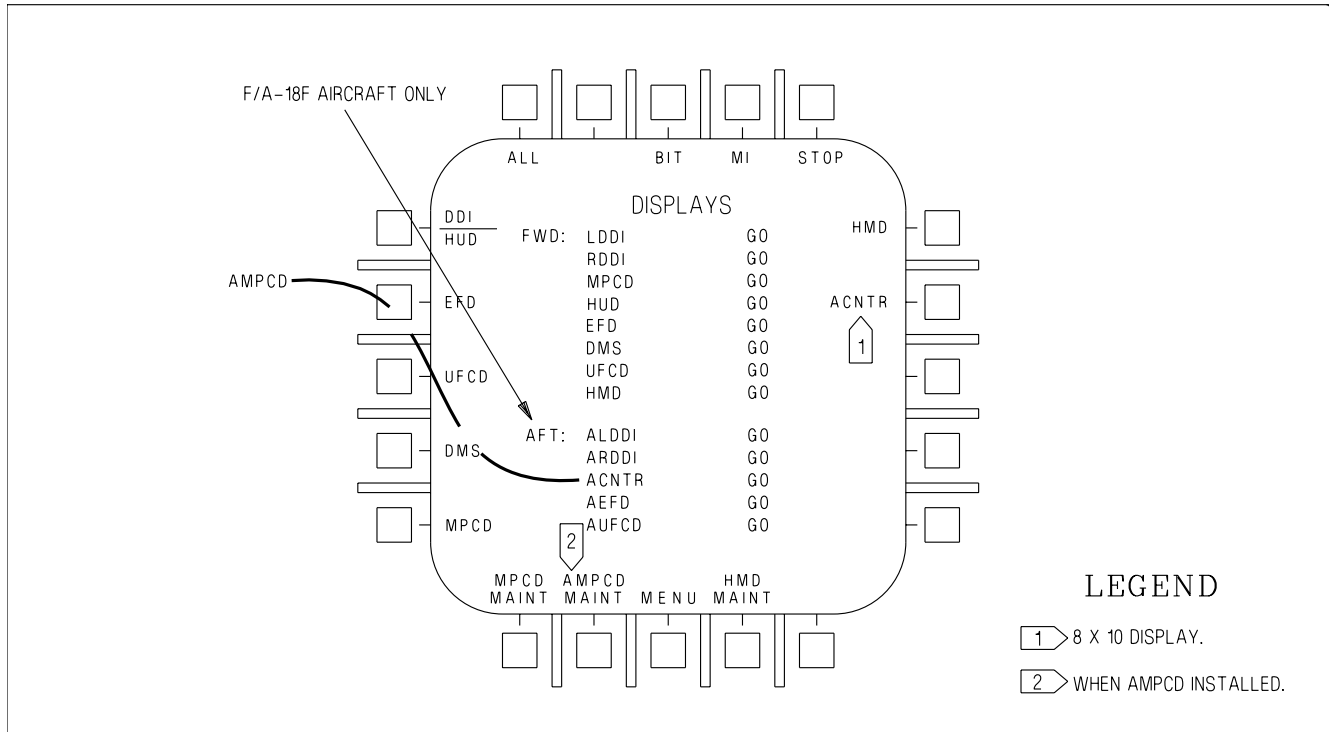

EFN520-378-1-013

Figure 2-80. Displays BIT Sublevel

2.23.10 Configuration Check. When the JHMCS system is turned on, the MC provides the EU with the aircraft make, model, and tail number.

2.23.11 Built-In Test (BIT). The JHMCS BIT system includes automated start-up BIT (SBIT) and initiated BIT (IBIT), and displays a BIT status message. See figure 2-80 for the DISPLAYS BIT sublevel display.

2.23.11.1 Start-up BIT (SBIT). When the HMD system is turned on, SBIT starts automatically and the internal software is loaded in the EU. SBIT cannot be stopped until it is completed. PBIT GO or DEGD, as appropriate, is displayed when SBIT is completed.

2.23.11.2 Initiated BIT (IBIT). IBIT is performed when the HMD (PB 11) option is selected in either cockpit on the DISPLAYS BIT sublevel display. ENTERING IBIT flashes on both HMDs, and an initiated BIT is performed on both helmets. When IBIT is complete, a series of four test patterns, which are automatically changed each second, are displayed on the HMD/AHMD. See figure 2-81. The test patterns are displayed until the STOP (PB 10) option is selected. If the ALL (PB 6) option is selected, IBIT and HMD test patterns are performed.

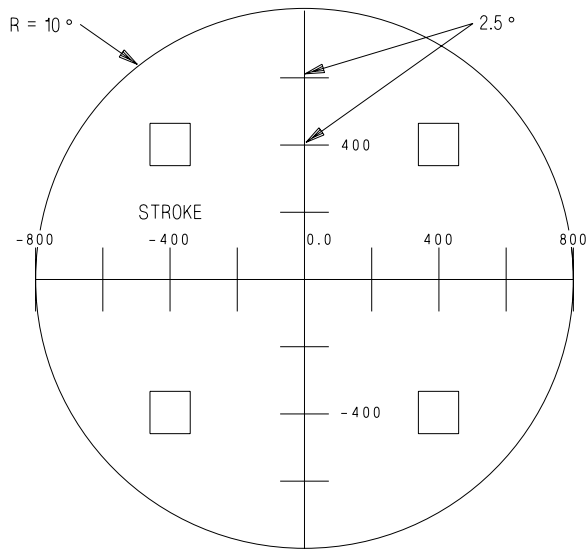

PATTERN 1

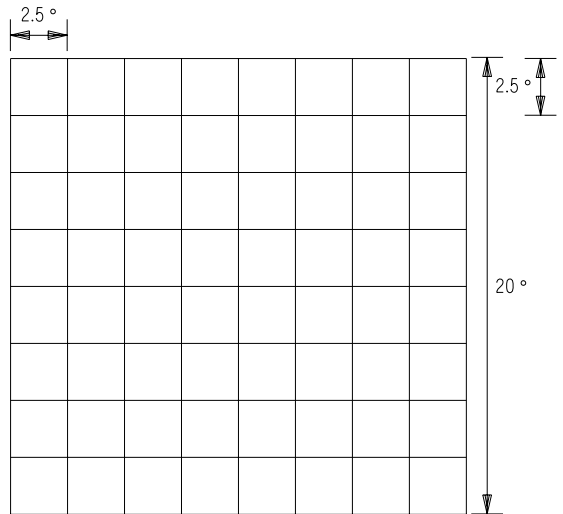

PATTERN 2

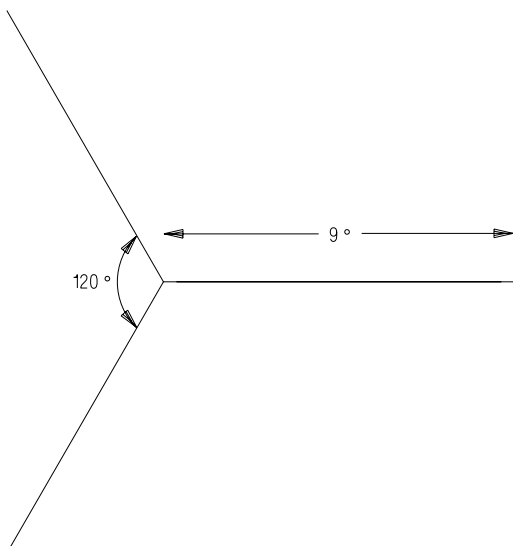

PATTERN 3

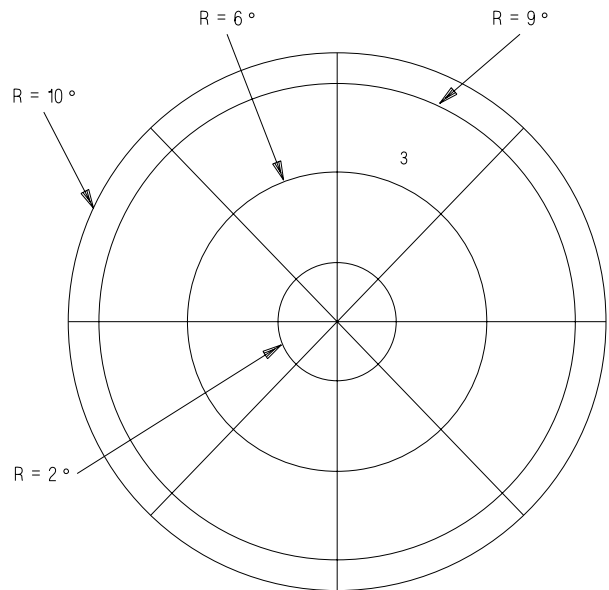

PATTERN 4

Figure 2-81. HMD/AHMD Test Patterns

EFN520-379-1-005

2.23.11.3 Status Messages. Refer to the following for status messages and associated descriptions:

STATUS	MESSAGE DESCRIPTION
MUX FAIL	Equipment ready discrete is high but the EU is not communicating on either MUX bus to the MC
NOT RDY	Equipment ready discrete is low and the EU is not communicating on either MUX bus to the MC
IN TEST	Initiated BIT in progress
RESTRT	Re-initiate BIT, EU did not respond to the IBIT command or IBIT did not complete within 30 seconds
DEGD	EU has detected a failure which degrades system performance
OVRHT	EU has reported a component as overheated
DEGD+OVRHT	EU has detected a failure and EU has reported a component as overheated
GO	EU responded with no failures.
OP GO	EU has detected a failure which does not degrade system performance
PBIT GO	EU responded with no failures prior to performing IBIT

2.23.11.4 BIT Recording On The Memory Unit. The MC records any failure or degrade reported by the EU to the memory unit for fault reporting and isolation.

2.23.11.5 Overheat Condition. The system has the capability to detect an equipment overheat condition. When an overheat condition is detected the system is automatically shut down to prevent equipment damage.

2.23.12 JHMCS Alignment. The JHMCS must be boresighted (aligned) with the aircraft prior to every flight. Selecting the ALIGN (PB 20) option on the HMD format boxes ALIGN, selects coarse alignment mode, and displays the FINE (PB 1) alignment option after the coarse align function is complete. See figure 2-82.

The forward and aft helmets are aligned independently. Selecting the ALIGN (PB 20) option on the HMD format from the aft cockpit initiates aft HMD align. When in aft coarse or fine align mode, the MC assigns the right hand controller undesignate and Designator Control (DC) switches to the HMD. Both forward and aft HMD alignments function identically with the exception that the aft helmet is aligned to the BRU mounted on top of the instrument blast shield and dust cover.

2.23.12.1 Coarse Alignment. An alignment cross is displayed on the HUD/BRU and on the HMD/AHMD. See figure 2-82. The pilot moves the HMD to superimpose the alignment cross on the HMD over the alignment cross on the HUD. Once aligned, the cage/uncage switch is pressed and held until ALIGN OK is displayed on the HMD. When coarse alignment is complete, fine alignment is automatically selected. Fine alignment (PB 1) can also be manually selected.

The WSO moves the HMD to superimpose the alignment cross on the HMD over the alignment cross on the BRU, figure 2-82, sheet 2. Once aligned, the undesignate switch on the right hand controller is pressed and held until ALIGN OK is displayed on the HMD. When coarse alignment is complete, fine alignment is automatically selected. Fine alignment (PB 1) can also be manually selected.

2.23.12.2 Fine Alignment. When the FINE (PB 1) option is boxed, an alignment cross is displayed in the HUD, and two alignment crosses are displayed on the HMD in the vicinity of the HUD alignment cross. See figure 2-83. The display indicates which axis is being aligned. If azimuth and elevation is indicated (FA DXDY), the pilot moves the TDC either left or right to align in azimuth, up or down to align in elevation. The pilot presses and releases the cage/uncage switch when satisfied with the quality of the azimuth and elevation alignment. This causes the display to toggle to roll alignment mode. With the roll axis indicated (FA DROLL), TDC inputs to the left or right are used to rotate the HMD alignment symbols to align with the HUD alignment cross. The pilot presses and releases the cage/uncage switch when satisfied with the quality of the roll alignment. Pressing and releasing the cage/uncage switch continues to toggle between these two modes until the pilot deselects FINE to return to coarse alignment or exits alignment.

Upon entering fine alignment, automatically, or if commanded by the WSO selecting the FINE option, the EU indicates which axis is being aligned. If the azimuth and elevation axis is indicated, the WSO uses the DC to move the crosses up/down and left/right to align with the cross displayed on the BRU, (figure 2-83 sheet 2). When satisfied with the alignment, the WSO presses and releases the undesignate switch on right hand controller at which time the EU automatically switches to roll alignment. The WSO uses the DC to rotate the cross so that it aligns with the cross displayed on the BRU. When satisfied with the quality of the alignment the WSO presses and releases undesignate switch on right hand controller.

2.23.12.3 Alignment Exit. Alignment is exited whenever ALIGN is deselected (unboxed), an A/A weapon is selected, MENU is selected, TDC priority is reassigned, ACM mode is selected, or the master mode is changed. This removes the alignment cross from the HUD, removes the FINE option, unboxes ALIGN, and returns the cage/uncage function to the previously assigned system.

2.23.12.4 Alignment Verification. When the HMD is in normal mode a cross is displayed on the HUD at the reported HMD LOS. See figure 2-84. If the reported HMD LOS is outside the HUD FOV, the cross flashes at the HUD FOV limit.

2.23.13 HMD/AHMD Symbology

2.23.13.1 HUD Symbology Replicated on the HMD. The HMD layout essentially replicates the HUD layout. Window locations, format, and occlusion level on the HMD are as identical to the HUD locations, format, and occlusion level as practical.

2.23.13.2 HUD Symbology Not Replicated on the HMD. Some of the symbology on the HUD is either not required on the HMD or would be disorienting if the information was presented. The following paragraphs describe the items on the HUD which are not replicated on the HMD.

2.23.13.2.1 Aircraft Attitude Data. Some HUD data only provides the pilot usable information when presented along the aircraft boresight. HMD data is not always presented along the aircraft boresight. For this reason, the aircraft pitch ladder, horizon bar, water line indicator, and velocity vector are not displayed on the HMD/AHMD.

WARNING

The HMD/AHMD does not provide adequate attitude information and should not be used as a primary flight instrument.

2.23.13.2.2 Ground Proximity Warning System. In addition to aircraft attitude data, the HMD/AHMD does not replicate the Ground Proximity Warning System (GPWS) arrow. However, when the GPWS is activated, ALTITUDE is displayed in the HARM window of the HMD/AHMD.

2.23.13.2.3 Landing Aid Symbology. Landing aid symbology is not displayed on the HUD.

2.23.14 Navigation Master Mode. If present, the MC displays the A/A L&S with the TD box and its associated TLL, or the A/G designation with the TD diamond and its associated TLL. However, if both the A/A L&S and the A/G designation are present, only the A/A L&S TLL is displayed.

2.23.14.1 NAV Master Mode TDC Priority. When in NAV master mode, the TDC can be assigned priority to the HMD by pressing the castle switch forward. This is indicated by an open aiming cross with a dot in the center being displayed. If TDC priority is removed from the HMD, the dot is removed from the center of the aiming cross.

HMD COARSE ALIGNMENT

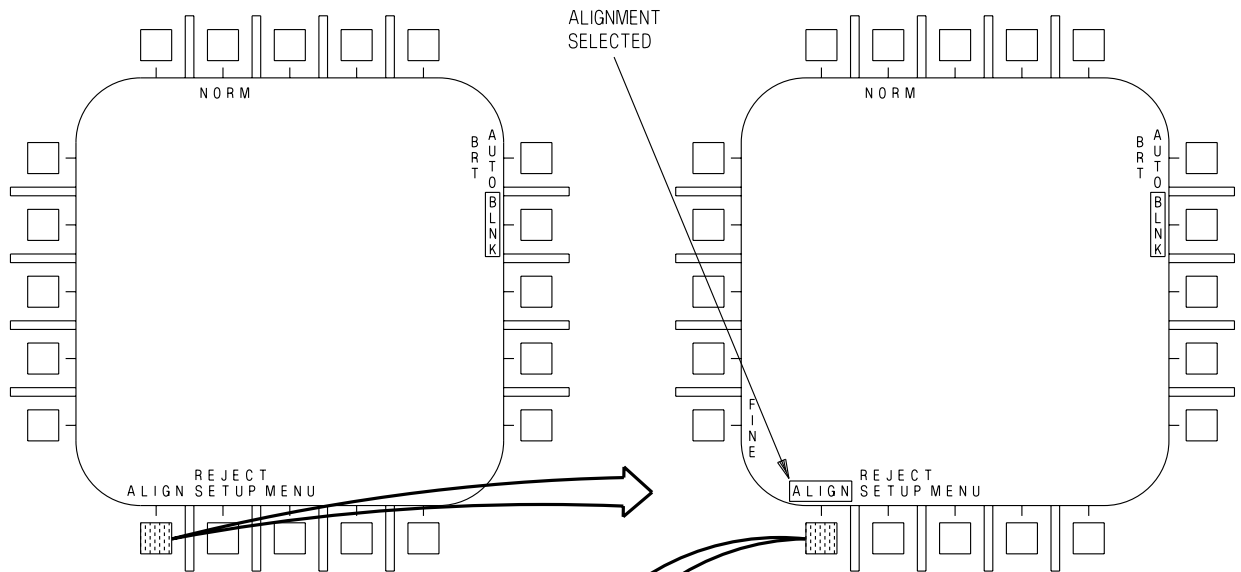

1. HMD MENU

2. COARSE ALIGNMENT SELECTION

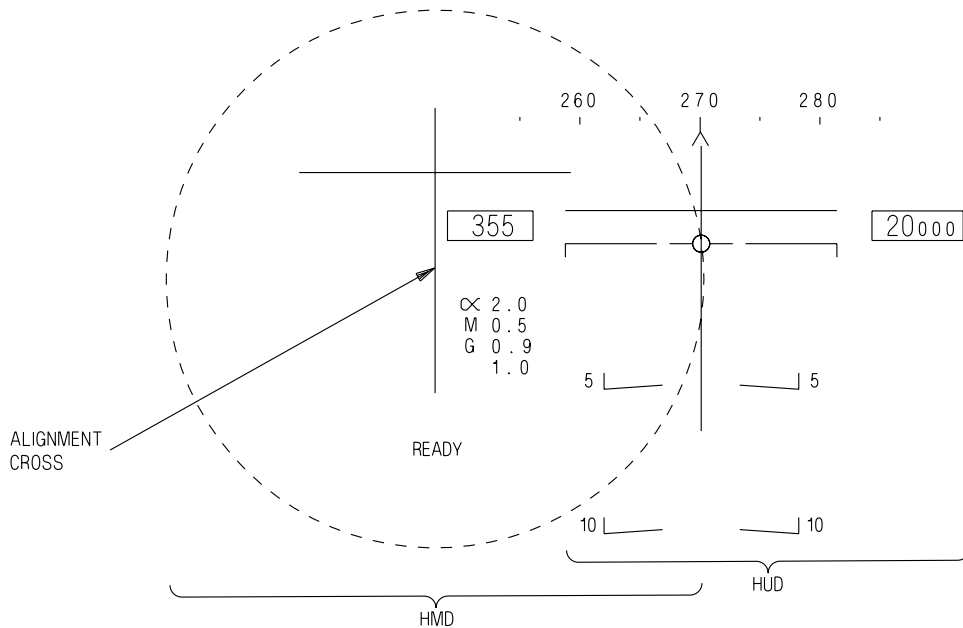

3. HUD AND HMD DISPLAYS

Figure 2-82. Coarse Alignment (Sheet 1 of 2)

AHMD COARSE ALIGNMENT

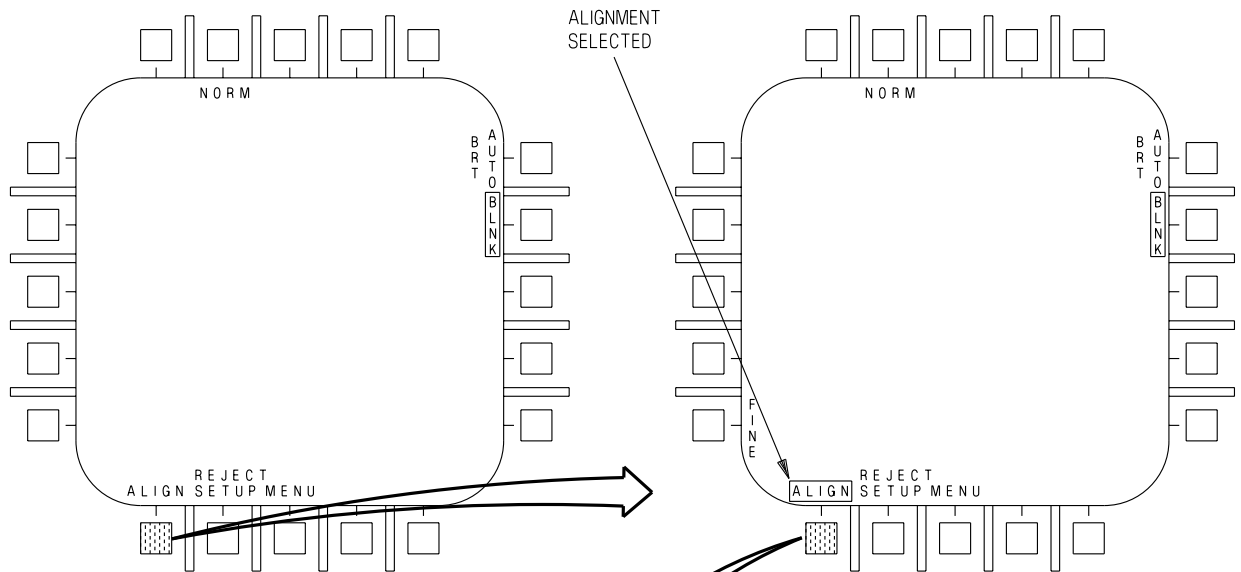

1. AHMD MENU

2. COARSE ALIGNMENT SELECTION

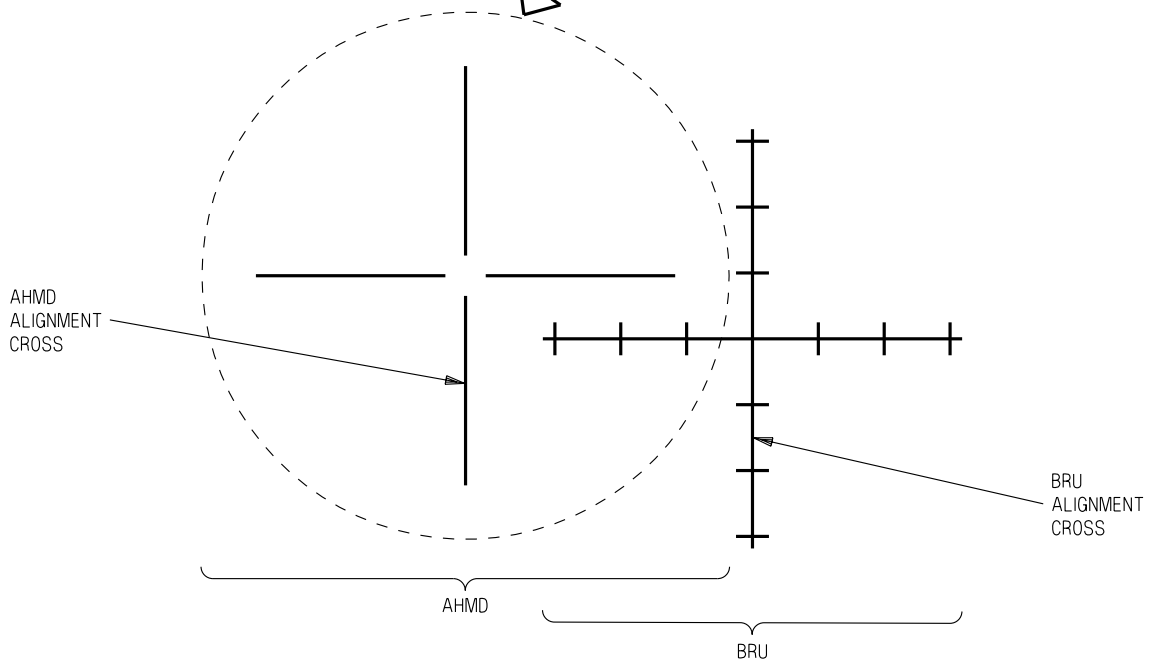

3. BRU AND AHMD DISPLAYS

Figure 2-82. Coarse Alignment (Sheet 2 of 2)

2.23.15 Mission Computer Failure. With non-AMCD aircraft, in the event of an MC1 failure, MC2 provides back-up symbology for the HMD. MC2, at a minimum, provides airspeed, altitude, selected A/A weapon and count, and the L&S and AIM-9 LOS. MC2 continues to slave the radar to the HMD LOS when in HACQ mode. MC2 also continues to slave the AIM-9 to the HMD LOS when the AIM-9 is selected. Activation of the uplook reticles are also maintained during back-up.

With non-AMCD aircraft, in the event of an MC2 failure, MC1 provides back-up symbology for the HMD. MC1, at a minimum, provides airspeed, altitude, selected A/A weapon and count. Slaving of the radar and AIM-9 is suspended.

With AMCD aircraft, the HMD is not supported in the MC backup mode. If either MC fails, no symbology is displayed on either helmet and the remaining operating MC functions as if no helmets are installed.

2.23.16 Electronic Unit Failure. In the event of an EU failure which does not allow any symbology to be displayed on the HMD, the MC provides the radar boresight symbol and AIM-9 FOV symbol on the HUD. If the LOS is still valid, the MC continues to slave the radar or AIM-9 to the HMD LOS. If the LOS is invalid, the MC reverts to the current no-helmet mechanization for slaving weapons, sensors, and HOTAS.

HMD FINE ALIGNMENT

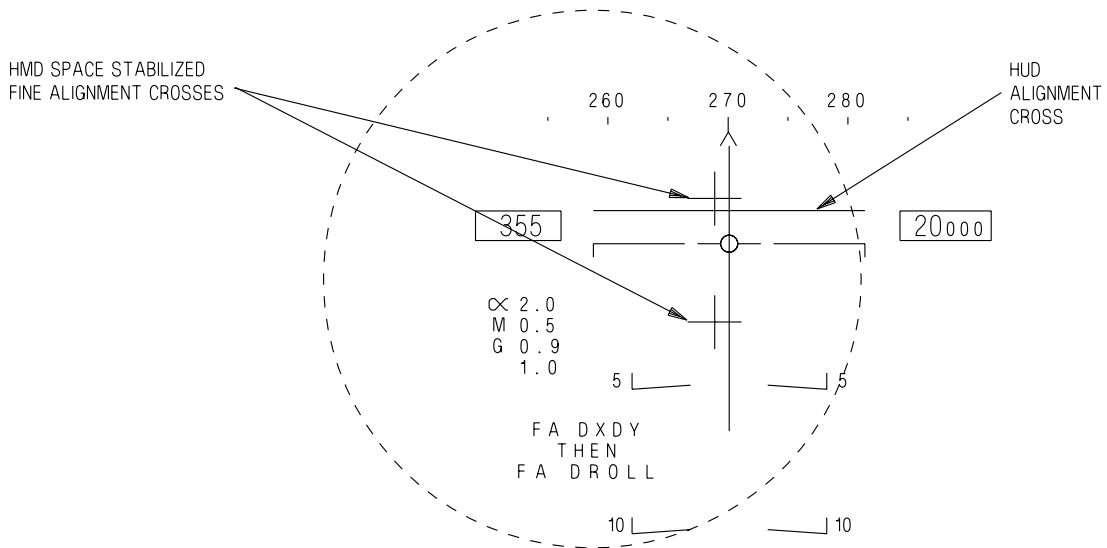
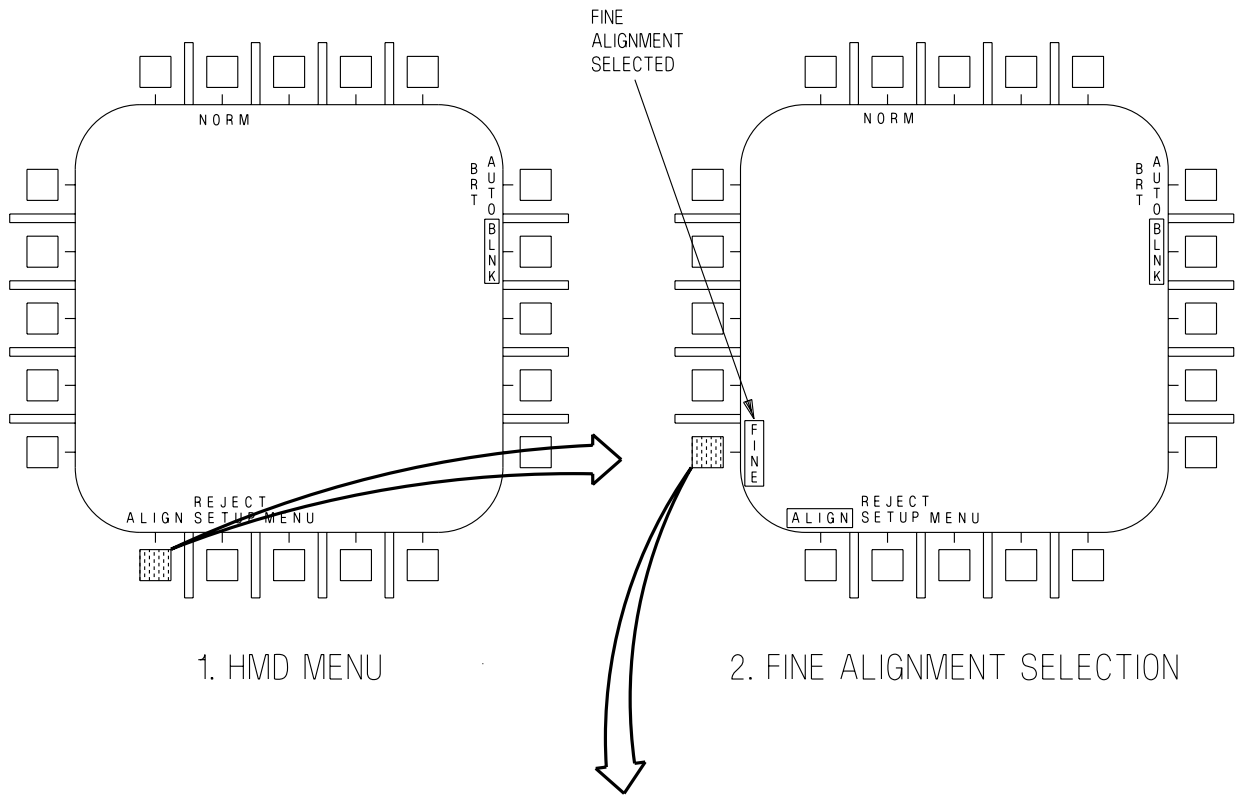

3. HUD AND HMD DISPLAYS

Figure 2-83. Fine Alignment (Sheet 1 of 2)

AHMD FINE ALIGNMENT

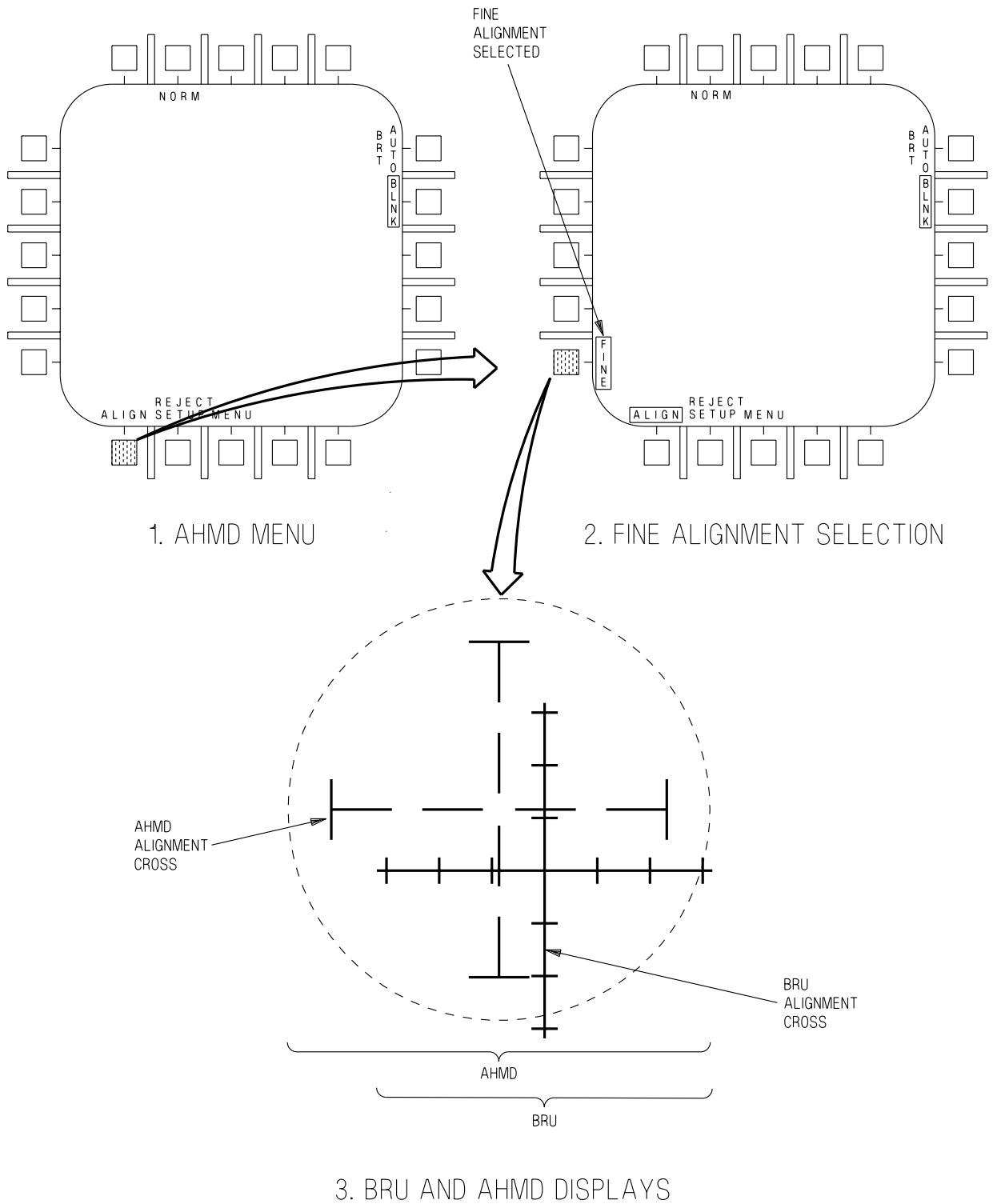

EFN520-384-2-016

Figure 2-83. Fine Alignment (Sheet 2 of 2)

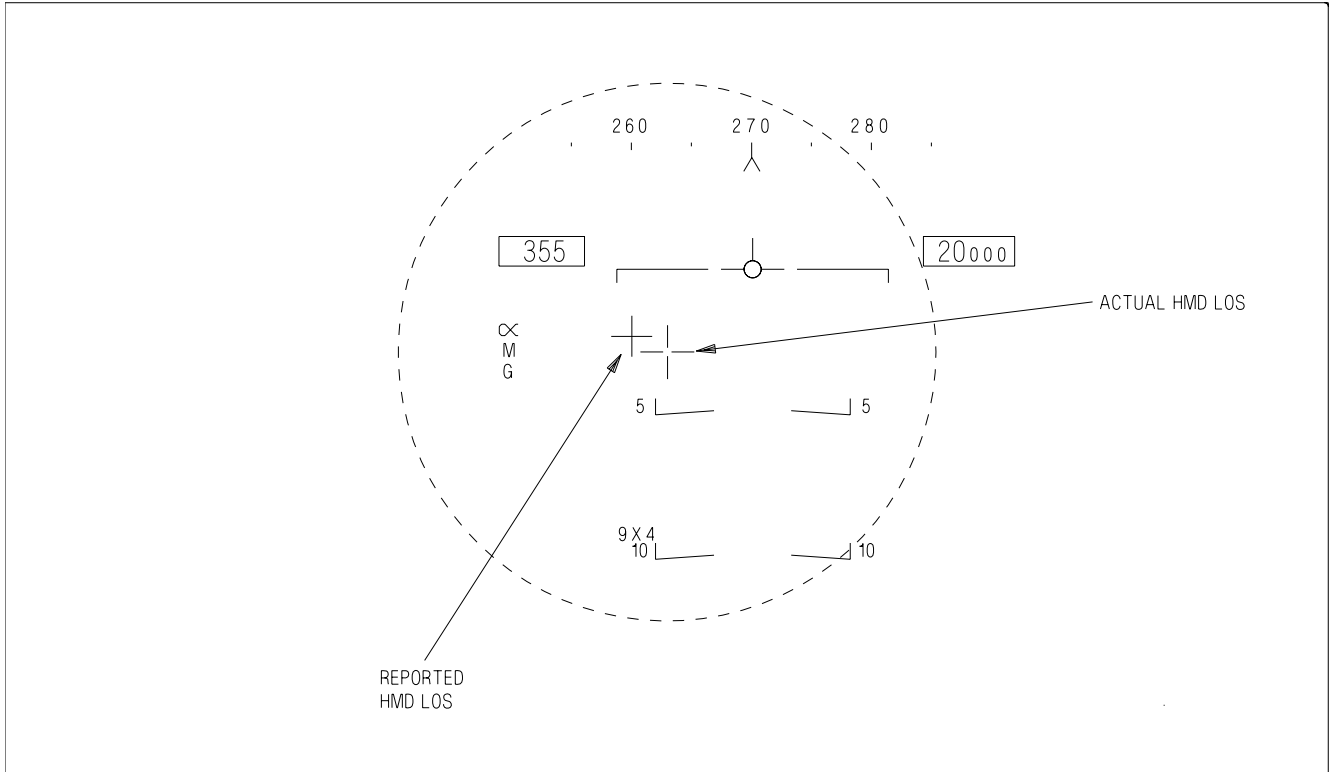

EFN520-385-1-005

Figure 2-84. Alignment Verification

2.23.17 Helmet Tracker Failure. If the EU reports that the helmet tracker is failed, or the helmet LOS is no longer valid, the MC discontinues slaving sensors and weapons to the HMD LOS. The MC replaces aircraft boresight for the helmet LOS to the radar and AIM-9, and deselects slaving for the A/A FLIR. Additionally, the MC removes any item from the HMD which is tied to the HMD LOS. The radar boresight and AIM-9 FOV symbol are restored to the HUD. The MC also restores VACQ mode and the HOTAS function to access the VACQ function. The MC continues to display information on the HMD which is not tied to the HMD LOS.

2.23.18 Helmet Not Installed. When the MC determines that the HMD is not on, or the EU is not responding to the MC via the mux bus, the MC reverts to the current no-helmet mechanization for slaving weapons, sensors, HOTAS, and HUD display.

CHAPTER 3

Servicing and Handling

3.1 SERVICING

Refer to A1-F18EA-NFM-600.

CHAPTER 4

Operating Limitations

4.1 LIMITATIONS OF THE BASIC AIRCRAFT

All operating limitations listed in this section are based on the following assumptions -

- 480 gallon EFTs are model -1013, -1015, or -1017
- F/A-18E aircraft LOT 23 and up, and F/A-18F aircraft LOT 23 and up, with SUU-79B/A wing pylons and AFC 315

4.1.1 Engine Operation Limitations. During normal engine operation, engine parameters (e.g., N_1 , N_2 , and EGT) are maintained within limits by the FADEC. See figure 4-1 for engine operation limitations.

Limitations		N_2 (%)	N_1 (%)	EGT (°C)	Nozzle (%)	Oil Press (psi)
Transient (MIL/MAX)		102	103	976	–	–
Steady state	MAX	100	100	952	50 to 100	80 to 150 (warm oil)
	MIL			932	0 to 45	
Ground IDLE		≥ 61	≥ 32	250 to 590	77 to 83	35 to 90 (warm oil)
Start		≥ 10	–	871	–	<ul style="list-style-type: none"> • Min 10 within 30 sec • 180 max after 2.5 min

Figure 4-1. Engine Operation Limitations

4.1.1.1 Engine Vibration Limitations. Engine vibration limitations are:

1. FAN VIB: 1.6 ips max
2. CORE VIB: 2.2 ips max

4.1.2 CG Limitations. 16.8 to 31.8% MAC

4.1.3 Airspeed Limitations. The airspeed limitations for the basic aircraft (with or without pylons) in smooth or moderately turbulent air with the landing gear retracted and flaps in AUTO are shown in figure 4-2. Subsystem related airspeed limitations are shown in figure 4-3.

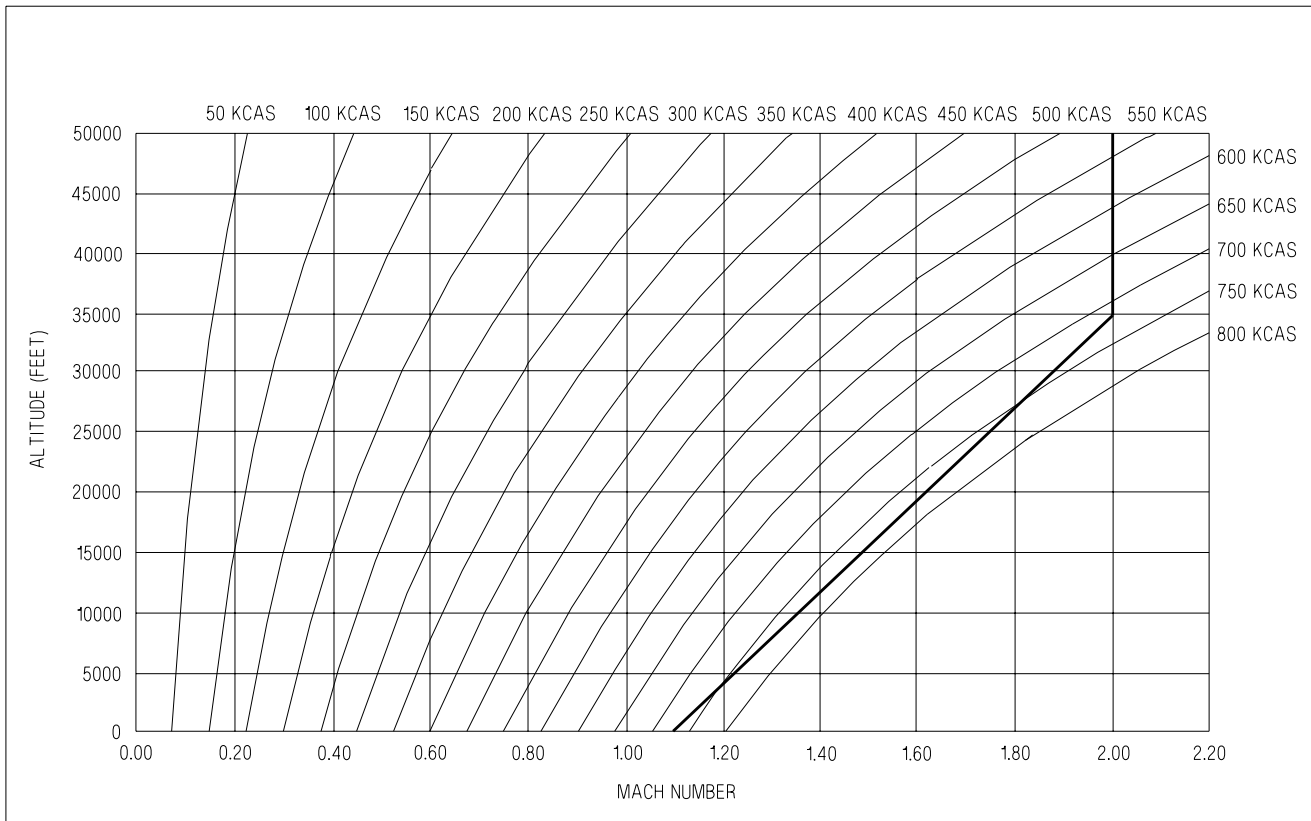

EFN520-218-1-001

Figure 4-2. Basic Aircraft Airspeed Limitations

Subsystem	Position/Action	Airspeed/Groundspeed
Refueling Probe	Extension/Retraction	300 KCAS
	Extended	400 KCAS
Landing Gear	Extension/Retraction/Extended	250 KCAS
	Emergency Extension	170 KCAS
Trailing Edge Flaps	HALF/FULL	250 KCAS
Tires	Nose Gear	195 KGS
	Main Gear	210 KGS
Wingfold	Spread/Fold	60 knots
Canopy	Open	60 knots

Figure 4-3. Subsystem Airspeed Limitations

4.1.4 Gross Weight and Lateral Weight Asymmetry Limitations. See figure 4-4 for gross weight and lateral weight asymmetry limitations.

Condition	GW Limit (lb)	Asymmetry Limit ¹ (ft-lb)
Field Takeoff/In Flight	66,000	29,000 ^{2,3} (FLY)
Field Landing/FCLP/T&G	50,600	33,000 ^{4,5} (LAND)
Catapult	66,000	29,000 ² (FLY) not to exceed 30,800 ^{4,5} (LAND)
Carrier Landing/Barricade	44,000	30,800 ^{4,5} (LAND)
1. FLY and LAND values for MC OFP H3E AND UP, if unavailable, calculate using notes 2-5. 2. Calculate using station 2-10 stores/pylons/external fuel. 3. Add internal wing fuel split with FUEL XFER caution. 4. Calculate using station 1-11 stores/pylons/external fuel. 5. Add internal wing fuel split.		

Figure 4-4. Gross Weight and Lateral Weight Asymmetry Limitations

NOTE

- Field landing/FCLP/T&G, and Carrier Landing/Barricade limits are ground loads limits and apply to touchdown only. All in-flight phases, including approach to landing must meet the in-flight lateral asymmetry restrictions in figure 4-4.
- Catapult limits are derived from both flying quality limits and ground load limits. Ensure neither limit is exceeded during catapult launch.

4.1.4.1 Lateral Weight Asymmetry Calculations. Field takeoff and in-flight lateral asymmetry is calculated by using the weight of asymmetric stores on stations 2 thru 10. Field landing events lateral asymmetry is calculated by using the weight of asymmetric stores on stations 1 thru 11. For catapult operations, lateral weight asymmetry is calculated for stations 1 thru 11 and stations 2 thru 10. For asymmetric catapult launch endspeed (asymmetric weight board designation) and catapult launch lateral trim calculations, use the asymmetry of stations 2 thru 10. For field takeoff and in-flight calculations, the weight of asymmetric internal wing fuel can be ignored unless the FUEL XFER caution is displayed due to asymmetric internal wing fuel. In addition, for catapult and landing events, all asymmetric internal wing fuel weight (regardless of FUEL XFER caution) is included due to landing gear structural load limitations.

With MC OFP H3E AND UP, lateral weight asymmetry is calculated by the MC and displayed on the CHKLST page. Two values are displayed, FLY and LAND, and indicate thousands of ft-lb. The values are displayed on the heavy side of the aircraft and it is possible that one value will be displayed on one side of the aircraft and the other value on the other side. The FLY value is calculated using the weight of asymmetric stores on stations 2 thru 10. The LAND value is calculated using the weight of

asymmetric stores on stations 1 thru 11. Both values include internal wing fuel imbalances regardless of FUEL XFER caution status. The values will flash when one fuel quantity is invalid or one weapon station indicates HUNG and the values will be removed if more than one fuel quantity is invalid, and/or weapon station indicates HUNG.

The FLY value is used for field takeoff, catapult, and in flight. The LAND value is used for landing events or catapult. For asymmetric catapult launch endspeed (asymmetric weight board designation) and catapult launch trim calculations, use the FLY value. In flight, it is possible for the FLY value to exceed the value in figure 4-4 due to small fuel imbalances. A manual lateral asymmetry calculation should be performed in accordance with figure 4-4. If AOA TONE caution is present and/or lateral weight asymmetry calculations are flashing, calculate aircraft lateral asymmetry manually.

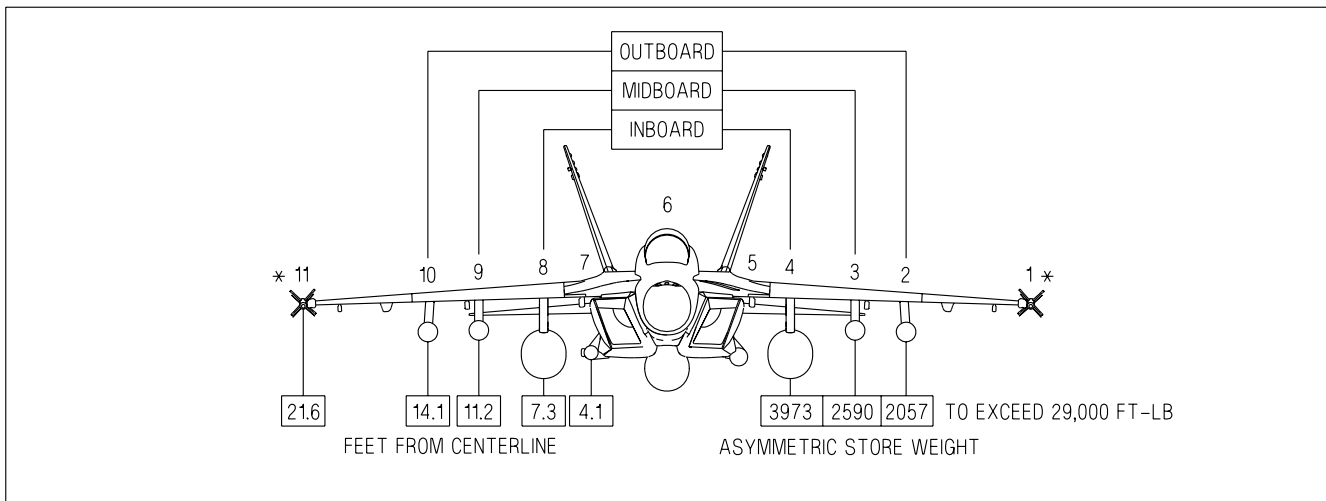

EFN520-371-1-015

* The weight of an asymmetric missile or pod on stations 1 or 11 is not to be included in asymmetry limitations calculations for field takeoff or in flight, but is included in landing events lateral weight asymmetry calculations. For catapult operations, lateral asymmetry must be calculated for stations 1 thru 11 and stations 2 thru 10.

Figure 4-5. Asymmetric Stores Limitations

NOTE

- If a FUEL XFER caution is displayed **and** the internal wing tanks are unbalanced, the weight of asymmetric internal wing fuel must be used in calculating total weight asymmetry in all phases of flight. Completely split internal wing tanks (one full and one empty) have the potential of reaching 14,000 ft-lb of lateral weight asymmetry.
- The following is a rule of thumb for calculating internal wing tank asymmetry: pounds of fuel split x 10 (e.g., a 200 pound fuel split equates to approximately 2,000 ft-lb of asymmetry).
- With a symmetrically loaded aircraft, release of any single store, with the exception of a full midboard 480 gallon tank, will not exceed the lateral weight asymmetry limitations. Release of dissimilar stores in the normal SMS release sequence may exceed the lateral weight asymmetry limitation.

4.1.5 AOA Limitations - Flaps AUTO. Refer to figure 4-6 for AOA limitations with flaps in AUTO.

4.1.5.1 AOA Limit Display. With MC OFP H3E AND UP, the current positive AOA limit is displayed on the CHKLST page. The limit is displayed below the aircraft and only when a limit exists. For every set of positive/negative AOA limits, only the positive AOA limit is displayed. The AOA limit will be removed if the FLY lateral weight asymmetry value is removed. The AOA limit of 14° will be displayed with flaps in HALF or FULL regardless of the lateral weight asymmetry AOA limit.

AOA Limitations - Flaps AUTO ¹			
Lateral Weight Asymmetry (1,000 ft-lb)	Subsonic		Supersonic
≤ 6	Unrestricted		Unrestricted (> +15° Half lateral stick or half rudder pedal inputs only)
> 6 to ≤ 8			
> 8 to ≤ 12	Low or Slow (≤ 20k ft or ≤ 250 KCAS) Unrestricted	High and Fast (> 20k ft and > 250 KCAS) ≤ +30°	-6 to +15° and Single axis inputs only ²
> 12 to ≤ 29	-6 to +15° and Single axis inputs only ²		

Notes:

- (1) Rolling maneuvers up to abrupt, full stick (full stick in less than 1 second) are authorized within the AOA and acceleration limitations specified in figure 4-7.
- (2) In “Single axis inputs only” regions, avoid rolling or yawing the aircraft while changing longitudinal stick position. It is acceptable to pull, stop, then roll or to pull and counter any roll-off induced by the heavy wing under g.
- (3) With MC OFP H3E AND UP, AOA tone in flaps AUTO is based on the limits in this figure and computed lateral asymmetry. The tone indicates that the AOA lateral asymmetry limit has been exceeded. AOA shall be reduced to stay within the limits of figure 4-6.

Figure 4-6. AOA Limitations - Flaps AUTO

4.1.6 Acceleration Limitations. With flaps in AUTO, the acceleration limitations for the basic aircraft (with or without empty pylons) in smooth air with the landing gear retracted are shown in figure 4-7. In moderate turbulence, reduce deliberate accelerations 2g below that shown in figure 4-7 to minimize the potential of an aircraft over-g.

Acceleration limits during landing gear extension/retraction, or with landing gear extended, are 0.0 to +2.0g (symmetrical) and +0.5 to +1.5g (rolling).

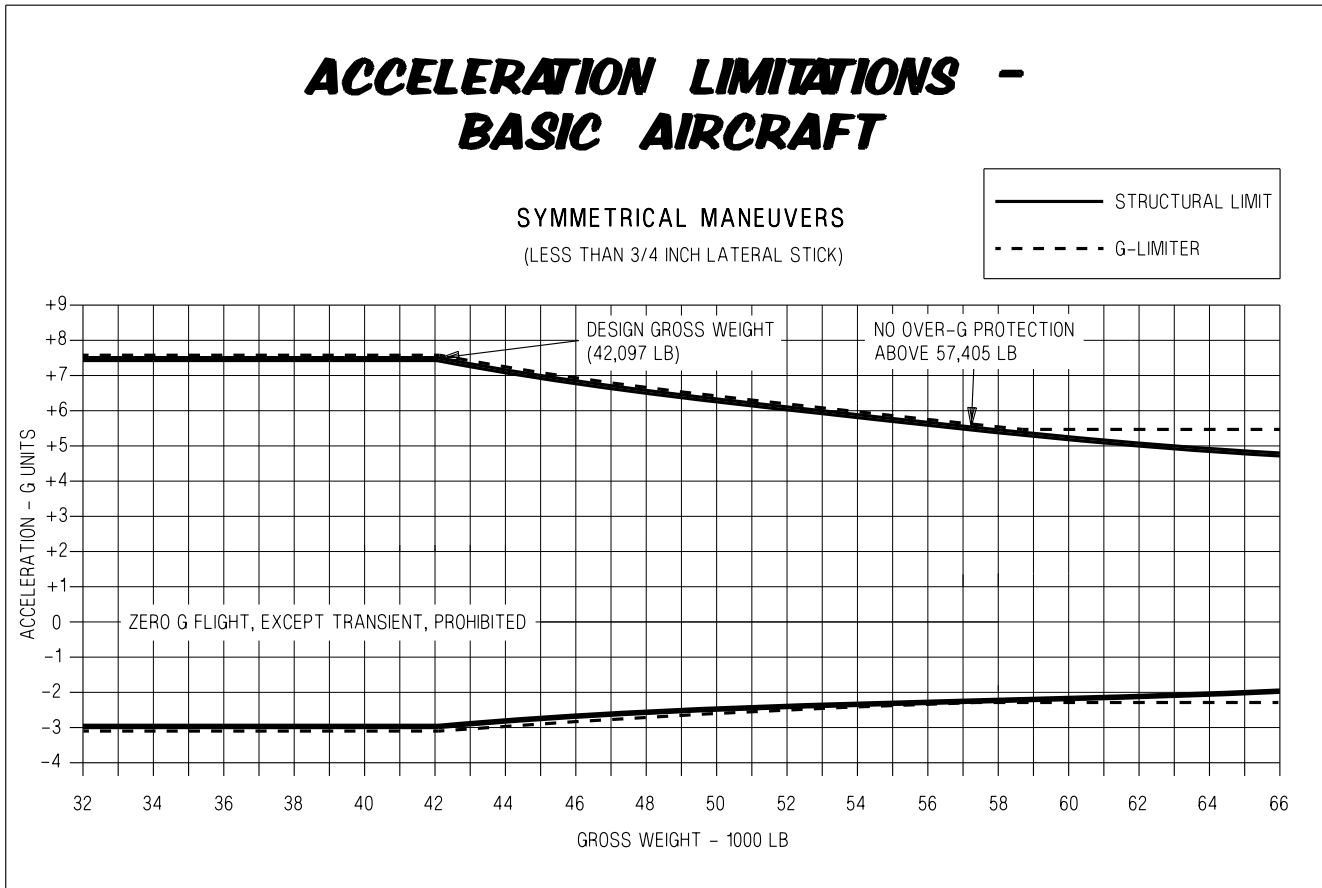

NOTES

1. At any specific gross weight, the G-limiter will attempt to limit command g to the levels shown above, up to 57,405 lb GW. Above 57,405 lb GW, the G-limiter is fixed at +5.5.
2. Overshoots up to +0.5g or -0.2g do not constitute an over-g.
3. Above 57,405 lb, an over-g will occur if the pilot solely relies on the G-limiter.
4. The aircraft structural carriage g envelope is based on the product of the maximum normal acceleration limits of +7.5g and -3.0g at a weight of 42,097 lb. As aircraft gross weight increases above 42,097 lb, Nz must be decreased so that the maximum NzW allowable is not exceeded. Refer to sheet 3 for an example of NzW correction for these calculations. Nz limits less than +2.0 and -2.0 need not be corrected for NzW.
5. See External Stores Limitations, A1-F18EA-TAC-020 (NWP 3-22.5-F/A18E/F VOL. IV) for additional acceleration limitations which may apply when carrying stores. Unless otherwise noted, Nz store limitations are based on an aircraft gross weight of 42,097 lb. As aircraft gross weight increases above 42,097 lb, Nz must be decreased so that the maximum NzW allowable is not exceeded. Refer to sheet 3 for an example of NzW correction for these calculations. Over-g protection is not provided by the G-limiter for additional Nz restrictions due to store carriage. Over-g due to store limitations will not trigger an over-g MSP code but aircraft over stress may result. Additional store restrictions should be closely monitored by aircrew. Nz limits between +2.0 and -2.0 need not be corrected for NzW.

**Figure 4-7. Acceleration Limitations - Basic Aircraft
(with or without empty pylons) (Sheet 1 of 3)**

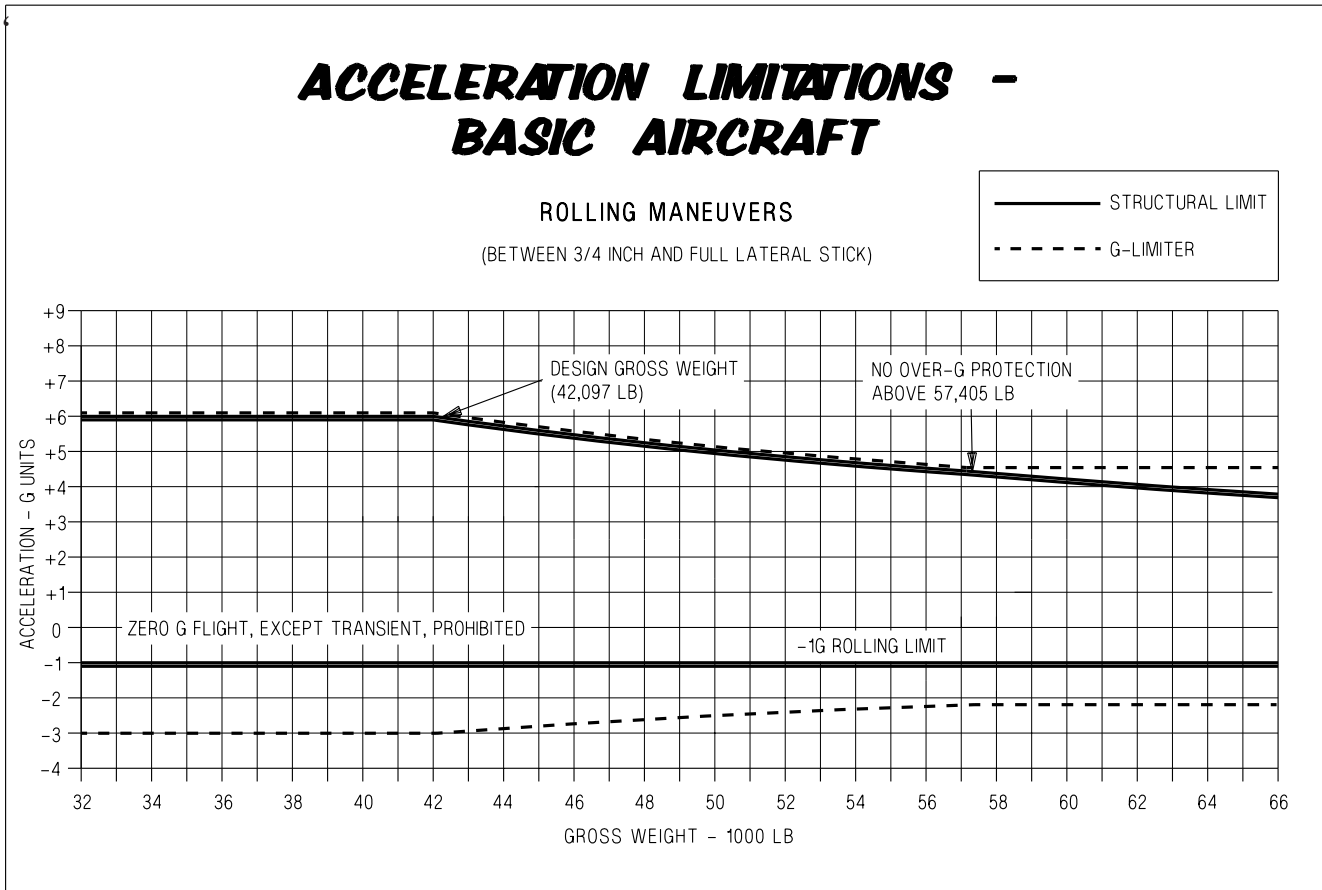

EFN520-212-2-018

NOTES

1. At any specific gross weight, the G-limiter will attempt to limit command positive g to the levels shown above, up to 57,405 lb GW with lateral stick inputs. Above 57,405 lb GW, the G-limiter is fixed at +4.4. For negative rolling maneuvers beyond -1 g, the G-limiter will not reduce command g in response to lateral stick input. Negative load factor when rolling shall be closely monitored.
2. G-limiter overshoots up to +0.5g or -0.2g do not constitute an over-g.
3. Above 57,405 lb, an over-g will occur if the pilot solely relies on the G-limiter.
4. The aircraft structural carriage g envelope is based on the product of the maximum normal acceleration limits of +7.5g and -3.0g at a weight of 42,097 lb. As aircraft gross weight increases above 42,097 lb Nz must be decreased so that the maximum NzW allowable is not exceeded. Refer to sheet 3 for an example of NzW correction for these calculations. Nz limits between +2.0 and -2.0 need not be corrected for NzW.
5. See External Stores Limitations, A1-F18EA-TAC-020 (NWP 3-22.5-F/A18E/F VOL. IV) for additional acceleration limitations which may apply when carrying stores. Unless otherwise noted, Nz store limitations are based on an aircraft gross weight of 42,097 lb. As aircraft gross weight increases above 42,097 lb, Nz must be decreased so that the maximum NzW allowable is not exceeded. Refer to sheet 3 for an example of NzW correction for these calculations. Over-g protection is not provided by the G-limiter for additional Nz restrictions due to store carriage. Over-g due to store limitations will not trigger an over-g MSP code but aircraft over stress may result. Additional store restrictions should be closely monitored by aircrew. Nz limits between +2.0 and -2.0 need not be corrected for NzW.

**Figure 4-7. Acceleration Limitations - Basic Aircraft
(with or without empty pylons) (Sheet 2)**

ACCELERATION LIMITATIONS - BASIC AIRCRAFT

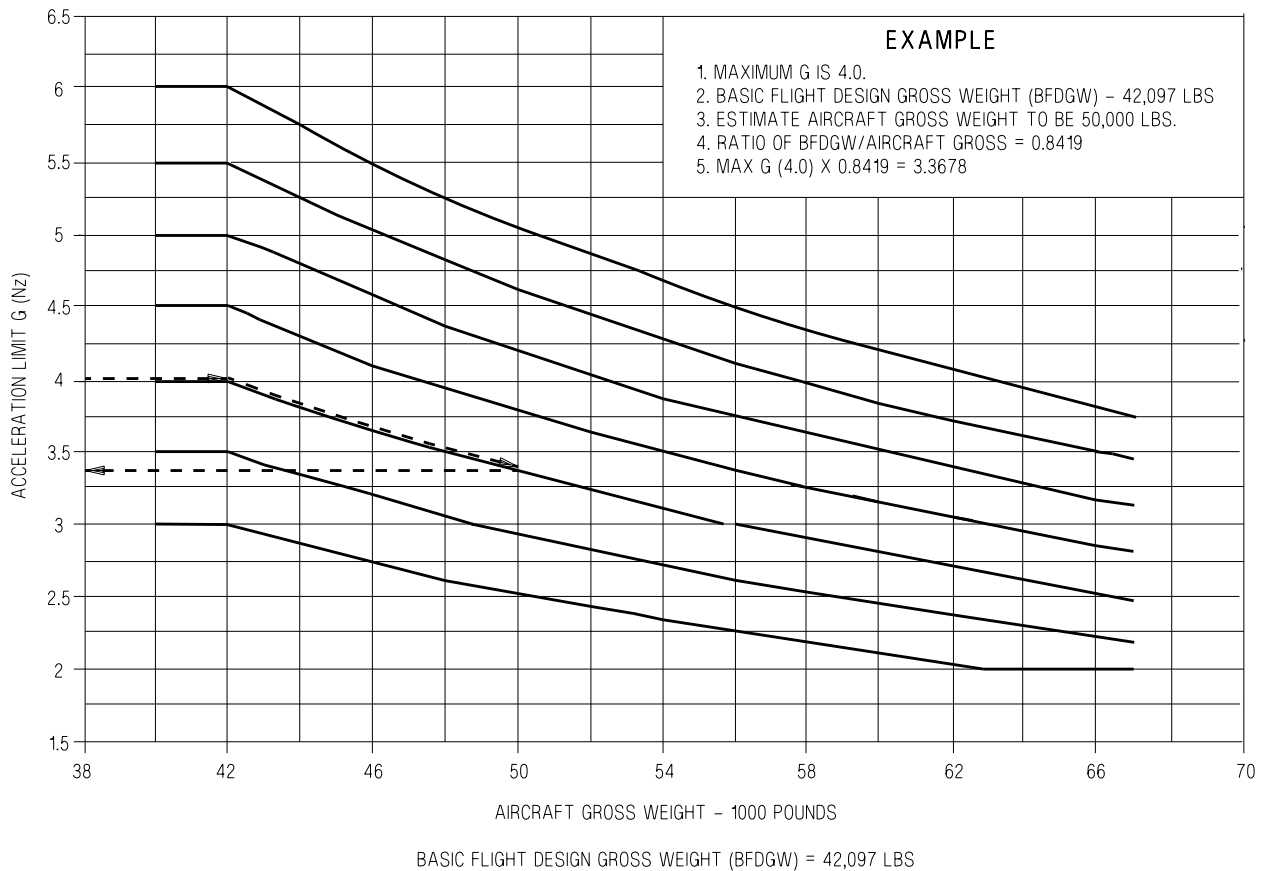

**Figure 4-7. Acceleration Limitations - Basic Aircraft
(with or without empty pylons) (Sheet 3)**

EFN520-212-3-010

4.1.7 Limitations with Flaps HALF or FULL. Refer to figure 4-8 for flaps limitations when HALF or FULL.

Parameter		Limitation
AOA		0 to 14° (AOA tone) (1)
Bank angle		90° max 15° max during flap selection (HALF or FULL from AUTO) with a HI AOA advisory
Acceleration	Symmetrical	0.0 to +2.0g
	Rolling	+0.5 to +1.5g
NOTE: 1. Transitory excursions above 14° may be seen during catapult launch.		

Figure 4-8. Limitations with Flaps HALF or FULL

4.1.8 Refueling Limitation. Maximum refueling pressure, inflight or on the ground, is 55 psi.

4.1.9 Prohibited Maneuvers.

Environmental -

1. Flight in lightning or thunderstorms.

Systems -

1. Takeoff with a FADEC DEGD indication (dual channel line outs).
2. Takeoff with a FCS A or FCS B DEGD.
3. Pulling any FCS circuit breaker inflight except as directed by NATOPS.
4. Use of RALT mode below 500 feet AGL.
5. Use of the auto sever/redeployment function of the ALE-50.
6. Landing with autopilot modes engaged except for the following:
 - a. Mode 1 ACL.
 - b. Field landings with FPAH/ROLL.
7. Takeoffs and landings while using any laser eye protection (LEP) devices.

8. Selection of MAN with the ECS MODE switch.

WARNING

Selection of MAN with the ECS MODE switch while the aft cooling fan shutoff valve is open may cause the fan to overspeed resulting in a catastrophic fan failure potentially leading to loss of OBOGS.

9. Flight in RVSM controlled airspace with any of the following:
 - a. Mach > 0.92
 - b. AOA > 15°
 - c. Load factor > 2g
 - d. Initial engagement of BALT when above Mach 0.90
 - e. BALT not engaged when level at assigned altitude (During formation flight, BALT engagement is only required by the flight leader.)
 - f. Refueling probe extended
 - g. GAIN ORIDE selected
 - h. Suspected AOA or pitot-static probe damage (e.g., birdstrike, refueling basket strike)
 - i. Baro altitude displayed with an "X"
10. In-flight Memory Inspect (MI) of FCC (UNIT 14 or 15) addresses (ADDR) greater than six digits long.

WARNING

In-flight Memory Inspect (MI) of FCC (UNIT 14 or 15) addresses (ADDR) greater than six digits long may cause all four FCC channels to shut down which will result in loss of aircraft control.

Departure/Spin -

1. Zero airspeed tailslides.
2. Intentional departures/spins.
3. Yaw rates over 40° second (yaw tone).
4. Holding roll inputs (lateral stick or rudder pedal) past 360° of bank angle change.
5. Inflight selection of RCVY on the SPIN switch.

WARNING

Selection of manual spin recovery mode (SPIN switch in RCVY) seriously degrades controllability and prevents recovery from any departure or spin.

Fuel and Engine Oil -

1. Zero g except transient (over 2 seconds between +0.2 and -0.2g).
2. Negative g for more than 10 seconds (30 seconds required between negative g maneuvers).

Loads -

1. Field full stop, FCLP, or T&G with lens settings greater than 3.25°.
2. Carrier arrestment or T&G with lens settings greater than 4.0°.
3. Pushing beyond -1g above 700 KCAS and below 10,000 feet MSL.
4. Holding lateral stick inputs past 180° of bank angle change when pushing between 0.0 and -1.0g.
5. Abrupt, full aft stick inputs (full aft stick in less than 0.5 seconds) with less than 3,500 pounds of fuel.
6. AUX release of external fuel tanks or aerial refueling store.
7. **Lateral and directional trim limitations.** Use of lateral and/or directional trim in combination with lateral stick inputs above certain airspeeds may result in the exceedance of aircraft structural load limitations. Following are four conditions that require trim due to aircraft imbalance and their associated limitations. These limitations are in addition to existing limitations for the basic aircraft and any store peculiar limitation. Air to ground limitations are for any configuration with a wing EFT or wing carried air to ground store.

Condition A: Roll off tendency > 5°/sec without lateral trim or
FLIR pod loading only on one side of the aircraft without a centerline 480 EFT

Condition B: Lateral weight asymmetry for air-to-air weapons > 6,000 ft-lb and ≤ 14,000 ft-lb

Condition C: Lateral weight asymmetry for to air-to-ground weapons > 6,000 ft-lb and ≤ 29,000 ft-lb

Condition D: Lateral weight asymmetry for to air-to-air weapons > 14,000 ft-lb

Flight Restrictions	A	B	C	D
Airspeed > 500KCAS Symmetric Nz = -1.2 to +7.5g	X	X	X	X
Airspeed > 600 KCAS or IMN > 1.1 below 24,000 ft MSL Airspeed > 500 KCAS above 24,000 ft MSL 1/2 Lateral Stick Deflection	X	X		
Airspeed > 600 KCAS or IMN > 1.05 non-abrupt 1/2 lateral stick deflections			X	
All airspeeds except for powered approach, 1/2 lateral stick input				X

These limitations assume that the aircraft is configured with ECP 6171 or IAFC 362 (aft fuselage stiffener).

Without this modification there are additional limitations that are defined below:

Configuration	Restriction
For aircraft with asymmetry due to air to air weapons \leq 8,000 ft-lb	IMN between 0.9 and 1.04 Symmetric Nz = -3.0 to +7.5g Asymmetric Nz = -1.0 to +5.0g
For aircraft with roll off tendency $>5^\circ$ /sec without lateral trim For aircraft with a FLIR pod only on one side of the aircraft without a centerline tank For aircraft with lateral weight asymmetry $>$ 8,000 ft-lb due to air-to-air stores For aircraft with lateral weight asymmetry $>$ 6,000 ft-lb due to air-to-ground stores	IMN between 0.9 and 1.04 Symmetric Nz = -3.0 to +5.0g Asymmetric Nz = -1.0 to + 1.5g

8. Any rudder input when aircraft load factor is less than -1.2g.

Flutter -

1. Flight without LAU-127 wingtip launcher rails. The launchers on both stations 1 and 11 shall be either: (a) LAU-127A/A or B/A (with power supply and nitrogen bottle installed), or (b) LAU-127C/A (with power supply and High Pressure Pure Air Generator (HiPPAG) unit installed).

Flying Qualities -

1. Single-ship takeoffs with 90° crosswind component over 30 knots.
2. Section takeoffs with any of the following conditions:
 - a. 90° crosswind component over 15 knots.
 - b. Asymmetric loading over 9,000 ft-lb not including wingtip missiles or pods.
 - c. Dissimilar loading except pylons, FLIR, LDT, fuselage missiles, wingtip missiles or pods, CVERS, MERS, or TERS.
3. Flight with GAIN ORIDE selected above 10° AOA or above 350 KCAS (flaps AUTO), 200 KCAS (flaps HALF), or 190 KCAS (flaps FULL).

WARNING

With GAIN ORIDE selected (fixed FCS gains), the aircraft is uncontrollable above approximately 450 KCAS.

4. Single-ship landings with 90° crosswind component over 30 knots.
5. Section landings with 90° crosswind component over 15 knots.
6. Aerobraking on landing rollout with crosswind greater than 5 knots, pitch attitude greater than 10° , airspeed less than 80 KCAS, GAIN ORIDE selected, FCS AIR DAT caution or FLAP SCHED caution.

4.2 EXTERNAL STORES LIMITATIONS

External stores limitations for external fuel tanks are provided in figures 4-9 thru 4-11. Figure 4-12 contains Air Refueling Store Carriage Limits. Figures 4-9 thru 4-12, in conjunction with the Tactical Manual, A1-F18EA-TAC-020 (NWP 3-22.5-F/A18E/F Vol IV) define the stores limitations for all (external fuel tanks and other) external stores. Only those pylons and stores shown in the Tactical Manual may be carried and/or released.

LIMITATIONS (weight/tank)		Fuel in Tank	
		>500 lb	≤ 500 lb
Airspeed (KCAS/IMN)		LON	
Load Factor (g)	Symmetrical	LON	LON
	Rolling	LON (1)	
Lateral Stick Deflection		LON (1)	LON
Rudder		LON	
Field Landing, FCLP, T&G, Field Arrest		Any fuel state	
Catapult		Less than or equal to 100 lb or greater than 2,700 lb	
Carrier Arrestment, Carrier T&G		Less than or equal to 800 lb	
<p>NOTE: 1. Lateral stick inputs are restricted to checks to neutral only to terminate rolls. Abrupt full lateral stick deflection authorized for roll initiation.</p>			
<p>Simplified Limitations Schematic</p>  <p style="text-align: right;">EFN520-410-1-010</p>			

Figure 4-9. Station 6 480-Gal External Fuel Tank Carriage Limits

SUU-79B/A (Rev B) Wing Pylons, AFC-315 to Lot 22 aircraft			
LIMITATIONS (weight/tank)		Fuel in Tank	
		>500 lb	≤ 500 lb
Airspeed (KCAS/IMN)		635/1.6 above 15,000 ft MSL 570 KCAS at or below 15,000 ft MSL	635/1.6
Load Factor (g)	Symmetrical	LON at or below 500 KCAS -3.0 to +6.0 from 500 KCAS up to 550 KCAS -1.0 to +4.0 above 550 KCAS (1)	LON
	Rolling	LON (rolling) at or below 400 KCAS -1.0 to +2.0 above 400 KCAS and below 470 KCAS (1) +1.0 to +2.0 above 470 KCAS (1)	
Lateral Stick Deflection	At or below 15,000 ft MSL	LON at or below 470 KCAS Smooth inputs of up to 3/4 inches above 470 KCAS	
	Above 15,000 ft MSL	LON at or below 570 KCAS Smooth inputs of up to 3/4 inches above 570 KCAS	
Rudder		Smooth inputs above 500 KCAS	
Field Landing, FCLP, T&G, Field Arrest		Any fuel state	
Catapult		Less than or equal to 100 lb or greater than 2,700 lb	
Carrier Arrestment, Carrier T&G		Less than or equal to 800 lb	
NOTE: 1. Nz restriction due to carriage of 480 EFT need not be corrected for an aircraft weight greater than 42,097 lb (NzW).			
Simplified Limitations Schematic			
			
EFN520-411-1-010			
		> 500 lb Fuel	≤ 500 lb Fuel
		<ul style="list-style-type: none"> • Max Airspeed 570 KCAS/1.6 IMN • LON at or below 400 KCAS • Single Axis Control inputs above 400 KCAS (roll then pull) • 4g Max above 500 KCAS 	<ul style="list-style-type: none"> • Max Airspeed 635 KCAS/1.6 IMN
<p>Note: The simplified limitations are presented as a rule-of-thumb for ease of memorization. The actual NATOPS limits are shown in the upper portion of the table.</p>			

Figure 4-10. Station 4/8 480-Gal External Fuel Tank Carriage Limits (Rev B Pylons)

SUU-79A/A (Rev A) Wing Pylons			
LIMITATIONS (weight/tank)		Fuel in Tank	
		>500 lb	≤ 500 lb
Airspeed (KCAS/IMN)		550/1.6 above 15,000 ft MSL 520 KCAS at or below 15,000 ft MSL	600/1.3 without FLIR Pod 570/1.3 with FLIR Pod
Load Factor (g)	Symmetrical	-3.0 to +3.0 at or below 475 KCAS 0 to +2.0 above 475 KCAS (1)	LON
	Rolling	-1.0 to +2.0 at or below 325 KCAS 0 to +2.0 above 325 KCAS (1)	
Lateral Stick Deflection		LON at or below 225 KCAS Half between 225 and 325 KCAS Smooth inputs of up to 3/4 inches above 325 KCAS	LON without FLIR Pod Smooth inputs of up to 3/4 inches above 550 KCAS with FLIR Pod
Rudder		Smooth inputs above 500 KCAS	
Field Landing, FCLP, T&G, Field Arrest		Any fuel state	
Catapult		Less than or equal to 100 lb or greater than 2,700 lb	
Carrier Arrestment, Carrier T&G		Less than or equal to 800 lb	
NOTE:			
1. For load factor restrictions resulting in an aircraft envelope less than or equal to 2.5 g for symmetric and 2.0 g for rolling, no further reduction in load factor is required as a result of aircraft weight being greater than basic flight design gross weight.			
Simplified Limitations Schematic			
			
EFN520-412-1-010			
> 500 lb Fuel		≤ 500 lb Fuel	
<ul style="list-style-type: none"> • Max Airspeed 520 KCAS/1.6 IMN • Navigational Turns Only (Ferry Jet or Tanker) 		<ul style="list-style-type: none"> • Max Airspeed 570 KCAS/1.3 IMN • LON up to 550 KCAS 	
<p>Note: The simplified limitations are presented as a rule-of-thumb for ease of memorization. The actual NATOPS limits are shown in the upper portion of the table.</p>			

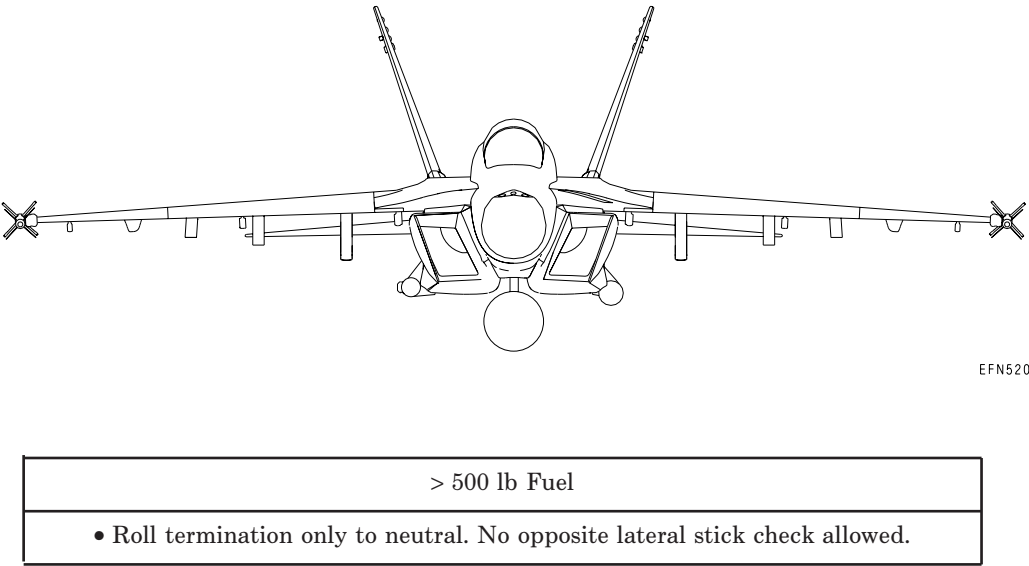
Figure 4-11. Station 4/8 480-Gal External Fuel Tank Carriage Limits (Rev A Pylons)

LIMITATIONS (weight/tank)		Station 6 ARS Stowed and feathered	Station 6 ARS, Station 3/4/8/9 480-Gal Carriage (5-wet)(1)
Altitude (ft MSL)		0 to 40,000	
Airspeed (KCAS/IMN)		575/0.92	430/0.8 (2)
Load Factor (g)	Symmetrical	LON	-1.0 to +4.0 (3)
	Rolling		-1.0 to +3.0 (3,4)
Lateral Stick Deflection		Full with any air to ground store or an EFT on any wing station (roll limiting on); otherwise Half (6)	Simultaneously large and abrupt multi-axis inputs prohibited (4,5)
Rudder		LON	
Angle of Attack		LON	Flaps AUTO: -6° to + 15° Flaps HALF or FULL: LON
Field Landing, FCLP, T&G, Field Arrest		Any fuel state	
Catapult		≤ 100 lb or > 1,700 lb fuel	ARS: ≤ 100 lb or > 1,700 lb fuel 480-gal EFT: ≤ 100 lb or > 2,700 lb fuel
Carrier Arrestment, Carrier T&G		≤ 500 lb fuel	ARS and/or Station 3/9 480-gal EFT: ≤ 500 lb fuel Station 4/8 480-gal EFT: ≤ 800 lb fuel
<p>NOTES:</p> <ol style="list-style-type: none"> SUU-79 B/A (Rev B) Wing Pylons, AFC-315 to Lot 22 aircraft. Abnormal wing tank fuel transfer sequence: If fuel is transferred (because of a failure condition) from Station 4/8 tanks before the Station 3/9 tanks are empty, then airspeed limit is 300 KCAS/0.6 IMN, whichever is less. Nz is based on an aircraft GW of 66,000 lb. When aircraft gross weight is greater than 66,000 lb, reduce symmetric load factor allowable to -0.5 to +3.5 and rolling load factor allowable to -0.5 to +2.5 Lateral stick input is restricted to half when the fuel in Station 3/9 is greater than 1,600 lb/tank. This restriction is not applicable when in power approach configuration. Large is defined as greater than half maximum input. Abrupt is defined as a control input rate of maximum deflection in less than 1 second. Multi-axis is defined as simultaneous longitudinal, lateral, or directional control inputs. A multi-axis input is allowed as long as it is not large and abrupt. Half lateral stick displacement restriction does not apply when in power approach configuration. 			

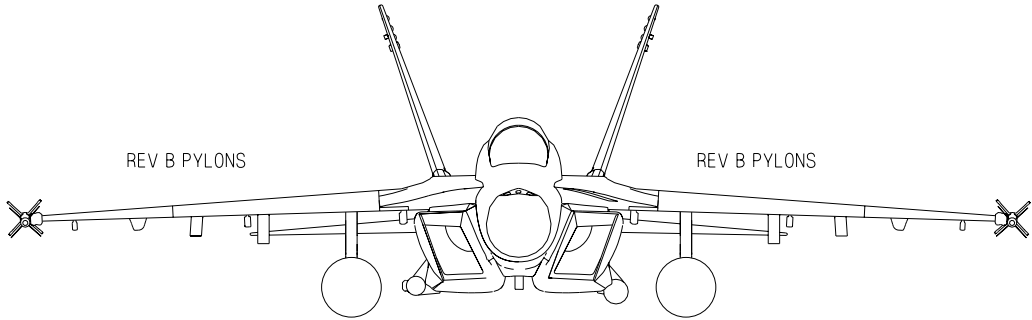
Figure 4-12. Air Refueling Store Carriage Limits

4.2.1 ARS Limitations

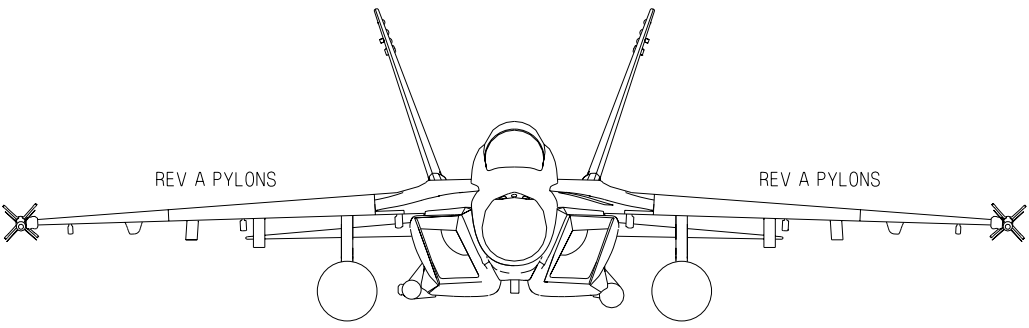
1. ARS operating limitations are listed in figure 4-13.

Condition	Limitation (P/N 31-301-48310-2)	Limitation (P/N 31-301-48310-3)	
		Station 4/8 (3 wet)	Station 3/4/8/9 (5 wet)
EFT loading	Station 4/8 only (3 wet)	Station 4/8 (3 wet)	Station 3/4/8/9 (5 wet)
Altitude	0 to 35,000 feet MSL		
Power on (RAT unfeathered)	180 to 300 KCAS		
Hose extension	180 to 250 KCAS	180 to 275 KCAS	180 to 250 KCAS (<5,000 feet MSL)
			180 to 260 KCAS (5,000 to 10,000 feet MSL)
			180 to 275 KCAS (>10,000 feet MSL)
Hose extended	180 to 300 KCAS/0.80 IMN max		
Fuel transfer to receiver	180 to 300 KCAS/ 0.80 IMN max	225 to 300 KCAS/0.80 IMN max	
Hose retraction	180 to 200 KCAS (<25,000 feet MSL) 180 to 210 KCAS (≥25,000 feet MSL)	180 to 275 KCAS	180 to 250 KCAS (<5,000 feet MSL)
			180 to 260 KCAS (5,000 to 10,000 feet MSL)
			180 to 275 KCAS (>10,000 feet MSL)

Figure 4-13. ARS Operating Limitations (Sheet 1 of 2)

2. Prohibited maneuvers with ARS installed:

- a. Placing the LTD/R switch to ARM.
- b. Afterburner operation with the hose extended.

3. ARS carriage limitations are listed in figure 4-12.

4. ARS operating limitations for P/N 31-301-48310-4 and -5 are as follows:

Condition	Limitation (P/N 31-301-48310-4/5)	
EFT loading	Station 4/8 (3 wet)	Station 3/4/8/9 (5 wet)
Altitude	0 to 35,000 feet MSL	
Power on (RAT unfeathered)	220-300 KCAS	
Hose extension/ retraction	180 to 275 KCAS (<5,000 feet MSL)	180 to 250 KCAS (<5,000 feet MSL)
	190 to 275 KCAS (5,000 to 7,500 feet MSL)	190 to 260 KCAS (5,000 to 7,500 feet MSL)
	200 to 275 KCAS (7,501 to 10,000 feet MSL)	200 to 260 KCAS (7,501 to 10,000 feet MSL)
	200-275 KCAS 10,001 to 15,000 feet MSL	
	220-275 KCAS 15,001 to 35,000 feet MSL	
Hose extended	180 to 300 KCAS/0.80 IMN max	
Fuel transfer to receiver	180 to 300 KCAS/0.80 IMN max (<5,000 feet MSL)	
	190 to 300 KCAS/0.80 IMN max (5,000 to 7,500 feet MSL)	
	200 to 300 KCAS/0.80 IMN max (7,501 to 15,000 feet MSL)	
	220 to 300 KCAS/0.80 IMN max 15,001 to 35,000 feet MSL	

Figure 4-13. ARS Operating Limitations (Sheet 2)

5. Prohibited maneuvers with ARS installed:
 - a. Placing the LTD/R switch to ARM.
 - b. Afterburner operation with the hose extended.
6. ARS carriage limitations are listed under External Stores Limitations.

4.2.2 ATFLIR Limitations

1. These limits are ATFLIR specific, apply to any ATFLIR configuration without inboard 480 gallon tanks, and do not pertain to asymmetric loads. ATFLIR limitations are listed in figure 4-14.

WARNING

Failure to use eye protection when firing the LASER may result in severe eye damage and possible blindness.

ATFLIR Limitations							
Altitude		< 10,000 feet MSL			Between 10,000 and 18,000 feet MSL		> 18,000 feet MSL
Airspeed (KCAS)		< 550	Between 550 and 600	> 600	< 550	> 550	LON
Nz (g's)	Symmetric	LON	-3.0 to +7.0	-1.0 to 4.0	LON	-3.0 to 7.0	LON
	Rolling	LON	-1.0 to +4.0	(1)	LON		
NOTE:							
1. Smooth inputs up to ¾ inch deflection for navigational turns or as required to maintain roll attitude.							

Figure 4-14. ATFLIR Limitations

4.3 OPERATING LIMITATIONS (LOT 21)

4.3.1 Prohibited Maneuvers

Systems -

1. Flight in RVSM controlled airspace.

4.4 AESA RADAR LIMITATIONS

Flight testing of the AN/APG-79 AESA radar has shown that this system can interfere with, and significantly degrade the performance of, various precision approach systems including PAR and ACLS. Aircrew operating AN/APG-79 AESA equipped aircraft shall be aware that directing AN/APG-79 AESA transmissions toward landing facilities (ship or shore) may cause strong electromagnetic interference (EMI) affecting the safety of aircraft on approach. To the maximum extent possible, aircrew shall avoid directing AN/APG-79 AESA radar transmissions towards facilities with an operating active PAR or ACLS (shipboard or shore-based). Unless specifically authorized for operational necessity or required for safety of flight, aircrew should cease AN/APG-79 AESA radar transmissions whenever operating within 10 nm of PAR and ACLS facilities during IMC/Case III conditions.

WARNING

- AN/APG-79 AESA radar transmissions specifically directed towards an operating PAR or ACLS within 10 nm have caused strong electromagnetic interference (EMI) with these radar-based systems and caused intermittent, unannounced anomalies that resulted in erroneous azimuth/glideslope commands being sent to aircraft on precision approach, increasing the risk of controlled flight into terrain (CFIT). Proper flight instrument crosscheck using all available means (TACAN, DME, and RADALT) is essential for all aircraft during PAR and ACLS approaches to detect abnormal precision approach parameters.
- The AGR mode of the AN/APG-79 AESA radar was observed to cause some of the highest levels of EMI on affected PAR and ACLS systems. Ensure the AN/APG-79 radar is in SIL, STBY, or OFF prior to selection of TDC to the HUD in order to enable the steering dot in the center of the velocity vector (which commands AGR).
- AN/APG-79 AESA radar transmissions within 10 nm directed towards civil airfields operating ASDE-X ground traffic management systems have caused EMI. ASDE-X is an FAA-designed, radar-based system designed to reduce runway incursions by tracking departing, arriving, and taxiing aircraft plus ground vehicles at major civilian airfields. AN/APG-79 AESA-generated EMI results in ASDE-X system shutdown, increasing the risk to taxiing aircraft and airport vehicles of unintentional ground or runway incursion.

NOTE

AN/APG-79 AESA radar does not interfere with SPN-41 ICLS systems or non-precision radar approach systems (ASR). AN/APG-79 has not been tested against other civil systems (ILS).

NOTE

- Adverse EMI effects from AN/APG-79 AESA equipped aircraft acting as overhead/recovery tankers (not on approach) have been observed during SPN-42 and SPN-46 ACLS testing.
- The SPN-42 (shore-based ACLS) and SPN-46 (shipboard ACLS) have shown degraded lock-on and command guidance anomalies due to EMI interference from AN/APG-79 AESA radar transmissions. For the SPN-46 system, these anomalies are more severe and more probable with the Block 1 Upgrade to the SPN-46 system.
- Through 2011, the FAA has stated the ASDE-X system will be fielded at the following locations: KATL, KBDL, KBOS, KBWI, KCLT, KDCA, KDEN, KDFW, KEWR, KFLL, KHIK, KHOU, KIAD, KIAH, KJFK, KLAX, KLGA, KLSV, KMCO, KMDW, KMEM, KMIA, KMKE, KMSP, KORD, KPHL, KPHX, KPVD, KSAL, KSAN, KSDF, KSEA, KSNA, and KSTL.

This page intentionally left blank.

PART II

INDOCTRINATION

Chapter 5 - Indoctrination

CHAPTER 5

Indoctrination

5.1 INITIAL QUALIFICATION

Initial NATOPS qualification in F/A-18E/F series aircraft shall be obtained by satisfactory completion of the CNO approved course of instruction at an F/A-18E/F Fleet Replacement Squadron (FRS). The minimum training requirements to be completed prior to initial NATOPS qualification for pilots and weapon system operators (WSO) are set forth below.

5.1.1 Minimum Ground Training Requirements. The following minimum ground training requirements shall be successfully completed prior to first flight in an E/F-series aircraft:

1. FRS academic familiarization syllabus to include:
 - a. Aircraft systems and procedures.
 - b. Emergency procedures review.
 - c. Instrument flight training.
 - d. Immediate action, open, and closed book NATOPS exams.
 - e. Cockpit orientation.
 - f. Ejection, egress, and survival equipment checkout.
 - g. Preflight checkout.
2. FRS simulator familiarization syllabus in the Tactical Operational Flight Trainer (TOFT).

5.1.2 Minimum Flight Training Requirements. The following minimum flight training requirements shall be successfully completed prior to initial NATOPS qualification:

1. FRS familiarization flight phase to include a minimum of 10 hours first pilot time (FPT) in E/F-series aircraft (5 hours if currently NATOPS qualified in F/A-18A-D), and a minimum of 10 hours special crew time (SCT) (5 hours if currently NATOPS qualified in F/A-18B/D) in F-series aircraft for WSOs.

5.2 FOLLOW-ON TRAINING

Follow-on ground training for each activity may vary according to local conditions, field facilities, requirements from higher authority, and the immediate unit Commanding Officer's estimate of squadron readiness.

Follow-on flight training should include aircraft and weapon systems instruction, normal and emergency procedures, simulators (if available), and evaluation of aircrew performance. Local command requirements, squadron mission, and other factors may influence the actual flight training syllabus and the sequence in which it is completed.

5.3 CURRENCY REQUIREMENTS

Minimum requirements to maintain currency after initial qualification shall be established by the unit Commanding Officer but will involve no less than 5 hours of first pilot time and two takeoffs and landings in E/F-series aircraft in the previous 90 days for pilots, and 5 hours of special crew time in F-series aircraft in the previous 90 days for WSOs. Additionally, an annual NATOPS evaluation with a grade of at least conditionally qualified is required for both pilots and WSOs.

5.3.1 Regaining Currency. Requalification of those crewmembers whose currency has lapsed shall include a familiarization flight(s), to include enough flight time to enable crewmembers to attain the requirement of 5 flight hours and 2 takeoff and landings in E/F series within 90 days. Specifics of familiarization flight(s) at discretion of Commanding Officer of the unit having custody of the aircraft.

5.4 REQUIREMENTS FOR VARIOUS FLIGHT PHASES

The specific requirements for various flight phases conducted during initial training in E/F-series aircraft are listed in figure 5-1.

Flight Phase	Pilot General	WSO	Pilots with current NATOPS in Type/Model, and F/A-18 CAT1 or CAT2 transition syllabus complete
Day Solo/Crew Solo	4 FAM flights *		1 FAM flight *
Night Solo/Crew Solo	Day Solo/Crew Solo qualified, 1 night FAM flight *		
Solo/Crew Solo Cross Country	F/A-18E/F instrument and NATOPS qualified		
Initial CQ	50 F/A-18E/F hours (FPT)	NATOPS Qualified	15 F/A-18E/F hours (FPT)
* CNO approved syllabus			

Figure 5-1. Requirements for Various Flight Phases During Initial Training

5.4.1 Instrument Evaluation Flights. Instrument evaluation flight requirements are delineated in OPNAVINST 3710.7 series and the NATOPS Instrument Flight Manual. Instrument evaluation flights may be conducted by designated military aviators or Naval Flight Officers designated in writing by their Commanding Officer.

5.4.2 Instrument Qualification. In accordance with OPNAVINST 3710.7 series, instrument ratings shall be valid in all aircraft in which the pilot is instrument qualified regardless of the model in which the check was flown. A pilot may be considered to be instrument qualified in an aircraft when he/she has completed the evaluation as outlined in each respective NATOPS manual and has met the requirements for an instrument rating as outlined in OPNAVINST 3710.7 series.

5.4.2.1 Requirements for Instrument Qualification in E/F-Series Aircraft. Each aircrew is required to be instrument qualified in F/A-18E/F series aircraft.

Pilots must have a current instrument rating prior to flight in actual instrument conditions. Figure 5-2 delineates the pilot requirements for instrument qualification along with ceiling and visibility restrictions for instrument rated pilots. When a pilot becomes fully instrument qualified in F/A-18E/F series aircraft, the ceiling and visibility requirements shall be the minimums authorized by OPNAVINST 3710.7 series, namely field minimums not less than 200/1/2.

WSOs must attend instrument ground school and satisfactorily complete a written examination to be instrument qualified.

5.4.3 Ceiling/Visibility Requirements. The ceiling and visibility requirements for takeoff and landing for pilots who are not fully instrument qualified in E/F-series aircraft are delineated in figure 5-2.

F/A-18E/F Actual Flight Experience	Pilot With Current Instrument Rating, F/A-18A-D NATOPS Qualification and >300 hours in model	Pilot With Current Instrument Rating and >500 Hours in Tactical Aircraft	Pilot With Current Instrument Rating
IP in rear of F(T)	300/1		
None	1000/3 for takeoff/landing, and training in clear air mass	Remain VMC and VFR	
Complete 1st FAM flight *	Circling mins for takeoff/landing, and training in clear air mass		
Complete 2nd FAM flight *	F/A-18E/F instrument qualified	1000/3 for takeoff/landing, and training in clear air mass	Remain VMC and VFR
Complete 2nd FAM flight *, and IAC in rear cockpit or complete all FAM flights * ++	-	Circling mins for takeoff/landing, and training in clear air mass	1000/3 for takeoff/landing, and training in clear air mass
F/A-18E/F NATOPS check and >10 hours (FPT)	-	F/A-18E/F instrument qualified	Circling mins for takeoff/landing, and training in clear air mass
F/A-18E/F NATOPS check and >40 hours (FPT)	-	-	F/A-18E/F instrument qualified
* CNO approved syllabus ++ Excluding CQ introduction			

Figure 5-2. Pilot Ceiling and Visibility Restrictions Prior to Instrument Qualification

5.5 WAIVERS

Unit Commanding Officers are authorized to waive, in writing, minimum flight and/or training requirements in accordance with OPNAVINST 3710.7 series.

5.6 PERSONAL FLYING EQUIPMENT

The minimum requirement for personal flying equipment is contained in OPNAVINST 3710.7 series. In addition, all F/A-18E/F aircrew shall use the latest available flight safety and survival equipment authorized by the Aircrew Personal Protective Equipment Manual (NAVAIR 13-1-6).

PART III

NORMAL PROCEDURES

Chapter 6 - Flight Preparation

Chapter 7 - Shore-Based Procedures

Chapter 8 - Carrier-Based Procedures

Chapter 9 - Special Procedures

Chapter 10 - Functional Checkflight Procedures

CHAPTER 6

Flight Preparation

6.1 MISSION PLANNING

6.1.1 General. All aircrew shall be responsible for preflight planning and preparation of required charts, route navigation computations including fuel planning, checking weather and NOTAMS, and for filing required flight plans. Refer to Part XI, Performance Data or approved fuel planning software, to determine fuel consumption and profile. Planned minimum on deck fuel should not be less than 1,800 lb. The aircrew shall refer to applicable tactical publications to plan specialized missions.

6.1.2 Flight Codes. The proper flight classification and flight purpose codes to be assigned to individual flights are established by OPNAVINST 3710.7 (Series).

6.2 BRIEFING/DEBRIEFING

6.2.1 Briefing. The flight leader is responsible for the briefing of each aircrew in the flight on all aspects of the mission to be flown. A standard briefing guide shall be used in conducting the briefing. Briefs shall include applicable ADMIN, TAC ADMIN, and MISSION CONDUCT. Aircrew qualified to assume the mission lead shall record all data necessary to complete the mission. The briefing guide should include the following:

6.2.1.1 NATOPS Admin Briefing Guide

General

- Time hack
- Objectives
 - Mission (Primary, Secondary)
 - Training
- Julian date, event number
- Times
 - Walk
 - Start
 - Check In
 - Taxi
 - Takeoff
 - Land
 - Debrief
- Line up
 - Callsigns
 - Aircraft assigned
 - Crew (Msn Commander, Alternate Lead)
 - A/A TACAN
 - Radar channels, search block
 - Loadout Gross Weight, Max Trap
- Comm Plan
 - Frequencies

Controlling Agencies
IFF Procedures
Alpha Check
Waypoint Plan
Weather, NOTAMs
Launch, Mission, Recovery, Divert
Sunrise, Sunset, Moonrise, Moonset
Water / Air Temperature
Joker / Bingo / Fuel Ladder

Preflight

Aircraft
Ordnance

Ground / On-deck

Line / Deck and Start Procedures
Final checks
Clearance
Arming
Marshal
Taxi

Takeoff / Launch

Duty Runway / Ships Heading
Ships Posit, PIM
Type Takeoff / Case Departure
Takeoff Data (NWLO, T/O, Abort speeds, Distance)
Catapult Endspped, Trim (asymmetrical)
Takeoff Checks
Departure Procedures

En Route

Rendezvous (Location, Speed)
En Route Formation
Route of Flight

Op Area

Range Info, Altitudes, Restrictions
Target Time, Range Event Number
Controlling Agency
Entry / Exit procedures

RTB / Recovery

Rendezvous (Location, Speed)
Battle Damage Checks

Formation
Controlling Agency
Route of Flight
Airfield Recovery Procedures
Ship Recovery Procedures
 Case Recovery
 Marshal
 Recovery Time
Type entry
 Overhead, Break Interval
 Straight-In / GCA
Type Landing

Post Landing

Clearing Landing Area
Configuration Changes
Comm
Taxi
De-Arming
Parking (Line / Hotpits / Hotseat)

Contingencies

Allowable Slide Time
Go / No Go Criteria
Fallouts, Spares
Bent Radar / Sensor / Weapon
Hung / Unexpended Ordnance
Weather

Emergencies

Abort, Field Arrestment
Loss of Brakes, Emergency Cat Flyaway
Inflight Emergencies / System Failures
NORDO, Lost Comm / Lost Sight
Midair, Bird Strike
Divert / BINGO
Ejection / SAR

ORM

Training Rules

ACM
NVG
LAT
LATT

Aircrew Coordination

Refer to Chapter 28.

6.2.1.2 NATOPS Tactical Admin Briefing Guide.

Environmentals

Sun / Moon

Winds

Conning Altitudes, Conn Check

Cloud cover

Decks (Hard / Soft)

Weapons Checks

G-warm, Inverted Check

Expendables Check

Fence Checks Complete

CVRS - Tapes

Knock It Off / Terminate Calls

Fuel & G Checks

6.2.2 Debriefing. Post-flight debriefing is an integral part of every flight. The flight leader shall conduct a mission debrief to include ADMIN, TAC ADMIN, SAFETY OF FLIGHT, and MISSION CONDUCT. Emphasis shall be placed on identifying and correcting errors and poor techniques. Debrief shall include all available aircrew and be conducted in a timely manner.

CHAPTER 7

Shore-Based Procedures

NOTE

- F/A-18F WSO responsibilities are *italicized*.
- For F/A-18F crew coordination specifics, including individual aircrew responsibilities and ICS communications, refer to Chapter 29, Crew Coordination Standards.

7.1 PREFLIGHT CHECKS

7.1.1 In Maintenance Control. The A-sheet must be checked for aircraft status, configuration, armament loading, and servicing prior to manning the aircraft. Review the aircraft discrepancy book (ADB) for (1) all outstanding discrepancies and (2) at least the last 10 flights worth of discrepancies and corrective action. Weight and balance clearance is the responsibility of the Maintenance Department.

7.1.2 Inspection of RCS Reduction Features. The most critical RCS reduction features/treatments include (1) EMIS III radar bulkhead shields, (2) canopy and windshield coatings, (3) engine inlet devices, and (4) outer moldline mismatch/gap control. To ensure that the survivability characteristics of the aircraft are retained, attention should be focused on the following areas:

1. On missions where the full RCS reduction potential of the aircraft is desired (typically wartime environment only), ensure the twelve missionized EMIS III radar bulkhead shields are installed. Additionally, ensure all SUU-79 pylons are fitted with their LO hardware (CAD access covers and four bolt fairings).
2. Typically, if minor damage to canopy or windshield coatings is visually acceptable for flight, the RCS reduction potential of the coatings should be retained.
3. Typically, if minor damage to the inlet lip/duct RAM coatings or to the inlet device are acceptable from a FOD standpoint, the RCS reduction potential of the coatings/device should be retained.
4. Mismatches and gaps in the outer moldline of the aircraft can substantially reduce RCS reduction potential. Care should be taken to note and repair damage to RAM coatings and FIP seals, particularly around frequently opened panels. Doors and panels should be flush with the surrounding structure and gaps should be filled. In general, a rule of thumb for an acceptable amount of panel/structure mismatch is no greater than the thickness of a PCL cover. With mismatches greater than that width, some RCS reduction potential is lost. The most critical gaps are those aligned perpendicular to the longitudinal axis of the aircraft (e.g., vertical gaps between side panels and 3-9 line gaps between underside panels). Gaps and mismatches that run along the longitudinal axis of the aircraft are less critical.

In general, at least 75 % of the perimeter of every door should exhibit good FIP seal integrity (e.g., sealed and flush). RAM coating damage should not exceed 25 % of the total RAM area in any particular location (e.g., around flap hinges or main landing gear door edges). Multi-layer RAM patches forward

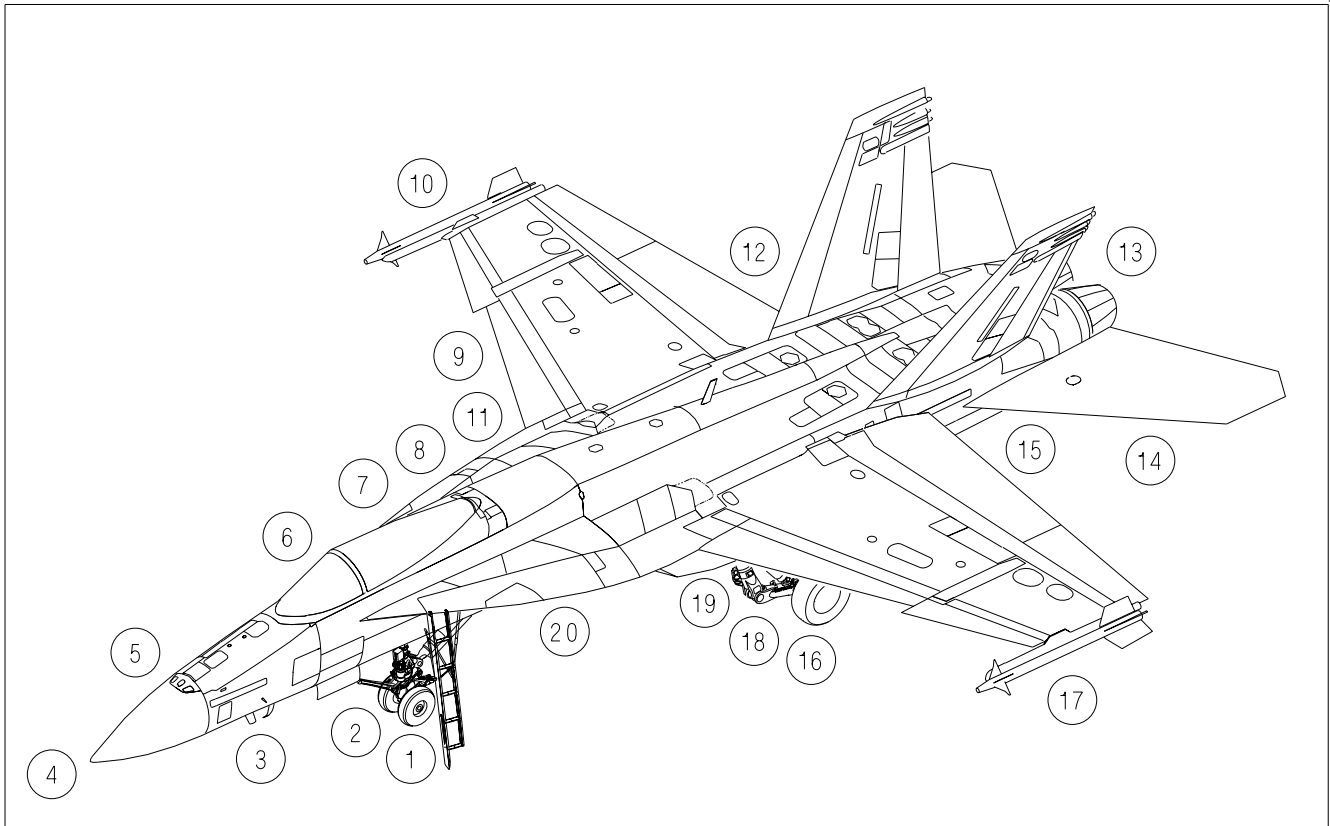

EFN520-55-1-001

Figure 7-1. Exterior Inspection

of the inlet should show no sign of disbonding or peeling. All conductive tape, the windshield aft arch termination strip, NLG blade seals, canopy and wing conductive bulb seals, and TEF/rudder boots should be fully bonded, with no loose or peeling corners or edges. It is normally acceptable to trim loose materials that are noticed just prior to flight.

7.1.3 Exterior Inspection. The exterior inspection (figure 7-1) is divided into 20 areas, beginning at the left forward fuselage and continuing clockwise around the aircraft. Check doors secure and be alert for loose fasteners, cracks, dents, leaks, and other general discrepancies. Close inspection shall be given to the left and right nose sections for moldline defects (bends, dents, dings, cracking or blistering of exterior coatings, or other surface discrepancies) that will affect the pitot-static system and RVSM capability.

1. Nose landing gear
 - a. Drag brace/fairing - CHECK CONDITION
 - b. Drag brace ground safety pin - REMOVED
 - c. Holdback fitting - CHECK CONDITION
 - d. Tires and wheels - CHECK CONDITION
 - e. Ensure key washer not in direct contact with wheel hub.

- f. Strut piston chrome exposed - 6 INCHES
 - g. Launch bar - CHECK CONDITION
 - h. Nosewheel steering assembly - CHECK CONDITION
 - i. Tiedown rings (2) - CHECK FOLDED AGAINST STRUT
 - j. Taxi and approach lights - CHECK CONDITION
 - k. Strut pressure gauges (2) - CHECK IN THE GREEN
 - l. Retract actuator - CHECK CONDITION
 - m. Strut - CHECK CONDITION
2. Nose wheelwell
- a. Maintenance code switch - SELECT RESET MOMENTARILY (applies power to the SMS processor).
 - b. Doors and linkages - CHECK CONDITION
3. Nose section (left side)
- a. Fuselage surface - CHECK CONDITION (no bends, dents, dings, cracking or blistering of exterior coatings, or other surface discrepancies)
 - b. Safety switches - CHECK
 - (1) Expendables - Yellow when out
 - (2) Gun electrical - Orange when out
 - (3) Gun holdback - Orange when out
 - c. Gun - PREFLIGHT
 - d. AOA probe - CHECK CONDITION
 - (1) Smooth, concentric rotation through the full range of travel to include while gently pulling and pushing the AOA probe.
 - (2) No bends, dents, dings, cracking or blistering of exterior coatings, or other surface discrepancies.
 - e. Pitot tube - CHECK CONDITION (no bends, dents, dings, cracking or blistering of exterior coatings, or other surface discrepancies).
 - f. Pitot static drains (4) - CLOSED (underside)
 - g. Forward antennas - CHECK CONDITION

- (1) Blade antenna (Comm 1, DL, IFF)
- (2) Hump antenna (ALR-67 Low band array)
- (3) Flush chevron antenna (ICLS, ACLS)
- h. Radome - CHECK SECURE (2 points)
- 4. Nose section (top)
 - a. Gun blast diffuser and gun port - CLEAR
- 5. Nose section (right side)
 - a. Fuselage surface - CHECK CONDITION (no bends, dents, dings, cracking or blistering of exterior coatings, or other surface discrepancies)
 - b. Radome - CHECK SECURE (2 points)
 - c. AOA probe - CHECK CONDITION
 - (1) Smooth, concentric rotation through the full range of travel to include while gently pulling and pushing the AOA probe.
 - (2) No bends, dents, dings, cracking or blistering of exterior coatings, or other surface discrepancies.
 - d. Pitot tube - CHECK CONDITION (no bends, dents, dings, cracking or blistering of exterior coatings, or other surface discrepancies).
 - e. Refuel cap - ON
 - f. Refuel door (8R) - CLOSED/SECURED
- 6. Forward fuselage (right side)
 - a. Aft blade antenna (Comm 2, TCN) - CHECK CONDITION
 - b. Flush LEX antenna (ALQ-165 low/high band transmitter) - CHECK CONDITION
 - c. SMS processor - CHECK WEAPON/FUZE CODES
 - d. DOOR 13R - CLOSED/SECURED
 - e. Right engine intake - CLEAR
 - f. Heat exchanger ram air inlet (top, inside intake) - CLEAR
 - g. Chaff/flare dispensers (2) - PREFLIGHT (ensure chaff/flare buckets or access covers installed).
- 7. External fuel tank(s) - PREFLIGHT

- a. Refuel cap - DOWN, LOCKED, ARROW FORWARD
- b. Precheck valve - DOWN, FLUSH
- 8. Station 7 missile, NFLR, or LDT (if installed) - PREFLIGHT
- 9. Right main landing gear - CHECK
 - a. Tire and wheel - CHECK CONDITION
 - b. Brake wear indicator - EXTENDED (not flush or below flush)
 - c. Planing link - CHECK CONDITION
 - d. Strut - CHECK CONDITION
 - e. Tiedown rings (2) - CHECK SPRING CONDITION
 - f. Landing gear pin - REMOVED
- 10. Right wing
 - a. Flush LEF antenna (ALR-67/ALQ-165 receivers) - CHECK CONDITION
 - b. LEF - CHECK CONDITION
 - c. Pylons and external stores - PREFLIGHT
 - d. Wingfold area - CHECK CONDITION AND VERIFY WINGFOLD PIN REMOVED
 - e. Position lights - CHECK CONDITION
 - f. LAU-7 - ENSURE NITROGEN BOTTLE INSTALLED AND DOORS SECURE
 - g. Wingtip AIM-9 (if installed) - PREFLIGHT
 - h. Aileron - CHECK CONDITION, FAIRED WITH WINGS FOLDED



If the wings are folded, note the position of the ailerons. If the aileron locking pins do not restrain the ailerons in the faired position, ensure the ailerons are moved to a faired or outboard position prior to engine start to preclude damage to the ailerons and TEFs.

- i. TEF - CHECK CONDITION
- 11. Right main wheelwell
 - a. Hydraulic filter indicators (delta-Ps) - NOT POPPED

- b. APU accumulator gauge - CHECK (3,000 psi nominal)
 - c. APU handpump handle - STOWED AND PINNED
 - d. Doors and linkages - CHECK CONDITION
 - e. Landing gear downlock and retract actuators - CHECK CONDITION
12. Aft fuselage (right side)
- a. Vertical tail and rudder - CHECK CONDITION
 - b. Strobe light - CHECK CONDITION
 - c. Fuel vent outlet - CLEAR
 - d. Light/antenna radomes - CHECK CONDITION
 - (1) Tail light (top)
 - (2) ALQ-165 low/high band receiver (middle)
 - (3) ALR-67 receiver (bottom)
 - e. Dump outlet - CLEAR
 - f. Stabilator - CHECK CONDITION
 - g. Exhaust nozzle and afterburner section - CHECK CONDITION
13. Arresting hook area
- a. Arresting hook - CHECK CONDITION (make sure cotter key installed in hook point attach bolt)
 - b. Arresting hook pin - REMOVED
 - c. Towed decoy stand-off bar (when installed) - CHECK CONDITION
14. Aft fuselage (left side)
- a. Exhaust nozzle and afterburner section - CHECK CONDITION
 - b. Stabilator - CHECK CONDITION
 - c. Vertical tail and rudder - CHECK CONDITION
 - d. Antenna radomes - CHECK CONDITION
 - (1) ALQ-165 high band transmitter (top)
 - (2) ALQ-165 low band transmitter (middle)

- (3) ALR-67 receiver (bottom)
 - e. Dump outlet - CLEAR
 - f. Strobe light - CHECK CONDITION
 - g. Fuel vent outlet - CLEAR
15. Aft fuselage (underside)
- a. APU intake (screened) and exhaust ducts - CLEAR
 - b. ATS exhaust ducts (screened) - CLEAR
 - c. ALE-50 dispenser - CHECK CONDITION (make sure live or protected magazine installed)
16. Left main wheelwell
- a. Hydraulic filter indicators (delta-Ps) - NOT POPPED
 - b. Doors and linkages - CHECK CONDITION
 - c. Landing gear downlock and retract actuators - CHECK CONDITION
 - d. Landing gear pin - REMOVED
17. Left wing
- a. TEF - CHECK CONDITION
 - b. Aileron - CHECK CONDITION, FAIRED WITH WINGS FOLDED



If the wings are folded, note the position of the ailerons. If the aileron locking pins do not restrain the ailerons in the faired position, ensure the ailerons are moved to a faired or outboard position prior to engine start to preclude damage to the ailerons and TEFs.

- c. Wingtip AIM-9 (if installed) - PREFLIGHT
- d. LAU-7 - ENSURE NITROGEN BOTTLE INSTALLED AND DOORS SECURE
- e. Position lights - CHECK CONDITION
- f. Wingfold area - CHECK CONDITION AND VERIFY WINGFOLD PIN REMOVED
- g. Pylons and external stores - PREFLIGHT
- h. LEF - CHECK CONDITION

- i. Flush LEF antenna (ALR-67/ALQ-165 receivers) - CHECK CONDITION
18. Left main landing gear
- a. Tire and wheel - CHECK CONDITION
 - b. Brake wear indicator - EXTENDED (not flush or below flush)
 - c. Planing link - CHECK CONDITION
 - d. Strut - CHECK CONDITION
 - e. Tiedown rings (2) - CHECK SPRING CONDITION
19. Station 5 missile or TFLR (if installed) - PREFLIGHT
20. Forward fuselage (left side)
- a. Chaff/flare dispensers (2) - PREFLIGHT (ensure chaff/flare buckets or access covers installed).
 - b. Left engine intake - CLEAR
 - c. Heat exchanger ram air inlet (top, inside intake) - CLEAR
 - d. Fuel cavity drains (underside) - VERIFY NO LEAKS
 - e. Loose fasteners - CHECK
 - f. Flush LEX antenna (ALQ-165 low/high band transmitter) - CHECK CONDITION

7.1.4 Before Entering Cockpit.

- 1. Ensure all doors forward of the intakes are secured properly.
- 2. Boarding ladder - SECURE (2 points)
- 3. Fuselage (upper surface)
 - a. Spoilers - CHECK CONDITION
 - b. Upper blade antenna (Comm 1, DL, TCN) - CHECK CONDITION
 - c. ECS auxiliary duct doors - CHECK DOWN/CONDITION
 - d. Maintenance handle - CHECK STOWED
- 4. (LOTs 21-24) Over-the-shoulder cameras (2) - CHECK SECURE
- 5. CVRS tapes - INSTALL IN RECORDERS (if desired)

6. EMI shields (covers over bay behind ejection seat) - CLOSED/SECURED



Ensure the EMI shields are properly closed and secured prior to closing the canopy to prevent damage to the shields and the canopy actuation link.

7. Ejection seat SAFE/ARMED handle - SAFE

8. Ejection seat(s) - PREFLIGHT

- a. Manual override handle - FULL DOWN and LOCKED
- b. Right pitot - STOWED
- c. Ballistic gas quick-disconnect - CONNECTED (indicator dowel flush or slightly protruding)
- d. Top latch plunger locking indicator - FLUSH WITH THE END OF THE PLUNGER

A rectangular warning symbol with a thick black border and the word "WARNING" in bold, uppercase letters in the center.

If the top latch plunger locking indicator is not flush, the seat could come loose on the mounting rails.

- e. Catapult manifold valve - CHECK (hoses and manifold connected; retaining pin installed)
- f. Parachute withdrawal line - CONNECTED/SECURED
- g. Parachute container lid - SECURE
- h. Left pitot - STOWED
- i. Electronic sequencer - NOT ACTIVATED
 - (1) Indicator should be BLACK (not activated).
 - (2) White - CHECK THERMAL BATTERIES NOT ACTIVATED
- j. Thermal batteries - NOT ACTIVATED
 - (1) Indicator should be WHITE or PINK (not activated).
 - (2) Black or purple is UNSAT (activated).
- k. Console oxygen/comm lines - CONNECTED/SECURED
- l. Survival kit - CHECK
 - (1) Oxygen/comm lines - CONNECTED/SECURED

- (2) Emergency oxygen gauge - IN THE BLACK
- (3) Seat pan - CHECK SECURED TO SEAT (pull up on front end to test security)
- m. Radio beacon lanyard - SECURED TO COCKPIT FLOOR (make sure lanyard and quick release connector are positioned forward of the underseat rocket motor tubes)
- n. Lap belts - SECURE (pull up strongly on each belt to make sure bolt fittings are engaged in the seat)
- o. Leg restraint lines - CHECK
Check that leg restraint lines are secured to seat and floor and are not twisted. Check that lines are routed first through the thigh garter ring, then through the lower garter ring, and then routed outboard of the thigh garter ring before the lock pins are inserted into the seat just outboard of the snubber boxes.

WARNING

Failure to route the restraint lines properly through the garters could cause serious injury during ejection/emergency egress.

- p. Ejection seat firing initiators - CHECK FIRING LINKAGE CONNECTED TO SEARS
- q. Parachute risers - CHECK (ensure risers are routed down the forward face of the parachute container and are routed behind the retaining strap; pull on risers to check ease of operation).
- r. SEAWARS - CHECK FOR PROPER INSTALLATION
- s. (SJU-17A (V)1/A, 2/A, and 9/A) Backpad adjustment handle - SET TO DESIRED POSITION

For solo flight in the F/A-18F -

- 9. Rear cockpit - SECURE
 - a. Ejection seat SAFE/ARMED handle - SAFE
 - b. Ejection control handle pin - VERIFY REMOVED
 - c. (LOTs 21-24) EMERG BRK handle - STOWED

WARNING

The position of the EMERG BRK handle is the only indication that emergency braking is selected; no warning or caution is displayed. The EMERG BRK handle(s) must be fully stowed in both cockpits to ensure that normal braking with anti-skid is available.

- d. CANOPY JETT handle - OUTBOARD AND DOWN/PIN REMOVED
- e. L(R) DDI and MPCD knobs - OFF

- f. Comm 1 and 2 knobs - OFF
- g. EJECTION MODE handle - SOLO/COLLAR INSTALLED
- h. SEAT CAUT MODE switch - SOLO/PIN INSTALLED
- i. Leg restraints, lap belts, parachute risers, JHMCS QDC - SECURED/STOWED
- j. Loose items - SECURED

In trainer configured aircraft -

- k. Control stick - CHECK SECURE
- l. UFCD adapter - VERIFY NOT INSTALLED

WARNING

Forward stick throw is restricted if a rear cockpit control stick and UFCD adapter are both installed.

- m. Throttles - CHECK CONDITION

7.1.5 Interior Checks - Pilot.

CAUTION

Do not place any item on the glare shield, as scratching the windshield is probable.

- 1. Leads, leg restraints, and harness - SECURE/ADJUST
Connect oxygen, g suit, QDC (if applicable) and communications leads. Check routing of JHMCS. UHVI does not interfere with oxygen hose. Check QDC is securely connected or stowed if not in use. Fasten and secure leg restraint garters and lines. Check leg garters buckled and properly adjusted with hardware on inboard side of the legs. Connect and adjust lap belt straps. Attach parachute Koch fittings to harness buckles. Check operation of shoulder harness locking mechanism.

WARNING

The leg restraint lines must be buckled at all times during flight to ensure that the legs will be pulled back upon ejection. This enhances seat stability and prevents leg injury by keeping the legs from flailing following ejection.

WARNING

The JHMCS UHVI must be properly routed through the torso bundle flue under the survival vest and the QDC secured in the QMB to ensure that no entanglement exists with the oxygen hose. Misrouting of the JHMCS UHVI may allow the QDC to rub against the oxygen hose disconnect causing unintentional oxygen/communications disconnect in flight.

2. Ejection control handle - CLEAR
3. Ejection control handle pin - VERIFY REMOVED

Left console -

1. Circuit breakers - IN
2. Manual canopy handle - STOWED
3. MC and HYD ISOL switches - NORM
4. OBOGS control switch - OFF
5. OXY FLOW knob - OFF
6. OBOGS monitor pneumatic BIT plunger - VERIFY UNLOCKED AND FULLY EXTENDED

WARNING

Inadvertent rotation of the OBOGS monitor pneumatic BIT plunger while pressed can result in the locking of the plunger in a maintenance position and may result in intermittent OBOGS DEGD cautions and lead to hypoxia. Rotation of the BIT plunger disengages the locking slot allowing the plunger to extend and move freely when pushed.

7. COMM 1/IFF ANT SEL switches - AUTO/BOTH
8. COMM panel - SET
 - a. RLY and GXMT switches - OFF
 - b. ILS CHANNEL/ILS switch - SET/UFCD
 - c. CRYPTO, MODE 4, (IFF) MASTER switches - NORM/OFF/NORM
9. VOL panel - SET AS DESIRED
10. FCS GAIN switch - NORM/GUARD DOWN
11. APU switch - OFF

12. PROBE switch - RETRACT
13. EXT TANKS switches - NORM
14. DUMP switch - OFF
15. INTR WING switch - NORM
16. GEN TIE CONTROL switch - NORM/GUARD DOWN
17. EXT LT panel - SET
 - a. EXT LT IDENT knob - NORM
 - b. FORM knob - AS REQUIRED
 - c. POS knob - AS REQUIRED
 - d. STRB switch - BRT/DIM/OFF (as required)
18. Throttles - OFF
19. External lights master switch - FORWARD
20. BRK PRESS switch - CHECK (2,600 psi min)

Instrument panel -

1. PARK BRK handle - SET
2. LDG/TAXI LIGHT switch - OFF
3. ANTI SKID switch - ON
4. SELECT JETT knob - SAFE
5. FLAP switch - FULL
6. LAUNCH BAR switch - RETRACT
7. LDG GEAR handle - DN
8. Landing gear handle mechanical stop - FULLY ENGAGED
9. CANOPY JETT handle - FORWARD
10. MASTER ARM switch - SAFE
11. EMERG JETT button - NOT PRESSED IN

12. FIRE and APU FIRE warning lights - NOT PRESSED IN

NOTE

If a FIRE light is depressed, approximately 1/8 inch of yellow and black stripes will be visible around the outer edges of the light.

13. L(R) DDI, HUD, and MPCD knobs - OFF

NOTE

Power to the UFCD is controlled by the MPCD knob, so the UFCD knob does not need to be OFF.

14. COMM 1 and 2 knobs - OFF

15. CVRS mode switch - OFF

16. ALT switch - BARO or RDR

17. ATT switch - AUTO

18. Standby attitude reference indicator - CAGED

19. IR COOL switch - OFF

20. SPIN switch - NORM/GUARD DOWN

21. HOOK handle - UP

22. WINGFOLD switch - SAME AS WING POSITION

23. AV COOL switch - NORM

Pedestal Panel (LOTS 23 and up) -

1. ECM JETT button - NOT PUSHED IN

2. JAMMER switch - OFF

3. RWR switch - OFF

4. DISPENSER switch - OFF

5. AUX REL switch - NORM

6. RUD PED ADJ lever -

- a. SET PEDAL POSITION FULL FORWARD
 - Cycle left and right pedal to check for binding.

- b. SET PEDAL POSITION AS DESIRED FOR FLIGHT
 - Locks securely when RUD PED ADJ lever released.



Restrain the rudder pedals during adjustment. Unrestrained release of the rudder pedals may damage the rudder pedal mechanism.

Ensure the rudder pedals are locked in position after adjustment. Failure to lock the rudder pedals may result in uncommanded forward rudder pedal movement inflight.

Pedestal Panel (LOTS 21 - 22) -

1. ECM JETT button - NOT PUSHED IN
2. DISPENSER switch - OFF
3. ECM knob - OFF
4. DECOY switch - OFF
5. AUX REL switch - NORM
6. RWR switch - OFF
7. Clock - CHECK AND SET
8. RUD PED ADJ lever -
 - a. SET PEDAL POSITION FULL FORWARD
 - Cycle left and right pedal to check for binding.
 - b. SET PEDAL POSITION AS DESIRED FOR FLIGHT
 - Locks securely when RUD PED ADJ lever released.

Right console -

1. Circuit breakers - IN
2. GEN switches - NORM
3. BATT switch - OFF
4. ECS panel - SET
 - a. MODE switch - AUTO

WARNING

Selection of MAN with the ECS mode switch is prohibited. Selecting MAN while the aft cooling fan shutoff valve is open may cause the fan to overspeed resulting in a catastrophic fan failure potentially leading to loss of OBOGS.

- b. CABIN TEMP knob - AS DESIRED
 - c. CABIN PRESS switch - NORM
 - d. BLEED AIR knob - OFF
 - e. ENG ANTI ICE switch - OFF
 - f. PITOT ANTI ICE switch - AUTO
5. DEFOG handle - MID RANGE
 6. WINDSHIELD switch - OFF
 7. INTR LT panel - SET
 - a. CONSOLES, INST PNL, and FLOOD knobs - AS DESIRED
 - b. CHART and WARN/CAUT knobs - AS DESIRED
 - c. MODE switch - DAY, NITE, or NVG (as required)
 8. Sensor control panel - SET
 - a. FLIR, LTD/R, and LST/NFLR switches - OFF/SAFE/OFF
 - b. INS and RADAR knobs - OFF
 9. NVG storage container - CHECK SECURE

7.1.6 Interior Checks - WSO.

1. Leads, leg restraints, and harness - SECURE/ADJUST
 Connect oxygen, g suit, QDC (if applicable) and communications leads. Check routing of JHMCS UHVI does not interfere with oxygen hose. Check QDC is securely connected or stowed if not in use. Fasten and secure leg restraint garters and lines. Check leg garters buckled and properly adjusted with hardware on inboard side of the legs. Connect and adjust lap belt straps. Attach parachute Koch fittings to harness buckles. Check operation of shoulder harness locking mechanism.

WARNING

- The leg restraint lines must be buckled at all times during flight to ensure that the legs will be pulled back upon ejection. This enhances seat stability and prevents leg injury by keeping the legs from flailing following ejection.
- The JHMCS UHVI must be properly routed through the torso bundle flue under the survival vest and the QDC secured in the QMB to ensure that no entanglement exists with the oxygen hose. Misrouting of the JHMCS UHVI may allow the QDC to rub against the oxygen hose disconnect causing unintentional oxygen/communications disconnect in-flight.

2. Ejection control handle - CLEAR
3. Ejection control handle pin - VERIFY REMOVED

In trainer configured aircraft -

1. Control stick - CHECK SECURE
2. UFCD adapter - VERIFY NOT INSTALLED

WARNING

Forward stick throw is restricted if a rear cockpit control stick and UFCD adapter are both installed.

3. Throttles - CHECK CONDITION
4. RUD PED ADJ lever - ADJUST PEDAL POSITION

Left console -

1. OXY FLOW knob - OFF
2. Left hand controller - CHECK SECURE
3. CANOPY JETT handle - OUTBOARD AND DOWN
4. VOL panel - SET AS DESIRED
5. RECCE panel - SET
 - a. POD PWR knob - OFF
 - b. ATARS switch - OFF

Instrument panel -

1. (LOTs 21-24) EMERG LDG GEAR handle - STOWED
2. (LOTs 21-24) EMERG BRK handle - STOWED

WARNING

The position of the EMERG BRK handle is the only indication that emergency braking is selected: no warning or caution is displayed. The EMERG BRK handle(s) must be fully stowed in both cockpits to ensure that normal braking with anti-skid is available.

CAUTION

Due to friction in the EMERG BRK handle mechanism, the handle may not return to the fully stowed position unless positively pushed.

3. L(R) DDI and MPCD knobs - OFF

NOTE

Power to the UFCO is controlled by the MPCD knob, so the UFCO knob does not need to be OFF.

4. EMERG JETT button – NOT PRESSED IN
5. COMM 1 and 2 knobs - OFF
6. Standby attitude reference indicator - CAGED
7. EJECTION MODE handle - NORM

Right console -

1. Right hand controller - CHECK SECURE
2. INTR LT panel - SET
 - a. CONSOLES, INST PNL, and FLOOD knobs - AS DESIRED
 - b. CHART and WARN/CAUT knobs - AS DESIRED
3. NVG storage container - CHECK SECURE

7.2 ENGINE START

A self-contained (battery/APU) start is the primary method for starting the engines. The aircraft also has provisions for starting on external power, external air, or opposite engine bleed air (crossbleed) for circumstances when that may be appropriate (e.g., alert launch, low battery, maintenance, engine restart after APU shutdown, etc.). As such, the steps for a "normal" battery/APU start are numbered below, while steps for alternate starting sources are lettered.

With an external power start, all electrical systems are operative. With a battery start, power is available to operate the APU and engine fire warning systems, the caution lights panel, the intercom system between the aircrew and the ground crew, the cockpit utility light, and the EFD backup display.

The right engine is normally started first in order to provide normal hydraulics to the brakes. During first engine battery start, the EFD RPM indication typically jumps from 0 to 5 or 10 %, and light-off is indicated by TEMP rising from a minimum reported value of approximately 190°C. When the corresponding generator comes online (approximately 60 % N₂ rpm), the engine crank switch returns to OFF. After both generators are online, the APU will run for 1 minute and then shut down automatically.



- To prevent engine damage during start, if an engine was not idled (75 % N₂ rpm or less) for 5 minutes prior to shutdown and a restart must be made between 15 minutes and 4 hours after shutdown, the engine must be motored for 1 minute at 29 % N₂ or greater before restart.
- To prevent vibration and damage to compressor blades, do not allow N₂ rpm to dwell between 26 to 29 % during engine motoring.

7.2.1 Intercockpit Communications (F/A-18F). The following Challenge/Response voice communications are mandatory:

Challenge	Response
Pilot - ICS check	WSO - Loud and clear
Pilot - Fire warning	WSO - Roger (Optional)
Pilot - Starting APU left/right	WSO - Roger (Optional)
WSO - Good waypoint zero	Pilot - Roger (Optional)
Pilot - Canopy	WSO - Clear/standby

7.2.2 Engine Start Checks. *In the F/A-18F, the WSO must monitor pilot procedures, EFD indications, and plane captain signals to ensure maximum safety during engine start.*

1. BATT switch - ON

2. Battery gauge - CHECK

NOTE

Nominal voltage for a "good" battery should be 23 to 24 vdc. Minimum battery voltage is that which provides a successful engine start (i.e., APU remains online and the EFD remains powered to provide indications of RPM and TEMP). EFD blanking and/or uncommanded APU shutdown should be anticipated with a battery voltage at or below approximately 18 vdc. If a weak battery results in an unsuccessful engine start attempt, the battery should be charged or replaced prior to takeoff, since the battery provides the last source of electrical redundancy for the FCCs.

3. Caution Lights Panel - CHECK CABIN light on (if CPWS installed)

4. ICS - CHECK

With external electrical power -

- a. EXT PWR switch - RESET
- b. GND PWR switches 1, 2, 3, and 4 - B ON (hold for 3 seconds)
- c. L(R) DDI, HUD, and MPCD knobs - ON (*both cockpits*)
- d. COMM 1 and 2 knobs - ON/VOLUME AS DESIRED (*both cockpits*)
- e. LT TEST switch - TEST (*both cockpits*)
- f. MPCD/UFCD - ENTER DESIRED WAYPOINTS

All starts -

5. FIRE warning test - PERFORM

- a. FIRE test switch - TEST A (hold until all lights and aural warnings indicate test has been successfully passed)
- b. FIRE test switch - NORM (pause 7 seconds or cycle BATT switch for system reset)
- c. FIRE test switch - TEST B (hold until all lights and aural warnings indicate test has been successfully passed)

NOTE

During a successful FIRE warning test, **ALL** of the following lights should illuminate in each TEST position: both FIRE lights (all 4 bulbs), the APU FIRE light (all 4 bulbs), and both L and R BLEED warning lights. Additionally, the following voice aural warnings should be heard in order: "Engine fire left, engine fire right, APU fire, bleed air left, bleed air right" (each repeated twice).

NOTE

- A complete FIRE warning test is performed in each TEST position because it is difficult to recognize a single unlit bulb in a FIRE light. Since an aural warning does not annunciate if any of the FIRE or BALD loops are bad, lack of an aural warning is the best cue to the aircrew of a test failure.
- Failure to pause in NORM for at least 3 seconds between TEST A and TEST B results in a false BALD failure MSP code.

6. Forward MPCD and UFCD knobs - ON

NOTE

Forward MPCD and UFCD need to be turned on to display the backup HUD format and L/R ATS cautions.

If APU start -

7. APU ACC caution light - VERIFY OFF
8. APU switch - ON (READY light within 30 seconds)



To prevent an APU running engagement and to prevent APU exhaust torching, a minimum of 2 minutes must elapse between APU shutdown and another APU start.

NOTE

If an APU fire or overheat condition is detected on the ground, the APU fire extinguishing system will automatically shutdown the APU and, after 10 seconds, will discharge the extinguisher bottle.

If external air start -

- a. BLEED AIR knob - OFF

All starts -

Regardless of the engine start air source utilized, the corresponding GEN switch should be ON, as the generator provides primary overspeed cutout protection for the ATS.

9. ENG CRANK switch - R

10. Right throttle - IDLE (10 % N_2 minimum. Oil pressure should be a minimum of 10 psi within 30 seconds. Maximum transient EGT during start is 871°C).

NOTE

During ground starts only, the FADEC will automatically cut back fuel flow to prevent EGT from exceeding 815°C. If required, fuel flow will be reduced to the point of engine flameout. While this mechanization is provided to prevent engine damage due to an overtemp, the aircrew should not rely on it to prevent a hot start.

11. CFIT voice warnings - CHECK (OFP 18E: "ROLL-LEFT...ROLL-LEFT") (OFP 13E: "ROLL-OUT...ROLL-OUT")

NOTE

MC1 does an ACI configuration check after the generator comes on line during a cold start power-up by commanding the above voice warning. If the ACI does not contain the appropriate software, the "ROLL-LEFT...ROLL-LEFT" voice warning is not heard and the MC1 will assume an incompatible ACI is installed in the aircraft, GPWS/TAWS voice warnings are not available and only the recovery arrow will be displayed during a CFIT condition.

12. Battery gauge - VERIFY 28 vdc

NOTE

If the battery gauge fails to reach approximately 28 vdc with one generator online, a battery charger malfunction has occurred which requires maintenance action prior to flight.

13. L(R) DDI, HUD, and MPCD knobs - ON (*both cockpits*)



During a battery start of the right engine, recognition of a R ATS caution will be delayed until the displays are turned on. Once the displays are powered, verify that the R ATS caution is not set.

14. HMD switch (if applicable) - ON

15. EFD - CHECK

Ground idle -

RPM	61 % minimum
TEMP	250° to 590° C
FF	600 to 900 pph
OIL	35 to 90 psi (warm oil)
NOZ	77 % to 83 %

NOTE

Following the initial start of each engine, engine anti-ice airflow will turn on automatically 45 seconds after the engine reaches idle power and will remain on for 30 seconds, provided the throttle remains at IDLE. The corresponding LHEAT or RHEAT advisory will be displayed during this engine anti-ice functional test.

If external power start -

- a. External electrical power - DISCONNECT

If APU or crossbleed start -

16. BLEED AIR knob - NORM

NOTE

The bleed air shutoff valves close during the fire warning test, so the BLEED AIR knob must be rotated from OFF to NORM with ac power applied to reset the valves.

17. LT TEST switch - TEST (*both cockpits*)

For a crossbleed start ensure the APU switch is OFF. The operating engine should be advanced to a minimum of 80% N₂.

18. ENG CRANK switch - L
19. Left throttle - IDLE (10 % N₂ minimum)
20. ENG CRANK switch - CHECK OFF
21. EFD - CHECK

If external air start -

- a. BLEED AIR knob - NORM

7.3 BEFORE TAXI CHECKS

1. WYPT 0 and MVAR - CHECK/SET
2. GPWS/TAWS - CHECK BOXED
3. INS knob - CV or GND (PARK BRK SET)

4. RADAR knob - OPR
5. FLIR and LST/FLR switches - AS DESIRED
6. *UFCD avionics - TURN ON*
 - a. *RALT - ON/SET*
 - b. *TCN - ON, T/R, CH SET*
 - c. *IFF - ON/MODES UNBOXED*
7. WINGFOLD switch - SPREAD
8. FCS RESET button - PUSH (verify RSET advisory displayed)

NOTE

Prior to takeoff (cycle to WoffW), a successful FCS RESET automatically clears all BLIN codes.

If no reset (~~RSET~~ advisory displayed) -

- a. FCS exerciser mode - INITIATE (push the FCS RESET button while holding the FCS BIT consent switch up)



In standard or warm conditions, do not initiate the FCS exerciser mode multiple times in an attempt to get a successful FCS RESET. In such conditions, multiple initiations may excessively elevate hydraulic system temperatures, increasing actuator and hydraulic pump seal wear and potentially decreasing component life.

- b. FCS RESET button - PUSH (verify RSET advisory displayed)

After successful FCS reset -

9. FLAP switch - AUTO
10. FCS IBIT - PERFORM
 - a. FCS BIT consent switch - HOLD UP THEN PRESS THE FCS OPTION
 - b. AOA warning tone - VERIFY ANNUNCIATION AT FCS IBIT COMPLETION
 - c. FCS A and FCS B BIT status - VERIFY GO
 - d. FCS display - VERIFY NO BLIN CODES

WARNING

Flight with BLIN codes could result in a FCS failure and aircraft loss. Pressing the FCS RESET button simultaneously with the paddle switch does not correct BIT detected FCS failures; it simply clears the BLIN codes from the FCS display. FCS IBIT must be re-run after clearing BLIN codes to ensure that previously detected failures no longer exist. If BLIN codes remain following IBIT, maintenance action is required to identify and correct failures in the FCS.

NOTE

- With the wings folded, both ailerons are X'd out, but no aileron BLIN codes should be displayed. Even with wings folded, there are aileron functions tested that may reveal FCS failures via valid BLIN codes.
- For FCS IBIT to start, the FCS BIT consent switch must be held for at least 2 seconds. If not held for the required time, FCS A and FCS B will indicate RESTRT on the BIT status line. If RESTRT is displayed, select STOP on the FCS-MC sublevel display and then repeat the initiation procedure.
- The FCS will not enter IBIT if the throttles are above 14° THA or NWS is engaged.
- Do not operate any FCS related switches or move the stick or rudder pedals while FCS IBIT is running, as this may produce false failure indications.
- With the wings folded, a BIT status indication of GO will only be displayed for approximately 2 seconds before reverting to a DEGD indication. BIT status will return to GO when the wings are spread and locked.
- If the FCS IBIT fails, FCS A and FCS B will indicate DEGD on the BIT status line. Note surface X's and/or BLIN codes and contact maintenance personnel.

11. Trim - CHECK (check pitch, roll, and yaw trim for proper movement in all directions)

NOTE

It is not possible to trim the stabilators to negative values (TED) with WonW.

12. T/O TRIM button - PRESS UNTIL TRIM ADVISORY DISPLAYED (stabilators 4° NU)

NOTE

If the TRIM advisory does not appear, longitudinal trim is not set for takeoff. The CHECK TRIM caution will be displayed when both throttles are advanced beyond 27° THA if the stabilators are trimmed less than 3.5° TEU with the launch bar up (field takeoff) or 6.5° TEU with the launch bar down (carrier takeoff).

13. Controls - CHECK (tolerance $\pm 1^\circ$)

a. Control stick - CYCLE

- (1) Full aft - CHECK 24° NU STABILATOR (check left and right stabilators track symmetrically within $\pm 1^\circ$ of each other)

WARNING

At certain ejection seat heights, the A/A weapon select switch may hook the EJECTION handle at the full aft stick deflection. With an armed seat, inadvertent ejection initiation may occur if the stick returns to a neutral position.

- (2) Full fwd - CHECK 20° ND STABILATOR (check left and right stabilators track symmetrically within $\pm 1^\circ$ of each other)
- (3) Full L/R - CHECK 30° DIFFERENTIAL STABILATOR (21° with tanks or A/G stores on any wing station)

- CHECK DIFFERENTIAL TEFs

b. FLAP switch - HALF

c. Rudder pedals - CYCLE RUDDERS 40° L/R

d. FLAP switch - FULL (carrier-based)

e. TRIM - SET FOR CATAPULT LAUNCH (carrier-based)

14. PROBE, speedbrake, LAUNCH BAR switches and HOOK handle - CYCLE (LAUNCH BAR optional for shore based operations.)

CAUTION

Ensure HOOK handle is fully up to minimize the probability of inadvertent hook drops during catapult launch.

15. Pitot and AOA heat check - PERFORM

a. PITOT ANTI ICE switch - ON

- b. Make sure ground crew verify proper operation
- c. PITOT ANTI ICE switch - AUTO

WARNING

Failure of both AOA probe heaters in icing conditions may cause a sharp uncommanded nose down attitude, uncontrollable by normal stick forces or paddle switch actuation.

- 16. AV COOL switch emergency check (if ground personnel present)
 - a. AV COOL switch - EMERG then release
 - b. Make sure ground crew verify proper operation and stows emergency scoop.
- 17. APU - VERIFY OFF
- 18. FLBIT option - SELECT
- 19. BINGO - CHECK/SET
- 20. CVRS - AS DESIRED (*both cockpits*)
- 21. Standby attitude reference indicator - UNCAGE AND ERECT (*both cockpits*)
- 22. Altimeter setting - SET (*both cockpits*)
 - a. Altimeter setting displayed on HUD.
 - b. HUD altitude displayed within ± 30 feet of parking spot elevation.
 - c. Standby altimeter within ± 60 feet of parking spot elevation.

NOTE

If the standby altimeter barometric pressure is adjusted during the FCS IBIT, the altitude reading displayed in the HUD will not change until the IBIT is complete.

- 23. INS - CHECK
 - a. Alignment status - VERIFY COMPLETE
 - b. GPS HERR/VERR - VERIFY WITHIN LIMITS
 - c. INS knob - NAV or IFA

NOTE

- Prior to placing the INS switch to IFA for a GPS alignment or for AINS position keeping, ensure valid GPS data is available. AINS position keeping is normally available when GPS HERR and VERR are each less than 230 feet. Double digit GPS HERR/VERR (less than 100 feet) should guarantee AINS position keeping is available.
- Selecting IFA without good GPS data and without a complete carrier or ground alignment will cause the INS to attempt to perform a radar IFA and will halt/prevent alignment. If this occurs, return the INS knob to GND or CV (as appropriate).

d. Verify HUD airspeed indicates less than 50 kts.

24. *MUMI/ID - SELECT/ENTER DATE and FLT*

25. *Stores page - VERIFY PROPER STORE INVENTORY AND STATION STATUS*

26. *ZTOD/LTOD - BOX TO ENABLE HUD DISPLAY (if desired)*

NOTE

- The TIMEUFC option is removed from the HSI format if INS alignment is being performed (GND, CV, or IFA GPS).
- At GPS power up (first GEN online), SDC time and date are automatically sent to the GPS to aid the acquisition of satellites. After satellite acquisition, the GPS backloads satellite time to the SDC thus synchronizing the SDC with precise GPS time. This GPS time backload is only performed once per flight after the initial MC1 power up.
- Manually changing ZTOD, LTOD, or the DATE with WonW resets SDC time and/or date and reinitializes the GPS (even if GPS had a good satellite acquisition). GPS reinitialization will delay the availability of AINS position keeping. GPS time synchronization will not be available until a subsequent MC1 power-up (cold start). ARC-210 radios will need to be re-synched to enable HAVE QUICK operations.

27. *Weapons/sensors - ON/BIT CHECK (as required)*

28. *BIT page - NOTE DEGD/FAIL INDICATIONS*

29. HMD - ALIGN (*both cockpits*)**NOTE**

Canopy must be down and locked to align HMD/AHMD.

(CVRS record HMD if desired)

- a. SUPT/HMD/ALIGN page - SELECT
- b. Superimpose the HMD alignment cross on the HUD/BRU alignment cross.
- c. Cage/Uncage button - PRESS and HOLD until ALIGNING turns to ALIGN OK or ALIGN FAIL

If ALIGN FAIL -

- d. Repeat steps b and c.

If ALIGN OK and HMD alignment crosses are not coincident with HUD/BRU alignment cross -

- d. Perform FINE ALIGN.
 - (1) With FA DXDY displayed, use TDC to align azimuth and elevation HMD alignment crosses with the HUD/BRU alignment cross.
 - (2) Cage/Uncage button - PRESS and RELEASE
 - (3) With FA DROLL displayed, use TDC to align the roll axis HMD alignment crosses with the HUD/BRU alignment cross.
 - (4) Cage/Uncage button - PRESS and RELEASE

If satisfied with alignment -

- e. ALIGN - UNBOX
30. Standby attitude data - CHECK
- a. ATT switch - STBY
 - b. Verify INS attitude data is replaced by standby attitude data on the HUD and check agreement of standby and INS data.
 - c. ATT switch - AUTO
31. OBOGS system - CHECK
- a. OBOGS control switch - ON
 - b. OXY FLOW knob - ON/MASK ON (*both cockpits*)
 - c. OBOGS flow - CHECK

- d. OBOGS monitor electronic BIT pushbutton - PRESS AND RELEASE
- e. Verify OBOGS DEGD caution set and removed (within 15 seconds).
- f. OXY FLOW knob - OFF/MASK OFF (*both cockpits*)

WARNING

Continued operation and use of the OBOGS system with an OBOGS DEGD caution may result in hypoxia.

7.4 TAXI CHECKS

- 1. Canopy - EITHER FULL UP OR FULL DOWN FOR TAXI

CAUTION

Taxiing with the canopy at an intermediate position can result in canopy attach point damage and failure.

- 2. Normal brakes - CHECK
- 3. Nosewheel steering - CHECK IN HIGH MODE L/R

NOTE

When using brakes, apply firm, steady brake pedal pressure. Use nosewheel steering whenever possible, minimizing differential braking. Avoid dragging brakes or light brake applications except as necessary for drying wet brakes. Wet brakes can degrade brake effectiveness by as much as 50%. Hard momentary braking with wet brakes during taxi can reduce drying time. At heavy gross weight, make all turns at minimum speed and maximum practical radius.

7.5 TAKEOFF

7.5.1 Before Takeoff Checks.

■ **For MAX power catapult launches -**

- 1. ABLIM option - BOX
- 2. ABLIM advisory - VERIFY DISPLAYED

For all takeoffs -

- 3. CHKLST page (figure 7-2)
 - a. FUEL TYPE - VERIFY

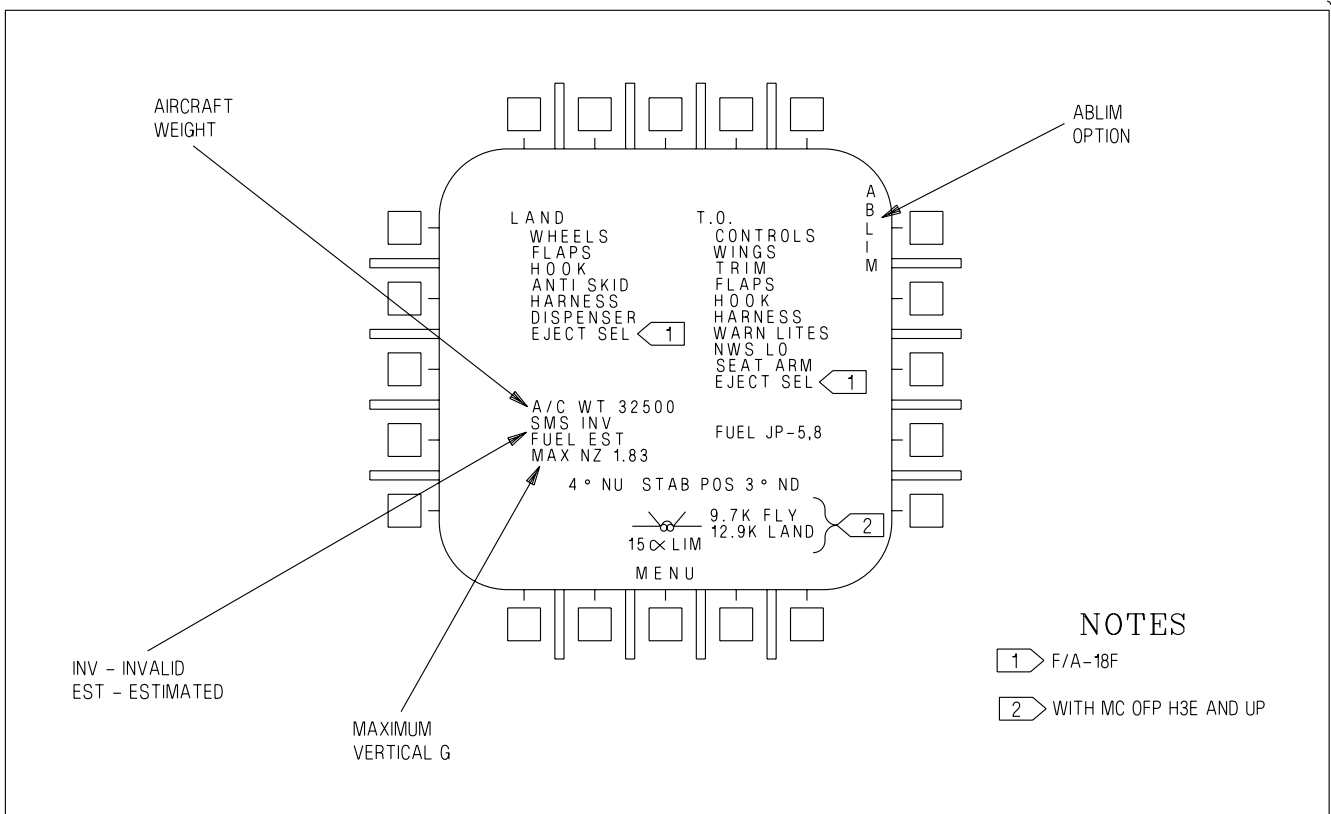

Figure 7-2. Checklist Display

EFN520-434-1-018

b. T.O. checklist - COMPLETE

WARNING

Ensure the WINGFOLD switch is lever-locked in the SPREAD position. If the wings are commanded to unlock or fold during a catapult shot, the wings will unlock, the ailerons will fair, the wings may fold partially, and the aircraft will settle.

CAUTION

WSO must make sure the EJECTION MODE handle is in AFT INITIATE (NORM) and, in Lot 21-24, aircraft the EMERG LDG GEAR and EMERG BRK handles are fully stowed.

NOTE

EJECT SEL is displayed in the F/A-18F only.

NOTE

Rear cockpit command eject is enabled when the *EJECTION MODE* handle is in the *AFT INITIATE* position. When a passenger unfamiliar with the *F/A-18F* occupies the aft cockpit, the *NORM* position may be utilized.

4. Canopy - CHECK CLEAR/CLOSED



Prior to operating the canopy switch, confirm aircrew are clear to reduce the potential for injury.

5. OXY FLOW knob - ON/MASK ON (both cockpits)

WARNING

It is possible to place the OXY FLOW knob in an intermediate position between the ON and OFF detents, which may result in a reduced flow of oxygen. The OXY FLOW knob should always be fully rotated to the ON or OFF detent position.

6. IFF sublevel - BOX REQUIRED MODES

7. PARK BRK handle - FULLY STOWED

8. ENG page - CHECK ENGINES AT MIL (if desired)

N ₁ RPM	86 to 98 %
N ₂ RPM	88 to 100 %
EGT	720 to 932° C
FF	11,000 pph max
NOZ POS	0 to 45 % open
OIL PRESS	80 to 150 psi

7.5.2 Normal Takeoff. Predictions for takeoff performance (nosewheel liftoff speed, takeoff speed, takeoff distance, and abort speed) should be calculated in the preflight brief based on aircraft configuration and expected ambient conditions. These predictions are based on the following technique: both engines stabilized at 80 % N₂ rpm, simultaneous brake release and throttle advance to MIL or MAX, ½-aft (2.5 inches) stick rotation at the predicted nosewheel liftoff speed. This technique should be used when ambient conditions and performance predictions warrant minimizing takeoff roll. Review these numbers prior to takeoff.

The takeoff checklist should be completed prior to taking the duty runway. For single-ship takeoffs, taxi to runway centerline and allow the aircraft to roll forward slightly to center the nosewheel. Begin the takeoff roll by releasing the brakes, advancing the throttles from IDLE to MIL, and checking EGT and RPM. If an afterburner takeoff is desired, further advance the throttles to MAX (full forward). Check for proper afterburner light-off as indicated by both nozzles opening. As the aircraft accelerates during the takeoff roll, track runway centerline using small rudder pedal inputs (e.g., NWS commands). NWS is the most effective means of directional control during takeoff. Differential

braking is much less effective and should therefore be avoided. The NWS system (low gain) incorporates a yaw rate feedback input from the FCCs, which is designed to suppress directional PIO tendencies by increasing directional damping during takeoff.

At nominal takeoff CG, aft stick will be required to rotate the aircraft. Approaching the predicted nosewheel liftoff speed, ease the stick back to approximately 1/3 to 1/2 aft stick (1-1/2 to 2-1/2 inches). Hold this input until the velocity vector rises to approximately 3 to 5°. Capture and climb/accelerate at the desired flight path angle.

When clear of the ground with a positive rate of climb, raise the LDG GEAR handle and place the FLAP switch to AUTO. In a flat takeoff attitude with MAX power selected, the aircraft will accelerate rapidly towards gear speed. If required, reduce power to MIL or below to ensure the landing gear is up and locked (light in the LDG GEAR handle is out) before passing 250 KCAS.



Takeoff performance is greatly affected by gross weight, center of gravity, power setting, stabilator position, and ambient conditions. Under adverse conditions (e.g., hot, heavy, and forward CG), takeoff speeds may be significantly higher than those routinely seen at nominal conditions. Knowing the aircraft's predicted takeoff performance should prevent a high speed abort in what is a normally functioning aircraft.



- Under the most extreme conditions (e.g., hot, heavy, and forward CG), nosewheel liftoff speed may exceed the nose tire limitation (195 KGS). The takeoff technique and/or the aircraft configuration may need to be adjusted to remain within limitations.
- Large aft stick inputs, particularly with CG near the aft limit, can result in significant over-rotation. With pitch attitude above 10°, the trailing edge of the stabilators can impact the ground if a large forward stick input is used to check the over-rotation. Above 14° pitch attitude, the engine exhaust nozzles may contact the ground. Therefore, pitch attitude shall not exceed 10° on takeoff.
- Takeoff with significant standing water (greater than 1/4 inch) on the runway may cause water ingestion, which in extreme cases can cause engine stalls, flameouts, AB blowouts, and/or engine FOD.

7.5.3 Crosswind Takeoff. Crosswind takeoffs should be performed using the normal takeoff technique. However, the pilot should expect to make slightly larger and more frequent rudder pedal inputs to track runway centerline. As the aircraft accelerates and the ailerons become effective, lateral stick into the wind may be desired to maintain wings level throughout the remainder of the takeoff roll and rotation. As the aircraft becomes light on the main wheels, the aircraft will tend to yaw into the wind. Slight main tire scrubbing can be expected. Allow the aircraft to crab into the wind at takeoff, while continuing to maintain runway centerline during the gear transition and early climbout.



When calculating crosswind component for takeoff or landing, use the full value of any reported gusts in your calculations.

7.5.4 After Takeoff Checks.

When definitely airborne -

1. LDG GEAR handle - UP
2. FLAP switch - AUTO

7.6 AIRBORNE CHECKS

7.6.1 Climb. For safe maneuverability of the aircraft, up to 350 KCAS may be required up to 10,000 feet. For optimum climb performance, refer to A1-F18EA-NFM-200.

7.6.2 10,000 Foot Checks.

1. *Cabin altimeter - VERIFY 8,000 FEET*
2. *Fuel transfer - CHECK INTERNAL and EXTERNAL*

3. *RALT - CHECK/SET to 5,000 FEET*

7.6.3 Cruise. Maximum range and maximum endurance data can be found in the performance charts contained in A1-F18EA-NFM-200. Maximum range cruise is approximated by establishing 3.0° AOA, but no faster than Mach 0.85. Maximum endurance cruise is approximated by establishing 3.7° AOA.

7.6.3.1 Cruise Check.

1. Cabin altimeter - MONITOR

Aircraft Altitude	Cabin Altitude
Less than 8,000 feet	Ambient
8,000 to 24,500 feet	8,000 feet
Greater than 24,500 feet	Alt x 0.4 (rule of thumb)

WARNING

A slowly increasing cabin pressure altimeter may be the first or only warning of a gradual loss of cabin pressurization.

7.6.3.2 RVSM Checks

When at assigned altitude on HUD -

1. AOA Crosscheck (REQUIRED ONCE)
 - a. Compare L and R AOA values on FCS page.
 - b. If L and R AOA values differ by more than 2°, notify ATC that the aircraft is no longer RVSM compliant.
2. Altitude Crosscheck (REQUIRED PERIODICALLY)

With MC OFF H5E AND UP -

- a. Compare STBY CHK value (HSI/DATA/(A/C)) to standby altimeter. These are uncorrected altitudes.

Otherwise -

- a. Add standby altimeter error (Standby Altimeter Error table below) to standby altimeter and compare to HUD altitude.

All aircraft -

- b. If altitudes differ by more than 250 feet, notify ATC that the aircraft is no longer RVSM compliant.
- c. If an "X" appears to the right of the HUD baro altitude box, notify ATC that the aircraft is no longer RVSM compliant.

Standby Altimeter Error	
Mach Number	Standby Altimeter Error (Feet)
0.50	120
0.60	150
0.65	175
0.70	200
0.75	220
0.80	280
0.85	260
0.90	330
0.92	380

7.7 LANDING CHECKS

7.7.1 Descent/Penetration. The windshield may fog rapidly under conditions of very high aircraft descent rates and high humidity. In such conditions, consider preheating the windshield by placing the DEFOG handle to HIGH and, if necessary, by placing the WINDSHIELD switch to either ANTI ICE or RAIN. The maximum comfortable cockpit temperature should be maintained to aid in windshield defog.

Normal instrument penetration is 250 KCAS with a 4,000 to 6,000 feet per minute descent rate. For safe maneuverability of the aircraft, up to 350 KCAS may be required below 10,000 feet. Refer to A1-F18EA-NFM-200, for optimum descent profiles. Before starting descent, perform the following:

7.7.1.1 Descent/Penetration Checks.

1. HOOK handle/HOOK BYPASS switch - AS REQUIRED/DESIRED
2. Exterior lights - SET FOR LANDING
3. Visual ID IDENT knob - NORM
4. ENG ANTI ICE switch - AS REQUIRED
5. PITOT ANTI ICE switch - AUTO
6. DEFOG handle - HIGH (if required)
7. WINDSHIELD switch - AS REQUIRED
8. Altimeter setting - CHECK

9. RALT - CHECK/SET
10. NAV master mode - SELECT (compare HUD with standby flight instruments and standby compass).
11. *Nav aids/MAG VAR - CROSSCHECK*
12. *ILS - ON/CHANNEL SET (if required)*
13. *IFF - AS DIRECTED*

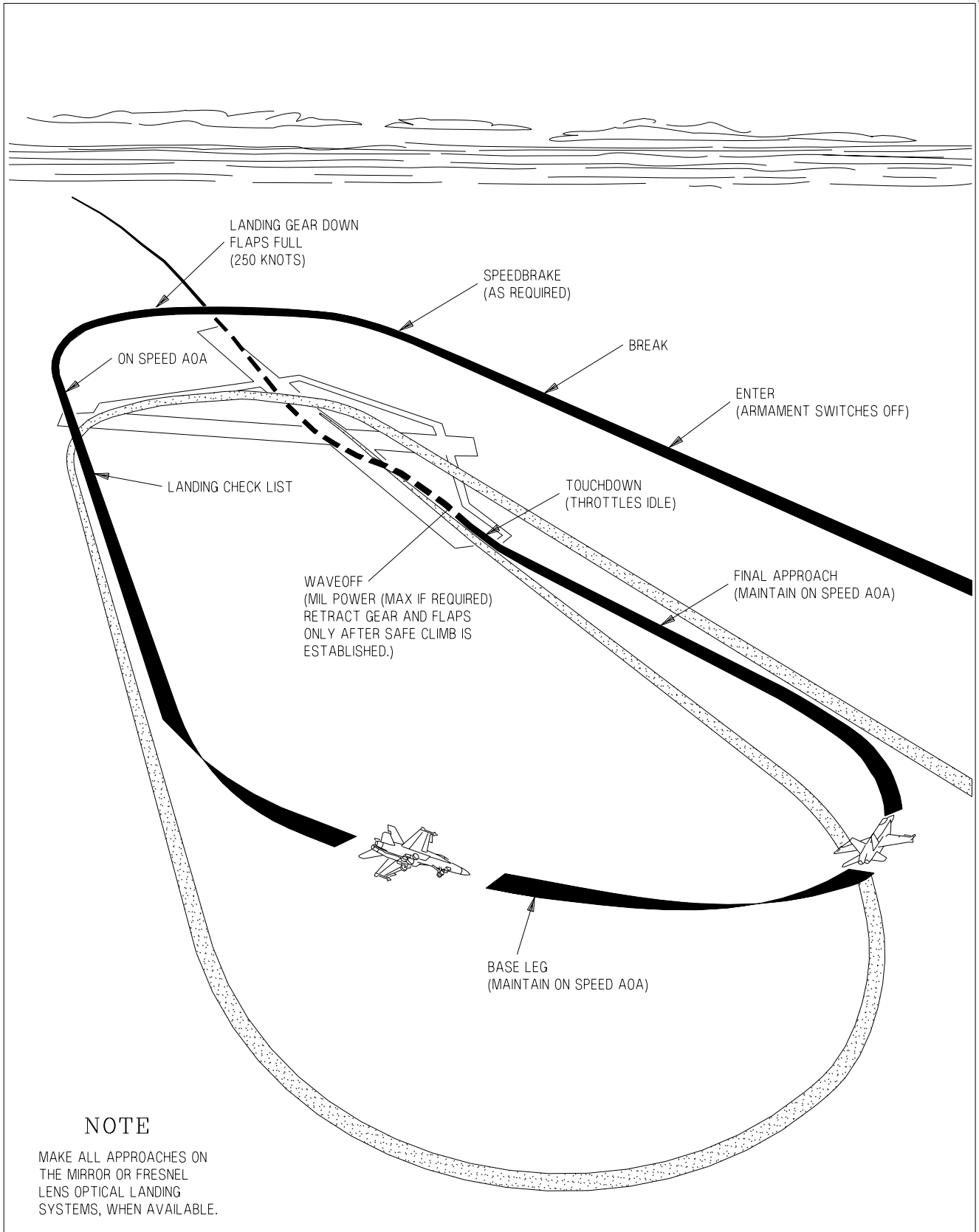

EFN520-11-1-001

Figure 7-3. Typical Field Landing Pattern

14. Weapons/sensors - OFF AS REQUIRED

7.7.2 VFR Landing Pattern Entry. See figure 7-3. Typically, the VFR landing pattern can be entered through several methods: the break, downwind entry, VFR straight-in, or low approach/touch-and-go from a GCA. Regardless of the entry method, enter the pattern at the altitudes and airspeeds prescribed by local course rules. A normal break is performed by executing a level turn to downwind with the throttles reduced to IDLE and the speedbrake function enabled (if required to reduce airspeed). The desired abeam distance is 1.0 to 1.3 nm. The g-level required to achieve the desired abeam distance will be a fallout of break airspeed.

As airspeed decelerates below 250 KCAS, lower the LDG GEAR handle and place the FLAP switch to FULL. If enabled, the speedbrake function will retract automatically when the FLAP switch is moved from the AUTO position. Continue to decelerate to on-speed AOA (8.1 deg). Longitudinal trim inputs are required with the flaps in HALF or FULL. The MI code for on-speed AOA is unit 14, address 15743, data 3300.

WARNING

In-flight Memory Inspect (MI) of FCC (UNIT 14 or 15) addresses (ADDR) greater than six digits long is prohibited since it may cause all four FCC channels to shut down which will result in loss of aircraft control.

With MC OFP H3E AND UP, the pitch trim AOA value is displayed on the HUD while trimming and for two seconds after trimming, and continuously on the FCS page with WoffW and flaps in HALF or FULL. The HUD value is displayed with or without ATC engaged but will not be displayed with autopilot engaged. If the autopilot is "paddled off" and AOA is greater than or equal to 6°, pitch trim is automatically set to on-speed. Trim the aircraft hands-off and on-speed. Compare airspeed and AOA. Onspeed AOA is approximately 136 KCAS at 44,000 lb gross weight (max trap). Subtract (add) 1½ KCAS for each 1,000 lb decrease (increase) in gross weight. Complete the landing checklist. When wings level on downwind, descend to pattern altitude (600 ft AGL for the low pattern). Ensure the ground track pointer is on the exact reciprocal of runway heading.

7.7.2.1 Landing Checks.

1. Landing checklist - COMPLETE:

WHEELS
FLAPS
HOOK
ANTI SKID
HARNESS
DISPENSER
EJECT SEL
AOA

2. Report - *AFT INITIATE, 3 DOWN AND LOCKED, FLAPS FULL (HALF), AOA CROSS-CHECKED*

7.7.3 VFR Landing Pattern and Approach. At the abeam position, pick a spot on the ground as a reference point. (At the ship, TACAN will be used to adjust abeam distance). Remember this abeam position, as all abeam distance corrections will use it as a reference. From the abeam position, time 20 seconds to arrive at a no-wind 180° position. To compensate for winds, subtract one second for each knot of final approach headwind component. At the 180, roll into 27 - 30° AOB, add power, and adjust rate of descent to 300 to 400 fpm. Maintain on-speed AOA. This should place the velocity vector about 1° below the horizon with its wingtip below the horizon bar. If required, adjust rate of descent to arrive at the 90° position at 450 ft AGL. Develop an instrument scan for the turn from the 180 to the 90, because an instrument scan will be required at the ship.

At the 90, glance at runway centerline and the lens and adjust AOB to arrive on extended centerline. From the 90, rate of descent must be increased by reducing power and adjusting the velocity vector to 1½ to 2° below the horizon, on-speed. This will produce a rate of descent of 400 to 500 fpm to arrive

at the 45° position at 320-370 feet AGL. From the 45, continue to increase rate of descent to approximately 500-600 fpm with a power reduction to arrive at "the start" on centerline, at 220 to 250 feet AGL, with 650 to 750 fpm rate of descent, on-speed. The optimum rate of descent will vary with glideslope angle, approach speed, and headwind component.

The approach turn from a pattern altitude greater than 600 ft AGL is slightly different. At the 180, adjust rate of descent between 400 - 700 fpm to arrive at the 90 at approximately 500 ft AGL. This requires a power reduction at the 180 rather than a power addition. Power will need to be added at the 90 to break the rate of descent to 400 to 500 fpm in order to arrive at the 45 at the same flight conditions as the low pattern.

7.7.4 Pattern Adjustments. Deviations to the standard no-wind pattern will be required based on headwind, crosswind, approach speed, and starts by adjusting abeam distance. Adjust the ground reference point and fly exactly the same AOB as the previous pass. Correct for long-in-the-groove or not-enough-straight-away starts by adjusting the timing from the abeam to 180° positions. Correct for high or low starts by adding or subtracting 20 to 50 feet from the target altitudes at and inside of the 90. The purpose of pattern adjustments is to determine a repeatable pattern technique which will produce consistent starts.

7.7.5 Final Approach. The desired final approach is flown by maintaining a centered ball to touchdown on runway centerline and on-speed. Timely, well-controlled power corrections will be required to capture and/or maintain the desired glideslope. A complete discussion of glideslope geometry and glideslope corrections will be covered during the FRS training syllabus and/or by squadron LSOs.

7.7.6 ATC Approaches. If an ATC approach is desired, engage ATC when wings level on downwind at or near on-speed AOA. With ATC engaged, the aircraft must still be manually trimmed to on-speed AOA. Unlike a manual throttles approach, nose position (i.e., velocity vector placement) now controls power. Fly the same pattern as a manual approach. Coming off the 180, roll into 27 to 30° AOB and lower the velocity vector approximately 1 to 2° below the horizon. ATC will add power as the aircraft rolls into the turn. Reposition the velocity vector to maintain 300 to 400 fpm rate of descent. Passing through the 90, lower the velocity vector slightly to pick up a 400 to 500 fpm rate of descent. Rolling wings level in the groove, lower the velocity vector further to about 3°. Power corrections required to adjust glideslope are made by repositioning the velocity vector with forward or aft stick inputs. For best results, make small corrections in velocity vector placement and be smooth. Avoid large, rapid, cyclic stick motion or "stick pumping" as these inputs can produce a PIO with the autothrottles.

Although ATC is capable of handling almost all glideslope corrections, the stick inputs required to successfully correct large deviations can be difficult to make. In general, if the ball is more than 1 ball from the center, consider disengaging ATC and executing a manual pass.

7.7.7 FPAH/ROLL - ATC Approaches. The FPAH/ROLL autopilot mode, when utilized with ATC, provides an alternative method for landing the aircraft. The FPAH/ROLL mode is designed to reduce pilot workload by maintaining flight path angle (FPA) and roll attitude. When the velocity vector is positioned as desired and the stick is neutralized, the autopilot maintains the current FPA and roll attitude, making corrections for wind gusts or disturbances as required. Repositioning the velocity vector with longitudinal or lateral stick inputs changes the reference FPA and/or roll attitude that the autopilot holds when the stick is released. In FPAH/ROLL, aircraft response to longitudinal stick inputs is slightly sluggish compared to CAS while response to lateral stick inputs is essentially the same.

Once the velocity vector is placed in the desired position, the stick is neutralized, and the pilot essentially monitors autopilot progress. Corrections should be small and applied only when required. Learning to make appropriate corrections and to stay out-of-the-loop when corrections are not required takes practice to achieve good results. With practice, smooth, consistent landings can be achieved even in gusty wind conditions.

NOTE

Use of FPAH/ROLL without ATC may result in more difficult AOA control and is not recommended.

7.7.7.1 FPAH/ROLL - ATC Approach Technique (field only). If an FPAH/ROLL - ATC approach is desired, engage ATC when wings level on downwind and trim for on-speed AOA. Select FPAH/ROLL from the A/P sublevel on the UFCD, and ensure both modes are boxed.

Fly the standard landing pattern utilizing the numbers and velocity vector positioning described in the ATC Approaches paragraph. A push and roll is required to establish the approach turn. Once the velocity vector is positioned, neutralize the stick and monitor autopilot progress. No back stick should be required in the turn. Passing through the 90 and approaching the start, push forward stick to lower the velocity vector and establish the desired rate of descent and then neutralize the stick. If on glideslope, roll wings level in the groove using only lateral stick inputs. Longitudinal stick inputs should not be required, as the autopilot compensates automatically to maintain FPA. Similarly, if on glideslope, make lineup corrections solely with lateral stick.

If the ball is not centered, adjust the velocity vector (i.e., reference FPA) up or down accordingly and allow the autopilot to fly the aircraft back to glideslope. Approaching a centered ball, adjust the velocity vector to the desired flightpath and neutralize the stick. The autopilot should then maintain FPA (ideally a centered ball) and compensate automatically for gusts. Make corrections with small, discrete longitudinal stick inputs and evaluate the correction before applying another. If the ball is centered and stable, the system works best if longitudinal inputs are minimized. There may be noticeable pitch motion, similar to what is seen on a Mode-1 ACLS approach, as the airplane responds to gusts, but FPA should be stable.

FPAH/ROLL is less capable at handling large deviations than CAS - ATC. In general, if the ball is more than 1 ball from the center, consider disengaging FPAH/ROLL with the paddle switch and executing an ATC or manual pass.

7.7.8 Full Stop Landings. Maintain approach rate of descent and power setting by flying a centered ball to touchdown or by placing the velocity vector at least 500 feet past the runway threshold. After touchdown, place the throttles to IDLE and track runway centerline using small rudder pedal inputs. The engines will not select ground idle until the aircraft has decelerated below 80 KCAS. While the rudders are effective above 100 KCAS, NWS is the most effective means of directionally controlling the aircraft during landing rollout. Low gain NWS is activated automatically at touchdown with weight on

the nose landing gear and at least one main landing gear. Differential braking to maintain directional control is not as effective and should normally be avoided.



Use of NWS HI during landing rollout is not recommended, as it may lead to directional PIO due to the increased sensitivity of the NWS system to rudder pedal inputs.

Engaging NWS HI while maintaining a rudder pedal input will greatly increase nosewheel deflection and may cause loss of directional control.

7.7.9 Braking Technique. Under normal circumstances, the best results are attained by applying moderate to heavy braking with one smooth application of increasing braking pressure as airspeed decelerates towards taxi speed. Anti-skid is effective down to approximately 40 KGS. Below 40 KGS, heavy brake pedal pressure should be relaxed to prevent tire skid. Below 35 KGS, steady but firm brake pedal pressure should be applied. Steady, light brake applications should be avoided, as they increase brake heating, do not significantly contribute to deceleration, and ultimately reduce braking effectiveness. If desired, selecting aft stick (up to full) below 100 KCAS will increase TEU stabilator deflection and aid in deceleration. Full aft stick increases down force on the main landing gear, as well as significantly increasing drag due to large stabilator size.



Recommended braking speeds are based on tests conducted at sea level. Ground speed may be significantly higher than calibrated airspeed at airfields above sea level. Aircrew should consider available runway length and field elevation to evaluate wheel brake usage and landing rollout distance to avoid excessive brake heat build up and subsequent tire deflation or wheel assembly fire when landing at airfields above sea level.

Maximum braking performance is attained by applying full brake pedal pressure (approximately 125 lb) immediately after touchdown. Anti-skid must be on to attain maximum braking performance and to reduce the risk of a blown tire. Longitudinal pulsing may be felt as the anti-skid cycles. Approaching 40 KCAS, full brake pedal pressure should be relaxed to prevent tire skid.

7.7.9.1 Aerobraking Technique. Aerobraking is not required under most circumstances. However, aerobraking is an effective method to slow heavy gross weight aircraft with a reduced risk of hot brakes and fire, or to slow aircraft on wet runways. Aerobraking is authorized under the following conditions:

- a. Crosswind 5 knots or less
- b. Pitch attitude 10° or less
- c. Greater than 80 KCAS
- d. GAIN ORIDE not selected
- e. No FCS AIR DAT or FLAP SCHED cautions

f. Flap position not changed during aerobraking

After main landing gear touchdown, smoothly apply aft stick to capture a positive pitch attitude with the waterline, not to exceed 10°. Directional control can be maintained with rudder pedal inputs and wings can be leveled with lateral stick. At approximately 100 KCAS, center rudder pedals and smoothly relax aft stick to allow the nose of the aircraft to fall. Avoid abrupt forward stick inputs to derotate. Once the nosewheel is on the ground, proceed with normal braking technique. Stopping distance using aerobraking should be approximately that experienced during normal braking.



Large, abrupt aft stick inputs, particularly with CG near the aft limit, can result in significant over-rotation. With pitch attitude over 10°, the trailing edge of the stabilators can impact the ground if a full forward stick input is used to check the over-rotation. Above 14° pitch attitude, the raised hook point or engine exhaust nozzles may contact the ground. Therefore, pitch attitude shall not exceed 10° during aerobraking and abrupt forward stick inputs to derotate should be avoided.

NOTE

Landing distance data in Chapter XI and the PCL are calculated on maximum braking performance technique listed above. The effect of aerobraking is not accounted for in the braking distance performance charts.

7.7.10 Heavy Gross Weight Landings. The aircraft's 50,600 lb GW field landing limitation provides the capability to land with a significant amount of fuel and/or stores (approximately 16,000 lb of bringback). Landing at heavy gross weight, however, requires that the pilot pay particular attention to braking technique and overall brake usage to avoid excessive brake and wheel assembly heating, melted fuse plugs, and deflated tires. The wheel assembly fuse plugs are designed to melt and deflate the tires at temperatures below those which would result in catastrophic tire blowouts. Wheel assembly temperatures do not, however, reach their peak until approximately 20 minutes after landing, e.g., it takes 20 minutes for the heat (energy) imparted to the brake assembly at landing to transfer into the wheel assembly. Due to this slow transfer of heat, it is not uncommon for an aircraft to pass a post flight hot brakes check yet still melt a fuse plug in the line.

In general, the aircraft's braking system is designed for landing under the following circumstances without melting a fuse plug: land at 50,600 lb GW, maximum anti-skid braking at 115 KCAS, three taxi stops from 30 KGS, park for 15 minutes, three more taxi stops from 30 KGS. If overall brake usage exceeds these criteria, melted fuse plugs and deflated tires may result. Below approximately 46,000 lb GW, brake usage following a maximum anti-skid landing (at or below 90 % of approach speed) should be unlimited. Therefore, any landing above 46,000 lb GW should be considered a heavy gross weight landing.

7.7.10.1 Heavy Gross Weight Braking Technique. Above 46,000 lb GW, delay the initial brake application to 115 KCAS or lower, if possible. Utilize aerobraking if desired and runway length is not a factor, otherwise normal braking technique or maximum anti-skid braking is acceptable. Release the brakes when desired taxi speed is reached. When clear of the runway, make a conscious effort to limit taxi speed and minimize brake applications, particularly if maximum anti-skid braking was utilized. If

overall brake usage is extensive, consider chocking the wheels and leaving the parking brake off to aid in brake cooling and to limit the amount of heat transferred to the wheel assembly.



Recommended braking speeds are based on tests conducted at sea level. Ground speed may be significantly higher than calibrated airspeed at airfields above sea level. Aircrew should consider field elevation when determining the calibrated airspeed at which brakes will be applied to avoid excessive brake heat build up and subsequent tire deflation or wheel assembly fire.

7.7.11 Crosswind Landings. During flight test, three crosswind landing techniques were evaluated: full-crab-to-touchdown, half-crab-kickout, and wing-down-top-rudder. In general, the half-crab-kickout technique works best and is recommended for all crosswinds up to 30 knots; the full-crab-to-touchdown technique is acceptable for moderate crosswinds only; and the wing-down-top-rudder technique is not recommended.



When calculating crosswind component for takeoff or landing, use the full value of any reported gusts in your calculations.

7.7.11.1 Half-Crab Kickout Technique. In crosswinds up to 30 knots, best crosswind landing results are attained by performing a half-crab-kickout technique. This technique reduces lateral and directional oscillations after touchdown and minimizes landing gear side loads.

Fly a full crab approach (wings level, neutral pedals) to approximately 50 feet AGL. Immediately prior to touchdown, apply one smooth rudder pedal input to "kick out" half of the crab angle. Maintain wings level. Allow the initial directional oscillations to subside, then utilize the normal braking technique. Stabilator braking with up to full aft stick does not degrade directional control and may be used to aid deceleration. Lateral stick into the wind will be required and is recommended to maintain wings level during landing rollout.

Avoid removing half the crab angle too early or removing more than half of the crab angle. This may cause the aircraft to drift downwind prior to touchdown and increases directional transients after landing.

7.7.11.2 Full-Crab-to-Touchdown Technique. The landing gear is capable of absorbing the sideloads imparted during a full-crab-to-touchdown landing in crosswinds up to 30 knots. However, in crosswinds above approximately 15 knots, the aircraft response produced by this technique can be uncomfortable. When the main gear contact the ground, the aircraft swerves downwind to align with the runway and rolls away from the crosswind and into the runway. This roll excursion can be as much as 8°. Two to three directional oscillations can be expected before the aircraft settles out and tracks straight. While this motion is controllable, lateral stick inputs to level the wings must be timely, and rudder pedal inputs must be judicious to control the directional transients. For this reason, a full-crab-to-touchdown technique is not recommended in crosswinds over 15 knots.

In crosswinds below 15 knots, the roll into the runway and ensuing directional oscillations are small, and the aircraft tends to track straight soon after touchdown. Fly a full-crab approach (wings level,

neutral pedals) all the way to touchdown. Apply lateral stick to keep the wings level, allow the small, initial directional oscillations to subside, and then utilize the normal braking technique.

7.7.11.3 Wing-Down-Top-Rudder Technique. Even in light to moderate crosswinds, a wing-down-top-rudder approach requires up to full rudder pedal displacement and an excessive bank angle (as much as 10°) to balance the aircraft with no drift. Landing in this attitude is uncomfortable and should be avoided. Additionally, any rudder pedal input applied at touchdown produces a large directional excursion when NWS automatically engages. For these reasons, a wing-down-top-rudder technique is not recommended.

7.7.12 Wet Runway Landings. Wet runway conditions can induce hydroplaning during landing rollout. The minimum total hydroplaning speeds of the main landing gear tires (280 psi) and the nose landing gear tires (150 psi) are 150 KGS and 110 KGS, respectively. Depending on runway conditions, partial hydroplaning can occur at much lower speeds. If the nose tires are hydroplaning, the aircraft may respond sluggishly to initial NWS commands. Under such circumstances, increasing rudder pedal inputs may cause directional excursions when nose tire contact is established. If hydroplaning is suspected, rudder pedal inputs should be kept as small as practicable.

For wet (standing water) runway conditions, reduce gross weight to the minimum practical. Land on-speed or slightly slow with the power reduced to idle as soon as possible. Maintaining a constant attitude and sink rate will help dissipate aircraft energy at touchdown. If directional control is questionable, do not hesitate to add power, go around, and set up for an arrested landing. If directional control is comfortable, use maximum anti-skid braking to minimize landing distance.

7.7.13 Asymmetric Stores Landings. The maximum lateral stores asymmetry for field landings is 29,000 ft-lb. For non-crosswind landings, the aircraft handles very much like a symmetrically loaded aircraft. Trim the aircraft for wings level flight and fly a normal on-speed approach to touchdown. During periods of moderate to heavy braking, expect the heavy wing to yaw forward. While easily controlled with small rudder pedal inputs, this motion should be anticipated and countered quickly to prevent a build up in yaw rate. Best results are attained by judiciously tracking runway centerline with timely rudder pedal inputs.

For crosswind landings, use the half-crab kickout technique recommended for normal crosswind landings. At touchdown, expect a slightly larger roll away from the crosswind and into the runway only if the wind is into the light wing. Lateral stick into the wind will be required and is recommended to maintain wings level during crosswind landing rollout, particularly when the wind is into the light wing.

Using this technique, asymmetric landings up to 29,000 ft-lb can be safely executed on a normal 3.25° glideslope up to 50,600 lb gross weight and in a 30 knot crosswind.

7.8 POST-FLIGHT CHECKS

7.8.1 After Landing. Do not taxi with the right engine shut down, as normal brakes and NWS are not available.

7.8.1.1 After Landing Checks.

When clear of active runway -

1. Ejection seat SAFE/ARMED handle(s) - SAFE (*confirm status in both cockpits*)

2. *EJECTION MODE handle - NORM***WARNING**

Make sure the ejection seat SAFE/ARMED handle is locked in the SAFE position detent and that the word SAFE is completely visible on the inboard side of the handle. If the handle will not lock in the detent or the word SAFE is not completely visible, check to ensure that the ejection control handle is fully stowed and attempt to resafe the seat. If unable to properly safe the ejection seat, instruct line personnel to remain clear of the cockpit until the seat is checked by qualified maintenance personnel.

3. Landing gear handle mechanical stop - CHECK FULLY ENGAGED

CAUTION

If the DOWNLOCK ORIDE button is pressed or the mechanical stop is not fully engaged, the LDG GEAR handle can be raised on the ground, and the main landing gear will retract.

4. FLAP switch - AUTO

5. T/O TRIM button - PRESS UNTIL TRIM ADVISORY DISPLAYED

6. Mask - OFF (*confirm status both cockpits*)

7. OBOGS system - SECURE

a. OXY FLOW knob - OFF (*both cockpits*)

b. OBOGS control switch - OFF

8. Canopy - EITHER FULL UP OR FULL DOWN FOR TAXI

CAUTION

- Taxiing with canopy at an intermediate position can result in canopy attach point damage and failure.
- Prior to operating the canopy switch, confirm aircrew are clear and all loose equipment is stowed to reduce the potential for injury and/or

engine FOD.

NOTE

Once the ejection seat(s) are confirmed *SAFE and the EJECTION MODE handle is in the NORM position*, it is safe to unstrap.

Adjusting seat height after the upper Koch fittings are removed may damage the ejection seat trombone fittings.

7.8.2 Hot Refueling. When hot refueling for a subsequent flight, the RADAR switch may be left in OPR or STBY. However, if feed tank fuel temperatures are approaching their 79°C limit, consider turning off the radar to aid in RLCS/fuel cooling.

Hot refueling must be performed with the canopy closed. Expect the REFUEL DR caution to be displayed when ground crew open door 8R to expose the single point refueling receptacle. If refueling of external tanks is not desired, the appropriate EXT TANKS switches must be placed to STOP. Otherwise, hot refueling through the single point receptacle will fill all internal and external tanks.

NOTE

When hot refueling in Lots 21 thru 25, the IFR probe must be extended to refuel any external fuel tanks loaded on the inboard stations (4 and 8) when external fuel tanks are loaded on the midboard stations (3 and 9).

The EFD and/or FUEL display can be referenced to monitor refueling progress. Expect external tanks to refuel slowly until the internal tanks are full.

If an internal tank refuel valve has failed or is leaking, that tank will overflow and direct fuel into the aircraft vent system. If the aircraft vent tanks overflow, fuel will spill from the vertical tail vent outlets.

When hot refueling is complete, ensure that the fuel cap is properly installed and door 8R is closed: the REFUEL DR caution should be out and the plane captain/final checker shall give the confirmation signal. This signal is a cupped, open hand rotated counterclockwise then clockwise followed by a thumbs up.

For a subsequent flight, expect final checks prior to taxi for takeoff. If placed to OFF prior to refueling, the RADAR switch may be reselected to OPR when refueling is complete.

WARNING

A failed or leaking refuel valve can cause rapid overfilling of the aircraft vent system, fuel spillage from the vent outlet(s), and possible fire if fuel spills on hot engine components. If this occurs, discontinue hot refueling immediately.

7.8.3 Before Engine Shutdown Checks.

1. PARK BRK handle - SET
2. *BIT display - RECORD DEGD/FAIL INDICATIONS*

3. *Radar maintenance (BOA) codes - RECORD IF PRESENT*
4. RADAR knob - OFF
5. *FCS display - RECORD BLIN CODES*
6. *EFD - RECORD MSP CODES*
7. *INS - PERFORM POST FLIGHT UPDATE (if desired)*
8. INS knob - OFF
9. Standby attitude reference indicator - *CAGE (both cockpits)*
10. HMD switch - OFF *(both cockpits)*
11. CRYPTO switch - AS REQUIRED

NOTE

Ensure the MIDS terminal is on, by ensuring L16 or TACAN is ON, prior to any attempt to zeroize IFF Mode 4 Crypto Keys via the CRYPTO switch.

12. Sensors, avionics, and CVRS - OFF

NOTE

The aircraft incorporates an avionics auto-shutdown feature which powers down all UFCD controlled avionics when both throttles are secured (ac power removed). Therefore, UFCD controlled avionics do not need to be secured prior to shutdown.

13. EXT and INTR LT knobs - OFF *(both cockpits)*
14. Canopy - CHECK CLEAR/OPEN

WARNING

A high voltage (100,000 volt) static electrical charge may build up in flight and be stored in the windscreen and canopy. If possible, ensure that ground crew discharge the static electricity prior to egress. Otherwise, avoid direct contact with the outside of the windscreen and canopy to prevent electrical shock.

15. QDC - DISCONNECTED AND STOWED

CAUTION

Failure to disconnect QDC prior to pilot egress will damage the lower IRC connection.

7.8.4 Engine Shutdown Checks.

1. Brake accumulator gauge - CONFIRM 3,000 PSI
2. Paddle switch - PRESS (disengage NWS)
3. Confirm 5 minute engine cool down.

NOTE

Before engine shutdown, both engines should be operated at ground idle (75% N_2 or less) for 5 minutes to allow engine temperatures to stabilize and to prevent engine seizure and rotor damage.

4. BLEED AIR knob - OFF

NOTE

If an engine is shutdown before placing the BLEED AIR knob to OFF, the corresponding primary bleed air shutoff valve may not fully close, resulting in residual engine fumes in the cockpit on subsequent start of that engine.

5. Throttle - OFF (alternate sides)
6. Verify proper switching valve operation.

After hydraulic pressure decays through 500 psi -

- a. FLAP switch - FULL
- b. If aileron, rudder, or LEF surfaces X and the Xs do not clear after one FCS reset attempt, maintenance action is required.

- c. If one FCS reset attempt was required to reset surface Xs, cycle FLAP switch to AUTO then back to FULL. If Xs reappear, maintenance action is required.

7. FCS page - Verify no channel is completely Xd out.

NOTE

If an FCS channel is completely Xd out with one engine shutdown, that channel is not being powered by essential bus backup, and maintenance action is required.

8. COMM 1 and 2 knobs - OFF (*both cockpits*)

9. L (R) DDI, HUD, and MPCD knobs - OFF (In the F/A-18F, confirm all COMM and display knobs OFF in both cockpits).

10. Other throttle - OFF

When amber FLAPS light illuminates -

11. BATT switch - OFF

WARNING

Due to FCS keep alive circuitry, uncommanded flight control movement may occur for up to 10 seconds after the BATT switch is placed to OFF if residual hydraulic pressure is still present.

CHAPTER 8

Carrier-Based Procedures

8.1 GENERAL

The CV and LSO NATOPS Manuals are the governing publications for carrier-based operations and procedures. All flight crewmembers shall be familiar with CV NATOPS procedures prior to carrier operations.

8.2 DAY OPERATIONS

8.2.1 Preflight Checks.

1. Exterior Inspection - Perform IAW NATOPS

Conduct a normal preflight inspection with particular attention given to the landing gear, day ID light, struts, tires, and arresting hook. Check the underside of the fuselage and stabilators for possible arresting cable damage. Note the relationship of the APU exhaust port and the arresting hook to the deck edge and, for example, catwalk fire extinguishers. If APU exhaust is a factor, the aircraft may need to be respotted prior to start. Do not lower the hook during poststart checks unless the hook point will drop onto the flight deck. A hook check may have to be delayed until the aircraft is taxiied forward. Make sure sufficient clearance exists for cycling ALL control surfaces.



The maximum wind allowed for canopy opening is 60 kt. Opening the canopy in headwinds of more than 60 kt or in gusty or variable wind conditions may result in damage to or loss of the canopy.

2. Interior Checks - Perform IAW NATOPS with two exceptions:

- a. External lights master switch - OFF (Required for proper operation of the Day ID strobe light on the nose landing gear)
- b. ANTI SKID switch - OFF

A rectangular icon with a thick black border containing the word "WARNING" in bold, uppercase letters.

WARNING

Ensure the ANTI SKID switch is OFF for all carrier operations to ensure that full brake authority is available (including locking a tire).

8.2.2 Hangar Deck Operation. Occasionally the aircraft may be manned on the hangar deck. Follow the same procedures as those concerning flight deck operations.

Tiedowns shall not be removed from the aircraft unless the emergency brake accumulator pressure gauge indicates at least 2,600 psi. Emergency brakes shall be used for stopping the aircraft anytime it is being moved while the engines are not running. The signal to stop an aircraft that is being towed is either a hand signal or a whistle blast. The whistle signifies an immediate or emergency stop. Once in the cockpit, leave the canopy open and helmet off to ensure hearing the whistle. Keep the taxi director in sight at all times. If unable to see the taxi director, or if in doubt of safe aircraft movement, stop the aircraft immediately.

If the aircraft is not already on the elevator, it will be towed or pushed (with the pilot in the cockpit) into position to be raised to the flight deck. Ensure tiedowns are in place; set the parking brake; and close the canopy. Ensure the parking brake is set anytime the aircraft is stopped on the elevator.

8.2.3 Engine Start. Do not start the engines until directed to do so by the tower/Air Boss, typically 30 minutes prior to the stated launch time. APU starts should be made whenever possible. Crossbleed starts must be approved by the Air Boss due to the relatively high power setting required, and the potential for injury from jet blast.

8.2.3.1 Before Taxi Checks.

1. Before Taxi Checks - Perform IAW NATOPS and ensure:
 - a. FLAP switch - FULL
 - b. TRIM - SET FOR CATAPULT LAUNCH

Ensure the T/O TRIM button is pressed until the TRIM advisory is displayed (stabilators 4° TEU). Horizontal stabilator trim should be manually set for catapult launch IAW figure 8-1 Tables A thru G. Launches with less than 15 knot excess endspeed require additional trim to compensate for the reduced launch speed. If the aircraft is loaded asymmetrically, lateral trim (differential stabilator with WonW) should also be manually set IAW figure 8-1 Table G. Trim laterally into the light wing (unloaded wing down). The trim settings are designed to keep roll off less than 5° for 3 seconds after WoffW. Obviously, not all possible external store configurations could be evaluated. Therefore, some external store configurations may exhibit more or less roll off at the Table G trim setting. Launches above 15 knots excess would require less lateral trim. Higher excess endspeeds, mis-set trim conditions were tested and the aircraft is easily controlled with lateral stick. The key is to trim in the correct direction, which is unloaded wing down.

Correct stabilator trim is critical to aircraft fly-away performance (hands-off). The stabilator trim setting determines the aircraft's initial pitch rate and sets the reference AOA that the FCS attempts to hold after launch. Reference AOA is set to 12° when the stabilators are trimmed to 6° TEU or higher. Between 4° and 6° TEU stabilator, reference AOA is steeply changed from 4° to 12°. The recommended launch trim settings are designed to provide the aircraft with a consistent 10° to 12°/sec pitch rate regardless of gross weight, CG, or catapult endspeed. Trim settings above those recommended in tables D and E or launches with greater than 15 knot excess endspeed will maintain the 12° reference AOA but will be characterized by increased pitch rates. Normal catapult launches are characterized by an initial rotation as high as 13° AOA before AOA and pitch rate feedbacks reduce AOA to the reference value. For light gross weight launches, peak pitch rates will be higher and peak AOA's will be lower due to the V_{mc} based launch speed. At heavier gross weights, a range of 10° thru 14° AOA can be expected during launch and is the best compromise between minimizing sink-off-bow and

ensuring controllability in the event of an engine failure. If stabilator trim is less than 6.5° , the CK TRIM caution will be set when the throttles are advanced above 27° THA (FLAP switch FULL).

- c. External fuel tank quantities - CHECK



Do not catapult with partially full external fuel tank(s) ($\leq 2,700$ lbs). Fuel sloshing may cause structural damage to the tanks, pylons, and/or airframe.

8.2.4 Catapult Trim. See figure 8-1.

CATAPULT TRIM CALCULATIONS

1. Enter with:

Example

Gross Weight _____ (60K)

CG from Form-F _____ (19%)

Lateral Weight Asymmetry _____ (9,000 ft-lb)

2. Using Gross Weight and Table A, determine type power setting for launch (MIL or MAX)

Catapult Power Setting Requirements	
Weight Board (1,000 lb)	Power Setting
64 to 66 (66.8*)	MAX only
58 to 63	MAX (MIL optional if density altitude is ≤ 3,000 ft)
46 to 57	MIL (MAX optional)
32 to 45	MIL only

Table A

* 5 Wet Tanker only

Example

Type Launch 60,000 lb with 3,500 ft DA _____ (MAX)

WARNING

To reduce engine susceptibility to steam ingestion and compressor stalls, transition from MIL to MAX during the catapult stroke shall not be performed except in an emergency.

Figure 8-1. Launch Trim (Sheet 1 of 5)

3. Using Gross Weight and Lateral Asymmetry, determine expected endspeed. Use Table B if symmetric or the higher endspeed of Tables B and C if asymmetric.

Catapult Launch Endspeed (Symmetrical Loading 0-2,500 ft-lb)		
GW (1,000)	Endspeed (MIN +15) (KCAS)	
	MIL	MAX
66.8*	-	164*
66	-	161
65	-	160
64	-	
63	165	
62	163	
61	161	
51-60	160	
≤50	153	153

Table B

* 5 Wet Tanker only

Catapult Launch Endspeed (Station 2 -10 Asymmetric Loading)		
Station 2-10 Asymmetry Level (ft-lb)	Endspeed (Min +15) (KCAS)	Weight Board Designation (xx,Xxx)
Sym Level 0 (0-2,500)	Table B	0
Asym Level 1 (2,501-9,000)	165	1
Asym Level 2 (9,001-17,000)	170	2
Asym Level 3 (17,001-29,000)	174	3

Table C

Example:

Expected Endspeed: 60 Klb, 9,000 ft-lb asymmetry, MAX Power_____ (165 KCAS)

Figure 8-1. Launch Trim (Sheet 2 of 5)

4. Determine required baseline longitudinal trim using Table D (MIL Power) and Table E (MAX Power). Enter with launch endspeed from Table B or C and Form-F CG. Determine longitudinal trim setting, interpolating between CG columns if required. The trim settings contained in Tables D and E

are set up for 15 knot excess endspeed launches. Launches with greater than 15 knots excess will have higher pitch rates but will maintain the same capture AOA target.

Longitudinal Trim - MIL Power						
Endspeed (KCAS)	Form - F CG (%MAC)					
	18	19	20	21	22	≥23
153	20	18	15	12	10	7
160	16	13	11	8	7	
161	15	12	10	7		
163	14	11	8			
164	13	10	8			
165	12	9	7			
170	8	7				
174	7					

Catapult Launch Trim MIL Power - Table D

Note: A 10 knot excess endspeed launch would require 4° additional nose up trim from the nominal settings.

Longitudinal Trim - MAX Power							
Endspeed (KCAS)	Form - F CG (%MAC)						
	18	19	20	21	22	23	≥24
153	22	20	17	14	12	9	7
160	19	16	13	11	8	7	
161	18	15	13	10	7		
163	17	14	11	8			
164	16	13	10	8			
165	15	12	10	7			
170	11	9	7				
174	8	7					

Catapult Launch Trim MAX Power - Table E

Note: A 10 knot excess endspeed launch would require 4° additional nose up trim from the nominal settings.

Example:

Baseline Longitudinal Trim: 165 KCAS, 19 % CG_____ (12°)

Figure 8-1. Launch Trim (Sheet 3 of 5)

5. Longitudinal trim **MUST** be adjusted for the aft CG shift that occurs during normal fuel burn. The CG can shift as much as 3% MAC (F/A-18E) or 1% MAC (F/A-18F) when Tank 2 fuel drops to approximately 2,200 lb and Tank 1 fuel drops to approximately 1,000 lb. This CG shift can affect longitudinal trim by as much as 7° and must be accounted for to prevent catapult launch with a significant over-trim. Once Tank 1 has dropped to approximately 1,000 lb, fuel scheduling maintains the CG at an essentially neutral position. Table F is a rule-of-thumb for decreasing longitudinal trim based solely on Tank 1 fuel quantity. Decrease baseline longitudinal trim by the “Trim Delta” value **down to but in no case less than 7° TEU stabilator.**

Trim Adjustments for Normal Fuel Burn		
Tank 1 Fuel Quantity (lb)	Trim Delta - (°)	
	F/A-18E	F/A-18F
2,100	-3	-
1,500	-5	-
1,000	-7	-2

Table F

Example

Baseline Longitudinal Trim from Step 4: _____ (12°)

Adjusted Longitudinal trim: Tank 1 fuel 2,000 lb _____(9°)



Failure to make Tank 1 fuel quantity trim adjustment will result in an over trimmed condition, which may aggravate aircraft controllability, particularly following a single engine failure.

NOTE

If longitudinal trim must be adjusted after differential stabilator has been input for a lateral weight asymmetry, push the T/O TRIM button, adjust longitudinal trim and re-input differential stabilator.

Figure 8-1. Launch Trim (Sheet 4 of 5)

6. If asymmetric, determine required differential stabilator (lateral trim) from Table G. Input differential stabilator after longitudinal trim has been set, trimming into the light wing (unloaded wing down).

CATAPULT LAUNCH LATERAL TRIM	
Station 2-10 Lateral Weight Asymmetry (ft-lb)	Differential Stabilator - Unloaded Wing Down (°)
0 - 2,500	0
2,501 - 5,500	1
5,501 - 9,500	2
9,501 - 13,500	3
13,501 - 16,500	4
16,501 - 19,500	5
19,501 - 25,500	6
25,501 - 29,000	7

Table G

Example:

Lateral weight asymmetry: _____(9,000 ft-lb)

Differential Stabilator (unloaded wing down): _____(2°)

Therefore, if you set longitudinal trim of 9° nose up, a 2° differential stabilator trim would result in an 8/10 or 10/8 nose up stabilator trim (depending on asymmetric loading) setting on the DDI FCS page.



Failure to input differential stabilator trim for catapult launches with asymmetric stores can aggravate aircraft controllability, particularly following a single engine failure.

Figure 8-1. Launch Trim (Sheet 5 of 5)

8.2.5 Taxi. The canopy should be down with oxygen mask on and the ejection seat armed prior to aircraft breakdown and during taxi. Taxiing aboard ship is similar to confined area taxiing ashore. However, be aware of jet exhaust from other aircraft and the relative position of own nozzles. Typically, the wings are folded until the aircraft is positioned behind the jet blast deflector (JBD), so full-time NWS HI should normally be available. NWS HI is recommended for carrier operations and should provide excellent turning capability for directional control aboard ship. Taxi speed should be kept under control at all times, especially on wet decks, in the landing area, and approaching the catapult. Taxi signals from the flight deck directors (yellow shirts) are mandatory.

Be prepared to use the emergency brakes should normal braking fail. In the event of loss of brakes, inform the tower and lower the tailhook immediately to indicate brake loss to deck personnel.

8.2.6 Takeoff Checks.

For MAX power catapult launches -

1. ABLIM option - BOX
2. ABLIM advisory - VERIFY DISPLAYED

All catapult launches -

3. T.O. checklist - COMPLETE (from bottom to top - EJECT SEL thru TRIM)

8.2.6.1 Catapult Hook-Up. The aircraft will be taxiied over the JBD and aligned with the catapult track. Approach the catapult track slowly, lightly riding the brakes with NWS engaged. Use the minimum power required to keep the aircraft rolling. Close attention to taxi director signals is required to properly align the aircraft with the catapult track entry wye. If the taxi director is obscured by steam from the catapult, stop the aircraft.

Prior to taxi past the shuttle -

4. Weight board - "Roger" gross weight and asymmetry level (if in accordance with figure 8.1, Tables B and C). The hundreds place on the weight board designates the asymmetry level (see figure 8-1 Table C) in order to set the proper catapult settings for launch. For example, if the aircraft's gross weight is 60,000 lb with 9,000 ft-lb of asymmetry, the 9,000 ft-lb falls within asymmetry level 1, and the aircrew will "Roger" a weight board that reads 60,100.

5. WINGFOLD switch - SPREAD and report: SPREAD and LOCKED, BEER CANS DOWN, CAUTION OUT, SWITCH LEVER-LOCKED

WARNING

Ensure the WINGFOLD switch is lever-locked in the SPREAD position. If the wings are commanded to unlock or fold during a catapult shot, the wings will unlock, the ailerons will fair, the wings may fold partially, and the aircraft will settle.

6. Missile arming - COMPLETE (if required)

When directed -

7. L BAR switch - EXTEND (green LBAR light on)
8. NWS button - PRESS and HOLD (if required to position launch bar)

Once the launch bar has been lowered, do not engage NWS unless directed to do so, since catapult personnel may be in close proximity to the launch bar. Once the launch bar enters the catapult track, do not use NWS. The catapult crew will install the holdback bar as the aircraft taxis forward. Taxi forward slowly, following the signals of the taxi director or Catapult Officer. When the launch bar drops over the shuttle spreader, the aircraft will be stopped by the holdback bar engaging the catapult buffer.

8.2.7 Catapult Launch.

When "Take Tension" and "Launch Bar Up" signals received -

9. Throttles - MIL
10. L BAR switch - RETRACT (green LBAR light out)

WARNING

Due to the close proximity of the FLAP and LAUNCH BAR switches, ensure that the FLAP switch is not inadvertently placed to AUTO. Launching with the flaps in AUTO will result in an excessive settle.

CAUTION

Failure to place the LAUNCH BAR switch to RETRACT prior to catapult launch may result in hydraulic seal failure and possible loss of HYD 2A.

11. Controls - CYCLE and report FREE and CLEAR (Takeoff Checks complete)
Wait 5 seconds and ensure all warning and caution lights are out.
12. Engine instruments - CHECK

When "Select AB" signal received (MAX power launches only) -

13. Throttles - MAX

When ready for launch -

14. Salute with right hand. Hold throttles firmly against the detent and place head against the headrest.

Throttle friction may be used to help prevent inadvertent retraction of the throttles during the catapult stroke. If required, it can be overridden if afterburner is needed due to aircraft/catapult malfunction. Immediately after the end of the catapult stroke, the aircraft will rotate to capture the 12° reference AOA (hands-off). To avoid PIO with the FCS, do not restrain the stick during catapult launch or make stick inputs immediately after catapult launch. The pilot should attempt to remain out of the loop but should closely monitor the catapult sequence.

WARNING

To reduce engine susceptibility to hot gas reingestion and compressor stalls, transition from MIL to MAX during the catapult stroke shall not be performed except in an emergency.

Once safely airborne -

15. LDG GEAR handle - UP
16. Clearing turn - PERFORM (if required)

With positive rate of climb and clearing turn complete -

17. FLAP switch - AUTO

NOTE

During catapult launches performed at heavy gross weight, the TEFs may begin to retract prior to FLAP switch actuation (at approximately 190 KCAS) in order to follow the loads alleviation schedule.

8.2.7.1 Catapult Suspend. To stop the launch while in tension on the catapult, signal by shaking the head negatively and transmitting "SUSPEND, SUSPEND" on land/launch frequency. Do not use a thumbs down signal or any hand signal that might be mistaken for a salute. The Catapult Officer will reply with a "SUSPEND" signal followed by an "UNTENSION AIRPLANE ON CATAPULT" signal. The shuttle spreader will be moved aft and the launch bar will automatically raise clear of the shuttle spreader. Maintain power at MIL or MAX until the Catapult Officer steps in front of the aircraft and gives the "throttle-back". The same signals will be used when a catapult malfunction exists.

8.2.7.2 Catapult Endspped Requirements. Catapult endspeeds are established to provide safe flyaway during normal launch conditions and to allow the pilot to maintain aircraft control in the event of a single engine failure. The catapult endspeeds are not based on single engine rate of climb (SEROC) capability, nor do they guarantee single engine flyaway performance. The minimum endspeed

requirement is calculated to provide sufficient airspeed and altitude to maintain aircraft control while executing emergency catapult flyaway procedures.

F/A-18E/F minimum catapult launch endspeeds are governed by three limiting factors: Flaps FULL minimum single engine control speed (V_{mc}), maximum longitudinal acceleration capability, and sink-off-bow. V_{mc} is the airspeed below which the aircraft is not controllable with a single engine failure. The V_{mc} airspeed governs the endspeed for most of the gross weight range in both MIL and MAX power (up to 60K MIL and 65K MAX, see figure 8-1, Table B). V_{mc} is also a function of lateral weight asymmetry; therefore, endspeed must be increased for asymmetric loadings (see figure 8-1, Table C). The catapult endspeed above 60K in MIL is governed by aircraft longitudinal acceleration capability which limits maximum gross weight for MIL power launches (see figure 8-1, Table A). Endspeeds above 65K in MAX are governed by the aircraft CG 10 foot sink-off-bow limit. Actual catapult endspeeds in the Aircraft Launching Bulletins are computed to launch at the minimum endspeed plus 15 knots ($V_{min} + 15$) (figure 8-1, Table B and C). FULL flap launches are required to meet wind-over-deck requirements at heavy gross weights. HALF flap launches have not been tested, and would increase launch wind-over-deck by approximately 10 knots.

8.2.7.3 Catapult Launch Flyaway Characteristics. Launches at light gross weights are characterized by higher pitch rate and attitude, higher rate of climb, and lower peak AOA when compared to heavy gross weight launches. Forward stick may be required following the rotation to control pitch attitude as the aircraft accelerates.

There is a noticeable difference in aircraft flyaway characteristics from light to heavy weights due to the transition from the V_{mc} based launch speeds to either the longitudinal acceleration or sink-off-bow based airspeeds. Heavy weight launches will be characterized by reduced pitch rates and attitudes, and higher peak AOA when compared to the light weight launches. Light buffet may be felt as the aircraft rotates through 11° AOA during launch at heavier gross weights. The longitudinal trim settings will provide the required $10\text{-}12^\circ/\text{sec}$ pitch rate and capture a target AOA of 12° ; however, peak AOA may reach 15° momentarily. Maintaining hands off the stick during rotation is crucial to optimizing launch performance and reduces the tendency for pilot induced oscillations during rotation and initial flyaway. With normal endspeed and steady deck conditions, the aircraft CG settles up to 3 feet. The pilot perceives the catapult launch to be level, as rotation keeps the pilot's eye approximately level even though the aircraft CG sinks. With less than 15 knots of excess endspeed, more settle will occur up to a maximum of 10 feet of settle with zero excess endspeed. Launches anticipated with less than the normal 15 knot excess endspeed require additional longitudinal trim to compensate for the reduced launch speed. A 10 knot excess endspeed launch would require 4° additional nose up trim from the nominal settings in figure 8-1, Tables D and E.

8.2.8 Landing Pattern. Refer to Chapter 4, for carrier operating limitations. While maneuvering to enter the traffic pattern, attempt to determine the sea state. This information will be of value in predicting problems that may be encountered during the approach and landing.

Enter the carrier landing pattern at 800 feet AGL (figure 8-2) with the hook down. Make a level break from a course parallel to the Base Recovery Course (BRC), close aboard to the starboard side of the ship. Below 250 KCAS lower the gear and flaps. The speedbrake function automatically retracts when the FLAP switch is moved to HALF or FULL. Descend to 600 feet AGL when established

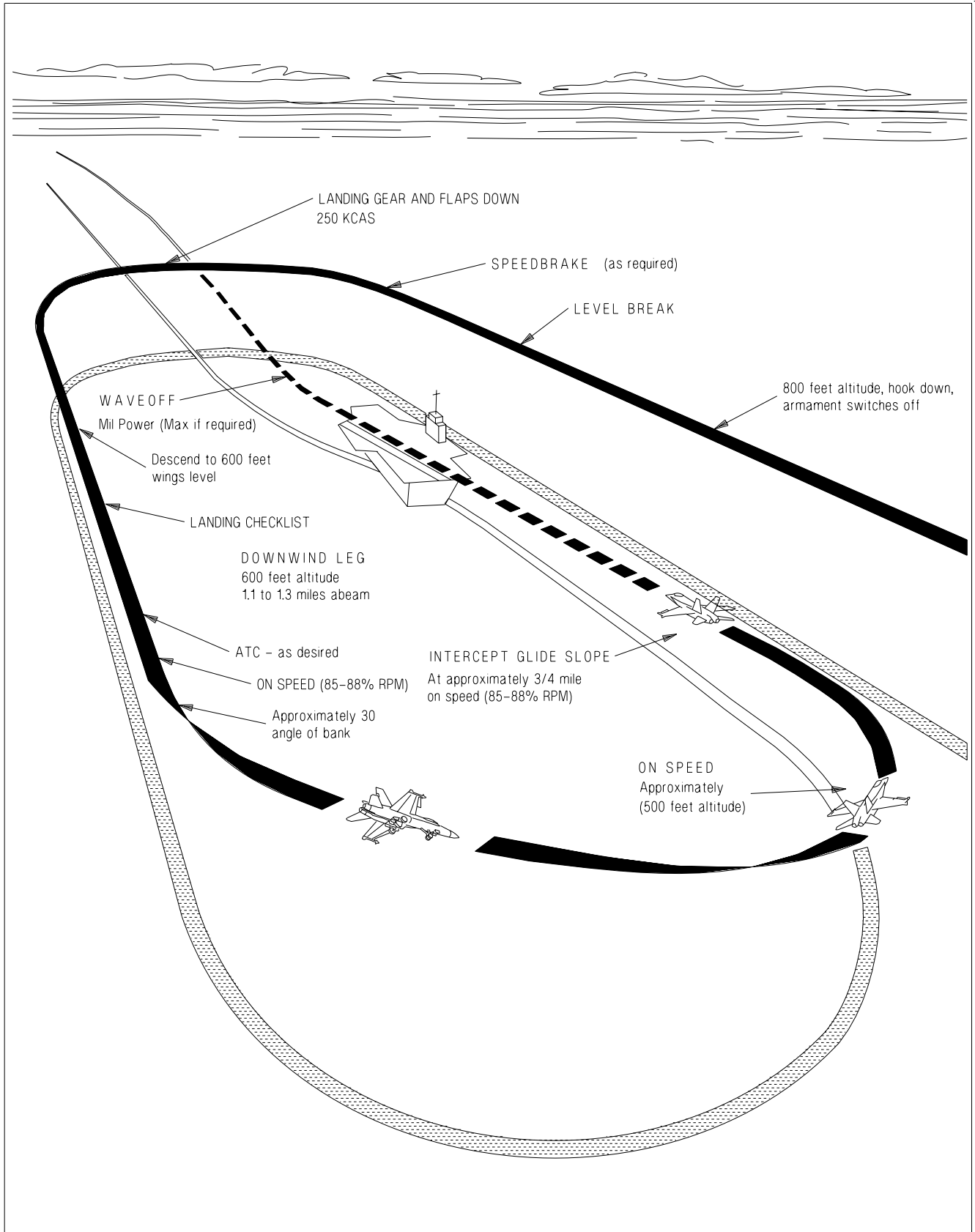

EFN520-137-1-004

Figure 8-2. Carrier Landing Pattern

downwind and prior to the 180° position. Complete the landing checklist and crosscheck AOA and airspeed (136 KCAS at 44,000 lb GW minus 1.5 KCAS for each 1,000 lb decrease in GW).

NOTE

Flaps HALF or FULL may be used for landing provided the minimum wind-over-deck (WOD) requirements of the Aircraft Recovery Bulletin (ARB) are met. As WOD increases above 30 kt, handling qualities in flaps HALF are slightly improved over flaps FULL and are recommended to avoid "settle at the ramp" situations.

To assist in achieving the desired abeam distance of 1.1 to 1.3 nm: select the 10 nm scale on the HSI display, select ship's TCN, and adjust the course line to the BRC. On downwind fly to place the wingtip of the HSI airplane symbol on the course line. Ensure the ground track pointer is on the exact reciprocal of the BRC. Select ILS if desired and available.

With 25-30 kt winds over deck begin the 180° turn to the final approach when approximately abeam the LSO platform or when the "white" of the round down becomes visible. Use an instrument scan from the 180 to the 90. Fly the pattern as described in the VFR Pattern and Approach section of Chapter 7. Adjust the 90 altitude up slightly to account for the height of the ship's deck, usually 500 feet AGL versus 450 feet AGL. Target 360 feet crossing the wake. The rate of descent required to maintain glideslope may be slightly less than on FCLP approaches due to wind over deck. Expect slightly higher throttle settings. When the meatball is acquired, transmit "SIDE NUMBER, RHINO, BALL, (fuel state in thousands of pounds to the nearest 100 pound), AUTO" (if using ATC for approach) e.g. "206, RHINO, BALL, 7.5, Auto". If unable to see any or all of the following: the meatball, datums, or centerline, transmit (SIDE NUMBER, CLARA/CLARA datums/CLARA lineup." (e.g. "206, CLARA"). See figure 8-3 for a typical Carrier Controlled Approach.

8.2.8.1 ATC Approach Mode Technique. Refer to the ATC Approaches section of Chapter 7 for basics on ATC operations. ATC stick-to-throttle gains are designed to allow correction of settles or updrafts with small, rapid stick movements. Close-in corrections are very critical. If a large attitude correction for a high-in-close situation develops, the recommended procedure is to stop ball motion, making no attempt to recenter the ball. A low-in-close condition is difficult to correct with ATC and may result in an over-the-top bolter. It may be necessary to downgrade from ATC and fly manually to safely recover from a low-in-close condition. The force required to manually disengage ATC is significant and may prevent salvaging the pass. Large deviations from glideslope may be difficult to correct with ATC. Typically, ATC should be disengaged if more than one ball from center (or upon LSO direction) and the approach continued manually.

8.2.8.2 Glideslope. The technique for maintaining glideslope is basically the same as FCLP except that more power may be required. Maintaining centerline will most likely require more line-up corrections due to the angled deck. With rough seas and a pitching deck, some erratic ball movement may be encountered. If this is the case, listen to LSO calls and attempt to average out ball movement to maintain a safe, controlled approach.

8.2.8.3 Waveoff. When the waveoff signal is received, select MIL (MAX if required) and maintain on-speed AOA with the E-bracket until rate of descent is arrested and 10° pitch attitude is captured for climb to pattern altitude. Best rate of climb occurs at on-speed AOA regardless of loading or configuration. This requires slight back stick pressure as the aircraft accelerates. If ATC is engaged,

immediately disengage ATC or apply enough force to override ATC while advancing the throttles to MIL or MAX. Do not over-rotate.



An in-close or late waveoff, coupled with an over-rotation can lead to an in-flight engagement, which can severely damage the aircraft and/or arresting gear.

8.3 ACL MODE 1 AND 1A APPROACHES

A typical Mode 1 and 1A approach is shown in figure 8-4. The Mode 1/1A approach does not require ATC, but ATC should normally be used. The following procedure is typical for a Mode 1 (1A) approach from marshal to touchdown (or 0.5 mile).

1. Request a Mode 1 or Mode 1A approach from Marshal.
2. HSI format - SELECT (box) ACL

When the ACL option is boxed, the LINK 4 format automatically appears on the LDDI, and the ACL mode automatically starts its self test. At this time, the ILS, data link, and radar beacon are automatically turned on (if not previously on), and IBIT is run on the data link and radar beacon systems. Also, the uplinked universal test message is monitored for valid receipt.

3. Onboard ACL Capability - CHECK
 - a. LINK 4 format - CHECK FOR ACL 1
Mode 1/1A capability is not available if ACL 1 is not displayed.
 - b. BIT page, NAV Sublevel - Verify AUG GO/PBIT GO



An augmentor degrade does not inhibit ACL coupling. A degraded augmentor may lead to a significant lineup error, most often tending right-of-centerline.

4. Report departing marshal - "SIDE NUMBER, COMMENCING"
5. Normal CCA - PERFORM

Descend at 250 KCAS and 4,000 fpm to 5,000 feet, (platform) then reduce rate of descent to 2,000 fpm. When selected, ILS steering is automatically displayed on the HUD once valid signals are received and must be manually deselected, if the symbology is not desired.

- a. At 5,000 ft MSL, report - "SIDE NUMBER, PLATFORM"
- b. Continue descent to 1,200 ft MSL.
- c. At 10 nm, report - "SIDE NUMBER, 10 MILES"

6. LDG GEAR handle - DN (at 10 nm but NLT 8 nm)
7. FLAP switch - FULL or HALF

NOTE

- Flaps may be switched between FULL and HALF while remaining coupled outside of one nautical mile from touchdown.
- When coupled, changing flap position inside one nautical mile from touchdown is prohibited.

8. Landing checklist - COMPLETE
 - a. Check the LDDI for ID LT indication.
9. Slow to approach speed at 6 nm.
10. ATC - ENGAGE
11. RALT hold mode - ENGAGE (if desired)

ACL acquisition occurs at approximately 3.5 to 8 nm and is indicated by ACL RDY on the LINK 4 format and the data link steering (TADPOLE) on the HUD. It is desired but not required, to have ACL coupled at least 30 seconds before tipover. T/C is replaced by MODE 1 on the LINK 4 format.

After ACL Acquisition -

12. Report needle position - e.g., "UP AND ON" or "UP AND RIGHT".

For Mode 1, when directed -

13. CPL option - SELECT on UFCD

If T/C is engaged, press CPL once to uncouple T/C then press CPL again to couple ACL. When the aircraft is not coupled, ACL RDY is displayed on the HUD. ACL couple is indicated by CMD CNT and MODE 1 on the LINK 4 format and CPLD P/R on the UFCD and HUD. At this time, the uplinked command displays of heading, airspeed, altitude, and rate of descent are removed from the LINK 4 format and the HUD.

14. When coupled, report - "COUPLED"
15. When aircraft responds to automatic commands, report - "COMMAND CONTROL"

For Mode 1A Approach -

16. Downgrade to Mode 2 at 0.5 mile by
 - a. Paddle switch - PRESS
 - b. ATC button - DISENGAGE (if desired)

VOICE REPORTS

- Entering holding
 - Departing marshal
 - 5,000 feet – SIDE NUMBER, PLATFORM
 - 10 miles – SIDE NUMBER, 10 MILES
 - Acquisition – SIDE NUMBER, RHINO, BALL OR CLARA
FUEL STATE, AUTO (only if ATC)
- * Non-precision (ASR) approach only. For precision (PAR) approach, maintain 1200 feet until directed to commence descent.

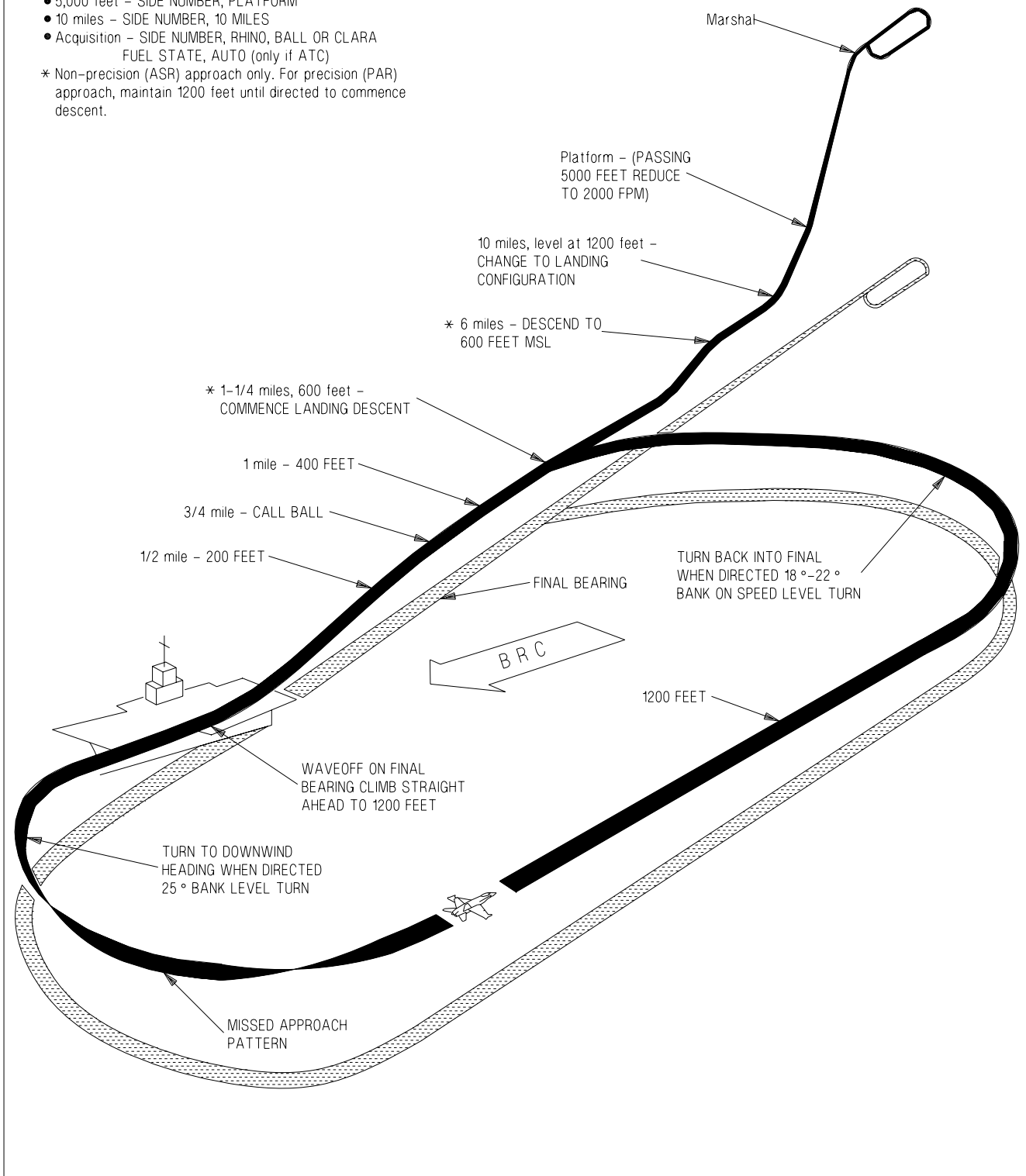

EFN520-138-1-010

Figure 8-3. Carrier Controlled Approach

17. Report - "SIDE NUMBER, RHINO, BALL or CLARA, FUEL STATE, AUTO" (if ATC engaged).

For Mode 1 Approach -

11. Report - "SIDE NUMBER, RHINO, BALL or CLARA, FUEL STATE, COUPLED".
12. At approximately 12.5 seconds before touchdown, the uplinked 10 SEC cue is displayed on the LINK 4 format and the HUD.
13. After touchdown, ACL and ATC should be automatically disengaged.

NOTE

After Mode 1 or 1A downgrade or touch-and-go, actuate the paddle switch to ensure complete autopilot disengagement.

8.4 ACL MODE 2 APPROACH

A typical ACL Mode 2 approach is shown in figure 8-5. For a Mode 2 approach, the HUD data link steering is used to fly a manual approach.

1. HSI format - SELECT (box) ACL

When the ACL option is boxed, the LINK 4 format automatically appears on the LDDI, and the ACL mode automatically starts its self test. At this time, the ILS, data link, and radar beacon are automatically turned on (if not previously on), and IBIT is run on the data link and radar beacon systems. Also, the uplinked universal test message is monitored for valid receipt.

2. LINK 4 format - CHECK FOR ACL 1 or ACL 2
Mode 2 capability is not available if ACL 1 or ACL 2 is not displayed.
3. Report departing marshal - "SIDE NUMBER, COMMENCING"
4. Normal CCA - PERFORM

Descend at 250 KCAS and 4,000 fpm to 5,000 feet, (platform) then reduce rate of descent to 2,000 fpm. When selected, ILS steering is automatically displayed on the HUD once valid signals are received and must be manually deselected, if the symbology is not desired.

- a. At 5,000 ft MSL, report - "SIDE NUMBER, PLATFORM"
- b. Continue descent to 1,200 ft MSL.
- c. At 10 nm, report - "SIDE NUMBER, 10 MILES"
5. LDG GEAR handle - DN (at 10 nm but NLT 8 nm)
6. FLAP switch - FULL (HALF if required)
7. Landing checklist - COMPLETE

VOICE REPORTS

- Entering holding
- Departing marshal - SIDE NUMBER, COMMENCING
- 5,000 feet - SIDE NUMBER, PLATFORM
- 10 miles - SIDE NUMBER, 10 MILES
- Data link steering - NEEDLES
- With CMD CNT - SIDE NUMBER, COUPLED
- Aircraft responding - SIDE NUMBER, COMMAND CONTROL
- 200 feet, 1/2 mile - UNCOUPLE (Mode 1A) SIDE NUMBER, RHINO, BALL OR CLARA, FUEL STATE, COUPLED (Mode 1) or AUTO (Mode 1A, only if ATC)

Marshal - CHECK LINK ACL 1, T/C; HUD CPLD HDG (if desired) IDENT switch to NORM

Platform - ILS STEERING DISPLAYED

10 miles, level at 1200 feet - LANDING CONFIGURATION, AUTOMATIC THROTTLES ENGAGED, FPAH/ROLL or RADAR ALTITUDE HOLD (IF DESIRED)

6 miles - LND CHK

1200 FEET

Acquisition (3.5 to 5 miles) - ACL RDY, D/L STEERING REPORT NEEDLES

Traffic control - UNCOUPLE (if engaged); ACL - COUPLE, REPORT COUPLED

Aircraft responds to automatic commands - REPORT COMMAND CONTROL

10 SEC

TIPOVER (APPROXIMATELY 3 MILES)

LND CHK

1200 FEET

200 feet, 1/2 mile - UNCOUPLE (MODE 1A), CALL BALL

BOLTER/WAVEOFF CONTROL

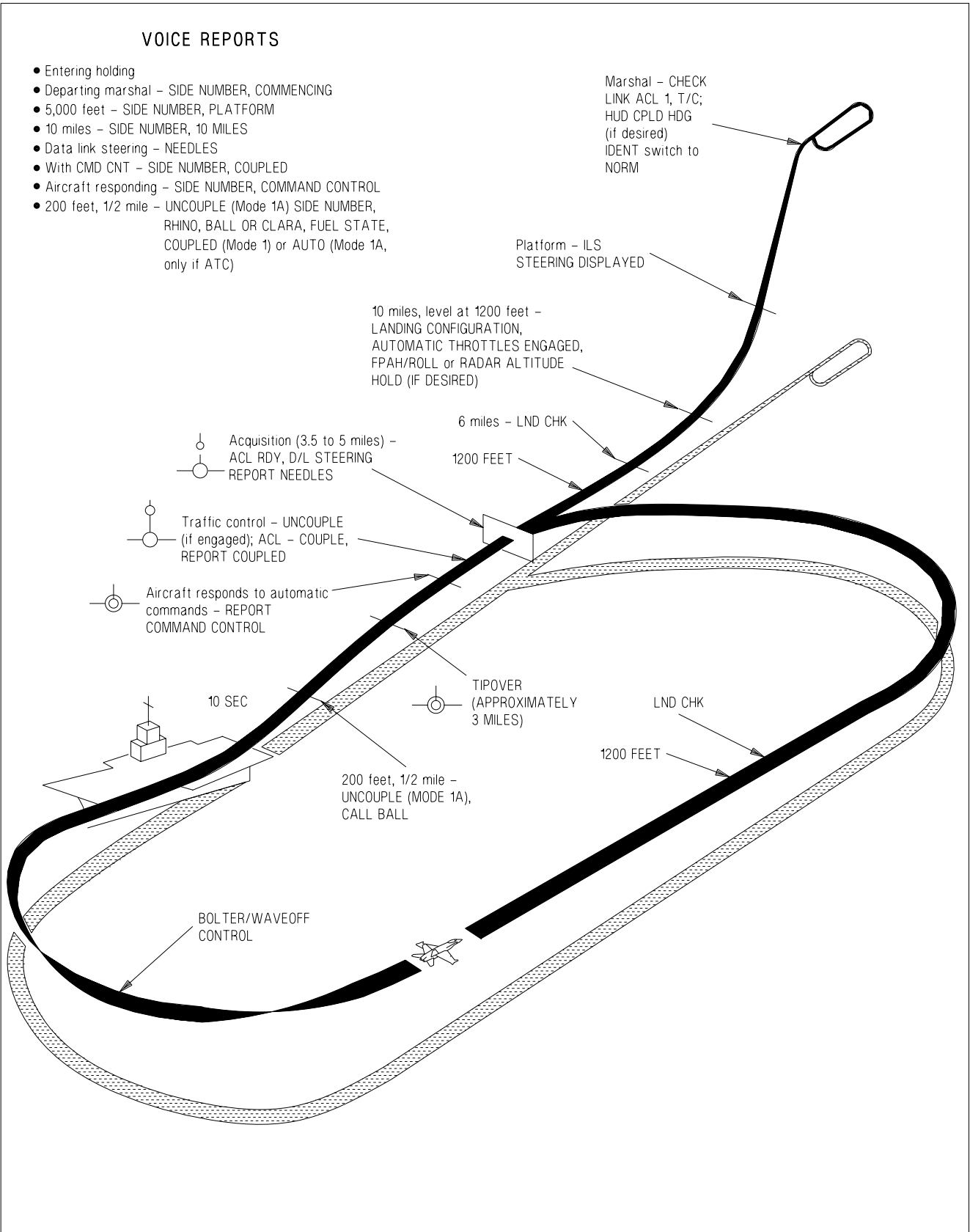

EFN520-139-1-010

Figure 8-4. ACL Mode 1 and 1A Approaches

- a. Check the LDDI for ID LT indication.
- 8. Slow to approach speed at 6 nm.
- 9. ATC - ENGAGE (if desired)
- 10. RALT hold mode - ENGAGE (if desired)

ACL acquisition occurs at approximately 3.5 to 8 nm and is indicated by ACL RDY on the LINK 4 format and the data link steering (TADPOLE) on the HUD.

After ACL Acquisition -

- 11. Report needle position - e.g., "UP AND ON" or "UP AND RIGHT".
- 12. Report - "SIDE NUMBER, RHINO, BALL or CLARA, FUEL STATE, AUTO" (if ATC engaged).

8.5 ARRESTED LANDING AND EXIT FROM THE LANDING AREA

- 1. Fly an on-speed, on centerline, centered-ball approach all the way to touchdown.

At touchdown -

- 2. Throttles - MIL

WARNING

To reduce aircraft and arresting gear loads and required recovery wind-over-deck, selection of MAX power at touchdown shall not be performed except in an emergency.

When forward motion ceases -

- 3. Throttles - IDLE and allow the aircraft to roll aft.

When directed -

- 4. Brakes - APPLY
- 5. HOOK handle - UP
If the wire does not clear the hook, the taxi director will signal to lower the hook for aircraft pullback.
- 6. FLAP switch - AUTO
- 7. WINGFOLD switch - HOLD or FOLD (HOLD if wingtip missile dearming required)
- 8. NWS button - ENGAGE NWS HI

When the come ahead signal is received, add power, release brakes, and exit the landing area cautiously and expeditiously. Taxi the aircraft as directed. Do not use excessive power. If one or both brakes fail, utilize the emergency brakes; advise the tower; and drop the arresting hook.

Once spotted, keep the engines running until the taxi director signals engine shutdown and the aircraft is properly chocked and chained.

8.6 SECTION CCA

A section CCA may be necessary when a failure occurs which affects navigation aids, communications equipment, or other aircraft systems. Normally, the aircraft experiencing the difficulty flies the parade position on the starboard side during the approach. When the meatball is sighted, but no lower than 300 feet AGL, the section leader breaks away from the wingman in a climbing left turn. The section leader should climb to 1,200 feet AGL, or below an overcast, in the bolter configuration, and position himself at the wingman's 11:00 o'clock position. If the wingman bolters or waves-off, he should rendezvous in the bolter configuration on the section leader. If a wave-off is required prior to flight break-up, the flight leader executes a climbing right turn to 1,200 feet AGL and follows the directions of CATCC. Necessary lighting signals between aircraft are contained in Chapter 26.

NOTE

A section penetration should not be made to the ship with less than non-precision minimums.

8.7 NIGHT OPERATIONS

8.7.1 General. Night carrier operations have a much slower tempo than day operations and it is the pilot's responsibility to maintain this tempo. Standard daytime hand signals from deck crew to pilot are executed with light wands. The procedures outlined here are different from, or in addition to, normal day carrier operations.

8.7.2 Preflight. Conduct the exterior preflight using a white-lensed flashlight. Ensure that the exterior lights are properly set for night launch and the external lights master switch is OFF before engine start. Ensure that instrument and console light knobs are on. This will reduce the brilliance of the warning and advisory lights when the generators come online.

8.7.3 Before Taxi. Adjust cockpit lighting as desired and perform Before Taxi Checks.

8.7.4 Taxi. Slow and careful handling by taxi directors and pilots is mandatory. If any doubt exists as to taxi director signals, stop the aircraft. At night it is very difficult to determine speed and motion over the deck, so the pilot must rely on the taxi director signals, following them closely.

8.7.5 Catapult Hook-Up. Maneuvering the aircraft for catapult hook-up at night is identical to that used in day operations; however, it is difficult to determine speed or degree of motion over the deck. If the taxi director is obscured by steam from the catapult, stop the aircraft.

8.7.6 Catapult Launch. At night, catapult procedures are the same as daytime, except signals are provided by lights instead of hand signals. The exterior lights are utilized to signal that the pilot is ready for launch. After the control wipeout, select the ADI for display on a DDI or the UFCD in case the HUD should be lost during or immediately after launch. When ready for launch, place external lights master switch to ON.

VOICE REPORTS

- Entering holding
- Departing marshal – SIDE NUMBER, COMMENCING
- 5,000 feet – SIDE NUMBER, PLATFORM
- 10 miles – SIDE NUMBER, 10 MILES
- Data link steering – SIDE NUMBER, NEEDLES
- 3/4 mile – SIDE NUMBER, RHINO, BALL OR CLARA, FUEL STATE, AUTO (only if ATC)

Marshal – CHECK
LINK ACL 1, T/C;
HUD CPLD HDG
(if desired)
IDENT switch to
NORM

Platform – ILS
STEERING DISPLAYED

10 miles, level at 1200 feet –
LANDING CONFIGURATION,
AUTOMATIC THROTTLES ENGAGED,
RADAR ALTITUDE HOLD (IF DESIRED)

6 miles – LND CHK

1200 FEET

Acquisition (3.5 to 5 miles) –
ACL RDY, D/L STEERING
REPORT NEEDLES

TIPOVER
(APPROXIMATELY
3 MILES)

3/4 mile – CALL BALL

LND CHK

1200 FEET

BOLTER/WAVEOFF
CONTROL

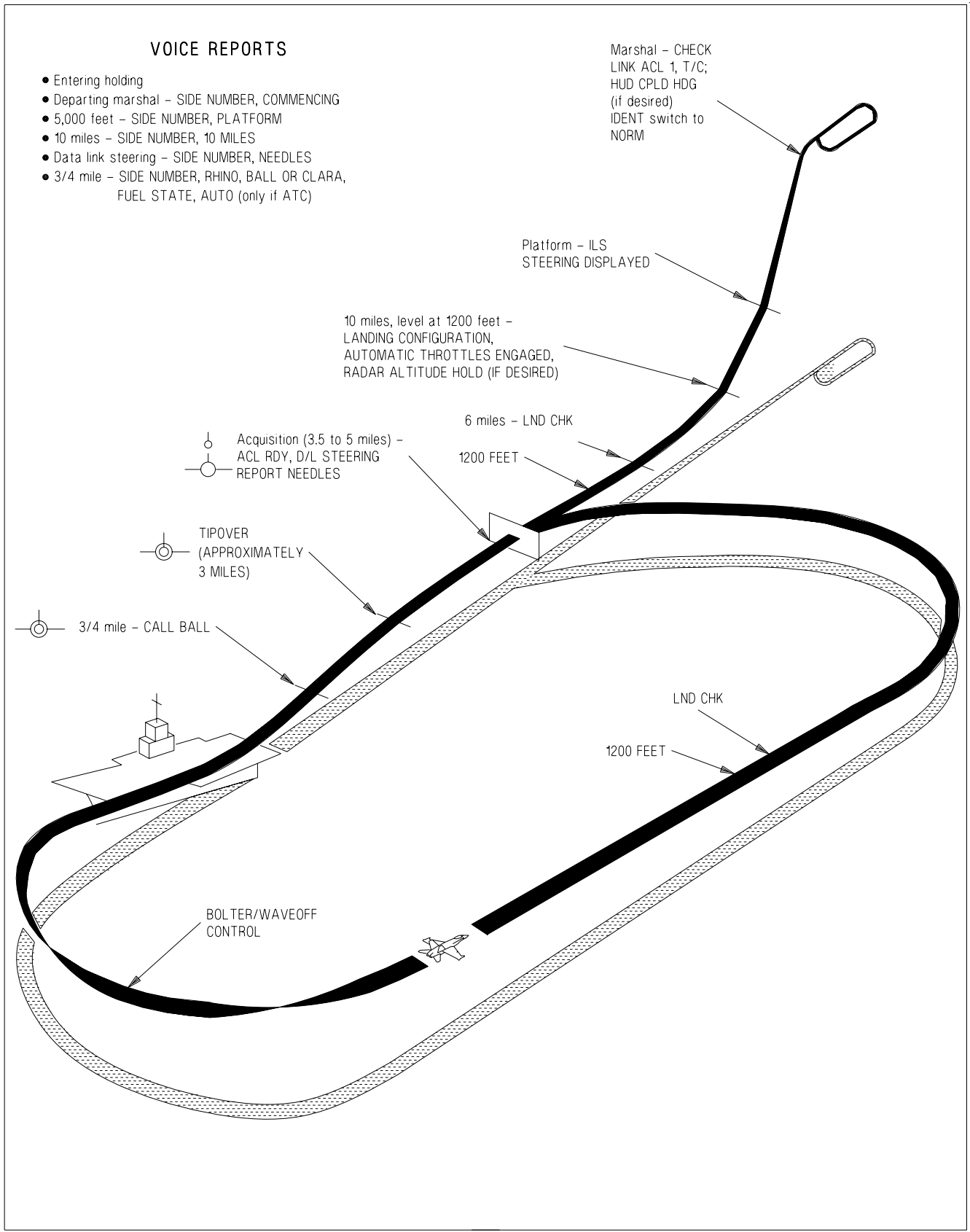

EFN520-140-1-010

Figure 8-5. ACL Mode 2 Approach

All exterior lights (position, formation, and strobes) should be on. If instrument meteorological conditions are expected shortly after launch, the strobes may be left off at the discretion of the pilot.

After launch, monitor rotation of the aircraft to 12° AOA, crosschecking all instruments to ensure a positive rate of climb. When comfortably climbing, retract the landing gear and flaps and proceed on the departure IAW CV NATOPS.

8.7.7 Catapult Suspend. To stop the launch while in tension on the catapult, do not turn on the exterior lights and transmit “SUSPEND, SUSPEND”. Maintain MIL/MAX power until the catapult officer walks in front of the wing and gives the throttle-back signal. If the external lights master switch has been placed on prior to ascertaining that the aircraft is down, transmit “SUSPEND, SUSPEND” and turn off the exterior lights and leave the throttles at MIL until signaled to reduce power.

8.7.8 Night Landings. Night and instrument recoveries will normally be made using case III procedures IAW CV NATOPS. Prior to departing marshal, change the IDENT switch on the exterior lights panel to the NORM position. Make sure the strobe lights are flashing a 3 flash, pause, repeat pattern.

8.7.9 AN/APG-79 AESA Considerations. Aircrew operating AN/APG-79 AESA equipped aircraft shall be aware that directing AN/APG-79 AESA transmissions toward the ship while on approach may cause strong electromagnetic interference (EMI) affecting the safety of aircraft on approach. Unless specifically authorized for operational necessity or required for safety of flight, aircrew shall cease AN/APG-79 AESA radar transmissions whenever operating within 10 nm of the ship while on approach during IMC/Case III conditions. Reference Chapter 4.4 for AN/APG-79 AESA radar limitations.

8.7.10 Arrestment and Exit From the Landing Area. During the approach, all exterior lights should be on with the exception of the landing/taxi light. Following arrestment, immediately turn the external lights master switch off. Taxi clear of the landing area following taxi director signals. If brakes are lost, signal by lowering the hook, turning on exterior lights, and transmitting on land/launch frequency.

CHAPTER 9

Special Procedures

9.1 FORMATION FLIGHT

9.1.1 Formation Taxi/Takeoff. During section taxi, ensure adequate clearance between flight lead's stabilator and wingman's wing/missile rail is maintained. The leader will take position on the downwind side of the runway with other aircraft in tactical order, maintaining normal parade bearing. See figure 9-1. For three aircraft formations, line up with the lead on the downwind side, number 2 on the centerline, and number 3 on the upwind side. Wingtip/launch rail overlap should not be required but is permitted if necessary. For four plane formations, line up with the lead's section on the downwind half of the runway and other section on the upwind half. When Before Takeoff checks are completed and the flight is in position, each pilot looks over the next aircraft to ensure the speed brake is retracted (spoilers down), the flaps are set for takeoff, all panels are closed, no fluids are leaking, safety pins are removed, rudders are toed-in, nosewheel is straight, and the launch bar is up. Beginning with the last aircraft in the flight, a "thumb up" is passed toward the lead to indicate "ready for takeoff".

9.1.1.1 Section Takeoff. For section takeoff, all aspects of the takeoff must be prebriefed by the flight leader, to include flap settings; use of nosewheel steering; power changes; power settings; and signals for actuation of landing gear, flaps, and afterburner. Engines are run up to approximately 80%, instruments checked, and nosewheel steering low gain ensured. On signal from the leader, brakes are released and throttles are advanced to military power minus 2% rpm. If afterburner is desired, the leader may go into mid range burner immediately without stopping at military power. Normal takeoff techniques should be used by the leader, with the wingman striving to match the lead aircraft attitude as well as maintain a position in parade bearing with wingtip separation. The gear and flaps are retracted on signal. Turns into the wingman shall not be made at altitudes less than 500 feet above ground level.

9.1.2 Aborted Takeoff. In the event of an aborted takeoff, the aircraft aborting must immediately notify the other aircraft. The aircraft not aborting should add max power and accelerate ahead and out of the way of the aborting aircraft. This allows the aborting aircraft to steer to the center of the runway and engage the arresting gear, if required.

9.1.3 Parade. The parade position is established by superimposing the front of the wingtip missile rail over the pilot's headbox. Superimposing the two establishes a bearing line and step down. Proper wingtip clearance is set by reference to the exhaust nozzles. When the left and right nozzles are aligned so that there is no detectable curve to the nozzles, the reference line is correct. The intersection of the reference line with the bearing line is the proper parade position. See figure 9-2.

Parade turns are either standard (VFR) or instrument turns. During day VFR conditions, turns away from the wingman are standard turns. To execute, when lead turns away, the wingmen roll the aircraft about its own axis and increase power slightly to maintain rate of turn with the leader. Lateral separation is maintained by increasing g. Proper step down is maintained by keeping the lead's fuselage on the horizon.

Turns into the wingmen and all IFR or night turns in a parade formation are instrument turns. During instrument turns maintain a parade position relative to the lead throughout the turn.

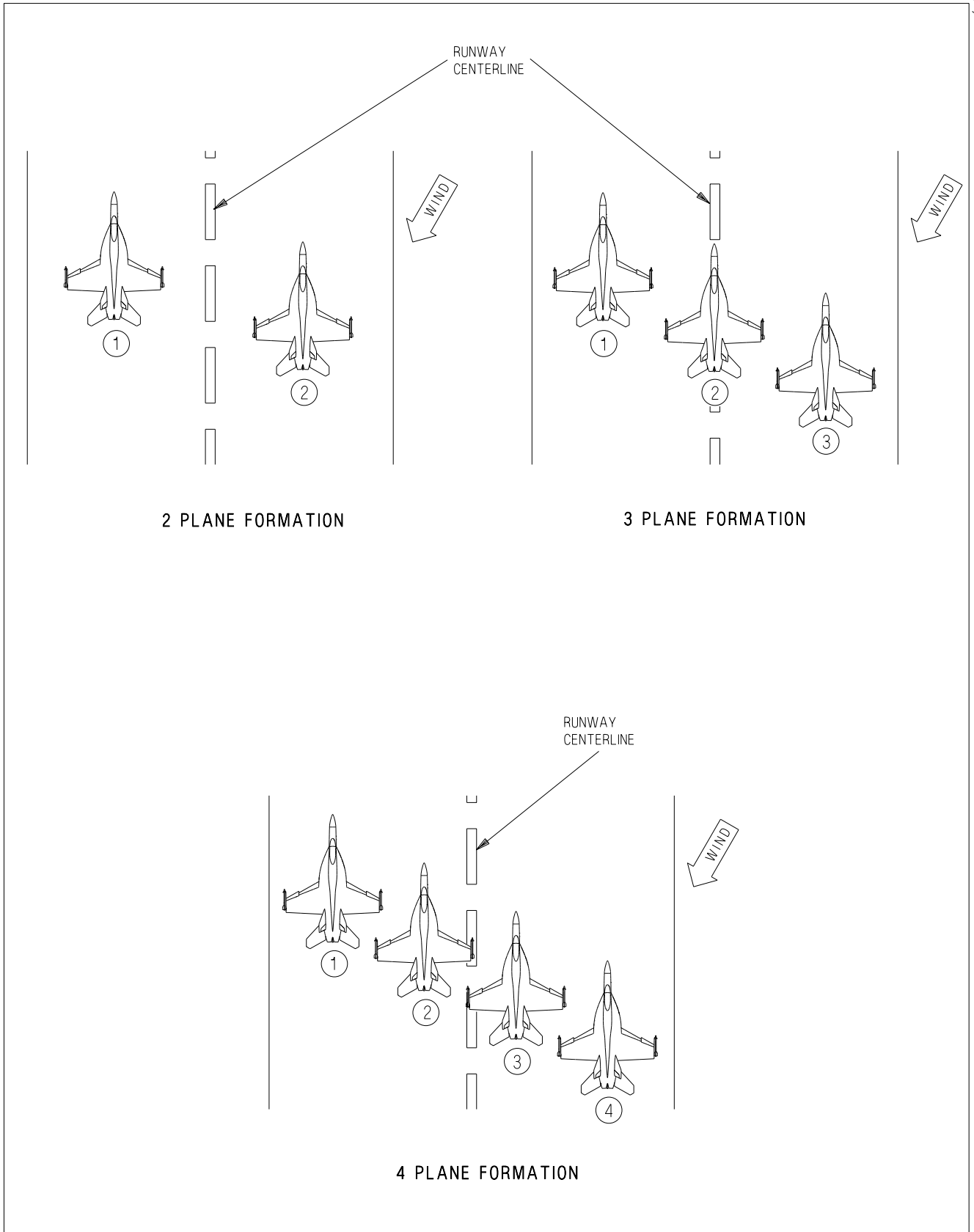

EFN520-301-1-001

Figure 9-1. Formation Takeoff Runway Alignments

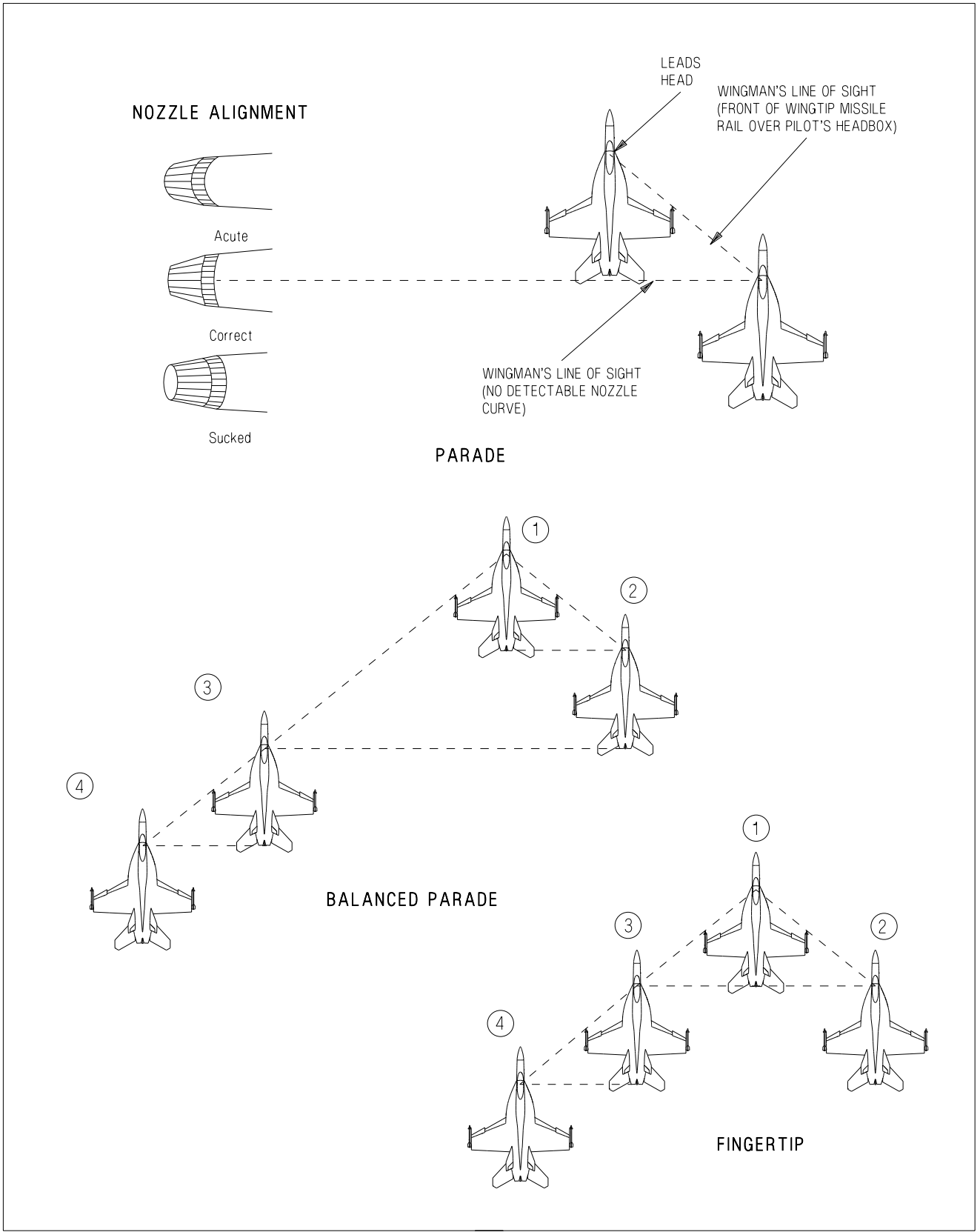

EFN520-302-1-004

Figure 9-2. Formations (Sheet 1 of 2)

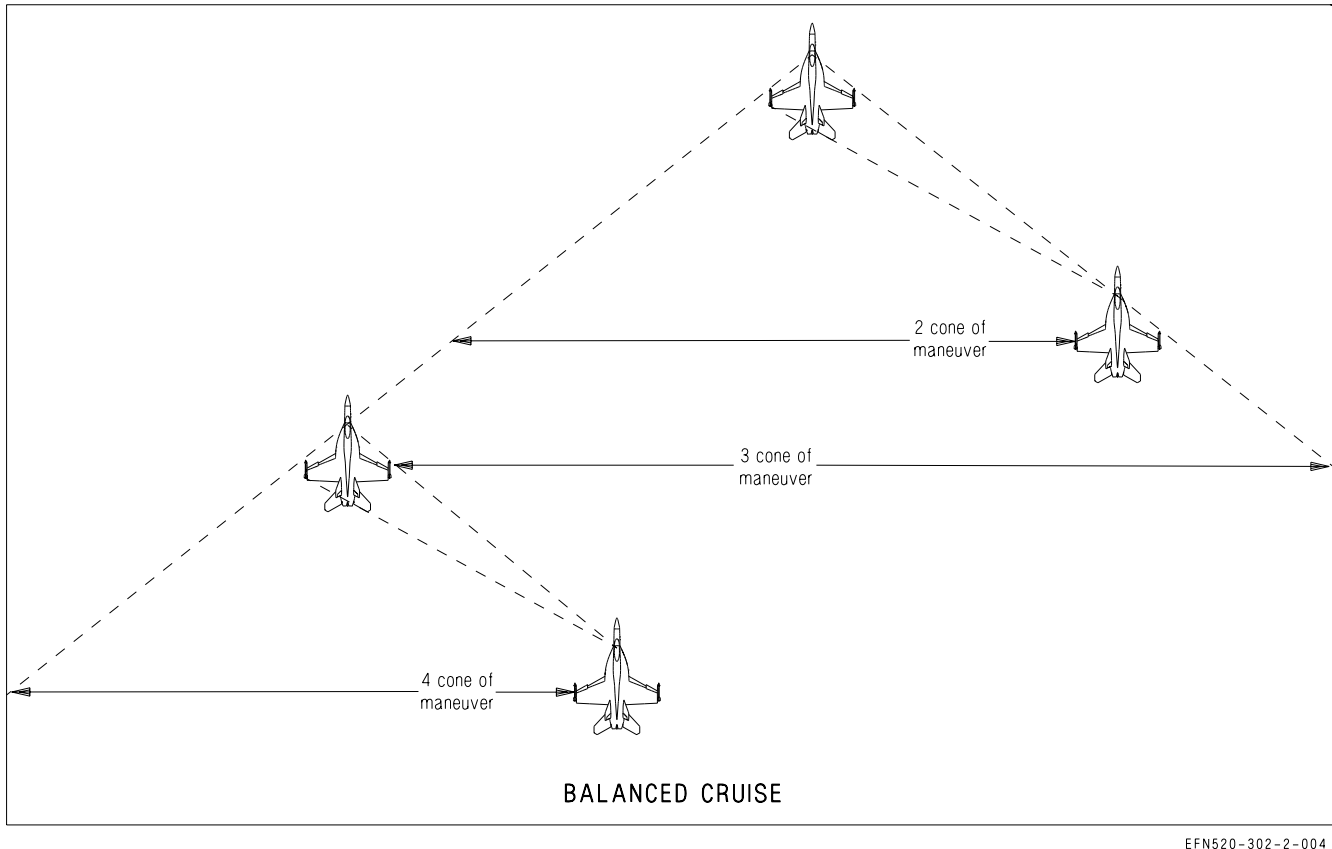

Figure 9-2. Formations (Sheet 2 of 2)

After initially joining up in echelon, three and four plane formations normally use balanced parade formation. In balanced parade number 3 steps out until the exhaust nozzles on number 2 are flush. This leaves enough space between number 3 and lead for number 2 to cross under into echelon.

When it is necessary to enter IFR conditions with a three or four plane formation, the lead directs the flight to assume fingertip formation. In this formation number 3 moves up into close parade on the lead. All turns are instrument turns.

9.1.4 Balanced Cruise Formation. The balanced cruise position is a looser formation which allows the wingmen more time for visual lookout. Balanced cruise provides the wingmen with a cone of maneuver behind the leader which allows the wingman to make turns by pulling inside the leader, and requires little throttle change.

The balanced cruise position is defined by the wingman aligning his headbox with the front of lead's wingtip missile rail and headbox, and lead's arresting hook fairing with the opposite wing formation light. The wingmen are free to maneuver within the cone established by that bearing line on either wing. In a division formation, number 3 should fly the bearing line but always leave adequate room for number 2 and lead. Number 4 flies balanced cruise about number 3.

9.1.5 Section Approaches/Landing. The aircraft is comfortable to fly in formation, even at the low airspeeds associated with an approach and landing. The rapid power response enhances position keeping ability. The formation strip lighting provides a ready visual reference at night and the dual radios generally ensure that intra-flight comm is available.

During section approaches all turns are “instrument” turns about the leader. When a penetration is commenced the leader retards power to 75 % rpm and descends at 250 KIAS. If a greater descent rate is required the speed brake may be used. Approximately 5 miles from the final approach fix or GCA pickup the lead gives the signal for landing gear.

9.1.5.1 Section Landing. If a section landing is to be made, lead continues to maintain ON-SPEED for the heaviest aircraft and flies a centered ball pass to touchdown on the center of one side of the runway. Wingman flies the normal parade position, taking care not to be stepped up.

When “in-close”, wingman adds the runway to his scan and takes a small cut away from the lead to land on the center of the opposite side of the runway while maintaining parade bearing. Use care to ensure that drift away from the lead does not become excessive for the runway width. Remember, flying a pure parade position allows 4 feet of wingtip clearance.

The wingman touches down first and decelerates on that half of the runway as an individual. Do not attempt to brake in section. If lead must cross the wingman’s nose to clear the duty, the wingman calls “clear” on comm 2 when at taxi speed and with at least 800 feet between aircraft. The lead stops after clearing the runway and waits for the wingman to join for section taxi.

9.2 AIR REFUELING (RECEIVER)

Air refueling shall be conducted in accordance with NATO publication ATP-56, Air-to-Air Refueling Procedures.

NOTE

The KC-10, KC-130, KC-135 tankers, F/A-18E/F and S-3 aircraft with a 31-301 (A/A42R-1) buddy store are authorized tankers for air refueling. Maximum refueling pressure is 55 psi.

9.2.1 Air Refueling Checklist. The air refueling checklist should be complete prior to plug-in.

1. RADAR - STBY/SILENT/EMCOM (“nose cold”)
2. MASTER ARM switch - SAFE (“switches safe”)
3. ALE-50 transmit power - OFF (if decoy deployed)
4. INTR WING switch - NORM (or as required)
5. EXT TANK switch(es) - AS DESIRED
If feed tank fuel level is critical, selecting STOP ensures the fastest transfer of fuel to the feed tanks.

NOTE

For ARS configured aircraft: If fueling of the ARS is not desired during aerial refueling, as the receiver, CTR ORIDE must be selected since CTR STOP will not prevent fuel from entering the ARS. Selecting CTR ORIDE will pressurize all external fuel tanks and significantly reduce refueling rate.

6. PROBE switch - EXTEND
7. Visor - DOWN (recommended)

For night air refueling -

8. Exterior lights - SET FOR REFUELING
9. Tanker lights - REQUEST AS DESIRED

9.2.2 Refueling Technique. The following procedures, as applied to tanker operations, refer to single drogue refueling from the F/A-18E/F and the aerial refueling store. All other tanking evolutions are dependent on the type of tanker being utilized. Refer to Chapter 26, Visual Communications, for proper hand signals during air refueling operations.

A sharp lookout doctrine must be maintained due to the precise flying imposed on both the tanker and receiver pilots. Other aircraft in the formation may assist the tanker in maintaining a sharp lookout. Refueling altitudes and airspeeds are dictated by receiver and/or tanker characteristics balanced with operational needs. This typically covers a practical envelope from the surface to 40,000 feet and 180 to 300 KCAS (while engaged), depending on the buddy store part number. (See figure 4-13).

9.2.2.1 Approach. When cleared to commence an approach and the refueling checklist is complete, assume a ready position 10 to 15 feet in trail of the drogue with the refueling probe in line both horizontally and vertically. Once in a stabilized position, trim the aircraft and make sure the tanker ready light (amber) is on. Referencing the probe and drogue for alignment, increase power to establish a 3 to 5 knot closure rate.



- If the tanker ready light is not on, do not engage drogue until signaled by tanker aircraft as hose-reel response may be inoperative, causing damage to tanker and receiver aircraft.
- Avoid damage to the right AOA probe by contact with the basket as a 4 channel AOA failure may result.
- An excessive closure rate may cause a violent hose whip following contact and/or increase the danger of structural damage to the aircraft in the event of misalignment.

NOTE

An insufficient closure rate results in the pilot fencing with the drogue as it oscillates in close proximity to the aircraft nose.

Make small corrections during the approach phase using the rudder pedals for lateral misalignment and longitudinal stick for vertical misalignment. Avoid lateral stick inputs as they cause both vertical and lateral probe displacement. During the final phase of the approach, the drogue has a tendency to move up and to the right as it passes the nose of the receiver aircraft due to the aircraft-to-drogue air stream interaction.

9.2.2.2 Missed Approach. A missed approach is executed by reducing power and backing to the rear with a 3 to 5 knot opening rate. Execute a missed approach if:

1. The receiver probe and the drogue basket cannot be properly aligned during the final phase of the approach.
2. The receiver probe passes forward of the drogue basket.
3. The receiver probe impinges on the rim of the drogue basket.
4. Any unsafe condition develops.

Analyze alignment problems prior to commencing another approach.

9.2.2.3 Contact. When the receiver probe engages the basket, it seats itself into the reception coupling and a slight ripple is evident in the refueling hose. The drogue and hose must be pushed forward 5 feet by the receiver aircraft before fuel transfer can be started. This position is evident by the tanker ready light (amber) going out and the (green) fuel transfer light (green) coming on. During refueling, maintain a position directly behind and slightly below tanker aircraft.

NOTE

If streaming fuel is observed around the refueling probe, the probe is not properly seated in the drogue. Disengage, stabilize in the ready position, and then reengage the drogue.

9.2.2.4 Disengagement. The receiver aircraft disengages by reducing power in order to open from the tanker at 3 to 5 knots. Back straight away and down, following the flight path of the tanker. The receiver probe separates from the reception coupling when the hose reaches full extension. When clear of the drogue, place the PROBE switch in the RETRACT position. Make sure that the PROBE UNLK caution display is out before resuming normal flight operations.



- Disengagement must be made straight back, parallel to the tanker flight path, and descending along the natural trail angle of the hose to prevent damage to the tanker and/or refueling aircraft.
- When installed on the F/A-18 E/F tanker, the ARS hose/drogue/coupling exhibits a strong tendency to re-center in its natural trail position. Off-center disconnects may result in drogue contact and damage to the aircraft. Avoid off-center disconnects and maintain a constant separation rate until clear.

9.2.2.5 KC-10 Refueling Operations. The KC-10 tanker is equipped with a centerline hose reel system and/or two Wing Aerial Refueling Pods (WARP). Maximum in-flight refueling airspeed and altitude for the F/A-18E/F when refueling from the KC-10 is 275 KCAS and 25,000 feet with an optimum airspeed of 220 KCAS. At airspeeds above 250 KCAS, tanker induced light turbulence causes

random drogue movement of 2 to 3 feet while 1 foot of movement will be encountered at airspeeds less than 250 KCAS. The recommended closure rate is 2 to 3 knots.

WARNING

When joining a flight of receiver aircraft, do not close astern of the KC-10 within 1 to 3 miles from co-altitude to 500 feet below. Loss of aircraft control can occur if wake turbulence is encountered.

CAUTION

Excessive closure rates may exceed the capabilities of the take-up reel. If this should happen, a sine wave develops in the hose. Immediate disengagement is required to prevent damage to the aircraft.

9.2.2.6 KC-135 Refueling Operations. The KC-135 may be configured with a Multi-Point Refueling System (MPRS) and/or a Boom to Drogue Adapter (BDA) kit.

9.2.2.6.1 KC-135 BDA Refueling. The KC-135 hose has a fixed length of 9 feet attached by a swiveling coupling to the end of a telescoping boom. The hose terminates in a hard, non-collapsible drogue and has no reel retraction capability. The following refueling parameters are recommended:

- Airspeed of 200 to 275 KCAS or Mach 0.8 (whichever is less).
- Closure rate of 2 knots or less.

Aerial refueling from the KC-135 is fundamentally different from the standard Navy hose-drogue systems. After assuming a standard ready position, add power to create a closure rate of 2 knots or less. Due to the short length of hose and the weight of the drogue, the aircraft-to-drogue air stream interaction is minimized.

CAUTION

Excessive closure rates (greater than 2 knots) may result in damage to the aircraft or the refueling drogue.

Once contact has been made, the drogue must be pushed in approximately 4 feet and held in that position within ± 2 feet fore and aft for fuel to flow (the hose forms a U-shape when in the correct position). If the F/A-18E/F is positioned too far aft with the hose near the trail position, slight aft or radial movement results in disconnect. The potentially more hazardous situation occurs when the drogue is pushed too far forward, such that the hose could be looped around the drogue on the probe.

When disengaging, align the drogue with the boom and back straight away with reference to the boom.

WARNING

Off-center disconnects can result in damage to the refueling probe or nozzle because of the excessive sideloads generated by the KC-135 boom-drogue adapter.

9.2.2.6.2 KC-135 MPRS Refueling. The KC-135 MPRS incorporates the use of wing tip mounted aerial refueling pods to support receivers designed for hose/drogue refueling operations. The refueling hose is slightly shorter than the KC-130 and located near the wing tips. The extreme outboard wing location subjects the hose and drogue to wing tip flowfield disturbances at higher refueling speeds.

- Maximum recommended refueling speed 285 KCAS (up to 300 KCAS/0.86 IMN allowed)
- Optimum refueling airspeeds 260 - 285 KCAS.

While flying at the approach position (20 ft aft of the drogue), small lateral trim inputs may be required to counter a tendency to roll toward the tanker. Deviations inboard and outboard may require additional lateral stick inputs. Deviations of more than 10 feet high can result in a strong sideslip (on right tanker wing, full left ball). Light buffet is a good indication to reposition down with respect to the tanker.

Maintaining a slow controlled constant closure rate (less than 5 knots) will result in the best engagement results. Tanking at 300 knots is demanding due to increased bow wave effects and high drogue position.

9.3 AIR REFUELING (TANKER)

Air refueling shall be conducted in accordance with NATO publication ATP-56, Air-To-Air Refueling Procedures.

9.3.1 Air Refueling Store (ARS). The ARS is a missionized component for in-flight refueling. The ARS control panel (figure 9-3) provides power, fuel transfer operation, fuel status indicators, BIT status, and normal hose extension/retraction, and hose jettison capability.

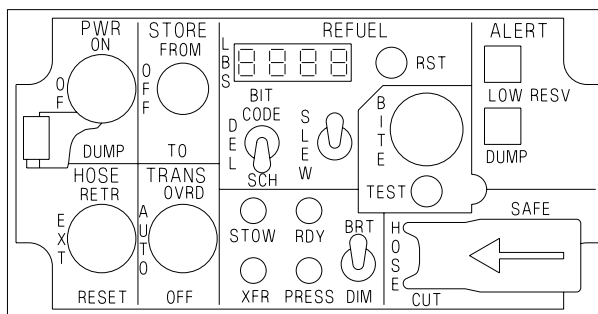

EFN520-27-1-001

Figure 9-3. ARS Control Panel

9.3.1.1 Power Switch (PWR). The PWR switch provides electrical and hydraulic power to the store.

NOTE

For the -4/-5 ARS stores, once powered on (220 KCAS min), airspeed may be reduced to as slow as 180 KCAS to transfer fuel below 5,000 ft MSL. Attempts to power on below 220 KCAS will be unsuccessful and accelerating to 220 KCAS will not recover the RAT. Store power must be turned off and airspeed increased to 220 KCAS or greater before re-applying power.

- ON Electrical power is routed in the store and the ram air turbine (RAT) unfeathers, which provides hydraulic power.
- OFF Feathers the RAT and removes electrical and hydraulic power.
- DUMP Disabled and safety guarded.

NOTE

If the hose is extended, the PWR switch is bypassed (cannot be turned OFF).

9.3.1.2 STORE Switch. The STORE switch controls fuel transfer between the store and tanker (own aircraft).

- FROM Pressurizes the store to transfer fuel from store to own aircraft.
- OFF Depressurizes store.
- TO Replenish ARS with own aircraft fuel.

9.3.1.3 REFUEL Display. The four digit display indicates fuel (in pounds) delivered or scheduled, a three digit BIT code - when commanded, or a 0E when a serious malfunction occurs. The display initially powers up with 2,500 lb scheduled.

9.3.1.4 Refuel RST Button. A momentary pushbutton that returns LBS scheduled or delivered to original settings. Pounds scheduled returns to 2,500 pounds or previously scheduled quantity. Pounds delivered returns to zero.

9.3.1.5 Refuel Data Display Switch. The refuel data display switch is a three position toggle switch which is spring-loaded to the delivery (DEL) position. The switch can be toggled to the BIT CODE or scheduled (SCH) positions.

- BIT
CODE Three digit number indicates a malfunction code.
- DEL Pounds of fuel being transferred (25 lb increments).

SCH Pounds of fuel scheduled to be transferred. When scheduled point is reached, automatic transfer is terminated. 2,500 lb automatically scheduled at power up.

9.3.1.6 Refuel SLEW Switch. The SLEW switch is a three position toggle switch which is spring-loaded to the center position. If the refuel data display switch is in the SCH position, moving the switch up increases pounds of fuel scheduled for transfer, and down decreases the fuel scheduled for transfer. In SCH, the SLEW switch moves the selected indications as follows:

1. 0 to 100 lb, 75 lb/sec in 25 lb increments
2. 100 to 1,000 lb, 300 lb/sec in 100 lb increments
3. >1,000 lb, 600 lb/sec in 200 lb increments

9.3.1.7 BITE Flag Indicator. The BITE flag indicator indicates failures in the control panel assembly.

9.3.1.8 ALERT Indicators. There are two ALERT lights on the right side of the ARS panel.

LOW RESV A red warning light illuminates when the hydraulic reservoir level drops below $\frac{1}{2}$ full and begins flashing when the reservoir level drops below $\frac{1}{4}$ full.

DUMP ARS DUMP is not functional.

9.3.1.9 HOSE CUT/SAFE Switch. The HOSE CUT/SAFE switch is a two position switch spring-loaded to the SAFE position and held in SAFE by a spring-loaded guard. The switch is wired through the WonW interlock to prevent accidental activation on the deck.

SAFE Normal position.

CUT Refueling hose is cut and crimped. ARS is deactivated hydraulically and electrically. In flight, the switch must be held for several seconds.

9.3.1.10 Dimming (BRT/DIM) Switch. The BRT/DIM switch controls the intensity of the receiver pilot advisory lights on the ARS tailcone and control panel displays. BRT is used for day operations, and DIM is used for night operations.

9.3.1.11 Status Lights. There are four status lights on the ARS control panel.

STOW Green light comes on when hose is approximately one foot from complete stowage. If hose/drogue is not fully stowed, the indication is through a MASTER CAUTION and aural tone, and the ARS DROGUE caution appears on the DDI.

RDY Green light illuminates when the hose is fully deployed and automatic hose response is established.

PRESS Green light illuminates when hydraulic pressure drops below 1,700 psi. Light goes out when pressure exceeds 2,000 psi.

XFR Green light illuminates when a minimum of 20 gallons/min of fuel is being transferred to the receiver.

9.3.1.12 TRANS Switch. The three position transfer switch is lever locked in the AUTO position and controls fuel transfer to the receiver aircraft.

OVRD The ARS fuel pump is turned on regardless of hose position, fuel schedule, or fuel remaining in the store. The OVRD position should only be used during emergency refueling situations.

AUTO When connected to receiver aircraft, fuel flows when the following conditions are met:

- The hose is within the refueling range (approximately 5 to 20 feet of full trail),
- ARS (fuel is above 175 pounds) is not low on fuel; and,
- The scheduled amount of fuel is not exceeded.

OFF Turns the pump off regardless of hose position.

9.3.1.13 HOSE Switch. The three position switch controls the hose reel. The HOSE switch lever locks in the RETR and EXT positions and is spring-loaded to EXT from the RESET position.

RETR The hose retracts or remains retracted.

EXT The hose extends or remains extended.

RESET Reset is used to establish a new reference pressure (after release to EXT) when air-speed varies more than 10 KCAS from the last reference airspeed (either at extension or at the time of the last RESET).

WARNING

Do not select RESET when a receiver aircraft is plugged in. RESET causes momentary loss of auto response and may damage receiver aircraft.

CAUTION

Failure to reset hose reference pressure may result in hose auto retraction if decelerating, or non-responsiveness if accelerating.

9.3.1.14 ARS DROGUE Caution. An ARS DROGUE caution on the DDI indicates that the ARS PWR switch is OFF and the refueling drogue has not fully retracted.

9.3.2 ARS (Tanker) Procedures.

9.3.2.1 Tanker Safety Precautions.

1. Do not extend the drogue when an ARS hydraulic leak is observed.
2. Do not actuate the speed brake function during any part of the refueling operation.
3. Single point failure of either the fuel/no air valve or ARS high level float sensor may result in fuel discharge from the ARS vent during refueling as a receiver (ground or inflight). Inability to transfer fuel from ARS to internal tanks, or failure to successfully complete pre-checks on ARS prior to ground refueling (hot pit or truck), are indications of single point failures. If failures are indicated, hot pit refueling and/or inflight refueling is prohibited.

NOTE

- When tanks 1 and 4 are empty, no more fuel can be transferred to the ARS. With normal fuel transfer, this occurs at a normal aircraft fuel state of 4,200 to 4,900 pounds.
 - Anytime four external fuel tanks are loaded on wing stations (3, 4, 8, and 9), selecting ORIDE on LI/RI external transfer switch will improve dump performance and external transfer rate by commanding simultaneous transfer of all external tanks vs. normal transfer sequence (tanks on Stations 3/9 must be empty prior to tanks on Stations 4/8 transferring). Performing this function imposes airspeed limitations defined in Figure 4-12.
4. Avoid use of barometric altitude hold in turbulent conditions or whenever receiver is having difficulty achieving basket contact.

9.3.2.2 ARS Interior Checks -

1. PWR switch - OFF
2. STORE switch - OFF
3. HOSE switch - RETR
4. PWR switch - OFF
5. Fuel TRANS switch - OFF
6. Light switch - BRT (day), DIM (night)
7. REFUEL data display switch - DEL
8. HOSE CUT switch - SAFE/GUARD DOWN

NOTE

If the post guillotine shutdown relay in the tail section of the store has not been reset following guillotine maintenance or actuation, the system will not operate.

9. EXT LT IDENT knob - Select appropriate strobe pattern

9.3.2.3 System Check - Prestart. Have the ground crew rotate the Ram Air Turbine (RAT) counterclockwise, while facing aft, until the RAT blades are at full feather.

1. External electrical power - APPLY
 - a. EXT PWR switch - RESET
 - b. GND PWR switches 1, 2, 3, and 4 - B ON (hold for 3 seconds)
2. RAT unfeather test - PERFORM
 - a. ARS PWR switch - ON
 - b. STOW light and PRES light - CHECK ON
 - c. Make sure ground crew verify proper operation of RAT.

WARNING

Prior to placing the ARS PWR switch to ON, make sure ground crew are clear of the ARS as the RAT blades will move to the unfeather position very rapidly.

3. BIT codes - CHECK
 - a. REFUEL DATA DISPLAY switch - BIT CODE
 - b. Refuel data display - CHECK (No codes should be present. If any codes are present, have ground crew reset display).
4. BITE test - PERFORM
 - a. BITE TEST button - PRESS
 - b. ARS control panel lights - CHECK (All should illuminate for 10 seconds, then go out.)
 - c. Refuel data display - CHECK (Display counts from 00 to 500 in 25 pound increments, and then returns to 00. If it indicates 0E, a serious malfunction has occurred and the ARS is down.)
 - d. Make sure ground crew verify proper operation of all tail cone lights.
5. ARS PWR switch - OFF (RAT remains unfeathered and control panel lights extinguish.)

9.3.2.4 System Check - Airborne.

1. HOSE switch - RETR
2. ARS PWR switch - ON (white STOW light illuminates)
3. BITE test - PERFORM
 - a. BITE TEST button - PRESS
 - b. ARS control panel lights - CHECK (All should illuminate for 10 seconds, then go out.)
 - c. Refuel data display - CHECK (Display counts from 00 to 500 in 25 pound increments, and then returns to 00 if no faults detected. If 0E is displayed, it indicates a serious malfunction has occurred and the ARS is down).

NOTE

- BITE check can only be performed with the hose stowed.
- Self-test of electronic and hydraulic systems takes approximately 90 seconds.
- If BITE is actuated with less than 300 gallons, or 200 pounds of fuel in the store, invalid fault indications may result.

9.3.2.5 Drogue Extension.

1. LTDR switch - CHECK SAFE

WARNING

- Permanent eye damage to the receiving aircrew can occur if laser is armed and firing during aerial refueling, even when using "eye safe" mode.
- Do not attempt to extend the hose unless system self-test has been successfully completed.

2. HOSE switch - RETR
3. PWR switch - ON (white STOW light illuminates)

NOTE

For the -4/-5 ARS stores, once powered on (220 KCAS min), airspeed may be reduced to as slow as 180 KCAS to transfer fuel below 5,000 ft MSL. Attempts to power on below 220 KCAS will be unsuccessful and accelerating to 220 KCAS will not recover the RAT. Store power must be turned off and airspeed increased to 220 KCAS or greater before re-applying power.

4. Airspeed - Refer to ARS operating limitations, figure 4-13.
5. HOSE switch - EXT (White STOW light extinguishes; amber RDY light illuminates when drogue reaches full trail. HOSE advisory appears on the DDI).
6. STORE switch - TO
7. Fuel TRANS switch - AUTO or OFF

9.3.2.6 Fuel Transfer. The amount of fuel to be transferred is automatically set at 2,500 pounds. To change the scheduled amount, place the REFUEL switch to SCH, and the digital display shows the amount scheduled. To increase or decrease the amount scheduled, hold the SLEW switch up or down, respectively. When desired amount is shown on the digital display, release SLEW switch and return

REFUEL switch to DEL. When fuel is transferred with the TRANS switch in AUTO, the digital display reads upward until the fuel transfer is automatically stopped at the scheduled amount. Pressing the REFUEL RST button resets the digital display to zero and reschedules 2,500 pounds, or the previously scheduled amount when the switch is in the DEL position.



The TRANS switch should always be in the AUTO position for normal fuel transfer. The OVRD position is an emergency condition that overrides normal system operation and provides fuel flow regardless of hose position.

9.3.2.7 Receiver Hook-up and Refueling. After the receiver aircraft engages and moves forward into the refueling range, the store amber RDY light extinguishes. Fuel transfer commences if the FUEL TRANS switch is in the AUTO position. The green XFR light illuminates when the transfer rate is 20 gallons per minute or higher.

9.3.2.8 Stopping Fuel Transfer. The receiver aircraft receives fuel until one of the following occurs:

1. The IFR probe disengages.
2. The receiver aircraft moves out past the fueling range outer limit, approximately 5 feet from full trail (the amber ready light comes on).
3. The receiver aircraft moves in past the refueling range inner limit, approximately 25 feet from full trail (the amber ready light flashes).



- Refueling cannot be stopped by placing the PWR switch to OFF with the hose extended.
- Lack of hydraulic pressure causes a loss of hose response resulting in hose instability and a potential hose whip incident. If either the red PRESS or LOW RESV light comes on, aerial refueling should be terminated and the hose retracted.

Transfer of fuel to the aerial refueling store continues until one of the following occurs:

1. ARS TRANS switch is placed to OFF.
2. The BINGO caution comes on.
3. Tanks 1 and 4 are empty (with normal fuel transfer, this occurs at a fuel state of approximately 5,000 pounds of fuel). The FQTY advisory comes on.

9.3.2.9 Emergency Fuel Transfer. If problems are encountered in obtaining fuel transfer from the store to the receiver aircraft, a system is provided that bypasses some normal switch functions to provide fuel transfer. After the receiver is engaged in the coupling, turn the TRANS switch to OVRD.

This switch provides power to open the shutoff valve and energize the priority valve to allow hydraulic flow to the fuel pump motor, and bypasses the low level switch and the fuel flow range switches.



- The receiver aircraft should not attempt engagement when the switch is in OVRD since there will be fuel pressure in the coupling that increases the force required to make an engagement. The force will be above that which provides adequate hose response and a damaging hose whip may result.
- The TRANS switch should be moved from OVRD to OFF prior to the receiver disconnecting. Fuel pressure in the coupling increases the disconnect forces by 200 pounds above normal. Momentary fuel spray may also occur.

NOTE

The TRANS switch should be taken out of the OVRD position if the green XFR light on the ARS control panel extinguishes.

9.3.2.10 Drogue Retraction.

1. TRANS switch - OFF
2. Airspeed - Refer to ARS operating limitations, figure 4-13.



Field arrestment or carrier landing with the drogue extended is not recommended. Guillotine (HOSE - CUT) drogue in clear or uninhabited areas.

3. HOSE switch - RETR
4. When the white STOW light illuminates, and the HOSE advisory clears, PWR switch - OFF

9.3.2.11 Transfer Fuel from ARS to Tanker (Own Ship). If it is desired to transfer fuel from the refueling store, do the following:

1. STORE switch - FROM

9.3.2.12 Before Landing.

1. STORE switch - OFF
2. HOSE switch - RETR
3. BIT codes - CHECK
 - a. REFUEL DATA DISPLAY switch - BIT CODE

b. Refuel data display - RECORD CODES

4. PWR switch - OFF

5. TRANS switch - OFF

9.3.3 ARS Jettison.

The ARS may be jettisoned in the same manner as other external stores.

9.3.4 ARS Limitations.

Refer to Chapter 4, Operating Limitations.

9.4 NIGHT VISION DEVICE (NVD) OPERATIONS

9.4.1 Effects on Vision. Flight techniques and visual cues used during unaided night flying also apply to flying with night vision devices (NVD). The advantage of NVD is improved ground reference provided through image intensifier systems (NVG/NAVFLIR). Dark adaptation is unnecessary for the effective viewing through night vision goggles (NVG). In fact, viewing through the NVG for a short period of time shortens the normal dark adaptation period. After using NVG, an average individual requires 1 to 3 minutes to reach the 30 minute dark adaptation level. Color discrimination is absent when viewing the NVG image. The image is seen in a monochromatic green hue and is less distinct than normal vision. Prolonged usage may result in visual illusions upon removal of the NVG. These illusions include complement or green after-images when viewing contrasting objects. Illusions from NVG are temporary and normal physiological phenomena and the length of time the effects last vary with the individual.

WARNING

- Aircrew are strongly cautioned against maneuvering above 3g with the AN/AVS-9 in the up-locked (not in use but on helmet) position because the NVD bracket cannot retain AN/AVS-9 under elevated loads.
- Ejection wearing Night Vision Goggles is not recommended. Severe neck injury may result.

9.4.2 Effects of Light. Any non-NVG compatible light source in the cockpit degrades the ability to see with NVG. Filters are used to prevent stray or scattered light from reaching the NVG intensifiers, which would cause the automatic gain control to reduce the NVG image intensification. Head down displays (DDI, MPCD) are filtered to allow non-electrical-optical viewing of the display. Viewing areas illuminated by artificial light sources with NVG (runway/landing lights, flares, or aircraft position lights) limit the ability to see objects outside of the area.

NOTE

Bright ground lights may cause loss of ground references during landing. Avoid looking directly at bright light sources to prevent degrading NVG vision.

The NAVFLIR is not affected by light sources and complements NVG use.

9.4.3 Weather Conditions. NAVFLIR and NVG provide a limited capability to see through visibility restrictions such as fog, rain, haze, and certain types of smoke. As the density of the visibility restrictions increases, a gradual reduction in light occurs. Use of an offset scanning technique will help in alerting the pilot to severe weather conditions.

NOTE

Visibility restrictions produce a “halo” effect around artificial lights.

9.4.4 Object/Target Detection. Detection ranges are largely a function of atmospheric and environmental conditions. Moving targets with contrasting backgrounds or targets with a reflected or generated light or heat sources can be identified at greater ranges when using NVD.

9.4.5 Flight Preparation. Flights with NVD require unique planning considerations that include weather, moon phase/angle, illumination, ground terrain and shadowing effects. Tactical consideration and procedures can be found in the Night Attack operational tactics guides (OTG).

9.5 SHORT AIRFIELD FOR TACTICAL SUPPORT (SATS) PROCEDURES

9.5.1 Landing Pattern. Approach the break point either individually or in echelon, parade formation, at 250 KIAS. A 17 to 20 second break interval provides a 35 to 40 second touchdown interval. The landing checklist should be completed and the aircraft should be at on-speed AOA/approach speed by the 180° position.

9.5.2 Approach. Plan for and execute an on-speed approach. Pay particular attention to maintaining the proper airspeed and correct lineup.

9.5.3 Waveoff. To execute a waveoff, immediately add full power and maintain optimum attitude. Make all waveoffs straight ahead until clear of the landing area.

9.5.4 Arrested Landing. The aircraft should be on runway centerline at touchdown. Aircraft alignment should be straight down the runway, with no drift. Upon touchdown, maintain the throttle at the approach position. When arrestment is assured, retard the throttle to idle. Allow the aircraft to roll back to permit the hook to disengage from the pendant. When directed by the taxi director, apply both brakes to stop the rollback and raise the hook. If further rollback is directed, release brakes and allow the aircraft to be pulled back until a brake signal is given. Apply brakes judiciously to prevent the aircraft from tipping or rocking back.



Use extreme caution when taxiing on a wet SATS runway.

9.5.5 Bolter. Bolters are easily accomplished. Simultaneously apply full power and retract the arresting gear hook. Smoothly rotate the aircraft to a lift-off attitude and fly away.

WARNING

- Bolters in GAIN ORIDE or with AOA failed require positive aft stick during rotation, 1/2 aft stick is recommended. Deflections of less than 1/2 aft stick will result in excessive settle during bolters.
- If landing on a runway with a SATS catapult installed, care must be taken to prevent engagement of the dolly arrester ropes with the aircraft tailhook. Structural damage to the aircraft and catapult will result.

9.6 HOT SEAT PROCEDURE

1. PARK BRK handle - SET
2. Paddle switch - PRESS (disengage NWS)
3. Left throttle - OFF
4. Throttle friction - MAX
5. Avionics - AS DESIRED

9.7 ALERT SCRAMBLE LAUNCH PROCEDURES

9.7.1 Setting the Alert. The alert/scramble aircraft shall be preflighted in accordance with NATOPS normal procedures every 4 hours or as local directives dictate. The pre-alert turn shall consist of full Plane Captain checks and full systems checks. Minimum requirements are:

1. Radar BIT status - GO
2. AIM-7 - TUNED (if loaded)
3. INS alignment status - OK
4. COMM 1 and 2 - SET TO LAUNCH FREQUENCY
5. Launch trim - SET (IAW Catapult Trim Calculations, Chapter 8)

Before engine shutdown -

6. INS known - OFF (10 seconds before engine shutdown)

NOTE

Do not switch INS to NAV during pre-alert turn so that STD HDG option will be available for next alignment.

7. CRYPTO switch - HOLD THEN NORM
8. Sensors and weapon systems - ON
9. COMM 1 and 2 knobs - ON
10. EMCON - AS DESIRED
11. Exterior and interior lights - SET
12. DDIs, MPCD, and HUD - ON
13. OBOGS control switch and OXY FLOW knob - OFF
14. Landing gear pins - REMOVED and STOWED

After engine shutdown -

15. External electrical power -CONNECT (if applicable)
16. EXT PWR switch - RESET THEN NORM
17. GND PWR switches 1, 2, 3, and 4 - OFF
18. BATT switch - OFF
19. SINS cable - CONNECT (if required)

9.7.2 Alert Five Launch.

If on external power -

1. GND PWR switches 1, 2, 3, and 4 - B ON (hold 3 seconds)
2. INS known - CV/GND
3. INS - STD HDG (if available)
4. BATT switch - ON
5. APU switch - ON (READY light within 30 seconds)
6. R engine - START
7. L engine - START
8. FCS RESET button - PUSH (verify RSET advisory displayed)
9. OBOGS control switch and OXY FLOW knob - ON
10. External electrical power - DISCONNECT (if applicable)
11. SINS cable - DISCONNECT (if applicable)

12. INS knob - NAV, GYRO or IFA
13. T.O. checklist - COMPLETE

9.8 AIRBORNE HMD ACCURACY CHECKS

The procedures below shall be performed to verify JHMCS accuracy at any time system accuracy is in question, including verifying the accuracy of the cockpit magnetic map. These procedures require an airborne target.

If performing these procedures to determine if cockpit re-mapping is needed following maintenance, only 9.8.2 Airborne HMD Accuracy Check with Radar is required. Cockpit re-mapping is not required if 9.8.2 Airborne HMD Accuracy Check with Radar is successful.

9.8.3 Airborne HMD Accuracy Check with CATM/AIM-9X can be performed at the aircrew's discretion to verify accuracy in the high off-boresight field of regard.

NOTE

If preflight HMD Alignment occurred less than 15 minutes after system powered on, repeat 9.8.1 HMD Alignment prior to any airborne checks.

9.8.1 HMD Alignment.

(CVRS record HMD if desired)

1. SUPT/HMD/ALIGN page - SELECT
2. Superimpose the HMD alignment cross on the HUD/BRU alignment cross.
3. Cage/Uncage button - PRESS and HOLD until ALIGNING turns to ALIGN OK or ALIGN FAIL

If ALIGN FAIL -

4. Repeat steps 2 and 3.

If ALIGN OK and HMD alignment crosses are not coincident with HUD/BRU alignment cross -

4. Perform FINE ALIGN -
 - a. With FA DXDY displayed, use TDC to align azimuth and elevation HMD alignment crosses with the HUD/BRU alignment cross.
 - b. Cage/Uncage button - PRESS and RELEASE
 - c. With FA DROLL displayed, use TDC to align the roll axis HMD alignment crosses with the HUD/BRU alignment cross.
 - d. Cage/Uncage button - PRESS and RELEASE

If satisfied with alignment -

5. ALIGN - UNBOX

9.8.2 Airborne HMD Accuracy Check with Radar.

1. Select STT while in trail of an airborne target.
2. Compare HMD TD Box to HUD TD Box and target's actual position (when in HUD FOV) and compare HMD TD Box and target's actual position (when NOT in HUD FOV) at various azimuth/elevation angles (up to 45° laterally left and right and 45° in elevation).

If HMD and HUD TD Boxes are not nearly coincident or portion of target is not located within HMD and HUD TD Boxes -

3. Perform 9.8.1 HMD Alignment procedures.
4. Repeat steps 1 and 2.

If HMD Alignment does not correct -

5. Consider re-mapping the cockpit.

9.8.3 Airborne HMD Accuracy Check with CATM/AIM-9X.

1. No L&S track selected.
2. Select AIM-9X (manual mode).
 - Verify AIM-9X symbology on HMD and AUTO not displayed below 9X at bottom of display.
 - Verify AIM-9X slaved to HMD.
3. Perform the following steps at various azimuth/elevation angles throughout the AIM-9X field of regard and outside the radar field of regard until aircrew are confident that the HMD and AIM-9X are pointing properly:
 - a. Place aiming cross on the target.
 - b. Cage/Uncage button - PRESS to command AIM-9X to enter track
 - Verify AIM-9X enters track on the target.
 - Verify in-track seeker circle is within one 9X circle size of touching the target.
 - c. Cage/Uncage button - PRESS to slave AIM-9X to HMD
 - d. Set up next azimuth/elevation angle and repeat steps a through c.

If the in-track seeker circle is not within one 9X circle size of touching the target -

4. Perform 9.8.1 HMD Alignment procedures.
5. Repeat steps 1 through 3.

If HMD Alignment does not correct -

6. Consider re-mapping the cockpit.

CHAPTER 10

Functional Checkflight Procedures

10.1 GENERAL

The intent of functional checks is to determine whether the airframe, power plant, accessories, and equipment are functioning per predetermined standards. The unique electronic built-in test (BIT), fault detection, and fault isolation capabilities of the F/A-18E/F allow functional checks that have historically been performed inflight to be performed on the ground. In general, engine control and flight control system faults are reliably detected, annunciated, and, in most cases, functionally bypassed by the aircraft control systems.

In most cases, functional checks for the F/A-18E/F will be performed on the ground by maintenance personnel based on the requirements set forth in the maintenance work package for the component being removed, replaced, and/or installed and not by a pilot on a dedicated FCF. Required maintenance ground checks take advantage of the aircraft's BIT and fault detection capability and ensure the health of the component and the integrity of the installation.

10.1.1 Engine Functional Checks. Based on the engine component replaced, ground functional test requirements for the engine may include any or all of the following: idle speed test (low power turn); air, oil, fuel leak test (leak check); anti-ice test; MIL power test; MIN AB test; MAX power test (high power turn); transient test; and/or shutdown test. For instance, a single engine removal/reinstallation, a single engine replacement, or a dual engine removal/reinstallation requires a low power turn and a leak check. A dual engine replacement requires a low power turn, leak check, and high power turn. A FADEC replacement requires ALL functional checks. Additionally, a crossbleed start is required on all engine reinstallations and replacements. Given the FADEC's fault detection capability, successfully completing these functional checks ensures that the engine is properly installed and is functioning normally. All engine functionality that would be checked inflight is checked during the required ground checks. Dedicated FCFs are, therefore, not required following engine related maintenance actions.

10.1.2 Flight Control System Functional Checks. Functional test requirements for the aircraft FCS include electronic rigging, an FCS maintenance BIT, and a test group (TG) for the specific actuator or surface which was reinstalled or replaced. The FCS maintenance BIT requires operator intervention and is the most comprehensive test of the FCS. The FCS maintenance BIT also performs unique tests to verify the proper installation of a system component. Successfully completing these functional checks ensures that all surfaces and actuators are properly installed and the FCS is functioning normally.

Generally, dedicated FCFs are not required following actuator/surface related maintenance actions. An exception involves the replacement of a LEF hydraulic drive unit (HDU). It is possible for a weak LEF HDU to pass ground checks yet fail to drive the LEF to the proper position when the surface is subjected to air loads. A weak HDU may manifest itself by a LEF split, a FLAP SCHED caution, and/or a possible roll off. Therefore, following the replacement of a LEF HDU, a series of inflight functional checks are required to test the new component at flight conditions that safely detect weak HDUs.

10.1.3 Landing Gear Functional Checks. Ground functional test requirements for the landing gear system include the following: aircraft jack, LDG GEAR handle mechanical stop and DOWNLOCK ORIDE button test, landing gear warning light and warning tone test, normal landing gear extension and retraction, planing link failure test, and emergency landing gear extension (front and rear cockpits in the F/A-18F). Successfully completing these functional checks ensures that the normal and emergency landing gear systems are functioning normally. While a dedicated FCF is not required following landing gear related maintenance, an airborne functional check of the emergency landing gear system may nonetheless be desired. An airborne functional check, coded E, has been included to perform this test, at the discretion of the Maintenance Officer, on a "pro and go" (FCF combined with but before operational flight) basis.

10.2 FCF REQUIREMENTS

Figure 10-1 lists the FCF requirements for the F/A-18E/F. Where appropriate, functional checks are grouped by system and are coded with a letter, A thru E, to identify the type of FCF profile to be flown. These letter codes appear next to each required item or groups of items in the FCF checklist.

COMNAVAIRFORINST 4790.2 Series allows an FCF to be flown in combination with operational flights at the discretion of the Commanding Officer, provided the operational portion is not conducted until the FCF requirements have been completed and entered on the FCF checklist. Generally, a profile "A" FCF is flown as a dedicated flight due to the number of required checks. However, due to the limited number of required checks, profile "C" and "E" FCFs, as well as profile "D" FCFs required solely by the reconfiguration of the rear cockpit, can be flown and are recommended to be flown as "pro and go's."

10.3 FCF QUALIFICATIONS

Aircrew who perform FCFs shall be qualified per OPNAVINST 3710.7 and must be designated in writing by the Squadron Commanding Officer. For a profile "A" FCF, the complete FCF checklist shall be utilized. For a profile "C" or "E" FCF, a special, abbreviated FCF checklist has been created which incorporates only those checks required for a "C" and "E" profile. Prior to flight, FCF aircrew must familiarize themselves with the FCF checklists and the specific functional checks required for the given profile.

Historically, FCF checklists have only included FCF checks. To reduce confusion and provide a more coherent checklist, the FCF checks presented in this chapter have been interleaved into the normal NATOPS checklist. Specific FCF requirements are, therefore, highlighted in italics in this chapter and in the FCF checklist which is utilized inflight. Additionally, check-off blocks, provided on the FCF checklist, appear next to those items required by the FCF and not next to non-FCF, normal procedure, items.

The FCF checklist shall be properly completed and promptly returned to Maintenance Control at the completion of the FCF.

10.4 FCF PROCEDURES

FCFs shall be conducted with the minimum crew necessary to ensure proper operation of all required equipment. FCF aircrew shall be given a thorough preflight briefing, coordinated by Maintenance Control and given by appropriate QA and work center personnel. The briefing shall describe maintenance performed, the requirements for that particular flight, and the expected results.

FCFs shall be performed using the applicable FCF checklist. The procedures contained in the FCF checklist are presented in a recommended order. While the order of these functional checks may be altered as required, the sequence of steps listed for any procedure is mandatory.

If an FCF profile cannot be completed on a single flight due to time, fuel, operating area restrictions, or other limiting factors, it is permissible to complete the remaining checks on a subsequent flight. This subsequent flight may be flown by a different pilot, provided there is a thorough passdown, either verbal or written, between the pilots.

Profile	Type of Checks/Requirements
A	<p>Complete FCF profile</p> <ul style="list-style-type: none"> • Completion of SDLM, to be conducted by the rework facility. • Acceptance of a newly assigned aircraft or upon receipt of an aircraft returned from SDLM. • Return to flight status of an aircraft that has not flown in 30 or more days. • At the discretion of the Maintenance Officer (e.g., return to flight status of an aircraft that has been excessively cannibalized). <p style="text-align: center;">NOTE</p> <p style="text-align: center;">In an F/A-18F (missionized configuration), an FCF qualified rear cockpit crewmember is required unless the Maintenance Officer determines that the maintenance actions performed do not require one.</p>
B	<p>Engine/FADEC/fuel control</p> <ul style="list-style-type: none"> • Not required.
C	<p>LEF Checks</p> <ul style="list-style-type: none"> • Removal/reinstallation or replacement of a LEF HDU.
D	<p>Rear cockpit checks of an F/A-18F (trainer configuration only)</p> <ul style="list-style-type: none"> • Acceptance of a newly assigned aircraft or upon receipt of an aircraft returned from SDLM. • Reconfiguration from missionized to trainer configuration. <p style="text-align: center;">NOTE</p> <p style="text-align: center;">Aft crewmember is required.</p>
E	<p>Emergency landing gear extension</p> <ul style="list-style-type: none"> • At the discretion of the Maintenance Officer (e.g., following extensive maintenance on the landing gear system).

Figure 10-1. Functional Checkflight Requirements

10.5 FCF CHECKLIST - PROFILE A

10.5.1 Plane Captain Brief.

1. Connect external power.
2. FCS ram air scoop check (manually restow)
3. REFUEL DR check
4. Normal engine starts
5. Alternate engine shutdowns
 - a. Fuel/air heat exchanger leak check
 - b. Switching valve checks
 - c. Crossbleed restarts
6. ECS ram air scoop check
7. Engine runups to check cautions
8. 4 down but only 3 up (launch bar down)
9. Probe light check
10. Tail light check

10.5.2 Preflight Checks.

1. Exterior Inspection - Perform IAW NATOPS
 - a. *No loose or improperly installed panels.*
 - b. *External canopy switch - CHECK*
 - *Canopy opens and closes smoothly.*
 - *Returns to center (hold) position when released.*
 - c. *Boarding ladder operation - CHECK*
 - *Ladder electrically deploys.*
 - *Ladder extends, locks, unlocks, and stows correctly.*
2. Interior Checks - Perform IAW NATOPS
 - a. *No loose or improperly installed components (both cockpits).*
 - b. *Brake accumulator pressure gauge reads 2,600 psi minimum.*
 - c. *Canopy and windscreen: No distortion, blemishes, or cracks (both cockpits).*

10.5.3 Pre-Start Checks.

1. BATT switch - ON
2. Battery gauge - CHECK
 - *Nominal: 23 to 24 vdc*
 - *FCF minimum: 18 vdc*
3. Caution Lights Panel - CHECK CABIN light on (if CPWS installed)
4. ICS - CHECK (F/A-18F)

Apply external electrical power -

5. EXT PWR switch - RESET
6. GND PWR switches 1, 2, 3, and 4 - B ON (hold for 3 seconds)
 - *Audibly verify avionics cooling fans are on.*
7. COMM 1 and 2 knobs - ON/VOLUME AS DESIRED (both cockpits)
8. L(R) DDI, HUD, and MPCD knobs - ON (both cockpits)
 - a. *Display IBIT - Select ALL*
 - *Approximately 3 minutes required before TEST patterns displayed.*
 - *No stuck pushtile indications (small circles).*
 - *Push STOP when complete.*
 - *All displays operative.*
 - *Note DEGD indications if present.*
 - b. *All mode (day/night), brightness, and contrast controls for all cockpit displays - CHECK/SET (both cockpits)*
 - c. *Display surfaces - CHECK (both cockpits)*
 - *No burned phosphor spots on HUD or DDIs.*
 - *No lineouts or burned liquid crystals on MPCD, UFCD, or EFD.*
 - d. *HUD symbology reject - CHECK*
 - (1) *Select REJ2*
 - *Heading scale, command heading, heading caret, nav range (if displayed), bank angle, g, and airspeed and altitude boxes are removed.*
 - (2) *Select NORM*
 - e. *HUD displayed radar altitude - CHECK*
 - (1) *UFCD/RALT - ON*
 - (2) *ALT switch - RDR*
 - *HUD displays radar altitude and "R".*
 - (3) *ALT switch - BARO*
 - *HUD displays barometric altitude.*

- f. (AMCD) ~~WDBU~~ advisory - NOT DISPLAYED
9. LT TEST switch - TEST (both cockpits)
- All warning and caution lights properly illuminate.
 - Landing gear warning tone annunciates (front cockpit switch only).
- a. AOA indexer brightness - CHECK AND SET
10. Seat adjustment - CHECK (both cockpits)
- Smooth through full range of travel.
 - Do not hold switch against stops (no limit switches).
11. Rudder pedal adjustment - CHECK (both cockpits)
- Adjustment smooth through full range of travel.
- a. SET PEDAL POSITION FULL FORWARD
- Cycle left and right pedal to check for binding.
- b. SET PEDAL POSITION AS DESIRED FOR FLIGHT
- Locks securely when RUD PED ADJ lever released.
12. EXT and INTR lights - Check for proper operation to extent possible for ambient conditions (both cockpits)
- Signal: Point 2 fingers at eyes.
13. FIRE warning test
- a. FIRE test switch - TEST A (hold until all lights and aural warnings indicate test has been successfully passed)
- b. FIRE test switch - NORM (pause 7 seconds or cycle BATT switch for system reset)
- c. FIRE test switch - TEST B (hold until all lights and aural warnings indicate test has been successfully passed)

10.5.4 Engine Start Checks.

APU start -

1. APU ACC caution light - VERIFY OFF
2. APU switch - ON (READY light within 30 seconds)
3. ENG CRANK switch - R
4. Right throttle - IDLE
 - RPM 10 % minimum
 - TEMP 871°C maximum transient
 - OIL 10 psi within 30 seconds
5. Battery gauge - VERIFY 28 vdc
 - Battery charger failed if ≤ 24 vdc.

6. EFD - CHECK

Ground idle -

- RPM 61 % minimum
- TEMP 250° to 590°C
- FF 600 to 900 pph
- OIL 35 to 90 psi (warm oil)
- NOZ 77 % to 83 %

7. External electrical power - DISCONNECT

8. BLEED AIR knob - NORM

9. ENG CRANK switch - L

10. Left throttle - IDLE

- RPM 10 % minimum
- TEMP 871°C maximum transient
- OIL 10 psi within 30 seconds

11. ENG CRANK switch - CHECK OFF

12. EFD - CHECK

10.5.5 Post-Start Checks.1. *APU automatic shutdown - CHECK*

- *APU shutdown 1 minute after second generator online.*

2. *WINDSHIELD ANTI ICE/RAIN removal - CHECK*a. *WINDSHIELD switch - ANTI ICE*

- *Verify airflow along the canopy bow.*

b. *WINDSHIELD switch - RAIN*

- *Verify reduced airflow along the canopy bow.*

c. *WINDSHIELD switch - OFF*

- *Verify airflow is secured.*

3. *Canopy operation (front cockpit) - CHECK*a. *CANOPY switch - CLOSE (half way)*

- *Canopy stops when switch is released.*

b. *CANOPY switch - OPEN then release*

- *Switch returns to HOLD position.*
- *Canopy moves to full open position.*

c. *(LOTs 26 and up) Repeat steps a-b for the aft canopy switch.*

- d. (LOTS 26 and up) Front CANOPY switch - CLOSE, aft CANOPY switch - OPEN -
 - Canopy should go up.
 - e. (LOTS 26 and up) Aft CANOPY switch - CLOSE, front CANOPY switch - OPEN -
 - Canopy should go up. Position canopy as desired.
4. WINGFOLD switch - SPREAD
5. FCS RESET button - PUSH (verify RSET advisory displayed)
- No flight control surface Xs.
 - No BLIN codes.
 - No complete FCC channel failures.

After successful FCS reset -

6. GAIN ORIDE - CHECK

With flaps FULL -

- a. GAIN switch - ORIDE
 - LAND advisory displayed.
 - Amber FLAPS light on.
 - b. FLAP switch - AUTO
 - CRUIS advisory displayed.
 - Amber FLAPS light on.
 - c. GAIN switch - NORM/GUARD DOWN
 - Amber FLAPS light out.
7. FCC keep-alive circuitry - CHECK
- a. FCS CH circuit breakers - PULL IN SEQUENCE 1, 2, 3, AND 4
 - b. Immediately reset in sequence 1, 2, 3, 4.
 - Complete within 7 seconds for valid test.
 - No FCC channel completely Xd out.
 - No FCS surface Xs and no BLIN codes.

Steps 8 thru 12 are to be performed on both engines (RIGHT then LEFT).

8. Engine FIRE light shutdown - PERFORM
- a. Throttle affected engine - IDLE
 - b. FIRE light affected engine - PUSH
 - FIRE EXTGHI READY light comes on.

When BOOST LO caution appears, but no longer than 5 seconds -

- c. Throttle affected engine - IMMEDIATELY OFF
 - Master caution light comes on, and tone sounds when BOOST LO caution appears.

- d. *BIT/STATUS MONITOR/FXFR page - SELECT ON RDDI*
 - *X COOL line reads CL (closed).*
 - *Affected ENG SO line reads CL.*
 - *CROSS FD line reads CL.*
 - *Affected REC first value reads 0 (i.e., 0,0).*
 - *FADEC HOT caution may appear and is not a failure indication.*
- e. *FIRE light affected engine - RESET*
 - *X COOL line reads O (open).*
 - *Affected ENG SO line reads O.*
 - *CROSS FD line reads O.*
 - *Affected engine REC first value reads non-zero (e.g., 13,0).*

Discontinue FCF upon failure of any item listed under b, c, d, and e above.

With affected engine below 10% N2 rpm -

9. *Fuel/air heat exchanger leak check - PERFORM*
 - a. *RBYP or LBYP option (affected side) - PUSH TO READ HX*
 - *Signal: Pull tip of nose with thumb and index finger.*
 - *No fuel leaking from the heat exchanger drains (forward lower inboard side of the inlet on the affected side) (thumbs up from PC).*
 - b. *FXFR/RESET option - PUSH*
 - *RBYP or LBYP option (affected side) reads BP.*
10. *Verify proper switching valve operation.*
 - a. *Note hydraulic pressure decay through 500 psi on the affected side.*
 - b. *Cycle lateral stick and rudder pedals and verify aileron and rudder surface movement.*
 - c. *If aileron, rudder, or LEF surfaces X, maintenance action is required.*

11. *GEN/electrical system checks - PERFORM*

With affected GEN inoperative -

- *Opposite GEN picks up all three busses.*
 - *GEN TIE caution light out.*
 - *All displays operative.*
 - *No FCS Xs or channel failures.*
- a. *BATT switch - OFF (opens bus tie)*
 - *Busses are isolated on affected side.*
 - *BATT SW and GEN TIE caution lights on.*

With R GEN off -

- *HUD and RDDI inoperative.*
- *LDDI, MPCD, and UFCD operative.*

With L GEN off -

- HUD and RDDI operative.
 - LDDI, MPCD, and UFCD inoperative.
- b. *BATT switch - ON*
- *BATT SW and GEN TIE caution lights out.*
 - *All displays operative.*
- c. *GEN switch opposite side - OFF (for at least 30 seconds)*
- *PMGs pickup essential bus.*
 - *Battery gauge reads >24 vdc (26.5 vdc nominal).*
 - *BATT SW caution light out.*
- d. *GEN switch opposite side - NORM*
- *No complete FCC channel failures on FCS page.*
 - *ENGINE LEFT/RIGHT voice alert and BLIN code 260 can be expected and are normal in the conduct of this check.*
12. *Inoperative engine - CROSSBLEED START*
Advance operating engine to a minimum of 80% rpm.
13. *Repeat steps 8 thru 12 for the left engine.*
- *Restart left engine within 15 minutes, else motor for 1 minute at 29% rpm or greater before restart (to preclude engine damage).*
14. *GEN TIE operation - CHECK*
- a. *GEN TIE switch - RESET*
- *GEN TIE caution light on.*
- b. *GEN TIE switch - NORM/GUARD DOWN*
- *GEN TIE caution light out.*
15. *WYPT 0 and MVAR - CHECK/SET*
16. *GPWS/TAWS - CHECK BOXED*
17. *INS knob - CV OR GND (PARK BRK SET)*
18. *RADAR knob - OPR*
19. *FLIR and LST/FLR switches - AS DESIRED*
20. *UFCD avionics - TURN ON*
- a. *RALT - ON/SET*
- b. *TCN - ON, T/R, CH SET*
- c. *IFF - ON/MODES UNBOXED*
21. *MPCD/UFCD - ENTER DESIRED WAYPOINTS*

22. *Fuel system checks - PERFORM***On the RDDI -**a. *SDC/sensor operation - CHECK*

- (1) *SUPT/BIT/STATUS MONITOR page - SELECT*
- (2) *SDC BIT option - SELECT*
 - *SDC BIT status indicates GO.*
- (3) *FXFR page - SELECT*
 - *Do not take off with flashing parameters.*
- (4) *FQTY page - SELECT*
 - *Do not take off with flashing parameters.*

On the LDDI -b. *Fuel quantity/cautions/advisories - CHECK*

- (1) *SUPT/FUEL page - SELECT*
 - *No fuel cautions or advisories displayed.*
 - *No CG DEGD, EST, INV, INVALID, or INVALID TIMER.*
 - *BINGO, TOTAL, and INTERNAL fuel quantities agree with EFD.*
- (2) *FLBIT option - SELECT*
 - *On RDDI, TK2FL indicates GO within 2 seconds.*
 - *On RDDI, TK3FL indicates GO within 13 seconds.*
 - *FUEL LO caution and voice alert activated within 13 seconds.*
 - *FUEL LO caution removed 60 seconds after displayed.*
- (3) *SDC RESET option - SELECT*
 - *CAUT DEGD caution displayed for 3 seconds.*

On the EFD -c. *BINGO caution - CHECK*

- (1) *BINGO - SET 200 lb above INTERNAL fuel*
 - *BINGO caution and voice alert activated.*
- (2) *BINGO - SET 200 lb below INTERNAL fuel*
 - *BINGO caution removed.*
- (3) *BINGO - SET AS DESIRED*

23. *Hydraulic pressure gauge - CHECK (2,600 to 3,300 psi)*24. *ECS system checks - PERFORM*a. *DEFOG - CHECK*

- (1) *DEFOG handle - LOW*
 - *Minimum defog airflow and maximum cabin airflow.*
 - (2) *DEFOG handle - HIGH*
 - *Progressively decreasing cabin airflow and increasing defog flow.*
 - b. *ECS modes - CHECK*
 - *Signal: Punch open palm with fist.*
 - (1) *ECS MODE switch - OFF/RAM*
 - *Cabin airflow stops.*
 - *Cabin ram air scoop opens (thumbs up from PC).*
 - If CPWS installed -*
 - *CK ECS caution light on.*
 - *MASTER CAUTION light on and tone sounds.*
 - (2) *ECS MODE switch - AUTO*
 - *Cabin airflow resumes.*
 - *Cabin ram air scoop closes (thumbs up from PC).*
 - If CPWS installed -*
 - *CK ECS caution light out.*
 - c. *CABIN TEMP knob - ROTATE BETWEEN COLD AND HOT*
 - *Air temperature changes to agree with setting.*
 - d. *Cabin Pressurization - CHECK*
 - (1) *CABIN PRESS switch - DUMP*
 - *Cabin depressurizes.*
 - *Cabin airflow remains.*
 - If CPWS installed -*
 - *CK ECS caution light on.*
 - *MASTER CAUTION light on and tone sounds.*
 - (2) *CABIN PRESS switch - RAM/DUMP*
 - *Cabin remains depressurized.*
 - *Cabin airflow stops.*
 - *Cabin ram air scoop opens (thumbs up from PC).*
 - If CPWS installed -*
 - *CK ECS caution light on.*
 - (3) *CABIN PRESS switch - NORM*
 - *Cabin pressurizes.*
 - *Cabin airflow resumes.*
 - *Cabin ram air scoop closes (thumbs up from PC).*
 - If CPWS installed -*
 - *CK ECS caution light out.*
25. *ENG ANTI ICE system - CHECK*
- a. *ENG ANTI ICE switch - ON*
 - *LHEAT and RHEAT advisories displayed.*

- b. *ENG ANTI ICE switch - TEST*
- *INLET ICE caution displayed when switch held.*
26. *BLEED AIR system - CHECK*
- a. *Throttles - IDLE*
- b. *BLEED AIR knob - CHECK EACH POSITION INDIVIDUALLY*
- (1) *R OFF*
- *R BLD OFF caution displayed.*
 - *MASTER CAUTION light on and tone sounds.*
 - *Left engine TEMP increases 5° to 90°C.*
- (2) *MASTER CAUTION light - RESET*
- (3) *Pause 5 seconds to allow Master Caution tone to reset.*
- (4) *OFF*
- *L and R BLD OFF cautions displayed.*
 - *MASTER CAUTION light on and tone sounds.*
 - *Cabin airflow stops.*
 - *ECS auxiliary duct doors close (thumbs up from PC).*
- If CPWS installed -*
- *CK ECS caution light on.*
- (5) *L OFF*
- *R BLD OFF caution removed.*
 - *Right engine TEMP increases 5° to 90°C.*
 - *Cabin airflow resumes.*
 - *ECS auxiliary duct doors open (thumbs up from PC).*
- If CPWS installed -*
- *CK ECS caution light out.*
- c. *BLEED AIR knob - NORM*
- *L BLD OFF caution removed.*
 - *MASTER CAUTION light out.*
- d. *FIRE test switch - TEST A (for at least 2 seconds)*
- *L and R BLEED warning lights on while switch held.*
 - *Voice alert sequence initiated.*
 - *L and R BLD OFF cautions displayed.*
 - *Cabin airflow stops.*
- e. *BLEED AIR knob - CYCLE THRU OFF TO NORM*
- *L and R BLD OFF cautions removed.*
 - *Cabin airflow resumes.*
- f. *Repeat steps d and e for the TEST B position.*
27. *Mission computer operation - CHECK*

LOTS 21-24:

- a. *SUPT MENU - SELECT ON LDDI*
- b. *MC switch - 1 OFF*
 - *MC1 and NO RATS cautions displayed.*
 - *BIT, CHKLST, ENG, and ADI options removed from SUPT MENU.*
 - *ACL option appears on HSI.*
- c. *MC switch - NORM*
 - *MC1 and NO RATS cautions removed.*
 - *SUPT MENU options return.*
- d. *TAC MENU - SELECT ON LDDI*
- e. *MC switch - 2 OFF*
 - *MC2 caution displayed.*
 - *STORES option removed from TAC MENU.*
- f. *MC switch - NORM*
 - *MC2 caution removed.*
 - *STORES option returns.*

LOTS 25 and up:

- a. *SUPT MENU - SELECT ON RDDI*
- b. *MC switch - 1 OFF*
 - *MC1 caution displayed on MPCD.*
 - *BIT and CHKLST options removed from SUPT MENU.*
 - *(A/A Master mode) STORES option removed from TAC MENU.*
 - *LDDI displays green square.*
- c. *MC switch - NORM*
 - *MC1 caution removed.*
 - *LDDI display returns.*
 - *SUPT MENU option returns.*
- d. *TAC MENU - SELECT ON LDDI*
- e. *MC switch - 2 OFF*
 - *MC2 caution displayed on MPDC.*
 - *RDDI displays green square.*
 - *BIT, FCS, and CHKLST options removed from the SUPT MENU.*
 - *(A/A Master mode) STORES option removed from TAC MENU.*
- f. *MC switch - NORM*
 - *MC2 caution removed.*
 - *RDDI display returns.*
 - *STORES option returns.*

28. (LOT 25 and up) HUD backup operation - CHECK

- a. MC switch - 1 OFF FOR 3 SECONDS
- b. MC switch - 2 OFF
 - Both DDIs display a green square followed by a flashing STANDBY.
 - Backup HUD provided on MPCD and UFCD.
- c. MC switch - NORM

10.5.6 Before Taxi Checks.

1. *WINGFOLD system - CHECK*

With wings spread and locked -

- a. *WINGFOLD switch - HOLD*
 - *Ailerons fair and beer cans pop up.*
 - *WING UNLK cautions displayed.*
- b. *NWS button - PUSH (twice if required)*
 - *Full-time NWS HI available.*
- c. *WINGFOLD switch - FOLD*
 - *Wingfold system and locking pins operate properly.*
 - *Both ailerons Xd out.*
- d. *WINGFOLD switch - SPREAD THEN HOLD*
 - *Wings stop at intermediate position.*

With NWS HI selected -

- e. *WINGFOLD switch - SPREAD*
 - *Wings spread fully.*
 - *Beer cans go down.*
 - *WING UNLK caution removed.*
 - *NWS HI reverts to NWS (low).*
 - f. *NWS - PADDLE OFF*
2. *Throttle position related cautions - CHECK*
- a. *PARK BRK handle - SET*
 - b. *FLAP switch - AUTO*
 - c. *Stabilator trim - SET LESS THAN 3° NU*
 - d. *Ejection seat SAFE/ARMED handle(s) - SAFE (both cockpits)*
 - e. *Throttles - ADVANCE TO MIL MOMENTARILY (Do not allow engine RPM to exceed 80%.)*
 - *CK FLAPS and PARK BRK cautions displayed momentarily.*

- *CHECK TRIM and CHECK SEAT cautions displayed.*
 - *CHECK SEAT caution does not clear until seat(s) armed for takeoff.*
- f. *T/O TRIM button - PRESS UNTIL TRIM ADVISORY DISPLAYED*
- *CHECK TRIM caution removed.*

To the maximum extent possible, make sure wings are spread and locked prior to FCS IBIT to make sure all aileron related tests are performed.

3. FCS RESET button - PUSH (if required)
 - RSET advisory displayed.
 - If wings are folded, both ailerons Xd out.
4. FCS IBIT - PERFORM
 - a. FCS BIT consent switch - HOLD UP THEN PRESS THE FCS OPTION
 - b. AOA warning tone - VERIFY ANNUNCIATION AT FCS IBIT COMPLETION
 - c. FCS A and FCS B BIT status - VERIFY GO (if wings not folded)
 - d. FCS display - VERIFY NO BLIN CODES
5. Trim - CHECK
 - a. *Trim - FULL LEFT and UP (ailerons, rudders, and stabs)*
 - *Control surfaces respond correctly.*
 - b. *T/O TRIM button - PRESS UNTIL TRIM ADVISORY DISPLAYED*
 - c. *Trim - FULL RIGHT and DOWN (ailerons, rudders, and stabs)*
 - *Control surfaces respond correctly.*
6. T/O TRIM button - PRESS UNTIL TRIM ADVISORY DISPLAYED (stabilators 4° NU)
7. Controls - CHECK (tolerance $\pm 1^\circ$)
 - a. Control stick - CYCLE
 - (1) Full aft - CHECK 24° NU STABILATOR (check left and right stabilators track symmetrically within $\pm 1^\circ$ of each other)
 - (2) Full fwd - CHECK 20° ND STABILATOR (check left and right stabilators track symmetrically within $\pm 1^\circ$ of each other)
 - (3) Full L/R - CHECK 30° DIFFERENTIAL STABILATOR (21° with tanks or A/G stores on any wing station)
- CHECK DIFFERENTIAL TEFs
 - b. FLAP switch - HALF
 - c. Rudder pedals - CYCLE RUDDERS 40° L/R

- d. FLAP switch - FULL (carrier-based)
 - e. TRIM - SET FOR CATAPULT LAUNCH (carrier-based)
8. Five Down Checks
- a. PROBE, speedbrake, LAUNCH BAR switches and HOOK handle - CYCLE
 - Spoilers extend to $60^{\circ} \pm 3^{\circ}$ and retract in 3 seconds.
 - SPDBRK light on when spoilers not fully retracted.
 - Hook extends within 2 seconds and retracts within 4 seconds.
 - Probe extends and retracts within 6 seconds.
 - Probe light is on with the probe extended (thumbs up from PC).
 - Launch bar extends (leave extended).
 - Green LBAR advisory light on.
 - b. AV COOL switch emergency cooling check
 - AV COOL switch - EMERG (FCS ram air scoop deploys)
9. Pitot and AOA heat check - PERFORM
- a. PITOT ANTI ICE switch - ON
 - b. Make sure ground crew verify proper operation.
 - c. PITOT ANTI ICE switch - AUTO
10. CHECK TRIM caution - CHECK
- With launch bar extended -**
- a. Stabilator trim - SET LESS THAN 6° NU
 - b. Throttles - Advance to MIL momentarily. Do not allow engine rpm to exceed 80%.
 - CHECK TRIM caution displayed.
 - c. Stabilator trim - SET ABOVE 7° NU
 - CHECK TRIM caution removed.
 - d. T/O TRIM button - PRESS UNTIL TRIM ADVISORY DISPLAYED
 - e. LAUNCH BAR switch - RETRACT
11. CVRS - AS DESIRED (both cockpits)
12. Standby attitude reference indicator - UNCAGE AND ERECT (both cockpits)
13. Altimeter setting - SET (both cockpits)
- Altimeter setting displayed on HUD.
 - HUD altitude displayed within ± 30 feet of parking spot elevation.
 - Standby altimeter within ± 60 feet of parking spot elevation.
14. INS - CHECK

- a. *PARK BRK handle - CYCLE*
 - *INS alignment time flashes when PARK BRK released.*
 - *Stops flashing after PARK BRK reset.*
 - *On ANAV equipped aircraft the alignment time does not flash when PARK BRK is released unless the aircraft moves.*
- b. Alignment status - VERIFY COMPLETE
 - *QUAL "OK" displayed within 6 minutes.*
- c. GPS HERR/VERR - VERIFY WITHIN LIMITS

When clear of overhead obstructions for 6 to 12 minutes -

- *HERR and VERR less than 100 feet (with keyed MAGR).*
- d. INS knob - NAV *(to check unaided drift)*
 - e. Verify HUD airspeed indicates less than 50 kts.
15. MUMI/ID - SELECT/ENTER DATE and FLT
 16. Stores page - Verify proper store inventory and station status.
 17. ZTOD/LTOD - BOX TO ENABLE HUD DISPLAY (if desired)
 18. Weapons/sensors - ON/BIT CHECK (as required)
 19. BIT page - NOTE DEGD/FAIL INDICATIONS
 20. Standby attitude data - CHECK
 - a. ATT switch - STBY
 - *Velocity vector disappears.*
 - *Pitch ladder referenced to the "W" .*
 - *INS ATT caution displayed.*
 - b. Standby attitude reference indicator - ERECT
 - *HUD pitch ladder moves/coincides with the standby attitude reference indicator.*
 - c. ATT switch - AUTO
 21. OBOGS system - CHECK
 - a. OBOGS control switch - ON
 - b. OXY FLOW knob - ON/MASK(S) (both cockpits)
 - *System provides oxygen on demand.*
 - *No excessive backpressure.*
 - c. OBOGS monitor pneumatic BIT plunger - PRESS AND HOLD (do not rotate)
 - *OBOGS DEGD caution displayed within 65 seconds.*

- *Release plunger.*
- *Caution removed within 30 seconds.*

WARNING

Inadvertent rotation of the OBOGS monitor pneumatic BIT plunger while pressed can result in the locking of the plunger in a maintenance position and may result in intermittent OBOGS DEGD cautions and lead to hypoxia. Rotation of the BIT plunger disengages the locking slot allowing the plunger to extend and move freely when pushed.

- d. *OBOGS electronic BIT button - PRESS AND RELEASE*
 - *OBOGS DEGD caution displayed and removed within 15 seconds.*
 - e. *OXY FLOW knob(s) - OFF (both cockpits)*
 - *OBOGS flow stops.*
22. *Engine status/FADEC channel transfer - CHECK*
- a. *ENG format - SELECT ON LDDI*
 - *LEFT and RIGHT engine STATUS is NORM.*
 - b. *FADEC channel transfers - A TO B AND B TO A ON EACH ENGINE*
 - *FADEC channels change with selection.*
 - *No channel line-outs.*
23. *REFUEL DR caution - CHECK*
- *Signal: (refuel cap) twist hand with curled fingers.*
 - *REFUEL DR caution displayed when PC opens door 8R.*
 - *Caution removed when PC closes door 8R.*
 - *PC manually restows scoop.*
 - *Thumbs up from PC checks complete good.*

10.5.7 Taxi Checks.

1. *Canopy - EITHER FULL UP OR FULL DOWN FOR TAXI*
2. *Braking system - CHECK*
 - a. *Normal brakes - CHECK*
 - *Nominal braking performance at taxi speed.*
 - b. *ANTI SKID switch - OFF*
 - *SKID advisory displayed.*
 - *Nominal braking performance at taxi speed.*
 - c. *ANTI SKID switch - ON*
 - *SKID advisory clears.*
 - d. *EMERG BRK handle - PULL TO DETENT (both cockpits - separately for LOTs 21-25, front cockpit only for LOTs 26 and up)*

- *Handle latches securely in detent.*
- *Nominal braking performance at taxi speed.*

e. *EMERG BRK handle - NORM*

3. Nosewheel steering - CHECK IN HIGH MODE L/R
 - *NWS responds appropriately in NWS and NWS HI.*
 - *NWS disengages when paddle switch pressed.*

10.5.8 Shipboard Taxi/Takeoff Checks.

1. Canopy - CHECK CLEAR/CLOSED (canopy caution removed)
2. OXY FLOW knob(s) - ON/MASK(S) ON prior to tiedown removal
3. Checklist page
 - a. FUEL TYPE - VERIFY
 - b. ABLIM OPTION - BOX
4. ABLIM advisory - VERIFY DISPLAYED on appropriate DDI
5. PARK BRK handle - FULLY STOWED
6. T.O. checklist - COMPLETE from Bottom to Top
7. IFF - SQUAWK MODES /CODES as appropriate
8. *Heading checks*
 - *NOTE HSI heading matches BRC within $\pm 3^\circ$.*
 - *STBY magnetic compass within limits of compass card.*

At catapult tension signal -

9. *Engine run-ups - PERFORM (together)*
 - a. *Throttles both engines - IDLE to MIL*
 - b. ENG page - CHECK ENGINES AT MIL
 - N_1 rpm 86 to 98 %
 - N_2 rpm 88 to 100 %
 - EGT 720 to 932° C
 - FF 11,000 pph maximum
 - NOZ POS 0 to 45 % open
 - OIL PRESS 80 to 150 psi
 - THRUST 100 % minimum on CAT officer/deck lighting signal
10. *Afterburners - SELECT*
 - *Both nozzles open correctly.*
 - *Feed tanks remain full during takeoff, climb, and immediately following climb.*

10.5.9 Shorebased Takeoff Checks.

1. Canopy - CHECK CLEAR/CLOSED, canopy caution removed
2. OXY FLOW knob(s) - ON/MASK(S) ON
3. Checklist page
 - a. FUEL TYPE - VERIFY
 - b. T.O. checklist - COMPLETE
4. PARK BRK handle - FULLY STOWED in position and hold
5. IFF - Squawk appropriate modes/codes
6. *Heading sources - CHECK after runway lineup -*
 - *HSI heading within $\pm 3^\circ$ of known runway heading.*
 - *STBY magnetic compass within limits of compass card.*
7. *Engine run-ups - PERFORM (individually)*
 - a. *Throttles affected engines - IDLE to MIL*
 - b. ENG page - CHECK ENGINE AT MIL
 - N_1 rpm 86 to 98 %
 - N_2 rpm 88 to 100 %
 - EGT 720 to 932°C
 - FF 11,000 pph maximum
 - NOZ POS 0 to 45 % open
 - OIL PRESS 80 to 150 psi
 - THRUST 100 % minimum
 - c. Throttles affected engines - MIL to IDLE, pause 1 second, IDLE to MIL
 - Engine responds with normal acceleration characteristics.
 - No stall or stagnation.
 - d. Throttles affected engines - IDLE
 - e. Repeat steps a thru d for opposite engine.

When cleared for takeoff -

8. *Afterburner Takeoff - Perform IAW Chapter 7.*
 - *Both nozzles open correctly.*
 - *Feed tanks remain full during takeoff, climb, and immediately following climb.*

10.5.10 After Takeoff Checks.**When definitely airborne -**

1. LDG GEAR handle - UP
 - *Gear retracts within 7 seconds.*

10.5.11 Medium Altitude Checks (above 10,000 feet).

Altitude blocks are suggested ONLY to provide a logical sequence for the FCF procedures. Deviations from these block altitudes are acceptable unless specified.

1. *Cabin pressurization - CHECK (both cockpits)*

<u>Aircraft Altitude</u>	<u>Cabin Altitude</u>
• <8,000 feet	Aircraft altitude (+0, -3,000 feet)
• 8,000 to 24,500 feet	8,000 feet (± 500 feet)
2. *Fuel transfer - CHECK INTERNAL and EXTERNAL*
3. *RALT - CHECK SET to 5,000 FEET*
4. *COMM - CHECK (both cockpits)*
 - *Comm switches function normally.*
 - *Both radios operative in transmit and receive.*
 - *Preset and manual frequency selection operative.*
5. *Flight control damping - CHECK*
 - a. *Airspeed - Maintain 300 to 350 KCAS*
 - b. *Make small, abrupt pitch, roll, and yaw inputs.*
 - *Aircraft response is appropriate.*
 - *No oscillation tendencies noted.*
6. *Air refueling probe - CHECK*
 - *Airspeed - Maintain below 300 KCAS.*
 - a. *PROBE switch - EXTEND*
 - *Probe extends normally within 6 seconds.*
 - b. *PROBE switch - RETRACT*
 - *Probe retracts normally within 6 seconds.*
 - *No PROBE UNLK caution when retracted.*
 - c. *PROBE switch - EMERG EXTD*
 - *Probe extends normally within 6 seconds.*
 - d. *PROBE switch - RETRACT*
 - *Probe retracts normally within 6 seconds.*
 - *No PROBE UNLK caution when retracted.*
7. *HOOK - CHECK*
 - a. *HOOK handle - DOWN*
 - *HOOK light on while hook in transit.*
 - *HOOK light out when hook fully extended.*
 - b. *HOOK handle - UP*

8. *Fuel dump - CHECK*
 - a. *BINGO - CHECK/SET just below internal fuel level*
 - b. *DUMP switch - ON*
 - *Fuel dumps from both vertical tails.*
 - c. *BINGO - Run above internal fuel level*
 - *DUMP switch returns to OFF automatically.*
 - *Fuel dump stops.*
9. *ATC cruise mode - CHECK*
 - *ATC advisory in HUD when selected.*
 - *Throttles respond correctly.*
 - *ATC holds calibrated airspeed when straight-and-level and during turns, climbs, and descents.*
10. *HUD symbology - CHECK (both cockpits)*

In NAV master mode with WYPT or TCN boxed -

 - *The following indications are present - heading, airspeed, altitude, AOA, Mach number, aircraft g, bank angle scale, velocity vector, flight path/pitch ladder, steering arrow (TCN), and distance to WYPT or TCN.*
 - *WYPT # displayed to right of distance when WYPT boxed.*
 - *Three-letter identifier displayed to right of distance when TCN boxed.*
 - *HUD and MPCD distance agree.*
 - *HUD format available on DDI, MPCD, or UFCD (both cockpits).*
11. *HSI symbology - CHECK on MPCD*
 - a. *HDG/TK set switch - SLEW (both cockpits)*
 - *Heading bug moves in correct direction.*
 - *Digital display and bug setting agree.*
 - b. *CRS set switch - SLEW (both cockpits)*
 - *Steering arrow rotates in correct direction.*
 - *Digital display and steering arrow agree.*
 - c. *TCN bearing and range - CHECK*
 - *Symbol displayed at appropriate position when compared to a waypoint or known landmark.*
 - *Digital display and symbol agree.*
12. *Standby flight instruments - CHECK (both cockpits)*
 - a. *Standby rate of climb indicator*
 - *Indicates ± 100 fpm or less during level 1g flight.*
 - *Pointer movement smooth during climbs/descents.*
 - b. *Standby attitude reference indicator*
 - (1) *Perform a 360° roll right and left.*
 - *No gyro tumble.*

- (2) *Perform a loop.*
- *Gyro indications are smooth thru bullseye.*
- c. *Standby airspeed indicator*
- *Agrees with HUD.*
 - *Pointer movement is smooth during airspeed changes.*
- d. *Standby altimeter*
- *Agrees with HUD (accept -100 to 400 feet of error since value is uncorrected by FCC air data function).*
 - *Pointer and drum movement is smooth and does not hang up during thousand-foot changes.*
13. *INS/GPS operation - CHECK*
- a. *TCN update - PERFORM*
- *Proper update mechanization.*
 - *Reject update.*
- b. *DSG update - PERFORM*
- *Proper update mechanization.*
 - *Reject update.*
- c. *GPS HERR/VERR - CHECK*
- *Less than 100 feet inflight (with keyed MAGR).*
14. *ADF receivers (if installed) - CHECK*
- a. *ADF - BOX on COMM 1 and COMM 2 sub-levels (individually)*
- *Bearing within $\pm 5^\circ$ off the nose.*
 - *Bearing within $\pm 20^\circ$ off the wing tip.*
15. *IFF operation - CHECK*
- *ATC reports valid mode 3 and C.*
- If/when possible -**
- a. *IFF MASTER switch - EMERG*
- *ATC reports valid emergency squawk (7700).*
16. *Radar/HOTAS functionality - CHECK (both cockpits)*
- a. *A/A master mode - CHECK*
- b. *A/G master mode - CHECK*

10.5.12 10,000 Feet Checks.

With an asymmetric FLIR pod on station 5 or 7 -

- *Expect a gradually increasing amount of pod-induced roll-off during the accel to 500 KCAS on the FCS RIG check or to Mach 0.9 to Mach 0.93 on the LEF/HDU stall check.*
- *In this configuration, FCS rigging is considered acceptable if the 300 and 400 KCAS points are passed.*
- *If encountered on the LEF/HDU stall check, this "gradual" roll-off is not indicative of an HDU stall.*

1. *FCS RIG check - 10,000 feet*
Only perform if -
 - *Aircraft symmetrically loaded. (Asymmetric FLIR pod on station 5 or 7 acceptable for 300 and 400 KCAS points only.)*
 - *External/internal wing tank fuel asymmetry less than 300 pounds.*
 - a. *Autopilot mode - Disengage in 1g flight*
 - b. *T/O TRIM button - PUSH (4 seconds minimum)*
 - *Do not re-trim laterally or directionally for duration of check.*
 - c. *Stabilize at each incremental airspeed. Release controls from wings-level and record the direction of roll-off and angle-of-bank (AOB) at the end of 10 seconds.*
 - d. *300 KCAS*
 - e. *400 KCAS*
 - f. *500 KCAS*
 - g. *Mach 0.92*
 - *Perform the Mach 0.92 check only if the AOB was > 30° at 300, 400, or 500 KCAS.*

NOTE

RIG Check fails if any AOB > 30° (> 3° per second); however, for diagnostics purposes, complete all applicable roll-off checks.

2. *LEF/HDU stall check - 10,000 feet*
 - a. *G-warm - PERFORM*
 - *4g for 90°.*
 - *6g for 90°.*
 - *-1g pushover to check for cockpit foreign objects.*
 - b. *FCS page - CHECK*
 - *G-LIM value not Xd out.*
 - *No G LIM 7.5G caution.*
 - c. *Speed - Accelerate to Mach 0.9 to Mach 0.93*
 - d. *Roll to 90° AOB, retard the throttles to IDLE, and smoothly pull to g-limiter.*

At 25° AOA -

- e. *Terminate the maneuver.*
 - *No "abrupt" rolling tendency.*
 - *No FLAP SCHED caution.*
 - *No BLIN code 256 (channel identifies weak HDU).*
3. *HYD system check - 10,000 feet*
 - *May be accomplished in conjunction with the FCS RIG accel and LEF/HDU decel.*

- a. *Stabilize at 350 to 375 KCAS (less than Mach 0.65).*
 - *HYD pressure is 3,000 psi (+300/-400).*
 - b. *Accelerate toward 450 KCAS.*
 - *HYD pressure increases to 5,000 psi (+400/-500) by 420 KCAS.*
 - c. *Decelerate towards 300 KCAS.*
 - *HYD pressure returns to 3,000 psi (+300/-400) by 330 KCAS.*
4. *Emergency landing gear extension - PERFORM (front cockpit)*
- a. *FLAP switch - HALF*
 - b. *Slow below 170 KCAS.*
 - c. *LG circuit breaker - PULL*
 - *Rear cockpit landing gear UNSAFE light on.*
 - d. *LDG GEAR handle - DN*
 - e. *LDG GEAR handle - ROTATE 90° CLOCKWISE then PULL TO DETENT*
 - *LDG GEAR handle stays in detent.*
 - *Gear extends within 30 seconds.*
 - *APU ACCUM caution displayed.*
 - f. *HYD ISOL switch - ORIDE (until APU ACCUM caution removed - approximately 20 seconds)*

With the LDG GEAR handle outboard (DN position) -

- g. *LDG GEAR handle - PUSH IN then ROTATE 90° CCW*

Pause 5 seconds -

- h. *LG circuit breaker - RESET*

5. *(LOTs 21-25) Emergency landing gear extension - PERFORM (rear cockpit)*

In front cockpit -

- a. *LDG GEAR handle - UP*
- b. *FLAP switch - HALF*
- c. *Slow below 170 KCAS.*

In rear cockpit -

- d. *EMERG LDG GEAR handle - PULL TO DETENT*
 - *Gear extends within 30 seconds.*
 - *APU ACCUM caution displayed.*

In front cockpit -

- e. *LDG GEAR handle - DN*
- f. *HYD ISOL switch - ORIDE (until APU ACCUM caution removed - approximately 20 seconds)*

In rear cockpit -

- g. *EMERG LDG GEAR handle - ROTATE 45° CLOCKWISE and PUSH FULL IN*
6. *AOA warning tone - CHECK*

With gear down and flaps HALF -

- a. *Increase AOA toward 15°.*
 - *AOA warning tone comes on at $14 \pm 0.5^\circ$.*
7. *PA throttle transients - 10,000 feet (INDIVIDUALLY)*

With gear down, flaps HALF, and at onspeed AOA -

- a. *Throttle affected engine - IDLE to MAX*
 - *Afterburner lights within 8 seconds.*
 - b. *Throttle affected engine - MAX to IDLE, pause 3 seconds, IDLE to MAX*
 - *Afterburner lights within 8 seconds.*
 - *Engine responds smoothly with no stall, stagnation, or flameout.*
 - c. *Repeat steps a and b for opposite engine.*
8. *LDG GEAR handle - UP*
9. *Wheels warning - CHECK*
- a. *Descend below 7,500 feet MSL.*
 - b. *Reduce airspeed below 175 KCAS.*
 - c. *Establish rate of descent greater than 250 fpm.*
 - *Landing gear warning light flashes.*
 - *Landing gear warning tone sounds.*
10. *FLAP switch - AUTO*

10.5.13 High Altitude (above 30,000 feet).

- 1. *Cabin pressurization - MONITOR*
Above 24,500 feet MSL, cabin pressurization shall remain within 5 psi differential of actual altitude. A rule of thumb is altitude x 0.4.

- | <u>Aircraft Altitude</u> | <u>Cabin Altitude</u> |
|--------------------------|-----------------------|
| • Less than 30,000 feet | 10,000 to 12,000 feet |
| • 40,000 feet | 15,000 to 17,000 feet |

2. *Throttle transients - 35,000 ± 2,000 feet (INDIVIDUALLY)*

- a. *ENG ANTI ICE switch - CHECK OFF*
- b. *Airspeed - Maintain 200 to 220 KCAS*
- c. *Throttle affected engine - IDLE to MAX*
 - *Afterburner lights within 12 seconds.*
- d. *Throttle affected engine - MAX to IDLE, pause 3 seconds, IDLE to MAX*
 - *Afterburner lights within 12 seconds.*
 - *Engine responds smoothly with no stall, stagnation, or flameout.*
- e. *Repeat steps a thru d for opposite engine.*

10.5.14 10,000 Feet to Landing.

1. *Fuel transfer - CHECK (throughout flight)*

With external fuel available -

- *External fuel transfers normally.*
- *Internal tanks fill/stay near full.*

With external tanks empty -

- *Tank 1 depletes to approximately 1,000 pounds prior to wing tanks depleting.*

When wing tanks are empty -

- *Tanks 1 and 4 fall in approximately ¼ ratio.*
- *No FUEL XFER caution.*

With fuel in tanks 1 and 4 -

- *Feed tanks stay at or near full (2,100 to 2,450 pounds).*

2. *RALT operation - CHECK*

During descent through 5,000 feet AGL -

- *Low altitude warning correctly comes on.*
- *Radar altitude tracks correctly during descent.*
- *Verify flashing B changes to a solid R when passing through 5,000 feet AGL.*

3. *TCN or WYPT course intercept - PERFORM*

- *Course deviation indicator in HUD corresponds with steering arrow on MPCD.*

4. *ILS/ACLS operation - CHECK (if available)*

- *Proper ILS and/or ACLS indications.*

10.5.15 Landing Checks.

1. Landing checklist - COMPLETE
2. *ATC approach mode - CHECK*
 - *ATC advisories in HUD when selected.*
 - *Throttles respond correctly.*
 - *Holds onspeed AOA during turns and on approach.*

10.5.16 After Landing Checks.

1. *Anti-skid system - CHECK*

Above 75 KGS on landing -

- a. *Brake pedals - Apply full brake pressure*
 - *Anti-skid cycles smoothly.*
 - *No left or right pulling tendencies.*

When clear of active runway -

2. Ejection seat SAFE/ARMED handle(s) - SAFE (both cockpits)
3. EJECTION MODE handle - NORM (rear cockpit)
4. Landing gear handle mechanical stop - FULLY ENGAGED
5. FLAP switch - AUTO
6. T/O TRIM button - PRESS UNTIL TRIM ADVISORY DISPLAYED
7. Mask(s) - OFF (both cockpits)
8. OXY FLOW knob(s) - OFF (both cockpits)
9. OBOGS control switch - OFF
10. Canopy - EITHER FULL UP OR FULL DOWN FOR TAXI

10.5.17 Before Engine Shutdown Checks.

1. PARK BRK handle - SET
2. BIT display - RECORD DEGD/FAIL INDICATIONS
3. *BIT/HYDRO-MECH page - VERIFY absence of FADEC fault codes*
4. Radar maintenance (BOA) codes - RECORD IF PRESENT
5. RADAR knob - OFF
6. FCS display - RECORD BLIN CODES

7. EFD - RECORD MSP CODES
8. INS - PERFORM POST FLIGHT UPDATE
 - *Maximum error is 1.5 nm per hour of operating time.*
9. INS knob - OFF
10. Standby attitude reference indicator - CAGE (both cockpits)
11. HMD switch - OFF
12. Sensors, avionics, and CVRS - OFF
13. EXT and INTR lights knobs - OFF (both cockpits)
14. Canopy - CHECK CLEAR/OPEN
15. QDC - DISCONNECTED AND STOWED

10.5.18 Engine Shutdown Checks.

1. Brake accumulator gauge - CONFIRM 3,000 PSI
2. Paddle switch - PRESS (disengage NWS)
3. Confirm 5 minute engine cool down.
4. OBOGS control switch - OFF
5. BLEED AIR knob - OFF
6. Throttle - OFF (alternate sides)
7. Verify proper switching valve operation.

After hydraulic pressure decays through 500 psi -

- a. FLAP switch - FULL
- b. If aileron, rudder, or LEF surfaces X and the Xs do not clear after one FCS reset attempt, maintenance action is required.
- c. If one FCS reset attempt was required to reset surfaces Xs, cycle FLAP switch to AUTO then back to FULL. If Xs reappear, maintenance action is required.
8. FCS page - Verify no channel is completely Xd out.
9. COMM 1 and 2 knobs - OFF (both cockpits)
10. L (R) DDI, HUD, and MPCD knobs - OFF (both cockpits)
11. Other throttle - OFF

When amber FLAPS light illuminates -

12. *BATT switch - LEAVE ON*
 - *Battery gauge reads 23 to 24 vdc (nominal).*
 - *Automatic battery cutoff operates at 2 minutes (1 minute on LOT 21 aircraft).*
13. *FCF Profile A - COMPLETE*

10.6 FCF CHECKLIST - PROFILE C

1. Perform engine start, taxi, and takeoff IAW NATOPS.

10.6.1 10,000 Feet Checks.**With an asymmetric FLIR pod on station 5 or 7 -**

- *Expect a gradually increasing amount of pod-induced roll-off during the accel to 500 KCAS on the FCS RIG check or to Mach 0.9 to Mach 0.93 on the LEF/HDU stall check.*
- *In this configuration, FCS rigging is considered acceptable if the 300 and 400 KCAS points are passed.*
- *If encountered on the LEF/HDU stall check, this "gradual" roll-off is not indicative of an HDU stall.*

1. *FCS RIG check - 10,000 feet*
Only perform if -
 - *Aircraft symmetrically loaded. (Asymmetric FLIR pod on station 5 or 7 acceptable for 300 and 400 KCAS points only.)*
 - *External/internal wing tank fuel asymmetry less than 300 pounds.*
 - a. *Autopilot mode - Disengage in 1g flight*
 - b. *T/O TRIM button - PUSH (4 seconds minimum)*
 - *Do not re-trim laterally or directionally for duration of check.*
 - c. *Stabilize at each incremental airspeed. Release controls from wings-level and record the direction of roll-off and angle-of-bank (AOB) at the end of 10 seconds.*
 - d. *300 KCAS*
 - e. *400 KCAS*
 - f. *500 KCAS*
 - g. *Mach 0.92*
 - *Perform the Mach 0.92 check only if the AOB was > 30° at 300, 400, or 500 KCAS.*

NOTE

RIG check fails if any AOB > 30° (> 3° per second); however, for diagnostics purposes, complete all applicable roll-off checks.

2. *LEF/HDU stall check - 10,000 feet*

- a. *G-warm - PERFORM*
 - *4g for 90°.*
 - *6g for 90°.*
 - *-1g pushover to check for cockpit foreign objects.*
- b. *FCS page - CHECK*
 - *G-LIM value not Xd out.*
 - *No G-LIM 7.5G caution.*
- c. *Speed - Accelerate to Mach 0.9 to Mach 0.93*
- d. *Roll to 90° AOB, retard throttles to IDLE, and smoothly pull to g-limiter.*

At 25° AOA -

- e. *Terminate the maneuver.*
 - *No "abrupt" rolling tendency.*
 - *No FLAP SCHED caution.*
 - *No BLIN code 256 (channel identifies weak HDU).*
3. *FCF Profile C - COMPLETE*

10.7 FCF CHECKLIST - PROFILE D (REAR COCKPIT)

1. When a profile D is required solely by the reconfiguration of the rear cockpit, perform engine start, taxi, and takeoff IAW NATOPS.

10.7.1 Preflight Checks.

1. *UFCD adapter - VERIFY NOT INSTALLED*

10.7.2 Before Taxi Checks.

1. *Rudder pedal adjustment - CHECK*
 - *Adjustment smooth through full range of travel.*
 - a. *SET PEDAL POSITION FULL FORWARD*
 - *Cycle left and right pedal to check for binding.*
 - b. *SET PEDAL POSITION AS DESIRED FOR FLIGHT*
 - *Locks securely when RUD PED ADJ lever released.*
2. *Stick and rudder pedals - CYCLE*
 - *No binding through full travel.*
3. *Throttles - Advance to MIL momentarily. Do not allow engine rpm to exceed 80%.*
 - *No binding or sticking through range of travel.*
 - *No engine shutdowns when pulled to IDLE.*

10.7.3 Taxi Checks.

1. *Braking system - CHECK*

- a. *Normal brakes - CHECK*
 - *Nominal braking performance at taxi speed.*
 - b. *EMERG BRK handle - PULL TO DETENT*
 - *Handle latches securely in detent.*
 - *Nominal braking performance at taxi speed.*
 - c. *EMERG BRK handle - NORM*
2. *Nosewheel steering - CHECK IN HIGH MODE L/R*
 - *NWS responds appropriately in NWS and NWS HI.*
 - *NWS disengages when paddle switch pressed.*

10.7.4 Medium Altitude Checks (above 10,000 feet).

1. *Flight control damping - CHECK*
 - a. *Airspeed - Maintain 300 to 350 KCAS*
 - b. *Make small, abrupt pitch, roll, and yaw inputs.*
 - *Aircraft response is appropriate.*
 - *No oscillation tendencies noted.*
2. *Throttles - CYCLE INTO AB*
 - *Nominal engine response to throttle position.*
 - *Afterburners light off normally and cancel when MIL selected.*
3. *COMM switch - CHECK*
 - *Comm switch functions normally.*
 - *Both radios operative in transmit and receive.*
4. *Speedbrakes - CHECK*
 - a. *Speedbrake switch - HOLD AFT*
 - *Speedbrake surfaces extend normally.*
 - *SPD BRK light on when surfaces not fully retracted.*
 - b. *Speedbrake switch - RELEASE*
 - *Speedbrake surfaces retract fully.*

In front cockpit -

- c. *Speedbrake switch - HOLD AFT*
 - *Speedbrake surfaces extend normally.*

In rear cockpit -

- d. *Speedbrake switch - HOLD FWD*
 - *Speedbrake surfaces retract (rear cockpit override).*
- e. *Speedbrake switches - RELEASE*

5. *Radar/HOTAS functionality - CHECK*

a. *A/A master mode - CHECK*

b. *A/G master mode - CHECK*

6. *FCF Profile D COMPLETE*

10.8 FCF CHECKLIST - PROFILE E

1. Perform engine start, taxi, and takeoff IAW NATOPS.

10.8.1 10,000 Feet Checks.

1. *Emergency landing gear extension - PERFORM (front cockpit)*

a. *FLAP switch - HALF*

b. *Slow below 170 KCAS*

c. *LG circuit breaker - PULL*

- *Rear cockpit landing gear UNSAFE light on.*

d. *LDG GEAR handle - DN*

e. *LDG GEAR handle - ROTATE 90° CLOCKWISE then PULL TO DETENT*

- *LDG GEAR handle stays in detent.*
- *Landing gear extends within 30 seconds.*
- *APU ACCUM caution displayed.*

f. *HYD ISOL switch - ORIDE (until APU ACCUM caution removed - approximately 20 seconds)*

With the LDG GEAR handle outboard (DN position) -

g. *LDG GEAR handle - PUSH IN then ROTATE 90° CCW*

Pause 5 seconds -

h. *LG circuit breaker - RESET*

2. *(LOTs 21-25) Emergency landing gear extension - PERFORM (rear cockpit)*
In front cockpit) -

a. *LDG GEAR handle - UP*

b. *FLAP switch - HALF*

c. *Slow below 170 KCAS*

In rear cockpit -

d. *EMERG LDG GEAR handle - PULL TO DETENT*

- *Gear extends within 30 seconds.*

- *APU ACCUM caution displayed.*

In front cockpit -

e. *LDG GEAR handle - DN*

f. *HYD ISOL switch - ORIDE (until APU ACCUM caution removed - approximately 20 seconds)*

In rear cockpit -

g. *EMERG LDG GEAR handle - ROTATE 45° CCW and PUSH FULL IN*

In front cockpit -

3. *LDG GEAR handle - UP*

4. *FCF Profile E - COMPLETE*

PART IV

FLIGHT CHARACTERISTICS

Chapter 11 - Flight Characteristics

CHAPTER 11

Flight Characteristics

11.1 HANDLING QUALITIES.

The F/A-18E/F flight control system (FCS) is designed to present handling qualities that provide virtually carefree maneuvering of the aircraft throughout most of the flight envelope. As such, there are some flight characteristics which are somewhat unique to the F/A-18E/F airplane. A thorough understanding of these flight characteristics along with the details of the flight control system described in Chapter 2 and the operating limitations detailed in Chapter 4, allows the pilot to safely and effectively exploit the full capabilities of the airplane.

11.1.1 Flight Control Mode Effects on Handling Qualities. Handling qualities are dependent on which mode the flight control system is operating. FCS mode is determined primarily by the FLAP switch position: power approach (PA) mode with the FLAP switch in HALF or FULL or up/auto (UA) mode with the FLAP switch in AUTO. However, if airspeed is above approximately 240 KCAS, the flight controls switches to, or remains in, UA mode regardless of FLAP switch position. FCS control laws are also designed to minimize transients when switching flight control modes.

11.1.2 Handling Qualities with Flaps HALF or FULL. The FCS employs full-time AOA and pitch rate feedback with flaps HALF or FULL. Therefore, longitudinal trim is required to maintain constant AOA and/or airspeed. Once trimmed to an AOA, the aircraft tends to remain at that AOA until changed by longitudinal stick or trim. The stick force gradient with AOA is constant up to 12° AOA and does not vary with aircraft gross weight or center of gravity. Above 12° AOA, increased AOA feedback increases stick forces as an artificial stall warning cue. Handling qualities are excellent up to the 14° AOA limit. Maximum AOA at full aft stick with flaps HALF or FULL is approximately 25° AOA. However, due to degraded handling qualities and reduced departure resistance above 15° AOA, particularly with abrupt inputs, flight at greater than 14° AOA with flaps HALF or FULL is prohibited.

The FCS provides good lateral directional control of the aircraft. The rolling surface to rudder interconnect (RSRI) function along with sideslip and sideslip rate feedback are used to coordinate lateral inputs, reducing pilot workload by allowing feet-on-floor maneuvering for most situations.

11.1.2.1 Stalls with Flaps HALF or FULL. The aircraft does not exhibit a classic stall break with flaps HALF or FULL and both configurations are very departure resistant up to the 14° AOA limit for normal two-engine operation, even with symmetric and asymmetric store loadings (see Single Engine Operation). Roll and yaw control remain positive up to the 14° AOA limit in either flap setting but is better above 10° AOA with flaps HALF. With flaps FULL, a distinct longitudinal buffet is felt at or above 11 to 12° AOA which serves as a stall warning cue. This buffet tends to be more pronounced at heavier gross weights and with wing tank loadings but does not adversely affect climb performance or handling qualities. Above the AOA limit, uncontrollable roll-offs are possible in either flap setting, particularly with high lateral weight asymmetry store loadings. An intermittent warning tone will sound beginning at 14° AOA with an increasing beep frequency as AOA increases up to full aft stick.

11.1.2.2 Takeoff and Landing. Low gain nosewheel steering (NWS) incorporates yaw rate feedback to stabilize directional control during the takeoff and landing roll. Maintaining runway position without NWS using differential braking alone may be difficult. Crosswinds have minimal effect on

takeoff characteristics and only a small amount of lateral stick into the wind is required to keep the wings level during the takeoff roll. Nosewheel lift-off speeds are dependent on CG location and aircraft gross weight. At nominal and forward CG locations, the airplane requires aft stick to effect rotation. Premature aft stick application during the takeoff roll can result in early nosewheel lift-off and potential over-rotation, particularly with aft CG.



- Pitch attitudes in excess of 10° during takeoff rotation may result in ground contact between engine exhaust nozzles and/or stabilators.
- With combinations of heavy gross weight, forward CG, high density altitudes and late takeoff rotation, ground speed can exceed the maximum nose gear tire speed of 195 knots ground speed (see NATOPS performance charts).

Additionally, landing gear speed limits can be easily exceeded during shallow climbs after takeoff with MAX power.

With large lateral weight asymmetries, there is a slight tendency to yaw into the heavy wing during the initial ground roll and again during the takeoff rotation. Otherwise, takeoff characteristics are very similar to symmetric store loadings. Directional trim may be required after takeoff for balanced flight with store asymmetries. A small lateral-directional transient may occur during configuration changes from flaps HALF to AUTO or from flaps AUTO to HALF. The lateral transient occurs since TEFs are deflected differentially for lateral control with flaps AUTO and the additional lateral control results in an associated directional transient due to the rolling-surface-to-rudder interconnect.

Normal approach and landing characteristics are excellent; with good speed stability and solid lateral-directional handling qualities. With crosswinds, a wings-level crabbed approach with removal of half the crab angle just prior to touchdown minimizes deviations from runway heading and landing gear side loads during landings. Touchdown in a full crab angle results in an uncomfortable roll opposite the crab angle and upwind drift, requiring large rudder pedal inputs to align the aircraft with the runway. Likewise, removing the crab angle entirely results in downwind drift and directional transients after touchdown. A wing down, top rudder approach results in excessive bank angle and is not recommended.

With flaps HALF or FULL, handling qualities with large lateral weight asymmetries are virtually identical to those with symmetric loadings; however, landing with crosswinds from the heavy wing side results in less roll away from the wind at touchdown. With large lateral asymmetries, the aircraft will fly with the heavy wing forward. Upon landing the aircraft will yaw into the heavy wing as the aircraft straightens to its ground track. Once airborne on a touch and go or bolter, the aircraft will yaw away from the heavy wing as the aircraft trims to a heavy wing forward position. Regardless of wind conditions, the aircraft tends to yaw away from the heavy wing during periods of heavy braking but the yaw is easily countered with a small rudder pedal input.

11.1.3 Flaps AUTO Handling Qualities. The FCS control laws create handling qualities that are slightly different from aircraft with conventional flight control systems. The most apparent characteristics are the neutral speed stability at low AOA and the excellent maneuverability at high AOA.

Neutral speed stability occurs since the FCS automatically attempts to keep the aircraft in 1g, zero pitch rate flight. This has the effect of eliminating the need for frequent longitudinal trim adjustments, lowering pilot workload for most tasks; however, some tasks are made slightly more difficult. For example, during large airspeed changes, the aircraft may initially appear to be slightly out of trim for a few seconds until FCS re-establishes 1g flight. Since pitch trim biases the FCS away from 1g flight, any pitch trim used during large airspeed changes must be removed within a few seconds of establishing the new airspeed and only adds workload. Additionally, during climbs or dives, a small but constant forward stick force is required to maintain a constant pitch attitude and load factor. Again, if pitch trim is used to eliminate these stick forces, additional short trim inputs will be required to re-establish 1g flight, further increasing pilot workload. Another task with a slightly increased workload is the instrument penetration/approach where neutral speed stability may cause difficulty in maintaining a desired airspeed.

The longitudinal handling qualities are excellent with good pitch rate and damping that combine to allow very aggressive maneuvering. FCS control laws modify aircraft response to stick inputs, creating the effect of changing stick forces to provide pilot cueing in maneuvering flight. Actual stick forces for a given stick displacement do not change with flight condition. Full forward and aft stick requires a 20-pound push and 37-pound pull, respectively. At high airspeeds, the FCS is a g-command system requiring 3.5 pounds of stick force per g. At medium airspeeds, the FCS acts as a hybrid pitch rate and g-command system. Pitch rate feedback is used to increase apparent stick force per g as a cue of decaying airspeed and available load factor. At low airspeed, the FCS is primarily an AOA command system using AOA feedback above 22° to provide increasing stick force with increasing AOA. The maximum commanded AOA is approximately 45° to 50° at full aft stick. Combined with the capability to command high AOA is the ability to generate high nose-down pitch rates with large forward stick to rapidly reduce AOA, particularly below approximately 200 KCAS. This nose-down pitch rate capability is further enhanced as airspeed decreases to 150 KCAS. When airspeed is below 150 KCAS and longitudinal stick is pushed far forward (greater than 1.7 inches), up to full stabilator, maximum rudder flare-out, and LEX spoiler are commanded to rapidly get the aircraft nose moving down. This FCS feature was added to enable pilots to rapidly reduce AOA when at low airspeed and high AOA for quick nose repositioning. To maintain departure resistance, the enhanced nose-down pitch rate capability is reduced when lateral stick is deflected more than one inch.

The g-limiter function in the FCS limits commanded load factor under most flight conditions to the symmetric load limit (N_z REF) based on gross weight below 57,400 pounds gross weight. Above 57,400 pounds, N_z REF is held constant at 5.5g even though the allowable load factor may be below N_z REF (refer to G-Limiter). Above 57,400 pounds gross weight, the g-limiter does not provide adequate over-g protection and pilot action may be required to prevent an aircraft overstress.

Very abrupt full aft stick commands with aft CG conditions can beat the g-limiter and cause a positive over-g (811 MSP code). Likewise, very abrupt pushes can result in a negative over-g (925 MSP code). Care should be taken during all abrupt maneuvers. During rolling maneuvers, the g-limiter also reduces commanded load factor to 80% of N_z REF. This feature can also be defeated with abrupt lateral stick inputs at elevated-g. Abrupt full lateral stick inputs at N_z REF may result in an aircraft overstress without setting an 811 or 925 over-g MSP code (see figure 4-7, Acceleration Limits - Basic Aircraft, Note 2).

Another flight characteristic related to g-limiter performance occurs during very high bleed rate turns where even with full aft stick, load factor may be slightly less than N_z REF. This can happen when the aircraft decelerates much faster than the FCS can position the stabilators to maintain N_z REF. Additionally, during elevated-g maneuvering at transonic flight conditions, the g-limiter unloads the

aircraft (and N_z REF) by as much as 1.0 to 1.7g. This feature helps prevent an aircraft overstress that could result from the classic aerodynamic phenomenon known as “transonic pitch-up” experienced during elevated-g decelerations at transonic flight conditions.

At low angles of attack, the aircraft is extremely smooth with little sensation of changing airspeed or Mach. However, at transonic flight conditions, the aircraft may exhibit a mild buffet, which is more pronounced with empty wing pylons or interdiction loadings but is almost nonexistent with clean wings. Buffet begins at approximately 0.88M, subsides by 0.95M, and presents a sensation much like riding on a “gravel road”. Airframe buffet is also noticeable in the cockpit while maneuvering at tactical speeds between approximately 6° and 11° AOA. At low altitudes, this AOA range begins at approximately 6g but at high altitude begins at 2g to 3g. Above this AOA range, the buffet sensation at the cockpit subsides slightly but is still apparent in the airframe. Although this buffet at elevated-g is present in all configurations, it is most apparent with empty wing pylons at transonic flight conditions. Additionally, persistent but bounded wing rock or roll-off may occur at some flight conditions if the maneuvers linger in the 8 to 13° AOA range. Gun tracking is still good in the presence of buffet but workload is slightly increased. Formation flight in the buffet AOA region also exhibits a slightly higher workload.

The speedbrake function provides very good deceleration capability at subsonic flight conditions. Deploying the speedbrake function results in a small nose-up transient; a small nose-down transient during retraction. These transients still allow the speedbrake function to be used comfortably during formation flight. With speedbrake function fully deployed, the aircraft may feel sloppy in the yaw axis during large rudder pedal inputs due to one rudder stalling. With lateral weight asymmetries, a small sideforce may also be apparent when deploying the speedbrake function. At most supersonic flight conditions up to Mach 1.5, the spoilers are the only active speedbrake surface due to limited effectiveness of the other surfaces. Deceleration capability is still adequate with throttles at IDLE; with one exception. When less than MIL thrust is selected above Mach 1.23, the engine fan speed lockup feature (to prevent engine inlet instability) maintains MIL thrust levels, which has the side effect of limiting deceleration capability until fan speed lockup deactivates at Mach 1.18.

Lateral-directional handling qualities are also excellent, particularly at high AOA. Roll rates and roll damping combine to provide very agile roll control. The FCS attempts to maintain consistent roll response throughout the 1g flight envelope. Additionally, rolling surface to rudder interconnects coordinate lateral inputs, reducing pilot workload by allowing feet on the floor maneuvering under most circumstances. Maximum roll rates are in the 200 to 225°/second range with clean wings and approximately 130 to 150°/second with wing tanks and/or air-to-ground stores. Flight tests with wing tank loadings demonstrated a very localized drop in maximum roll rate of approximately 50°/second at Mach 0.92 to Mach 0.93, most notably at 20,000 feet. The FCS reduces maximum roll rate by 40 to 60°/second at high subsonic airspeeds and low altitudes (approximately Mach 0.90 below 10,000 ft), due to structural load concerns. For additional structural loads concerns during negative-g rolls, maximum roll rate capability is reduced to approximately 60 to 80°/second above approximately 550 KCAS.

The most obvious lateral-directional characteristic is the excellent maneuverability at high AOA as a direct result of specific FCS high AOA control laws. At 25° AOA and above, rudder pedal deflections no longer provide yaw control inputs but instead act entirely as a roll control (identical to lateral stick input) by commanding aileron and differential stabilator with the RSRI commanding the required rudder deflection for roll coordination. Rudder pedal inputs are summed with lateral stick inputs and this combined input is limited to a value equal to a full lateral stick input. Therefore, applying pedal opposite to lateral stick cancels lateral stick inputs proportional to the pedal input, i.e., full opposite

pedal cancels a full lateral stick command resulting in zero roll rate. Between 13° and 25° AOA, rudder pedal deflections gradually change from pure yaw controllers to pure roll controllers. This method of control provides enhanced departure resistance at high AOA.

Some traditional yaw control with rudder pedal is returned at low airspeed and high AOA only when the pilot applies lateral stick and rudder in the same direction. This feature is effective only at airspeeds below 225 KCAS and between 25° and 40° AOA. During flight tests, the most effective pirouette initiation was found at approximately 200 KCAS and 35° AOA (18E-006 and subsequent). Enabling this feature outside of these conditions would compromise departure resistance. When this feature is enabled, the sum of lateral stick and rudder pedal command is no longer limited to a value equal to a full lateral stick input. The excess roll command is fed to the directional axis to command sideslip. For example, adding full rudder pedal with a full lateral stick input provides a maximum roll and yaw command. Alternatively, adding lateral stick to an existing full rudder pedal input has the same effect. The resulting aircraft motion is a highly controllable nose-high to nose-low reversal.

Small lateral trim variances may occur without significant changes in airspeed, AOA, or Mach number. These variances result from small changes in internal or external wing tank fuel asymmetry and may require more frequent lateral trim inputs. Lateral trim changes may also be required as flight conditions change with asymmetric store loadings or if one or more flight control surfaces are slightly out of rig. Additionally, small sideslip excursions (1 to 3°) are common during steep climbs and descents, even with symmetric store loadings. These excursions are non-oscillatory in nature and are controllable with minimal rudder pedal inputs.

In general, flying qualities are also very good with large lateral weight asymmetries. The aircraft tends to roll toward the heavy wing at elevated g such as during a pull off target during an air-to-ground attack; away from the heavy wing at negative g. In each case, the roll is easily countered with lateral stick. Additionally, roll coordination may be slightly degraded with large lateral stick inputs and may require rudder pedal to maintain balanced flight. At high AOA, the aircraft tends to yaw away from the heavy wing. Yaw-off should be expected above 25° AOA. Opposite rudder pedal may be required to maintain controlled flight.

11.1.4 FLIR Carriage Handling Qualities. Flight characteristics with a single ATFLIR or TFLIR pod produce roll-off in the direction of the pod of up to 12°/second at transonic (Mach 0.90 to Mach 1.05) Mach numbers. Above Mach 1.05, the roll-off becomes less and eventually reverses direction above Mach 1.15. Above Mach 0.90, sizable lateral and directional trim settings are required when changing Mach number, when greater than Mach 0.90, to reduce roll-off and large side forces. Additionally, lateral inputs are required under elevated load factor in order to maintain the same roll attitude. This roll-off phenomenon is dominated by the aerodynamic asymmetry, not the lateral weight asymmetry.

Carriage of the following reduces or eliminates the roll-off tendency. During flight test, empty inboard SUU-79 pylons reduced the aerodynamic asymmetry by 50%. Carriage of symmetric pods (ATFLIR or TFLIR on station 5 and NAVFLIR on station 7) effectively canceled the aerodynamic asymmetry. A 480-gallon external fuel tank on the centerline also reduced the aerodynamic asymmetry to nearly zero. The influence of an ARS was not flight tested but is expected to reduce the roll-off tendency. Empty SUU-79 pylons on the midboard stations displayed a slight improvement. An AIM-120 on the opposite fuselage station was ineffective in reducing the roll-off.

The magnitude of the roll-off at peak conditions (Mach 0.95) can be trimmed out, however, slight variations in Mach require large variations in both lateral and directional trim settings to maintain balanced flight. This additional pilot workload should be considered during low altitude flight where mission crosscheck time is critical.

During flight simulation, level bomb deliveries (using the ATFLIR for target identification and refinement) were flown in a simulated night environment with no outside visual reference. Uncommanded roll-off appeared as a rotating FLIR image similar to what is displayed during over flight of the designated target. It is possible that uncommanded aircraft bank angle changes, seen as a rotating FLIR image through the sensor, may be confused with the rotating image that results from target over flight.

WARNING

Uncommanded roll-off during heads down sensor operation may result in an unusual aircraft attitude, disorientation, altitude loss, and possible CFIT.

11.1.5 5-Wet (4-EFT and ARS) Loading Handling Qualities. The 5-Wet tanker loading handling characteristics are unique given the very high aircraft gross weight and considerable aerodynamic influence (in particular, drag) of the external stores.

Ground handling qualities are excellent although higher throttle settings can be expected to initiate aircraft movement. Additionally, heavy gross weights require noticeable long braking distances even during routine taxi evolutions.

Throughout most of the 5-Wet envelope, aircraft handling characteristics are excellent. The heavy gross weight and aerodynamic influence of the external fuel tanks result in a more sluggish aircraft response to control inputs in all axes. This characteristic is the most noticeable during in-flight refueling as a receiver. Control inputs during receiver tanking should be small and deliberate. High frequency, "last ditch" inputs should be avoided. Larger throttle inputs are required to initiate aircraft closure; however, the heavier aircraft weight requires considerable power reductions to arrest closure rates. In-flight tanking engagements should target 2-3 KCAS closure (see NATOPS Flight Manual Performance Data, A1-F18EA-NFM-200, Chapter 7, In-flight Refueling). As fuel is received, the change in gross weight may be dramatic. The 5-wet loading has the largest fuel fraction (ratio of fuel weight to total weight) of all loadings. As the total aircraft weight increases, the power required for level flight will increase. When operating at high gross weights (>64,000 lb) and slow 1 g flight conditions (<200 KCAS), AOA approaches the 15° limit. In this flight regime, the aircraft response may be more sluggish, but still safe. Taking into account the human factors associated with the refueling task and ARS operations (e.g. increased head-in-cockpit demands), difficulty of flying near the AOA limit is compounded. Pay particular attention to the task in this flight regime. Small momentary excursions above the AOA limit (15°) will not cause departure from controlled flight.

11.1.5.1 5-Wet Loading with 5-Wet FCC Gains not Set. Flying the aircraft with fuel tanks on the midboard stations causes the mission computer to request that the flight control system use 5-Wet control law gains to optimize flying qualities. The logic for this determination is absent from H1E-031U/032U MC OFP and therefore causes the aircraft to always fly without the 5-Wet control laws even if there are tanks on the midboard stations. For this case, where midboard tanks are installed and H1E-031U/032U is installed, there may be some looseness in the flaps AUTO longitudinal flying qualities at certain localized flight conditions, but this is not considered to be a safety of flight issue and will not interfere with in-flight refueling operations. There are no NATOPs restrictions for this loading/gain set "mismatch" condition. The degradation, if any, may become apparent for CGs aft of approximately 30% MAC. Flaps AUTO lateral/directional and all flaps HALF or FULL flying qualities are unaffected by this issue.

The H2E–MC OFPs have incorporated an FCCGN advisory that is annunciated when the 5-Wet loading information is declared invalid. The advisory is designed to notify the pilot that 5-Wet FCC control law gains are no longer being applied. The consequence of the gains changing while still in the 5-Wet loading is identical to the H1E software build discussion above. That is, there may be some longitudinal looseness while in AUTO flaps, but this will only be noticeable for aft CGs. Within the NATOPS approved 5-Wet loading airspeed envelope (430 KCAS/0.8M), the degradation in flying qualities stemming from the mismatched gain set is not considered to be a safety of flight issue.

11.1.6 Dual Midboard with Outboard Stores Handling Qualities.

NOTE

Loadings with dual carriage stores on stations 3 or 9 and an adjacent store on stations 2 or 10 may experience uncommanded pitch transients of $\pm 1/2g$ to $\pm 1g$, roll transients of up to $20^\circ/\text{second}$, and/or slight PIO at Mach 0.88–0.95 and less than 4° AOA. Roll-offs are more likely during negative-g maneuvers. Transient severity may worsen at lower altitude. Transients may increase pilot workload.

11.2 AIR COMBAT MANEUVERING.

11.2.1 Air-to-Air Gun Tracking. The flight characteristics described above combine to provide a very agile fighter throughout the flight envelope. Excellent pitch pointing capabilities and lift vector placement allow rapid acquisition and excellent fine tracking of air-to-air targets with little fear of departure from controlled flight, especially at high AOA. However, the high airspeed bleed rate associated with continued maneuvering at high AOA requires additional pilot attention to energy management. Also, the presence of airframe buffet at elevated-g and high subsonic Mach numbers may induce small pitch and roll transients and require increased workload to maintain precise pipper placement.

11.2.2 Over-the-Top Maneuvering. The aircraft exhibits excellent slow speed over-the-top maneuverability. Aft stick is required near the top of looping maneuvers to keep the nose tracking until the nose is below the horizon and airspeed is increasing. If aft stick is not maintained, AOA feedback results in nose-down stabilator which eventually reduces AOA below 22° . Once below 22° AOA, neutral longitudinal stick results in an inverted, nose-high attitude with only a small amount of pitch rate as the FCS attempts to maintain 1g. If airspeed is allowed to decay in this attitude, or is insufficient to complete the maneuver, a tailslide may result (see Departure Characteristics).

11.2.3 Slow Speed Maneuvering. The excellent controllability and maneuverability at high AOA provided by FCS control laws result in very precise nose pointing and gun tracking at extremely low airspeeds. When large and abrupt heading reversals are required during offensive or defensive maneuvering at high AOA and low airspeed, two features discussed earlier allow the pilot to accelerate aircraft motion without compromising departure resistance. The first is the enhanced nose-down pitch rate capability below 200 KCAS which allows very rapid nose-down pitch pointing to acquire the target at the end of a flat scissors engagement or to rapidly reduce AOA to maximize energy addition. The second is the "pirouette" turning capability at high AOA and low airspeed which allows very rapid and controllable nose-high to nose-low heading reversals. These two features combine to significantly enhance maneuverability at high AOA, allowing the pilot to quickly bring the nose to bear on air-to-air opponents.

11.3 OUT-OF-CONTROL FLIGHT (OCF)

11.3.1 Departure Resistance. A departure is defined by aircraft motion that is contrary to flight control inputs. Flight test has shown the F/A-18E/F is very resistant to departure from controlled flight with symmetric loadings. No departure tendencies were found for single-axis control inputs and for the majority of multi-axis inputs. A few departure tendencies exist with multi-axis inputs, but these were usually found to occur beyond the 360° bank angle change limitation (two exceptions are described in 11.3.2.1). Nose high, slow speed maneuvers that result in insufficient maneuvering airspeed or a tailslide will cause a departure. Overall, the aircraft is very departure resistant when flown within NATOPS limits. Additionally, clean and multiple store loadings (including aft CG), have shown no self-sustaining falling leaf mode in the F/A-18E/F. For all known departure modes, following NATOPS out-of-control (OCF) recovery procedures result in rapid recovery.

11.3.2 Departure Characteristics. The typical F/A-18E/F departure occurs as a yaw divergence (nose-slice) followed by an uncommanded roll in the same direction. Usually, a departure is preceded by a buildup in sideforce. This sideforce is often accompanied by "vortex rumble" generated from excessive sideslip. "Vortex rumble" may not be noticeable during aggressive maneuvering; therefore, excessive sideforce provides the most reliable departure warning cue. The initial phase of the departure is not particularly violent or disorienting unless it occurs at high airspeed or Mach number. The yaw rate warning tone may not provide sufficient departure warning. Post-departure gyrations self-recover with controls released. Application of controls during post-departure gyrations may delay recovery.

11.3.2.1 Maneuvering within NATOPS Limits. There are three typical departure cases found for flight within NATOPS limits.

1. **Forward corner inputs below 300 KCAS.**

Lateral stick and/or pedal combined with forward inputs at low airspeed may cause a departure prior to reaching 360° bank angle change limit if AOA transitions from positive to zero or negative during the roll. The departure is characterized by a dwell at 0 g, followed by a sideslip build-up and subsequent moderate yaw rate spike (40 to 50 °/sec) and AOA increase. Subtle differences in roll rate and nose-down pitch rates being generated by such inputs make it difficult to predict whether a departure or favorable (faster than normal) roll rates will occur.



Lateral stick and/or pedal combined with forward inputs at low airspeed may cause a departure.

2. **Lateral stick with pedal and forward stick at high altitude and supersonic speeds.** This input is predicted to cause a departure that could result in aircraft damage. This departure is possible at supersonic airspeed above 40,000 ft MSL and within 360° of bank angle change.

3. **Tailslices and over-the-top maneuvering with insufficient airspeed.**

NATOPS prohibits zero airspeed tailslices and intentional departures or spins. The obvious consequence of over-the-top maneuvering with insufficient airspeed is departure from controlled flight. In general, tailslices that are purely vertical induce departures that are benign and quick to recover. Tailslices with large yaw angle (nose vertical but 3 to 9 line off the horizon) or over-the-top maneuvering with sizable bank angle and insufficient airspeed usually result in a "sideslide" type motion. The resulting sideslide departure motion is similar to vertical but typically is accompanied by an abrupt roll snap before the aircraft settles nose low. If the sideslide motion yields excessive

gravity-induced sideslip at relatively slow airspeed (<90 KCAS), the resulting yawing motion from the growing aerodynamic forces can quickly develop into a spin. If the aircraft falls inverted, then the AOA will simultaneously build negative and may result in an inverted spin. Inverted spins from sideslides are slower to recover than upright sideslide recoveries.

11.3.2.2 Maneuvering Outside of NATOPS Limits.

NOTE

The following describe the known departure characteristics of the aircraft if flown outside of the NATOPS limits.

11.3.2.2.1 Exceeding 360° Roll Limit. Certain airspeed and control input combinations held for greater than the NATOPS bank angle change limit of 360° can lead to departures. Lateral stick with pedal and forward stick from high g near 300 KCAS may result in a severe departure, with yaw rates reaching above 100°/sec a possibility. Another severe departure is possible when slowly pulling aft stick (less than 1 inch/sec) while rolling with a full lateral stick input below 210 KCAS, if initiated near 1g. This departure can generate yaw rates briefly in excess of 120°/sec and negative g spikes from -2 to -3 g. Each of these departures was found only to occur when controls were held beyond the 360° bank angle change limit.

11.3.2.2.2 Exceeding Asymmetric Loading AOA Limits. Exceeding NATOPS limits for asymmetric store loadings can also lead to departures. Aggressive longitudinal maneuvers that result in AOA beyond NATOPS limits can lead to a benign departure that begins as a slow roll toward the heavy wing and yaw away from the heavy wing that cannot be controlled with lateral stick or rudder pedal. Recovery is immediate as soon as AOA is reduced to within limits. Large sideslips create a greater risk of a more violent departure. At higher speeds, aggressive maneuvering at elevated-g above AOA limits can result in sudden departures with little or no warning. If limits are exceeded and a departure does occur, post departure gyrations rapidly transition to an upright spin away from the heavy wing. Recovery from this type of departure has been demonstrated with up to a 24,000 ft-lb lateral weight asymmetry following NATOPS OCF recovery procedures (see Spin Characteristics).

11.3.2.3 Maneuvering with Flight Control System Failures. Continued maneuvering with flight control system failures such as surfaces failed off (X's in all channels of that actuator), air data, or other sensor failures can also lead to departure. The flight control system is designed to provide adequate flying qualities with actuator and other FCS failures as long as AOA and load factor are maintained within NATOPS limits. In the event of FCS failures, reducing AOA and load factor to wings level 1g flight as soon as possible minimizes the possibility of a departure. If a departure does occur, following OCF procedures results in the most rapid recovery.

11.3.3 Spin Characteristics. Entry into a spin is rare for symmetrically loaded F/A-18E/F. On a few occasions, moderate yaw rate spins have developed from departures experiencing large gravity-induced sideslip excursions (e.g. sideslips or nose-high slow airspeed flight while banked near 90°). If AOA is simultaneously negative, the spin will be inverted.

For high lateral weight asymmetry loadings, the aircraft is extremely departure resistant within NATOPS AOA limits. Exceeding AOA limits for high lateral weight asymmetries will most likely result in an upright spin away from the heavy wing. Spin recoveries for less common upright spins into the heavy wing, and inverted spins, can be delayed due to the oscillatory nature of the spin. Spin recovery has been extensively proven for lateral asymmetries up to 14,000 ft-lb for both spins into and away from the heavy wing with positive recoveries demonstrated in all cases.

Spin characteristics and recovery with asymmetries greater than 14,000 ft-lb have not been fully tested. A departure with 24,000 ft-lb of asymmetry resulted in a high yaw rate spin (greater than 100°/sec) within 3 to 5 seconds. Recovery occurred within two to three turns and about 10,000 feet of altitude loss after applying NATOPS OCF recovery procedures. High yaw rate spins typically result in longitudinal accelerations at the pilot seat as high as -3.5g (eyeballs out). Consequently, accomplishing spin recovery procedures can be difficult with an unlocked seat harness.

Spin recovery is straightforward and reliable if the OCF procedures are followed and sufficient altitude remains. If a spin is encountered (Spin recovery display on the DDI), recovery occurs very shortly after initiating NATOPS OCF recovery procedures, particularly from inverted spins. Recovery from spins with high lateral weight asymmetry may require an additional turn or two.

WARNING

Selection of manual spin recovery mode (SPIN switch in RCVY) seriously degrades controllability, prevents recovery from any departure or spin, and is prohibited.

NOTE

During highly oscillatory spins or spins that transform from upright to inverted or from inverted to upright, the spin recovery display may disappear momentarily.

11.4 DEGRADED MODE HANDLING QUALITIES.

The reliability of the FCS is very high and when failures do occur, usually occur singly. No single electrical failure affects flying qualities and multiple FCS failures are required to degrade flying qualities. Depending on which combination of failures has occurred, flying qualities may be considerably degraded. Degraded flying qualities associated with some of the more serious or more common FCS failures are described here. Appropriate corrective action is presented in the Warning/Caution/Advisory Displays, figure 12-1.

11.4.1 Single Engine Operation.

11.4.1.1 Flaps AUTO. Engine failure or shutdown with flaps AUTO results in no degradation in handling qualities under most circumstances at low AOA. A small amount of yaw trim may be required to counter asymmetric thrust effects. At high AOA, engine failure results in a yaw toward the failed engine that is controllable by quickly reducing AOA and countering the yaw with rudder. During hard maneuvering, a slight degradation in handling qualities may be noticeable at less than Mach 1.0 between approximately 400 to 500 KCAS where the hydraulic system normally operates at 5,000 psi. At these conditions 5,000 psi operation is inhibited by the FCS to maintain a windmill air-start capability. When 5,000 psi operation is inhibited, flying qualities may be degraded during aggressive maneuvers since there may not be enough hydraulic power to fully deflect numerous flight control surfaces. A reduction in departure resistance can also be expected anytime normal 5,000 psi hydraulic system operation is inhibited.

11.4.1.2 Flaps HALF or FULL. Single engine minimum control speed (V_{mc}) is defined as the minimum airspeed required to maintain controlled flight with one engine operating. V_{mc} airspeeds were determined at 14° AOA for catapult launches, and 12° AOA for all other circumstances. V_{mc} airspeed varies depending on AOA, lateral asymmetry, altitude, and day temperature. For an engine

failure off the catapult, 14° AOA provides the best compromise between arresting rate of descent off the bow and controllability (increased AOA helps arrest sink but also reduces lateral-directional controllability). In all cases, once control is established (and sink is stopped), allow the aircraft to accelerate to on-speed to provide the best flyaway handling qualities. When an engine fails in flaps HALF or FULL, the first perceptible aircraft motion is a yaw toward the failed engine. The rudders are the primary flight control surface used to counter the yaw caused by the operating engine. Using too much rudder pedal is not harmful, but using too little rudder pedal may not counter the yaw and cause controllability problems. In addition to yawing into the failed engine, the aircraft also tends to roll into the failed engine. The natural pilot reaction is to oppose the roll with lateral stick, but the resulting differential aileron deflection generates adverse yaw and increases the demand on the rudders to maintain directional control. As AOA increases above 10° AOA, the aircraft becomes less directionally stable and rudder control effectiveness deteriorates. In this instance, the rudders may become saturated (surfaces against the stops). When saturated, the rudders cannot counter any additional adverse yaw, resulting in an increase in sideslip and the potential for an adverse yaw departure. If airspeed is too slow, the rudders cannot generate enough control power to oppose the yaw toward the failed engine.

For some situations, controllability alone will not guarantee flyaway (e.g., excessive rate of descent), but may only ensure controllability for a long enough period of time to complete the requisite immediate action procedures and make a timely ejection decision, if warranted.

WARNING

When single engine with the operating engine at MAX, the possibility of an adverse yaw departure increases as AOA exceeds on-speed.

NOTE

- In straight and level flight, a small amount of lateral and/or directional trim is required to maintain balanced flight.
- Loss of either HYD 1 or HYD 2 due to engine failure or hydraulic pump failure does not effect flight control with flaps AUTO; however, failure of either HYD 1 or HYD 2 with flaps in HALF or FULL may cause uncommanded but controllable yaw and roll transients as the switching valves cycle. These yaw and roll transients may last 3 to 6 seconds.
- To prevent repeated switching valve cycling, avoid stabilized flight where engine windmill rpm results in hydraulic pressure fluctuations between 800 and 2,000 psi.

11.4.1.3 Single Engine Waveoff. Refer to Chapter 16, paragraphs 16.1 and 16.3.

11.4.2 Leading Edge Flap Asymmetry. Leading edge flap asymmetries can occur when one of the LEF hydraulic drive units (HDU) stalls/fails or the mechanical interconnect between the inboard and outboard LEF surfaces fails. The most common LEF asymmetry results from a weak LEF HDU that stalls (stops moving due to aerodynamic loading) during abrupt longitudinal maneuvers at high airspeed and low altitude. When this happens, a roll-off away from the failing HDU as AOA or g is increased followed by an abrupt roll-off in the opposite direction is typical. Failure detection logic in

the FCS software is designed to provide advanced warning of a LEF asymmetry; however, during extremely abrupt maneuvers, an HDU stall may not be detected in time to allow the pilot to abandon the maneuver and avoid a large roll transient. The FCS software uses two specific monitors to detect weak LEF HDUs. The first monitor results in a FLAP SCHED caution accompanied with BLIN 256. It sets and holds the FLAP SCHED caution for 6 seconds following the HDU stall. The second monitor results in a FLAP SCHED caution accompanied by a BLIN 537. When accompanied by a BLIN 537, the FLAP SCHED caution is displayed only as long as the failing HDU condition exists (e.g., when $AOA > 12^\circ$).

Avoid high-g maneuvers at low altitude if an HDU stall has been detected during the flight (BLIN 256 or 537 on the FCS status page) even if the FLAP SCHED caution has cleared. BLINs 256 and 537 indicate a weak/failing HDU that may result in very large roll transients and/or over-g during high-g maneuvers.

11.4.2.1 LEF Failure Landing Handling Qualities (Symmetric or Asymmetric). With a LEF failure, the LEF symmetric commands are frozen when the FLAP switch is set to AUTO; however, differential LEF and TEF continue to be commanded. With the FLAP switch set to HALF or FULL, the LEF commands are frozen while the TEF and aileron droop commands follow the normal schedules for PA. Shore and ship based flight tests were conducted with LEF frozen at both symmetric and asymmetric (up to $34^\circ/5^\circ$ LEF split) deflections. Straight in, on-speed approaches in flaps HALF are recommended for all frozen symmetric or asymmetric LEF configurations. General flying qualities, as well as waveoff and T&G performance are acceptable for all LEF configurations.

Light to moderate buffet is present in most of the LEF configurations, especially for AOA greater than on-speed. The buffet is more pronounced with LEF deflections significantly less than the normal scheduled positions. Selecting flaps FULL with small LEF deflections results in higher buffet levels at lower AOAs than with the FLAP switch set to HALF. Noticeable buffet is normal near on-speed conditions with either HALF or FULL flaps for the degraded LEF condition, but may be uncomfortable during maneuvering. Maintaining on-speed or slightly fast approach AOA (to minimize buffet) results in the best flying qualities for any off-schedule symmetric or asymmetric (left/right) LEF configuration. Where practical, flying slightly fast ($6-7^\circ$ AOA) minimizes exposure to the buffet. For carrier landings, the tendency to fly the approach in a "fast" condition should be avoided because the recovery WOD requirements are based on the on-speed approach airspeed. Flying a "fast" approach may result in aircraft and/or arresting gear overstress upon arrestment.

Small ($1-3^\circ$) roll-off due to buffet can be expected but is easily controllable with small lateral inputs. Roll and line up control are not significantly different than normal scheduled positions. The aircraft rolls faster into the lesser-deflected LEF and slower when rolling away from the lesser-deflected LEF. Roll-off may also be experienced with AOA/pitch attitude changes. As AOA decreases, the aircraft rolls away from the lesser-deflected LEF and as AOA increases, the aircraft rolls into the lesser-deflected LEF. Lateral stick and/or trim easily counters this roll-off tendency. A small roll off will occur with airspeed changes during a waveoff or bolter but are easily controlled with small lateral stick inputs.

Glideslope control degradations are more pronounced with LEF deflections significantly less than the normal scheduled positions. The addition of wing stores will further degrade glideslope control. The aircraft response to power corrections is sluggish and smaller in magnitude than normal flap configurations. Therefore, compared to normal flap configurations, larger, longer and more anticipatory power corrections are required to effect a glideslope change. Power corrections translate to an airspeed change first before a rate of descent change is noticed. The delay in aircraft response coupled with the larger throttle inputs leads to the tendency to over-control the glideslope. The technique of applying power and waiting for a glideslope change will lead to larger glideslope deviations.

Anticipatory throttle inputs are key to controlling glideslope. The sluggish power response also degrades waveoff performance slightly. When operating shipboard, the waveoff window for all LEF failure conditions should be moved farther out and the LSOs should be made aware of the degraded glideslope performance. Upon bolter/waveoff, climb-out attitude will appear flatter than normal. The LSOs and PRIFLY personnel should monitor rate of climb as the primary indication of bolter/waveoff performance. It is recommended aircrew perform a familiarization check of aircraft response to control and throttle inputs, including a waveoff maneuver, prior to attempting a shipboard landing.

11.4.3 Trailing Edge Flap Failure. TEF failures may be caused by an actuator failure (mechanical or three-four channel failure) or by a dual HYD 1A/2B circuit failure. TEF actuators continue to operate following two channel failures. If a TEF actuator is shutdown, the surface is hydraulically or aerodynamically driven to 5° TED and locked. If the left to right TEF asymmetry exceeds 6°, the opposite TEF fails off and is also driven to 5° TED and locked.

11.4.3.1 TEF Failure Landing Handling Qualities. Shore and ship based flight tests have been conducted with the TEF in the failed position of 5° TED. Straight in, 10° AOA approaches in flaps HALF or FULL are recommended for TEF failures. Pitch, roll, and line up control are similar to those for normal approaches. Approach speeds will be high and every attempt should be made to reduce gross weight. If shore based, consideration should be given to making an arrested landing taking into account maximum arresting gear engagement speed and nose tire limit.

With this failure, approach drag is reduced and approach power settings are less than normal. This results in slower engine response to throttle changes compared to normal HALF or FULL flap approaches. Flying a slightly slow approach (10° AOA) reduces approach speed and increases approach power setting slightly. Flying qualities at 10° AOA are similar or improved over those observed at on-speed AOA. The aircraft easily trims to and maintains 10° AOA. Glideslope maintenance will dominate the approach task and the tendency is to relax AOA maintenance. The 10° AOA approach reduces WOD requirements by approximately 12 to 16 KCAS and improves approach flying qualities. When operating at the ship, the recovery WOD should be kept as close as possible to the Aircraft Recovery Bulletin recommendations. Due to the large difference between WOD requirements at on-speed and 10° AOA, it is imperative that AOA be maintained at 10°. The sight picture behind the ship is altered, but the field of view over the nose is not degraded.

WARNING

Slower engine response to throttle changes may result in excessive sink rates under high WOD conditions. The recovery WOD should be kept as close as possible to the Aircraft Recovery Bulletin recommendations.

The aircraft response to power corrections is sluggish and smaller in magnitude than for normal TEF configurations. TEF failures require larger, longer, and more anticipatory power corrections to effect a glideslope change. There is a tendency to over control the power due to the low approach power setting and the longer time to effect a change. Power corrections translate to an airspeed change first before a rate of descent change is noticed. Aggressive, well-timed, and anticipatory throttle inputs are required for glideslope control. The technique of applying power and waiting for a glideslope change will lead to larger glideslope deviations. Waveoff performance is degraded for TEF failure approaches. The waveoff technique is the same as normal flap configurations; apply power, maintain AOA until positive rate of climb is achieved, and capture 10° pitch attitude for the climb-out. Time to achieve positive rate of climb is slower than for normal TEF configurations. At the ship, the waveoff window for a TEF failure condition should be moved farther out. The LSOs should be aware of degraded

waveoff and glideslope performance. Upon bolter/waveoff, climb-out attitude will appear flatter than normal. The LSOs and PRIFLY personnel should monitor rate of climb as the primary indication of bolter/waveoff performance. It is recommended aircrew perform a familiarization check of aircraft response to control and throttle inputs, including a waveoff maneuver, prior to attempting a shipboard landing.

11.4.4 Stabilator Failure. Since there is no mechanical reversion mode of the flight controls, the FCS control laws automatically reconfigure in each axis to allow continued flight in the event of a single stabilator failure. This failure mode, known as stabilator reconfiguration, or STAB RECON, is designed to compensate for the loss of the contribution of the failed stabilator to pitch and roll control. This is accomplished by disabling differential stabilator commands and using the other rolling surfaces to counter the roll and yaw moments produced when the remaining stabilator responds to pitch axis commands. Flight tests demonstrated excellent handling qualities with a stabilator failed off during maneuvering flight and aerial refueling. The pitch axis is slightly sluggish, maximum roll rate is noticeably lower, and roll coordination is slightly degraded.

WARNING

In UA, with a failed stabilator, maximum roll rate is extremely low in the transonic region below 20,000 feet, especially when rolling away from the failed side. Significant roll and yaw coupling may occur with forward stick inputs at Mach >1.4 and altitude >30,000 feet.

The degradation in roll coordination is characterized as a small amount of sideforce during lateral inputs with flaps AUTO and noticeable sideslip with flaps HALF. Configuration changes exhibit a slight roll toward the failed stabilator when transitioning from flaps AUTO to flaps HALF; away from the failed stabilator when transitioning from flaps HALF to flaps AUTO. Flight tests demonstrated that flight with a stabilator failed in flaps HALF was nearly transparent to the pilot from a handling qualities perspective during normal approaches, waveoffs, and bolters or flared landings. A small but controllable yaw away from the failed stabilator is apparent at touchdown. Additionally, pitch stick inputs during the landing roll complicate directional control and should be avoided.

Extending the speedbrake may produce uncommanded roll into the failed stabilator. The uncommanded roll is more pronounced at low speed flight conditions due to the reduced aileron effectiveness at the large trailing edge up aileron deflections commanded by the speedbrake function. The roll can be balanced with lateral stick deflection.

In UA, with a failed stabilator, nose down pitching moment capability is degraded at low to moderate airspeeds, especially for aft center of gravity and heavy wing store loadings. A safe level of nose down pitch capability is available for flight below 10° angle of attack.

WARNING

In UA, with a failed stabilator, do not exceed 10° AOA due to reduced nose down pitch authority.

Carrier based flight tests (STAB RECON/flaps HALF) demonstrated that carrier approaches were easily controlled but were characterized by slightly degraded flying qualities which required increased pilot attention to the landing task. Slight rolling and/or yawing motions were apparent when making longitudinal inputs. Multiple small lateral inputs were required to maintain a centered approach.

During bolters, the aircraft yawed into the good stabilator when the flight control system deflected the good stabilator trailing edge up (TEU) in preparation for aircraft nose down rotation. The yaw was sudden and pronounced, but easily controlled with rudder to counter the yawing motion.

Flight with flaps FULL has not been demonstrated due to limited nose-up control authority from the remaining good stabilator.

WARNING

- Do not select flaps FULL for landing with a failed stabilator, because longitudinal control authority may be insufficient for landing.
- With a failed stabilator, do not exceed 10° AOA in AUTO flaps with wing stores or wing tanks.

11.4.5 GAIN ORIDE. While not a failure mode, GAIN ORIDE is prescribed for certain AOA or pitot-static sensor failures to provide better or more predictable handling qualities (see Warning/Caution/Advisory Displays, figure 12-1). With flaps AUTO, selecting GAIN ORIDE results in fixed gains that correspond to Mach 0.80, 39,000 feet, and 250 KCAS. At flight conditions that deviate from the fixed gains, a slight degradation in handling qualities should be expected. The aircraft is less sensitive to longitudinal inputs, as less pitch rate is generated per given stick input. Lateral stick inputs provide similar responses as in GAIN NORM. In GAIN ORIDE, the aircraft is more sensitive to directional inputs. Regardless, handling qualities remain very good within the 10° AOA and 350 KCAS NATOPS limits for GAIN ORIDE operation. If the airspeed limit is exceeded, self-sustained pitch oscillations will start to occur above 375 KCAS, and the aircraft will become uncontrollable above 450 KCAS due to the fixed air data values in the flight control system gains. If the AOA limit is exceeded, departures are likely since the fixed values of the air data and AOA severely reduce departure resistance. Additionally, the aircraft will stall at a higher than normal airspeed due to the fixed position of the LEFs.

With flaps HALF or FULL, GAIN ORIDE results in fixed gains that correspond to 8.1° AOA and 500 feet; handling qualities are best at these conditions and degrade slightly away from on-speed AOA. At higher airspeeds in 1g flight, the aircraft will stabilize at lower than normal AOA, due to the TEF position frozen at higher than normal deflections. While not dangerous, this characteristic is uncomfortable. Also, at higher airspeeds, higher than normal aft stick force is required to maintain flight path while in a turn. Flight is prohibited above 190 KCAS (flaps FULL) or 200 KCAS (flaps HALF) due to these characteristics. Flight is also prohibited above 10° AOA due to the reduced stall margin available with fixed LEF deflections.

Transition to or from landing configuration should be done in level flight at 180 KCAS. Transition should not be made while in a bank due to the higher than normal aft stick forces required to maintain flight path angle. Sideslip excursions may also occur if flap transition is made in a turn.

Carrier based flight tests (GAIN ORIDE/flaps HALF) demonstrated satisfactory approach handling qualities. The aircraft remained easily controllable, though increased pilot attention to the landing task

was required. During descent, small longitudinal inputs were required to maintain proper AOA and pitch attitude. Approaches flown at conditions other than on-speed resulted in sluggish longitudinal handling qualities.

WARNING

Bolters in GAIN ORIDE or with AOA failed require positive aft stick during rotation, 1/2 aft stick is recommended. Deflections of less than 1/2 aft stick will result in excess settle during bolters.

CAUTION

In GAIN ORIDE, AOA will tend to readily increase above 14° when decelerating from a trimmed on-speed condition. Timely longitudinal stick inputs will be required to prevent excessive sink rates and correct a deceleration as power alone will not change the AOA or pitch attitude sufficiently in GAIN ORIDE. Alpha tone is disabled in GAIN ORIDE with FLAPS HALF or FULL.

11.4.6 AHRS Failure Flying Qualities. An AHRS channel failure is defined as the loss of both rate and acceleration data (Xs in CAS P, CAS R, CAS Y, N ACC, and L ACC). Single or dual channel AHRS failures should have no adverse effect on flying qualities. If a third channel failure is detected, all four channels will be Xd out because the FCCs will be unable to confirm which channel is providing valid data. If the third failure can be isolated to a particular channel, all four channels will be Xd out but the flying qualities will be unaffected with the exception of a small degradation to the g-limiter. If a third failure occurs but is not detected (two columns of Xs), or is detected but not isolated to a particular channel (four columns of Xs), flying qualities will be somewhat degraded. When flying qualities are degraded due to AHRS channel failures, poor roll coordination for large lateral inputs, pitch coupling, and/or sluggish pitch response can be expected. Due to the higher reliability of AHRS over previous rate and acceleration sensors, a four channel failure is highly unlikely. However, simulator evaluation has shown that a complete four channel AHRS failure (no rate and acceleration inputs to FCCs) is controllable for most of the flight envelope with the flaps in AUTO. Refer to figure 11-1 for AHRS channel failure indications and effects.

WARNING

AHRS failure modes have not been flight tested. With a four channel AHRS failure, the aircraft is not controllable with the flaps in HALF or FULL. At altitudes above 25,000 feet, loss of control occurs below Mach 0.92. For loss of AHRS above 25,000 feet, maintain airspeed above Mach 0.92 while descending.

With a four channel AHRS failure at altitudes below 20,000 feet, flying qualities are optimum between 190 to 210 KCAS, and are acceptable above 370 KCAS. When decelerating below 370 KCAS, flying qualities are degraded until below 270 KCAS. The worst flying qualities are between 270 to 370 KCAS. Flying qualities do improve above 370 KCAS, with a further improvement at supersonic speeds. Execute a straight-in on-speed approach with flaps in AUTO, and limit angle of bank to 20°. Pitch and directional damping will be very low and roll coordination weak. If not positioned for landing by in the

middle to in close, a wave-off and go-around should be executed. A clean, lightly loaded aircraft exhibits the best flying qualities. Flying qualities are not affected by CG locations, and the aircraft can be landed to the aft CG limit. An arrested landing should be made if airspeed permits. Avoid stabilator braking.

Level of AHRS Channel Failure	Indications	Effects
One Channel Failure	<ul style="list-style-type: none"> • Xs in one column (CAS P, CAS R, CAS Y, N ACC, and L ACC) • DEGD X 	No effects on flying qualities.
Two Channel (incremental failure)	<ul style="list-style-type: none"> • Xs in two columns (CAS P, CAS R, CAS Y, N ACC, and L ACC) • DEGD X 	
Two channel (simultaneous failure caused by loss of communication between the two AHRS channels and the FCCs)	<ul style="list-style-type: none"> • Xs in two columns (CAS P, CAS R, CAS Y, N ACC, and L ACC) • DEGD X 	
Three channel (detected and isolated)	<ul style="list-style-type: none"> • Xs in four columns (CAS P, CAS R, CAS Y, N ACC, and L ACC) • DEGD X • PCAS, RCAS, and YCAS cautions 	Small degradation to the g-limiter
Three channel (detected but not isolated)	<ul style="list-style-type: none"> • Xs in four columns (CAS P, CAS R, CAS Y, N ACC, and L ACC) • DEGD X • PCAS, RCAS, and YCAS cautions 	<ul style="list-style-type: none"> • Poor roll coordination for large lateral inputs • Sluggish pitch response • Pitch coupling
Three channel (not detected)	<ul style="list-style-type: none"> • Xs in two columns (CAS P, CAS R, CAS Y, N ACC, and L ACC) • DEGD X 	
Four channel	<ul style="list-style-type: none"> • Xs in four columns (CAS P, CAS R, CAS Y, N ACC, and L ACC) • DEGD X • PCAS, RCAS, and YCAS cautions 	<ul style="list-style-type: none"> • Uncontrollable in flaps HALF or FULL • Poor roll coordination for large lateral inputs • Sluggish pitch response • Pitch coupling

Figure 11-1. AHRS Channel Failure Indication and Effects

PART V

EMERGENCY PROCEDURES

Chapter 12 - General Emergencies

Chapter 13 - Ground Emergencies

Chapter 14 - Takeoff Emergencies

Chapter 15 - Inflight Emergencies

Chapter 16 - Landing Emergencies

Chapter 17 - Ejection

Chapter 18 - Immediate Action

EMERGENCY INDEX

Conference X-ray telephone number (Inflight emergencies only)
314-232-9999 and 866-543-5444

CHAPTERS 12 THRU 17

Page
No.

A

ABORT	V-14-2
AFTERBURNER FAILURE	V-15-1
AILERON HINGE FAILURE - SUSPECTED, INBOARD	V-15-47
ANGLE OF ATTACK (AOA) FAILURE	V-15-44
AOA PROBE DAMAGE OR BINDING	V-15-45
AOA PROBE SELECTION	V-15-46
ARRESTMENT - FIELD	V-16-13
Arresting Gear Types.	V-16-13
Arrestment Decision.	V-16-14
Arrestment - Short Field.	V-16-14
Arrestment - Long Field.	V-16-14
ARS MALFUNCTIONS.....	V-15-25
ARS Hose Fails to Retract.	V-15-25
ARS Refueling Hose Jettison.....	V-15-25
ARS Hydraulic Pressure Light.	V-15-25
No RDY Light.	V-15-26

B

BARRICADE ARRESTMENT	V-16-14
BOLTER	V-16-3
BRAKE FAILURE/EMERGENCY BRAKES	V-13-4

C

COCKPIT SMOKE, FUMES, OR FIRE.....	V-15-16
COCKPIT TEMPERATURE HIGH.....	V-15-15
CONTROLLABILITY CHECK	V-15-22
CV RECOVERY MATRIX	V-16-18

D

DISPLAY MALFUNCTION - AMCD AIRCRAFT	V-15-19
DITCHING	V-17-4
DOUBLE TRANSFORMER-RECTIFIER FAILURE.....	V-15-10
DUAL AOA FAILURE ON TAKEOFF.....	V-15-47
DUAL MISSION COMPUTER (MC) FAILURE - AMCD AIRCRAFT	V-15-19

E

EJECTION..... V-17-1
 Ejection Procedures..... V-17-3
 Ejection Seat Restrictions..... V-17-1
 Airspeed during Ejection..... V-17-2
 Injury Risks - Nude Weight Greater than 213 lb. V-17-1
 Injury Risks - Nude Weight Less than 136 lb..... V-17-1
 High Altitude Ejection..... V-17-3
 Low Altitude Ejection..... V-17-2
 EMERGENCY CATAPULT FLYAWAY V-14-1
 EMERGENCY TANKER DISENGAGEMENT V-15-26
 EMERGENCY EGRESS V-13-3
 ENGINE FAILS TO START/HUNG START V-13-1
 EXTERNAL STORES JETTISON..... V-15-23

F

FCS FAILURE INDICATIONS AND EFFECTS V-15-27
 FORCED LANDING V-16-4
 FUSELAGE FUEL LEAK..... V-15-4

G

GENERAL V-12-1
 Immediate Action Items..... V-12-1
 Warnings, Cautions, and Advisories. V-12-1
 GO AROUND V-14-3
 GROUND FIRE..... V-13-2

H

HOT BRAKES/BRAKE FIRE V-13-2
 HOT START..... V-13-1
 HUNG START V-13-1
 HYDRAULIC FAILURES..... V-15-5
 HYPOXIA/LOW MASK FLOW/NO MASK FLOW V-15-17

L

LANDING GEAR EMERGENCY EXTENSION..... V-16-5
 LANDING GEAR FAILS TO RETRACT V-14-6
 LANDING GEAR UNSAFE/FAILS TO EXTEND V-16-4
 LOSS OF CABIN PRESSURIZATION V-15-18
 LOSS OF DC ESSENTIAL BUS V-13-1
 LOSS OF DIRECTIONAL CONTROL DURING TAKEOFF OR LANDING
 (BLOWN TIRE, NWS FAILURE)..... V-14-4

O

OUT-OF-CONTROL FLIGHT (OCF) V-15-19
 Departure from Controlled Flight. V-15-19
 Spin. V-15-20
 OCF Recovery Procedures V-15-20
 Post Departure Dive Recovery V-15-21

P

PLANING LINK FAILURE..... V-16-12

R

RESTART V-15-1

S

SEAWATER ENTRY V-17-4
SINGLE ENGINE APPROACH AND LANDING..... V-16-1
SINGLE ENGINE FAILURE IN LANDING CONFIGURATION V-16-1
SINGLE ENGINE WAVEOFF/BOLTER V-16-3

WARN/CAUT/FCS/HYD/ADVIS

Warn/Caut/FCS/Hyd/Advis	Page No	Warn/Caut/FCS/Hyd/Advis	Page No
A/A	V-12-71	EGT HIGH L/R	V-12-17
A/G	V-12-71	ENG L/R	V-12-17
ABLIM	V-12-64	ENG VIB L/R	V-12-17
ACI	V-12-64	ERASE FAIL	V-12-17
AHMD	V-12-64	EXT TANK	V-12-18
AIR DATA	V-12-7	EXT XFER	V-12-18
ALGN Xd	V-12-64	FADEC	V-12-66
AM DL	V-12-64	FADEC HOT	V-12-19
AMAD & PR L/R	V-12-7	FC AIR DAT	V-12-41
ANTI ICE L/R	V-12-7	FCCGN	V-12-66
ANTISKID	V-12-7	FCS	V-12-42
AOA	V-12-38		-V-12-47
AOA TONE	V-12-8	FCS HOT	V-12-42
APU ACCUM	V-12-8	FCS Initial	V-12-35
APU FIRE	V-12-3	FCS AHRS 1/2	
ARS DROGUE	V-12-8	Ch Fail	V-12-36
ATC FAIL	V-12-39	FCS AHRS 4 Ch Fail	V-12-37
ATS L/R	V-12-9	FCS Ail Fail	V-12-38
AUTO PILOT	V-12-9	FCS AOA Fail	V-12-38
AV AIR HOT	V-12-10	FCS AOA 4 Ch Fail	V-12-39
BALT	V-12-64	FCS Singl Ch Fail	V-12-40
BATT SW	V-12-10	FCS Rud Fail	V-12-46
BAY DISCH	V-12-10	FCS Stab Fail	V-12-47
BAY FIRE	V-12-11	FIRE	V-12-4
BINGO	V-12-11	FLAMEOUT L/R	V-12-19
BIT	V-12-64	FLAP SCHED	V-12-45
BLD OFF L/R	V-12-12	FLAPS (Amber)	V-12-71
BLEED DUAL	V-12-3	FLAPS OFF LEF	V-12-43
BLEED Single	V-12-4	FLAPS OFF TEF	V-12-44
BOOST LO L/R	V-12-13	FLIR OVRHT	V-12-19
BRK ACCUM	V-12-13	FPAH	V-12-66
CABIN	V-12-13	FPAS	V-12-66
CANOPY	V-12-14	F-QTY	V-12-66
CAS P/R/Y	V-12-40	FUEL HOT L/R	V-12-20
CAUT DEGD	V-12-14	FUEL INLT L/R	V-12-20
CFIT Xd	V-12-64	FUEL LO	V-12-20
CHECK SEAT	V-12-14	FUEL XFER	V-12-21
CHECK TRIM	V-12-14	FULL	V-12-71
CK ECS	V-12-14	GEAR HANDLE	V-12-5
CK FLAPS	V-12-14	GEN L/R	V-12-22
CNI	V-12-15	GEN TIE	V-12-23
COM1H/2H	V-12-64	G-LIM 7.5G	V-12-23
COM1L/2L	V-12-64	G-LIM OVRD	V-12-23
COM1S/2S	V-12-64	GPS	V-12-66
CDATA	V-12-64	GPS DEGD	V-12-23
CONFG	V-12-65	GPSMP	V-12-66
CONSNT	V-12-71	GSEL	V-12-66
CPLD	V-12-65	GTRK	V-12-66
CRUIS	V-12-65	GUN GAS	V-12-24
CW	V-12-71	HALF	V-12-71
D BAD	V-12-65	HAND CNTRL	V-12-24
D LOW	V-12-65	HDG	V-12-66
DC FAIL L/R	V-12-15	HEAT L/R	V-12-67
DCSCS	V-12-65	HEAT Xd	V-12-67
DECM	V-12-65	HEAT FAIL	V-12-24
DCOY ON	V-12-71	HIAOA	V-12-67
DEPLOY	V-12-15	HMD	V-12-67
DEVC BLD L/R	V-12-15	HOME FUEL	V-12-24
DFIR OVRHT	V-12-15	HOOK (red)	V-12-5
DFIRS GONE	V-12-15	HOOK (green)	V-12-71
DISCH	V-12-71	HOSE	V-12-67
DPLY	V-12-71	HSEL	V-12-67
DUMP OPEN	V-12-16	HUDBU Xd	V-12-67
EBC	V-12-65	HYD 1A	V-12-48
ECS DR	V-12-65	HYD 1B	V-12-48
ECS ICING	V-12-16		

Warn/Caut/FCS/Hyd/Advis	Page No
HYD 2A	V-12-49
HYD 2B	V-12-49
HYD 1A/1B	V-12-50
HYD 1A/2A	V-12-51
HYD 1A/2B	V-12-52
HYD 1B/2A	V-12-53
HYD 1B/2B	V-12-54
HYD 2A/2B	V-12-55
HYD 1A/1B/2A	V-12-56
HYD 1A/1B/2B	V-12-58
HYD 1A/2A/2B	V-12-60
HYD 1B/2A/2B	V-12-62
HYD 1B/2B	V-12-54
HYD 5000	V-12-63
HYD 1/2 HOT	V-12-63
ID LT	V-12-24
IFF 4	V-12-24
IFFAI	V-12-24,
	V-12-68
IFF OVRHT	V-12-24
INLET ICE	V-12-25
INS ATT	V-12-25
INS DEGD	V-12-25
JAM ON	V-12-72
L BAR (Red)	V-12-6
L BAR (Green)	V-12-72
L DEGD	V-12-68
LADDER	V-12-26
LAND	V-12-68
LEFT	V-12-72
LOAD Xd	V-12-68
LOCK/SHOOT	V-12-72
M2ID	V-12-68
M4 OK	V-12-68
MASTER CAUTION	V-12-72
MC 1	V-12-26
MC 2	V-12-26
MC CONFIG	V-12-26
MIDS	V-12-68
MIDS OVRHT	V-12-27
MNTCD	V-12-68
MSNCD	V-12-68
MU FL	V-12-68
MU LOAD	V-12-27
NAV FAIL	V-12-27
NAV HVEL	V-12-27
NAV VVEL	V-12-27
NFLR OVRHT	V-12-27
NODOV	V-12-68
NO RATS	V-12-28
NOSE	V-12-72
NOSEC	V-12-69

Warn/Caut/FCS/Hyd/Advis	Page No
NWS	V-12-46
OBOGS DEGD	V-12-28
OCS	V-12-28
OIL HOT L/R	V-12-29
OIL PR L/R	V-12-29
OVRSPD L/R	V-12-29
PARK BRAKE	V-12-30
P/INS	V-12-69
PCODE	V-12-69
PITOT HT L/R	V-12-30
POS/ADC	V-12-30
POS ERROR	V-12-30
PROBE UNLK	V-12-30
RACK UNCPL	V-12-30
RALT	V-12-69
RMMCD	V-12-69
RMMFL	V-12-69
RCDR Xd	V-12-69
RCDR ON	V-12-72
READY (APU)	V-12-72
READY (Fire)	V-12-30
REC	V-12-72
REFUEL DR	V-12-31
RIG	V-12-31
RIGHT	V-12-72
R-LIM OFF	V-12-30
ROLL	V-12-69
RSET	V-12-69
RSET Xd	V-12-69
SAM	V-12-72
SPD BRK	V-12-72
SPN Light	V-12-6
S/W CONFIG	V-12-31
SEVER	V-12-31
SKID	V-12-69
SQTTR	V-12-69
STALL L/R	V-12-32
STBY	V-12-72
TK PRES LO	V-12-32
TK PRES HI	V-12-32
THERMAL L/R	V-12-33
TRIM	V-12-69
UNSAFE (Rear Cpt)	V-12-6
VOICE/AUR	V-12-33
VVEL	V-12-70
WDSHLD HOT	V-12-33
WING UNLK	V-12-34
WPNS	V-12-70
WRMUP	V-12-72
XMT	V-12-72
Y CODE	V-12-70

CHAPTER 12

General Emergencies

12.1 GENERAL

Part V contains procedures to correct an abnormal or emergency condition. While these procedures provide guidance in dealing with an emergency; they should be modified, as required, in case of multiple/combined emergencies, adverse weather, or other peculiar factors. Use common sense and sound judgment to determine the correct course of action.

Unless specifically stated in NATOPS, BLIN or MSP codes shall not be used for in-flight decision making.

Apply the following rules to all emergencies:

1. Aviate: first and foremost, maintain aircraft control.
2. Analyze the situation and take proper action. Perform immediate action procedures without delay; however, initially do only those steps required to manage the problem. When operating a control, be prepared to immediately return the control to its former setting if an undesirable response occurs.
3. Navigate: land as soon as practical, unless the situation dictates otherwise.
4. Communicate: As soon as possible, notify the flight lead, ship, ATC (air traffic control), or tower of the emergency, aircraft position, and intended course of action. Relay emergency indications, actions taken, flight conditions, power setting, etc., as time permits.

12.1.1 Immediate Action Items. Procedural steps preceded by an asterisk (*) are considered immediate action items. Pilots shall be able to accomplish these steps without reference to the Pocket Checklist (PCL).

12.1.2 Warnings, Cautions, and Advisories. Warnings, cautions, and advisories are displayed in the cockpit on the LDDI, on the upper warning/caution/advisory lights panels, or on the lower right caution lights panel. Certain cautions provide two indications: one on the LDDI and one on the lower right caution lights panel.

Warnings, cautions, and advisories are categorized and are listed alphabetically by category in figure 12-1 together with cause, remarks, and corrective action. Potential cause(s) for the associated warning/caution/advisory is indicated by a bullet (•) under the Cause/Remarks column. The categories are as follows:

- a. Warning Lights.
- b. DDI Cautions and Caution Lights not associated with FCES or HYD cautions.
- c. Flight Control Electronic System (FCES) Cautions.
- d. Hydraulic System (HYD) Cautions.
- e. DDI Advisories.
- f. Advisory Lights.
- g. CFIT Voice Warnings.

DDI cautions and advisories are listed in CAPS. Warning, caution, and advisory lights are distinguished by a box around the legend (e.g.,).

Where appropriate, voice aural warnings are listed in quotation marks with their respective warning or caution. If a DDI caution or caution light starts with a single letter (for example L, R, P, or Y) that letter is not used to place the caution alphabetically.

Warning Lights

INDICATOR	• CAUSE / REMARKS	CORRECTIVE ACTION
<p>APU FIRE</p> <p>Warning Light</p> <p>“APU Fire, APU Fire”</p>	<ul style="list-style-type: none"> • Fire/overheat condition detected in the APU bay. <p>APU FIRE extinguishing system operates automatically with WonW and must be manually activated with WoffW. System activation secures fuel to the APU, arms the fire bottle, and discharges the bottle after a 10 second delay. Discharge is delayed to allow the APU time to spool down before extinguishing agent is introduced.</p> <p style="text-align: center;">WARNING</p> <ul style="list-style-type: none"> • Since the fire extinguishing system requires 28 vdc essential bus power, the fire bottle may not be discharged if the BATT switch is turned OFF during the 10 second delay time. • Airborne, if the DISCH light does not come on 10 seconds after the APU FIRE and READY/DISCH lights have been pushed, the READY/DISCH light should be pushed and held until the DISCH light comes on. 	<p>IN FLIGHT or on GROUND</p> <ul style="list-style-type: none"> *1. APU FIRE light - PUSH *2. FIRE EXTGH READY light - PUSH <p>GROUND</p> <ul style="list-style-type: none"> *3. Throttles - OFF 4. Egress.
<p>DUAL</p> <p>L BLEED</p> <p>and</p> <p>R BLEED</p> <p>Warning Lights (of any duration)</p> <p>“Bleed Air Left (Right), Bleed Air Left (Right)”</p>	<ul style="list-style-type: none"> • Bleed air leak or fire detected in common ducting AND the overheat condition still exists (e.g., automatic BALD shutdown did not secure the leak). <p>Bleed air leak MSP codes: 953, 954, 955, 956, 957, 958, 959, 960, or 961 (code determines leak location)</p> <p>BLD OFF cautions indicate that the corresponding primary bleed air shutoff valve has been commanded closed and are not an indication of actual valve position. Valve(s) could still be open allowing bleed air to leak.</p> <p>If hook release cable is damaged by a bleed air leak or fire, it may be impossible to lower the hook.</p> <p style="text-align: center;">WARNING</p> <ul style="list-style-type: none"> • Under less than optimal conditions (low altitude, heavy breathing, loose fitting mask, etc.), as few as 3 minutes of emergency oxygen may be available. • If both bleeds secured - <ul style="list-style-type: none"> - No OBOGS - No ECS or cabin pressurization - No anti-g protection - No external fuel transfer - No crossbleed start - No windshield anti-ice/rain removal - May get AV AIR HOT during approach - To prevent canopy fogging, select OFF/RAM or RAM/DUMP and move the DEFOG handle to HIGH 	<p>GROUND</p> <ol style="list-style-type: none"> 1. Throttles - OFF 2. APU switch - OFF <p>IN FLIGHT</p> <ul style="list-style-type: none"> *1. Throttles - MINIMUM PRACTICAL *2. Emergency oxygen green ring(s) - PULL *3. BLEED AIR knob - OFF (DO NOT CYCLE) *4. Initiate rapid descent to below 10,000 feet cabin altitude. <p>If dual BLEED warning lights go out, execute DUAL BLD OFF caution procedure.</p> <p>If lights remain on -</p> <ol style="list-style-type: none"> 5. Land as soon as possible. 6. Airspeed - Maintain below 325 KCAS (300 to 325 KCAS optimum). 7. ECS MODE switch - OFF/RAM 8. AV COOL switch - EMERG 9. CABIN PRESS switch - RAM/DUMP 10. HOOK handle - DOWN 11. EXT TANKS switch(es) - STOP 12. OXY FLOW knob(s) - OFF 13. OBOGS control switch - OFF 14. Maintain altitude below 10,000 feet MSL prior to emergency oxygen depletion (10 to 20 minutes). 15. Consider removing mask and resetting emergency oxygen system once below 10,000 feet MSL. <p>If AV AIR HOT caution appears -</p> <ol style="list-style-type: none"> 16. Non-essential avionics equipment - OFF (e.g., RADAR, UFC controlled avionics, ECM, sensors, MC2)

Figure 12-1. Warning/Caution/Advisory Displays (Sheet 1 of 71)

Warning Lights

INDICATOR	• CAUSE / REMARKS	CORRECTIVE ACTION
<p>SINGLE</p> <p>L BLEED</p> <p>or</p> <p>R BLEED</p> <p>Warning Light (of any duration)</p> <p>“Bleed Air Left (Right), Bleed Air Left (Right)”</p>	<ul style="list-style-type: none"> Bleed air leak or fire detected on designated side AND the overheat condition still exists (e.g., automatic BALD shutdown did not secure the leak). <p>Bleed air leak MSP codes: 953, 954, 955, 956, 957, 958, 959, 960, or 961 (code determines leak location)</p> <p>BLD OFF cautions indicate that the corresponding primary bleed air shutoff valve has been commanded closed and are not an indication of actual valve position. Valve(s) could still be open allowing bleed air to leak.</p> <div style="text-align: center; border: 2px solid black; padding: 5px; width: fit-content; margin: 10px auto;">WARNING</div> <ul style="list-style-type: none"> Under less than optimal conditions (low altitude, heavy breathing, loose fitting mask, etc.), as few as 3 minutes of emergency oxygen may be available. If both bleeds secured - <ul style="list-style-type: none"> No OBOGS No ECS or cabin pressurization No anti-g protection No external fuel transfer No crossbleed start No windshield anti-ice/rain removal May get AV AIR HOT during approach To prevent canopy fogging, select OFF/RAM or RAM/DUMP and move the DEFOG handle to HIGH 	<p>GROUND</p> <ol style="list-style-type: none"> Throttles - OFF <p>IN FLIGHT</p> <ul style="list-style-type: none"> Throttle affected engine - IDLE BLEED AIR knob - L OFF or R OFF (DO NOT CYCLE) <p>If light goes out, execute SINGLE BLD OFF caution procedure.</p> <p>If light still on, do the following in order until light goes out -</p> <ul style="list-style-type: none"> Throttle affected engine - OFF Emergency oxygen green ring(s) - PULL BLEED AIR knob - OFF (DO NOT CYCLE) Initiate rapid descent to below 10,000 feet cabin altitude. Land as soon as possible. <p>If both bleeds secured -</p> <ol style="list-style-type: none"> Airspeed - Maintain below 325 KCAS (300 to 325 KCAS optimum). ECS MODE switch - OFF/RAM AV COOL switch - EMERG CABIN PRESS switch - RAM/DUMP EXT TANKS switch(es) - STOP OXY FLOW knob(s) - OFF OBOGS control switch - OFF Maintain altitude below 10,000 feet MSL prior to emergency oxygen depletion (10 to 20 minutes). Consider removing mask and resetting emergency oxygen system once below 10,000 feet MSL. <p>If AV AIR HOT caution appears -</p> <ol style="list-style-type: none"> Non-essential avionics equipment - OFF (e.g., RADAR, UFCO controlled avionics, ECM, sensors, MC2)
<p>FIRE</p> <p>Warning Light</p> <p>“Engine Fire Left (Right), Engine Fire Left (Right)”</p>	<ul style="list-style-type: none"> Fire/overheat condition detected in corresponding engine/AMAD bay. <p>If dual FIRE light indications and unable to determine which light came on first, check engine instruments for indications of a fire. High fuel flow, high EGT, rough running, or smoke and fumes may indicate the affected side, even if present prior to the FIRE light coming on. Do not hesitate to push the FIRE EXTGH READY light and lower the HOOK handle once FIRE procedures have been initiated. If the hook release cable is damaged by an engine bay fire, it may be impossible to lower the hook.</p> <div style="text-align: center; border: 2px solid black; padding: 5px; width: fit-content; margin: 10px auto;">WARNING</div> <ul style="list-style-type: none"> The probability of extinguishing a fire and preventing relights is greatly increased by immediately discharging the fire extinguisher. An engine bay fire may damage the engine bay door, which is critical to structural integrity. Following an engine bay fire, limit maneuvering to 5g, limit descent rate at touchdown to less than 1,000 fpm, and minimize roll and yaw at landing. An off-center arrestment following an engine fire can lead to catastrophic structural failure. 	<p>GROUND</p> <ol style="list-style-type: none"> Throttles - OFF FIRE light affected engine - PUSH FIRE EXTGH READY light - PUSH AND HOLD UNTIL DISCH LIGHT COMES ON (5 seconds maximum) BATT switch - OFF Egress. <p>IN FLIGHT</p> <p>Dual FIRE lights -</p> <ul style="list-style-type: none"> Throttles - Minimum practical <p>Single FIRE light or Dual when side confirmed -</p> <ul style="list-style-type: none"> Throttle affected engine - OFF FIRE light affected engine - PUSH FIRE EXTGH READY light - PUSH AND HOLD UNTIL DISCH LIGHT COMES ON (5 seconds maximum) HOOK handle - DOWN Land as soon as possible.

Figure 12-1. Warning/Caution/Advisory Displays (Sheet 2)

Warning Lights

INDICATOR	• CAUSE / REMARKS	CORRECTIVE ACTION
<p>HOOK (Red) Warning Light</p>	<ul style="list-style-type: none"> Arresting hook position does not agree with HOOK handle position. Hook not fully extended with the HOOK handle down in flight. Hook down with WonW. <p style="text-align: center;">WARNING</p> <p>With the HOOK light on, the HOOK handle up, and the hook up, the hook will drop during engine shutdown. Ensure personnel are clear of the hook prior to engine shutdown</p> <p>If the mechanical hook uplatch mechanism fails, the hook cannot be released and an arrested landing is not possible. If the hook is unlocked (HOOK handle down) but fails to leave the up position, an arresting hook system failure may be applying HYD 2B pressure to hold the hook up. For this reason, pulling the HOOK circuit breaker deenergizes the hook selector valve and ensures HYD 2B pressure is removed.</p> <p>If the arresting hook snubber is not properly charged, the arresting hook may not fully extend due to airloads and HYD 2B back-pressure. In this case, if reducing airspeed does not extinguish the HOOK light, shutting down the right engine reduces HYD 2B back-pressure and should increase arresting hook extension. After engine restart, the hook may retract at a maximum rate of 2° minute. If the HOOK light remains on after this procedure and a visual inspection confirms the hook is partially extended, a successful arrestment is possible due to g-loads at landing.</p>	<p>IN FLIGHT</p> <ol style="list-style-type: none"> Reduce airspeed. <p>If HOOK light remains on -</p> <ol style="list-style-type: none"> Get a visual inspection (if practical). <p>If the hook is in the up position -</p> <ol style="list-style-type: none"> HOOK circuit breaker - PULL <p>If the HOOK light remains on and the hook is partially extended -</p> <ol style="list-style-type: none"> Throttle right engine - IDLE for one minute then OFF Reduce airspeed to drop HYD2 pressure to zero (if practical). Restart for landing. <p>If hook still fails to extend (Carrier landing) -</p> <ol style="list-style-type: none"> Divert. <p>If the hook is partially extended -</p> <ol style="list-style-type: none"> Attempt a normal carrier landing.
<p>Landing Gear Warning Light (Light in LDG GEAR Handle)</p>	<p>STEADY</p> <ul style="list-style-type: none"> Landing gear in transit. Landing gear unsafe. Planing link failure. <p>-----</p> <p>FLASHING</p> <ul style="list-style-type: none"> Wheels warning (less than 7,500 feet, less than 175 KCAS, and over 250 fpm descent rate). Loss of air data. 	<p>STEADY</p> <ol style="list-style-type: none"> Check gear down indications. Refer to appropriate emergency procedures. <ul style="list-style-type: none"> LDG Gear Fails to Retract LDG Gear Unsafe/Fails to Extend Planing Link Failure <p>-----</p> <p>FLASHING (Wheels Warning)</p> <ol style="list-style-type: none"> LDG GEAR handle - DN or increase airspeed and/or altitude.

Figure 12-1. Warning/Caution/Advisory Displays (Sheet 3)

Warning Lights

INDICATOR	• CAUSE / REMARKS	CORRECTIVE ACTION
<p>RED</p> <p>L BAR</p> <p>Warning Light</p>	<p>ON DECK</p> <ul style="list-style-type: none"> Launch bar control system malfunction (proximity switch failure). <p>IN FLIGHT</p> <ul style="list-style-type: none"> Launch bar failed to retract after catapult launch (Launch bar not up and locked AND weight off the left main gear). Launch bar control system malfunction (proximity switch failure). <p>If the red L BAR light remains on, assume that the launch bar is NOT up and locked and it may drop to the deck during landing. The nose landing gear cannot be retracted. Placing the LDG GEAR handle UP raises the main landing gear and leaves the nose landing gear extended.</p>	<p>ON DECK</p> <ol style="list-style-type: none"> Suspend catapult launch. LAUNCH BAR switch - RETRACT <p>If launch bar fails to retract -</p> <ol style="list-style-type: none"> LB circuit breaker - PULL <p>IN FLIGHT</p> <ol style="list-style-type: none"> LDG GEAR handle - LEAVE DN (if practical) LAUNCH BAR switch - VERIFY RETRACT LB circuit breaker - PULL <p>Carrier -</p> <ol style="list-style-type: none"> Divert or remove cross deck pendants 1 and 4 (1 and 3 as appropriate) and make a normal landing. Refer to Landing Gear Malfunction Landing Guide. <p>Ashore -</p> <ol style="list-style-type: none"> Remove arresting wires and make a normal landing. Refer to Landing Gear Malfunction Landing Guide.
<p>RALT Warning (on UFCD)</p>	<ul style="list-style-type: none"> Aircraft is below the primary low altitude warning (LAW) setting. 	<ol style="list-style-type: none"> Climb above primary RALT setting or reset LAW setting to a lower altitude.
<p>SPN</p> <p>Warning Light</p>	<p>WARNING</p> <p>• SPIN switch in the RCVY position.</p> <p>Selection of manual spin recovery mode (SPIN switch to RCVY) seriously degrades controllability, prevents recovery from any departure or spin, and is prohibited.</p>	<ol style="list-style-type: none"> SPIN switch - NORM (GUARD DOWN)
<p>THREAT WARNINGS</p>	<p>Refer to Tactical Manual.</p>	
<p>UNSAFE</p> <p>(rear cockpit)</p>	<ul style="list-style-type: none"> Landing gear in transit. Landing gear unsafe. If illuminated with no indications in the front cockpit, indicates a popped LG circuit breaker. <p>Does not illuminate for a planing link failure, loss of air data, or wheels warning.</p>	<ol style="list-style-type: none"> Confirm landing gear position with pilot.

Figure 12-1. Warning/Caution/Advisory Displays (Sheet 4)

DDI Cautions and Caution Lights

INDICATOR	• CAUSE / REMARKS	CORRECTIVE ACTION
AIR DATA	<ul style="list-style-type: none"> MC unable to determine which source error correction to utilize (e.g., configuration discrepancy). FCC source error correction disagrees with MC commanded source error correction. <p>Caution is only activated WonW.</p>	<ol style="list-style-type: none"> Perform FCS IBIT. <p>If caution remains/returns -</p> <ol style="list-style-type: none"> Do not takeoff.
L AMAD PR R AMAD PR	<ul style="list-style-type: none"> Loss of designated AMAD oil pressure. <p>Securing the GEN (ac output) greatly reduces the heat load imparted to the AMAD oil and may prevent heat-related damage to the generator.</p> <div style="border: 2px solid black; padding: 5px; text-align: center; width: fit-content; margin: 10px auto;">WARNING</div> <p>A L/R AMAD PR caution could be an indication of an AMAD oil leak which may result in an engine /AMAD bay fire.</p> <p>SINGLE GEN FAILURE AND AMAD PR</p> <ul style="list-style-type: none"> A single GEN failure accompanied by an AMAD PR caution on the same side is a potential indication of major mechanical damage to the generator and AMAD. 	<ol style="list-style-type: none"> GEN switch affected engine - OFF <p>If more than 5 minutes to landing -</p> <ol style="list-style-type: none"> Throttle affected engine - OFF Restart for landing (if required). Land as soon as practical. <p>If restarting affected engine for landing -</p> <ol style="list-style-type: none"> GEN switch affected engine - ON Affected engine - Restart <p>After engine restarted -</p> <ol style="list-style-type: none"> GEN switch affected engine - OFF <p>SINGLE GEN FAILURE AND AMAD PR</p> <ol style="list-style-type: none"> GEN switch affected engine - OFF (DO NOT RESET) Throttle affected engine - OFF immediately (if practical) Land as soon as practical. Execute Single Engine Approach and Landing procedure.
L ANTI ICE R ANTI ICE	<ul style="list-style-type: none"> Engine anti-ice valves failed to close when commanded by the FADEC. <div style="border: 2px solid black; padding: 5px; text-align: center; width: fit-content; margin: 10px auto;">CAUTION</div> <p>Unregulated engine anti-ice airflow may damage the inlet device and cause potential engine FOD.</p>	<ol style="list-style-type: none"> Throttle affected engine - IDLE <p>If not in icing conditions -</p> <ol style="list-style-type: none"> ENG ANTI ICE switch - OFF <p>If caution is removed -</p> <ol style="list-style-type: none"> Resume normal engine operation. <p>If caution remains/returns -</p> <ol style="list-style-type: none"> Throttle affected engine - IDLE Land as soon as practical.
ANTISKID	<ul style="list-style-type: none"> Anti-skid system failed BIT. <p>Anti-skid protection not available for use with normal braking.</p> <div style="border: 2px solid black; padding: 5px; text-align: center; width: fit-content; margin: 10px auto;">WARNING</div> <ul style="list-style-type: none"> Use of brakes without anti-skid at high speed can result in blown tires resulting in loss of directional control. If practical, rollout speed should be slow as possible before applying brake pedal pressure. Do not cycle the ANTI SKID switch in response to an ANTISKID caution immediately prior to landing for the following reasons: <ol style="list-style-type: none"> The ANTISKID caution is removed for up to 13.5 seconds as the system performs IBIT even though the anti-skid system may still be failed. If the system is not failed, wheel motion at touchdown or during landing rollout may cause a false BIT failure and a dump of normal brake pressure when brakes are applied. If the ANTI SKID switch is not placed to OFF with an ANTISKID caution displayed, normal braking capability may be lost completely. 	<p>GROUND</p> <ol style="list-style-type: none"> ANTI SKID switch - OFF <p>IN FLIGHT</p> <p>If more than 30 seconds to landing -</p> <ol style="list-style-type: none"> ANTI SKID switch - CYCLE ONCE <p>If caution reappears or if less than 30 seconds to landing -</p> <ol style="list-style-type: none"> ANTI SKID switch - OFF (DO NOT CYCLE.) Consider Short Field arrestment. If arresting gear not available or not desired, regulate brake pedal force to prevent wheel skid.

Figure 12-1. Warning/Caution/Advisory Displays (Sheet 5)

DDI Cautions and Caution Lights

INDICATOR	• CAUSE / REMARKS	CORRECTIVE ACTION
<p>AOA TONE</p>	<ul style="list-style-type: none"> • AOA warning tone in flaps AUTO is unavailable due to AOA failure or more than one invalid value used to calculate the FLY lateral weight asymmetry. <p>If caution caused by AOA failure, the AOA limit will still be displayed on the CHKLST page. Otherwise, the FLY lateral weight asymmetry value and AOA limit value will be removed from the CHKLST page.</p>	<p>If caution caused by AOA failure -</p> <ol style="list-style-type: none"> 1. Execute AOA Four Channel Failure procedure. <p>Otherwise -</p> <ol style="list-style-type: none"> 1. Manually calculate lateral weight asymmetry to determine AOA limit.
<p>APU ACCUM</p> <div style="border: 1px solid black; padding: 2px; display: inline-block; margin: 5px;">APU ACC</div> <p>Caution Light</p>	<ul style="list-style-type: none"> • APU accumulator pressure low (below 2,450 psi). <p>The APU ACCUM caution can be expected after APU start or after emergency gear/probe extension in flight. With WonW, the APU accumulator recharges automatically. With WoffW, the HYD ISOL switch may need to be held for up to 20 seconds following emergency gear/probe extension or APU start to remove the APU ACCUM caution and 30 seconds to provide a full charge (up to 40 seconds after in-flight APU start).</p> <div style="text-align: center; margin: 10px 0;">  </div> <p>If the APU ACCUM caution appears in flight and is not related to emergency gear/probe extension or APU start, it may indicate a possible leak in the isolated HYD 2B system.</p>	<p>IN FLIGHT</p> <p>If APU ACCUM caution appeared following emergency gear or probe extension or APU start -</p> <ol style="list-style-type: none"> 1. HYD ISOL switch - ORIDE (until 10 seconds after APU ACCUM caution removed - approximately 30 seconds total) <p>Otherwise, if required or desired -</p> <ol style="list-style-type: none"> 1. HYD ISOL switch - ORIDE (10 seconds maximum) <p>If caution remains or returns -</p> <ol style="list-style-type: none"> 2. Do not select HYD ISOL ORIDE. (To inhibit leaking out HYD 2B.) 3. Extend landing gear as soon as practical.
<p>ARS DROGUE</p>	<ul style="list-style-type: none"> • ARS PWR switch is OFF and the drogue is not fully retracted. 	<p>GROUND</p> <ol style="list-style-type: none"> 1. Ensure ground crew properly stows drogue by manually rotating RAT CCW. <p>If caution remains -</p> <ol style="list-style-type: none"> 2. Do not takeoff. <p>IN FLIGHT</p> <ol style="list-style-type: none"> 1. Maintain airspeed at/below maximum hose/drogue retraction airspeed. 2. ARS PWR switch - ON 3. HOSE switch - CYCLE TO EXT THEN RETR 4. ARS PWR switch - OFF <p>If caution remains -</p> <ol style="list-style-type: none"> 5. Get a visual inspection. <p>If drogue appears stowed -</p> <ol style="list-style-type: none"> 6. Make a normal landing. <p>If drogue extended and does not retract -</p> <ol style="list-style-type: none"> 6. HOSE jettison switch - HOLD IN CUT (until hose is severed) <p>If hose jettison is unsuccessful -</p> <ol style="list-style-type: none"> 7. Perform a field landing with the arresting cable removed.

Figure 12-1. Warning/ Caution/ Advisory Displays (Sheet 6)

DDI Cautions and Caution Lights

INDICATOR	• CAUSE / REMARKS	CORRECTIVE ACTION
<p>L ATS R ATS</p>	<ul style="list-style-type: none"> Designated air turbine starter rpm too high (e.g., both sources of ATS overspeed cutout protection have failed). ECS valve failures are routing engine bleed air to rotate the corresponding ATS. <div style="text-align: center; border: 2px solid black; padding: 5px; width: fit-content; margin: 10px auto;">WARNING</div> <ul style="list-style-type: none"> Under less than optimal conditions (low altitude, heavy breathing, loose fitting mask, etc.), as few as 3 minutes of emergency oxygen may be available. If both bleeds secured - <ul style="list-style-type: none"> No OBOGS No ECS or cabin pressurization No anti-g protection No external fuel transfer No crossbleed start No windshield anti-ice/rain removal May get AV AIR HOT during approach To prevent canopy fogging, select OFF/RAM or RAM/DUMP and move the DEFOG handle to HIGH <div style="text-align: center; border: 2px solid black; padding: 5px; width: fit-content; margin: 10px auto;">CAUTION</div> <p>Regardless of the engine start air source utilized, the corresponding GEN switch should be ON, as the generator provides primary overspeed cutout protection for the ATS.</p>	<p>GROUND After engine start (other than momentary) –</p> <ol style="list-style-type: none"> APU switch - OFF BLEED AIR knob - OFF Throttle affected engine - OFF ENG CRANK switch - VERIFY OFF <p>IN FLIGHT (other than momentary)</p> <ul style="list-style-type: none"> *1. Throttles - Minimum practical *2. Emergency oxygen green ring(s) - PULL *3. BLEED AIR knob - OFF (DO NOT CYCLE) *4. Initiate rapid descent to below 10,000 feet cabin altitude. <p>If caution remains -</p> <ol style="list-style-type: none"> Throttle affected engine - IDLE <p>With both BLEEDS secured -</p> <ol style="list-style-type: none"> Maintain airspeed below 325 KCAS (300 to 325 KCAS optimum). ECS MODE switch - OFF/RAM AV COOL switch - EMERG CABIN PRESS switch - RAM/DUMP EXT TANKS switch(es) - STOP Land as soon as practical. OXY FLOW knob(s) - OFF OBOGS control switch - OFF Maintain altitude below 10,000 feet MSL prior to emergency oxygen depletion (10 to 20 minutes). Consider removing mask and resetting emergency oxygen system once below 10,000 feet MSL. <p>If AV AIR HOT caution appears -</p> <ol style="list-style-type: none"> Non-essential avionics equipment - OFF (e.g., RADAR, UFCO controlled avionics, ECM, sensors, MC2) Land as soon as possible.
<p>AUTO PILOT</p>	<ul style="list-style-type: none"> Requested autopilot mode has disengaged. 	<ol style="list-style-type: none"> Paddle switch - PRESS Desired autopilot mode - RE-ENGAGE <p>If in RVSM airspace and BALT inhibited -</p> <ol style="list-style-type: none"> Notify ATC that the aircraft is no longer RVSM compliant.

Figure 12-1. Warning/Caution/Advisory Displays (Sheet 7)

DDI Cautions and Caution Lights

INDICATOR	• CAUSE / REMARKS	CORRECTIVE ACTION
<p>AV AIR HOT</p>	<ul style="list-style-type: none"> The avionics undercool sensor, located forward of the avionics bays, has determined that avionics airflow and temperature are deficient. The system assumes that if flow and temperature downstream of the avionics bays are deficient, effective avionics cooling is not being provided. <p>In flight, in ECS AUTO mode with the throttles above IDLE, if an AV AIR HOT caution is displayed, then the ECS is most likely degraded. On deck, the avionics cooling fans provide adequate avionics cooling up to an ambient temperature of approximately 103°F, but above that an AV AIR HOT caution can be expected. Advancing one or both throttles above approximately 74% N₂ rpm or selecting AUG PULL should remove the caution within 3 minutes. If an AV AIR HOT caution cannot be cleared, maintenance action is required.</p> <div style="border: 2px solid black; padding: 5px; text-align: center; width: fit-content; margin: 10px auto;"> <p>WARNING</p> </div> <p>Selection of MAN with the ECS MODE switch is prohibited. Selecting MAN while the aft cooling fan shutoff valve is open may cause the fan to overspeed resulting in a catastrophic fan failure potentially leading to loss of OBOGS.</p>	<p>GROUND</p> <ol style="list-style-type: none"> ECS mode switch - VERIFY AUTO BLEED AIR knob - CYCLE <p>If conditions permit -</p> <ol style="list-style-type: none"> Either throttle - ADVANCE ABOVE 74% rpm <p>If conditions do not permit engine runup -</p> <ol style="list-style-type: none"> APU switch - ON BLEED AIR knob - AUG PULL <p>If caution on after 3 minutes -</p> <ol style="list-style-type: none"> Do not takeoff. <p>If caution removed prior to 3 minutes -</p> <ol style="list-style-type: none"> BLEED AIR knob - Push down to normal position APU switch - OFF prior to takeoff <p>IN FLIGHT</p> <ol style="list-style-type: none"> Throttles - Maintain above IDLE <p>If caution on after 1 minute -</p> <ol style="list-style-type: none"> Maintain altitude below 25,000 feet (20,000 to 25,000 feet optimum for cooling). Maintain airspeed below 325 KCAS (300 to 325 KCAS optimum for cooling). ECS MODE switch - OFF/RAM AV COOL switch - EMERG CABIN TEMP knob - FULL COLD (cabin pressure altitude will slowly increase) <p>If caution off -</p> <ol style="list-style-type: none"> Land as soon as practical. <p>If caution remains -</p> <ol style="list-style-type: none"> Non-essential avionics equipment - OFF (e.g., RADAR, UFCO controlled avionics, ECM, sensors, MC2) Land as soon as possible.
<p>BATT SW</p> <div style="border: 1px solid black; padding: 2px; display: inline-block;"> <p>BATT SW</p> </div> <p>Caution Light</p>	<p>ALL AIRCRAFT</p> <ul style="list-style-type: none"> BATT switch is ON on the ground in the absence of ac power (first engine start). Battery is depleting and the switch should be placed to OFF unless APU start is about to be made. BATT switch is OFF in flight. (Switch should be placed to ON to provide essential bus backup capability from the PMGs and the battery.) <p>LOT 21</p> <ul style="list-style-type: none"> Battery is not being recharged in flight (BATT switch ON). Battery charger has failed or the R GEN has failed with the buses isolated (R GEN and GEN TIE caution lights). Battery is powering essential bus in flight (dual generator and dual PMG failures). At least 5 to 10 minutes of battery power remains to run the FCCs. 	<p>ALL AIRCRAFT</p> <ol style="list-style-type: none"> BATT switch - CONFIRM ON <p>LOT 21</p> <p>If all cockpit displays operating (battery charger has failed) -</p> <ol style="list-style-type: none"> Land as soon as practical. <p>If accompanied by R GEN and GEN TIE caution lights -</p> <ol style="list-style-type: none"> Refer to GEN TIE caution procedures. Land as soon as practical. <p>If all cockpit power lost (except essential bus equipment) -</p> <ol style="list-style-type: none"> Refer to L GEN/R GEN (DUAL GEN FAILURE) procedures. Land as soon as possible.
<p>BAY DISCH</p>	<ul style="list-style-type: none"> Dry Bay Fire Suppression System (DBFSS) discharged. <p>DBFSS is only armed with the LDG GEAR handle UP.</p>	<ol style="list-style-type: none"> Use all available means to confirm absence of fire. Land as soon as practical.

Figure 12-1. Warning/Caution/Advisory Displays (Sheet 8)

DDI Cautions and Caution Lights

INDICATOR	• CAUSE / REMARKS	CORRECTIVE ACTION
BAY FIRE	<p>With LDG GEAR handle UP -</p> <ul style="list-style-type: none"> Dry bay fire condition still detected 3 seconds after DBFSS discharge (e.g., fire was not extinguished). <p>With LDG GEAR handle DN -</p> <ul style="list-style-type: none"> Dry bay fire detected. (No extinguishing capability available.) <p>If dry bay fire goes out, the BAY FIRE caution is removed.</p>	<ol style="list-style-type: none"> Use all available means to confirm presence of fire. Land as soon as possible.
BINGO "Bingo, Bingo"	<ul style="list-style-type: none"> Internal fuel level below BINGO setting. <p>With MC OFP 20X OR H3E AND UP, the BINGO voice alert is repeated every 30 seconds until the BINGO setting is adjusted.</p>	<ol style="list-style-type: none"> Adjust BINGO setting or execute BINGO profile.

Figure 12-1. Warning/Caution/Advisory Displays (Sheet 9)

DDI Cautions and Caution Lights

INDICATOR	• CAUSE / REMARKS	CORRECTIVE ACTION
<p>L BLD OFF R BLD OFF</p> <p>(Both BLEED warning lights out)</p>	<ul style="list-style-type: none"> • The corresponding primary bleed air shutoff valve has been commanded closed. 1. BALD system detected a leak in one or both bleed air systems and the overheat condition no longer exists (L, R, or both cautions). 2. Over pressurization detected in one or both systems (both cautions). 3. BLEED AIR knob in L OFF, R OFF, or OFF (L, R, or both cautions). 4. ENG CRANK switch in L or R (L or R caution, respectively). 5. FIRE test switch in TEST A or TEST B (both cautions). <p>BLD OFF cautions are not an indication of actual valve position. Valve(s) could still be open allowing bleed air to leak.</p> <p>Bleed air leak MSP codes: 953, 954, 955, 956, 957, 958, 959, 960, or 961 (code determines leak location) Over pressurization MSP code: 833</p> <div style="border: 2px solid black; padding: 5px; text-align: center; width: fit-content; margin: 10px auto;">WARNING</div> <ul style="list-style-type: none"> • Automatic functioning of the BALD system may extinguish the red BLEED warning light(s) prior to aircrew recognition and may not trigger the appropriate voice alerts or the voice alerts may be the only indication of a bleed air system leak. In this case, cycling the BLEED AIR knob to remove the BLD OFF caution(s) reintroduces hot bleed air to the leaking duct. If the sensing element was damaged by the leak, automatic shutdown and isolation capability may be lost. Extensive damage or fire may result. • Under less than optimal conditions (low altitude, heavy breathing, loose fitting mask, etc.), as few as 3 minutes of emergency oxygen may be available. • If both bleeds secured - <ul style="list-style-type: none"> - No OBOGS - No ECS or cabin pressurization - No anti-g protection - No external fuel transfer - No crossbleed start - No windshield anti-ice/rain removal - May get AV AIR HOT during approach - To prevent canopy fogging, select OFF/RAM or RAM/DUMP and move the DEFOG handle to HIGH 	<p>GROUND</p> <ol style="list-style-type: none"> 1. APU switch - OFF <p>IN FLIGHT - DUAL</p> <ol style="list-style-type: none"> *1. Throttles - Minimum practical *2. Emergency oxygen green ring(s) - PULL *3. BLEED AIR knob - OFF (DO NOT CYCLE) *4. Initiate rapid descent to below 10,000 feet cabin altitude. 5. MSP codes – CHECK for 953 to 961 and for 833 <p>If 833 present without 953 to 961 (over pressurization) -</p> <ol style="list-style-type: none"> 6. BLEED AIR knob - NORM <p>If cautions do not return -</p> <ol style="list-style-type: none"> 7. Resume normal OBOGS operation. 8. Reset emergency oxygen system. 9. Throttles as desired. <p>If 953 to 961 are present (BALD shutdown) or if both cautions return -</p> <ol style="list-style-type: none"> 6. BLEED AIR knob - OFF (DO NOT CYCLE.) 7. Airspeed - Maintain below 325 KCAS (300 to 325 KCAS optimum). 8. ECS MODE switch - OFF/RAM 9. AV COOL switch - EMERG 10. CABIN PRESS switch - RAM/DUMP 11. EXT TANKS switch(es) - STOP 12. Land as soon as practical. 13. OXY FLOW knob(s) - OFF 14. OBOGS control switch - OFF 15. Maintain altitude below 10,000 feet MSL prior to emergency oxygen depletion (10 to 20 minutes). 16. Consider removing mask and resetting emergency oxygen system once below 10,000 feet MSL. <p>If AV AIR HOT caution appears -</p> <ol style="list-style-type: none"> 17. Non-essential avionics equipment - OFF (e.g., RADAR, UFCO controlled avionics, ECM, sensors, MC2) 18. Land as soon as possible. <p>IN FLIGHT - SINGLE</p> <ol style="list-style-type: none"> 1. BLEED AIR knob - L OFF or R OFF (DO NOT CYCLE) 2. Land as soon as practical.

Figure 12-1. Warning/Caution/Advisory Displays (Sheet 10)

DDI Cautions and Caution Lights



INDICATOR	• CAUSE / REMARKS	CORRECTIVE ACTION
<p>L BOOST LO R BOOST LO</p>	<ul style="list-style-type: none"> Loss of fuel boost pressure to designated engine. May indicate fuselage fuel leak. May indicate fuel transfer failure. May indicate a power transmission shaft failure if accompanied with the corresponding GEN, DC FAIL, and both HYD circuit cautions. May result from prolonged transitions through zero g (greater than 2 seconds). <p>Afterburner may not operate above 30,000 feet. The crossfeed and cross cooling valves open automatically.</p>	<ol style="list-style-type: none"> Limit corresponding afterburner usage above 30,000 feet. Check for indications of fuselage fuel leak. Monitor fuel transfer. Land as soon as practical.
<p>BRK ACCUM</p>	<ul style="list-style-type: none"> Brake accumulator pressure low (below 2,000 psi). <p>Emergency brakes may not be available.</p> <div style="text-align: center;">  </div> <p>A BRK ACCUM caution in flight is not normal and may indicate a possible leak in the isolated HYD 2B system. If the caution appears in flight, do not attempt to recharge the accumulator as this may result in additional loss of HYD 2B fluid.</p>	<ol style="list-style-type: none"> Extend landing gear as soon as practical.
<div style="border: 1px solid black; padding: 2px; display: inline-block;">CABIN</div> <p>Caution Light</p>	<ul style="list-style-type: none"> Cabin pressure altitude above 21,000 +/- 1,100 feet. <p>Cabin light may not extinguish until cabin pressure altitude is below 16,500 feet.</p> <div style="text-align: center;">  </div> <ul style="list-style-type: none"> CABIN light may appear with normal cabin pressurization when aircraft altitude is above 47,000 feet MSL. If altitude is maintained, aircrew should continuously monitor physiological condition. DCS may be experienced when operating with cabin pressure altitude above 25,000 feet even with a working oxygen system. Symptoms of DCS include pain in joints, tingling sensations, dizziness, paralysis, choking, and/or loss of consciousness. 	<p>BELOW 47,000 FEET MSL</p> <ul style="list-style-type: none"> *1. Emergency oxygen green ring(s) - PULL *2. OXY FLOW knob(s) - OFF *3. Initiate rapid descent to below 10,000 feet cabin altitude. 4. CABIN PRESS switch - CHECK NORM 5. ECS MODE switch - CHECK AUTO <p>If DCS or hypoxia symptoms present -</p> <ol style="list-style-type: none"> Maintain altitude below 10,000 feet MSL. Land as soon as possible. <p>If DCS or hypoxia symptoms not present -</p> <ol style="list-style-type: none"> Reset emergency oxygen system and resume normal OBOGS operation. Maintain altitude below 25,000 feet MSL. Land as soon as practical. <p>ABOVE 47,000 FEET MSL</p> <ol style="list-style-type: none"> Continuously monitor physiological conditions and cabin pressure altimeter.

Figure 12-1. Warning/Caution/Advisory Displays (Sheet 11)

DDI Cautions and Caution Lights

INDICATOR	• CAUSE / REMARKS	CORRECTIVE ACTION
<p>CANOPY</p>	<ul style="list-style-type: none"> • Canopy not down and locked. <p>In the F/A-18F, rear seat occupant should lower seat and lean as far forward as possible in case the canopy departs the aircraft.</p>	<p>IN FLIGHT</p> <ol style="list-style-type: none"> 1. CANOPY switch - CONFIRM DOWN 2. Slow below 300 KCAS, 200 KCAS in F/A-18F (if practical). 3. Maintain altitude below 25,000 feet. 4. CABIN PRESS switch - RAM/DUMP 5. CANOPY switch - DOWN 6. CABIN PRESS switch - NORM <p>If light stays on -</p> <ol style="list-style-type: none"> 7. Land as soon as practical.
<p>CAUT DEGD</p>	<ul style="list-style-type: none"> • Capability to display cautions degraded. <p style="text-align: center;">NOTE</p> <p>LOTs 21-24: Back-up TOTAL fuel quantity value may be reset to zero following MC1 power cycle. If fuel quantity information is critical and other MC functions appear to be working normally, MC1 power cycle is not recommended.</p> <p>Cautions may be false or erratic.</p>	<ol style="list-style-type: none"> 1. FUEL page/SDC - RESET 2. MC1 - CYCLE to 1 OFF then NORM <p>If caution remains or reappears -</p> <ol style="list-style-type: none"> 3. Land as soon as practical.
<p>CHECK SEAT</p> <div style="border: 1px solid black; padding: 2px; display: inline-block;">CK SEAT</div> <p>Caution Light</p>	<ul style="list-style-type: none"> • With WonW, one or both ejection seats are not armed when both throttles are advanced beyond 27° THA. 	<ol style="list-style-type: none"> 1. Ejection seat SAFE/ARMED handle(s) - CHECK ARMED <p>If caution remains -</p> <ol style="list-style-type: none"> 2. Do not takeoff.
<p>CHECK TRIM</p>	<ul style="list-style-type: none"> • With WonW, trim is not set for takeoff. <p>The caution is displayed when both throttles are advanced beyond 27° THA if the stabilators are trimmed less than 3.5° TEU with the launch bar up (field takeoff) or 6.5° TEU with the launch bar down (carrier takeoff).</p>	<ol style="list-style-type: none"> 1. T/O TRIM button - PRESS UNTIL TRIM ADVISORY DISPLAYED (stabilators 4° NU) <p>If carrier-based -</p> <ol style="list-style-type: none"> 2. TRIM - SET FOR CATAPULT LAUNCH
<div style="border: 1px solid black; padding: 2px; display: inline-block;">CK ECS</div> <p>Caution Light</p>	<ul style="list-style-type: none"> • ECS MODE switch - OFF/RAM • CABIN PRESS switch - DUMP or RAM/DUMP • BLEED AIR knob - OFF 	<ol style="list-style-type: none"> 1. ECS MODE/CABIN PRESS switches/BLEED AIR knob - CHECK POSITION
<p>CK FLAPS</p>	<ul style="list-style-type: none"> • With WonW, flaps are not set for takeoff. <p>The caution is displayed when both throttles are advanced beyond 27° THA with the FLAP switch not in HALF and the launch bar up (field takeoff) or with the FLAP switch not in FULL and the launch bar down (carrier takeoff).</p>	<p>If shore-based -</p> <ol style="list-style-type: none"> 1. FLAP switch - HALF <p>If carrier-based -</p> <ol style="list-style-type: none"> 1. FLAP switch - FULL

Figure 12-1. Warning/Caution/Advisory Displays (Sheet 12)

DDI Cautions and Caution Lights

INDICATOR	• CAUSE / REMARKS	CORRECTIVE ACTION
CNI	<ul style="list-style-type: none"> • CSC MUX FAIL or CNI interface failure. • May also be caused by an MPCD malfunction. <p>MPCD and UFCD may not operate in some or all modes. If CSC indicates MUX FAIL, the VOICE/AUR, FCS, and G-LIM 7.5G cautions are also set, and the following equipment is inoperative: RALT, CFIT protection Voice alerts COMM control except by UFC BU TACAN, beacon, IFF SDC RESET function LOCK/SHOOT lights TACTS functions ILS control except by ILS panel EMCON control</p>	<ol style="list-style-type: none"> 1. BIT page - CHECK CSC and MPCD BIT STATUS <p>If MPCD indicates DEGD -</p> <ol style="list-style-type: none"> 2. MPCD knob - OFF, wait 15 seconds, ON
L DC FAIL R DC FAIL	<ul style="list-style-type: none"> • All three PMG outputs have failed on the corresponding side. • May indicate a power transmission shaft failure if accompanied with the corresponding BOOST LO, GEN, and both HYD circuit cautions. <p>The affected FCC channels are powered by the essential bus. One level of redundancy for the essential bus is lost.</p>	<ol style="list-style-type: none"> 1. Electrical RESET button - PRESS <p>If caution clears -</p> <ol style="list-style-type: none"> 2. Continue normal operations. <p>If caution remains -</p> <ol style="list-style-type: none"> 2. Land as soon as practical.
DEPLOY	<ul style="list-style-type: none"> • The RFCM is in AUTO, PPLAN, or SEMI and DCOY is selected without a decoy out. <p>The RFCM cannot respond to a threat using the decoy.</p>	<ol style="list-style-type: none"> 1. Either dispense a decoy (consent) or unbox DCOY on EW page.
L DEVC BLD R DEVC BLD	<ul style="list-style-type: none"> • A hot air leak from the inlet device anti-ice system has been detected. <p>Inlet device anti-ice capability degraded or lost.</p> <div style="text-align: center;">  </div> <p>If not secured, a hot air leak can cause structural damage to the inlet device and possible engine FOD.</p>	<p>If not in icing conditions -</p> <ol style="list-style-type: none"> 1. ENG ANTI ICE switch - OFF <p>If caution remains with switch OFF -</p> <ol style="list-style-type: none"> 2. Throttle affected engine - IDLE 3. Land as soon as practical.
DFIR OVRHT	<ul style="list-style-type: none"> • DFIRS reporting an overtemperature condition. 	Information
DFIRS GONE	<ul style="list-style-type: none"> • DFIRS inadvertently deployed. 	<p>Unless visually confirmed intact -</p> <ol style="list-style-type: none"> 1. Land as soon as practical.

Figure 12-1. Warning/Caution/Advisory Displays (Sheet 13)

DDI Cautions and Caution Lights

INDICATOR	• CAUSE / REMARKS	CORRECTIVE ACTION
DUMP OPEN	<ul style="list-style-type: none"> Fuel dump valve open with DUMP switch in OFF. <p>If the dump valve cannot be closed, fuel continues to dump until Tanks 1 and 4 are empty. Selecting WING INHIBIT diverts recirculation fuel from the wings to the feed tanks. Stopping external transfer may make this fuel available if the dump valve is subsequently closed. When uncommanded fuel dump ceases (Tanks 1 and 4 empty), the feed tanks should contain between 4,200 and 4,900 lb, depending on JLS cycling.</p> <p>Delaying landing until the transfer tanks are empty and uncommanded fuel dump ceases will prevent fuel from dumping onto hot exhaust nozzles and fouling of the landing area.</p>	<ol style="list-style-type: none"> DUMP switch - CYCLE BINGO setting - Set above internal fuel state. <p>If caution remains -</p> <ol style="list-style-type: none"> INTR WING switch - INHIBIT <p>If external fuel also remains -</p> <ol style="list-style-type: none"> EXT TANKS switch(es) - STOP Land as soon as possible. <p>When capacity available in feed tanks -</p> <ol style="list-style-type: none"> EXT TANKS switches - NORM <p>If fuel continues to dump on deck -</p> <ol style="list-style-type: none"> Turn aircraft into the wind. Throttles - OFF <p>If caution removed -</p> <ol style="list-style-type: none"> EXT TANKS switch(es) - CHECK NORM
ECS ICING	<ul style="list-style-type: none"> The ECS compressor/turbine is icing (e.g., an ECS valve failure or malfunction in the warm air system which normally prevents ECS icing occurred). ECS controller failure with altitude below 30,000 feet (ECS DEGD, MSP 8A0 or 8A1). ECS icing sensor failure with altitude below 30,000 feet (MSP 8E1). <p>For a sensor or ECS controller failure, the caution is inhibited above 30,000 feet, since insufficient moisture is present to cause ECS icing.</p> <p>The ECS system incorporates a bypass valve designed to prevent ECS compressor/turbine failure when icing occurs. Depending on the severity of the failure which caused the icing condition, the capacity of the bypass valve may be exceeded. If an ECS ICING caution appears (without MSPs 8A0, 8A1, or 8E1), there is one of two outcomes: (1) bypass, in which case the system needs to be de-iced but the ECS continues to function or (2) the ECS compressor/turbine fails and conditioned ECS airflow is lost (loss of cabin pressurization and AV AIR HOT caution).</p> <p>The ECS ICING caution may or may not be removed after selecting OFF/RAM.</p> <div style="text-align: center; border: 1px solid black; padding: 5px; width: fit-content; margin: 10px auto;"> <p>WARNING</p> </div> <p>Selection of MAN with the ECS MODE switch is prohibited. Selecting MAN while the aft cooling fan shutoff valve is open may cause the fan to overspeed resulting in a catastrophic fan failure potentially leading to loss of OBOGS.</p>	<p>GROUND</p> <ol style="list-style-type: none"> Throttles - IDLE BLEED AIR knob - OFF ECS MODE switch - OFF/RAM Do not takeoff. <p>IN FLIGHT</p> <ol style="list-style-type: none"> MSP codes - CHECK <p>If MSP 8A0 or 8A1 (ECS control failure) or 8E1 (sensor failure) present -</p> <ol style="list-style-type: none"> Throttles - Minimum practical (to reduce cabin pressurization surge) BIT/HYDRO-MECH/ECS RESET option - SELECT <p>If ECS continues to operate (good pressurization and no AV AIR HOT caution) -</p> <ol style="list-style-type: none"> ENG page - SELECT Airspeed - Increase to at least 0°C INLET TEMP (if possible) <p>If ECS fails (pressurization lost or AV AIR HOT caution) -</p> <ol style="list-style-type: none"> Maintain altitude below 25,000 feet (20,000-25,000 feet optimum for cooling). Maintain airspeed below 325 KCAS (300 to 325 KCAS optimum for cooling). ECS MODE switch - OFF/RAM AV COOL switch - EMERG CABIN TEMP knob - FULL COLD (cabin pressure altitude slowly increases) <p>If AV AIR HOT caution appears -</p> <ol style="list-style-type: none"> Non-essential avionics equipment - OFF (e.g., RADAR, UFCO controlled avionics, ECM, sensors, MC2). Land as soon as possible. <p>Otherwise -</p> <ol style="list-style-type: none"> Land as soon as practical.

Figure 12-1. Warning/Caution/Advisory Displays (Sheet 14)

DDI Cautions and Caution Lights

INDICATOR	• CAUSE / REMARKS	CORRECTIVE ACTION
<p>L EGT HIGH R EGT HIGH</p> <p>"Engine Left (Right), Engine Left (Right)"</p>	<ul style="list-style-type: none"> Designated exhaust gas temperature out of limits. 	<p>*1. Throttle affected engine - IDLE If caution remains at IDLE or engine response is abnormal -</p> <ol style="list-style-type: none"> Throttle affected engine - OFF Refer to Single Engine Approach and Landing procedure. <p>If caution clears -</p> <ol style="list-style-type: none"> Land as soon as practical. Consider HALF flap approach for landing.
<p>L ENG R ENG</p> <p>"Engine Left (Right) Engine Left (Right)"</p>	<ul style="list-style-type: none"> Abnormal engine condition due to a failure(s) in the engine control system. The failure(s) result in a change in ENG STATUS on the ENG page: <ol style="list-style-type: none"> PERF90 - 10 % or less thrust loss and/or slower engine transients. AB is not inhibited. AB FAIL - No afterburner capability. THRUST - Engine thrust limited to between 40 % and 90 % and significantly slower transients. IDLE - Engine limited to idle power. SHUTDN - Engine automatically shutdown. <div style="text-align: center; border: 2px solid black; padding: 5px; width: fit-content; margin: 10px auto;"> <p>WARNING</p> </div> <p>If ENG STATUS has changed, a FADEC reset should not be attempted, particularly airborne, as any degrade in ENG STATUS is most likely indicative of the failure of a mechanical component. Under these conditions, the engine may fail to restart following shutdown and FADEC reset attempt.</p> <p>With an ENG STATUS of PERF90, AB FAIL, THRUST, or IDLE, engine performance is degraded, but the FADEC is still controlling the engine and there are NO throttle restrictions.</p> <p>A FADEC reset should not normally be attempted.</p>	<p>GROUND</p> <ol style="list-style-type: none"> Do not takeoff. <p>IN FLIGHT</p> <p>*1. Throttle affected engine - IDLE</p> <ol style="list-style-type: none"> ENG page - Determine ENG STATUS <p>If PERF 90, ABFAIL, THRUST, or IDLE -</p> <ol style="list-style-type: none"> Use throttles as required. Land as soon as practical. <p>For landing -</p> <ol style="list-style-type: none"> FLAP switch - HALF (THRUST or IDLE) Assess throttle response in the landing configuration. <p>If SHUTDN -</p> <ol style="list-style-type: none"> Throttle affected engine - OFF Refer to Single Engine Approach and Landing procedure. <p>If SHUTDN and operational necessity dictates -</p> <ol style="list-style-type: none"> Throttle affected engine - OFF Reset lined out FADEC by commanding a channel transfer. <p>If caution clears -</p> <ol style="list-style-type: none"> Attempt affected engine restart.
<p>L ENG VIB R ENG VIB</p> <p>"Engine Left (Right) Engine Left (Right)"</p>	<ul style="list-style-type: none"> Excessive engine vibration in either the fan or compressor section of the engine. <ul style="list-style-type: none"> FAN VIB greater than 1.6 ips CORE VIB greater than 2.2 ips 	<p>*1. Throttle affected engine - IDLE If caution remains at IDLE -</p> <ol style="list-style-type: none"> Throttle affected engine - OFF Refer to Single Engine Approach and Landing procedure. <p>If caution removed and engine is required -</p> <ol style="list-style-type: none"> Throttle - Advance slowly, maintaining vibration level below the caution threshold.
<p>ERASE FAIL</p>	<ul style="list-style-type: none"> A component which contains classified information has reported a critical failure which may prevent successful erasure of stored classified data. 	<p>Information</p>

Figure 12-1. Warning/Caution/Advisory Displays (Sheet 15)

DDI Cautions and Caution Lights

INDICATOR	• CAUSE / REMARKS	CORRECTIVE ACTION
EXT TANK	<ul style="list-style-type: none"> External tanks are pressurized with WonW (EXT TANKS switch(es) in ORIDE). External tanks over pressurized with WoffW. <p>External tank pressurization is terminated for in-flight refueling (PROBE switch in EXTEND) and for arrested landing (both HOOK and LDG GEAR handles down).</p> <p style="text-align: center;">NOTE</p> <p>Carrier launch prohibited with less than 2,700 lbs (1,700 lbs for ARS) and greater than 100 lbs in external drop tank.</p>	<p>GROUND</p> <ol style="list-style-type: none"> EXT TANKS switch(es) - VERIFY NORM <p>If caution remains -</p> <ol style="list-style-type: none"> Do not catapult. <p>IN FLIGHT</p> <ol style="list-style-type: none"> EXT TANKS switch(es) - STOP (when external transfer complete)
EXT XFER	<ul style="list-style-type: none"> One or more external tanks failed/slow to transfer when commanded. <p>The EXT XFER caution can be set, even if no failures exist, if the external fuel tanks do not transfer at the same rate. During normal external fuel transfer, fuel quantity splits between external tanks may be as much as 2,000 lbs. with the centerline tank usually transferring slower than the wing tank(s). As long as external fuel transfer keeps the internal fuel tanks full (greater than 12,000 lbs), no corrective action is required.</p> <p>Icing may occur in the external fuel tank pressurization system inhibiting external tank transfer and refueling. Descending and accelerating may reduce the effects of icing.</p> <p>Failure to transfer may also affect ability to refuel affected tank(s). If in-flight refueling is required, consider inhibiting refueling of external tank(s) that set the caution and were slow to transfer (corresponding EXT TANKS switch to STOP).</p> <div style="border: 2px solid black; padding: 5px; text-align: center; width: fit-content; margin: 10px auto;">WARNING</div> <p>When in 5-wet loading, if fuel is transferred from IB tanks before MB tanks are empty, failure to maintain airspeed below 300 KCAS/0.6 IMN, whichever is less, may result in aircraft structural damage.</p> <p style="text-align: center;">NOTE</p> <p>In the event that an ARS Control Panel is installed in the aircraft, the TRANS switch on the ARS Control Panel overrides the FUEL panel.</p>	<ol style="list-style-type: none"> FUEL page/EFD - IDENTIFY EXT TANK WITH TRAPPED FUEL <p>Perform the following steps while monitoring fuel transfer, tank quantities, and lateral asymmetry -</p> <ol style="list-style-type: none"> EXT TANKS switch(es) - ORIDE EXT TANKS switch(es) - CYCLE TO STOP AND BACK TO ORIDE EXT TANKS switch(es) - NORM PROBE switch - CYCLE Apply positive and negative g. FUEL page/SDC - RESET <p>If practical -</p> <ol style="list-style-type: none"> Descend below freezing level and repeat steps 2 thru 7. If below 10,000 feet MSL, BLEED AIR knob - CYCLE THRU OFF TO NORM LDG GEAR and HOOK handles - DOWN LDG GEAR and HOOK handles - UP Perform in-flight refueling. <p>If 5-wet loading and fuel is transferred from IB tanks before MB tanks are empty -</p> <ol style="list-style-type: none"> Airspeed - Maintain below 300 KCAS/0.6 IMN, whichever is less. <p>If a MB tank is trapped near full -</p> <ol style="list-style-type: none"> SELECT JETT failed tank or control fuel transfer to prevent exceedance of 29,000 ft-lb lateral weight asymmetry limit. <p>If/when transfer complete but prior to landing -</p> <ol style="list-style-type: none"> EXT TANKS switch(es) - NORM <p>If external wing tank fuel trapped -</p> <ol style="list-style-type: none"> Ensure lateral asymmetry within limits for landing. <p>FOR CARRIER LANDING -</p> <p>If IB or C/L tank(s) over 800 lb/ARS or MB tank(s) over 500 lb -</p> <ol style="list-style-type: none"> Divert or SELECT JETT non-transferring tank(s).

Figure 12-1. Warning/Caution/Advisory Displays (Sheet 16)

DDI Cautions and Caution Lights

INDICATOR	• CAUSE / REMARKS	CORRECTIVE ACTION
FADEC HOT	<p>WonW, both engines shutdown -</p> <ul style="list-style-type: none"> Left or right engine FADEC indicates an overheat condition. <p>-----</p> <p>WonW, IDLE or above -</p> <ul style="list-style-type: none"> Insufficient fuel flow through the FADEC for adequate cooling. 	<p>WonW, both engines shutdown -</p> <ol style="list-style-type: none"> Discontinue any electrical power to FADECs for 30 to 60 minutes. Do not attempt engine start. <p>After the cooling period and prior to any FADEC operation -</p> <ol style="list-style-type: none"> Confirm absence of engine related MSP codes. <p>-----</p> <p>WonW, IDLE or above -</p> <ol style="list-style-type: none"> Both engines - SHUTDOWN
<p>L FLAMEOUT R FLAMEOUT</p> <p>“Engine Left (Right), Engine Left (Right)”</p>	<ul style="list-style-type: none"> Designated engine flamed out. Ignition automatic with throttle at or above IDLE whenever flameout sensed. <p>Single Engine Flameout</p> <ul style="list-style-type: none"> Accessories lost on corresponding side by indication: <ul style="list-style-type: none"> - BOOST LO caution - HYD cautions - GEN and/or DC FAIL cautions - AMAD PR caution One generator supplies sufficient power to operate all systems. As corresponding HYD pressure decays below 900 psi, aileron, rudder, and LEF switching valves function (typically within 2 seconds). If any FCS X's appear, there is no hazard with multiple FCS reset attempts to regain the Xd surface. If a windmilling engine causes HYD pressure to fluctuate between 800 and 2,000 psi, the switching valves cycle between their primary and backup circuits. If this occurs, reduce airspeed until hydraulic pressure fluctuations cease. <p>Dual Engine Flameout</p> <ul style="list-style-type: none"> Generators drop off line as rpm decays through 60 %. Stand-by instruments must be used. EFD only displays RPM and EGT. PMGs supply power to run flight controls down to approximately 20 % N2 (battery below 20 %) 	<p>SINGLE ENGINE FLAMEOUT</p> <p>*1. Throttle affected engine - IDLE</p> <p>If rpm continues to decrease with increasing EGT (failed auto-restart) -</p> <ol style="list-style-type: none"> Throttle affected engine - OFF Refer to Single Engine Approach and Landing procedure. <p>If engine auto-restarts -</p> <ol style="list-style-type: none"> Check engine response at safe altitude. Land as soon as practical.
FLIR OVRHT	<ul style="list-style-type: none"> Targeting FLIR internal overheat detected. 	<ol style="list-style-type: none"> FLIR switch - OFF (if practical)

Figure 12-1. Warning/Caution/Advisory Displays (Sheet 17)

DDI Cautions and Caution Lights

INDICATOR	• CAUSE / REMARKS	CORRECTIVE ACTION
<p>L FUEL HOT R FUEL HOT</p>	<ul style="list-style-type: none"> Engine FUEL INLET TEMP high (>121°C). Engine FUEL NOZ TEMP high (>177°C). FEED TANK TEMP high. WoffW: ≥ 60°C for 10 min or >65°C for 15 sec WonW: ≥ 80°C for 15 sec (<5,000 lb fuel) ≥ 60°C for 10 min or >65°C for 15 sec (>5,000 lb fuel) Parameter which triggered FUEL HOT caution should be highlighted in red on ENG page. - In LOT 26 and up, the feed tank temperature limits that trigger a FUEL HOT caution differ for in-flight and on-deck conditions. Fuel system should provide adequate cooling for FA-DECs and subsystem accessories under normal ambient conditions. Fuel system temperature can approach limits under extremely hot ambient conditions (>103°C) particularly during extended low altitude flight or with low fuel states. If corresponding THERMAL caution appears, the fuel thermal management system has lost the capability to regulate fuel system temperatures. Increasing fuel flow may not have the desired effect of reducing fuel system temperatures. 	<p>PREFLIGHT 1. Throttle affected engine - OFF</p> <p>IN FLIGHT 1 RADAR knob - STBY (if practical) Without a THERMAL caution - 2. Throttle affected engine - Increase fuel flow above 3,500 pph. (MIL power optimum) and maintain at least 80% N₂ rpm whenever possible. 3. Land as soon as practical. With either THERMAL caution - 2. Throttle (THERMAL caution side) - OFF 3. Consider restarting affected engine for landing. • Engine Restart • Single Engine Approach and Landing</p> <p>POSTFLIGHT 1 RADAR knob - OFF If caution remains for more than 5 minutes- 2. Throttle (THERMAL caution side) - OFF</p>
<p>L FUEL INLT R FUEL INLT</p>	<ul style="list-style-type: none"> The designated fuel/air heat exchanger is leaking, and the fuel system has failed to shut off flow to the heat exchanger. <p>Due to fuel/air heat exchanger location (above the engine inlet), engine fuel ingestion is possible if fuel flow is not immediately secured.</p> <div style="border: 2px solid black; padding: 5px; text-align: center; width: fit-content; margin: 10px auto;">WARNING</div> <p>Failure to secure an engine with an unisolated fuel/air heat exchanger leak may result in catastrophic engine failure and/or fire.</p>	<p>*1. Throttle affected engine - OFF *2. FIRE light affected engine - PUSH 3. Land as soon as possible.</p>
<p>FUEL LO</p> <div style="border: 2px solid black; padding: 2px; display: inline-block;">FUEL LO</div> <p>"Fuel Low, Fuel Low"</p>	<ul style="list-style-type: none"> At least one feed tank below 1,125 lb. May also be an indication of a fuel transfer failure. May indicate fuselage fuel leak. Sideslip may be required to transfer wing fuel. <p>If a low level indication was caused by a transient condition such as prolonged negative g flight, the FUEL LO caution remains for 60 seconds after the low level indication has cleared.</p> <div style="border: 2px solid black; padding: 5px; text-align: center; width: fit-content; margin: 10px auto;">WARNING</div> <p>If the FUEL LO caution remains displayed, aircrew must assume that at least one feed tank is below approx. 1,125 lb regardless of displayed fuel quantity.</p>	<p>1. Throttles - REDUCE FUEL FLOW (IF PRACTICAL) 2. Land as soon as possible. 3. Check for fuel transfer failure indications. If trapped fuel indicated - 4. EXT TANKS - CHECK 5. Avoid negative g maneuvering.</p>

Figure 12-1. Warning/Caution/Advisory Displays (Sheet 18)

DDI Cautions and Caution Lights

INDICATOR	• CAUSE / REMARKS	CORRECTIVE ACTION
<p>FUEL XFER</p>	<ul style="list-style-type: none"> • Internal wing tank fuel asymmetry exceeds 350 lb. • Tank 1 and 4 fuel is not scheduling properly (e.g., Tank 4 full and Tank 1 empty). <p>INTERNAL WING TANK FAILURE</p> <ul style="list-style-type: none"> • Most likely result of a valve failure. • If one internal wing tank fails to transfer, the other is commanded to stop transferring when wing tank balance logic detects a 200 lb split. • When Tank 4 drops to approximately 3,000 lb, the SDC declares a wing transfer failure, cancels wing balance logic, and reinitiates transfer from the good internal wing tank. • All fuel from the failed internal wing tank should gravity transfer with the aid of bank angle changes or a steady sideslip. • Selecting INTR WING INHIBIT isolates normal wing transfer/ refuel and diverts recirculation fuel to the feed tanks. <p>TANK 1 TRANSFER FAILURE</p> <ul style="list-style-type: none"> • Tank 1 fails to stop transfer (pump and/or valve failure) • Tank 1 depletes as soon as the feed tanks can accept its fuel causing FUEL XFER caution. • Assuming normal Tank 4 transfer, caution is removed when Tank 4 depletes to approximately 2,100 lb. <p>TANK 4 TRANSFER FAILURE</p> <ul style="list-style-type: none"> • Tank 4 fails to transfer (pump failure). • Tank 1 also stops transferring when it reaches the fuel transfer schedule (approximately 1,000 lb). • Tank 4 continuously gravity transfers to Tank 3 and, when feed tank balance logic is initiated, to Tank 2 using scavenge pump. • The last 1,000 lb of Tank 1 transfers when Tank 2 cycles in and out of FUEL LO. • With Tank 4 near full, the FUEL XFR caution is set when Tank 1 drops below 400–500 lb. 	<ol style="list-style-type: none"> 1. FUEL page - Check wing and transfer tanks <p>If wing asymmetry exceeds 350 lb -</p> <ol style="list-style-type: none"> 2. Monitor wing tank transfer. 3. Roll heavy wing up 5° (if required). <p>If one wing still fails to transfer or when both wings below approximately 200 lb -</p> <ol style="list-style-type: none"> 4. INTR WING switch - INHIBIT 5. Recalculate lateral weight asymmetry if wings are split for landing. 6. Land as soon as practical. <p>If Tank 1 empty & Tank 4 full -</p> <ol style="list-style-type: none"> 2. INTR WING switch - INHIBIT 3. Monitor Tank 1 and 4 transfer. 4. Land as soon as practical.

Figure 12-1. Warning/Caution/Advisory Displays (Sheet 19)

DDI Cautions and Caution Lights

INDICATOR	• CAUSE / REMARKS	CORRECTIVE ACTION
<p>L GEN R GEN</p> <div style="border: 1px solid black; display: inline-block; padding: 2px;">L GEN</div> <div style="border: 1px solid black; display: inline-block; padding: 2px; margin-left: 10px;">R GEN</div> <p>Caution Lights</p>	<ul style="list-style-type: none"> • Designated generator ac power source is off line. <p>May indicate a power transmission shaft failure if accompanied with the corresponding BOOST LO, DC FAIL, and both HYD circuit cautions.</p> <p>SINGLE GEN FAILURE</p> <ul style="list-style-type: none"> • Either generator is capable of powering the entire electrical load of the aircraft. <p>DUAL GEN FAILURE</p> <ul style="list-style-type: none"> • Primary failure indications: <ul style="list-style-type: none"> - Loss of all displays - Loss of cabin pressurization (both bleed valves close) • GEN caution lights are inop. • May be caused by a fault in the RADAR. • Standby flight instruments must be used and EFD only displays RPM and EGT. • COMM 1 (last frequency), G XMT, and IFF EMERG available. • Gear must be emergency extended. • Anti-skid inoperative. • PMGs are powering FCC channels and essential bus indefinitely if: <ul style="list-style-type: none"> - Battery gauge indicates 28 vdc (LOT 22 and up), or - BATT SW caution light is out (LOT 21) • Only 5 to 10 minutes of battery power remains to power essential bus and the FCCs if: <ul style="list-style-type: none"> - Battery gauge indicates 24 vdc or below (LOT 22 and up), or - BATT SW caution light is on (LOT 21) • Refer to Emerg Pwr Dist chart for inoperative equipment. <p>SINGLE GEN FAILURE AND AMAD PR</p> <ul style="list-style-type: none"> • A single GEN failure accompanied by an AMAD PR caution on the same side is a potential indication of major mechanical damage to the generator and AMAD. 	<p>SINGLE GEN FAILURE</p> <ol style="list-style-type: none"> 1. GEN switch - CYCLE <p>If GEN fails to reset -</p> <ol style="list-style-type: none"> 2. Electrical RESET button - PRESS <p>If GEN still failed -</p> <ol style="list-style-type: none"> 3. GEN switch - OFF 4. Land as soon as practical. <p>DUAL GEN FAILURE</p> <ol style="list-style-type: none"> 1. RADAR knob - OFF 2. Electrical RESET button - PRESS <p>If either GEN fails to reset -</p> <ol style="list-style-type: none"> 3. Failed GEN switch(es) - CYCLE <p>If both GENs remain inop -</p> <ol style="list-style-type: none"> 4. Battery gauge - CHECK (BATT SW caution light - CHECK in LOT 21) <p>If gauge reads 28 vdc (BATT SW caution light out in LOT 21)-</p> <ol style="list-style-type: none"> 5. Land as soon as practical. <p>For landing -</p> <ol style="list-style-type: none"> 6. IFF MASTER switch - EMERG 7. G XMIT switch - COMM 1 (if required) 8. Refer to Landing Gear Emergency Extension procedure. 9. Make a short field arrestment (if available). 10. Use emergency brakes with steady brake pressure. (Anti-skid is not available.) <p>If gauge reads 24 vdc or below (BATT SW caution light on in LOT 21) -</p> <ol style="list-style-type: none"> 5. Land as soon as possible using "For landing" procedures. <p>SINGLE GEN FAILURE AND AMAD PR</p> <ol style="list-style-type: none"> 1. GEN switch - OFF (DO NOT RESET) 2. Throttle affected engine - OFF immediately (if practical) 3. Land as soon as practical. 4. Execute Single Engine Approach and Landing procedure.

Figure 12-1. Warning/Caution/Advisory Displays (Sheet 20)

DDI Cautions and Caution Lights

INDICATOR	• CAUSE / REMARKS	CORRECTIVE ACTION														
<p>GEN TIE</p> <p>Caution Light</p>	<ul style="list-style-type: none"> • Left and right 115 vac buses are isolated (bus tie open). • May be caused by electrical fault protection circuitry. • May be caused by initial engine start with the PARK BRK released. <p style="text-align: center;">CAUTION</p> <p>If the left and right buses are isolated because of a detected fault, cycling the GEN TIE CONTROL switch reenergizes the faulty bus/equipment and may cause further damage or loss of the remaining generator.</p>	<p>GROUND If PARK BRK released during first engine start - Battery Start 1. PARK BRK handle - SET 2. Operating GEN switch - CYCLE 3. Start second engine. External Power Start 1. PARK BRK handle - SET 2. GEN TIE CONTROL switch - CYCLE 3. Start second engine.</p> <p>IN FLIGHT 1. GEN TIE CONTROL switch - NORM (DO NOT CYCLE) If both GENs operating - 2. Do not attempt to reset GEN TIE. 3. Continue mission with GEN TIE on. With L or R GEN caution light - 2. GEN switch affected side - CYCLE 3. Electrical RESET button - PRESS If GEN restored - 4. Do not attempt to reset GEN TIE. 5. Continue mission with GEN TIE on. If GEN still failed - 4. GEN switch affected side - OFF 5. Land as soon as practical. 6. Refer to Emergency Power Distribution chart.</p>														
<p>G-LIM 7.5G</p> <p>"Flight Controls, Flight Controls"</p>	<ul style="list-style-type: none"> • Nz REF (g-command limiter) set to 7.5g regardless of gross weight. <p>G-command limiter will not prevent an aircraft overstress at gross weights above 42,097 lb. Above 42,097 lb gross weight, pilot must limit g to prevent an overstress.</p> <p>Normally, for aircraft gross weights of 42,097 lb to 57,405 lb, Nz REF is reduced by the FCS to prevent aircraft overstress. Above aircraft gross weight of 57,405 lb, the FCS maintains 5.5g.</p>	<p>1. Limit symmetrical accelerations to the following:</p> <table border="1" style="margin-left: auto; margin-right: auto;"> <thead> <tr> <th>GW (lb)</th> <th>Acceleration (g)</th> </tr> </thead> <tbody> <tr> <td>≤42,097</td> <td>-3.0 to +7.5</td> </tr> <tr> <td>45,000</td> <td>-2.8 to +7.0</td> </tr> <tr> <td>50,000</td> <td>-2.5 to +6.3</td> </tr> <tr> <td>55,000</td> <td>-2.3 to +5.7</td> </tr> <tr> <td>60,000</td> <td>-2.1 to +5.2</td> </tr> <tr> <td>66,000</td> <td>-1.9 to +4.7</td> </tr> </tbody> </table>	GW (lb)	Acceleration (g)	≤42,097	-3.0 to +7.5	45,000	-2.8 to +7.0	50,000	-2.5 to +6.3	55,000	-2.3 to +5.7	60,000	-2.1 to +5.2	66,000	-1.9 to +4.7
GW (lb)	Acceleration (g)															
≤42,097	-3.0 to +7.5															
45,000	-2.8 to +7.0															
50,000	-2.5 to +6.3															
55,000	-2.3 to +5.7															
60,000	-2.1 to +5.2															
66,000	-1.9 to +4.7															
<p>G-LIM OVRD</p>	<ul style="list-style-type: none"> • G-limiter overridden. <p>Selected by momentarily pressing the paddle switch when the stick is near the full aft limit. Maximum allowed g-limit increased by 33% (allows a 10g command at 7.5g Nz REF). Unless g-limiter override is desired, control maximum g-level. If the paddle switch has failed electrically, NWS and the autopilot may be commanded off without pilot action or notification.</p>	<p>1. Stick - Return to near neutral to disengage override.</p>														
<p>GPS DEGD</p>	<ul style="list-style-type: none"> • GPS approach flight phase and HERR exceeds 108 feet for 10 seconds. 	<p>Information</p>														

Figure 12-1. Warning/Caution/Advisory Displays (Sheet 21)

DDI Cautions and Caution Lights

INDICATOR	• CAUSE / REMARKS	CORRECTIVE ACTION
GUN GAS	<ul style="list-style-type: none"> • Gun purge air pressure low. <div style="border: 2px solid black; padding: 5px; text-align: center; width: fit-content; margin: 10px auto;">WARNING</div> <p>Failure to purge cartridge combustion gases may result in a gun bay explosion and significant aircraft damage.</p>	<ol style="list-style-type: none"> 1. Do not fire gun, even if caution clears.
HAND CNTRL	<ul style="list-style-type: none"> • Either hand controller inoperative. 	Information
HEAT FAIL	<ul style="list-style-type: none"> • Engine anti-ice failure detected while the ENG ANTI ICE switch is ON. <p>The corresponding L HEAT or R HEAT advisory is removed on the failed side. Engine and inlet device anti-ice capability lost on failed side.</p> <p>If the ENG ANTI ICE switch is placed to OFF, the HEAT FAIL caution is replaced by the HEAT advisory.</p>	<ol style="list-style-type: none"> 1. Avoid icing conditions. <p>If icing conditions encountered -</p> <ol style="list-style-type: none"> 2. Refer to Extreme Weather procedures.
HOME FUEL	<ul style="list-style-type: none"> • Fuel remaining sufficient to fly to HOME waypoint with 2,000 lb reserve or less. <p>HOME FUEL caution logic is disabled with WonW, the refueling probe extended, the landing gear cycled down then up, or within 5 seconds after a HOME waypoint change.</p>	<ol style="list-style-type: none"> 1. Change HOME waypoint (if appropriate) or analyze configuration, fuel flow, and profile for BINGO.
ID LT	<ul style="list-style-type: none"> • A failure is detected in the day ID strobe light, interconnecting wiring, or the day ID power supply. 	<ol style="list-style-type: none"> 1. Identify aircraft type on approach to make sure of proper arresting gear weight setting.
IFF 4 "Mode 4 Reply, Mode 4 Reply"	<ul style="list-style-type: none"> • Transponder failed to respond to a valid Mode 4 interrogation (failure or Mode 4 not enabled). • Failure in the KIT 1C. • Mode 4 codes zeroized, or KIT 1C installed but not keyed with crypto. <p>The IFF 4 caution and voice alert are disabled with the IFF MODE 4 switch in the OFF position.</p>	Information
IFFAI (OFP 18E)	<ul style="list-style-type: none"> • Fault with the airborne interrogator. <p>Unable to interrogate Mode 4 or cannot interrogate any mode.</p>	<ol style="list-style-type: none"> 1. BIT/COMM/PIDS MAINT - Check Crypto Status <p>If CRYPTO lined out -</p> <ol style="list-style-type: none"> 2. Reload M4 Crypto. <p>If CRYPTO not lined out -</p> <ol style="list-style-type: none"> 2. Information: <ul style="list-style-type: none"> • IFF may be DEGD • Unable to interrogate Mode 4 • Unable to solve ROE if M4 not removed
IFF OVRHT	<ul style="list-style-type: none"> • IFF overheat detected. 	<ol style="list-style-type: none"> 1. IFF - OFF (if practical)

Figure 12-1. Warning/Caution/Advisory Displays (Sheet 22)

DDI Cautions and Caution Lights

INDICATOR	• CAUSE / REMARKS	CORRECTIVE ACTION
INLET ICE	<ul style="list-style-type: none"> • Engine inlet icing conditions detected. • INLET ICE caution comes on when 0.025 inch of ice has accumulated on the ice detector located in the left inlet. • DO NOT delay activating engine anti-ice. Any delay can result in ice accumulating rapidly on IGVs and shedding into the engine when system is turned on. • Ice accumulation on LEFs is similar to inlet lip and can serve as an indication of how much ice may be on the inlet. • As little as 0.5 inch of ice ingested by the engine can result in compressor stalls and major FOD. <p>WITH ICE CLEARLY VISIBLE ON LEFs</p> <ul style="list-style-type: none"> • Reduce throttle settings below 80 % N₂ rpm while descending below the freezing level to prevent ice shedding into the engine. • Avoid throttle transients above 90 % N₂ rpm, abrupt maneuvers, and bank angles over 20° to prevent ice from detaching from the inlet lip. <p>WITH NO ICE VISIBLE ON AIRCRAFT</p> <ul style="list-style-type: none"> • Maintain INLET TEMP of at least +5° C (+10° C preferred) to provide sufficient aerodynamic heating to prevent ice accumulation on LEFs and inlet lips. 	<ol style="list-style-type: none"> 1. ENG ANTI ICE switch - ON 2. PITOT ANTI ICE switch - ON <p>NO ICE VISIBLE ON LEFS -</p> <ol style="list-style-type: none"> 3. Airspeed - Increase until INLET TEMP is at least +5° C (+10° C preferred) on ENG page (if possible). 4. AOA - Maintain less than 6° (if possible) to prevent ice accumulation on underside of LEX. 5. Climb or descend out of icing danger zone (> 25,000 feet, or below freezing level). <p>When clear of icing conditions and caution removed -</p> <ol style="list-style-type: none"> 6. ENG ANTI ICE switch - OFF <p>ICE VISIBLE ON LEFS -</p> <ol style="list-style-type: none"> 3. Throttles - Reduce below 80 % N₂ rpm (if possible). Avoid throttle transients above 90 % N₂ rpm. 4. Airspeed - Maintain above 250 KCAS. 5. AOA - Maintain less than 6° (if possible) to prevent ice accumulation on underside of LEX. 6. Avoid abrupt maneuvers and bank angles over 20°. 7. Descend below the freezing level. <p>For landing in icing conditions -</p> <ol style="list-style-type: none"> 8. WINDSHIELD switch - ANTI ICE or RAIN (as required) 9. Reduce airspeed and lower the landing gear at the last possible moment (minimizes ice accumulation on the gear). <p>If a missed approach is necessary -</p> <ol style="list-style-type: none"> 10. Slowly advance throttles to the minimum power required for a safe waveoff. 11. Raise landing gear and flaps as soon as possible.
INS ATT	<ul style="list-style-type: none"> • HUD displayed aircraft attitude is supplied by the standby attitude indicator. <p>W replaces  on the HUD.</p> <p>GPS functions still operate.</p>	<ol style="list-style-type: none"> 1. ATT switch - STBY 2. Verify HUD pitch ladder coincides with the standby attitude reference indicator. 3. Attempt an in-flight alignment. <p>If IFA unsuccessful -</p> <ol style="list-style-type: none"> 4. Refer to HIAOA procedure.
INS DEGD	<ul style="list-style-type: none"> • INS failure detected during periodic BIT. <p>GPS function still operates.</p> <p>ABLIM function may not be available.</p>	<p>GROUND</p> <ol style="list-style-type: none"> 1. Secure and realign INS. <p>IN FLIGHT if INS information is incorrect -</p> <ol style="list-style-type: none"> 1. ATT switch - STBY 2. Verify HUD pitch ladder coincides with the standby attitude reference indicator. 3. Attempt an in-flight alignment. <p>If IFA unsuccessful -</p> <ol style="list-style-type: none"> 4. Refer to HIAOA procedure.

Figure 12-1. Warning/Caution/Advisory Displays (Sheet 23)

DDI Cautions and Caution Lights

INDICATOR	• CAUSE / REMARKS	CORRECTIVE ACTION
LADDER	<ul style="list-style-type: none"> Boarding ladder unlocked. <p>May FOD left engine.</p>	<p>IN FLIGHT</p> <ol style="list-style-type: none"> Reduce airspeed to minimum practical. Get a visual inspection (if practical). Consider shutting off left engine to prevent engine FOD. Land as soon as practical.
MC 1	<ul style="list-style-type: none"> Mission Computer 1 failed. <p>LOTS 21-24 -</p> <ul style="list-style-type: none"> The only cautions available are MC 1, HYD 1A, HYD 1B, HYD 2A, HYD 2B, NO RATS, and AUTO PILOT. GPS assisted velocity vector enhancement is disabled. G-limiter defaults to 7.5g. (G-LIM 7.5G caution is not displayed.) Roll limiting inoperative. RATS inoperative. UFCD reverts to the top level CNI page. Autopilot is inoperative. FCS page not available. <p style="text-align: center;">NOTE</p> <p>LOTS 21-24: Backup TOTAL fuel quantity value may reset to zero following MC1 power cycle. If fuel quantity information is critical, MC1 power cycle is not recommended, or note fuel state and burn prior to MC1 cycle.</p> <p>LOT 25 and up -</p> <ul style="list-style-type: none"> All cautions are available except: AIR DATA, GPS DEGD, HOME FUEL, MC CONFIG, OCS, and S/W CONFIG. G-limiter defaults to 7.5g and sets G-LIM 7.5G caution. Autopilot is inoperative. LDDI inoperative. Flaps AUTO AOA warning tone inoperative. 	<ol style="list-style-type: none"> MC switch - CYCLE to 1 OFF then NORM <p>If caution remains -</p> <p>LOTS 21-24 -</p> <ol style="list-style-type: none"> Use no more than ½ lateral stick with EFTs or A/G stores on the wings. Refer to G-LIM 7.5G and NO RATS procedures. Land as soon as practical. <p>LOTS 25 and up -</p> <ol style="list-style-type: none"> Refer to G-LIM 7.5G procedures. Manually calculate lateral weight asymmetry to determine AOA limit. Land as soon as practical. <p>All aircraft -</p> <p>If in RVSM airspace -</p> <ol style="list-style-type: none"> Notify ATC that the aircraft is no longer RVSM compliant.
MC 2	<ul style="list-style-type: none"> Mission Computer 2 failed. <p>LOTS 21-24 -</p> <p>With MC2 failed:</p> <ul style="list-style-type: none"> All cautions are available. G-limiter defaults to 7.5g and sets G-LIM 7.5G caution. Roll limiting inoperative. UFCD reverts to the top level CNI page. <p>LOT 25 and up -</p> <ul style="list-style-type: none"> All cautions are available except: AIR DATA, GPS DEGD, HOME FUEL, MC CONFIG, OCS, and S/W CONFIG. G-limiter defaults to 7.5g and sets G-LIM 7.5G caution. Autopilot is inoperative. RDDI inoperative. Flaps AUTO AOA warning tone inoperative. 	<ol style="list-style-type: none"> MC switch - CYCLE to 2 OFF then NORM <p>If caution remains -</p> <p>LOTS 21-24 -</p> <ol style="list-style-type: none"> Use no more than ½ lateral stick with EFTs or A/G stores on the wings. Refer to G-LIM 7.5G procedures. Land as soon as practical. <p>LOT 25 and up -</p> <ol style="list-style-type: none"> Refer to G-LIM 7.5G procedures. Manually calculate lateral weight asymmetry to determine AOA limit. Land as soon as practical. <p>All aircraft -</p> <p>If in RVSM airspace -</p> <ol style="list-style-type: none"> Notify ATC that the aircraft is no longer RVSM compliant.
MC CONFIG	<ul style="list-style-type: none"> OPF loaded into either MC is incorrect. 	<ol style="list-style-type: none"> Do not takeoff.

Figure 12-1. Warning/Caution/Advisory Displays (Sheet 24)

DDI Cautions and Caution Lights

INDICATOR	• CAUSE / REMARKS	CORRECTIVE ACTION
MIDS OVRHT	<ul style="list-style-type: none"> MIDS overheat condition. <p>If an overheat occurs, the MIDS will secure itself in 30 seconds unless MIDS O/H OVRD is boxed.</p> <p>If TCN or D/L turned back on, expect MIDS O/H caution to return until MIDS page activates. If MIDS O/H then remains, MIDS is still in an overheat condition.</p>	<ol style="list-style-type: none"> TCN - OFF D/L, BCN, ILS - OFF MIDS page - Verify MIDS page deactivates
MU LOAD	<ul style="list-style-type: none"> AMU/mission card problem. <p>Caution is disabled in flight.</p>	<p>LOTs 21-22 -</p> <ol style="list-style-type: none"> Verify MU is installed and seated properly. <p>If caution remains -</p> <ol style="list-style-type: none"> Do not takeoff. <p>LOT 23 and up -</p> <ol style="list-style-type: none"> Verify mission/maintenance cards installed in proper AMU slot and AMU door is closed. If accompanied by a MNTCD or MSNCD advisory, refer to MNTCD or MSNCD procedures. If not accompanied by a MNTCD or MSNCD advisory, do not takeoff.
NAV FAIL	<ul style="list-style-type: none"> Indicates functional failures of the INS, GPS, and air data functions. 	<p>GROUND</p> <ol style="list-style-type: none"> INS knob - OFF then realign (GND, CV, or IFA) <p>IN FLIGHT</p> <ol style="list-style-type: none"> Use standby instruments for altitude/airspeed/vertical velocity. Attempt an in-flight alignment. <p>If in RVSM airspace -</p> <ol style="list-style-type: none"> Notify ATC that the aircraft is no longer RVSM compliant.
NAV HVEL	<p>GPS operating and POS/AINS selected -</p> <ul style="list-style-type: none"> Aided INS and air data function horizontal velocities disagree. <p>GPS operating and POS/INS selected -</p> <ul style="list-style-type: none"> INS, GPS, or air data function horizontal velocities disagree. <p>GPS failed or inoperative -</p> <ul style="list-style-type: none"> INS and air data function horizontal velocities disagree. May be caused by high wind velocity. 	<ol style="list-style-type: none"> Crosscheck velocity vector. Crosscheck horizontal velocities on HSI/DATA/NAVCK page.
NAV VVEL	<p>INS declared invalid -</p> <ul style="list-style-type: none"> GPS and air data function vertical velocities disagree. <p>GPS declared valid -</p> <ul style="list-style-type: none"> INS and GPS vertical velocities disagree. <p>GPS declared invalid or ANAV installed and INS aided -</p> <ul style="list-style-type: none"> INS and air data function vertical velocities disagree. 	<ol style="list-style-type: none"> Crosscheck HUD velocity vector, HUD digital vertical velocity, and standby rate-of-climb indicator. If vertical velocities disagree, consider using standby attitude for landing.
NFLR OVRHT	<ul style="list-style-type: none"> NAVFLIR overheat detected. 	<ol style="list-style-type: none"> LST/NFLR switch - OFF (if practical)

Figure 12-1. Warning/Caution/Advisory Displays (Sheet 25)

DDI Cautions and Caution Lights

INDICATOR	• CAUSE / REMARKS	CORRECTIVE ACTION
NO RATS	<ul style="list-style-type: none"> • RATS not available. <p>One of the following input parameters missing/invalid: longitudinal acceleration, WonW, wheel speed, hook down position, THA.</p> <p>When single engine, RATS is not available and the NO RATS caution should be expected.</p> <p>Caution is displayed when the INS knob is OFF.</p>	<p>Carrier based -</p> <ol style="list-style-type: none"> 1. SDC - RESET 2. Cycle gear and hook (if practical). <p>If caution remains -</p> <ol style="list-style-type: none"> 3. Advise carrier of NO RATS condition. Ship should increase wind-over-deck (WOD). <p>If required WOD not available -</p> <ol style="list-style-type: none"> 4. Reduce gross weight to permit recovery with available WOD. <p>If shipboard recovery not possible -</p> <ol style="list-style-type: none"> 5. Divert. 6. Execute shore based procedure. <p>Shore based -</p> <ol style="list-style-type: none"> 1. MSP codes - CHECK for 851 <p>If set -</p> <ol style="list-style-type: none"> 2. ANTI SKID switch - OFF
<p>OBOGS DEGD</p> <p>(Cautions of any duration)</p>	<ul style="list-style-type: none"> • Oxygen concentration is below acceptable limits. • Disconnected oxygen hose. • Removing oxygen mask without placing the OXY FLOW knob to OFF. • System gas leak (broken integrity). <div style="border: 2px solid black; padding: 5px; text-align: center; width: fit-content; margin: 10px auto;">WARNING</div> <ul style="list-style-type: none"> • Good flow does not equate to good oxygen concentration. An OBOGS DEGD caution indicates that the oxygen concentration is inadequate and hypoxia may result. • Under less than optimum conditions (low altitude, heavy breathing, loose fitting mask, etc.), as few as 3 minutes of emergency oxygen may be available. 	<p>GROUND</p> <ol style="list-style-type: none"> 1. Check oxygen system integrity: <ul style="list-style-type: none"> • Mask integrity • Hose connections • OBOGS monitor pneumatic BIT plunger unlocked and fully extended <p>IN FLIGHT</p> <ol style="list-style-type: none"> *1. Emergency oxygen green ring(s) - PULL *2. OXY FLOW knob(s) - OFF *3. Initiate rapid descent to below 10,000 feet cabin altitude. 4. Check oxygen system integrity: <ul style="list-style-type: none"> • Mask integrity • Hose connections • OBOGS monitor pneumatic BIT plunger unlocked and fully extended <p>If system integrity not compromised -</p> <ol style="list-style-type: none"> 5. Maintain cabin altitude below 10,000 feet. 6. OBOGS control switch - OFF <p>Once below 10,000 feet cabin altitude and no hypoxic symptoms present -</p> <ol style="list-style-type: none"> 7. Consider removing mask and resetting emergency oxygen system or resuming normal OBOGS operation if flow appears normal and donning of mask is desired. 8. Land as soon as practical. <p>If system integrity restored -</p> <ol style="list-style-type: none"> 5. Resume normal OBOGS operation. 6. Reset emergency oxygen system.
OCS	<ul style="list-style-type: none"> • MC or SMS overlay halted due to run time. <p>Stores that require overlay may not be available.</p>	<ol style="list-style-type: none"> 1. Attempt to reload overlay.

Figure 12-1. Warning/Caution/Advisory Displays (Sheet 26)

DDI Cautions and Caution Lights

INDICATOR	• CAUSE / REMARKS	CORRECTIVE ACTION
<p>L OIL HOT R OIL HOT</p>	<ul style="list-style-type: none"> Designated ENG OIL TEMP high (149°C or above). Designated AMAD OIL TEMP high (88°C or above). <p>May be caused by: Engine malfunction, hot fuel at low fuel states, over-serviced AMAD, AMAD/fuel heat exchanger failure, fuel recirculation system failure, motive flow system failure, or with a normally operating system during extended ground operations with OAT > 103°F.</p> <div style="text-align: center; border: 2px solid black; padding: 5px; width: fit-content; margin: 10px auto;"> <p>WARNING</p> </div> <p>Prolonged operation of a hot AMAD may result in an engine bay fire.</p> <ul style="list-style-type: none"> Parameter which triggered caution should be highlighted in red on the ENG page. If OIL HOT caution caused by extended ground operations (OAT > 103°F), increasing affected engine rpm should clear the caution within 20 seconds (normal operating system). <p>AMAD OIL TEMP HIGH</p> <ul style="list-style-type: none"> Securing the GEN greatly reduces the head load imparted to AMAD OIL and may prevent heat-related damage to the generator. 	<p>PREFLIGHT</p> <ol style="list-style-type: none"> Throttle affected engine - ADVANCE ABOVE 74% rpm ENG page - Identify out of limit parameter <p>If caution removed in 20 seconds -</p> <ol style="list-style-type: none"> Continue mission, monitoring OIL TEMPs until airborne. <p>If caution remains longer than 20 seconds -</p> <ol style="list-style-type: none"> Do not takeoff. Throttle affected engine - OFF (within 5 minutes) <p>IN FLIGHT</p> <p>*1. Throttle affected engine - IDLE</p> <p>If caution removed -</p> <ol style="list-style-type: none"> Land as soon as practical. <p>If caution remains at IDLE -</p> <ol style="list-style-type: none"> ENG page - Identify out of limit parameter <p>If AMAD OIL TEMP hot -</p> <ol style="list-style-type: none"> GEN switch affected side - OFF <p>If caution remains and more than 5 minutes to landing -</p> <ol style="list-style-type: none"> Throttle affected engine - OFF Consider restarting for landing. <p>POSTFLIGHT</p> <p>If caution on for more than 5 minutes -</p> <ol style="list-style-type: none"> Throttle affected engine - OFF
<p>L OIL PR R OIL PR</p> <p>“Engine Left (Right), Engine Left (Right)”</p>	<ul style="list-style-type: none"> Designated engine oil pressure out of limits. <p>Zero oil pressure without the L/R OIL PR caution indicates the oil pressure transmitter has failed and the oil pressure switch is detecting oil pressure greater than 35 psi. Flight may be continued.</p>	<p>*1. Throttle affected engine - IDLE</p> <p>If caution remains after 15 seconds -</p> <ol style="list-style-type: none"> Throttle affected engine - OFF Refer to Single Engine Approach and Landing procedure. <p>If caution clears -</p> <ol style="list-style-type: none"> Land as soon as practical. Consider HALF flap approach for landing.
<p>L OVRSPD R OVRSPD</p> <p>“Engine Left (Right), Engine Left (Right)”</p>	<ul style="list-style-type: none"> Designated fan or compressor rpm high. 	<p>*1. Throttle affected engine - IDLE</p> <p>If caution remains at IDLE or engine response is abnormal -</p> <ol style="list-style-type: none"> Throttle affected engine - OFF Refer to Single Engine Approach and Landing procedure. <p>If caution clears -</p> <ol style="list-style-type: none"> Land as soon as practical. Consider HALF flap approach for landing.

Figure 12-1. Warning/Caution/Advisory Displays (Sheet 27)

DDI Cautions and Caution Lights

INDICATOR	• CAUSE / REMARKS	CORRECTIVE ACTION
PARK BRAKE	<ul style="list-style-type: none"> • Parking brake still set when throttles are advanced over 27° THA with the INS on. <div style="text-align: center;">  </div> <p>Even if PARK BRAKE caution is extinguished in flight, the possibility exists that the parking brake may still be engaged.</p>	<p>GROUND</p> <ol style="list-style-type: none"> 1. PARK BRK handle - RELEASE <p>IN FLIGHT</p> <ol style="list-style-type: none"> 1. PARK BRK handle - CYCLE AND CHECK FULLY STOWED <p>Whether or not the caution clears -</p> <ol style="list-style-type: none"> 2. Make a fly-in arrested landing with LSO assistance (if available).
L PITOT HT R PITOT HT	<ul style="list-style-type: none"> • Designated pitot tube, AOA probe, or AOA probe cover heater malfunction. <p>If displayed immediately after takeoff, the caution may also be an indication of a WonW proximity switch failure on the corresponding side.</p>	<ol style="list-style-type: none"> 1. PITOT ANTI ICE switch - ON <p>After landing -</p> <ol style="list-style-type: none"> 2. PITOT ANTI ICE switch - AUTO
POS/ADC	<ul style="list-style-type: none"> • INS velocities unreliable. <p>Position keeping supplied by the air data function.</p> <p>POS/ADC is not as reliable a position keeping source as the INS or GPS.</p> <p>Automatic position keeping reversion with a hierarchy of AINS, INS, GPS, MIDS (if installed) and FCC air data is provided in case of an INS and/or GPS failure.</p>	<ol style="list-style-type: none"> 1. Verify selected TCN information is loaded in TCN Data Table on HSI/DATA/TCN page. 2. Position keeping - SELECT POS/TCN
POS ERROR	<ul style="list-style-type: none"> • A present position discrepancy exists between INS position and GPS position. <p>ANAV is preventing aided navigation because horizontal position is more than 20 nm different, or vertical position is greater than 5,000 feet different.</p>	<ol style="list-style-type: none"> 1. Waypoint 0 - CHECK 2. Realign INS.
PROBE UNLK	<ul style="list-style-type: none"> • Air refueling probe not fully retracted with PROBE switch in RETRACT. 	<ol style="list-style-type: none"> 1. Airspeed - Maintain below 300 KCAS 2. PROBE switch - CYCLE
R-LIM OFF	<ul style="list-style-type: none"> • Roll rate limiting failed. 	<ol style="list-style-type: none"> 1. Use no more than ½ lateral stick with tanks or A/G stores on the wings.
RACK UNCPL	<ul style="list-style-type: none"> • BRU-32 rack(s) failed to lock or unlock during rack test. <p>Store may not be jettisonable.</p>	<p>GROUND</p> <ol style="list-style-type: none"> 1. Do not takeoff.
FIRE EXTGH <div style="border: 1px solid black; padding: 2px; display: inline-block;">READY</div> Light	<ul style="list-style-type: none"> • Fire extinguisher bottle armed. <p>FIRE light or APU FIRE light pressed.</p>	<p>If FIRE light unintentionally pressed -</p> <ol style="list-style-type: none"> 1. Identify affected FIRE light. 2. FIRE light - RESET

Figure 12-1. Warning/Caution/Advisory Displays (Sheet 28)

DDI Cautions and Caution Lights

INDICATOR	• CAUSE / REMARKS	CORRECTIVE ACTION
REFUEL DR	<ul style="list-style-type: none"> Ground refueling door not properly secured. Only activated with WonW.	1. Ensure ground crew secure door prior to takeoff. If caution remains - 2. Do not takeoff.
RIG	<ul style="list-style-type: none"> Flight controls out of rig. Only activated with WonW.	1. Do not takeoff.
S/W CONFIG	<ul style="list-style-type: none"> Software incompatible and/or engine FADEC software mismatched. Incompatible software is lined-out on the BIT/CONFIG page.	1. BIT/CONFIG page - Identify lined out system 2. Turn on affected system if not already on. 3. IBIT affected system. If caution remains - 4. Do not takeoff.
SEVER	<ul style="list-style-type: none"> JAMMER switch OFF for greater than 10 seconds with decoy deployed. (H2E and up) Deployed decoy/towline failed (electrically or mechanically) with AUTO RDPLY not selected and usable non-deployed decoy available. Cable severing signal failed to fire the squib. Landing gear or hook lowered with decoy deployed. <div style="border: 2px solid black; padding: 5px; text-align: center; width: fit-content; margin: 10px auto;"> WARNING </div> <p>Turning the JAMMER power switch to OFF with a decoy deployed (H1E and prior) will prevent subsequent activation of the SEVER caution under any of the conditions listed above. Aircrew must ensure no decoy is deployed prior to securing the JAMMER power switch.</p> <p>Sever decoy in a clear area. Once CUT/VERIFY is selected, the option is removed from the display.</p>	1. JAMMER switch - CHECK ON If gear or hook lowered - 2. EW page CUT/VERIFY options - SELECT or JAMMER switch - CUT If decoy failure and ECM required - 2. Throttle dispenser switch - UP (auto-sever and redeploy) If decoy failure and ECM not required - 2. EW page CUT/VERIFY options - SELECT or JAMMER switch - CUT If caution remains - 3. JAMMER switch - CUT 4. Get a visual inspection (if possible). If caution still remains - 5. Set 25° AOA with AB selected.

Figure 12-1. Warning/Caution/Advisory Displays (Sheet 29)

DDI Cautions and Caution Lights

INDICATOR	• CAUSE / REMARKS	CORRECTIVE ACTION
<p>L STALL R STALL</p> <p>“Engine Left (Right), Engine Left (Right)”</p>	<ul style="list-style-type: none"> • Engine stall detected on designated side. • Engine stalls result from conditions which exceed and reduce the stall margin of the engine (high AOA, steam or exhaust ingestion, engine/aircraft damage, etc.) • Engine stall indications: <ul style="list-style-type: none"> - Audible bangs - Airframe vibration - Visible flames out the exhaust and/or inlet • Self-recovering single pop or surge stalls DO NOT result in L or R STALL caution unless engine limits are exceeded. • Hung stall or multiple pop stalls (three or more in 5 seconds), will result in L or R STALL caution with following indications: <ul style="list-style-type: none"> - Lack of throttle response - Increasing EGT - Steady or decreasing rpm (rpm that continues to decrease may result in L or R FLAMEOUT caution) <p style="text-align: center;">NOTE</p> <p style="text-align: center;">A L or R STALL caution caused by a hung stall will time out after 5 seconds regardless of whether the stall has actually cleared.</p>	<ul style="list-style-type: none"> *1. Throttle affected engine - IDLE <p>If stall does not clear or L/R ENG VIB caution present -</p> <ul style="list-style-type: none"> 2. Throttle affected engine - OFF 3. Refer to Single Engine Approach and Landing procedure. <p>If stall clears -</p> <ul style="list-style-type: none"> 2. Check engine response at a safe altitude. 3. Land as soon as practical.
<p>TK PRES LO</p>	<ul style="list-style-type: none"> • Internal fuel tank pressure low above 20,000 feet. <p>Possible fuel pump cavitation and engine flameout above 40,000 feet.</p> <p>High rates of descent may damage fuel cells.</p>	<ul style="list-style-type: none"> 1. BLEED AIR knob - CYCLE THRU OFF TO NORM <p>If caution remains or reappears -</p> <ul style="list-style-type: none"> 2. Do not exceed Mach 0.9 in dive. 3. Altitude - Maintain below 40,000 feet (if practical)
<p>TK PRES HI</p>	<p>GROUND</p> <ul style="list-style-type: none"> • Internal fuel tanks pressurized with WonW. <p>Catapult may cause structural damage.</p> <p>IN FLIGHT</p> <ul style="list-style-type: none"> • Internal fuel tank pressure high. <p>Possible exceedance of tank structural limits.</p>	<p>GROUND</p> <ul style="list-style-type: none"> 1. BLEED AIR knob - OFF 2. Do not takeoff. <p>IN FLIGHT</p> <ul style="list-style-type: none"> 1. BLEED AIR knob - CYCLE THRU OFF TO NORM <p>If caution remains or reappears -</p> <ul style="list-style-type: none"> 2. Maintain +0.2 to +2.5g.

Figure 12-1. Warning/Caution/Advisory Displays (Sheet 30)

DDI Cautions and Caution Lights

INDICATOR	• CAUSE / REMARKS	CORRECTIVE ACTION
<p>L THERMAL R THERMAL</p>	<ul style="list-style-type: none"> Designated engine thermal control valve (TCV) has failed open. Fuel thermal management system has lost capability to regulate fuel system temperatures. <p>If a TCV fails open, hot feed fuel is recirculated back to the fuel tanks instead of being burned. May eventually lead to a corresponding FUEL HOT caution.</p> <p>Engine FUEL INLET TEMP high ($\geq 121^{\circ}\text{C}$). Engine FUEL NOZ TEMP high ($\geq 177^{\circ}\text{C}$). FEED TANK TEMP high.</p> <p>WoffW: $\geq 60^{\circ}\text{C}$ for 10 min or $> 65^{\circ}\text{C}$ for 15 sec WonW: $\geq 80^{\circ}\text{C}$ for 15 sec (<5,000 lb fuel) $\geq 60^{\circ}\text{C}$ for 10 min or $> 65^{\circ}\text{C}$ for 15 sec (>5,000 lb fuel)</p>	<p>GROUND</p> <ol style="list-style-type: none"> Do not takeoff. <p>IN FLIGHT</p> <ol style="list-style-type: none"> ENG page - Monitor corresponding FEED TANK TEMP, FUEL INLET TEMP, and FUEL NOZ TEMP RADAR knob - OFF Land as soon as practical. <p>If either FUEL HOT caution comes on -</p> <ol style="list-style-type: none"> Throttle (THERMAL caution side) - OFF Restart for landing.
<p>VOICE/AUR</p>	<ul style="list-style-type: none"> Voice alert or master caution aural tone inoperative. 	<ol style="list-style-type: none"> BIT page - CHECK CSC BIT status <p>If CSC MUX fail -</p> <ol style="list-style-type: none"> Refer to CNI caution procedure.
<p>WDSHLD HOT</p>	<ul style="list-style-type: none"> Windshield temperature high or sensor failed. <p>If caution remains with the switch in OFF, an ECS valve failure may be directing hot air to the windshield. In this case, securing the ECS may be the only means to stop windshield airflow.</p> <div style="text-align: center; border: 2px solid black; padding: 5px; width: fit-content; margin: 10px auto;"> <p>WARNING</p> </div> <p>Under less than optimal conditions (low altitude, heavy breathing, loose fitting mask, etc.), as few as 3 minutes of emergency oxygen may be available.</p> <div style="text-align: center; border: 2px dashed black; padding: 5px; width: fit-content; margin: 10px auto;"> <p>CAUTION</p> </div> <p>Do not operate the windshield anti-ice/rain removal system on a dry windshield. If a WDSHLD HOT caution appears, place the WINDSHIELD switch to OFF immediately to prevent heat damage to the windshield.</p>	<p>If visible moisture not present -</p> <ol style="list-style-type: none"> WINDSHIELD switch - OFF <p>If visible moisture present (ice/rain) -</p> <ol style="list-style-type: none"> WINDSHIELD switch - ANTI ICE or RAIN (for a maximum of 5 minutes) <p>If caution remains and switch OFF -</p> <ol style="list-style-type: none"> Throttles - Minimum practical Land as soon as practical. <p>If greater than 5 minutes to landing -</p> <ol style="list-style-type: none"> Emergency oxygen green ring(s) - PULL OXY FLOW knob(s) - OFF Maintain altitude below 25,000 feet MSL. BLEED AIR knob - OFF (DO NOT CYCLE) Maintain airspeed below 325 KCAS (300 to 325 KCAS optimum). ECS MODE switch - OFF/RAM AV COOL switch - EMERG EXT TANKS switch(es) - STOP Maintain altitude below 10,000 ft MSL prior to emergency oxygen depletion (10 to 20 minutes). <p>Once below 10,000 feet MSL -</p> <ol style="list-style-type: none"> Consider removing mask and resetting emergency oxygen. CABIN PRESS switch - RAM/DUMP OBOGS control switch - OFF <p>If AV AIR HOT caution appears -</p> <ol style="list-style-type: none"> Non-essential avionics equipment - OFF (e.g., RADAR, UFCD controlled avionics, ECM, sensors, MC2) Land as soon as possible.

Figure 12-1. Warning/Caution/Advisory Displays (Sheet 31)

DDI Cautions and Caution Lights

INDICATOR	• CAUSE / REMARKS	CORRECTIVE ACTION
<p>WING UNLK</p>	<ul style="list-style-type: none"> • Either wing indicates unlocked (beer can up). • Catapult with the WINGFOLD switch in FOLD or HOLD. • An electrical failure in the WING UNLK caution circuitry. <p>The wings cannot be unlocked or folded in flight, even if the WINGFOLD switch is placed to FOLD or HOLD. If a WING UNLK caution appears with the beer cans down, an electrical failure has occurred in the caution circuitry and not in the wing unlock circuitry. If the WINGFOLD switch is inadvertently placed to HOLD or FOLD in flight, the wings unlock and the ailerons fair when the aircraft transitions to WonW during landing. In FOLD, the wings fold when the aircraft decelerates below 66 KCAS during landing rollout.</p> <div style="text-align: center; border: 2px solid black; padding: 5px; width: fit-content; margin: 10px auto;">WARNING</div> <p>Ensure the WINGFOLD switch is lever-locked in the SPREAD position during takeoff checks. If the wings are commanded to unlock or fold during a catapult shot, the wings unlock, the ailerons fair, the wings may fold partially, and the aircraft will settle.</p> <div style="text-align: center; border: 2px solid black; padding: 5px; width: fit-content; margin: 10px auto;">CAUTION</div> <p>If the wings are unlocked during landing rollout, ensure the NWS button is not pressed and full-time NWS HI is not engaged. In NWS HI, rudder pedal inputs command significantly greater nosewheel deflections and may result in a loss of directional control.</p>	<p>IN FLIGHT</p> <ol style="list-style-type: none"> 1. WINGFOLD switch - VERIFY SPREAD 2. Wingfold unlock flag (Beer Cans) - CHECK DOWN <p>If wings inadvertently unlocked/folded on catapult shot -</p> <ol style="list-style-type: none"> 1. Do not change WINGFOLD switch position. 2. Climb to a safe altitude. 3. WINGFOLD switch - SPREAD <p>If the wings are partially folded -</p> <ol style="list-style-type: none"> 4. Unload the aircraft to reduce aerodynamic forces. <p>FOR LANDING</p> <p>If both beer cans down -</p> <ol style="list-style-type: none"> 5. Make a normal landing. <p>If both beer cans are up -</p> <ol style="list-style-type: none"> 5. Make an arrested landing (if practical). 6. Make sure NWS HI not engaged.

Figure 12-1. Warning/Caution/Advisory Displays (Sheet 32)

FCS Cautions

INDICATOR	• CAUSE / REMARKS	CORRECTIVE ACTION
<p>FCS Initial</p> <p>FCS</p> <p>FCES</p> <p>Caution Light</p> <p>"Flight Controls, Flight Controls"</p>	<p>INITIAL FCS/FCES CAUTION PROCEDURES</p> <ul style="list-style-type: none"> • An FCS/FCES related failure has occurred. • FCS page Xs and/or BLIN codes identify the location and type of failure. <ul style="list-style-type: none"> - BLIN codes may be the only indication of a failure and should be treated with the same initial level of concern as failures that also produce Xs. • FCS RESET button <ul style="list-style-type: none"> - Clears the FCS caution whether or not the reset was successful. - Successful reset indicated by RSET advisory and removal of all Xs from the FCS page. - Unsuccessful reset indicated by RSET <div style="text-align: center; border: 2px solid black; padding: 5px; width: fit-content; margin: 10px auto;"> <p>WARNING</p> </div> <ul style="list-style-type: none"> • FCS page Xs indicate respective FCS function has been shutdown. The FCS RESET button does NOT fix a detected failure, but merely allows the components to be restored and failure indications to be removed if the failure no longer exists. • Avoid multiple FCS reset attempts of a recurring FCS failure to preclude the failure from occurring during a critical phase of flight (e.g., during final approach to landing) 	<ol style="list-style-type: none"> 1. Cease maneuvering. 2. FCS page - SELECT and identify failure <p>If AOA Xd in all four channels -</p> <ol style="list-style-type: none"> 3. Execute AOA Four Channel failure procedure. <p>All other failures -</p> <ol style="list-style-type: none"> 3. FCS RESET button - PUSH <p>If in RVSM airspace and BALT inhibited -</p> <ol style="list-style-type: none"> 4. Notify ATC that the aircraft is no longer RVSM compliant. <p>If no reset and no more than single X in any row -</p> <ol style="list-style-type: none"> 5. Land as soon as practical. <p>If no reset and two or more Xs in any row -</p> <ol style="list-style-type: none"> 5. The following general restrictions apply: <ul style="list-style-type: none"> • AOA below 10° in flaps AUTO, on-speed in flaps HALF/FULL • 2g maximum • Minimum sideslip • Half lateral stick maximum 6. Refer to the appropriate failure procedure: <ul style="list-style-type: none"> • AHRS 1/2 Channel Failure • AHRS Four Channel Failure • Aileron Failure • AOA Four Channel Failure • P/R/Y CAS • FCS Single Channel Failure • FC AIR DAT • FCES Caution Light • FLAPS OFF-LEF Failure • FLAPS OFF-TEF Failure • FLAP SCHED • Rudder Failure • Stab Failure <p>If no procedure applies -</p> <ol style="list-style-type: none"> 7. Execute Controllability Check procedure (if required). 8. Fly a straight-in approach (if practical). 9. Land as soon as practical.

Figure 12-1. Warning/Caution/Advisory Displays (Sheet 33)

FCS Cautions

INDICATOR	• CAUSE / REMARKS	CORRECTIVE ACTION
<p>AHRS One or Two Channel Failure</p> <p>FCS</p> <p>FCES</p> <p>Caution Light</p> <p>Five Xs will appear for each failed channel (CAS P, CAS R, CAS Y, N ACC, and L ACC)</p>	<p>AHRS ONE OR TWO CHANNEL FAILURE</p> <ul style="list-style-type: none"> FCCs have detected a failure of AHRS rate or acceleration data in one or two channels. <p>For each failed channel, rate sensor failures will occur in all three sensor axes (Xs in CAS P, CAS R, and CAS Y) and acceleration sensor failures will occur in both sensor axes (Xs in N ACC and L ACC) simultaneously.</p> <p>Loss of one or two AHRS channels will not affect flying qualities.</p> <p>Loss of redundancy in rate and acceleration information to the FCCs is the primary concern for a two channel failure. Although there is no degradation in flying qualities, subsequent AHRS failures could lead to controllability problems if the two channel AHRS failure procedures are not followed.</p> <p>It is possible that a third AHRS channel has failed but is not detected. Flying qualities will be degraded for this situation and will include poor roll coordination for large lateral inputs, pitch coupling, and sluggish pitch response. If flying qualities are degraded, assume a four channel failure has occurred, and refer to AHRS Four Channel Failure.</p>	<p>LOT 22 and up (AHRS equipped aircraft) -</p> <p>When FCS/FCES Initial procedures complete -</p> <p>One channel AHRS failure -</p> <p>7. Land as soon as practical.</p> <p>Two channel AHRS failure -</p> <p>7. Descend below 25,000 feet.</p> <p>If degradation in flying qualities is present -</p> <p>8. Refer to AHRS Four Channel Failure procedures.</p> <p>If no degradation in flying qualities is present -</p> <p>8. Land as soon as practical.</p>

Figure 12-1. Warning/Caution/Advisory Displays (Sheet 34)

FCS Cautions

INDICATOR	• CAUSE / REMARKS	CORRECTIVE ACTION
<p>AHRS Four Channel Failure</p> <p>PCAS RCAS YCAS FCS</p> <p>FCES</p> <p>Caution Light</p> <p>"Flight Controls, Flight Controls"</p> <p>Five Xs will appear for each failed channel (CAS P, CAS R, CAS Y, N ACC, and L ACC).</p>	<p>AHRS FOUR CHANNEL FAILURE</p> <ul style="list-style-type: none"> FCCs have detected a failure of AHRS rate or acceleration data in three or four channels. <p>For each failed channel, rate sensor failures will occur in all three sensor axes (Xs in CAS P, CAS R, and CAS Y) and acceleration sensor failures will occur in both sensor axes (Xs in N ACC and L ACC) simultaneously.</p> <p>It is possible to experience a three channel failure with only two channels Xd out. Flying qualities will be degraded for this situation.</p> <p>A detected loss of a third AHRS channel will result in all four AHRS channels being Xd out. Three columns of Xs will not be displayed because the FCCs cannot determine the good channel.</p> <p>Below 20,000 feet, flying qualities are best between 190-210 KCAS. Pitch and directional damping will be very low and roll coordination will be weak.</p> <div style="border: 2px solid black; padding: 5px; text-align: center; width: fit-content; margin: 10px auto;">WARNING</div> <ul style="list-style-type: none"> With a four channel AHRS failure, the aircraft is not controllable with the flaps in HALF or FULL. At altitudes above 25,000 feet, loss of control will occur below Mach 0.92. For loss of AHRS above 25,000 feet, maintain airspeed above Mach 0.92 while descending. Potential for lateral pilot induced oscillations (PIO) exists when landing with a Y CAS failure. 	<p>LOT 22 and up (AHRS equipped aircraft) -</p> <p>When FCS/FCES Initial procedures complete -</p> <ol style="list-style-type: none"> FLAP switch - AUTO If above 25,000 feet, maintain >Mach 0.92 until descent below 25,000 feet is accomplished. Jettison unwanted stores, if required, to improve flying qualities. Execute a straight-in on-speed approach with flaps in AUTO. Limit angle of bank to 20°. If not positioned for landing by in-the-middle to in-close, a wave off and go around should be executed. Make an arrested landing if available. Avoid stabilator braking.

Figure 12-1. Warning/Caution/Advisory Displays (Sheet 35)

FCS Cautions

INDICATOR	• CAUSE / REMARKS	CORRECTIVE ACTION
<p>Aileron Failure</p> <p>FCS</p> <p>FCES</p> <p>Caution Light</p> <p>"Flight Controls, Flight Controls"</p>	<p>AILERON ACTUATOR FAILURE</p> <ul style="list-style-type: none"> Aileron failures may be caused by an actuator failure (mechanical or two channel failure) or by a switching valve failing to switch to the backup circuit following a HYD circuit failure. <p>Speedbrake function and autopilot inoperative.</p> <ul style="list-style-type: none"> Failed aileron surface driven to a faired position by air loads and damped to prevent oscillations. Expect slightly higher approach speeds. For Flaps FULL approach speed will be increased by about 11 knots. Flaps HALF 17 knots. Avoid overcontrolling lateral stick inputs as it can cause lateral PIO especially when approaching touchdown. Operating aileron continues to provide roll control. <ul style="list-style-type: none"> - Roll damping is noticeably less. 	<p>When FCS/FCES Initial procedures complete -</p> <ol style="list-style-type: none"> Execute Controllability Check procedure. <p>For landing -</p> <ol style="list-style-type: none"> FLAP switch - HALF or FULL Fly a straight-in approach (if practical). Fly on-speed AOA to touchdown.
<p>AOA</p> <p>FCES</p> <p>Caution Light</p> <p>"Flight Controls, Flight Controls"</p>	<ul style="list-style-type: none"> FCCs have detected an excessive split between the left and right AOA probes immediately after takeoff. <div style="text-align: center; border: 1px solid black; padding: 5px; width: fit-content; margin: 10px auto;">WARNING</div> <p>With an AOA caution set, HUD displayed AOA may be grossly in error and should not be utilized to control aircraft flyaway.</p> <ul style="list-style-type: none"> AOA caution can only be activated within 12 seconds after WoffW. With AOA caution set: <ul style="list-style-type: none"> - During first 12 seconds, FCCs utilize a fixed gain (on-speed AOA) for pitch axis control, so expected flying qualities should be fairly nominal. - Movement of FLAP switch does not change flap scheduling (e.g. flaps stay down). - After 12 seconds, caution is removed even if failure remains. After 12 seconds, if failure remains, an FCS caution is set along with Xs in all four AOA channels. <ul style="list-style-type: none"> - HUD displayed AOA value is the average of the two split AOA probes. 	<p>IMMEDIATELY AFTER TAKEOFF</p> <ol style="list-style-type: none"> Throttles - MIL (MAX if required) Fly straight ahead. Maintain 10° to 12° pitch attitude with the waterline symbol. <p>When safely airborne -</p> <ol style="list-style-type: none"> FCS page - SELECT <p>If FCS caution set and AOA Xd in all four channels -</p> <ol style="list-style-type: none"> Execute the AOA Four Channel Failure procedure. <p>If no AOA Xs present -</p> <ol style="list-style-type: none"> Continue mission. Split was transitory but indicative of a binding-probe condition. Monitor AOA for proper indications. <p>For landing -</p> <ol style="list-style-type: none"> Execute the AOA Four Channel Failure procedure.

Figure 12-1. Warning/Caution/Advisory Displays (Sheet 36)

FCS Cautions

INDICATOR	• CAUSE / REMARKS	CORRECTIVE ACTION
<p>AOA Four Channel Failure</p> <p>FCS</p> <p>FCES</p> <p>Caution Light</p> <p>"Flight Controls, Flight Controls"</p>	<p>AOA FOUR CHANNEL FAILURE</p> <ul style="list-style-type: none"> A persistent (>10 second) mismatch between the left and right AOA probes has been detected (15° in flaps AUTO or 5.5° to 15° in flaps HALF/FULL depending on sideslip). Mismatch may be caused by a transient condition; a stuck, binding, or damaged probe; or a two-channel probe failure. <p>Autopilot inoperative.</p> <p>FLAPS AUTO</p> <ul style="list-style-type: none"> If the probe split clears, the AOA Xs are automatically removed. The split/AOA Xs may re-appear when/if the split conditions reoccur. With an AOA failure, FCCs use the AOA estimator for gain scheduling. Flying qualities should be essentially normal provided aircrew avoid high AOA. <p>FLAPS HALF/FULL</p> <ul style="list-style-type: none"> Rudder toe-in is disabled. FCCs use a fixed gain of 8.1°. HUD AOA, E-bracket and AOA indexers can be restored by selecting GAIN ORIDE and boxing the valid AOA probe on the FCS page. <p style="text-align: center;">WARNING</p> <ul style="list-style-type: none"> If an AOA probe is stuck or damaged (IFR basket impact, bird strikes, probe icing), AOA errors may be unannounced if the AOA split thresholds are not exceeded. Bolters in GAIN ORIDE or with AOA failed require positive aft stick during rotation; 1/2 aft stick is recommended. Deflections of less than 1/2 aft stick will result in excessive settle during bolters. <p style="text-align: center;">CAUTION</p> <p>In GAIN ORIDE, AOA will tend to readily increase above 14° when decelerating from a trimmed on-speed condition. Timely longitudinal stick inputs will be required to prevent excessive sink rates and correct a deceleration as power alone will not change the AOA or pitch attitude sufficiently in GAIN ORIDE. Alpha tone is disabled in GAIN ORIDE with flaps HALF/FULL.</p>	<p>When FCS/FCES Initial procedures complete -</p> <ol style="list-style-type: none"> The following general restrictions apply: <ul style="list-style-type: none"> AOA below 10° in flaps AUTO, on-speed in flaps HALF/FULL 2g maximum minimum sideslip Half lateral stick maximum <p>For landing -</p> <ol style="list-style-type: none"> Slow below 180 KCAS at a safe altitude. LDG GEAR handle - DN FLAP switch - HALF or FULL GAIN switch - ORIDE (ATC is not available in GAIN ORIDE.) FCS page - SELECT If possible, identify undamaged probe using center (INS) AOA value, airspeed crosscheck, wingman or BLIN code 475. <ul style="list-style-type: none"> BLIN 475 <ul style="list-style-type: none"> CH 1 & 4 - LEFT PROBE FAILED CH 2 & 3 - RIGHT PROBE FAILED <p>If undamaged probe identified -</p> <ol style="list-style-type: none"> Undamaged probe - SELECT (PB 16) Fly a straight-in approach (if practical). Notify LSO that GAIN ORIDE and a single probe has been selected. Fly on-speed AOA to touchdown. Maintenance action required prior to next flight. <p>If undamaged probe NOT identified -</p> <ol style="list-style-type: none"> Fly a straight-in approach (if practical). Determine on-speed for intended landing GW. If on-speed AOA and airspeed do not cross-check, fly airspeed to touchdown. Notify LSO that GAIN ORIDE has been selected and AOA indications may be in error. Maintenance action required prior to next flight.
<p>ATC FAIL</p> <p>FCES</p> <p>Caution Light</p>	<ul style="list-style-type: none"> Auto throttle control (ATC) failed. GAIN ORIDE selected with ATC approach mode engaged. Bank angle >70° in HALF or FULL flaps. <p>ATC capability not available. Supersonic engine thrust limiting (SETLIM) and ABLIM may be disabled.</p>	<ol style="list-style-type: none"> Control throttles manually. Avoid flight above 700 KCAS or Mach 1.8. <p>If GAIN ORIDE selected with ATC approach mode engaged -</p> <ol style="list-style-type: none"> FCS RESET button - PUSH

Figure 12-1. Warning/Caution/Advisory Displays (Sheet 37)

FCS Cautions

INDICATOR	• CAUSE / REMARKS	CORRECTIVE ACTION
<p>P CAS or R CAS or Y CAS</p> <p>FCS</p> <p>FCES</p> <p>Caution Light</p> <p>"Flight Controls, Flight Controls"</p>	<ul style="list-style-type: none"> FCS degraded in its ability to measure rates or acceleration in either pitch (P), roll (R), or yaw (Y) axis, as indicated. <p style="text-align: center;">WARNING</p> <p>Potential for lateral PIO exists when landing with a Y CAS failure.</p>	<p>LOT 22 and up (AHRS equipped aircraft) - Refer to AHRS Four Channel Failure procedures.</p> <p>LOT 21 - When FCS/FCES Initial procedures complete -</p> <p>P CAS 7. Make smooth longitudinal inputs only.</p> <p>R CAS 7. Limit pedal inputs to half throw.</p> <p>Y CAS 7. Make smooth lateral inputs only. 8. Limit pedal inputs to half throw.</p>
<p>FCS Single Channel Failure</p> <p>FCS</p> <p>FCES</p> <p>Caution Light</p>	<p>FCS SINGLE CHANNEL FAILURE</p> <ul style="list-style-type: none"> FCC channel failure. <p>No change in flying qualities.</p> <p>Speedbrake function inoperative.</p> <p>Channel 2 or Channel 4:</p> <ul style="list-style-type: none"> ATC inoperative. Normal NWS inoperative. <p>Channel 2 also:</p> <ul style="list-style-type: none"> Loss of HUD baro altitude and IFF reporting (standby altitude and RALT still available). MAD sensor data lost. (Mag heading may degrade). <p>Channel 4 also:</p> <ul style="list-style-type: none"> AOA indexer/approach lights inoperative. <p style="text-align: center;">WARNING</p> <p>Pulling the wrong circuit breaker shuts down a second flight control channel and may result in degraded flying qualities or loss of control.</p>	<p>When FCS/FCES Initial procedures complete -</p> <p>7. Circuit breaker failed channel - PULL, pause 20 seconds, RESET</p> <p>8. Land as soon as practical.</p> <p>With CH 2 or CH 4 failed -</p> <p>9. Consider a precautionary arrested landing (if available). (Normal NWS is not available.)</p>

Figure 12-1. Warning/Caution/Advisory Displays (Sheet 38)

FCS Cautions

INDICATOR	• CAUSE / REMARKS	CORRECTIVE ACTION																				
<p>FC AIR DAT</p> <p>FCS</p> <p>FCES</p> <p>Caution Light</p>	<p>Caution indicates one of the following:</p> <ul style="list-style-type: none"> • Left and right pitot-static probes are reporting in the valid range but disagree. • Pitot-static failure (both pitot probes invalid, PTS inoperable or an excessive split between left and right readings). <p>Caution is also accompanied by four channel PTS X-out.</p> <p>FCCs use the highest total pressure input if valid.</p> <ul style="list-style-type: none"> • Wheels Warning also set if caution resulted from a loss of air data. • With loss of static pressure, HUD altitude and vertical velocity are blanked. • With loss of total pressure, HUD Mach and airspeed are blanked. - Altitude appears with an X to the right (e.g., value is uncorrected). <p>WITH GAIN ORIDE SELECTED</p> <ul style="list-style-type: none"> • FCCs use fixed values for speed, altitude, and AOA depending on flap position causing LEFs, TEFs, and AIL droop to be driven to fixed positions. <table border="1" data-bbox="349 821 779 909"> <thead> <tr> <th>Flaps</th> <th>Mach</th> <th>KTAS</th> <th>Feet</th> <th>°AOA</th> </tr> </thead> <tbody> <tr> <td>AUTO</td> <td>0.80</td> <td>459</td> <td>39,000</td> <td>3.5</td> </tr> <tr> <td>HALF</td> <td>0.23</td> <td>151</td> <td>500</td> <td>8.1</td> </tr> <tr> <td>FULL</td> <td>0.21</td> <td>139</td> <td>500</td> <td>8.1</td> </tr> </tbody> </table> <ul style="list-style-type: none"> • FLAPS light comes on along with: <ul style="list-style-type: none"> - CRUIS advisory in flaps AUTO - LAND advisory in flaps HALF/FULL • Noticeable transients may occur when selecting GAIN ORIDE. • Longitudinal and lateral response is more sluggish as airspeed is reduced below the gain values and is more sensitive as airspeed is increased above the gain values. • Do not lower flaps in a turn as higher than normal aft stick forces are required and side-slip excursions may occur. • Avoid over-control and resulting PIO during flap transition. <div style="border: 2px solid black; padding: 5px; text-align: center; width: fit-content; margin: 10px auto;">WARNING</div> <ul style="list-style-type: none"> • With an FC AIR DAT caution, HUD displayed airspeed may be in error. Fly an on-speed AOA approach (GAIN ORIDE selected). • Bolters in GAIN ORIDE or with AOA failed, require positive aft stick during rotation; 1/2 aft stick is recommended. Deflections of less than 1/2 aft stick will result in excessive settle during bolters. • AOA warning tone is disabled in GAIN ORIDE with flaps HALF/FULL. • Exceeding GAIN ORIDE airspeed limitations of 350 KCAS (flaps AUTO), 200 KCAS (flaps HALF), or 190 KCAS (flaps FULL) may result in an uncontrollable aircraft. <div style="border: 2px solid black; padding: 5px; text-align: center; width: fit-content; margin: 10px auto;">CAUTION</div> <ul style="list-style-type: none"> • In GAIN ORIDE, AOA will tend to readily increase above 14° when decelerating from a trimmed on- speed condition. Timely longitudinal stick inputs will be required to prevent excessive sink rates and correct a deceleration as power alone will not change the AOA or pitch attitude sufficiently in GAIN ORIDE. • If left pitot probe is damaged or suspect, standby instruments including standby airspeed indicator may be significantly erroneous. In all cases where airspeed are suspect, reference AOA values to approximate airspeed for selection of GAIN ORIDE, landing configuration, and approach to landing. 	Flaps	Mach	KTAS	Feet	°AOA	AUTO	0.80	459	39,000	3.5	HALF	0.23	151	500	8.1	FULL	0.21	139	500	8.1	<p>When FCS/FCES Initial procedures complete -</p> <ol style="list-style-type: none"> 7. Assess airspeed indications. <p>If HUD airspeed and standby airspeed indicators agree -</p> <ol style="list-style-type: none"> 8. Airspeed - Maintain below 350 KCAS <p>If airspeed blanked or does not agree with standby indicator -</p> <ol style="list-style-type: none"> 8. Establish 4° to 5° AOA (DO NOT EXCEED 10° AOA). <p>Once below 350 KCAS/above 4° AOA in wings-level flight -</p> <ol style="list-style-type: none"> 9. GAIN switch - ORIDE <p>For landing -</p> <ol style="list-style-type: none"> 1. Airspeed - Below 180 KCAS (approximately 6° to 7° AOA). <p>In wings-level flight -</p> <ol style="list-style-type: none"> 2. LDG GEAR handle - DN 3. FLAP switch - HALF or FULL 4. DO NOT EXCEED 190 KCAS or 10° AOA. 5. Fly a straight-in approach (if practical). 6. Fly on-speed AOA to touchdown. (ATC is not available in GAIN ORIDE.)
Flaps	Mach	KTAS	Feet	°AOA																		
AUTO	0.80	459	39,000	3.5																		
HALF	0.23	151	500	8.1																		
FULL	0.21	139	500	8.1																		

Figure 12-1. Warning/Caution/Advisory Displays (Sheet 39)

FCS Cautions

INDICATOR	• CAUSE / REMARKS	CORRECTIVE ACTION
<p>FCES</p> <p>Caution Light</p> <p>(With MC1 Inoperative)</p>	<ul style="list-style-type: none"> If MC1 is inoperative, the FCES caution light is the only indication of a FCES failure. <p>The FCS page is not available.</p> <p style="text-align: center;">WARNING</p> <p>Exceeding GAIN ORIDE airspeed limitations of 350 KCAS (flaps AUTO), 200 KCAS (flaps HALF), or 190 KCAS (flaps FULL) may result in an uncontrollable aircraft.</p> <p>If the FCES light remains on after an FCS RESET attempt, an actuator is still failed or one of the following cautions did not reset: AOA, ATC FAIL; P, R or Y CAS; FC AIR DAT, FCS, FLAP SCHED, FLAPS OFF, HYD 5000, or NWS.</p>	<p>When FCS/FCES Initial procedures complete -</p> <ol style="list-style-type: none"> Airspeed - Maintain below 250 KCAS Attempt to identify the malfunction. Execute Controllability Check procedure. <p>If failure not identified and DDI warnings and FCS cautions still inoperative -</p> <p>For landing -</p> <ol style="list-style-type: none"> Slow below 180 KCAS at a safe altitude. LDG GEAR handle - DN FLAP switch - HALF or FULL GAIN switch - ORIDE (if required) FCS page - SELECT VALID AOA PROBE (if required) Fly a straight-in approach (if practical). Fly on-speed AOA to touchdown. (ATC is not available in GAIN ORIDE.) Make a precautionary short field arrestment (if required).
<p>FCS HOT</p> <p>FCS HOT</p> <p>Caution Light</p> <p>"Flight Computer Hot, Flight Computer Hot"</p>	<ul style="list-style-type: none"> FCC A over-temperature detected. AHRS over-temperature detected. FCCs can only operate for a short time without cooling. Placing AV COOL switch to EMERG provides emergency ram air cooling to FCC A and right TR. If airspeed above 325 KCAS required, delay deploying FCS ram air scoop, as ram air temperature may actually increase FCC heating and decrease operating time. Once deployed, the FCS ram air scoop cannot be closed in flight. 	<ol style="list-style-type: none"> Maintain airspeed below 325 KCAS (300 to 325 KCAS optimum for cooling). AV COOL switch - EMERG Land as soon as possible.

Figure 12-1. Warning/Caution/Advisory Displays (Sheet 40)

FCS Cautions

INDICATOR	• CAUSE / REMARKS	CORRECTIVE ACTION
<p>LEF Failure</p> <p>FLAPS OFF</p> <p>FCES</p> <p>Caution Light</p> <p>FLAPS</p> <p>Amber</p> <p>"Flight Controls, Flight Controls"</p>	<p>LEF FAILURE</p> <ul style="list-style-type: none"> LEF failures may be caused by an actuator failure (mechanical or two channel failure) or by a switching valve failing to switch to the backup circuit following a HYD circuit failure. <p>Speedbrake function and autopilot inoperative.</p> <ul style="list-style-type: none"> Failed LEF surface is mechanically locked in its current position. <ul style="list-style-type: none"> Opposite LEF held frozen by FCCs except for differential control in flaps AUTO. In most cases, LEFs should be fairly symmetric; however, multiple FCS reset attempts may aggravate the asymmetry. With a LEF locked near 21° LED (± 5°): <ul style="list-style-type: none"> Flaps HALF/FULL handling qualities essentially normal. If locked above this position, stall margin reduced. With LEF locked near 0° LED (± 5°): <ul style="list-style-type: none"> Light to moderate buffet levels persist for AOAs above on-speed (Buffet more pronounced with LEF deflections significantly less than normal scheduled positions). Selecting flaps FULL not recommended due to higher buffet levels at lower AOAs than with flaps HALF. <p>ROLL AND LINE-UP CONTROL</p> <ul style="list-style-type: none"> Expect slight roll-off (1-3°) due to buffet and/or AOA/pitch attitude changes. Roll off will not significantly degrade line-up control. A small roll-off will occur with airspeed changes during wave-off or bolter that is easily controllable with small lateral stick inputs. <p>GLIDESLOPE CONTROL</p> <ul style="list-style-type: none"> Glideslope control degradations may be more pronounced depending on frozen LEF position. Wing stores will further degrade glideslope control. Power corrections will translate into an airspeed change before a rate of descent change is noticed. This may lead to a tendency to over control glideslope. Anticipatory throttle inputs are key to glideslope control. Time to achieve positive rate of climb is longer during a bolter/waveoff due to sluggish throttle response. Climb-out attitude will appear flatter than normal. When operating shipboard, the waveoff window for all LEF failure conditions should be moved farther out and the LSOs should be made aware of the degraded glideslope performance. <p>GAIN ORIDE CONSIDERATIONS</p> <p>FLAPS AUTO</p> <ul style="list-style-type: none"> GAIN ORIDE will drive the unfailed LEF to a fixed position of 5° LED in AUTO. If the failed LEF is near 21°, this will cause a controllable but undesirable LEF split. Therefore, only select GAIN ORIDE if TEF retraction is essential or if the LEFs are fixed near 5° LED. If fuel or range is a concern, momentary selection of GAIN ORIDE brings the TEFs up to 4° TED and then returns them to normal scheduling when NORM is selected. <p>FLAPS HALF/FULL</p> <ul style="list-style-type: none"> GAIN ORIDE will drive the unfailed LEF to a fixed position of 21° LED in HALF/FULL. If the failed LEF is near 0° LED, this will cause a controllable LEF split. <div style="text-align: center; border: 1px solid black; padding: 5px; width: fit-content; margin: 10px auto;">WARNING</div> <ul style="list-style-type: none"> Bolters in GAIN ORIDE or with AOA failed require positive aft stick during rotation; 1/2 aft stick is recommended. Deflections of less than 1/2 aft stick will result in excessive settle during bolters. Exceeding GAIN ORIDE airspeed limitations of 350 KCAS (flaps AUTO), 200 KCAS (flaps HALF), or 190 KCAS (flaps FULL) may result in an uncontrollable aircraft. <div style="text-align: center; border: 1px solid black; padding: 5px; width: fit-content; margin: 10px auto;">CAUTION</div> <p>In GAIN ORIDE, AOA will tend to readily increase above 14° when decelerating from a trimmed on-speed condition. Timely longitudinal stick inputs will be required to prevent excessive sink rates and correct a deceleration as power alone will not change the AOA or pitch attitude sufficiently in GAIN ORIDE. Alpha tone is disabled in GAIN ORIDE with flaps HALF/FULL.</p>	<p>When FCS/FCES Initial procedures complete -</p> <p>If failed in flaps HALF/FULL and flaps AUTO required -</p> <ol style="list-style-type: none"> Airspeed - 180 KCAS LDG GEAR handle - UP FLAP switch - AUTO GAIN switch - ORIDE <p>When TEFs retract to 4° TED -</p> <ol style="list-style-type: none"> GAIN switch - NORM <p>For landing -</p> <ol style="list-style-type: none"> Execute Flaps-HALF Controllability Check procedure, including throttle response and waveoff maneuver. FLAP switch - HALF Fly a straight-in approach (if practical). Field - If buffet level is uncomfortable on-speed, fly a slightly fast approach (6° to 7° AOA) then slow to on-speed AOA prior to touchdown. Carrier - Fly on-speed throughout approach.

Figure 12-1. Warning/Caution/Advisory Displays (Sheet 41)

FCS Cautions

INDICATOR	• CAUSE / REMARKS	CORRECTIVE ACTION
<p>TEF Failure</p> <p>FLAPS OFF</p> <p>FCES</p> <p>Caution Light</p> <p>FLAPS</p> <p>Amber</p> <p>“Flight Controls, Flight Controls”</p>	<p>TEF FAILURE</p> <ul style="list-style-type: none"> • TEF failures may be caused by an actuator failure (mechanical or three-four channel failure) or by a dual HYD 1A/2B circuit failure. <p>Speedbrake function and autopilot inoperative.</p> <ul style="list-style-type: none"> • If a TEF actuator is shutdown, the surface is hydraulically or aerodynamically driven to 5° TED and locked. • If/when left versus right TEF asymmetry exceeds 6°, the opposite TEF turns off and is also driven to 5° TED and locked. • With both TEFs locked at 5° TED, drag is significantly reduced, approach speeds are significantly higher, and on-speed power settings are near idle. • A 10° AOA approach is required to attain acceptable approach throttle response nearing touchdown. • Approach speeds for shore landing may be near the maximum nose tire speed (195 KGS). If making an arrested landing take maximum arresting gear engagement speed into consideration. <ul style="list-style-type: none"> • Expect slower engine response to throttle changes. • Flying a 10° AOA approach reduces approach speed and increases approach power setting slightly. <ul style="list-style-type: none"> - Aircraft easily trims to and maintains 10° AOA. Expect normal flying qualities. • Sight picture behind the ship is altered, but field of view over the nose is not degraded. • Due to large difference between wind over the deck requirements at on-speed and 10° AOA, it is imperative that AOA be maintained at 10°. <ul style="list-style-type: none"> - Tendency exists to relax AOA control while maintaining glideslope. <p>GLIDESLOPE CONTROL</p> <ul style="list-style-type: none"> • Aircraft response to power corrections is sluggish and small in magnitude. • Power corrections will translate into an airspeed change before a rate of descent change is noted. • Expect larger, longer, and more anticipatory power corrections to be required in order to effect a glideslope change. Aggressive, well-timed, and anticipatory throttle inputs are key to glideslope control. • There is a tendency to over control power due to the low approach power setting and the longer time required to effect a change. • Time to achieve positive rate of climb is longer during a bolter/waveoff due to sluggish throttle response. Climb-out attitude will appear flatter than normal. <div style="border: 2px solid black; padding: 5px; text-align: center; margin: 10px 0;"> <p>WARNING</p> </div> <p>Slower engine response to throttle changes may result in excessive sink rates under high WOD conditions. The recovery WOD should be kept as close as possible to the Aircraft Recovery Bulletin recommendations.</p>	<p>When FCS/FCES Initial procedures complete -</p> <p>For landing -</p> <ol style="list-style-type: none"> 7. Execute Controllability Check procedure, including throttle response and waveoff maneuver. 8. Adjust gross weight to the minimum practical. 9. FLAP switch - FULL or HALF 10. Fly a straight-in approach (if practical). 11. Trim to and fly 10° AOA to touchdown.

Figure 12-1. Warning/Caution/Advisory Displays (Sheet 42)

FCS Cautions

INDICATOR	• CAUSE / REMARKS	CORRECTIVE ACTION
<p>FLAP SCHED</p> <p>FCES Caution Light</p> <p>FLAPS Amber</p> <p>"Flight Controls, Flight Controls"</p>	<ul style="list-style-type: none"> FCCs have detected a LEF hydraulic drive unit (HDU) stall. <div style="border: 2px solid black; padding: 5px; text-align: center; width: fit-content; margin: 10px auto;">WARNING</div> <p>If a weak HDU fails to drive a LEF surface to the commanded position, an uncommanded roll-off may result. When aerodynamic loads are reduced, the weak HDU may operate normally.</p> <p>There are two sets of LEF conditions that can set the FLAP SCHED caution:</p> <p>CONDITION 1</p> <ul style="list-style-type: none"> Relates to aircraft maneuvering that may be departure prone with incorrect LEF movement. FLAP SCHED caution asserted when all of the following occur: <ol style="list-style-type: none"> 10° difference exists between LEF commanded vs. actual position. AOA > 12° Nz > 1.5g LEF rate is less than 1.5°/sec OR is diverging from its command. <p>CONDITION 2</p> <ul style="list-style-type: none"> Severely degraded LEF performance detected that can cause pronounced roll-off at intermediate AOA due to less than optimum LEF deflection on one side. FLAP SCHED caution asserted when all of the following occur: <ol style="list-style-type: none"> 4° difference between LEF commanded vs. actual position. LEF rate is 2°/sec slower than estimated rate capability of the LEF. FLAP SCHED caution will remain on for an additional 6 seconds after the HDU stall condition clears. 	<p>If LEF Xs not present (HDU Stall) -</p> <ol style="list-style-type: none"> Limit AOA to 6° maximum when below 3,000 feet AGL and above Mach 0.6. <p>If LEF Xs present (HDU failed) -</p> <ol style="list-style-type: none"> Execute FLAPS OFF procedure. <p>For landing -</p> <ol style="list-style-type: none"> FLAP switch - HALF or FULL Fly a straight-in approach (if practical). Fly on-speed AOA to touchdown.

Figure 12-1. Warning/Caution/Advisory Displays (Sheet 43)

FCS Cautions

INDICATOR	• CAUSE / REMARKS	CORRECTIVE ACTION
<p>NWS</p> <p>FCES</p> <p>Caution Light</p>	<ul style="list-style-type: none"> Nosewheel steering malfunction/failure (mechanical or electrical). <p style="text-align: center;">OR</p> <ul style="list-style-type: none"> Launch bar signal to the FCCs has failed. NWS or NWS HI cue removed from HUD. NWS reverts to 360° free-swiveling mode. If NWS lost due to FCS CH2 or CH4 failure, emergency high gain NWS can be obtained by unlocking the wings. Single channel NWS operation in emergency mode prevents detection of NWS command failures. Disengage NWS if uncommanded motion occurs. <p style="text-align: center;">WARNING</p> <p>When emergency high gain NWS mode is entered, NWS indications may not be displayed on the HUD. As a result, inadvertent nosewheel steering actuation may injure ground personnel.</p>	<p>GROUND</p> <p>If no FCS Channel 2 or 4 failure -</p> <ol style="list-style-type: none"> Do not attempt taxi. <p>If FCS Channel 2 or 4 failure present and emergency high gain NWS required -</p> <ol style="list-style-type: none"> WINGFOLD switch - HOLD or FOLD <p>If FCS CH 4 failed -</p> <ol style="list-style-type: none"> NWS button - PRESS and RELEASE <p>If FCS CH 2 failed -</p> <ol style="list-style-type: none"> NWS button - PRESS and RELEASE Paddle switch - PRESS NWS button - PRESS and RELEASE <p>IN FLIGHT</p> <p>If no BLIN code 123 present -</p> <ol style="list-style-type: none"> Make a precautionary arrested landing (if available). <p>If BLIN code 123 present -</p> <ol style="list-style-type: none"> NWS Low gain available by holding the NWS switch pressed.
<p>Rudder Failure</p> <p>FCS</p> <p>FCES</p> <p>Caution Light</p> <p>“Flight Controls, Flight Controls”</p>	<p>RUDDER ACTUATOR FAILURE</p> <ul style="list-style-type: none"> Rudder failures may be caused by an actuator failure (mechanical or two channel failure) or by a switching valve failing to switch to the backup circuit following a HYD circuit failure. Speedbrake function, autopilot, and rudder toe-in inoperative. Following rudder actuator failure, surface driven to a faired position by air loads and is damped to prevent oscillations. Counter any roll-off with rudder. Countering a roll-off with lateral stick alone increases adverse yaw and aggravates the roll-off. To ensure balanced flight, minimize sideslip by the early use of the operating rudder. <p>LINEUP CONSIDERATIONS</p> <ul style="list-style-type: none"> Lineup control will be degraded. Make lineup corrections slowly and smoothly, particularly when single engine. <p style="text-align: center;">WARNING</p> <p>Full opposing rudder may not be sufficient to prevent a departure when single engine if MAX power selected. Large single engine throttle transients can cause significant yaw and roll.</p> <ul style="list-style-type: none"> Departure resistance is degraded above on-speed AOA. Bolter performance degraded due to lack of rudder toe-in. 	<p>When FCS/FCES Initial procedures complete -</p> <ol style="list-style-type: none"> Execute Flaps-HALF Controllability Check procedure. <p>For landing -</p> <ol style="list-style-type: none"> FLAP switch - HALF Fly a straight-in approach (if practical). Fly on-speed AOA to touchdown. (DO NOT EXCEED ON-SPEED AOA.)

Figure 12-1. Warning/Caution/Advisory Displays (Sheet 44)

FCS Cautions

INDICATOR	• CAUSE / REMARKS	CORRECTIVE ACTION
<p>Stabilator Failure</p> <p>FCS</p> <p>FCES</p> <p>Caution Light</p> <p>"Flight Controls, Flight Controls"</p>	<p>STABILATOR ACTUATOR FAILURE</p> <ul style="list-style-type: none"> Stabilator failures may be caused by an actuator failure (mechanical or three-four channel failure) or by a dual HYD circuit failure (1B/2A or 1A/2B). <p>Autopilot inoperative.</p> <ul style="list-style-type: none"> Stabilator reconfiguration control laws are automatically enabled following a single stabilator failure to compensate for the loss of that surface. With hydraulics intact, failed stabilator is driven to 2° TEU and locked. Below 250 KCAS, flying qualities should be nearly normal. <div style="text-align: center; border: 2px solid black; padding: 5px; width: fit-content; margin: 10px auto;"> <p>WARNING</p> </div> <ul style="list-style-type: none"> In flaps AUTO, maximum roll rate is extremely low in the transonic region below 20,000 feet, especially when rolling away from the failed stabilator. Significant roll and yaw coupling may occur with forward stick inputs at >Mach 1.4 and altitude >30,000 feet. In flaps AUTO, DO NOT EXCEED 10° AOA due to reduced nose-down pitch authority. During a bolter, aircraft yaws into good stabilator when the flight control system deflects the good stabilator TEU in preparation for aircraft nose rotation. The yaw may be sudden and pronounced, but easily controlled with rudder to counter the yawing motion. Positive aft stick is required to achieve positive rotation during bolters. 	<p>When FCS/FCES Initial procedures complete -</p> <ol style="list-style-type: none"> Airspeed - Maintain below 300 KCAS AOA - Maintain below 10° Execute Controllability Check procedure. <ul style="list-style-type: none"> Flaps HALF DO NOT EXCEED ON-SPEED AOA. <p>For landing -</p> <ol style="list-style-type: none"> FLAP switch - HALF Fly a straight-in approach. Fly on-speed AOA to touchdown. Make a precautionary short field arrestment (if available). Avoid longitudinal stick inputs during landing rollout (e.g., aero braking).

Figure 12-1. Warning/Caution/Advisory Displays (Sheet 45)

HYD Cautions

INDICATOR	• CAUSE / REMARKS	CORRECTIVE ACTION
HYD 1A	<ul style="list-style-type: none"> • HYD circuit 1A pressure low (<1,400 psi). <p>HYD 1A is the first circuit turned off during RLS operation. If caution remains without HYD 1B, the leak was successfully isolated in HYD 1A.</p> <p>Right AIL Xs will occur if switching valve is slow/fails to switch.</p> <ul style="list-style-type: none"> • FCS RESET recovers surface only if hydraulic pressure present. 	<ol style="list-style-type: none"> 1. Airspeed - Maintain below 350 KCAS 2. Land as soon as practical. <p>If right AIL Xs -</p> <ol style="list-style-type: none"> 3. FCS RESET button - PUSH (multiple times if required) <p>If right AIL Xs remain -</p> <ol style="list-style-type: none"> 4. Read remarks for AIL Xs. 5. Execute Controllability Check procedure. <ul style="list-style-type: none"> • Flaps HALF or FULL • DO NOT EXCEED ON-SPEED AOA. <p>If no Xs -</p> <ol style="list-style-type: none"> 3. Fly a straight-in approach.
HYD 1B	<ul style="list-style-type: none"> • HYD circuit 1B pressure low (<1,400 psi). <p>HYD 1B is the second circuit turned off during RLS operation. If caution remains without HYD 1A, the leak was successfully isolated in HYD 1B.</p> <p>Left RUD and/or left LEF Xs will occur if switching valve is slow/fails to switch.</p> <ul style="list-style-type: none"> • FCS RESET recovers surface only if hydraulic pressure present. 	<ol style="list-style-type: none"> 1. Airspeed - Maintain below 350 KCAS 2. Land as soon as practical. <p>If left RUD and/or left LEF Xs -</p> <ol style="list-style-type: none"> 3. FCS RESET button - PUSH (multiple times if required) <p>If left RUD and/or left LEF Xs remain -</p> <ol style="list-style-type: none"> 4. Read remarks for RUD and/or LEF Xs. 5. Execute Controllability Check procedure. <ul style="list-style-type: none"> • Flaps HALF • DO NOT EXCEED ON-SPEED AOA. <p>If no Xs -</p> <ol style="list-style-type: none"> 3. Fly a straight-in approach.

Figure 12-1. Warning/Caution/Advisory Displays (Sheet 46)

HYD Cautions

INDICATOR	• CAUSE / REMARKS	CORRECTIVE ACTION
<p>HYD 2A</p>	<ul style="list-style-type: none"> • HYD circuit 2A pressure low (<1,400 psi). <p>HYD 2A is the first circuit turned off during RLS operation. If caution remains without HYD 2B, the leak was successfully isolated in HYD 2A.</p> <p>With HYD 2A failed:</p> <ul style="list-style-type: none"> • No landing gear retraction/normal extension • No normal NWS (flashing NWS in HUD) • No normal braking • No anti-skid • No probe retraction/normal extension • No launch bar extension • No gun <p>Right LEF Xs will occur if switching valve is slow/fails to switch.</p> <ul style="list-style-type: none"> • FCS RESET recovers surface only if hydraulic pressure present. 	<ol style="list-style-type: none"> 1. Airspeed - Maintain below 350 KCAS 2. Land as soon as practical. 3. PROBE switch - EMERG EXT D (if required) <p>If right LEF Xs -</p> <ol style="list-style-type: none"> 4. FCS RESET button - PUSH (multiple times if required) <p>If right LEF Xs remain -</p> <ol style="list-style-type: none"> 5. Read remarks for LEF Xs. 6. Execute Controllability Check procedure. <ul style="list-style-type: none"> • Flaps HALF • DO NOT EXCEED ON-SPEED AOA. <p>If no Xs -</p> <ol style="list-style-type: none"> 4. Consider Select Jettison unwanted stores prior to gear extension. 5. Execute Landing Gear Emergency Extension procedure. <p>FOR LANDING</p> <ol style="list-style-type: none"> 1. Fly a straight-in approach. 2. Make an arrested landing (if practical). <p>If arrested landing not practical -</p> <ol style="list-style-type: none"> 3. Use emergency brakes with steady brake pressure (DO NOT PUMP). Anti-skid is not available. 4. Consider paddle switch - PRESS after touch-down to preserve APU ACCUM pressure for slow speed NWS. <p>Once stopped on runway -</p> <ol style="list-style-type: none"> 5. Do not taxi (even if HYD 2A caution is removed).
<p>HYD 2B</p>	<ul style="list-style-type: none"> • HYD circuit 2B pressure low (<1,400 psi). <p>HYD 2B is the second circuit turned off during RLS operation. If caution remains without HYD 2A, the leak was successfully isolated in HYD 2B.</p> <p>With HYD 2B failed:</p> <ul style="list-style-type: none"> • No hook retraction <p>Left AIL and/or right RUD Xs will occur if switching valve is slow/fails to switch.</p> <ul style="list-style-type: none"> • FCS RESET recovers surface only if hydraulic pressure present. 	<ol style="list-style-type: none"> 1. Airspeed - Maintain below 350 KCAS 2. Land as soon as practical. <p>If left AIL and/or right RUD Xs -</p> <ol style="list-style-type: none"> 3. FCS RESET button - PUSH (multiple times if required) <p>If left AIL and/or right RUD Xs remain -</p> <ol style="list-style-type: none"> 4. Read remarks for AIL and/or RUD Xs. 5. Execute Controllability Check procedure. <ul style="list-style-type: none"> • Flaps HALF (Flaps FULL check acceptable if no RUD Xs) • DO NOT EXCEED ON-SPEED AOA. <p>If no Xs -</p> <ol style="list-style-type: none"> 3. Fly a straight-in approach.

Figure 12-1. Warning/Caution/Advisory Displays (Sheet 47)

HYD Cautions

INDICATOR	• CAUSE / REMARKS	CORRECTIVE ACTION
<p>HYD 1A HYD 1B</p>	<ul style="list-style-type: none"> • Dual left HYD circuit failure (<1,400 psi). (a) Left HYD pump internal failure (needle NOT stabilized at zero). May be accompanied by HYD1 HOT caution. (b) HYD 1 leak which could not be isolated by RLS (preceded by RLS circuit caution sequencing). (c) Left HYD pump shaft shear (needle stabilized at zero). (d) Left power transmission shaft failure (accompanied by L GEN, L DC FAIL, and L BOOST LO cautions). <p>Right AIL, left RUD, and/or left LEF Xs will occur if switching valve is slow/fails to switch.</p> <ul style="list-style-type: none"> • FCS RESET recovers surface only if hydraulic pressure present. <div style="text-align: center;">  <p>CAUTION</p> </div> <p>Prolonged use of a failed hydraulic pump without the pump shaft shearing as indicated by the needle not stabilized at zero will generate considerable heat and may result in an AMAD bay fire. Consider restarting the engine prior to landing.</p>	<ol style="list-style-type: none"> 1. Throttle LEFT engine - IDLE 2. Airspeed - Maintain below 350 KCAS 3. Land as soon as practical. <p>If HYD 1 needle NOT stabilized at zero -</p> <ol style="list-style-type: none"> 4. Throttle LEFT engine - OFF <p>If HYD1 HOT caution never displayed -</p> <ol style="list-style-type: none"> 5. Consider restart for landing (if required). <p>If right AIL, left RUD, and/or left LEF Xs -</p> <ol style="list-style-type: none"> 6. FCS RESET button - PUSH (multiple times if required) <p>If right AIL, left RUD, and/or left LEF Xs remain -</p> <ol style="list-style-type: none"> 7. Read remarks for AIL, RUD and/or LEF Xs. 8. Execute Controllability Check procedure. <ul style="list-style-type: none"> • Flaps HALF (Flaps FULL check acceptable if no RUD or LEF Xs) • DO NOT EXCEED ON-SPEED AOA. <p>FOR LANDING</p> <p>If single engine -</p> <ol style="list-style-type: none"> 1. Execute Single Engine Approach and Landing procedure. <p>If both engines running -</p> <ol style="list-style-type: none"> 1. FLAP switch - HALF (Flaps FULL acceptable if no RUD or LEF Xs) 2. Fly a straight-in approach.

Figure 12-1. Warning/Caution/Advisory Displays (Sheet 48)

HYD Cautions

INDICATOR	• CAUSE / REMARKS	CORRECTIVE ACTION
<p>HYD 1A HYD 2A</p>	<ul style="list-style-type: none"> • Dual HYD circuit failure (<1,400 psi). <p>Flight control surface affected:</p> <ul style="list-style-type: none"> • Right aileron lost (faired and damped) <p>With HYD 2A failed:</p> <ul style="list-style-type: none"> • No landing gear retraction/normal extension • No normal NWS (flashing NWS in HUD) • No normal braking • No anti-skid • No probe retraction/normal extension • No launch bar extension • No gun <p>Right LEF Xs will occur if switching valve is slow/fails to switch.</p> <ul style="list-style-type: none"> • FCS RESET recovers surface only if hydraulic pressure present. <p>Remarks for any surface off:</p> <ul style="list-style-type: none"> • General Limits: <ul style="list-style-type: none"> • 10° AOA for flaps AUTO • On-speed AOA for flaps HALF/FULL • 2g max • Minimize sideslip • Half lateral stick • Loss of speedbrake • Loss of autopilot <p>Remarks for AIL Xs:</p> <ul style="list-style-type: none"> • Expect slightly higher approach speeds. For flaps FULL, approach speed will be increased by about 11 knots. Flaps HALF, 17 knots. • Avoid over-controlling lateral stick inputs as it can cause lateral PIO especially when approaching touchdown. 	<ol style="list-style-type: none"> 1. Airspeed - Maintain below 350 KCAS 2. Land as soon as practical. 3. PROBE switch - EMERG EXTND (if required) <p>If right LEF Xs -</p> <ol style="list-style-type: none"> 4. FCS RESET button - PUSH (multiple times if required) <p>If right LEF Xs remain -</p> <ol style="list-style-type: none"> 5. Read remarks for AIL and LEF Xs. 6. Execute Controllability Check procedure. <ul style="list-style-type: none"> • Flaps HALF • DO NOT EXCEED ON-SPEED AOA. <p>If only right AIL Xs -</p> <ol style="list-style-type: none"> 5. Read adjacent remarks for AIL Xs. 6. Execute Controllability Check procedure. <ul style="list-style-type: none"> • Flaps HALF or FULL • DO NOT EXCEED ON-SPEED AOA. <p>FOR LANDING</p> <ol style="list-style-type: none"> 1. Fly a straight-in approach. 2. Make an arrested landing (if practical). <p>If arrested landing not practical -</p> <ol style="list-style-type: none"> 3. Avoid longitudinal stick inputs during landing rollout (e.g., aerobraking). 4. Use emergency brakes with steady brake pressure (DO NOT PUMP). Anti-skid is not available. 5. Consider paddle switch - PRESS after touchdown to preserve APU ACCUM pressure for slow speed NWS. <p>Once stopped on runway -</p> <ol style="list-style-type: none"> 6. Do not taxi (even if HYD 2A caution is removed).

Figure 12-1. Warning/Caution/Advisory Displays (Sheet 49)

HYD Cautions

INDICATOR	• CAUSE / REMARKS	CORRECTIVE ACTION
<p>HYD 1A HYD 2B</p>	<ul style="list-style-type: none"> Dual HYD circuit failure (<1,400 psi). <p>Flight control surfaces affected:</p> <ul style="list-style-type: none"> Both TEFs lost Right rudder lost (faired and damped) Right stabilator lost <p>With HYD 2B failed:</p> <ul style="list-style-type: none"> No hook retraction <p>Left and/or right AIL Xs will occur if switching valve is slow/fails to switch.</p> <ul style="list-style-type: none"> FCS RESET recovers surface only if hydraulic pressure present. <p>Remarks for any surface off:</p> <ul style="list-style-type: none"> General Limits: <ul style="list-style-type: none"> 10° AOA for flaps AUTO On-speed AOA for flaps HALF/FULL 2g max Minimize sideslip Half lateral stick Loss of speedbrake Loss of autopilot <p>Remarks for TEF/STAB/RUD Xs:</p> <div style="border: 1px solid black; padding: 5px; text-align: center; margin: 10px 0;">WARNING</div> <p>Full opposing rudder may not be sufficient to prevent a departure when single engine if MAX power selected. Large single engine throttle transients can cause significant yaw and roll.</p> <ul style="list-style-type: none"> TEF driven to 5° TED and locked. Approach speeds are significantly higher and on-speed power settings are near idle. Approach speeds for field landing may be near the maximum nose tire speed (195 KGS). <div style="border: 1px solid black; padding: 5px; text-align: center; margin: 10px 0;">WARNING</div> <p>Expect slower engine response to throttle changes which may result in excessive sink rates under high WOD conditions. The recovery WOD should be kept as close as possible to the Aircraft Recovery Bulletin recommendations.</p> <ul style="list-style-type: none"> Aircraft response to power corrections is sluggish and small in magnitude. Power corrections will translate into an airspeed change before a rate of descent change is noted. Expect larger, longer, and more anticipatory power corrections to be required in order to effect a glideslope change. Aggressive, well-timed, and anticipatory throttle inputs are key to glideslope control. There is a tendency to over-control power due to the low approach power setting and the longer time required to effect a change. Time to achieve positive rate of climb is longer during a bolter/waveoff due to sluggish throttle response. Climb-out attitude will appear flatter than normal. Rudder toe-in is removed. Bolter performance degraded. <div style="border: 1px solid black; padding: 5px; text-align: center; margin: 10px 0;">WARNING</div> <p>Because of right rudder and stabilator loss, bolter performance will be degraded due to the lack of rudder toe-in and aircraft yawing left, into good stab, when stab deflects TEU in preparation for nose rotation. Yaw rate may be sudden and pronounced, but controllable using rudder/NWS.</p> <ul style="list-style-type: none"> Counter any roll-off with rudder. Countering roll-off with lateral stick alone increases adverse yaw and aggravates roll-off. Line-up control is degraded. Make slow and smooth line-up corrections (especially if single engine). Departure resistance is degraded above on-speed AOA. 	<p>High approach speeds will likely preclude CV landing. Divert if able.</p> <ol style="list-style-type: none"> Airspeed - Maintain below 300 KCAS AOA - MAINTAIN BELOW 10° Land as soon as practical. <p>If aileron Xs -</p> <ol style="list-style-type: none"> FCS RESET button - PUSH (multiple times if required) <p>If aileron Xs remain -</p> <ol style="list-style-type: none"> Read remarks for AIL Xs. <p>In all cases -</p> <ol style="list-style-type: none"> Read adjacent remarks for TEF/STAB/RUD Xs. Execute Controllability Check procedure. <ul style="list-style-type: none"> Flaps HALF DO NOT EXCEED ON-SPEED AOA. Adjust gross weight to the minimum practical. <p>FOR LANDING</p> <ol style="list-style-type: none"> FLAP switch - HALF Fly a straight-in approach. Make an arrested landing (if practical). <p>If arrested landing not practical -</p> <ol style="list-style-type: none"> Avoid longitudinal stick inputs during landing rollout (e.g., aerobraking).

Figure 12-1. Warning/Caution/Advisory Displays (Sheet 50)

HYD Cautions

INDICATOR	• CAUSE / REMARKS	CORRECTIVE ACTION
<p>HYD 1B HYD 2A</p>	<ul style="list-style-type: none"> • Dual HYD circuit failure (<1,400 psi). <p>Flight control surfaces affected:</p> <ul style="list-style-type: none"> • Both LEFs frozen • Left rudder lost (faired and damped) • Left stabilator lost • Both LEX spoilers lost • TEFs held frozen in flaps AUTO <p>With HYD 2A failed:</p> <ul style="list-style-type: none"> • No landing gear retraction/normal extension • No normal NWS (flashing NWS in HUD) • No normal braking • No anti-skid • No probe retraction/normal extension • No launch bar extension • No gun <p>Remarks for any surface off:</p> <ul style="list-style-type: none"> • General Limits: <ul style="list-style-type: none"> • 10° AOA for flaps AUTO • On-speed AOA for flaps HALF/FULL • 2g max • Minimize sideslip • Half lateral stick • Loss of speedbrake • Loss of autopilot <p>Remarks for LEF/STAB/RUD Xs:</p> <div style="border: 1px solid black; padding: 5px; text-align: center; width: fit-content; margin: 10px auto;">WARNING</div> <p>Full opposing rudder may not be sufficient to prevent a departure when single engine if MAX power selected. Large single engine throttle transients can cause significant yaw and roll.</p> <ul style="list-style-type: none"> • Stall margin reduced for LEF locked above 5° LED. • Buffet likely with LEF near 0° at lower AOA. • Expect slight roll-off as airspeed changes during a waveoff or bolter that is easily controllable. • Glideslope control degradations may be more pronounced depending on frozen LEF position. Wing stores will further degrade glideslope control. • Power corrections will translate into an airspeed change before a rate of descent change is noticed. This may lead to a tendency to over-control glideslope. Anticipatory throttle inputs are key to glideslope control. • Rudder toe-in is removed. Bolter/waveoff performance is degraded and climb-out attitude will appear flatter than normal. <div style="border: 1px solid black; padding: 5px; text-align: center; width: fit-content; margin: 10px auto;">WARNING</div> <p>Because of left rudder and stabilator loss, bolter performance will be degraded due to the lack of rudder toe-in and aircraft yawing right, into good stab, when stab deflects TEU in preparation for nose rotation. Yaw rate may be sudden and pronounced, and not easily controlled because of failed left rudder and no normal NWS.</p> <ul style="list-style-type: none"> • Counter any roll-off with rudder. Countering roll-off with lateral stick alone increases adverse yaw and aggravates roll-off. • Line-up control is degraded. Make slow and smooth line-up corrections (especially if single engine). • Departure resistance is degraded above on-speed AOA. • If AUTO is selected after being in flaps HALF or FULL, the TEFs will not retract except for loads alleviation (no higher than 17°). While in AUTO, momentary selection of GAIN ORIDE will command the TEFs to retract to 4° TED. However, the operating LEF will also be commanded to move to 5° LED. This may drive a controllable but undesirable left versus right LEF split if the failed LEF is not near 5° LED. Therefore, only select GAIN ORIDE if TEF retraction is essential for range or fuel considerations. 	<p>1. Airspeed - Maintain below 300 KCAS 2. AOA - MAINTAIN BELOW 10° 3. Land as soon as practical. 4. PROBE switch - EMERG EXTD (if required) 5. Read adjacent remarks for LEF/STAB/RUD Xs. 6. Execute Controllability Check procedure.</p> <ul style="list-style-type: none"> • Flaps HALF • DO NOT EXCEED ON-SPEED AOA. • Adjust gross weight to the minimum practical. <p>FOR LANDING</p> <ol style="list-style-type: none"> 1. Fly a straight-in approach. 2. Make an arrested landing (if practical). <p>If arrested landing not practical -</p> <ol style="list-style-type: none"> 3. Avoid longitudinal stick inputs during landing rollout (e.g., aerobraking). 4. Use emergency brakes with steady brake pressure (DO NOT PUMP). Anti-skid is not available. 5. Consider paddle switch - PRESS after touchdown to preserve APU ACCUM pressure for slow speed NWS. <p>Once stopped on runway -</p> <ol style="list-style-type: none"> 6. Do not taxi (even if HYD 2A caution is removed).

Figure 12-1. Warning/Caution/Advisory Displays (Sheet 51)

HYD Cautions

INDICATOR	• CAUSE / REMARKS	CORRECTIVE ACTION
HYD 1B HYD 2B	<ul style="list-style-type: none"> • Dual HYD circuit failure (<1,400 psi). <p>Flight control surface affected:</p> <ul style="list-style-type: none"> • Left aileron lost (faired and damped) <p>With HYD 2B failed:</p> <ul style="list-style-type: none"> • No hook retraction <p>Left LEF, left RUD, and/or right RUD Xs will occur if switching valve is slow/fails to switch.</p> <ul style="list-style-type: none"> • FCS RESET recovers surface only if hydraulic pressure present. <p>Remarks for any surface off:</p> <ul style="list-style-type: none"> • General Limits: <ul style="list-style-type: none"> • 10° AOA for flaps AUTO • On-speed AOA for flaps HALF/FULL • 2g max • Minimize sideslip • Half lateral stick • Loss of speedbrake • Loss of autopilot <p>Remarks for AIL Xs:</p> <ul style="list-style-type: none"> • Expect slightly higher approach speeds. For flaps FULL, approach speed will be increased by about 11 knots. Flaps HALF, 17 knots. • Avoid over-controlling lateral stick inputs as it can cause lateral PIO especially when approaching touchdown. 	<ol style="list-style-type: none"> 1. Airspeed - Maintain below 350 KCAS 2. Land as soon as practical. <p>If any RUD and/or left LEF Xs -</p> <ol style="list-style-type: none"> 3. FCS RESET button - PUSH (multiple times if required) <p>If any RUD and/or left LEF Xs remain -</p> <ol style="list-style-type: none"> 4. Read adjacent remarks for AIL Xs and RUD and/or LEF Xs. 5. Execute Controllability Check procedure. <ul style="list-style-type: none"> • Flaps HALF • DO NOT EXCEED ON-SPEED AOA. <p>If only left AIL Xs -</p> <ol style="list-style-type: none"> 4. Read adjacent remarks for AIL Xs. 5. Execute Controllability Check procedure. <ul style="list-style-type: none"> • Flaps HALF or FULL • DO NOT EXCEED ON-SPEED AOA. <p>FOR LANDING</p> <ol style="list-style-type: none"> 1. Fly a straight-in approach.

Figure 12-1. Warning/Caution/Advisory Displays (Sheet 52)

HYD Cautions

INDICATOR	• CAUSE / REMARKS	CORRECTIVE ACTION
<p>HYD 2A HYD 2B</p>	<ul style="list-style-type: none"> • Dual right HYD circuit failure (<1,400 psi). (a) Right HYD pump internal failure (needle NOT stabilized at zero). May be accompanied by HYD2 HOT caution. (b) HYD 2 leak which could not be isolated by RLS (preceded by RLS circuit caution sequencing). (c) Right HYD pump shaft shear (needle stabilized at zero). (d) Right power transmission shaft failure (accompanied by R GEN, R DC FAIL, and R BOOST LO cautions). <p>With HYD 2A/2B failed:</p> <ul style="list-style-type: none"> • No landing gear retraction/normal extension • No normal NWS (flashing NWS in HUD) • No normal braking • No anti-skid • No probe retraction/normal extension • No launch bar extension • No gun • No hook retraction <p>Left AIL, right RUD, and/or right LEF Xs will occur if switching valve is slow/fails to switch.</p> <ul style="list-style-type: none"> • FCS RESET recovers surface only if hydraulic pressure present. <div style="text-align: center;">  </div> <p>Prolonged use of a failed hydraulic pump without the pump shaft shearing as indicated by the needle not stabilized at zero will generate considerable heat and may result in an AMAD bay fire. Consider restarting the engine prior to landing.</p>	<ol style="list-style-type: none"> 1. Throttle RIGHT engine - IDLE 2. Airspeed - Maintain below 350 KCAS 3. Land as soon as practical. 4. PROBE switch - EMERG EXTD (if required) <p>If HYD 2 needle NOT stabilized at zero -</p> <ol style="list-style-type: none"> 5. Throttle RIGHT engine - OFF <p>If HYD2 HOT caution never displayed -</p> <ol style="list-style-type: none"> 6. Consider restart for landing (if required). <p>If left AIL, right RUD and/or right LEF Xs -</p> <ol style="list-style-type: none"> 7. FCS RESET button - PUSH (multiple times if required) <p>If left AIL, right RUD and/or right LEF Xs remain -</p> <ol style="list-style-type: none"> 8. Read remarks for AIL, RUD, and/or LEF Xs. 9. Execute Controllability Check procedure. <ul style="list-style-type: none"> • Flaps HALF (Flaps FULL check acceptable if no RUD or LEF Xs) • DO NOT EXCEED ON-SPEED AOA. <p>If no Xs -</p> <ol style="list-style-type: none"> 7. Consider Select Jettison unwanted stores prior to gear extension (if single engine, consider desired max gross landing weight). 8. Execute Landing Gear Emergency Extension procedure. <ul style="list-style-type: none"> • Flaps HALF if single engine <p>FOR LANDING</p> <p>If single engine -</p> <ol style="list-style-type: none"> 1. Execute Single Engine Approach and Landing procedure. <p>If both engines running -</p> <ol style="list-style-type: none"> 1. FLAP switch - HALF (Flaps FULL acceptable if no RUD or LEF Xs) 2. Fly a straight-in approach. 3. Make an arrested landing (if practical). <p>If arrested landing not practical -</p> <ol style="list-style-type: none"> 4. Use emergency brakes with steady brake pressure (DO NOT PUMP). Anti-skid is not available. 5. Consider paddle switch - PRESS after touch-down to preserve APU ACCUM pressure for slow speed NWS. <p>Once stopped on runway -</p> <ol style="list-style-type: none"> 6. Do not taxi (even if HYD 2A caution is removed).

Figure 12-1. Warning/Caution/Advisory Displays (Sheet 53)

HYD Cautions

INDICATOR	• CAUSE / REMARKS	CORRECTIVE ACTION
<p>HYD 1A HYD 1B HYD 2A</p>	<ul style="list-style-type: none"> • Triple HYD circuit failure (<1,400 psi). <p>Flight control surfaces affected:</p> <ul style="list-style-type: none"> • Both LEFs frozen • Right aileron lost (faired and damped) • Left rudder lost (faired and damped) • Left stabilator lost • Both LEX spoilers lost • TEFs held frozen in flaps AUTO <p>With HYD 2A failed:</p> <ul style="list-style-type: none"> • No landing gear retraction/normal extension • No normal NWS (flashing NWS in HUD) • No normal braking • No anti-skid • No probe retraction/normal extension • No launch bar extension • No gun <div style="border: 2px solid black; padding: 5px; text-align: center; width: fit-content; margin: 10px auto;">WARNING</div> <p>Jettison all stores prior to flaps HALF transition since the transition with stores results in an uncontrollable nose-up tendency.</p> <p>Remarks for any surface off:</p> <ul style="list-style-type: none"> • General Limits: <ul style="list-style-type: none"> • 10° AOA for flaps AUTO • On-speed AOA for flaps HALF/FULL • 2g max • Minimize sideslip • Half lateral stick • Loss of speedbrake • Loss of autopilot <p>Remarks for AIL/RUD/STAB/LEF Xs:</p> <ul style="list-style-type: none"> • Flaps AUTO flying qualities acceptable. Enough lateral trim authority is available to balance the failure induced roll-off up to Mach 0.85. <div style="border: 2px solid black; padding: 5px; text-align: center; width: fit-content; margin: 10px auto;">WARNING</div> <p>Full opposing rudder may not be sufficient to prevent a departure when single engine if MAX power selected. Large single engine throttle transients can cause significant yaw and roll.</p> <div style="border: 2px solid black; padding: 5px; text-align: center; width: fit-content; margin: 10px auto;">CAUTION</div> <p>Flaps HALF transition from a clean configuration can be accomplished (expect a LWD roll near on-speed AOA). Carrier approach is possible but exhibits sloppy directional/centerline control. In the event of a field bolter, the decision to go around should be made immediately upon recognition of a missed wire as rudder power may be insufficient to maintain directional control below 140 KCAS.</p> <ul style="list-style-type: none"> • Expect slightly higher approach speeds. For flaps FULL, approach speed will be increased by about 11 knots. Flaps HALF, 17 knots. • Line-up control is degraded. Avoid over-controlling lateral stick inputs as it can cause lateral PIO especially when approaching touchdown. • Rudder toe-in is removed. Bolter/waveoff performance degraded. Climb-out attitude will appear flatter than normal. <p style="text-align: center; font-size: 1.2em; font-weight: bold; margin-top: 20px;">CONTINUED</p>	<p>May be uncontrollable in flaps HALF if stores not jettisoned prior to transition to flaps HALF. If HYD1 HOT caution appears, consider securing left engine until preparing for landing. Departure is probable if left engine is secured.</p> <ol style="list-style-type: none"> 1. Throttle LEFT engine - IDLE 2. Airspeed - Maintain below 300 KCAS 3. AOA - MAINTAIN BELOW 10° 4. Land as soon as possible. 5. PROBE switch - EMERG EXTND (if required) <p>If HYD 1 needle stabilized at zero -</p> <ol style="list-style-type: none"> 6. DO NOT secure left engine. <p>If HYD 1 needle NOT stabilized at zero -</p> <ol style="list-style-type: none"> 6. Consider securing LEFT engine. <ul style="list-style-type: none"> • DEPARTURE IS PROBABLE IF LEFT ENGINE IS SECURED. • IF SINGLE ENGINE, DEPARTURE IS LIKELY WITH THE USE OF AFTER-BURNER. 7. Read adjacent remarks for AIL/RUD/STAB/LEF Xs. 8. EMERG JETT button - PUSH (prior to landing gear extension) 9. Execute Controllability Check procedure. <ul style="list-style-type: none"> • Flaps HALF • DO NOT EXCEED ON-SPEED AOA. • Adjust gross weight to the minimum practical. <p>FOR LANDING</p> <p>If single engine -</p> <ol style="list-style-type: none"> 1. Execute Single Engine Approach and Landing procedure. <p>If both engines running -</p> <ol style="list-style-type: none"> 1. Fly a straight-in approach. 2. Make an arrested landing (if practical). <p>If arrested landing not practical -</p> <ol style="list-style-type: none"> 3. Avoid longitudinal stick inputs during landing roll-out (e.g., aerobraking). 4. Use emergency brakes with steady brake pressure (DO NOT PUMP). Anti-skid is not available. 5. Consider paddle switch - PRESS after touchdown to preserve APU ACCUM pressure for slow speed NWS. <p>Once stopped on runway -</p> <ol style="list-style-type: none"> 6. Do not taxi (even if HYD 2A caution is removed).

Figure 12-1. Warning/Caution/Advisory Displays (Sheet 54)

HYD Cautions

INDICATOR	• CAUSE / REMARKS (continued)	CORRECTIVE ACTION
HYD 1A HYD 1B HYD 2A (continued)	<div style="text-align: center; border: 2px solid black; padding: 5px; width: fit-content; margin: 0 auto 10px auto;"> WARNING </div> <p>Because of left rudder and stabilator loss, bolter performance will be degraded due to the lack of rudder toe-in and aircraft yawing right, into good stab, when stab deflects TEU in preparation for nose rotation. Yaw rate may be sudden and pronounced, and not easily controlled because of failed left rudder and no normal NWS.</p> <ul style="list-style-type: none"> • Counter any roll-off with rudder. Countering roll-off with lateral stick alone increases adverse yaw and aggravates roll-off. • Stall margin reduced for LEF locked above 5° LED. • Buffet likely with LEF near 0° at lower AOAs. • Power corrections will translate into an airspeed change before a rate of descent change is noticed. This may lead to a tendency to over-control glide-slope. Anticipatory throttle inputs are key to glide-slope control. • Departure resistance is degraded above on-speed AOA. • If AUTO is selected after being in flaps HALF or FULL, the TEFs will not retract except for loads alleviation (no higher than 17°). While in AUTO, momentary selection of GAIN ORIDE will command the TEFs to retract to 4° TED. However, the operating LEF will also be commanded to move to 5° LED. This may drive a controllable but undesirable left versus right LEF split if the failed LEF is not near 5° LED. Therefore, only select GAIN ORIDE if TEF retraction is essential for range or fuel considerations. 	

Figure 12-1. Warning/Caution/Advisory Displays (Sheet 55)

HYD Cautions

INDICATOR	• CAUSE / REMARKS	CORRECTIVE ACTION
<p>HYD 1A HYD 1B HYD 2B</p>	<ul style="list-style-type: none"> • Triple HYD circuit failure (<1,400 psi). <p>Flight control surfaces affected:</p> <ul style="list-style-type: none"> • Both TEFs lost • Left aileron lost (faired and damped) • Right rudder lost (faired and damped) • Right stabilator lost <p>With HYD 2B failed:</p> <ul style="list-style-type: none"> • No hook retraction <p>Remarks for any surface off:</p> <p>General Limits:</p> <ul style="list-style-type: none"> • 10° AOA for flaps AUTO • On-speed AOA for flaps HALF/FULL • 2g max • Minimize sideslip • Half lateral stick <ul style="list-style-type: none"> • Loss of speedbrake • Loss of autopilot <p>Remarks for AIL/RUD/STAB/TEF Xs:</p> <div style="border: 2px solid black; padding: 5px; text-align: center; width: fit-content; margin: 10px auto;">WARNING</div> <ul style="list-style-type: none"> • Full opposing rudder may not be sufficient to prevent a departure when single engine if MAX power selected. Large single engine throttle transients can cause significant yaw and roll. • Slower engine response to throttle changes may result in excessive sink rates under high WOD conditions. The recovery WOD should be kept as close as possible to the Aircraft Recovery Bulletin recommendations. <ul style="list-style-type: none"> • Expect loose and sluggish response in flaps HALF, with high approach speeds due to TEF failure. • Expect slightly higher approach speeds. • Avoid over-controlling lateral stick inputs as it can cause lateral PIO especially when approaching touch-down. • Rudder toe-in is removed. Bolter performance degraded. <div style="border: 2px solid black; padding: 5px; text-align: center; width: fit-content; margin: 10px auto;">WARNING</div> <p>Because of right rudder and stabilator loss, bolter performance will be degraded due to the lack of rudder toe-in and aircraft yawing left, into good stab, when stab deflects TEU in preparation for nose rotation. Yaw rate may be sudden and pronounced, but controllable with rudder/NWS.</p> <ul style="list-style-type: none"> • Counter any roll-off with rudder. Countering roll-off with lateral stick alone increases adverse yaw and aggravates roll-off. • Line-up control is degraded. Make slow and smooth line-up corrections (especially if single engine). • TEF driven to 5° TED and locked. • Approach speeds are significantly higher and on-speed power settings are near idle. • Approach speeds for field landing may be near the maximum nose tire speed (195 KGS). If making an arrested landing, take maximum arresting gear engagement speed into consideration. • Expect slower engine response. <p style="text-align: center; font-size: 1.5em; font-weight: bold; margin-top: 20px;">CONTINUED</p>	<p>High approach speeds will likely preclude CV landing. Divert if able. If HYD1 HOT caution appears, consider securing left engine until preparing for landing. Departure is probable if left engine is secured.</p> <ol style="list-style-type: none"> 1. Throttle LEFT engine - IDLE 2. Airspeed - Maintain below 300 KCAS 3. AOA - MAINTAIN BELOW 10° 4. Land as soon as possible. <p>If HYD 1 needle stabilized at zero -</p> <ol style="list-style-type: none"> 5. DO NOT secure left engine. <p>If HYD 1 needle NOT stabilized at zero -</p> <ol style="list-style-type: none"> 5. Consider securing LEFT engine. <ul style="list-style-type: none"> • DEPARTURE IS PROBABLE IF LEFT ENGINE IS SECURED. • IF SINGLE ENGINE, DEPARTURE IS LIKELY WITH THE USE OF AFTER-BURNER. <ol style="list-style-type: none"> 6. Read adjacent remarks for AIL/RUD/STAB/TEF Xs. 7. Execute Controllability Check procedure. <ul style="list-style-type: none"> • Flaps HALF • DO NOT EXCEED ON-SPEED AOA. • Adjust gross weight to the minimum practical. <p>FOR LANDING</p> <p>If single engine -</p> <ol style="list-style-type: none"> 1. Execute Single Engine Approach and Landing procedure. <p>If both engines running -</p> <ol style="list-style-type: none"> 1. Fly a straight-in approach. 2. Make an arrested landing (if practical). <p>If arrested landing not practical -</p> <ol style="list-style-type: none"> 3. Avoid longitudinal stick inputs during landing roll-out (e.g., aerobraking).

Figure 12-1. Warning/Caution/Advisory Displays (Sheet 56)

HYD Cautions

INDICATOR	• CAUSE / REMARKS (continued)	CORRECTIVE ACTION
HYD 1A HYD 1B HYD 2B (continued)	<ul style="list-style-type: none"> • Aircraft response to power corrections is sluggish and small in magnitude. Power corrections will translate into an airspeed change before a rate of descent change is noted. Expect larger, longer, and more anticipatory power corrections to be required in order to effect a glideslope change. Aggressive, well-timed, and anticipatory throttle inputs are key to glideslope control. • There is a tendency to over-control power due to the low approach power setting and the longer time required to effect a change. • Time to achieve positive rate of climb is longer during a bolter/waveoff due to sluggish throttle response. Climb-out attitude will appear flatter than normal. • Departure resistance is degraded above on-speed AOA. 	

Figure 12-1. Warning/Caution/Advisory Displays (Sheet 57)

HYD Cautions

INDICATOR	• CAUSE / REMARKS	CORRECTIVE ACTION
<p>HYD 1A HYD 2A HYD 2B</p>	<ul style="list-style-type: none"> • Triple HYD circuit failure (<1,400 psi). <p>Flight control surfaces affected:</p> <ul style="list-style-type: none"> • Both TEFs lost • Right aileron lost (faired and damped) • Right rudder lost (faired and damped) • Right stabilator lost <p>With HYD 2A/2B failed:</p> <ul style="list-style-type: none"> • No landing gear retraction/normal extension • No normal NWS (flashing NWS in HUD) • No normal braking • No anti-skid • No probe retraction/normal extension • No launch bar extension • No gun • No hook retraction <p>Remarks for any surface off:</p> <ul style="list-style-type: none"> • General Limits: <ul style="list-style-type: none"> • 10° AOA for flaps AUTO • On-speed AOA for flaps HALF/FULL • 2g max • Minimize sideslip • Half lateral stick • Loss of speedbrake • Loss of autopilot <p>Remarks for AIL/RUD/STAB/TEF Xs:</p> <div style="border: 2px solid black; padding: 5px; text-align: center; width: fit-content; margin: 10px auto;">WARNING</div> <p>Full opposing rudder may not be sufficient to prevent a departure when single engine if MAX power selected. Large single engine throttle transients can cause significant yaw and roll.</p> <div style="border: 2px solid black; padding: 5px; text-align: center; width: fit-content; margin: 10px auto;">CAUTION</div> <p>In flaps AUTO, full LWD lateral trim and half lateral stick are required to keep wings level at Mach 0.7 and 20,000 feet, while full lateral trim is required at Mach 0.6 and 20,000 feet. Lateral authority is lost around 14° AOA. Transition to flaps HALF/FULL may be safely accomplished with or without stores. Consider SEL JETT right wing stores to balance failure-induced roll.</p> <ul style="list-style-type: none"> • Approach speeds are significantly higher and on-speed power settings are near idle. • Approach speeds for field landing may be near the maximum nose tire speed (195 KGS). If making an arrested landing, take maximum arresting gear engagement speed into consideration. • Expect slower engine response. <p style="text-align: center; font-size: 1.5em;">CONTINUED</p>	<p>High approach speeds will likely preclude CV landing. Divert if able. If HYD2 HOT caution appears, consider securing right engine until preparing for landing. Departure is probable if right engine is secured.</p> <ol style="list-style-type: none"> 1. Throttle RIGHT engine - IDLE 2. Airspeed - Maintain below 300 KCAS 3. AOA - MAINTAIN BELOW 10° 4. Land as soon as possible. 5. PROBE switch - EMERG EXT D (if required) <p>If HYD 2 needle stabilized at zero -</p> <ol style="list-style-type: none"> 6. DO NOT secure right engine. <p>If HYD 2 needle NOT stabilized at zero -</p> <ol style="list-style-type: none"> 6. Consider securing RIGHT engine. <ul style="list-style-type: none"> • DEPARTURE IS PROBABLE IF RIGHT ENGINE IS SECURED. • IF SINGLE ENGINE, DEPARTURE IS LIKELY WITH THE USE OF AFTER-BURNER. 7. Read adjacent remarks for AIL/RUD/STAB/TEF Xs. 8. Execute Controllability Check procedure. <ul style="list-style-type: none"> • Flaps HALF • DO NOT EXCEED ON-SPEED AOA. • Adjust gross weight to the minimum practical. <p>FOR LANDING</p> <p>If single engine -</p> <ol style="list-style-type: none"> 1. Execute Single Engine Approach and Landing procedure. <p>If both engines running -</p> <ol style="list-style-type: none"> 1. Fly a straight-in approach. 2. Make an arrested landing (if practical). <p>If arrested landing not practical -</p> <ol style="list-style-type: none"> 3. Avoid longitudinal stick inputs during landing roll-out (e.g., aerobraking). 4. Use emergency brakes with steady brake pressure (DO NOT PUMP). Anti-skid is not available. 5. Consider paddle switch - PRESS after touchdown to preserve APU ACCUM pressure for slow speed NWS. <p>Once stopped on runway -</p> <ol style="list-style-type: none"> 6. Do not taxi (even if HYD 2A caution is removed).

Figure 12-1. Warning/Caution/Advisory Displays (Sheet 58)

HYD Cautions

INDICATOR	• CAUSE / REMARKS (continued)	CORRECTIVE ACTION
<p>HYD 1A HYD 2A HYD 2B (continued)</p>	<ul style="list-style-type: none"> Aircraft response to power corrections is sluggish and small in magnitude. Power corrections will translate into an airspeed change before a rate of descent change is noted. Expect larger, longer, and more anticipatory power corrections to be required in order to effect a glideslope change. Aggressive, well-timed, and anticipatory throttle inputs are key to glideslope control. <p style="text-align: center;">WARNING</p> <p>Slower engine response to throttle changes may result in excessive sink rates under high WOD conditions. The recovery WOD should be kept as close as possible to the Aircraft Recovery Bulletin recommendations.</p> <ul style="list-style-type: none"> There is a tendency to over-control power due to the low approach power setting and the longer time required to effect a change. Time to achieve positive rate of climb is longer during a bolter/waveoff due to sluggish throttle response. Climb-out attitude will appear flatter than normal. Rudder toe-in is removed. Bolter performance degraded. <p style="text-align: center;">WARNING</p> <p>Because of right rudder and stabilator loss, bolter performance will be degraded due to the lack of rudder toe-in and aircraft yawing left, into good stab, when stab deflects TEU in preparation for nose rotation. Yaw rate may be sudden and pronounced, and not easily controlled because of failed right rudder and no normal NWS.</p> <ul style="list-style-type: none"> Counter any roll-off with rudder. Countering roll-off with lateral stick alone increases adverse yaw and aggravates roll-off. Line-up control is degraded. Make slow and smooth line-up corrections (especially if single engine). Departure resistance is degraded above on-speed AOA. 	

Figure 12-1. Warning/Caution/Advisory Displays (Sheet 59)

HYD Cautions

INDICATOR	• CAUSE / REMARKS	CORRECTIVE ACTION
<p>HYD 1B HYD 2A HYD 2B</p>	<ul style="list-style-type: none"> • Triple HYD circuit failure (<1,400 psi). <p>Flight control surfaces affected:</p> <ul style="list-style-type: none"> • Both LEFs frozen • Left aileron lost (faired and damped) • Left rudder lost (faired and damped) • Left stabilator lost • Both LEX spoilers lost • TEFs held frozen in flaps AUTO <p>With HYD 2A/2B failed:</p> <ul style="list-style-type: none"> • No landing gear retraction/normal extension • No normal NWS (flashing NWS in HUD) • No normal braking • No anti-skid • No probe retraction/normal extension • No launch bar extension • No gun • No hook retraction <div style="border: 2px solid black; padding: 5px; text-align: center; width: fit-content; margin: 10px auto;">WARNING</div> <p>Maintain FLAP switch in AUTO. Transition to flaps HALF/FULL results in an uncontrollable nose-up tendency.</p> <p>Remarks for any surface off:</p> <ul style="list-style-type: none"> • General Limits: <ul style="list-style-type: none"> • 10° AOA for flaps AUTO • On-speed AOA for flaps HALF/FULL • 2g max • Minimize sideslip • Half lateral stick • Loss of speedbrake • Loss of autopilot <p>Remarks for AIL/RUD/STAB/LEF Xs:</p> <ul style="list-style-type: none"> • Flaps AUTO flying qualities are acceptable with smooth lateral stick inputs. Wings level can be maintained up to Mach 0.85. Piloted simulation determined that flaps AUTO approach and landing is controllable. A 10° AOA approach to reduce approach speed is recommended. <div style="border: 2px solid black; padding: 5px; text-align: center; width: fit-content; margin: 10px auto;">WARNING</div> <p>Full opposing rudder may not be sufficient to prevent a departure when single engine if MAX power selected. Large single engine throttle transients can cause significant yaw and roll.</p> <ul style="list-style-type: none"> • Expect slightly higher approach speeds. • Line-up control is degraded. Avoid over-controlling lateral stick inputs as it can cause lateral PIO especially when approaching touchdown. • Rudder toe-in is removed. Bolter performance degraded. <div style="border: 2px solid black; padding: 5px; text-align: center; width: fit-content; margin: 10px auto;">WARNING</div> <p>Because of left rudder and stabilator loss, bolter performance will be degraded due to the lack of rudder toe-in and aircraft yawing right, into good stab, when stab deflects TEU in preparation for nose rotation. Yaw rate may be sudden and pronounced, and not easily controlled because of failed left rudder and no normal NWS.</p> <p style="text-align: center; font-size: 1.2em; font-weight: bold; margin-top: 20px;">CONTINUED</p>	<p>Uncontrollable during transition from flaps AUTO to flaps HALF/FULL. Flaps AUTO approach required. High approach speeds will likely preclude CV landing. Divert if able. If HYD2 HOT caution appears, consider securing right engine until preparing for landing. Departure is probable if right engine is secured.</p> <ol style="list-style-type: none"> 1. Throttle RIGHT engine - IDLE 2. Airspeed - Maintain below 300 KCAS 3. AOA - MAINTAIN BELOW 10° 4. Land as soon as possible. 5. PROBE switch - EMERG EXT D (if required) <p>If HYD 2 needle stabilized at zero -</p> <ol style="list-style-type: none"> 6. DO NOT secure right engine. <p>If HYD 2 needle NOT stabilized at zero -</p> <ol style="list-style-type: none"> 6. Consider securing RIGHT engine. <ul style="list-style-type: none"> • DEPARTURE IS PROBABLE IF RIGHT ENGINE IS SECURED. • IF SINGLE ENGINE, DEPARTURE IS LIKELY WITH THE USE OF AFTER-BURNER. 7. Read adjacent remarks for AIL/RUD/STAB/LEF Xs. 8. Execute Controllability Check procedure. <ul style="list-style-type: none"> • Flaps AUTO • DO NOT EXCEED ON-SPEED AOA. • Adjust gross weight to the minimum practical. <p>FOR LANDING</p> <p>If single engine -</p> <ol style="list-style-type: none"> 1. Execute Single Engine Approach and Landing procedure. <ul style="list-style-type: none"> • Flaps AUTO <p>If both engines running -</p> <ol style="list-style-type: none"> 1. FLAP switch - AUTO 2. Fly a straight-in approach. 3. Make an arrested landing (if practical). <p>If arrested landing not practical -</p> <ol style="list-style-type: none"> 4. Avoid longitudinal stick inputs during landing rollout (e.g., aerobraking). 5. Use emergency brakes with steady brake pressure (DO NOT PUMP). Anti-skid is not available. 6. Consider paddle switch - PRESS after touchdown to preserve APU ACCUM pressure for slow speed NWS. <p>Once stopped on runway -</p> <ol style="list-style-type: none"> 7. Do not taxi (even if HYD 2A caution is removed).

Figure 12-1. Warning/Caution/Advisory Displays (Sheet 60)

HYD Cautions

INDICATOR	• CAUSE / REMARKS	CORRECTIVE ACTION
HYD 1B HYD 2A HYD 2B (continued)	<ul style="list-style-type: none"> • Counter any roll-off with rudder. Countering roll-off with lateral stick alone increases adverse yaw and aggravates roll-off. • Stall margin reduced for LEF locked above 5° LED. • Buffet likely with LEF near 0° at lower AOAs. • Power corrections will translate into an airspeed change before a rate of descent change is noticed. This may lead to a tendency to over-control glide-slope. Anticipatory throttle inputs are key to glide-slope control. • Bolter/waveoff performance is degraded and climb-out attitude will appear flatter than normal. • Departure resistance is degraded above on-speed AOA. • If AUTO is selected after being in flaps HALF or FULL, the TEFs will not retract except for loads alleviation (no higher than 17°). While in AUTO, momentary selection of GAIN ORIDE will command the TEFs to retract to 4° TED. However, the operating LEF will also be commanded to move to 5° LED. This may drive a controllable but undesirable left versus right LEF split if the failed LEF is not near 5° LED. Therefore, only select GAIN ORIDE if TEF retraction is essential for range or fuel considerations. 	
HYD 5000 <div style="border: 1px solid black; padding: 2px; display: inline-block;">FCES</div> Caution Light	<ul style="list-style-type: none"> • Hydraulic pressure is less than 4,600 psi when 5,000 psi operation is requested from the hydraulic system. <p>Expect degraded flying qualities above 380 KCAS and reduced departure resistance above 650 KCAS. Uncommanded roll possible following aggressive lateral maneuvering at greater than 4g above 650 KCAS.</p>	<p>If above 650 KCAS -</p> <ol style="list-style-type: none"> 1. Do not command rolling maneuvers above 4g. 2. Full symmetric g capability still available.
HYD1 HOT HYD2 HOT	<ul style="list-style-type: none"> • Hydraulic pump case temperature exceeds 400° F and either the respective case drain temperature exceeds 275° F or the respective reservoir temperature exceeds 250° F. <p>May be an indication of an internal hydraulic pump failure.</p> <p>Hydraulic pump overheat may result in pump case failure and fire in the AMAD bay.</p>	<p>*1. Throttle affected engine - OFF 2. Land as soon as practical.</p>

Figure 12-1. Warning/Caution/Advisory Displays (Sheet 61)

DDI Advisories

INDICATOR	• CAUSE / REMARKS	CORRECTIVE ACTION
ABLIM	<ul style="list-style-type: none"> • Afterburner limiting function of the FADEC is activated. <p>The ABLIM function is used during MAX power catapult launches only. ABLIM limits engine power to half afterburner with the throttles at MAX. ABLIM is disabled with an FCC Ch 2 or 4, MC1, FADEC, or INS failure.</p>	Information
ACI	<ul style="list-style-type: none"> • An ACI configuration that is incompatible with TAWS/GPWS is detected. <p>TAWS/GPWS voice alerts are unavailable and are replaced with "whoop/whoop". Visual cues are still available.</p>	Information
AHMD	<ul style="list-style-type: none"> • Aft Quick Disconnect Connector (QDC) is not connected. • Aft QDC is not properly secured to Quick Mounting Bracket (QMB). • Aft coarse alignment is invalid or has not been performed. • Aft Helmet Display Unit (HDU) is not connected to the helmet. 	<ol style="list-style-type: none"> 1. Verify aft HMD properly connected. 2. Verify aft QDC is properly connected and mounted in the QMB. 3. Aft HMD - ALIGN 4. Verify aft HDU is properly connected to the helmet.
ALIGN	<ul style="list-style-type: none"> • INS switched to NAV without a complete alignment. 	1. INS knob - IFA or GYRO
AM DL	<ul style="list-style-type: none"> • Radar hardware needed to support AMRAAM data link not installed. 	Information
ARMAMENT ADVISORIES	<ul style="list-style-type: none"> • Refer to A1-F18EA-TAC-Series. 	
BALT	<ul style="list-style-type: none"> • Autopilot barometric altitude hold mode engaged. 	Information
BIT	<ul style="list-style-type: none"> • Built-in test failure detected. 	1. BIT page - Identify failure
CDATA	<ul style="list-style-type: none"> • Onboard unit other than MU contains classified data. 	Information
CFIT	<ul style="list-style-type: none"> • TAWS/GPWS has been deselected. <p>Protection against CFIT is unavailable.</p>	Information
COM1H COM2H	<ul style="list-style-type: none"> • ARC 210 COM1 or COM2 not loaded with Have Quick time. 	Information
COM1L COM2L	<ul style="list-style-type: none"> • Indicates COMM 1 or COMM 2 is reporting failed checksum or validity fill loading error. <p>When selected on the MUMI page, COMM 1 boxes while the data is downloaded from the AMU to COMM 1 and 2 and unboxes when the download is complete.</p>	<p>With COMM 1 and 2 on -</p> <ol style="list-style-type: none"> 1. MUMI page - SELECT COMM
COM1S COM2S	<ul style="list-style-type: none"> • ARC 210 COM1 or COM2 not loaded with SINGARS time. 	Information

Figure 12-1. Warning/Caution/Advisory Displays (Sheet 62)

DDI Advisories

INDICATOR	• CAUSE / REMARKS	CORRECTIVE ACTION
CONFG	<ul style="list-style-type: none"> All systems have not been checked for configuration compatibility because one or more of the systems is off or not communicating. Typical poststart with RADAR knob in OFF. 	Information
CPLD	<ul style="list-style-type: none"> Autopilot coupled to WYPT, OAP, SEQ #, or TCN. 	Information
CRUIS	<ul style="list-style-type: none"> GAIN switch in ORIDE with FLAP switch in AUTO. 	Information
D BAD	<ul style="list-style-type: none"> ALE-47 dispenser failure. 	Information
D LOW	<ul style="list-style-type: none"> ALE-47 dispenser expendables quantity below set BINGO level. 	Information
DCSCS	<ul style="list-style-type: none"> Indicates a failure of the COMSEC capability has been detected. 	Information
DECM	<ul style="list-style-type: none"> Degrade detected that may result in loss of jamming functionality or jammer interface problems. 	1. BIT/EW/DECM STATUS page - CHECK
EBC	<ul style="list-style-type: none"> The integrity of the DFIRS-stored electronic boresight constants (EBCs) is uncertain. <p>Mode S may be unavailable. Advisory is disabled in flight.</p>	1. BIT/SENSORS/EBC ENTRY page - Verify permanent Mode S address
ECS DR	<ul style="list-style-type: none"> ECS auxiliary duct door not in commanded position. <p>If the advisory is displayed above Mach 0.4, a door is failed open. If the advisory is displayed below Mach 0.32, a door is failed closed. The advisory clears if the doors are in the correct position for flight conditions. The advisory may return if the failure still exists and the flight conditions reoccur. No flight restrictions are imposed as long as airspeed is maintained above Mach 0.4.</p> <div style="text-align: center; border: 2px solid black; padding: 5px; width: fit-content; margin: 10px auto;">WARNING</div> <p>If ECS troubleshooting has been done while on deck, check for an 8A6 MSP Code after takeoff. An 8A6 MSP Code is set by a system flow modulating regulating valve failure. This failure can potentially lead to an unexpected loss of cabin pressurization.</p> <div style="text-align: center; border: 2px dashed black; padding: 5px; width: fit-content; margin: 10px auto;">CAUTION</div> <p>Minimize operation at high power settings below Mach 0.4 with both doors failed closed. A dual bleed shutdown is possible under such conditions.</p>	<p>GROUND</p> <ol style="list-style-type: none"> Do not takeoff. <p>IN FLIGHT</p> <ol style="list-style-type: none"> Accelerate and maintain 0.40 IMN using minimum power. There are no throttle restrictions and the mission may be continued provided airspeed remains above 0.40 IMN to landing. <p>For landing -</p> <ol style="list-style-type: none"> Minimize time below 0.40 IMN. ECS MODE switch - OFF/RAM AV COOL switch - EMERG

Figure 12-1. Warning/Caution/Advisory Displays (Sheet 63)

DDI Advisories

INDICATOR	• CAUSE / REMARKS	CORRECTIVE ACTION
F-QTY	<ul style="list-style-type: none"> Failure in fuel quantity gauging system that may affect fuel quantity indications or FUEL XFER caution display. 	<ol style="list-style-type: none"> Fuel page - CHECK If all fuel quantities invalid - SDC - RESET FLBIT - PERFORM
FADEC	<ul style="list-style-type: none"> Left or right FADEC has lost backup redundancy in one channel. <p>If advisory remains, a level of redundancy is lost. Another engine/control system failure may result in engine shutdown. ABLIM function may not be available.</p>	<p>GROUND</p> <ol style="list-style-type: none"> ENG page - Verify ENG STATUS If ENG STATUS is NORM - Throttle affected engine - OFF ENG page - Push unboxed channel (A or B) on affected engine If dual channel lineouts are removed - Restart affected engine. Continue mission. If ENG STATUS is other than NORM or dual lineouts do not clear - Do not takeoff. <p>IN FLIGHT Information</p>
FCCGN	<ul style="list-style-type: none"> 5-Wet FCC control law gains are no longer being applied. <p>There is possibility of looseness in the flaps AUTO longitudinal flying qualities at certain localized flight conditions. This is not considered to be a safety of flight issue and will not interfere with in-flight refueling operations. The degradation, if any, may become apparent for CGs aft of approximately 30% MAC. Flaps AUTO lateral/directional and all flaps HALF or FULL flying qualities are unaffected by this issue.</p>	Information
FPAH	<ul style="list-style-type: none"> Autopilot flight path angle hold mode engaged. 	Information
FPAS	<ul style="list-style-type: none"> Flight performance advisory system is unable to calculate HOME FUEL caution. 	Information
GPS	<ul style="list-style-type: none"> GPS NORM mode error > 1,000 feet. 	1. INS knob - NAV
GPSMP	<ul style="list-style-type: none"> GPS multi-path is detected. <p>GPS-aided navigation is prevented.</p>	Information
GSEL	<ul style="list-style-type: none"> Autopilot ground track select mode engaged. 	Information
GTRK	<ul style="list-style-type: none"> Autopilot ground track hold mode engaged. 	Information
HDG	<ul style="list-style-type: none"> Autopilot magnetic heading hold mode engaged. 	Information

Figure 12-1. Warning/Caution/Advisory Displays (Sheet 64)

DDI Advisories

INDICATOR	• CAUSE / REMARKS	CORRECTIVE ACTION
LHEAT RHEAT	<ul style="list-style-type: none"> Designated engine anti-ice system is operating. <p>Both advisories should be displayed with the ENG ANTI ICE switch ON. Single advisory displayed during post-start engine anti-ice functional test with the switch OFF. Corresponding advisory is removed if an anti-ice failure is detected.</p>	Information
HEAT	<ul style="list-style-type: none"> Engine anti-ice failure detected while the ENG ANTI ICE switch is OFF. <p>If the ENG ANTI ICE switch is placed to ON, the HEAT advisory is replaced by the HEAT FAIL caution. The corresponding L HEAT or R HEAT advisory is not displayed on the failed side. Engine and inlet device anti-ice capability lost on failed side.</p>	<ol style="list-style-type: none"> Avoid icing conditions. <p>If icing conditions are encountered -</p> <ol style="list-style-type: none"> Refer to Extreme Weather procedures.
HIAOA	<ul style="list-style-type: none"> INS attitude data is not being provided to the FCCs for sideslip and AOA estimation calculations. May be caused by an INS failure (INS ATT caution), by placing the ATT switch to STBY with good INS data, or by an FCC detected failure. Autopilot inoperative. <p>Above approximately 20° AOA in flaps AUTO, the FCCs use INS data for sideslip and sideslip rate feedback to provide roll coordination and departure resistance. When INS data is not available or invalid, the FCCs will no longer use INS data. There is no significant degradation to flying qualities, departure resistance or roll performance with this indication.</p>	<ol style="list-style-type: none"> FCS RESET button - PUSH <p>If advisory remains -</p> <ol style="list-style-type: none"> Monitor any sideslip excursions above 20° AOA in flaps AUTO.
HMD	<ul style="list-style-type: none"> Forward Quick Disconnect Connector (QDC) is not connected. Forward QDC is not properly secured to Quick Mounting Bracket (QMB). Forward coarse alignment is invalid or has not been performed. Forward Helmet Display Unit (HDU) is not connected to the helmet. 	<ol style="list-style-type: none"> Verify forward HMD properly connected. Verify forward QDC is properly connected and mounted in the QMB. Forward HMD - ALIGN Verify forward HDU is properly connected to the helmet.
HOSE	<p>With ARS control panel power switch ON:</p> <ul style="list-style-type: none"> Drogue deployed for normal refueling (wet or dry). Hose reel has failed to secure hose. <p>With ARS control panel power switch OFF, the ARS DROGUE caution message is displayed.</p>	<p>If ARS switch ON and drogue deployed - Information</p> <p>If ARS switch ON and hose reel failed to secure hose -</p> <ol style="list-style-type: none"> Hose EXT/RETR switch - CONFIRM RETR <p>If drogue still does not retract -</p> <ol style="list-style-type: none"> Refer to ARS DROGUE caution.
HSEL	<ul style="list-style-type: none"> Autopilot heading select mode engaged. 	Information
HDU	<ul style="list-style-type: none"> SDC HUD Backup is unavailable. <p>In the event of a dual MC failure, the backup HUD page will not be available on the MPCD or UFCD.</p>	Information

Figure 12-1. Warning/Caution/Advisory Displays (Sheet 65)

DDI Advisories

INDICATOR	• CAUSE / REMARKS	CORRECTIVE ACTION
IFFAI	<ul style="list-style-type: none"> • Fault with the airborne interrogator. Unable to interrogate Mode 4 or cannot interrogate any mode.	1. BIT/COMM/PIDS MAINT - Check Crypto Status If CRYPTO lined out - 2. Reload M4 Crypto. If CRYPTO not lined out - 2. Information: <ul style="list-style-type: none"> • IFF may be DEGD • Unable to interrogate Mode 4 • Unable to solve ROE if M4 not removed
LAND	<ul style="list-style-type: none"> • GAIN switch in ORIDE with the FLAP switch in HALF or FULL. 	Information
L DEGD	<ul style="list-style-type: none"> • LTD/R and/or Marker degrade detected. Laser designation/ranging and/or marking may be unavailable or inaccurate. If ATFLIR installed - ALN DEGD - Neither LTD/R nor Marker will fire due to alignment errors. PWR DEGD - LTD/R power could be deficient for ranging and/or designating. RNG DEGD - Laser ranging will be invalid but designating may still be possible. MRK DEGD - Marker will either not fire or fire at low power.	If ATFLIR installed - 1. TAC/FLIR/SETUP page - IDENTIFY FAILURE If either TFLIR or ATFLIR installed - 2. FLIR IBIT - PERFORM (SUPT/BIT/SENSORS/FLIR or ATFLIR) If advisory remains - 3. FLIR switch - CYCLE
LOAD	<ul style="list-style-type: none"> • Improper weapon load, codes, or incompatible fuzing. Refer to A1-F18EA-TAC-series. 	1. SMS processor - Check for proper codes If LOAD remains - 2. Do not takeoff.
M2ID	<ul style="list-style-type: none"> • ACL mode has been enabled and the current IFF Mode 2 code is not the same as the last four digits of the aircraft Link 4 address. 	Information
M4 OK	<ul style="list-style-type: none"> • Transponder replied to a valid Mode 4 interrogation. IFF MODE 4 switch must be in DIS or DIS/AUD to enable this advisory.	Information
MIDS	<ul style="list-style-type: none"> • MIDS fault detected. 	1. MIDS page - IDENTIFY FAILURE
MNTCD	<ul style="list-style-type: none"> • AMU/maintenance card problem. Advisory is disabled in flight.	1. Verify maintenance card installed in proper AMU slot and AMU door is closed. 2. If indication does not clear - Do not takeoff
MSNCD	<ul style="list-style-type: none"> • AMU/mission card problem. Advisory is disabled in flight.	1. Verify mission card installed in proper AMU slot and AMU door is closed. 2. If indication does not clear - Pilot discretion
MU FL	<ul style="list-style-type: none"> • Memory Unit memory full. Oldest stored data will be overwritten.	Information
NODOV	<ul style="list-style-type: none"> • DoV mission card data is not present or failed to load. • No DoV data is available for current position for 30 seconds. CV alignment times will increase. INS performance while unaided may be degraded.	If DOV displayed on MUMI page - 1. Remove and re-insert mission card. If DOV remains - 2. Insert new mission card.

Figure 12-1. Warning/Caution/Advisory Displays (Sheet 66)

DDI Advisories

INDICATOR	• CAUSE / REMARKS	CORRECTIVE ACTION
NOSEC	• GPS operating in non-secure mode.	Information
P/INS	• GPS satellite communication lost. Position keeping has reverted from POS/AINS to POS/INS. INS not being updated with GPS data.	Information
PCODE	• GPS keys incorrect or not loaded.	Information
RALT	• Autopilot radar altitude hold mode engaged.	Information
RMMCD	• RMM not installed or failed.	Information
RMMFL	• RMM full (less than 20 minutes remaining).	Information
BCDR	• MU turned off.	Information
ROLL	• Autopilot roll attitude hold mode engaged.	Information
RSET	• FCS RESET attempt successful.	Information
RSET	• FCS RESET attempt unsuccessful. FCS failure and failure indications remain.	Information
SKID	• Landing gear down with the ANTI SKID switch in OFF.	Information
SQTTR	• Mode S is enabled while acquisition squitter is disabled.	If Mode S operation desired - 1. Enable acquisition squitter via the UFCD. If Mode S operation not desired - 1. Secure Mode S via the UFCD.
TRIM	• Pitch, roll, and yaw trim properly set for takeoff. Stabilators 4° TEU, roll trim zero, RUD TRIM knob mechanically neutral.	Information

Figure 12-1. Warning/Caution/Advisory Displays (Sheet 67)

DDI Advisories

INDICATOR	• CAUSE / REMARKS	CORRECTIVE ACTION
VVEL	<ul style="list-style-type: none"> GPS assisted velocity vector enhancement disabled. <p>Only the air data function is being used to smooth the velocity vector and may result in degraded velocity vector accuracy.</p> <div style="border: 2px solid black; padding: 5px; text-align: center; width: fit-content; margin: 10px auto;">WARNING</div> <p>With a VVEL advisory displayed, sustained climbs and descents, such as penetration from the marshal stack, can result in uncued (i.e., no cautions) vertical velocity errors and a possible inaccurate velocity vector position. Error magnitudes increase at slower airspeeds and lower altitudes. Errors of up to 3° (e.g., actual flightpath 3° below the displayed velocity vector) have been observed in the landing configuration.</p>	<ol style="list-style-type: none"> Monitor velocity vector for errors. <p>If errors noted -</p> <ol style="list-style-type: none"> Maintain level flight for 3 minutes (if practical).
WPNS	<ul style="list-style-type: none"> Bulk data transfer error or JSOW overheat condition. 	Information
Y CODE	<ul style="list-style-type: none"> GPS receiver is not receiving encrypted code in secure mode. 	<p>If GPS signals are believed to be accurate -</p> <ol style="list-style-type: none"> HSI/DATA/(A/C) page - SELECT NOSEC GPS OPTION <p>If GPS signals believed to be corrupted -</p> <ol style="list-style-type: none"> INS knob - NAV

Figure 12-1. Warning/Caution/Advisory Displays (Sheet 68)

Advisory Lights

INDICATOR	• CAUSE / REMARKS	CORRECTIVE ACTION
A/A	• Air-to-Air master mode selected.	1. Refer to A1-F18EA-TAC-Series.
A/G	• Air-to-Ground master mode selected.	1. Refer to A1-F18EA-TAC-Series.
CONSNT	• RFCM or ALE-47 is requesting consent to execute countermeasures response as indicated by HUD cueing, or ALE-47 BIT underway.	1. Refer to A1-F18EA-TAC-Series.
CW	• Continuous wave (RF Threat) detected.	1. Refer to A1-F18EA-TAC-Series.
DCOY ON	<p>STEADY Decoy is deployed and either transmitting or enabled to transmit, or decoy portion of DECM BIT is underway.</p> <p>-----</p> <p>FLASHING Decoy is deployed and transmission is inhibited due to altitude limit or EMCON selected. Also flashes for 30 seconds upon deployment of, or enabling transmission from, last usable decoy if invalid reel count occurs during its deployment.</p>	1. Refer to A1-F18EA-TAC-Series.
DISCH	• Fire extinguisher bottle discharge initiated or pressure drop detected.	<p>GROUND</p> <p>1. Do not takeoff.</p>
DPLY	<p>STEADY Decoy is deployed to, or beyond, the defined minimum successful deployment length or 8 sec (ALE-50)/16 sec (ALE-55) have elapsed since launch squib firing, or decoy portion of BIT underway.</p> <p>-----</p> <p>FLASHING Decoy is currently being deployed, or decoy sever has failed or cannot be determined. Flashes indefinitely if first sever attempt unsuccessful. Transitions to off if sever re-attempt successful or continues to flash for 30 seconds and then transitions to off if sever re-attempt fails.</p>	Information
FLAPS (Amber)	• TEF(s) OFF, LEF(s) OFF, SPIN mode engaged, GAIN ORIDE selected, or FLAPS HALF/FULL over 240 KCAS (auto flap retract).	Information
FULL	• FLAP switch in FULL.	Information
HALF	• FLAP switch in HALF.	Information
HOOK (Green)	• Hook is down.	Information

Figure 12-1. Warning/Caution/Advisory Displays (Sheet 69)

Advisory Lights

INDICATOR	• CAUSE / REMARKS	CORRECTIVE ACTION
JAM ON	<ul style="list-style-type: none"> • ASPJ or RFCM on board transmitter is active and transmitting. • DECM BIT in progress 	1. Refer to A1-F18EA-TAC-Series.
L BAR (Green)	<ul style="list-style-type: none"> • Launch bar extended. (Weight on the nose gear, LAUNCH BAR switch in EXTEND, launch bar not up (launch bar proximity switch not energized)) 	Information
LEFT	<p>STEADY</p> <ul style="list-style-type: none"> • Left main landing gear down and locked. <hr/> <p>FLASHING</p> <ul style="list-style-type: none"> • Left planing link failure detected with the left main landing gear down and locked. 	<p>Information</p> <hr/> <p>1. Refer to Planing Link Failure procedure.</p>
LOCK/SHOOT	<ul style="list-style-type: none"> • Radar in STT; ready to shoot. 	1. Refer to A1-F18EA-TAC-Series.
MASTER CAUTION	<ul style="list-style-type: none"> • Warning or caution has been activated. 	1. MASTER CAUTION light - RESET
NOSE	<ul style="list-style-type: none"> • Nose landing gear down and locked. 	Information
RCDR ON	<ul style="list-style-type: none"> • CVRS mode switch in MAN or AUTO (in A/A or A/G). • The SSR is commanded to record. <p>The light is not an indication that tape is actually pulling or SSR actually recording.</p>	Information
READY (APU)	<ul style="list-style-type: none"> • APU online and ready to support engine start. 	Information
REC	<ul style="list-style-type: none"> • ASPJ or RFCM is in receive or transmit mode and is receiving threat signals that warrant a response. • DECM BIT in progress. 	1. Refer to A1-F18EA-TAC-Series.
RIGHT	<p>STEADY</p> <ul style="list-style-type: none"> • Right main landing gear down and locked. <hr/> <p>FLASHING</p> <ul style="list-style-type: none"> • Right planing link failure detected with the right main landing gear down and locked. 	<p>Information</p> <hr/> <p>1. Refer to Planing Link Failure procedure.</p>
SAM	<ul style="list-style-type: none"> • SAM threat detected. 	1. Refer to A1-F18EA-TAC-Series.
SPD BRK	<ul style="list-style-type: none"> • Speedbrake function surfaces not fully retracted. 	Information
STBY	<ul style="list-style-type: none"> • ASPJ in standby mode. 	1. Refer to A1-F18EA-TAC-Series.
WRMUP	<ul style="list-style-type: none"> • ASPJ or RFCM transmitters are in the warm up cycle. 	1. Refer to A1-F18EA-TAC-Series.
XMT	<ul style="list-style-type: none"> • ASPJ in transmit mode. 	1. Refer to A1-F18EA-TAC-Series.

Figure 12-1. Warning/Caution/Advisory Displays (Sheet 70)

CFIT Voice Warnings

INDICATOR	• CAUSE / REMARKS	CORRECTIVE ACTION
CHECK GEAR	<ul style="list-style-type: none"> Aircraft is <150 feet, <200 KCAS, more than 60 seconds after take-off/bolter or wave-off, descending and landing gear is not down and locked for 0.3 seconds. <p>There is no visual cue.</p>	<ol style="list-style-type: none"> Wave-off LDG GEAR handle - DN
POWER	<p>Approach Phase -</p> <ul style="list-style-type: none"> Aircraft is <150 feet, <200 KCAS, more than 60 seconds after take-off/bolter or waveoff, and sink rate ≥ threshold for 0.3 seconds. Threshold varies linearly with a maximum sink rate of 2,040 fpm from 150 feet. <p>Takeoff Phase -</p> <ul style="list-style-type: none"> Aircraft is <150 feet, <250 KCAS, less than 60 seconds after take-off/bolter or waveoff, and a sink rate ≥300 fpm for greater than 0.3 seconds. 	<ol style="list-style-type: none"> Immediately add power (up to MAX may be required) to reduce sink rate and pull up using the direction-of-pull arrow on the HUD to maintain 10 to 12° AOA. <div style="border: 2px solid black; padding: 5px; display: inline-block; margin: 10px 0;">WARNING</div> <p>Do not exceed 14° AOA (AOA tone).</p>
PULL UP	<ul style="list-style-type: none"> Aircraft is ≥150 feet and MC1 calculates a dive recovery is required. Aircraft is ≤90 feet for 0.3 seconds and airspeed is either ≥250 KCAS or ≥200 KCAS (when more than 60 seconds after take-off/bolter or wave-off). 	<ol style="list-style-type: none"> Immediately pull-up using the direction-of-pull arrow on the HUD.
ROLL LEFT/RIGHT	<ul style="list-style-type: none"> Aircraft is ≥150 feet, angle of bank >45°, and MC1 calculates a dive recovery is required. May be followed by PULL UP once bank angle is ≤45°. Aircraft is <150 feet, <200 KCAS, more than 60 seconds after take-off/bolter or wave-off, and at a bank angle of ≥45° for more than one second. 	<ol style="list-style-type: none"> Immediately roll towards wings level in direction indicated and pull-up using the direction-of-pull arrow on the HUD.
ROLL OUT	<ul style="list-style-type: none"> Aircraft is ≥150 feet, angle of bank >45°, and MC1 calculates a dive recovery is required. May be followed by PULL UP once bank angle is ≤45°. Aircraft is <150 feet, <200 KCAS, more than 60 seconds after take-off/bolter or wave-off, and at a bank angle of ≥45° for more than one second. 	<ol style="list-style-type: none"> Immediately roll towards wings level and pull up using the direction-of-pull arrow on the HUD.

Figure 12-1. Warning/Caution/Advisory Displays (Sheet 71)

CHAPTER 13

Ground Emergencies

13.1 LOSS OF DC ESSENTIAL BUS

With WonW and both GENs offline, the Essential Bus is powered by the battery through the battery contactor. If the battery contactor fails to apply power to the Essential Bus, the following cautions and/or failures are displayed together and indicate an essential bus failure:

- L and R OIL PR cautions
- BINGO caution
- NWS caution
- FIRE EXTNGH READY light on
- SPN RCVY light on
- Landing gear position lights inoperative
- UHF 1 and 2 inoperative
- Fuel dump inoperative
- HOOK position light inoperative

If a loss of the DC Essential Bus is suspected -

1. BATT switch - CYCLE
2. Electrical RESET button - PUSH
3. GEN switches - CYCLE

If DC Essential Power not restored -

4. APU start and crossbleed capability are lost.

13.2 ENGINE FAILS TO START/HUNG START

If no EGT rise within 20 seconds after throttle advance or rpm stabilizes below IDLE -

1. Throttle affected engine - OFF
2. Continue cranking for 3 minutes.

After 3 minutes -

3. ENG CRANK switch - OFF
4. APU switch - OFF

13.3 HOT START

If EGT climbs rapidly through 750°C -

- *1. Throttle affected engine - OFF
2. Engine - CRANK UNTIL EGT BELOW 200°C, reengage when rpm below 30%.

When EGT below 200°C -

3. ENG CRANK switch - OFF
4. APU switch - OFF

13.4 GROUND FIRE

Several fire conditions exist that may be detected and signalled by ground crew without corresponding cockpit FIRE indications. These may include, for example, APU exhaust torching, ignition of fuel or other flammable liquids exposed to hot surfaces, or brake fires. Aircraft location and the nature of the fire condition will determine the course of action. In most cases, if ground crew signal a fire condition, the aircraft should be stopped and shut down immediately. If a fire occurs during hot refueling, the pilot must decide whether to taxi clear or shut down immediately.

13.4.1 HOT BRAKES/BRAKE FIRE. Hot brakes and/or melted wheel assembly fuse plugs can be expected any time maximum effort braking is used at heavy gross weights with or without anti-skid, e.g., aborted takeoff or heavy weight landing with high taxi brake usage.

There are basically two types of fires related to the brake system: flash fires and fires due to continuous hydraulic fluid leakage onto hot brakes.

Brake flash fires are normally short in duration and self-extinguish. They can occur if excess grease or residual/leaking hydraulic fluid have built up in the wheel brake assembly or on the carbon discs. These materials may ignite at normal post-landing brake temperatures. Visible flames may extend from the wheel assembly while flammable material is being consumed and smoke may be visible for a short time after the fire goes out.

Continuous hydraulic fluid leakage coming into contact with hot brakes may result in a fire which will not immediately self-extinguish. Setting the parking brake increases the rate of heat transfer from the brakes to the wheel assembly which may lead to continuous hydraulic fluid leakage.



- Avoid setting the parking brake with hot brakes until the brake assembly has cooled to prevent damage by heat and/or fire to the brakes, wheel, tire, and landing gear components.
- If fire occurs with the parking brake set, the parking brake may become non-operational and the aircraft may need to be chocked.

If hot brakes are suspected -

1. Continue to taxi to cool brakes (if practical).
2. DO NOT set parking brake.
3. Chock nosewheel (do not chock main wheels).

4. Park into the wind (if practical).
5. Cool brake assembly with ground cooling fan (if available).

If brake fire occurs -

1. Shut down both engines.
2. Chock nosewheel or PARK BRK handle - SET
3. Egress.
4. Ensure unnecessary ground personnel remain well clear of the aircraft.

13.5 EMERGENCY EGRESS

1. Canopy - OPEN (CANOPY switch, CANOPY JETT handle, or canopy handcrank)

WARNING

CANOPY JETT rocket thrusters may ignite spilled fuel or hydraulic fluid and may injure ground crew in the immediate vicinity.

NOTE

- The CANOPY switch should be used to raise the canopy unless there are overriding circumstances. If weight is not on the left main gear (e.g., gear up landing), the CANOPY switch must be held to raise the canopy.
- In LOTs 21-25 aircraft the CANOPY JETT handle is the only means of opening the canopy from the rear cockpit of the F/A-18F.
- If electrical power is not available, the canopy must be jettisoned or raised with the handcrank.

2. Harness and leg restraints - RELEASE

NOTE

Several options exist for releasing the harness and leg restraints. (1) All four harness buckles and all four leg restraints can be manually released. (2) The upper Koch fittings can be manually released and the manual override handle can be pulled to release the leg restraints and the survival kit. The survival kit will be retained and may hamper egress. (3) All four harness buckles can be manually released, and the manual override handle can be pulled to release the leg restraints.

3. Oxygen/comm lead - DISCONNECT

4. EXIT THE COCKPIT

NOTE

If the boarding ladder has not been lowered, aircrew have several alternatives, i.e., jump from the LEX (an approximately 8 ft drop), slide down an extended TEF, or step down from the wing to an installed wing tank/store.

13.6 BRAKE FAILURE/EMERGENCY BRAKES

The emergency brake system is powered by the brake accumulator or HYD 2B. Anti-skid protection is bypassed when emergency brakes are selected or when the ANTI SKID switch is OFF. Normally limited by the anti-skid system, 3,000 psi hydraulic brake pressure is available and regulated only by pilot brake pedal forces. When using emergency brakes at high speed, initially apply very light brake pedal pressure and gradually increase as required. There is a very small margin between effective emergency braking and blown tires. If practical, rollout speed should be as slow as possible before applying emergency brakes. The use of emergency brakes at high speeds should be considered a last resort.

If detected after touchdown and flyaway airspeed available -

- *1. Go Around.

If brake failure occurs at slow speed or flyaway airspeed not available -

- *1. Brakes - RELEASE
- *2. EMERG BRK handle - PULL TO DETENT
- *3. Brakes - APPLY gradually

CHAPTER 14

Takeoff Emergencies

14.1 EMERGENCY CATAPULT FLYAWAY

After catapult launch, several emergencies may cause the aircraft to settle, e.g., slow catapult, AB blowout, degraded engine performance, single engine total loss of thrust, improper trim setting, etc. If settling cannot be stopped immediately, it is necessary to eject without delay. Priorities during emergency catapult flyaway are to establish control of the aircraft, arrest aircraft settle, and accelerate for climbout.

If a settle is detected, the throttles should be advanced to MAX as soon as possible. If the thrust output of one engine is degraded, some yaw and roll should be expected. If one engine is failed completely, significant amounts of yaw and roll result with both throttles at MAX. In this worst case, full rudder pedal and partial lateral stick may be required to oppose yaw/roll and maintain lateral-directional control of the aircraft. Too much rudder pedal is not harmful, but too little rudder pedal may cause controllability problems. Therefore, FULL rudder pedal to oppose yaw/roll is prudent.

Proper AOA control is crucial to maintaining aircraft control and to arresting aircraft settle. AOA must be high enough to minimize altitude loss yet low enough to maintain lateral-directional control. During a nominal, two-engine catapult launch, the aircraft is trimmed to capture and maintain a reference AOA of 12° (hands off). The FCS does allow small overshoots during initial flyaway, but peak AOA should typically be below 13°. Catapult launch bulletins ensure an endspeed at least 15 knots above minimum controllable airspeed (V_{mc}). V_{mc} numbers for the F/A-18E/F launch bulletins are defined at 14° AOA, which was selected as a compromise between arresting settle off the bow and controllability. (Increased AOA helps arrest sink but also reduces lateral-directional controllability resulting in higher minimum control speeds.) During single engine, MAX power catapult flyaway, controllability should be sufficient if airspeed is above V_{mc} .

Under normal circumstances, proper AOA control should be provided by the FCS. However, certain catapult failures (mis-trim, AOA probe splits or failures, FCS malfunctions) may require the pilot to actively control flyaway pitch attitude/AOA. With an AOA malfunction, HUD displayed AOA may be in error, so that pitch attitude becomes the only reliable source of AOA control. For this reason, the recommended flyaway procedure is to maintain 10 to 12° pitch attitude with the waterline symbol without exceeding 14° AOA (AOA tone). This should provide an AOA high enough to arrest the settle yet low enough to retain lateral-directional control.

Depending on aircraft gross weight, stores jettison may be required to ensure a positive single engine rate of climb (SEROC). Immediate jettison of excess weight minimizes altitude loss and, when launching with a lateral weight asymmetry, returns the aircraft to a symmetric configuration, potentially improving lateral-directional controllability.

It is also essential that the flaps remain in FULL until a positive rate of climb is established, as flap retraction increases aircraft settle.

The first four steps in the procedure are the most important to arrest settle and maintain control of the aircraft. Raising the LDG GEAR handle reduces drag and allows a greater rate of climb; however, attention should not be diverted from maintaining aircraft control to perform this action. The landing gear should only be raised when the first four immediate action steps have been accomplished, controllability is not in question, and raising the gear does not compound the emergency.

NOTE

When the LDG GEAR handle is raised, the on-speed AOA bracket is removed from the HUD.

If flyaway airspeed available -

- *1. Throttles - MAX
- *2. Rudder pedal - FULL AGAINST YAW/ROLL
- *3. EMERG JETT button - PUSH
- *4. Maintain 10° to 12° pitch attitude with "W" symbol.
 - Do not exceed 14° AOA (AOA tone).

If unable to arrest yaw/roll or stop settle -

- *5. EJECT

WARNING

- Exceeding 10° to 12° pitch attitude may result in rapid loss of lateral directional control.
- Raising flaps will increase aircraft settle.

14.2 ABORT

Maximum planned abort speed is dependent on ambient conditions, gross weight, runway length, and runway and/or braking conditions. However, the decision to abort depends on the nature and severity of the emergency.

Published maximum abort speeds for the existing conditions should allow the aircraft to be stopped within the runway remaining without the use of long field arresting gear. For extreme emergencies, the availability of long field arresting gear may influence the decision to abort. For other, less critical emergencies, the decision to abort or continue the takeoff is crucial. Successfully stopping a heavy weight aircraft on a high speed abort may prove to be a more extreme emergency than continuing a takeoff with the given malfunction. No rule can be made to cover every situation, so good judgment and common sense should be used. A thorough preflight briefing of abort contingencies should aid the pilot in making a timely abort decision.

Once the decision to abort is made, the amount of runway remaining dictates braking technique and the decision to take any long field gear. After brakes are applied, stabilator braking with up to full aft stick is extremely effective in aiding deceleration. At heavy takeoff gross weight, excessive brake heating, melted wheel assembly fuze plugs, and/or blown tires should be anticipated. If the long field gear is required to stop the aircraft, inform the tower and/or other members of the flight as soon as possible. Lower the hook in time for it to fully extend. If the aircraft cannot be stopped in the runway remaining, the decision whether or not to eject must be made. If in doubt, eject prior to the aircraft leaving the prepared surface.

- *1. Throttles - IDLE
- *2. Speedbrake - AS DESIRED
- *3. Brakes - APPLY
- *4. Stick - AFT below 100 knots (if required)
- *5. HOOK handle - DOWN (if required)

NOTE

A rule of thumb to ensure full hook extension is 1,000 feet prior to the arresting gear.

14.3 GO AROUND

Several emergency situations may require the use of the Go Around procedure: FIRE light on takeoff (engine fire), loss of thrust on takeoff (engine failure), or loss of directional control on takeoff or landing (NWS or blown tire). The decision to abort or execute a go around depends on the nature and severity of the emergency. Refer to the preceding ABORT discussion.

For a loss of directional control on landing, the decision to execute a go around should not be delayed. In most cases, it is better to go around immediately than struggle with directional control and possibly depart the runway. An immediate go around allows time to assess the emergency and set up for an arrested landing, if required.

The Go Around procedure provides a quick, simple way to safely get airborne if a situation arises which requires immediate action. The use of MIL or MAX power depends on airspeed, runway remaining, and aircraft configuration/asymmetry. If one engine fails, asymmetric thrust effects are exacerbated at MAX power but are nonetheless controllable if AOA is maintained near on-speed.

When safely airborne, raising the landing gear, if HYD 2A is operative, improves acceleration and climb; however, it may not always be prudent depending on the nature of the emergency.

With the FLAP switch in HALF, SEROC is normally sufficient at all gross weights and ambient conditions. However, if the situation warrants, jettisoning excess weight increases SEROC and, if asymmetric, returns the aircraft to a symmetric configuration, potentially improving lateral-directional controllability. See figure 14-1 for the maximum weight and altitudes for 100 fpm SEROC.

- 1. Throttles - MIL or MAX
- 2. Maintain ON-SPEED AOA and balanced flight.

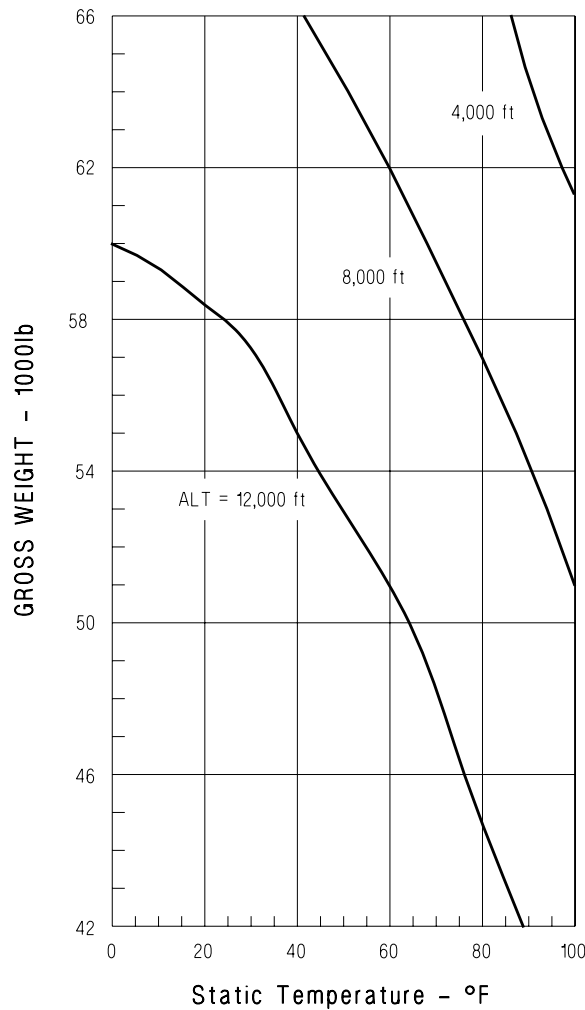

EFN520-342-1-004

Figure 14-1. Maximum Weight for 100 fpm Single Engine Rate of Climb

3. EMERG JETT button - PUSH (if required)

WARNING

When single engine with the operating engine at MAX, the possibility of an adverse yaw departure increases as AOA exceeds on-speed.

14.4 LOSS OF DIRECTIONAL CONTROL DURING TAKEOFF OR LANDING (BLOWN TIRE, NWS FAILURE)

A directional control problem on takeoff or landing may be caused by a NWS, brake, landing gear component failure, planing link failure or a blown tire. Directional control problems may be compounded by wet or icy runways, crosswinds, hydroplaning, high lateral weight asymmetries, or single-engine operations. It may be difficult to identify the source of the problem, and time is usually

critical. The decision whether to continue a takeoff or to abort, or on landing, to continue rollout depends on the speed at the time the directional control problem is detected, the stopping distance required, and the availability of arresting gear.

Loss of brakes may be caused by a brake or anti-skid system failure. A brake system failure may cause a locked brake and/or blown tire, resulting in ineffective braking and/or loss of directional control. A blown tire may cause engine FOD or flap and gear door damage. If decision to stop is made, the primary danger is loss of directional control. For Planing Link Failure Procedures, refer to chapter 16.

WARNING

If the decision to takeoff is made, nose rotation and/or takeoff may be delayed by abnormal aircraft attitudes due to failures, increased drag, and lack of or reduced rudder toe due to rudder deflection to counter directional motion.

If detected after touchdown and flyaway airspeed available -

- *1. Go Around

If flyaway airspeed not available -

- *1. Select emergency brakes (if appropriate).
- *2. HOOK handle - DOWN (if required)

If NWS failure suspected -

- 3. Paddle switch - PRESS

If takeoff is continued and blown tire suspected -

- 2. LDG GEAR handle - DO NOT CYCLE
- 3. Engine instruments - MONITOR FOR FOD INDICATIONS
- 4. ANTI SKID switch - OFF
- 5. Make a short field arrestment.

If decision to stop is made and blown tire suspected -

- 3. Do not retract flaps.
- 4. Do not taxi once stopped.

14.5 LANDING GEAR FAILS TO RETRACT**If LDG GEAR handle cannot be moved from the DN position -**

- 1. LDG GEAR handle - LEAVE DN (DO NOT OVERRIDE)

If landing gear warning light and warning tone on with the LDG GEAR handle UP -

1. LG circuit breaker - CHECK IN
2. LDG GEAR handle - DN (DO NOT CYCLE)

If three down and locked indications -

3. Land as soon as practical.
4. Consider an arrested landing (normal braking and NWS may not be available)

If any gear indicates unsafe -

5. Refer to Landing Gear Unsafe/Fails to Extend procedure.

CHAPTER 15

Inflight Emergencies

15.1 AFTERBURNER FAILURE

Afterburner failure can be recognized by failure of the nozzle to open, which may be the only symptom that is immediately recognizable. The afterburner receives continuous ignition any time the throttle is above the MIL detent and afterburner lightoff is not yet detected. If an afterburner does not light after selection or blows out, reduce the throttle to MIL and reselect afterburner. If an afterburner fails to light on subsequent attempts, maintenance action is most likely required.

15.2 RESTART

Ignition is activated automatically whenever a flameout is sensed and the throttle is at or above IDLE. At least 350 KCAS is required to maintain 12 % rpm for a windmill airstart. When single engine, the hydraulic system switches from 3,000 to 5,000 psi output pressure above approximately 500 KCAS/1.0 IMN (see figure 15-2). This results in additional horsepower extraction and reduced windmill rpm. The hydraulic system output drops from 5,000 to 3,000 psi at approximately 480 KCAS/0.95 IMN. Therefore, maintain airspeed below 480 KCAS/0.95 IMN to maximize the chance of a successful windmill restart.

Continuing automatic restart attempts at high altitude or high AOA may cause the engine to overtemp. In this case, place the throttle OFF until in a better start environment. The optimum restart envelope is below 25,000 feet. If the engine is shut down from a high power setting and rpm decays to 0 %, temporary rotor binding may occur. In this case, engine rotation will not be regained until the engine cools evenly (about 10 to 15 minutes). Windmill restart attempts made after rpm has degraded to 0 % may require up to 450 knots to obtain 12 % rpm for ignition.

APU restart is the last alternative. If APU restart is required, HYD ISOL ORIDE should first be selected for 10 seconds prior to APU start, assuming good HYD 2B. With the APU switch ON, and the green READY light on, the engine crank switch may be used to crank the engine for restart. The APU restart envelope is below 250 KCAS, below 10,000 ft. See figures 15-1 through 15-4.



Attempting to restart an engine that has flamed out for no apparent reason may result in an engine bay fuel leak/fire.

If rpm above 30% -

1. Throttle affected engine - IDLE or above

If rpm below 30% -

1. Throttle good engine - 80 % N₂ rpm minimum.
2. ENG CRANK switch - L or R (affected side)
3. Throttle affected engine - IDLE or above
4. Monitor EGT during start (871°C maximum). FADEC will not prevent hot starts airborne.

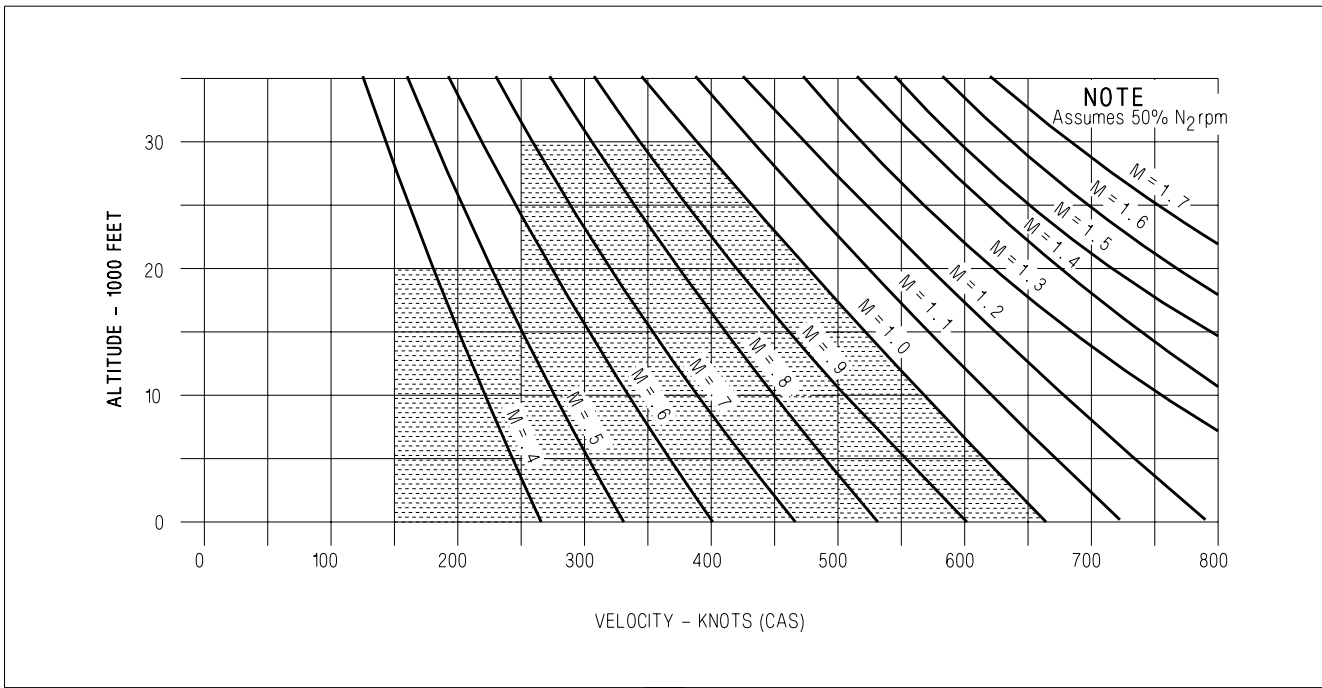

EFN520-146-1-001

Figure 15-1. Spoldown Restart Envelope

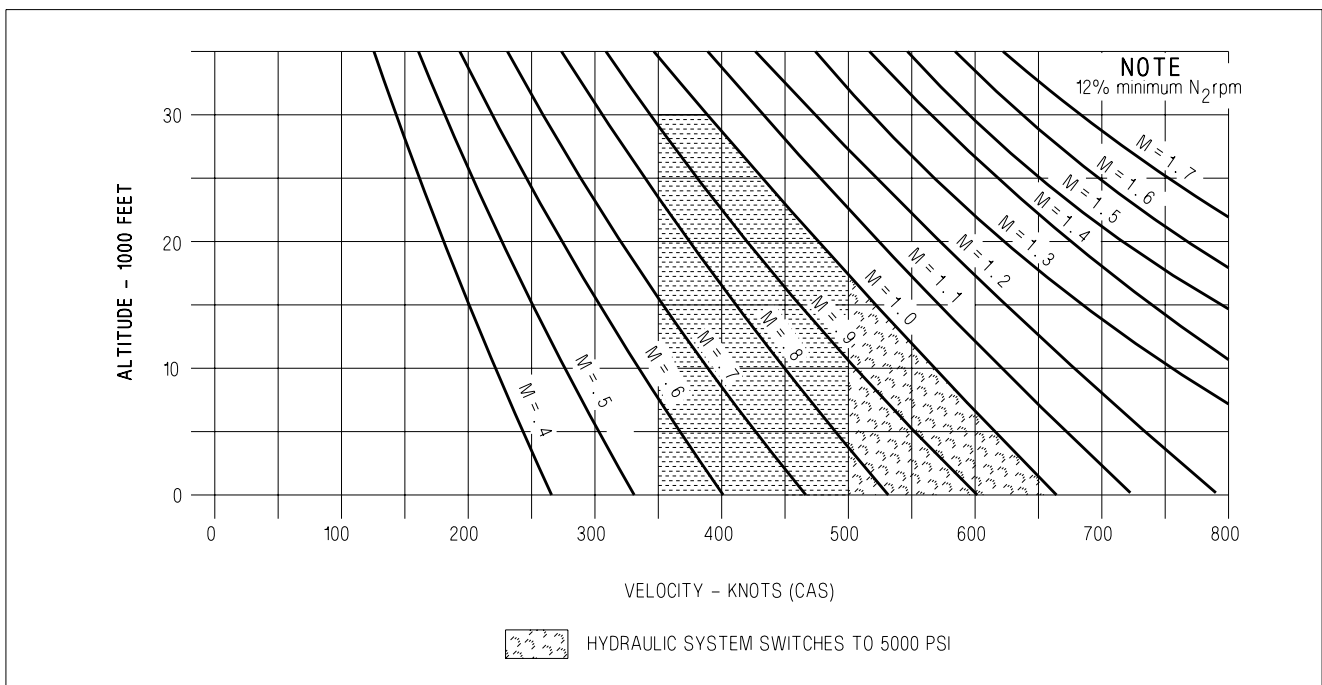

EFN520-147-1-001

Figure 15-2. Windmill Restart Envelope

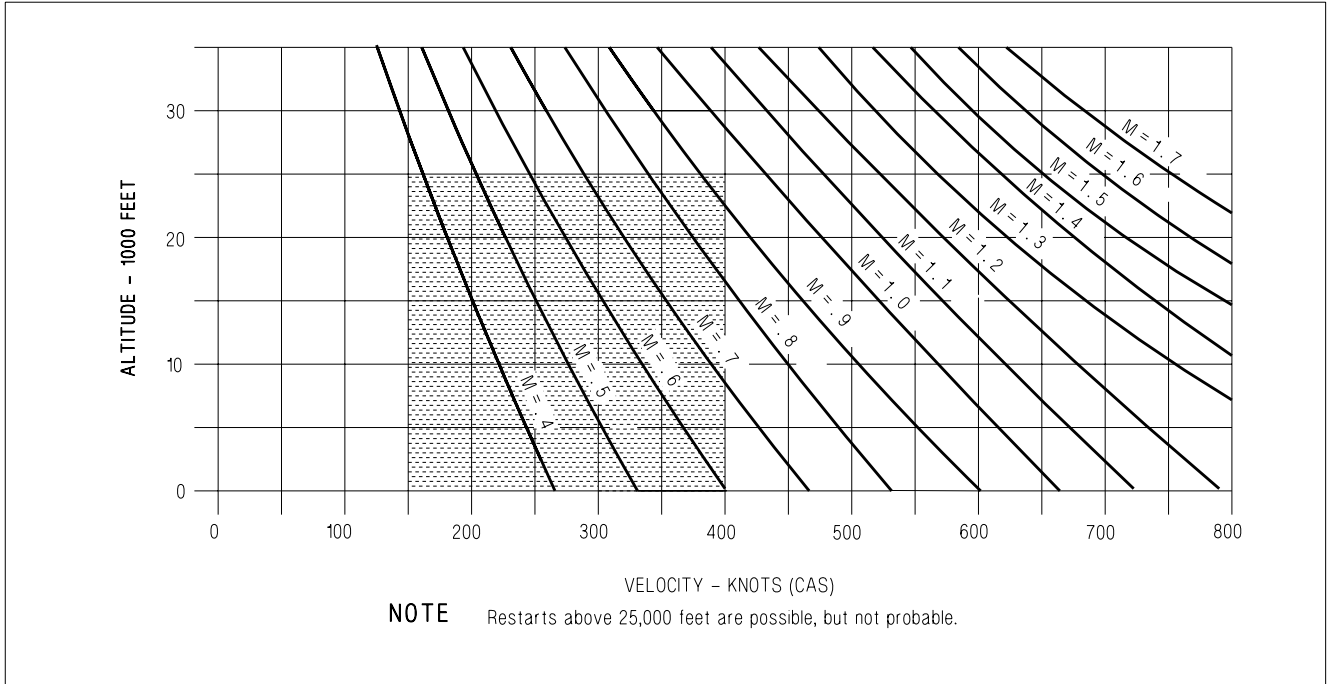

EFN520-148-1-001

Figure 15-3. Crossbled Restart Envelope

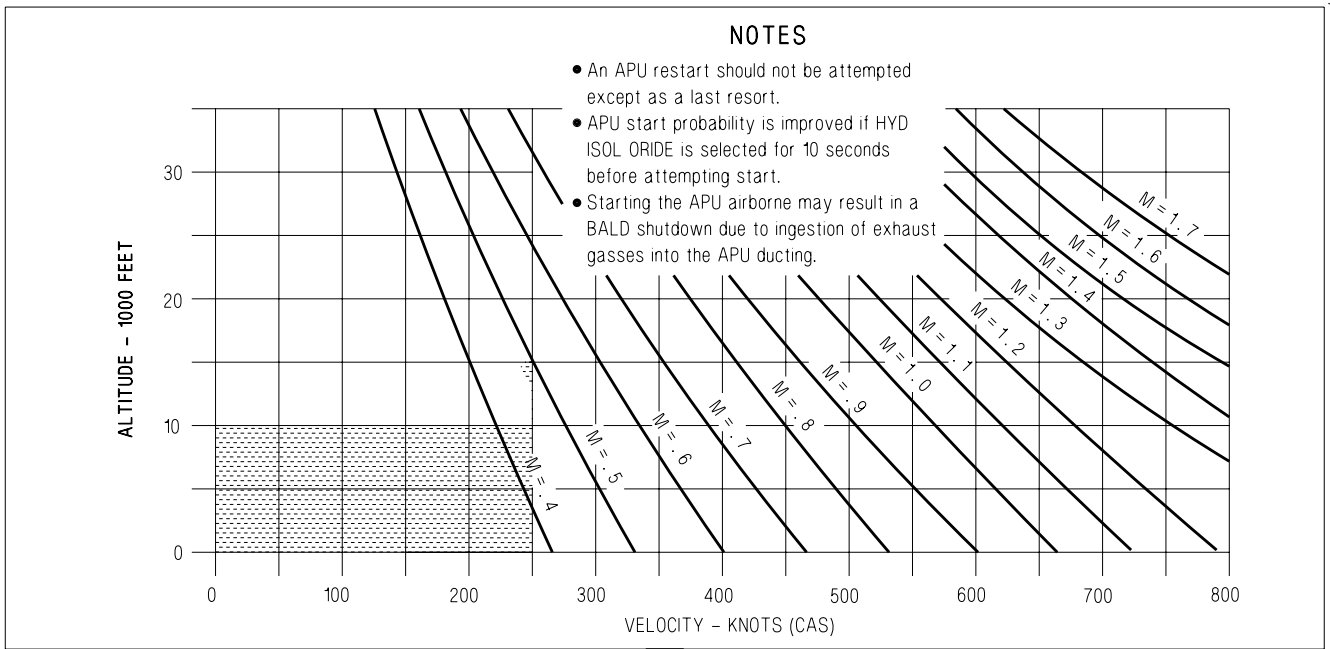

EFN520-149-1-007

Figure 15-4. APU Restart Envelope

15.3 FUSELAGE FUEL LEAK

The possibility of fire is normally of prime concern with any fuel leak; however, with a massive leak, the fuel loss itself must be dealt with promptly and correctly to ensure that sufficient fuel remains to return to base. Fuel loss rates can be in excess of 1,000 ppm from failed main fuel lines. Left unchecked, this leak can rapidly drain external tanks, both transfer tanks, and the feed tank on the leaking side. Since leaks may occur upstream of the throttle-operated fuel shutoff valve in the fuel control, shutting down the throttle may not stop the leak. Pressing the corresponding FIRE light closes the feed tank fuel shutoff valve for that engine and stops fuel flow through the main fuel line.

The pilot may not be able to visually determine which side is leaking. Utilize a wingman, when available, and check for secondary indications to determine the side of the leak. In addition to the primary cockpit indications listed in the procedure, the following may also be indications of a fuselage fuel leak: FUEL LO caution, erratic engine operation at high power settings, abnormal fuel flow indications.

1. Afterburners - DESELECT

WARNING

Afterburner operation with a fuselage fuel leak may result in a fire.

2. Analyze indications to determine which side is leaking:

- Visual confirmation of fuel leakage
- L or R BOOST LO caution
- FEED tank imbalance (lower feed tank)
- FUEL LO caution (lower feed tank)
- Erratic engine operation

If unable to confirm side -

3. Land as soon as possible.

If side confirmed -

3. Throttle affected engine - OFF
4. FIRE light affected engine - PUSH

CAUTION

Securing the good engine may result in flameout of both engines.

If fuel leak stops -

5. Land as soon as practical.

If fuel leak continues -

6. Land as soon as possible.

FOR LANDING (leak continues) -

1. Make normal vice arrested landing (if possible).
2. Use light braking.

After landing-

3. Turn aircraft into the wind.
4. Throttles - OFF
5. FIRE lights - PUSH

15.4 HYDRAULIC FAILURES

Hydraulic failures are indicated by the HYD 1A, 1B, 2A, and 2B circuit cautions described in Chapter 12. The effects of losing one or more HYD circuits can be seen by analyzing the Hydraulic Flow Diagram shown in figure 15-5. For multiple hydraulic circuit failures, the Hydraulic Subsystems Malfunction Guide (figure 15-6) shows which flight control surfaces are lost. Remarks regarding the flight control effects due to hydraulic failures are shown in figure 15-7.

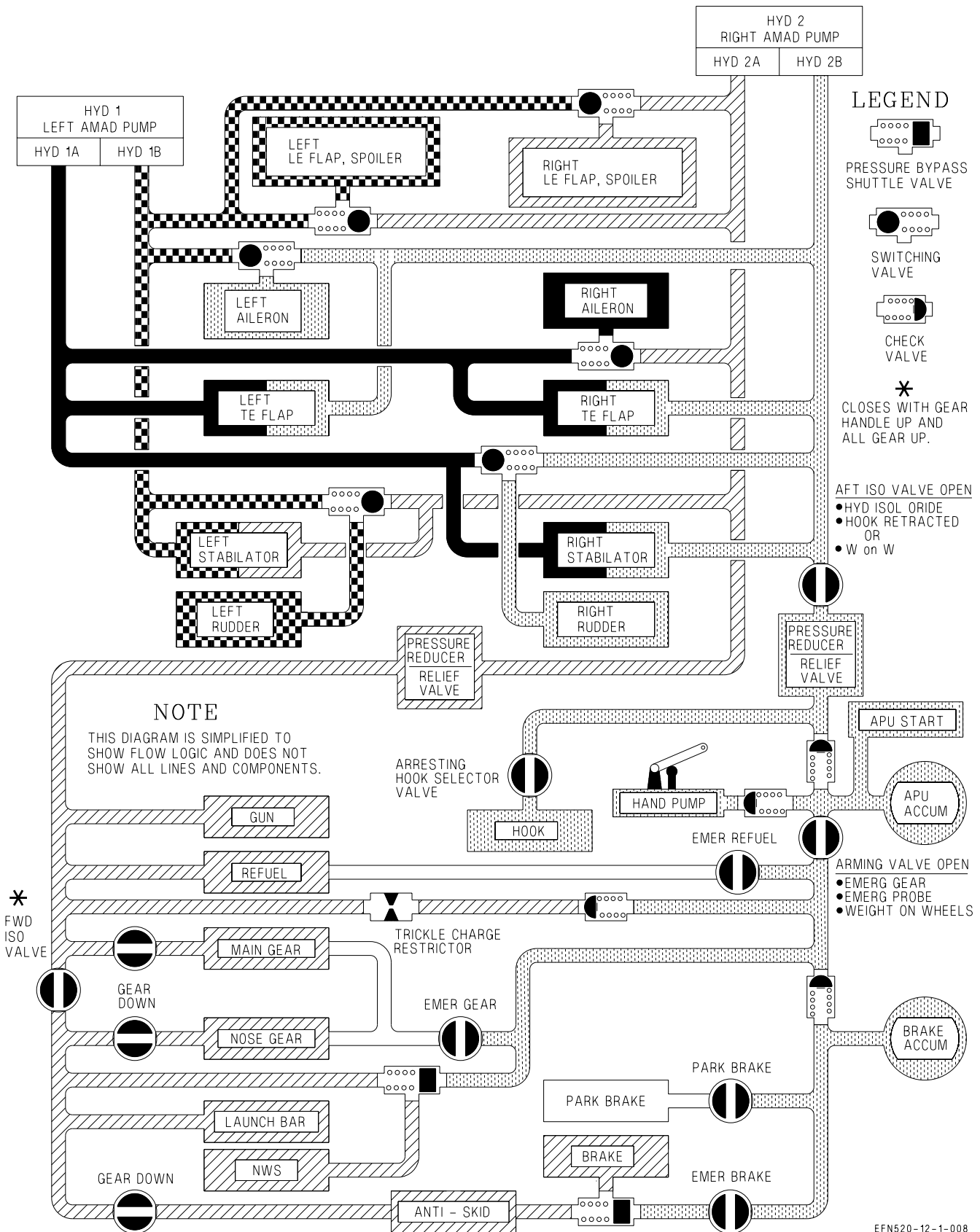

EFN520-12-1-008

Figure 15-5. Hydraulic Flow Diagram (Aircraft on Deck)

HYD FAILURE DISPLAYS	FLIGHT CONTROLS LOST	SURFACES	FLIGHT CONTROLS LOST	HYD FAILURE DISPLAYS
		LEF/LEX/SPLR AIL/TEF RUD STAB		
HYD 1B				HYD 1A
HYD 2B				HYD 2A
		LEF/LEX/SPLR AIL/TEF RUD STAB		
HYD 1B				HYD 1A
HYD 2A				HYD 2B
		LEF/LEX/SPLR AIL/TEF RUD STAB		
HYD 1A				HYD 1A
HYD 1B				HYD 2A
HYD 2A				HYD 2B
	MAY BE UNCONTROLLABLE IN FLAPS HALF/FULL IF STORES NOT JETTISONED			
		LEF/LEX/SPLR AIL/TEF RUD STAB		
HYD 1B				HYD 1A
HYD 2A				HYD 1B
HYD 2B				HYD 2B
	UNCONTROLLABLE DURING TRANSITION FROM FLAPS AUTO TO FLAPS HALF/FULL			

= CONTROL SURFACE(S) INOPERATIVE

EFN520-2-1-015

Figure 15-6. Hydraulic Subsystems Malfunction Guide

FLIGHT CONTROL EFFECTS DUE TO HYDRAULIC FAILURES	
Flight Control Failure ¹	REMARKS
Any Surface Off	<ul style="list-style-type: none"> • General Limits: <ul style="list-style-type: none"> • 10° AOA for flaps AUTO • On-speed AOA for flaps HALF/FULL • 2g max • Minimize sideslip • Half lateral stick • Loss of speedbrake • Loss of autopilot
AIL Xs	<ul style="list-style-type: none"> • Expect slightly higher approach speeds. For flaps FULL, approach speed will be increased by about 11 knots. Flaps HALF, 17 knots. • Avoid over-controlling lateral stick inputs as it can cause lateral PIO especially when approaching touchdown.
RUD Xs	<div style="text-align: center; border: 2px solid black; padding: 5px; width: fit-content; margin: 0 auto;">WARNING</div> <p style="text-align: center;">Full opposing rudder may not be sufficient to prevent a departure when single engine if MAX power selected. Large single engine throttle transients can cause significant yaw and roll.</p> <ul style="list-style-type: none"> • Rudder toe-in is removed. Bolter performance degraded. • Counter any roll-off with rudder. Countering roll-off with lateral stick alone increases adverse yaw and aggravates roll-off. • Line-up control is degraded. Make slow and smooth line-up corrections (especially if single engine). • Departure resistance is degraded above on-speed AOA.
LEF Xs	<ul style="list-style-type: none"> • Opposite LEF held frozen. TEFs held frozen in flaps AUTO. • Stall margin reduced for LEF locked above 5° LED. • Buffet likely with LEF near 0° at lower AOA. • Expect slight roll-off as airspeed changes during a waveoff or bolter that is easily controllable. • Glideslope control degradations may be more pronounced depending on frozen LEF position. Wing stores will further degrade glideslope control. • Power corrections will translate into an airspeed change before a rate of descent change is noticed. This may lead to a tendency to over-control glideslope. Anticipatory throttle inputs are key to glideslope control. • Bolter/waveoff performance is degraded and climb-out attitude will appear flatter than normal. • If AUTO is selected after being in flaps HALF or FULL, the TEFs will not retract except for loads alleviation (no higher than 17°). While in AUTO, momentary selection of GAIN ORIDE will command the TEFs to retract to 4° TED. However, the operating LEF will also be commanded to move to 5° LED. This may drive a controllable but undesirable left versus right LEF split if the failed LEF is not near 5° LED. Therefore, only select GAIN ORIDE if TEF retraction is essential for range or fuel considerations.
<p>Note: (1) Surface inoperative due to lack of hydraulic pressure.</p>	

Figure 15-7. Flight Control Effects Due To Hydraulic Failure (Sheet 1 of 2)

FLIGHT CONTROL EFFECTS DUE TO HYDRAULIC FAILURES (CONT)	
Flight Control Failure(1)	REMARKS
STAB Xs	<p style="text-align: center;">WARNING</p> <p>During a bolter, aircraft yaws into good stabilator when the flight control system deflects the good stabilator TEU in preparation for aircraft nose rotation. Yaw rate may be sudden and pronounced.</p> <ul style="list-style-type: none"> • In flaps AUTO, max roll rate is extremely low in the transonic region below 20,000 feet, especially when rolling away from the failed stabilator.
TEF Xs	<p style="text-align: center;">WARNING</p> <p>Slower engine response to throttle changes may result in excessive sink rates under high WOD conditions. The recovery WOD should be kept as close as possible to the Aircraft Recovery Bulletin recommendations.</p> <ul style="list-style-type: none"> • TEF driven to 5° TED and locked. • Approach speeds are significantly higher and on-speed power settings are near idle. • Approach speeds for field landing may be near the maximum nose tire speed (195 KGS). If making an arrested landing, take maximum arresting gear engagement speed into consideration. • Expect slower engine response. • Aircraft response to power corrections is sluggish and small in magnitude. Power corrections will translate into an airspeed change before a rate of descent change is noted. Expect larger, longer, and more anticipatory power corrections to be required in order to effect a glideslope change. Aggressive, well-timed, and anticipatory throttle inputs are key to glideslope control. • There is a tendency to over-control power due to the low approach power setting and the longer time required to effect a change. • Time to achieve positive rate of climb is longer during a bolter/waveoff due to sluggish throttle response. Climb-out attitude will appear flatter than normal.
<p>Note: (1) Surface inoperative due to lack of hydraulic pressure.</p>	

Figure 15-7. Flight Control Effects Due To Hydraulic Failure (Sheet 2 of 2)

15.5 DOUBLE TRANSFORMER-RECTIFIER FAILURE

Failure of both transformer-rectifiers (TRs) can be recognized by loss of the HUD (but not the other displays), bleed air including cockpit airflow/pressurization, and other equipment which operates on the main dc busses. The FCC channels continue to be powered by their respective PMG outputs. The Essential Bus is powered by the EBB PMGs with the battery charger and the battery as backups. Therefore, the battery gauge should read greater than 24 vdc (26.5 nominal) and the BATT SW caution light should be out.

With a dual TR failure, time is not critical, and essential bus equipment need not be turned off. Equipment requiring ac power only will remain operable with a dual TR failure and need not be turned off to conserve battery power. If the L or R DC FAIL caution lights illuminate, all three 28 volt dc windings from the corresponding PMG are prevented from supplying FCC CH or essential bus backup power. See the Emergency Power Distribution Charts (figure 15-8) for operative and inoperative equipment.

1. BATT SW caution light - CONFIRM OUT
2. Electrical RESET button - PRESS
3. Maintain airspeed below 325 KCAS (300 to 325 KCAS optimum).
4. ECS MODE switch - OFF/RAM
5. AV COOL switch - EMERG
6. CABIN PRESS switch - RAM/DUMP
7. OBOGS control switch - OFF
8. Maintain altitude below 10,000 feet MSL prior to emergency oxygen depletion (10 to 20 minutes).
9. Consider removing mask and resetting emergency oxygen system once below 10,000 feet MSL.
10. Land as soon as practical.

If AV AIR HOT caution appears -

11. Non-essential avionics equipment - OFF (e.g., RADAR, UFCD controlled avionics, ECM, sensors, MC2)
12. Land as soon as possible.

For landing -

13. Perform Landing Gear Emergency Extension procedure.
14. Make a short field arrestment (if available).
15. Use emergency brakes with steady brake pressure. (Anti-skid is not available.)

BOTH GENERATORS INOPERATIVE

OPERATIVE EQUIPMENT

ENGINE

Afterburner ignition
 Anti-icing
 APU ready light
 APU start
 Bleed air leak detectors
 Engine ignition
 Engine start
 Fire detectors and extinguishers
 Engine fuel display
 (RPM and EGT only)
 Tank 4 scavenge pump
 Wing transfer

FLIGHT CONTROLS

CAS
 Flaps
 Flap position indicator

FLIGHT INSTRUMENTS

Front cockpit standby attitude
 reference indicator
 Standby airspeed/Mach indicators
 Standby altimeters
 Standby rate-of-turn indicators
 Standby turn needles

LIGHTING EQUIPMENT

Caution lights panel
 (less GEN and FUEL LO lights.
 CABIN light may be on but is not accu-
 rate. CK ECS light is not fully func-
 tional.)
 Master caution lights
 Utility flood lights

NAVIGATION EQUIPMENT

1 COMM 1 R/T
 IFF emergency

OTHER

Arresting hook extension
 Canopy
 Emergency air refueling
 Emergency jettison
 FCS ram air selection
 2 Intercom
 Landing gear (emergency system)
 Landing gear position indicator
 Voice alerts (APU fire,
 engine fire, bleed air)

INOPERATIVE EQUIPMENT

ENGINE

Anti-ice control
 Bleed air system
 Engine fuel display
 (all functions except RPM
 and EGT)
 External fuel transfer
 Fuel CG control/fuselage transfer
 Fuel dump
 FUEL LO warning light
 Fuel thermal mgmt
 Fuel transfer pressure light
 Inlet ice detector
 Internal fuel tank pressurization
 Internal wing fuel inhibit
 N₁ lockup
 Tank 4 transfer pump

FLIGHT CONTROLS

Autopilot

FLIGHT INSTRUMENTS

2 Aft cockpit standby ARI
 AOA indexer lights
 HUD
 L & R AOA heaters
 L & R pitot static/total temp
 heaters
 MC1/2
 Total temperature probe

LIGHTING EQUIPMENT

Approach lights
 Caution/advisory displays
 CK ECS caution light is not
 fully functional
 Flood lights
 Formation lights
 GEN caution lights
 Instrument lights
 Landing/taxi lights
 Light test switch
 Nav flood lights
 Position lights
 Strobe lights

NAVIGATION EQUIPMENT

ADF (If installed)
 COMM 2 R/T
 DMS
 ICLS, IFF, INS/ANAV
 KY-58
 Radar altimeter
 Radar beacon
 TACAN

OTHER

ALR-67 radar warning receiver
 ARS operation
 Air refueling light and normal probe
 extension
 Anti-skid
 Arresting hook retraction
 Battery charger
 CSC interference blanker
 CPWS pressure sensing
 CVRS
 DDIs/MPCD/UFCD
 Data link
 Hook warning light
 Hydraulic pressure indicator
 JHMCS
 Landing gear (normal system)
 Landing gear warning tone
 Master caution tone
 OBOGS
 OBOGS monitor
 Radar
 Selective jettison
 Voice alerts (fuel low, bingo, altitude,
 flight computer hot, flight controls,
 mode 4 reply, engine)
 Weapon fire/launch/release
 Windshield anti-ice/rain removal

1 Frequency selection lost. Will operate on last selected frequency. Guard transmit receive can be selected by COMM G XMT switch.

2 F/A-18F

Figure 15-8. Emergency Power Distribution (Sheet 1 of 4)

**BOTH TRANSFORMER-RECTIFIERS INOPERATIVE
BOTH GENERATORS OPERATIVE**

OPERATIVE EQUIPMENT

ENGINE

- Afterburner ignition
- Anti-icing
- APU ready light
- APU start
- Bleed air leak detectors
- Engine fuel display engine start
- Engine ignition
- Fire detectors and extinguishers
- Fuel dump
- Internal fuel transfer
- Tank 4 scavenge pumps
- Wing transfer

FLIGHT CONTROLS

- All channels autopilot
- All channels are operative
- CAS
- Flaps
- Flap position indicator

FLIGHT INSTRUMENTS

- 1 Front cockpit standby ARI
- Left and right pitot static/Total temperature heaters
- Standby airspeed/Mach indicators
- Standby altimeters
- Standby rate-of-climb indicators
- Standby turn needles

LIGHTING EQUIPMENT

- Caution/advisory displays
- Caution lights panel (less GEN and FUEL LO lights)
- CABIN light may be on but is not accurate.
- CK ECS light is not fully functional.
- Console lights
- Emergency instrument light
- Flood lights
- Instrument lights
- Master caution lights (and tone)
- NVG floodlights
- Position lights
- Utility floodlights

NAVIGATION EQUIPMENT

- 2 COMM 1 R/T
- IFF
- IFF (emergency)
- INS/ANAV
- Radar altimeter

OTHER

- Arresting hook extension
- Battery charger
- Canopy
- DDIs/MPCD/UFCD
- Emergency air refueling
- Emergency jettison
- FCS ram air selection
- Hydraulic pressure indicator
- 1 Intercom
- JHMCS
- Landing gear (emergency system)
- Landing gear position indicator
- Voice alerts (all)

INOPERATIVE EQUIPMENT

ENGINE

- Anti-ice
- Bleed air system
- External fuel transfer
- Fuel c.g. transfer
- FUEL LO warning light
- Fuel tank pressure light
- Fuel thermal mgmt
- Inlet ice detector
- Internal fuel tank pressurization
- Internal wing fuel inhibit
- N₁ lockup

FLIGHT INSTRUMENTS

- AOA indexer lights
- HUD

LIGHTING EQUIPMENT

- Approach lights
- CK ECS caution light is not fully functional
- Formation lights
- GEN caution lights
- Landing/taxi lights
- Lights test switch
- Strobe lights

NAVIGATION EQUIPMENT

- ADF (If installed)
- COMM 2 R/T
- DMS
- ILS
- KY-58
- Radar beacon
- TACAN

OTHER

- ALR-67 radar warning receiver
- ARS operation
- Air refueling lights and normal probe extension
- Anti-skid
- Arresting hook retraction
- Cabin ram air selection
- CPWS pressure sensing
- CVRS
- Data link
- Hook warning light
- Landing gear (normal system)
- Landing gear warning tone
- Nosewheel steering
- OBOGS
- OBOGS monitor
- Radar
- Selective jettison
- Weapon fire/launch/release
- Windshield anti-ice removal

1 F/A-18F

2 Backup mode operative only.

Figure 15-8. Emergency Power Distribution (Sheet 2)

LEFT GENERATOR INOPERATIVE - BUS TIE OPEN

OPERATIVE EQUIPMENT

ENGINE

- Afterburner ignition
- Anti-ice control
- Anti-icing
- APU ready light
- APU start
- Bleed air leak detectors
- Bleed air system
- Engine fuel display
- Engine ignition
- Engine start
- External fuel transfer
- Fire detectors and extinguishers
- Fuel dump
- Fuel quantity
- Fuel tank pressure light
- Inlet ice detector
- Internal fuel tank pressurization
- Internal wing fuel inhibit
- N₁ lockup
- Tank 1 transfer pump
- Tank 4 scavenge pump
- Wing diverter valves
- Wing transfers

FLIGHT INSTRUMENTS

- AOA indexer lights
- HUD
- Right pitot static/total temp heaters
- 1 Front cockpit standby ARI
- Standby airspeed/Mach indicators
- Standby altimeters
- Standby rate-of-climb indicators
- Standby turn needles

FLIGHT CONTROLS

- Autopilot
- CAS
- Flaps
- Flap position indicator
- Speedbrake
- Speedbrake advisory light

NAVIGATION EQUIPMENT

- ADF (Before ECP 6061)
- COMM 1 R/T
- IFF (less mode 4)
- IFF emergency
- KY-58
- Radar altimeter
- Radar beacon

LIGHTING EQUIPMENT

- Approach lights
- Caution lights panel (less FUEL LO light)
- Emergency instrument light
- Forward console, flood and instrument lights
- Lights test switch
- Master caution lights
- NVG floodlights
- Position lights
- Utility floodlights

OTHER

- ARS operation
- Anti-skid
- Arresting hook extension and retraction
- Audio tones
- Battery charger
- Cabin ram air selection
- Canopy
- CPWS
- CVRS
- Data link
- ECS
- Emergency air refueling
- Emergency jettison
- FCS ram air selection
- Hook warning light
- 1 Intercom
- Interface blanker
- JHMCS
- Landing gear (emergency system)
- Landing gear (normal system)
- Landing gear position indicator
- Landing gear warning tone
- Master caution tone
- Nosewheel steering
- OBOGS monitor
- RDDI
- Selective jettison (stations 6 thru 10 only)
- Voice alerts (APU fire, engine fire bleed air)
- Weapons launch/release (stations 6 thru 11 only)
- Windshield anti-ice/rain removal

INOPERATIVE EQUIPMENT

ENGINE

- FUEL LO warning light
- Tank 4 transfer pump

FLIGHT INSTRUMENTS

- L AOA probe heater
- L pitot static/total temp heater
- MC1
- Total temp probe heater

LIGHTING EQUIPMENT

- AFT console, flood and instrument lights
- Caution/advisory/display
- Formation lights
- Landing/taxi lights
- Strobe lights

NAVIGATION EQUIPMENT

- DMS
- ILS
- INS/ANAV
- TACAN

OTHER

- Air refueling light
- ALR-67 Radar warning receiver
- LDDI/MPCD/UFCD
- Nozzle indication on EFD
- OBOGS
- Radar
- 2 Selective jettison (stations 2 thru 5 only)
- Voice alerts (fuel low, bingo, altitude, flight computer hot, flight controls, mode 4 reply, engine)
- 2 Weapon fire/launch/release (Gun and station 1 thru 5 only)

1 F/A-18F

2 Failure of stations 1 thru 5 will not be indicated on DDI until SMS attempts to communicate with failed stations.

Figure 15-8. Emergency Power Distribution (Sheet 3)

RIGHT GENERATOR INOPERATIVE - BUS TIE OPEN

OPERATIVE EQUIPMENT

ENGINE

Afterburner ignition
 Anti-ice control
 Anti-icing
 APU ready light
 APU start
 Bleed air leak detectors
 Bleed air system
 Engine fuel display
 Engine ignition
 Engine start
 External fuel transfer
 Fire detectors and extinguishers
 Fuel dump
 FUEL LO warning light
 Fuel tank pressure light
 Internal fuel tank pressurization
 Internal wing fuel inhibit
 N₁ lockup
 Tank 4 transfer pump
 Wing diverter valves
 Wing transfer

FLIGHT CONTROLS

Autopilot
 CAS
 Flaps
 Flap position indicator
 Speedbrake
 Speedbrake advisory light

NAVIGATION EQUIPMENT

COMM 1 R/T
 COMM 2 R/T
 DMS
 IFF (Less mode C)
 IFF emergency
 ILS
 INS/ANAV
 Radar beacon

LIGHTING EQUIPMENT

Aft console, flood and instruments lights
 Caution lights panel
 Formation lights
 Landing/taxi lights
 Lights test switch
 Master caution lights
 NVG floodlights
 Strobe lights
 Utility floodlights

FLIGHT INSTRUMENTS

Front cockpit standby attitude reference indicator
 Left AOA heater
 Left pitot static/total temp heater
 Standby airspeed/Mach indicator
 Standby altimeters
 Standby rate-of-climb indicators
 Standby turn needles

OTHER

ALR-67 radar warning receiver
 ARS operation
 Air refueling light and normal probe extension
 Anti-skid
 Arresting hook extension and retraction
 Audio tones (less Master Caution)
 Cabin ram air selection
 Canopy
 CPWS
 Data link
 ECS (cold cockpit, defog air flow)
 Emergency air refueling
 Emergency jettison
 FCS ram air selection
 Hook warning light

1

Intercom
 Landing gear (emergency system)
 Landing gear (normal extension)
 Landing gear position indicator
 Landing gear warning tone
 LDDI/MPCD/UFCD
 Nosewheel steering
 OBOGS
 OBOGS monitor
 Radar

2

Radar coolant pump
 Voice alerts (APU fire, engine fire, bleed air)
 Windshield anti-ice/rain removal

INOPERATIVE EQUIPMENT

ENGINE

Inlet ice detector
 Tank 1 transfer pump

FLIGHT INSTRUMENTS

AOA indexer lights
 Aft cockpit standby attitude reference indicator
 HUD
 MC2
 R AOA heater
 R pitot static/total temp heater

LIGHTING EQUIPMENT

Approach lights
 Forward console, flood instrument lights
 Position lights

NAVIGATION EQUIPMENT

Radar altimeter

OTHER

Battery charger
 CSC
 CVRS
 Hydraulic pressure indicator
 Interference blanker
 JHMCS
 Master caution tone
 RDDI
 Selective jettison
 Voice alerts (fuel low, bingo, altitude, flight computer hot, flight controls, mode 4 reply, engine)
 Weapon fire/launch/release

1 F/A-18F

2 Back-up mode operative only.

Figure 15-8. Emergency Power Distribution (Sheet 4)

15.6 COCKPIT TEMPERATURE HIGH

Hot cockpit airflow may be caused by an ECS control failure or a valve failure. Selecting full COLD on the CABIN TEMP knob should shut off warm air to the cockpit. If this procedure fails to secure warm air to the cockpit, then the failure is most likely with the cockpit flow valve itself. If this is the case, securing both BLEEDS may be the only means to stop the flow of warm air.

WARNING

Selection of MAN with the ECS MODE switch is prohibited. Selection of MAN while the aft cooling fan shutoff valve is open may cause the fan to overspeed resulting in a catastrophic fan failure potentially leading to loss of OBOGS.

1. CABIN TEMP knob - FULL COLD

If temperature still high -

2. Maintain altitude below 25,000 feet.
3. CABIN PRESS switch - RAM/DUMP

If temperature not reduced -

4. Emergency oxygen green ring - PULL
5. OXY FLOW knob - OFF
6. BLEED AIR knob - OFF (DO NOT CYCLE)
7. Maintain altitude below 10,000 feet MSL prior to emergency oxygen depletion (10 to 20 minutes).

WARNING

Under less than optimal conditions (low altitude, heavy breathing, loose fitting mask, etc.) as few as 3 minutes of emergency oxygen may be available.

8. Maintain airspeed below 325 KCAS (300-325 KCAS optimum).
9. ECS MODE switch - OFF/RAM
10. AV COOL switch - EMERG
11. EXT TANKS switch(es) - STOP

Once below 10,000 feet MSL -

12. Consider removing mask and resetting emergency oxygen.
13. OXY FLOW knob - OFF
14. OBOGS control switch - OFF

If AV AIR HOT caution appears -

15. Non-essential avionics equipment - OFF (e.g., radar, UFCD controlled avionics, ECM, sensors, MC2)
16. Land as soon as possible.

15.7 COCKPIT SMOKE, FUMES, OR FIRE

Consider all unidentified fumes in the cockpit as toxic. Do not confuse condensation from the ECS with smoke. The most probable source of visible smoke or fumes in the cockpit is from the engine bleed air or residual oil in the ECS ducts. This smoke is blue gray in color, has a characteristic pungent odor, and may cause the eyes to sting. Another source of smoke or fumes is an electrical malfunction or overheat of equipment located in the cockpit. In the event of an electrical short or overload condition, this equipment may generate electrical smoke (usually white or gray in color) but should not cause an open fire since cockpit equipment uses very little electrical current. Cockpit electrical wiring insulation may smolder and create smoke, but will not erupt into a seriously damaging fire.

- *1. Emergency oxygen green ring(s) - PULL
- *2. OXY FLOW knob(s) - OFF
- *3. Initiate rapid descent to below 10,000 feet cabin altitude.
- *4. CABIN PRESS switch - RAM/DUMP

WARNING

- DCS may be experienced when operating in an unpressurized cabin above 25,000 feet even with a working oxygen system. Symptoms of DCS include pain in joints, tingling sensations, dizziness, paralysis, choking, and/or loss of consciousness.
 - Under less than optimal conditions (low altitude, heavy breathing, loose fitting mask, etc.) as few as 3 minutes of emergency oxygen may be available.
5. Airspeed - Maintain 200 to 300 KCAS.
 6. OBOGS control switch - OFF
 7. Maintain altitude below 10,000 feet MSL prior to emergency oxygen depletion (10-20 minutes).
 8. Consider resetting emergency oxygen system once below 10,000 feet MSL.

If smoke and fumes still present -

9. BLEED AIR knob - OFF (DO NOT CYCLE.)
10. AV COOL switch - EMERG
11. EXT TANK switch(es) - STOP

If smoke and fumes persist or fire present -

12. All electrical equipment - OFF
13. UFCD controlled avionics - OFF (AC power is required.)
14. Required electrical equipment - ON
Restore power to equipment one at a time. If smoke/fire starts again, secure that equipment.

If still unable to clear smoke -

15. Slow and jettison canopy. Secure all loose articles and ensure helmet visor is down. In the F/A-18F, the rear crewmember should lower the seat and lean as far forward as possible before jettisoning canopy.

15.8 HYPOXIA/LOW MASK FLOW/NO MASK FLOW

- *1. Emergency oxygen green ring(s) - PULL
- *2. OXY FLOW knob(s) - OFF
- *3. Initiate rapid descent to below 10,000 feet cabin altitude.

WARNING

Under less than optimal conditions (low altitude, heavy breathing, loose fitting mask, etc.) as few as 3 minutes of emergency oxygen may be available.

4. OBOGS control switch - OFF
5. Maintain cabin altitude below 10,000 feet prior to emergency oxygen depletion (10 to 20 minutes).

If hypoxia symptoms persist -

6. Remain on emergency oxygen as long as possible.
7. Land as soon as possible.

If hypoxia symptoms removed -

6. Land as soon as practical.

7. Consider removing mask and resetting emergency oxygen system or resuming normal OBOGS operation if flow appears normal and donning of mask is desired once below 10,000 feet cabin altitude.

15.9 LOSS OF CABIN PRESSURIZATION

Decompression sickness (DCS) becomes a physiological concern at exposures to cabin altitudes in excess of 18,000 feet. The potential for DCS increases at exposures above 25,000 feet or in the case of a rapid decompression. Aircrew exposed to these conditions should be alert for the symptoms of DCS.

- *1. Emergency oxygen green ring(s) - PULL
- *2. OXY FLOW knob(s) - OFF
- *3. Initiate rapid descent to below 10,000 feet cabin altitude.
4. CABIN PRESS switch - CHECK NORM
5. ECS MODE switch - CHECK AUTO

WARNING

DCS may be experienced when operating in an unpressurized cabin above 25,000 feet even with a working oxygen system. Symptoms of DCS include pain in joints, tingling sensations, dizziness, paralysis, choking, and/or loss of consciousness.

If DCS or hypoxia symptoms present -

6. Maintain altitude below 10,000 feet MSL.
7. Land as soon as possible.

If DCS or hypoxia symptoms not present -

6. Reset emergency oxygen system and resume normal OBOGS operation.
7. Maintain altitude below 25,000 feet MSL.
8. Land as soon as practical.

15.10 DISPLAY MALFUNCTION - NON-AMCD AIRCRAFT

If a display malfunctions, cycle power to attempt to restore normal functioning. HUD symbology is provided by either DDI, with the LDDI as the primary driver. If the HUD malfunctions, consider also cycling both DDI power knobs. The same holds true for the UFCD which is powered by the MPCD. If a display continues to malfunction, turn it off to prevent an overheat.

If all displays are flashing, turn MC1 and MC2 off alternately to see if the problem clears. If one or more displays are frozen with an accompanying MC1 or MC2 caution, turn off the failed MC. If all displays then go blank, cycle power to the operating MC, then resecure the failed MC.

15.11 DISPLAY MALFUNCTION - AMCD AIRCRAFT

If a display malfunctions (stale data or DDI pushbuttons do not work), attempt to restore by cycling display power. If cycling power to the display does not fix the problem, cycling the corresponding mission computer may restore the DDI (cycle MC1 for LDDI, MC2 for RDDI). HUD symbology is driven by either MC1 or MC2. If the UFC/D malfunctions, attempt to restore by cycling the MPC/D or (LOT 26 AND UP) 8 x 10 display.

If all displays are flashing STANDBY, and a backup HUD is displayed in the front cockpit, a dual MC failure has occurred.

15.12 DUAL MISSION COMPUTER (MC) FAILURE - AMCD AIRCRAFT

A dual MC failure is recognized by STANDBY flashing on the HUD and L/RDDIs. In the front cockpit, a backup HUD format (driven by the SDC) is displayed on the MPC/D and UFC/D. After cycling an MC, the corresponding display (LDDI for MC1, RDDI for MC2) continues to flash STANDBY for approximately 11 seconds while the MC boots up.

1. MC switch - CYCLE TO 1 OFF, THEN TO 2 OFF

After 15 seconds, if MC1 is restored (MC1 Backup Mode) -

2. MC switch - MOVE FROM 2 OFF TO NORM

15.13 OUT-OF-CONTROL FLIGHT (OCF)

WARNING

Selection of manual spin recovery mode (SPIN switch in RC/VY) seriously degrades controllability, will prevent recovery from any departure or spin, and is prohibited.

15.13.1 Departure from Controlled Flight. A typical F/A-18E/F departure occurs as a yaw divergence (nose-slice) followed by an uncommanded roll in the same direction. The yaw divergence can happen very quickly; therefore, the yaw rate tone may not provide sufficient departure warning. Usually, a departure is preceded by a slow buildup in sideslip and uncomfortable sideforces. The buildup of sideslip is accompanied by "vortex rumble"; however, vortex rumble may not be noticed during aggressive maneuvering. Therefore, excessive sideforce provides the most reliable departure warning cue to the pilot. The initial phase of the departure is not particularly violent or disorienting unless it occurs at high airspeed or Mach number. Recognition of these cues permits neutralization of the controls and avoidance of a departure.

15.13.1.1 Departures with Lateral Weight Asymmetries. Complying with NATOPS limits for asymmetric store loadings is required to prevent departures. Aggressive longitudinal maneuvering beyond NATOPS AOA limits may result in a yaw departure away from the heavy wing, which cannot be controlled with lateral stick or pedal inputs. At low airspeed, recovery is immediate when AOA is reduced below NATOPS limits. At higher airspeed, more violent and sudden departures may occur with little or no warning when maneuvering aggressively beyond NATOPS limits. In such cases, the resulting post-stall gyrations rapidly transition to an upright spin away from the heavy wing.

15.13.1.2 Departure Recovery. Recovery is generally very prompt, on release of the controls. Some departures, particularly from inadvertent tailslides, may exhibit large transitory sideslips or negative

g rolls prior to positive recovery. Sideslip type departures yield excessive gravity-induced sideslip at relatively slow airspeeds (<90 KCAS) and can quickly develop into a spin. In the absence of a steady spin arrow, controls should remain neutral throughout all such post departure motion, as CAS reliably regains control. Any pilot input will delay recovery or precipitate further departure. For departure recoveries that stabilize in a negative g stall, application of aft stick may be used to finish the recovery.

15.13.2 Spin. Spin is confirmed by a steady spin arrow or the presence of a sustained yaw rate, elevated positive or negative AOA, and airspeed less than 150 KCAS. F/A-18E/F spin arrows very reliably indicate the appropriate recovery action. While some departures may generate sufficient yaw rate to trip the command arrow, they are typically self-recovering by the time the arrow is displayed, and the arrow will quickly disappear. Therefore, with the spin arrow present, a brief hesitation is all that is required to confirm a steady, valid arrow prior to applying anti-spin lateral stick.

15.13.2.1 Spin Recovery. The command arrow indicates the proper control stick position for upright or inverted spins. For upright spins, the command arrow directs the pilot to apply full lateral stick with the spin direction. For inverted spins, the command arrow directs the pilot to apply full lateral stick opposite the spin direction. In general, spin recovery is straightforward and reliable if the OCF procedures are followed and sufficient altitude remains. For lateral weight asymmetry loadings, recoveries from upright spins away from the heavy wing are essentially identical to the symmetrical loaded airplane. Spin recoveries for less common upright spins into the heavy wing, and inverted spins, were sometimes delayed due to the oscillatory nature of the spin. Recovery begins immediately but may take up to one turn to become apparent. Recovery from a fully developed spin may include high roll rates with significant negative g unloads, which, though disorienting and uncomfortable, should be interpreted as a positive indication of imminent recovery. When the command arrow is removed, lateral stick should be smoothly returned to neutral. Maintaining anti-spin lateral stick after the command arrow has disappeared may transition the recovering spin into a controllable roll that could delay recovery.

15.13.3 OCF Recovery Procedures

*1. Controls - RELEASE, FEET OFF RUDDERS, SPEEDBRAKE IN

If still out of control -

*2. Throttles - IDLE

*3. Altitude, AOA, airspeed, and yaw rate - CHECK

If command arrow present -

*4. Lateral stick - FULL WITH ARROW

When command arrow removed -

*5. Lateral stick - SMOOTHLY NEUTRAL

When recovery indicated by AOA and yaw rate tones removed, side forces subsided, and airspeed accelerating above 180 knots -

*6. Recover.

WARNING

Failure to ensure all criteria are met may result in departure during recovery.

Passing 6,000 ft AGL, dive recovery not initiated -

*7. Eject.

15.13.4 Post Departure Dive Recovery**WARNING**

- Recovery is indicated when AOA and YAW rate tones are removed, side forces subside, and airspeed is accelerating above 180 knots. Failure to ensure all criteria are met may result in redeparture during recovery.
- Limit AOA to 10° during a recovery from departure caused by a flap system failure/malfunction (FCS/FC AIR DAT/FLAPS OFF cautions) to avoid departing the aircraft. Departure warning is characterized by an uncommanded yaw/roll.
- Post departure dive recovery initiated below 6,000 feet AGL is not assured. Delaying the ejection decision below 6,000 feet AGL while departed may result in unsuccessful ejection.

1. One-g roll to the nearest horizon.
2. Throttles - MAX (MIL if altitude not critical)
3. Pull to and maintain 25° to 35° AOA until positive rate of climb established (AOA configuration dependent).

WARNING

A positive rate of climb requires wings level pitch attitude (waterline) greater than indicated AOA.

If aircraft departs during dive recovery below 6,000 ft AGL -

4. Eject.

15.14 CONTROLLABILITY CHECK

Requirement: Malfunction, failure, or damage, which degrades approach and landing characteristics.

Purpose (to determine):

- Whether to attempt an approach or a controlled ejection.
 - Safe landing configuration.
 - Safe final approach airspeed/AOA.
1. Climb to and maintain a safe altitude in VMC:
 - 15,000 feet AGL (recommended)
 - At or above 5,000 feet AGL (if practical)
 2. Coordinate a visual inspection (if possible).
 3. Plan to configure aircraft and conduct controllability check as close to field/CV as possible (avoid populated areas if able).
 - In all cases, consider BINGO fuel requirements.
 4. Reference the appropriate emergency procedure to plan the following:
 - Normal or Emergency Landing Gear Extension
 - Appropriate flap setting for controllability check and landing
 - AOA and/or airspeed limitations
 - Any controllability issues that may arise from landing gear and/or flap extension
 - Desired landing gross weight and fuel dump plan
 5. Consider Select Jettison stores prior to gear extension if:
 - Lateral weight asymmetry is over 12,000 ft-lb to establish a more symmetric configuration
 - Emergency Landing Gear extension required (i.e., no HYD 2A)
 - Stated in appropriate emergency procedure

If single engine -

6. Reduce gross weight (44,000 lb max, lower if practical).
7. Maintain operating engine above 80 % RPM during flap and landing gear extension.
8. Do not exceed 15° AOB in turns (if possible).

If normal landing gear extension possible (i.e., no HYD2A caution) -

9. Slow to below 250 KCAS.
10. LDG GEAR handle - DN

If normal landing gear extension not possible -

9. Execute Landing Gear Emergency Extension procedure.
 - Do not configure flaps during Landing Gear Emergency Extension.
 - Return to Controllability Check procedure once gear extended.

Once landing gear down and locked -

10. DO NOT TRIM until minimum controllable airspeed is determined.
11. Crosscheck AOA and airspeed during decel.
12. FLAP switch – AUTO/HALF/FULL based on:
 - Flap setting stated in appropriate emergency procedure
 - If single engine, flaps HALF
 - Consideration of type landing, failure/damage, engine performance, etc.
13. Determine minimum controllable airspeed by slowing in 10 knot increments.
 - If still controllable at AOA limit stated in appropriate emergency procedure or on-speed, plan on flying appropriate AOA for approach and landing.
 - If one-half stick or rudder pedal deflection required to maintain balanced flight prior to AOA limit stated in appropriate emergency procedure or on-speed, add 10 knots for airspeed to be used during approach and landing.
 - If lateral stick required for balanced flight, plan for turns in the direction of stick displacement (if possible).
14. Assess:
 - Controllability in a 15° AOB turn
 - Throttle response and wave-off maneuver

If controllability unacceptable to attempt landing -

15. Consider a controlled ejection over an unpopulated area (if possible).

If controllability acceptable to attempt landing -

15. Fly a straight-in approach.
 - Do not go slower than the minimum-controllable-airspeed-plus-10 knots, or equivalent AOA, as determined during controllability check.

If single engine -

16. Execute Single Engine Approach and Landing procedure.

If dual engine -

16. Return to appropriate emergency procedure to ensure all corrective action steps are completed prior to attempting approach to landing.
17. If arrested landing desired/required, consider effects of approach speed on max arresting-gear engagement speed.
18. If controllability changes or safe landing is not certain at any point on approach, execute wave-off/missed approach immediately.

15.15 EXTERNAL STORES JETTISON

Refer to External Stores Jettison Chart (figure 15-9).

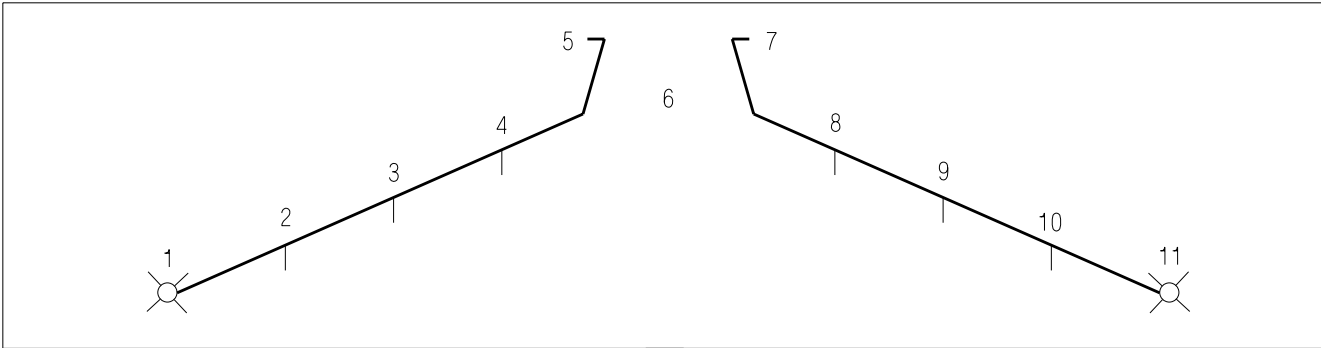

EFN520-347-1-002

EMERGENCY JETTISON

Requirements: WoffW or LDG GEAR handle UP

1. EMERG JETT button - PUSH Jettison all stores/racks/launchers sequential by station pairs: 3 & 9, 2 & 10, 4 & 8, then 6 (100 ms)

SELECTIVE JETTISON

Requirements:

(1) WoffW, (2) LDG GEAR handle UP, (3) All landing gear up and locked

1. Find a clear area (if possible).
 2. LT TEST switch - TEST Verify all JETT STATION SELECT buttons are illuminated.
 3. JETT STATION SELECT buttons - SELECT DESIRED STATIONS (CTR, LI, RI, LM, RM, LO, RO)
 4. SELECT JETT knob - ROTATE (as required)
 - a. L FUS MSL - Left fuselage missile
 - b. R FUS MSL - Right fuselage missile
 - c. RACK/LCHR - Rack/launcher (jettisons whatever is attached to the selected parent racks)
 - d. STORES - (1) Jettisons ordnance loaded on selected parent racks, CVERs, or IMERs;
(2) Jettisons missiles attached to launchers on selected stations except HARM;
(3) HARM anti-compromise launch.
 5. SIM mode - UNBOXED
 6. MASTER ARM switch - ARM
 7. SELECT JETT button - PUSH Jettison sequential by selected stations: RM, LM, RI, LI, CL, RO, LO (350 ms)
- After jettison -
8. MASTER ARM switch - SAFE
 9. SELECT JETT knob - SAFE

NOTE

- Outboard station ADU-773 missile rails cannot be jettisoned, since they are installed in place of a BRU-32 rack.
- If multiple stations selected for STORE jettison include AGM-88s, the first HARM in the default sequence is launched first, then the sequence continues from that station, releasing the remaining selected non-HARM stores. Regardless of the number selected, only one HARM is launched each time the SELECT JETT button is pushed.
- With the SELECT JETT knob rotated out of the SAFE position, the SMS unlocks all racks/launchers. When SAFE is reselected, racks/launchers are not locked again until commanded by either lowering the landing gear or selecting SIM mode.

AUX RELEASE

Requirements: (1) station must be H+LKD or H+ULK following a failed normal release or SELECT JETT attempt, (2) WoffW, (3) MASTER ARM switch - ARM (SIM unboxed), (4) auxiliary cartridge installed in the HUNG parent rack.

WARNING

During an AUX REL, the Mk 19 auxiliary cartridge is fired, opening the selected parent rack's hooks and allowing the attached store or rack/launcher to free fall from the aircraft. Lacking a forced ejection, this release mode is prohibited except in an emergency and then only in 1.0g level flight.

NOTE

A Mk 19 auxiliary cartridge is not installed in a parent rack when a wing station is loaded with an IMER, a HARM, a Maverick, a Harpoon, or a SLAM.

1. Find a clear area (if possible).
 2. LT TEST switch - TEST Verify all jettison pushtiles are illuminated.
 3. AUX REL switch - ENABLE
 4. Jettison pushtiles - SELECT HUNG STATION(S)
 5. SELECT JETT knob - ROTATE TO EITHER RACK/LCHR or STORES
 6. SIM mode - UNBOXED
 7. MASTER ARM switch - ARM
 8. SELECT JETT button - PUSH
Fires the aux cartridge(s) for gravity release of all stores/racks/launchers from the selected parent rack(s).
- After AUX REL -
9. MASTER ARM switch - SAFE
 10. SELECT JETT knob - SAFE
 11. AUX REL switch - NORM

Figure 15-9. External Stores Jettison Chart

15.16 ARS MALFUNCTIONS

15.16.1 ARS Hose Fails to Retract.

1. Reduce airspeed to 230 KCAS or less.
2. Recycle HOSE switch.



A shipboard/field arrestment is not recommended with a trailing hose. Either a field landing with arresting gear derigged, or a hose jettison is recommended. Refer to ARS Refueling Hose Jettison.

15.16.2 ARS Refueling Hose Jettison.

1. Airspeed - Maintain 250 KCAS, level flight
2. HOSE CUT/SAFE switch - CUT (3 seconds minimum)



Consideration should be given to a controlled jettison in a safe retrieval area, such as abeam the runway on a low altitude, slow speed pass to possibly save the MA-3 coupling and basket.

NOTE

It is recommended that a visual inspection be made prior to, and during, hose jettison.

15.16.3 ARS Hydraulic Pressure Light. If the HYD PRESS light illuminates, reel response may be lost, a hydraulic failure may be imminent, and/or the hose may not retract.

1. Receiver aircraft - Disengage
2. Fuel TRANS switch - OFF
3. Reduce airspeed to 220 KCAS.
4. HOSE switch - RETR
5. PWR switch - OFF

15.16.4 No RDY Light.

1. Make sure tanker is clear aft.
2. Increase airspeed (do not exceed 300 KCAS).
3. HOSE switch - RESET

15.17 EMERGENCY TANKER DISENGAGEMENT

Emergency disengagement may be required if difficulties occur in either the tanker or the receiver aircraft. Emergency breakaway signals are by radio transmission and/or turning on the lower anti-collision lights. If the situation allows, normal, but expeditious, disconnect procedures should be followed to minimize the possibility of aircraft damage.



The following procedures may result in damage to the tanker and/or receiver aircraft.

Tanker -

1. Throttles - MIL

Receiver -

1. Throttles - IDLE
2. SPEEDBRAKE switch - AFT

15.18 FCS FAILURE INDICATIONS AND EFFECTS

FCS failures are indicated by various cautions and by FCS format Xs and BLIN codes. Following display or annunciation of an FCS caution, the FCS format should be used to identify the exact malfunction/failure.

With the failure of FCC channels 1 and 3, the FCS format displays the word INVALID in place of the G-LIM advisory. Subsequent FCS failures or resets will not be displayed.

The following figures depict typical FCS failure indications and their effects for the majority of FCS related malfunctions/failures.

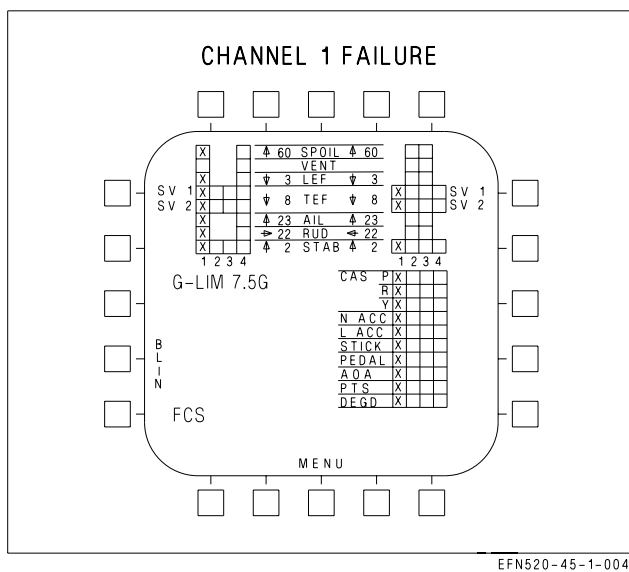

EFFECTS:
Loss of speedbrake function.

Figure 15-10. FCS Failure Indications and Effects

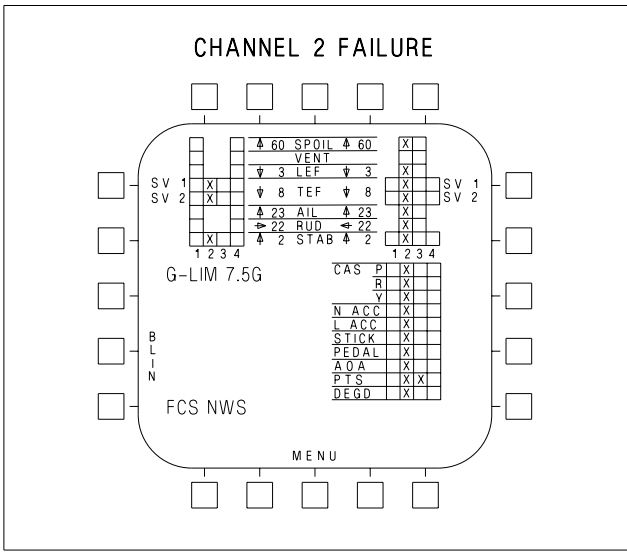

Figure 15-11. FCS Failure Indications and Effects - Channel 2

EFFECTS:

- ATC inoperative.
- Normal NWS inoperative.
- Loss of HUD barometric altitude (radar altitude available below 5,000 feet).
- Standby altimeter available.
- Loss of IFF altitude reporting.
- Loss of speedbrake function.
- Loss of Air Data from right pressure transmitter set (PTS)
- Loss of AOA/yaw rate warning tone.
- Autopilot pitch mode defaults to FPAH if BALT or RALT were previously selected.
- MAD sensor data lost.

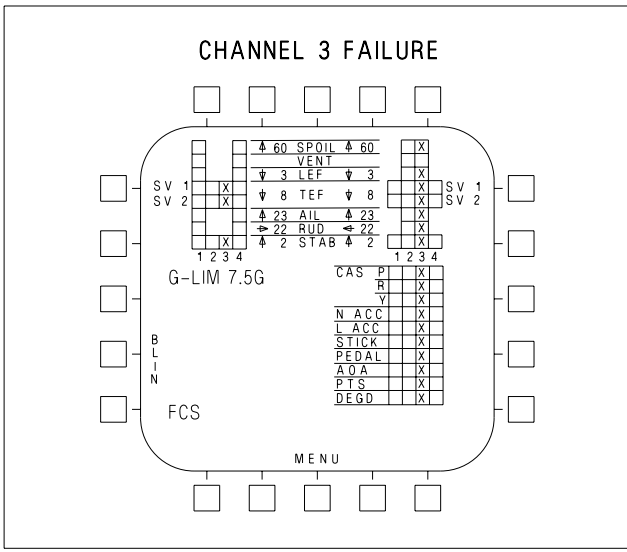

Figure 15-12. FCS Failure Indications and Effects - Channel 3

EFFECTS:

- Loss of speedbrake function.

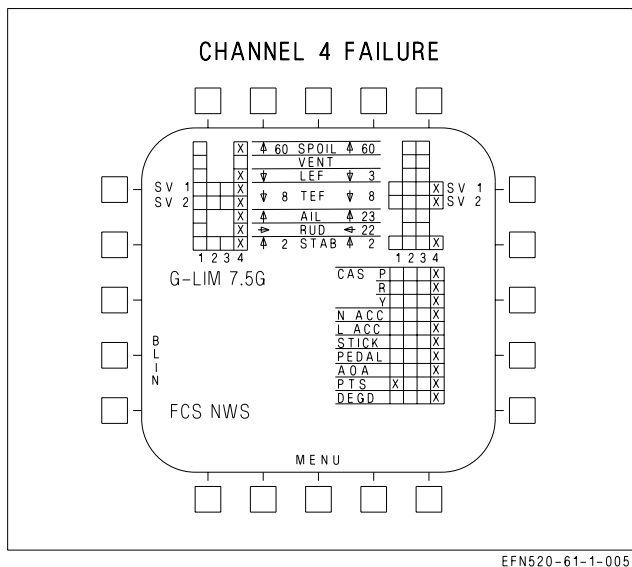

Figure 15-13. FCS Failure Indications and Effects - Channel 4

EFFECTS:

- ATC inoperative.
- Normal NWS inoperative.
- Loss of Air Data from left pressure transmitter set (PTS)
- Loss of AOA approach/indexer lights.
- Loss of speedbrake function.
- Loss of AHRS over temperature detection.

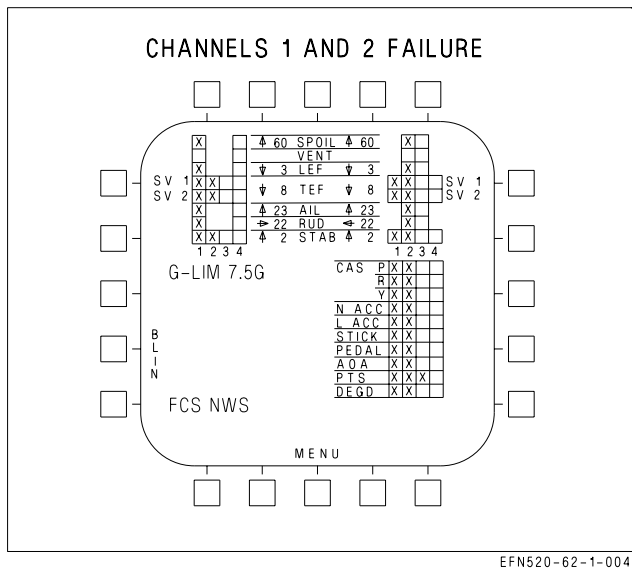

Figure 15-14. FCS Failure Indications and Effects - Channels 1 and 2

EFFECTS:

- ATC inoperative.
- Autopilot inoperative.
- Normal NWS inoperative.
- Loss of Air Data from left pressure transmitter set (PTS)
- Loss of HUD barometric altitude (radar altitude available below 5,000 feet).
- Standby altimeter available.
- Loss of IFF altitude reporting.
- Loss of speedbrake function.
- MAD sensor data lost.

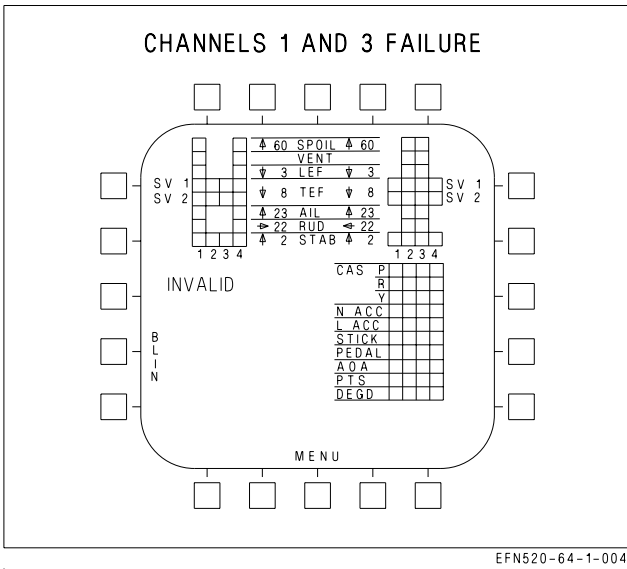

Figure 15-15. FCS Failure Indications and Effects - Channels 1 and 3

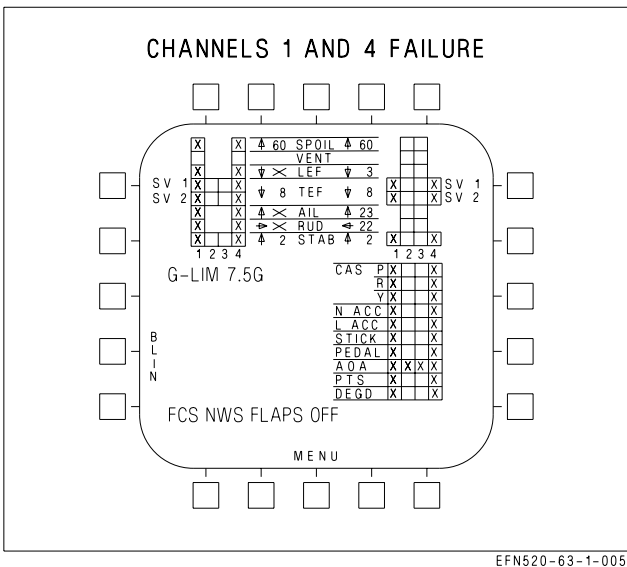

Figure 15-16. FCS Failure Indications and Effects - Channels 1 and 4

NOTE

A simultaneous failure of channels 1 and 3 prevents the display of any FCS cautions. The FCS display shows the word INVALID. Use FCES light to monitor FCS failures.

EFFECTS:

- Autopilot inoperative.
- Loss of HUD air data displays.
- Roll rate limiting is failed. Use no more than 1/2 lateral stick with rate limited stores aboard.
- FCS G-limiter defaults to 7.5g.
- Degraded flying qualities >20° in AUTO FLAPS.
- Use no more than ±15° bank when selecting HALF or FULL FLAPS from AUTO FLAPS.
- Loss of speedbrake function.

EFFECTS:

- FLAP SCHED caution is not displayed.
- Left probe AOA blanked from FCS status page.
- Autopilot inoperative.
- ATC inoperative.
- Normal NWS inoperative.
- Left leading edge flap locked in failed position.
- Left aileron and left rudder failed (flutter damper).
- Left spoiler.
- Loss of Air Data from left pressure transmitter set (PTS)
- Flaps - AUTO:**
 - Loss of speedbrake function.
 - Flaps freeze.
- Flaps - HALF or FULL:**
 - Right leading edge flap frozen.
 - Trailing edge flaps 30° or 40° maximum.
 - Scheduled with airspeed.
 - No aileron droop.
 - No rudder toe-in.
 - Loss of AOA approach/indexer lights.
 - Loss of AHRS over temperature detection.

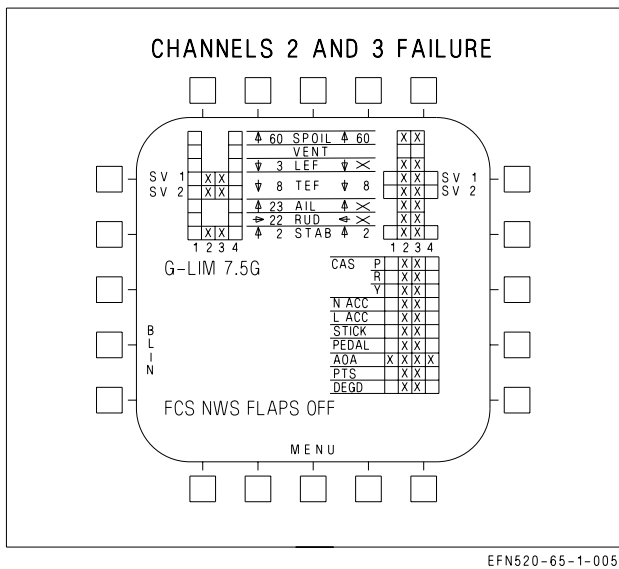

Figure 15-17. FCS Failure Indications and Effects - Channels 2 and 3

EFFECTS:

- Right probe AOA blanked from FCS status page.
- Autopilot inoperative.
- ATC inoperative.
- Normal NWS inoperative.
- Right leading edge flap locked in failed position.
- Right aileron and right rudder failed (flutter damper).
- Standby altimeter available.
- Loss of IFF altitude reporting.
- Loss of AOA/yaw rate warning tone.
- MAD sensor data lost.

Flaps - AUTO:

- TEFs will not schedule with AOA but operate differentially for roll.
- Loss of speedbrake function.

Flaps - HALF or FULL:

- Left leading edge flap frozen.
- Trailing edge flaps 30° or 40° maximum.
- Scheduled with airspeed.
- No aileron droop.
- No rudder toe-in.

NOTE

If failure occurs in flaps AUTO, GAIN ORIDE must be selected to obtain HALF or FULL flaps setting.

EFFECTS:

- FLAP SCHED caution may be displayed.
- Autopilot inoperative.
- ATC inoperative.
- Loss of HUD barometric altitude, airspeed and vertical velocity.
- Loss of IFF altitude reporting.
- Loss of FCES light.
- Loss of AOA bracket and AOA approach/indexer lights.
- Loss of speedbrake function.
- Loss of AOA/yaw rate warning tone.
- Loss of air data.
- MAD sensor data lost.
- Loss of AHRS over temperature detection

Flaps - AUTO:

- Degraded flying qualities.
- Flaps function with frozen air data values.
- Flaps schedule with AOA.

Flaps - HALF or FULL:

- Trailing edge flaps 30° or 40°.
- Leading edge flaps and rudder toe-in schedule with AOA.
- NWS inoperative.

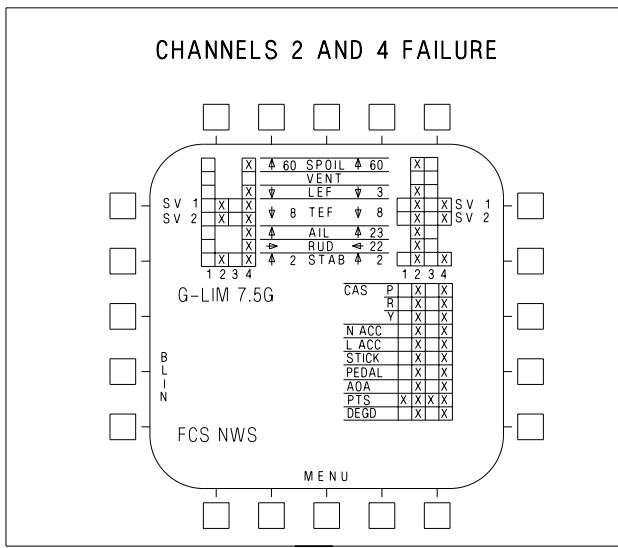
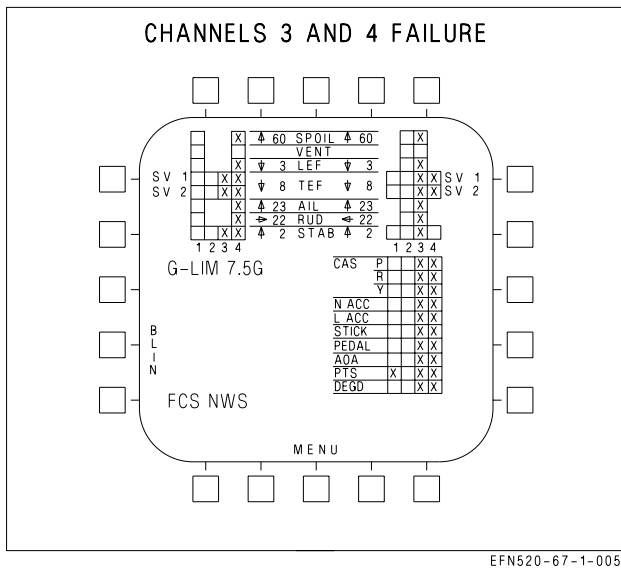
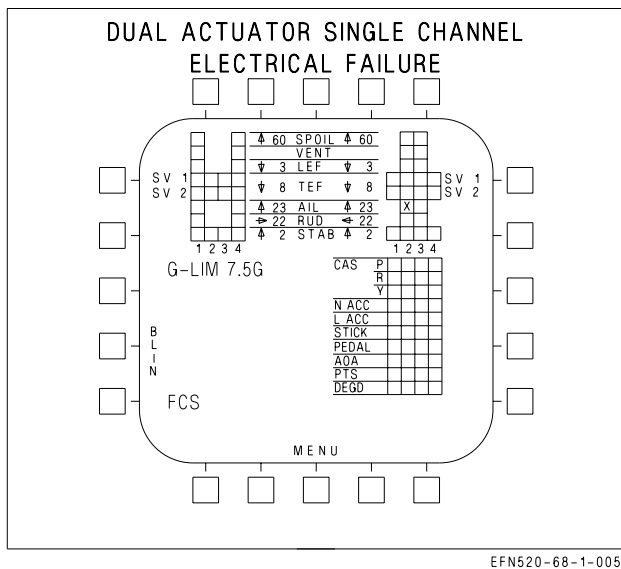

Figure 15-18. FCS Failure Indications and Effects - Channels 2 and 4



EFFECTS:
 Autopilot inoperative.
 ATC inoperative.
 Normal NWS inoperative.
 Loss of AOA bracket and AOA approach/indexer lights.
 Loss of speedbrake function.
 Loss of AOA/yaw rate warning tone.
 Loss of AHRS overtemperature detection.
 Loss of Air Data from left pressure transmitter set (PTS)

Figure 15-19. FCS Failure Indications and Effects



NOTE

FCS status display is shown for a right aileron channel 2 failure but is typical for any single channel failure of aileron, rudder, leading edge flap, or spoiler.

EFFECTS:
 No change in flying qualities.
 One more electrical failure causes the actuator to revert to degraded mode.

Figure 15-20. FCS Failure Indications and Effects

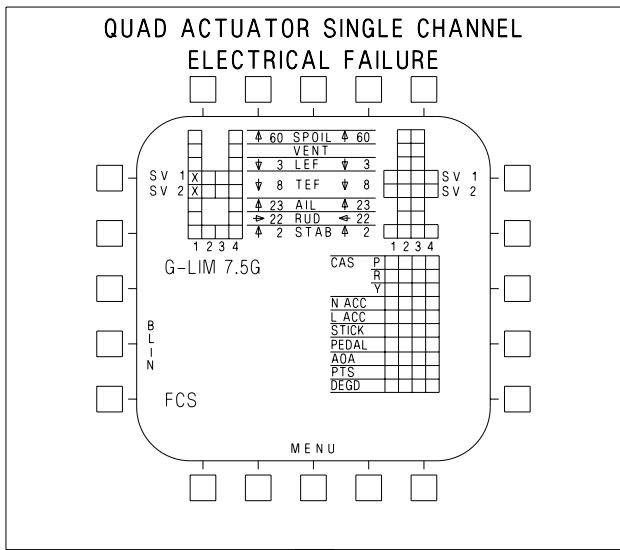

EFN520-69-1-005

Figure 15-21. FCS Failure Indications and Effects

NOTE

FCS status display is shown for a left trailing edge flap channel 1 failure but is typical for any single channel failure of trailing edge flap or stabilator.

EFFECTS:

No change in flying qualities.
Two more electrical failures causes the actuator to revert to degraded mode.

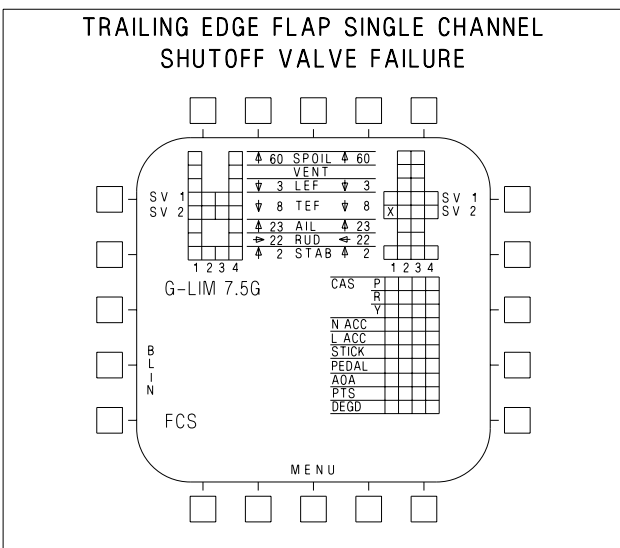

EFN520-94-1-005

Figure 15-22. FCS Failure Indications and Effects

NOTE

FCS status display is shown for a channel 1 right trailing edge flap shutoff valve 2 failure but is typical for any channel failure of trailing edge flaps shutoff valves.

EFFECTS:

No change in flying qualities.
Actuator reduced to half hinge moment capability if four channels of single shutoff valve fail.

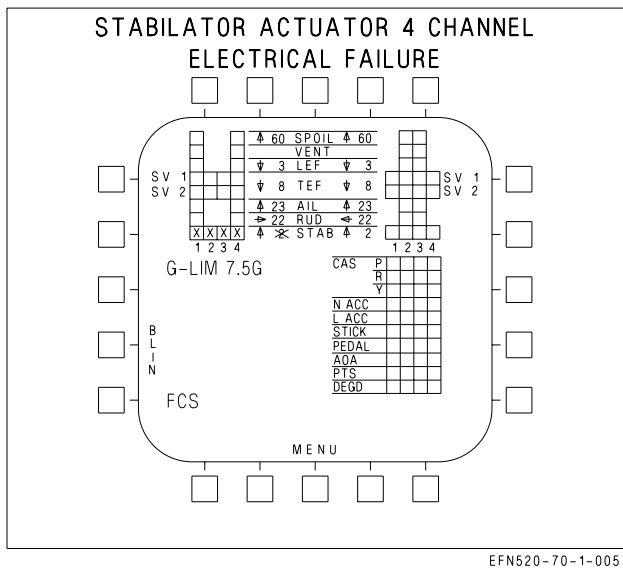

Figure 15-23. FCS Failure Indications and Effects

NOTE

FCS status display is shown for a left stabilator 4 channel failure example.

EFFECTS:

Autopilot inoperative.

Failed stabilator hydraulically driven to 2° trailing edge up.

Automatic compensation for failed stabilator.

Flaps - AUTO:

Low roll rate in transonic region below 20,000 feet.

Significant roll and yaw coupling may occur with forward stick inputs when above Mach 1.4 and 30,000 feet.

Reduction in nose down pitch authority above 10° AOA.

Flaps - HALF:

Nearly normal flying qualities.

Minor roll-yaw coupling with longitudinal stick inputs.

Sudden, but controllable, yaw during rotation on bolters or touch-and-go.

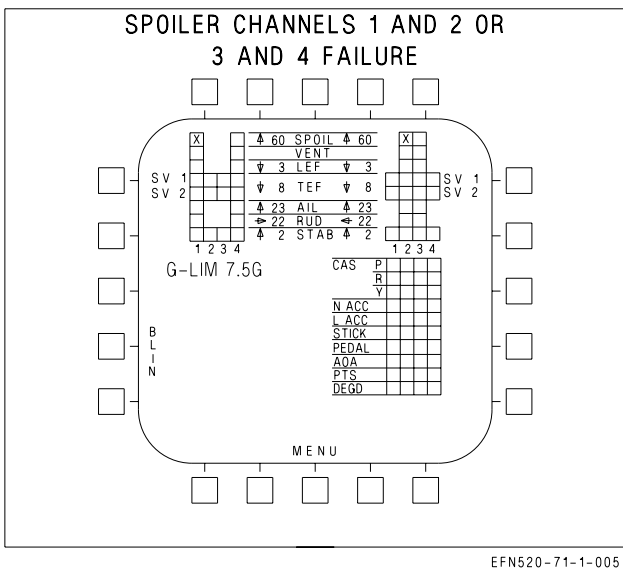

Figure 15-24. FCS Failure Indications and Effects

NOTE

FCS status display is shown for channels 1 and 2 failure example.

EFFECTS:

FCS caution is not displayed.

No change in flying qualities.

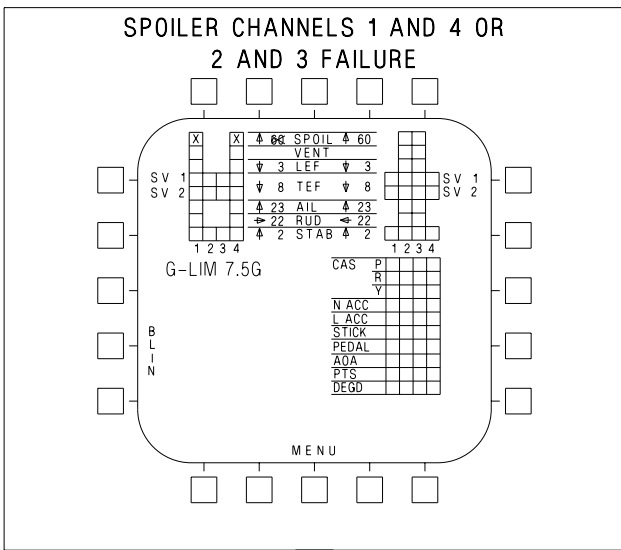

EFN520-72-1-005

NOTE

FCS status display is shown for channels 1 and 4 failure example.

EFFECTS:

Flaps - AUTO:

Spoiler failed closed -

- Available nose-down pitching moment reduced at high AOA.
- Slight uncommanded roll and yaw can occur at high AOA when functional spoiler opens.

Figure 15-25. FCS Failure Indications and Effects

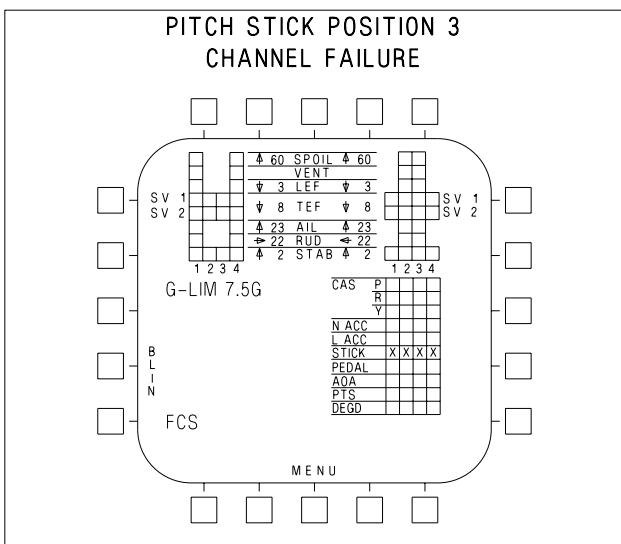

EFN520-75-1-005

EFFECTS:

Autopilot inoperative.

Reduced pitch stick authority.

Flaps - AUTO:

Increased stick force per g.

Flaps - HALF or FULL:

Increased stick force per AOA.

Figure 15-26. FCS Failure Indications and Effects

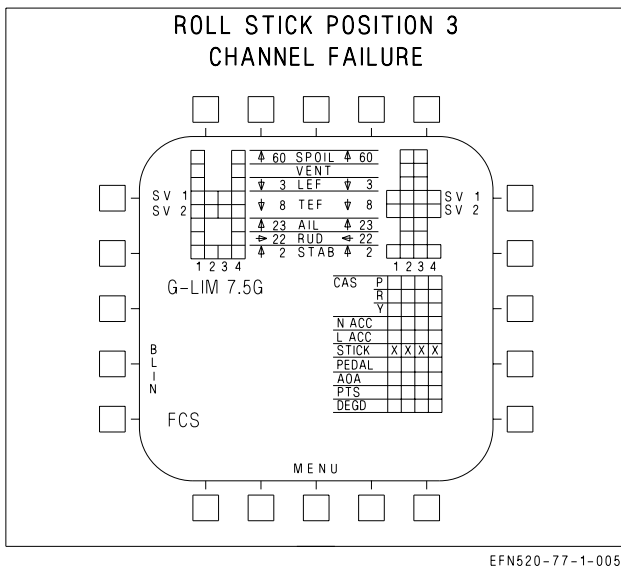

Figure 15-27. FCS Failure Indications and Effects

EFFECTS:
 Autopilot inoperative.
 Reduced roll stick authority.

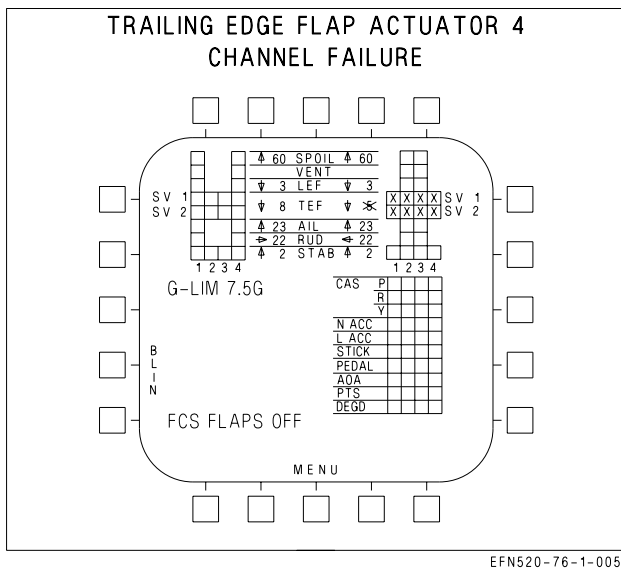

Figure 15-28. FCS Failure Indications and Effects

NOTE

FCS status display is shown for right trailing edge flap four channels failure example.

EFFECTS:
 Autopilot inoperative.
 Trailing edge flaps hydraulically driven to 5°.

Flaps - AUTO:
 Speedbrake function disabled.

Flaps - HALF or FULL:
 Select FULL flaps for maximum aileron droop.
 Excessive approach speed (refer to FLAPS OFF FCS caution).
 Left trailing edge flaps may fail OFF due to asymmetry.

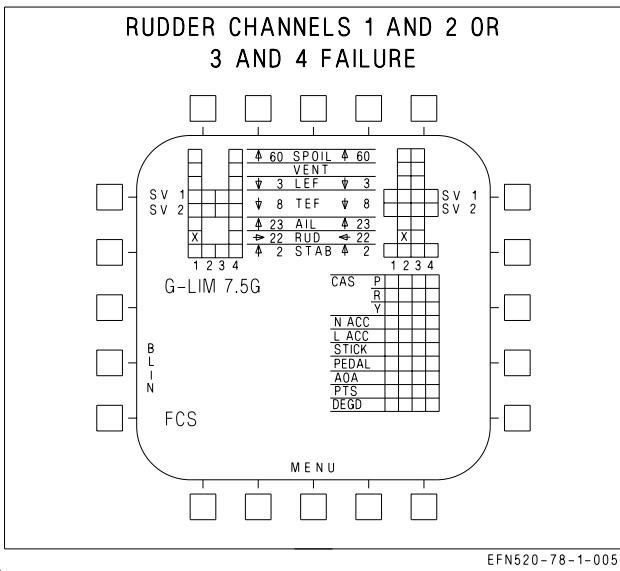

NOTE

FCS status display is shown for channels 1 and 2 failure example.

EFFECTS:

No change in flying qualities.

Figure 15-29. FCS Failure Indications and Effects

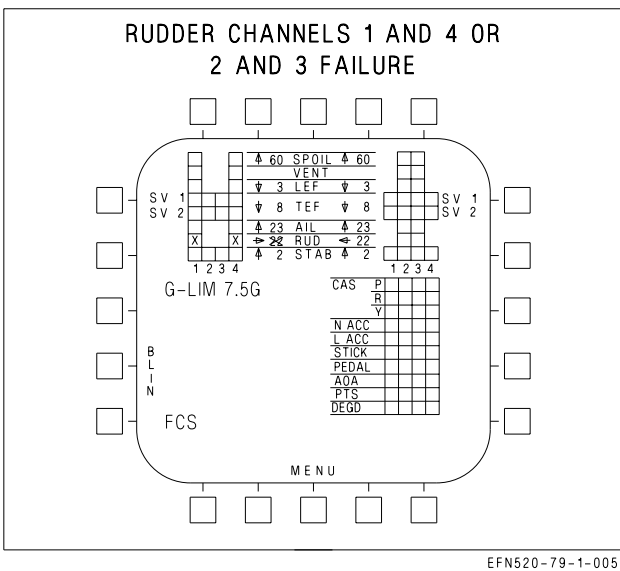

NOTE

FCS status display is shown for channels 1 and 4 failure example.

EFFECTS:

Left rudder (channels 1 and 4) failed (flutter damped) or right rudder (channels 2 and 3) failed (flutter damped).

Directional control critical with one engine inoperative.

Autopilot inoperative.

No rudder toe-in or flare.

Flaps - AUTO:

Speedbrake function disabled.

Figure 15-30. FCS Failure Indications and Effects

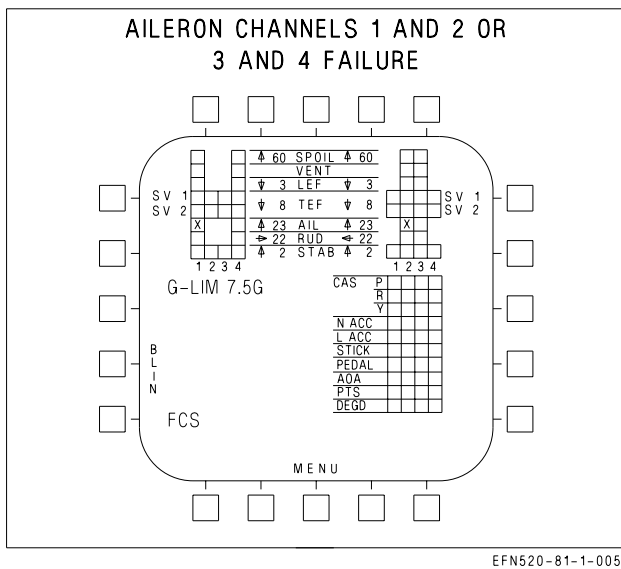

NOTE

FCS status display is shown for channels 1 and 2 failure example.

EFFECTS:

No change in flying qualities.

Figure 15-31. FCS Failure Indications and Effects - Aileron Channels 1 and 2 or 3 and 4

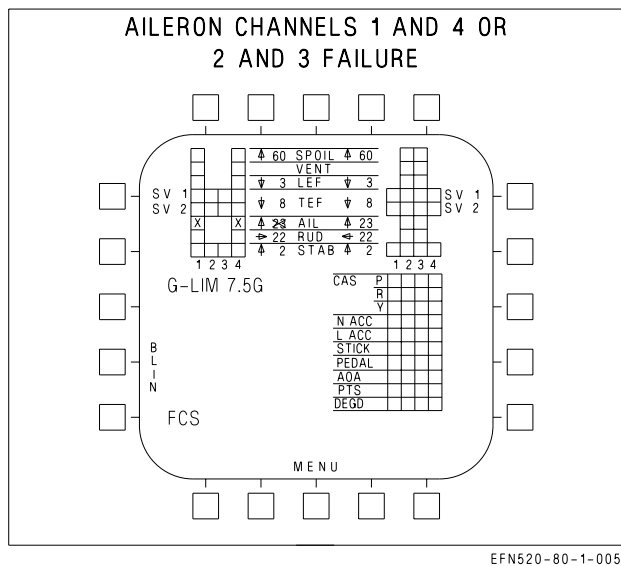

NOTE

FCS status display is shown for channels 1 and 4 failure example.

EFFECTS:

Left aileron (channels 1 and 4) failed (flutter damped) or right aileron (channels 2 and 3) failed (flutter damped).

Autopilot inoperative.

Flaps - AUTO:

Speedbrake function disabled.

Flaps - HALF or FULL:

No aileron droop.

Trailing edge flaps 30° or 40°.

Leading edge flaps and rudder toe-in schedule normally.

Figure 15-32. FCS Failure Indications and Effects - Aileron Channels 1 and 4 or 2 and 3

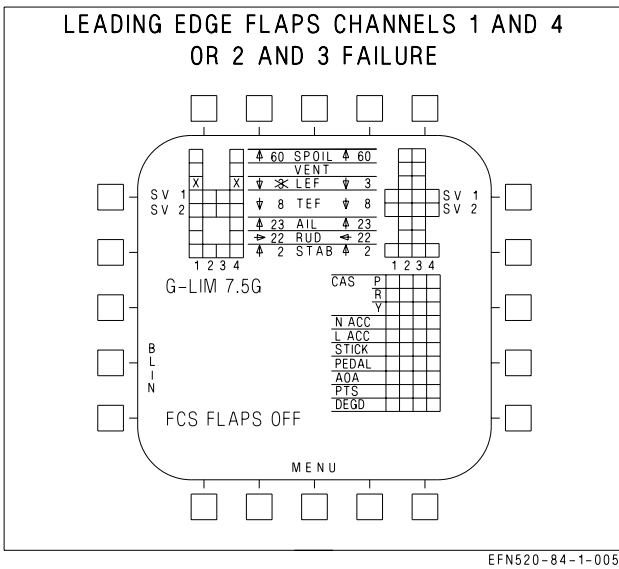

EFN520-84-1-005

Figure 15-33. FCS Failure Indications and Effects - LEF Channels 1 and 4 or 2 and 3

NOTE

FCS status display is shown for channels 1 and 4 failure example.

EFFECTS:

Failed leading edge flap frozen.
Autopilot inoperative.

Flaps - AUTO:

Speedbrake function disabled.
Good flap frozen, responds to differential commands only.

Flaps - HALF or FULL:

Good flap frozen.

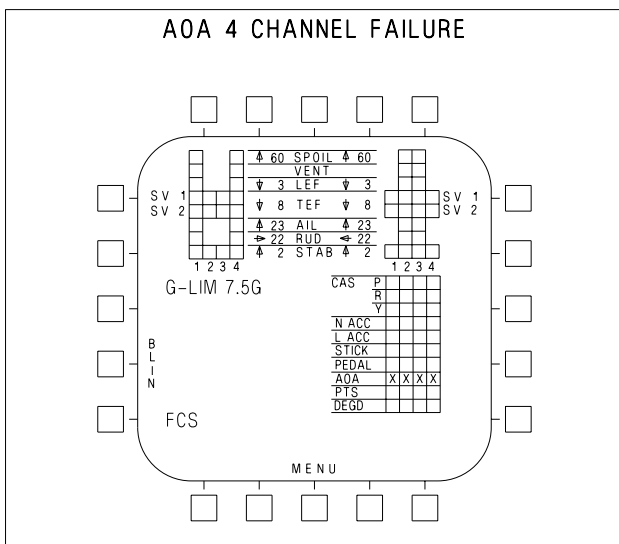

EFN520-82-1-005

Figure 15-34. FCS Failure Indications and Effects - AOA Channel 4

EFFECTS:

Autopilot inoperative.

Flaps - AUTO:

Flaps schedule as a function of estimated AOA.
Flaps go to 5°/4° if GAIN ORIDE selected.

Flaps - HALF or FULL/Gear - DOWN:

Nearly normal flying qualities at 8.1° AOA with GAIN ORIDE selected.
Rudder toe-in disabled.

Loss of AOA bracket and AOA approach/indexer lights without GAIN ORIDE selected.

Flaps scheduled based on estimated AOA.

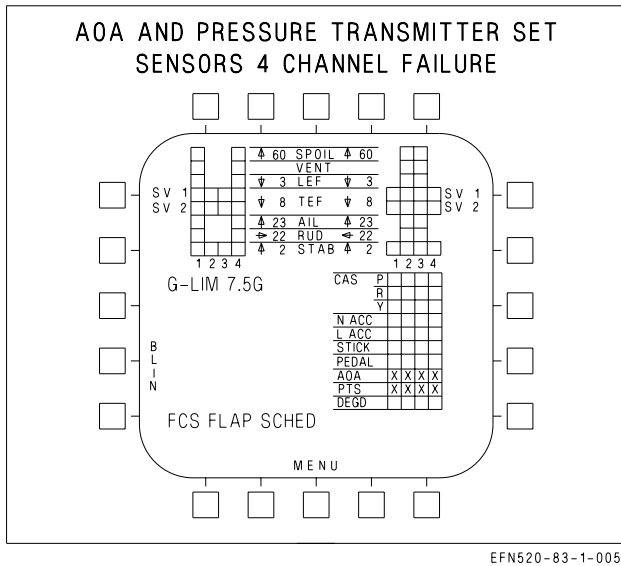

Figure 15-35. FCS Failure Indications and Effects

EFFECTS:

Pitot-static instruments may be inaccurate.
 Autopilot inoperative.
 Air data blanked from HUD.
 Loss of HUD barometric altitude, airspeed, and vertical velocity.
 Standby altimeter may be available.

Flaps - AUTO:

Degraded flying qualities.
 Flaps freeze.
 Flaps go to 5°/4° if GAIN ORIDE selected.

Flaps - HALF or FULL:

No rudder toe-in.
 Flaps freeze.
 Flaps go to 21°/30° or 21°/40° if GAIN ORIDE selected.
 Loss of AOA bracket and AOA approach/indexer lights without GAIN ORIDE selected.

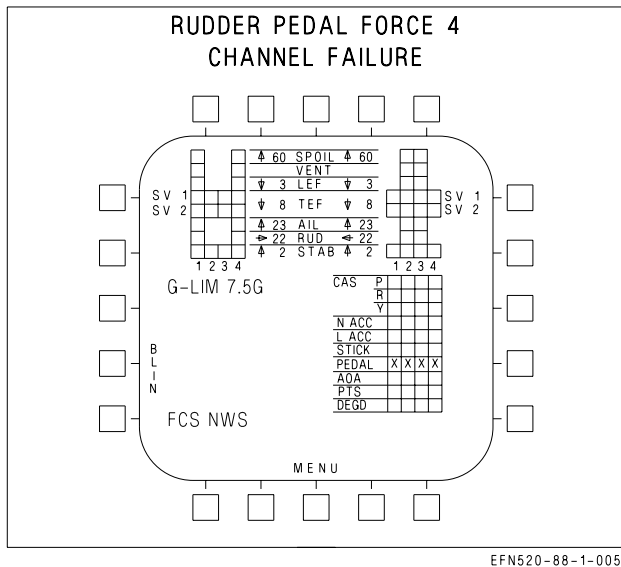

Figure 15-36. FCS Failure Indications and Effects

EFFECTS:

NWS caution is also displayed.
 Reduced rudder pedal authority.
 Lateral stick gives rudder for roll coordination.

Flaps - AUTO:

Trim gives 10° rudder authority.

Flaps - HALF or FULL:

Trim gives 22.5° rudder authority.
 NWS inoperative.

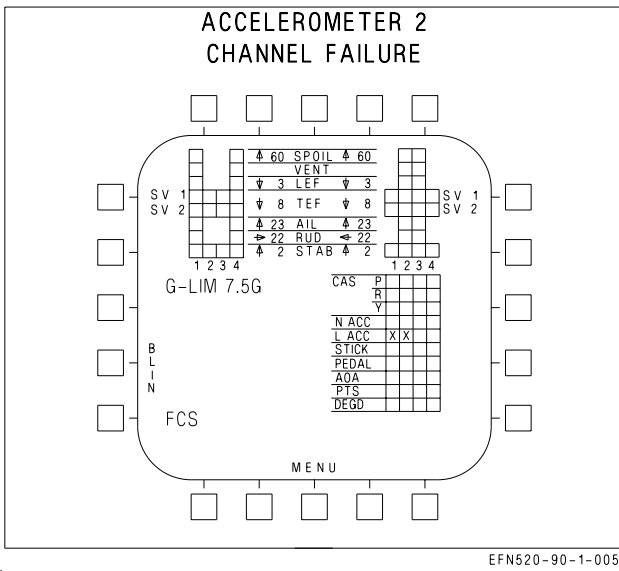

NOTE

FCS status display is shown for lateral accelerometer channels 1 and 2 failure example.

EFFECTS:

No change in flying qualities.
Autopilot inoperative.

Figure 15-37. FCS Failure Indications and Effects

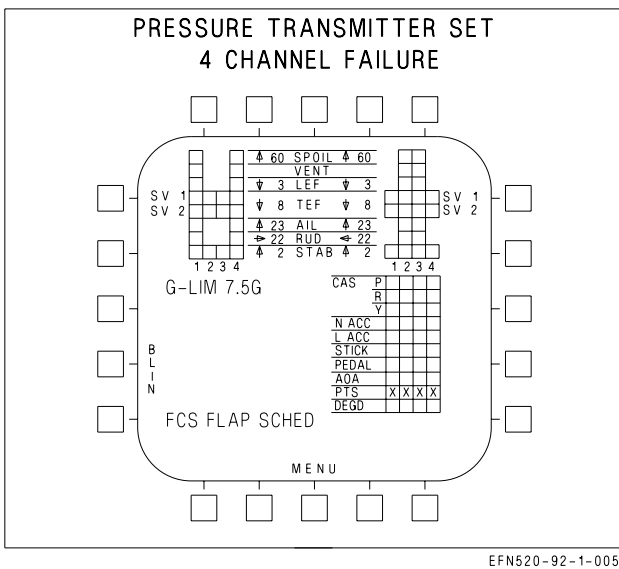

EFFECTS:

Pitot-static instruments may be inaccurate.
Autopilot inoperative.
Loss of HUD barometric altitude, airspeed, and vertical velocity.
Standby altimeter available.

Flaps - AUTO:

Degraded flying qualities.
Flaps schedule with AOA only.
Flaps go to 5°/4° if ORIDE selected.

Flaps - HALF or FULL:

Trailing edge flaps go to 30° or 40°.
Leading edge flaps and rudder toe-in schedule with AOA.

Figure 15-38. FCS Failure Indications and Effects

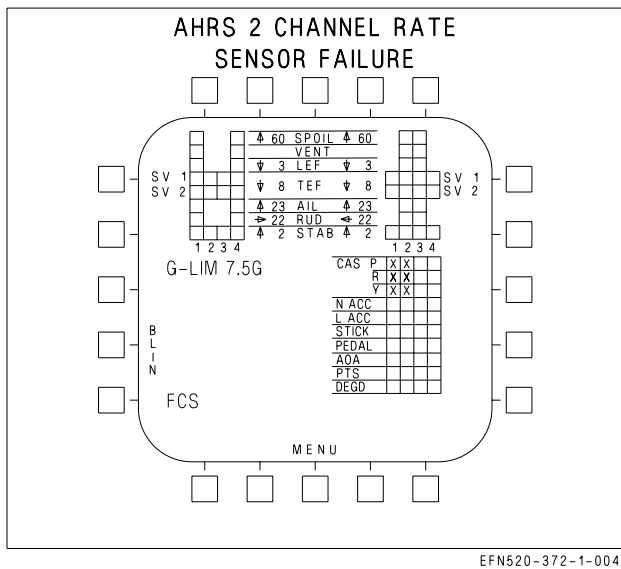

Figure 15-39. FCS Failure Indications and Effects

EFFECTS:

Autopilot inoperative.
 If third undetected failure occurs, the following flying qualities will be evident -
 Poor roll coordination with large lateral inputs.
 Pitch coupling.
 Sluggish pitch response.

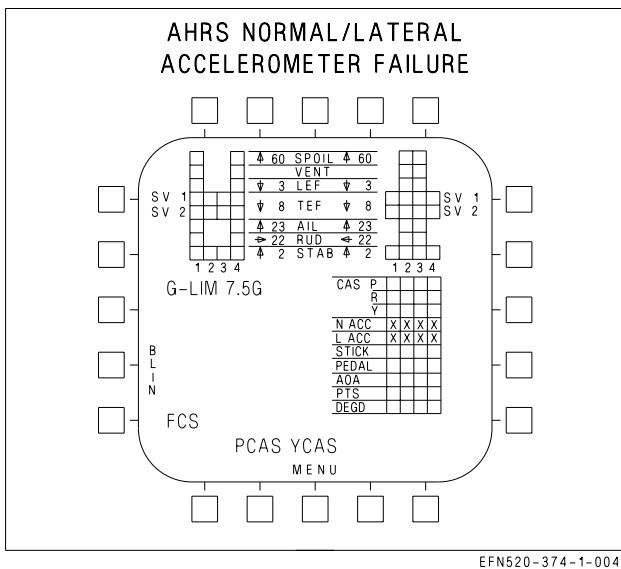

Figure 15-40. FCS Failure Indications and Effects

EFFECTS:

Autopilot inoperative.
 ATC inoperative.
 Spin recovery arrow not provided, but ASM still available.
Flaps - AUTO:
 Degraded pitch CAS
 Degraded yaw CAS
Flaps - HALF or FULL:
 Large sideslips with full rudder

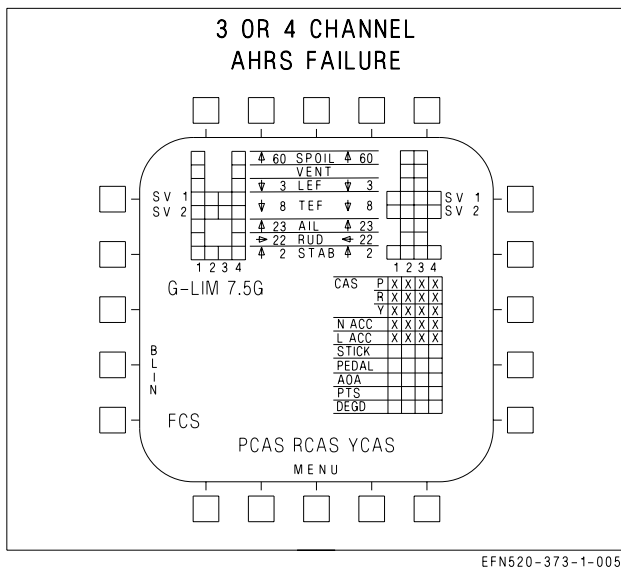

Figure 15-41. FCS Failure Indications and Effects

WARNING

Do not select flaps HALF or FULL.

NOTE

If detected by the FCCs, the indications for a three and four channel failure are the same. A third undetected channel failure appears as a two channel failure.

EFFECTS:

Autopilot inoperative.
ATC inoperative.
Sensitive dynamic pitch characteristics.
Aggressive pitch inputs may result in PIO.
Degraded roll CAS.
Reduced roll damping.
ASRM inoperative.

Flaps - AUTO:

Poor dutch roll damping.
Large sideslip with lateral stick.
Degraded roll CAS.
Reduced roll damping.

Flaps - HALF or FULL:

Uncontrollable.

15.19 ANGLE OF ATTACK (AOA) FAILURE

The AOA values displayed on the FCS Status page on the DDI represent source-error corrected AOA values, also referred to as True AOA values. In normal operation, the average of the Left and Right True AOA values is used to drive the HUD AOA numeric value, E-bracket and indexer lights. The AOA values on the FCS Status page remain displayed even if a probe is damaged or binding. Pilots can use these displayed values at any time to determine the health of each probe by: comparing their values to each other; performing an AOA/airspeed crosscheck; or comparing each value to the center AOA value derived from INS data.

When flaps are in Up/Auto, the HUD AOA numeric value is equal to the average of the displayed left and right AOA probe values until AOA exceeds approximately 45° (True AOA), at which time INS based AOA estimations are used for display.

In Flaps Up/Auto, whenever a filtered difference of the left and right AOA probe values exceeds about 10° (a 15.5° uncorrected, local AOA probe-split), the L-versus-R AOA monitor is tripped, a four-channel AOA failure is declared, and the HUD AOA numeric value is blanked. In Flaps HALF/FULL, whenever the filtered difference of the left and right AOA probe values exceeds the failure threshold (with zero sideslip, about 3° true, 5.5° local AOA), a four-channel AOA failure is declared, and the HUD E-bracket, AOA numeric value and indexer lights are blanked. In Flaps HALF/FULL, the failure threshold is increased as a function of sideslip. With no sideslip, the failure threshold is about 3°, but increases to approximately 10° with 15° of sideslip.

When the L-versus-R AOA monitor is tripped, the following will occur:

- FCS caution is annunciated
- HUD numeric value blanks
- AOA four-channel X-out is displayed on the FCS status page
- An X appears next to the altitude (indicating altitude is not corrected)
- Autopilot will not engage, or will disengage if currently engaged

When flaps are in HALF or FULL, additional indications are:

- ATC will not engage or will disengage if currently engaged
- HUD E-bracket is blanked
- AOA indexer lights and external approach lights are blanked

NOTE

The effects on ATC, HUD E-bracket, AOA indexer lights and external approach lights, and autopilot will also occur if the unfiltered difference in the left and right AOA probes exceeds a failure threshold (with zero sideslip, about 3.4° true AOA) for at least 0.5 seconds.

15.19.1 AOA PROBE DAMAGE OR BINDING. Pilots should be alert for AOA probe damage or binding. Typically, probe-damage is a result of an IFR basket strike, a bird strike or heater malfunction. In the cruise configuration, the FCS software will only recognize a probe is damaged if that damaged probe has an electrical malfunction or has a value that differs from the nondamaged probe by more than the AOA failure-threshold of 10° true AOA (15.5° local AOA). If AOA probe damage is suspected, an AOA/airspeed crosscheck in the landing configuration should be made (with a wingman if possible). After transitioning to the landing configuration, conduct a wings-level AOA/airspeed crosscheck as well as compare the FCS page L and R AOA probe values against the center INS AOA value. Also make gentle, banked turns to ensure the L and R probes are tracking one another. If a damaged probe is confirmed, execute the AOA Four-Channel Failure procedure.

NOTE

In flaps AUTO, an L-versus-R AOA failure is not latched. When the displayed AOA 10° probe-split is no longer exceeded, the failure annunciation will automatically clear and the HUD AOA numeric value will return. This does not mean that both AOA probes are fully functioning. It's only an indication the probes are now back within at least 10° of one another.

A binding probe, on the other hand, can occur at any time as a result of faulty cover installation, manufacturing and/or environmental elements. The best defense against encountering a binding probe is judicious execution of the AOA probe condition-check during the Exterior Inspection prior to takeoff. Once airborne, whenever in the landing configuration, the best defense against a binding-probe condition is routine AOA/airspeed crosschecks and an occasional FCS page L/R AOA probe crosscheck.

In flight, a probe that is binding will typically only make itself apparent in the landing configuration, during gentle, banked turns or wings-level flight, with airspeeds less than 145 KCAS. Binding that causes the filtered difference in the left and right AOA probes to exceed 3° (true AOA) will result in a four-channel X-out.



In flaps HALF/FULL, a L-versus-R AOA failure is latched. DO NOT reset the four-channel AOA failure. When the 3° probe-split is no longer exceeded, the failure annunciation can be manually reset, but this does not mean that both AOA probes are now properly functioning. It is only an indication the probes are momentarily within at least 3° of one another. It is highly likely that the binding-condition which initiated the original failure still exists. When a failure annunciation is reset with an FCS reset, the subsequent return of that failure will cause a reoccurrence of the associated effects (such as loss of rudder toe-in, pitch down transient). This may occur at an inopportune time such as just prior to weight on wheels.

A binding probe can occasionally free-up, providing a valid reset window, but the probe will likely bind again, and it may result in an insidious probe-split of less than 3° that is only detectable by an AOA/airspeed crosscheck or judicious scan of the FCS page. If the failure annunciation is reset with an FCS reset, any transients experienced with the first occurrence of the failure can reoccur when the failure is subsequently annunciated. The appropriate reaction is to execute the AOA Four-Channel Failure procedure. This procedure is designed to drive the pilot to select GAIN ORIDE, enabling the ability to select the functional probe, once it is identified, to regain HUD displays. In addition, GAIN ORIDE provides the pilot with a fixed AOA gain (nominal flying qualities) that is no longer dependent on the health of the AOA probes, thereby providing immunity from further AOA failure anomalies. A binding probe can also be intermittent or momentary. If, during an approach where autopilot and auto-throttle modes are engaged, these modes will disengage if the FCCs detect a momentary AOA split. Simultaneously, the HUD AOA numeric value, E-bracket and indexer lights will blank, even if the split does not persist. If this occurs, be aware that a binding-probe condition or 4-channel AOA failure may be imminent. A persistent split will annunciate a four channel AOA X-out.

15.19.2 AOA PROBE SELECTION AOA probe selection is only available when GAIN ORIDE is engaged. The selected AOA probe is used to drive the HUD AOA numeric value, the E-bracket and indexer/approach lights. This ensures that both the pilot and LSO have valid data displayed, but the selected AOA does not drive or affect the flying qualities. However, the GAIN ORIDE mode does force the control system to employ a fixed set of gains for AOA and air data.

Selection of an AOA probe can only be performed while in GAIN ORIDE and is accomplished by pressing the push-tile on the digital display labeled AOA. The first pressing of the push-tile selects and boxes the left AOA probe and the second pressing selects and boxes the right AOA probe. While a third pressing boxes the center/INS value, that value cannot be selected to drive the HUD displays.

15.19.3 SINGLE AOA FAILURE ON TAKEOFF The FCC software monitors the AOA probe values during takeoff to provide protection against a slow to rotate AOA probe and/or protection for a single stuck AOA probe. The protection activates special logic that is only available during the 12 seconds after lift-off. This logic was developed to allow a safe recoverable field and catapult takeoff. The special

processing logic is engaged if the difference between the left and right AOA probe values exceed the instantaneous mismatch threshold after airspeed exceeds 117 KCAS with weight on wheels or during the first 12 seconds following the transition to weight off wheels.. If this special logic is engaged, an AOA caution is annunciated for 12 seconds following transition to weight off wheels. During that time, the FCCs will use a fixed AOA gain for fly away and the flap state will remain in FULL flaps irrespective of FLAP switch position. If the Left versus Right failure persists, the AOA X-out condition will occur along with an FCS caution. Even if the AOA X-out does not occur, it is recommended that the AOA Four Channel Failure corrective action procedure is used for landing after the mission is complete.

15.19.4 DUAL AOA FAILURE ON TAKEOFF. With FCC OFP 18E-102 and subsequent, there is added protection provided to counter the unlikely event of a dual AOA failure (both probes binding) on takeoff. The FCC software monitors the AOA probe values during takeoff to ensure that they are moving properly. There are two monitors active on takeoff. The first monitor simply looks for both AOA probes to be in the range of -6° to 10° as the aircraft accelerates through 100 to 112 KCAS, with WonW and weight on the nosewheel. If both probes are outside this range for longer than 0.125 seconds, AOA special logic (fixed gains) is engaged. After transitioning to weight off wheels, there is an additional monitor that compares the average corrected AOA values from the probes to an estimated AOA value derived from pitch and flightpath angles. If average corrected AOA value from the probes differs by 6° or more from the estimated AOA value within the first 8 seconds after takeoff, the AOA special logic is engaged. The AOA special logic provides the control system a fixed AOA gain for a nominal takeoff. Aircraft takeoff-characteristics are nominal, with a slight nose-down tendency. The special logic is annunciated to the pilot in the form of an AOA caution which is set for a period of 12 seconds after the transition to weight off wheels. During the 12 second period the flaps are commanded to FULL regardless of the FLAP switch position. At the end of the 12 seconds the flaps will move to a position coincident with the FLAP switch position, and a FCS caution is set along with a four-channel AOA X-out. This four-channel AOA X-out condition can not be reset in flight. Execute the AOA Four Channel Failure corrective action procedure.

15.20 AILERON HINGE FAILURE - SUSPECTED, INBOARD.

Inboard aileron hinge failure may be suspected if a sudden uncommanded roll-off appears with no corresponding aural "Flight Controls, Flight Controls" alert or associated FCS Xs or BLIN codes. If the hinge has failed, the affected aileron will not respond normally to commanded inputs. However, the aileron position indicator on the FCS page will function normally since the affected aileron actuator is operating properly. In this case, the aileron position indicator on the FCS page will be indicating the position of the actuator rod and not the aileron surface. The only true indication of this failure is a visual check of the suspected aileron to determine if it is responding to control inputs.

For a failed hinge condition, the resultant flying qualities will be degraded but adequate for a shore-based landing. Aircraft response to normal control inputs will be fairly uncoordinated and roll performance away from the damaged aileron will be reduced. A failed inboard hinge may result in a condition where wing and aileron oscillations occur, immediately reduce airspeed by decelerating at 1g without using speedbrake until the oscillations subside.

NOTE

Do not use speedbrake to reduce airspeed. Ailerons contribute to the integrated speedbrake function and selecting speedbrake with a damaged aileron may cause roll transients.

If ship based, divert to an appropriate airfield. When determining the divert/BINGO profile, consider the presence of wing or aileron oscillations and their impact on divert airspeed and fuel management.



The presence of wing or aileron oscillations and the need to slow down until the oscillations subside may significantly impact the planned divert/BINGO profile.

Prior to landing, conduct a controllability check. During the controllability check, avoid selecting flaps - HALF or FULL. Selecting flaps - HALF or FULL will cause significant roll-off into the failed aileron. Because a hinge failure is undetected by the FCS, normal operation is assumed and aileron droop will be commanded when flaps HALF or FULL is selected. The damaged aileron is likely to remain undrooped and result in significant roll-off due to asymmetric aileron droop. For this case, large stick deflections are required to maintain wings level and significant trim inputs are necessary to reduce stick forces. Placing the flaps in HALF or FULL may also result in control surface binding if the damaged aileron interferes with the deflection of the trailing edge flaps (TEF).

Lateral weight asymmetries will aggravate the roll-off and may preclude the aircrew's ability to zero the roll-off with trim. Consideration should be given to jettisoning stores to reduce lateral weight asymmetries and to reduce gross weight for landing.

Execute a FLAPS-AUTO, straight-in approach (on-speed AOA, if controllable) to landing. Trim as required to reduce lateral stick forces. Crosscheck aircraft groundspeed to ensure that it is below safe tire speed limits and the maximum engagement speed for the arresting gear. If controllability is not in question, fuel may be dumped to reduce airspeed. However, controllability checks should be completed at the new (lighter) weight. The aircraft should then be re-trimmed on-speed for wings level and balanced (ball centered) flight. As the aircraft slows, it will require more directional trim to center the ball. Flying qualities should be adequate for a normal shore-based FLAPS-AUTO approach to landing. Handling characteristics may be degraded such that aircraft response to control stick or throttle inputs may be coupled in roll, pitch, and yaw. These transient aircraft motions may be annoying, but do not significantly degrade glideslope and line-up capture.

15.20.1 Suspected Inboard Aileron Hinge Failure Corrective Action.

If failed inboard aileron hinge suspected -

1. Reduce load factor to 1g.
2. Oppose roll-off with lateral stick, rudder or trim.

If aileron or wing oscillations are present -

3. Airspeed - IMMEDIATELY REDUCE UNTIL OSCILLATIONS SUBSIDE.
DO NOT USE SPEEDBRAKE TO REDUCE AIRSPEED.



If aileron or wing oscillations are present, failure to immediately reduce airspeed until oscillations cease can result in further structural failure.

If no aileron or wing oscillations are present -

3. Airspeed - MAINTAIN AS PRACTICAL

NOTE

Use of speedbrake with a damaged aileron will cause an immediate roll transient and should be avoided.

4. Use smooth, small control inputs.
5. Land as soon as practical.

If ship based -

6. DIVERT



Bingo profile may be adversely affected due to reduced airspeed necessary for given condition. Allow for a controllability check prior to landing.

For shore-based landing -

7. Perform controllability check with FLAPS AUTO at safe altitude. Trim as required.
8. Verify aircraft groundspeed is less than nose tire and arresting gear groundspeed limits.
9. Execute a straight-in approach with FLAPS AUTO.
10. Make a short field arrestment if situation permits.

CHAPTER 16

Landing Emergencies

16.1 SINGLE ENGINE FAILURE IN LANDING CONFIGURATION

At MIL power and below, the amount of yaw/roll caused by a single engine failure is minimal, and the aircraft is easily controllable. If an engine fails with both throttles at MAX power (e.g., waveoff), a significant amount of yaw/roll can be anticipated due to asymmetric thrust. In this case, timely rudder pedal inputs (up to FULL) are required. Too much rudder pedal is not harmful, but too little rudder pedal may cause controllability problems. Therefore, FULL rudder pedal to oppose yaw/roll is prudent. If lateral stick is also required to oppose roll (worst case), inputs should be limited to approximately $\frac{1}{2}$ displacement. Lateral stick inputs greater than $\frac{1}{2}$ throw may compromise directional controllability and result in excessive sideslip buildup. The demand on the rudders may be too great when trying to balance asymmetric thrust and coordinate the adverse yaw generated by the ailerons when opposing the tendency of the aircraft to roll into the failed engine. If the rudders are saturated (surfaces against the stops) and additional adverse yawing moment is generated, sideslip grows and an adverse yaw departure will result. During single engine operations, restricting lateral stick inputs to less than $\frac{1}{2}$ throw reduces the potential for an adverse yaw departure.

- *1. Throttles - MIL or MAX
- *2. FLAP switch - HALF
- *3. Maintain on-speed AOA and balanced flight.

WARNING

When single engine with the operating engine at MAX, the possibility of an adverse yaw departure increases as AOA exceeds on-speed.

- 4. Refer to Single Engine Approach and Landing.

16.2 SINGLE ENGINE APPROACH AND LANDING

During a single engine approach and landing, use of the afterburner on the operating engine is not restricted as long as on-speed AOA is maintained.

WARNING

When single engine with the operating engine at MAX, the possibility of an adverse yaw departure increases as AOA exceeds on-speed.

GENERAL CONSIDERATIONS -

- 1. Reduce gross weight (44,000 lb max, lower if practical).
- 2. Maintain operating engine above 80 % RPM during flap and landing gear extension.

3. Consider crossbleed to provide HYD 2 pressure to extend the landing gear normally and to preserve APU accumulator pressure for emergency braking and emergency nosewheel steering.



- Do not crossbleed if engine and/or AMAD related damage is suspected.
 - Extended crossbleeding of a failed engine traps feed tank fuel on that side if the FIRE light has not been pushed, and may result in a flameout.
 - ATS exhaust may blister paint and cause possible door damage on the aft underside of the fuselage.
 - Starting the APU airborne may result in a BALD shutdown due to ingestion of exhaust gases into the APU ducting.
4. Fly a straight-in approach.
 5. Plan approach to make turns using shallow bank angle ($\leq 15^\circ$)
 6. Do not exceed on-speed AOA in turns.
 7. Avoid turns into inoperative engine.

LEFT ENGINE FAILED -

1. FLAP switch - HALF
2. LDG GEAR handle - DN
3. Make a normal landing or a precautionary short field arrested landing (if practical).

RIGHT ENGINE FAILED -

1. FLAP switch - HALF
2. Execute Landing Gear Emergency Extension procedure.

If short field arresting gear available -

3. Make an arrested landing.

If short field arresting gear NOT available and right engine crossbleed NOT desired/required -

3. EMERG BRK handle - VERIFY PULLED TO DETENT (anti-skid is not available)
4. Make a normal landing.
5. Consider paddle switch - PRESS after touchdown to preserve APU ACCUM pressure for braking and slow-speed NWS.
6. Use emergency brakes with steady brake pressure (Do Not Pump). Anti-skid is not available.

Once stopped on runway -

7. Do not taxi (even if HYD 2A caution is removed).

If short field arresting gear NOT available and right engine crossbleed IS desired/required -**If APU ACCUM caution light on (i.e., landing gear emergency extended) -**

3. Recharge the APU accumulator.
 - a. Left throttle - ADVANCE to 80 % rpm minimum
 - b. ENG CRANK switch - R

When HYD 2 pressure restored -

- c. HYD ISOL switch - ORIDE (until 10 seconds after APU ACCUM caution removed - approximately 30 seconds total)
- d. ENG CRANK switch - OFF

With APU ACCUM caution off -

4. APU switch - ON (READY light on within 30 seconds)
5. ENG CRANK switch - R

When HYD 2 pressure restored -

6. HYD ISOL switch - ORIDE (until 10 seconds after APU ACCUM caution removed - approximately 40 seconds total)
7. EMERG BRK handle - VERIFY RESET
8. Make a normal landing using normal brakes with antiskid.

Once stopped on runway -

9. Do not taxi (even if HYD 2A caution is removed).

16.3 SINGLE ENGINE WAVEOFF/BOLTER

During a single engine waveoff or bolter, use of the afterburner on the operating engine is not restricted as long as on-speed AOA is maintained. Best single engine rate of climb occurs at or near on-speed AOA regardless of configuration, lateral weight asymmetry, or gross weight. If MAX power is used, pilot workload is higher due to higher asymmetric thrust effects. Up to full rudder pedal may be required to oppose yaw/roll. If required, coordinated lateral stick should be used to maintain wings level.

1. Throttles - MIL (MAX if required)
2. Maintain on-speed AOA and balanced flight.

3. Climb, then accelerate to a safe altitude/airspeed.

16.4 FORCED LANDING

The aircraft is not designed to land on an unprepared surface. If a suitable landing site is not available, perform a controlled ejection.

16.5 LANDING GEAR UNSAFE/FAILS TO EXTEND

A landing gear position of three down and locked is indicated by three steady green position lights in either cockpit with the landing gear warning light and warning tone out. See figure 16-1.

If the LEFT or RIGHT landing gear position indicator is flashing, and the landing gear warning light and warning tone are on, refer to PLANING LINK FAILURE.

If the landing gear warning light and warning tone are out -

1. AOA indexer lights - CONFIRM ON
2. INTR LT MODE switch - CHECK DAY
3. Landing gear position lights - CHECK FLUSH
4. LT TEST switch - TEST

If bulb(s) test bad -

5. It is safe to assume the landing gear is down and locked.
6. Get a visual inspection (if practical).
 - The approach lights should be illuminated if the landing gear is down and locked.
7. Landing gear may be raised as necessary to conserve fuel.
8. Make a normal landing.

If the landing gear warning light and warning tone are on -

1. AOA indexer lights - CONFIRM OUT
2. LT TEST switch - TEST
 - Verify that all 3 position lights and the landing gear warning light are on.
3. LDG GEAR handle - CHECK FULL DN (DO NOT CYCLE)
4. LG circuit breaker - CHECK IN
5. Get a visual inspection (if practical).
 - If one or more landing gear indicates unsafe, a visual inspection can only confirm general position and obvious damage.
 - There is no external indication of a locked landing gear.

Perform the following in order until 3 down and locked -

6. LG circuit breaker - CYCLE
7. Perform Landing Gear Emergency Extension Procedure.
8. Perform positive and negative g maneuvers and gently roll and yaw aircraft to obtain safe gear indication.

If HYD 2A is operative and any gear still unsafe -

9. LDG GEAR handle - PUSH IN then ROTATE 90° CCW
10. LDG GEAR handle - UP (DOWNLOCK ORIDE if required)
11. If all gear up and locked, consider selective jettison of unwanted stores.
 - Selective jettison can only be performed with LDG GEAR handle UP and all landing gear up and locked.
12. LDG GEAR handle - DN
13. Perform Landing Gear Emergency Extension procedure.
14. Perform positive and negative g maneuvers and gently roll and yaw aircraft to attempt to drive the unsafe gear down and locked.

If any gear still indicates unsafe -

15. Refer to Landing Gear Malfunction - Landing Guide chart.

If at any time landing gear indicates three down and locked -

16. LDG GEAR handle - DO NOT CYCLE
17. Make minimum sink rate short field arrested landing (if available).
18. Pin the landing gear after landing.

16.6 LANDING GEAR EMERGENCY EXTENSION

1. Consider selective jettison of unwanted stores.
 - Selective jettison can only be performed with LDG GEAR handle UP and all landing gear up and locked.
2. FLAP switch - HALF or FULL
3. Slow below 170 KCAS.
4. LDG GEAR handle - DN

If LDG GEAR handle cannot be moved to the DN position -

5. LG circuit breaker - PULL

With LDG GEAR handle DN or UP (DN preferred) -

6. LDG GEAR handle - ROTATE 90° CLOCKWISE then PULL TO DETENT
7. Verify three down and locked.
8. Make a short field arrestment (if practical)

NOTE

If the landing gear was emergency extended with the LDG GEAR handle in the UP position, the landing gear warning light remains on with the gear down and locked.

9. EMERG BRK handle - PULL TO DETENT (Anti-skid is not available)



If the forward pressure reducer valve is failed, normal gear extension and normal braking will be inoperative. If emergency gear extension was required to achieve three down and locked with a good HYD 2A system, emergency brakes should be selected prior to landing. If the landing gear was emergency extended with a good HYD 2A system, emergency brakes should be selected, as failure of normal braking is anticipated.

If HYD 2B is operative -

10. HYD ISOL switch - ORIDE (until 10 seconds after APU ACCUM caution removed - approximately 30 seconds total)

NOTES

- C.G. AT 25% MAC.
- INCREASE MAX WEIGHT BY 175 LBS FOR EACH 1% THE C.G. IS AFT OF 25% MAC.
- DECREASE MAX WEIGHT BY 175 LBS FOR EACH 1% THE C.G. IS FWD OF 25% MAC.
- GREATER WOD PROVIDES IMPROVED WAVEOFF PERFORMANCE.
- ADJUSTING GROSS WEIGHT AT OR BELOW THE RECOMMENDED WEIGHT ENSURES LESS THAN 50 FEET ALTITUDE LOST DURING AN ON-SPEED AOA SINGLE ENGINE MILITARY POWER WAVEOFF FROM AN ON-SPEED AOA/ON GLIDE SLOPE CONDITION. MAXIMUM ALTITUDE LOST FOR TWO ENGINE OPERATION UNDER IDENTICAL CONDITIONS IS LESS THAN 35 FEET.

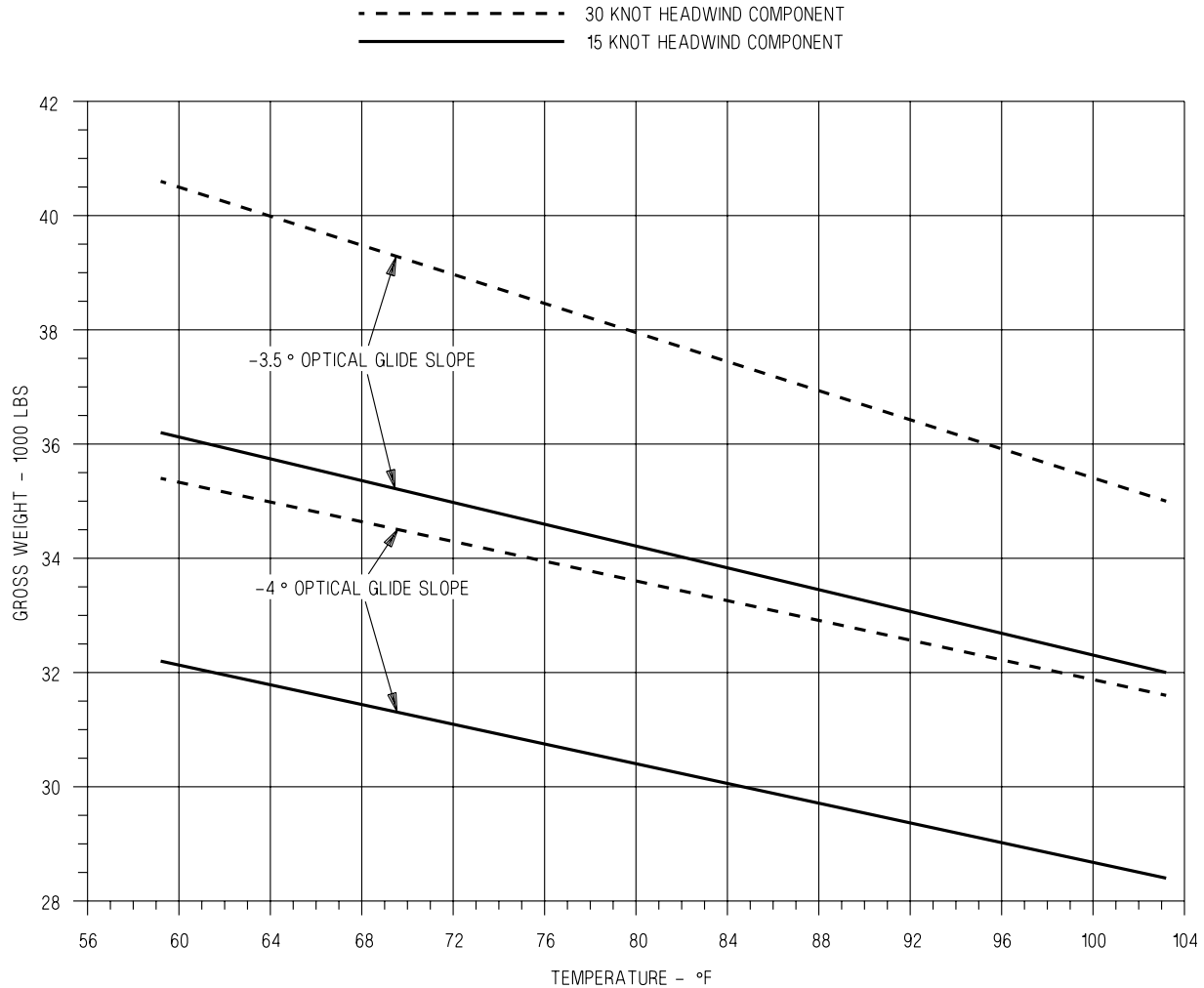

Figure 16-1. Maximum Single Engine Recovery Weight - Military Thrust

EFN520-419-1-015

NOTES

- C.G. AT 25% MAC.
- INCREASE MAX WEIGHT BY 222 LBS FOR EACH 1% THE C.G. IS AFT OF 25% MAC.
- DECREASE MAX WEIGHT BY 222 LBS FOR EACH 1% THE C.G. IS FWD OF 25% MAC.
- GREATER WOD PROVIDES IMPROVED WAVEOFF PERFORMANCE.
- ADJUSTING GROSS WEIGHT AT OR BELOW THE RECOMMENDED WEIGHT ENSURES LESS THAN 50 FEET ALTITUDE LOST DURING AN ON-SPEED AOA SINGLE ENGINE MAXIMUM POWER WAVEOFF FROM AN ON-SPEED AOA/ON GLIDE SLOPE CONDITION. MAXIMUM ALTITUDE LOST FOR TWO ENGINE OPERATION UNDER IDENTICAL CONDITIONS IS LESS THAN 40 FEET.

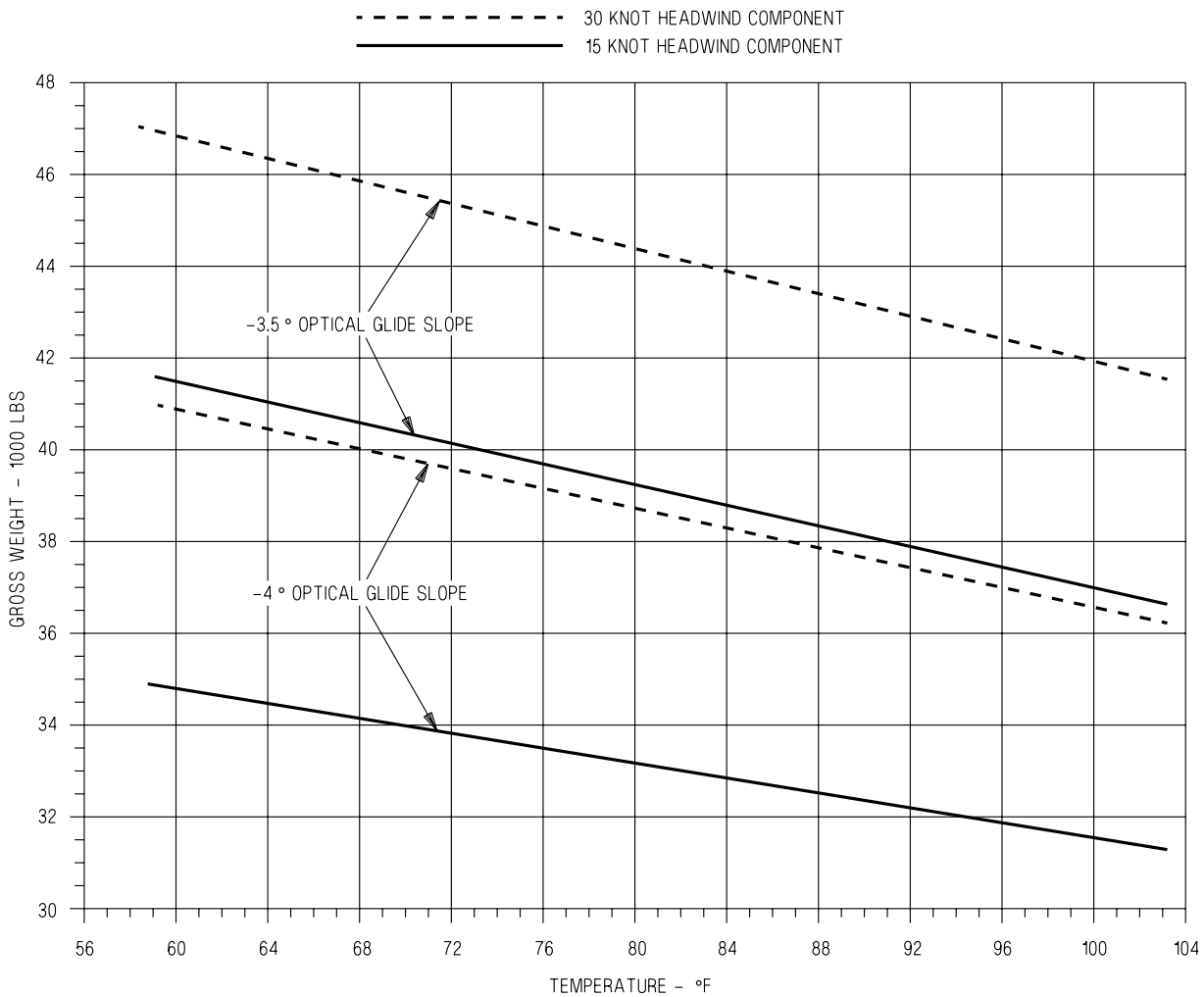

Figure 16-2. Maximum Single Engine Recovery Weight - Maximum Thrust

EFN520-419-2-015

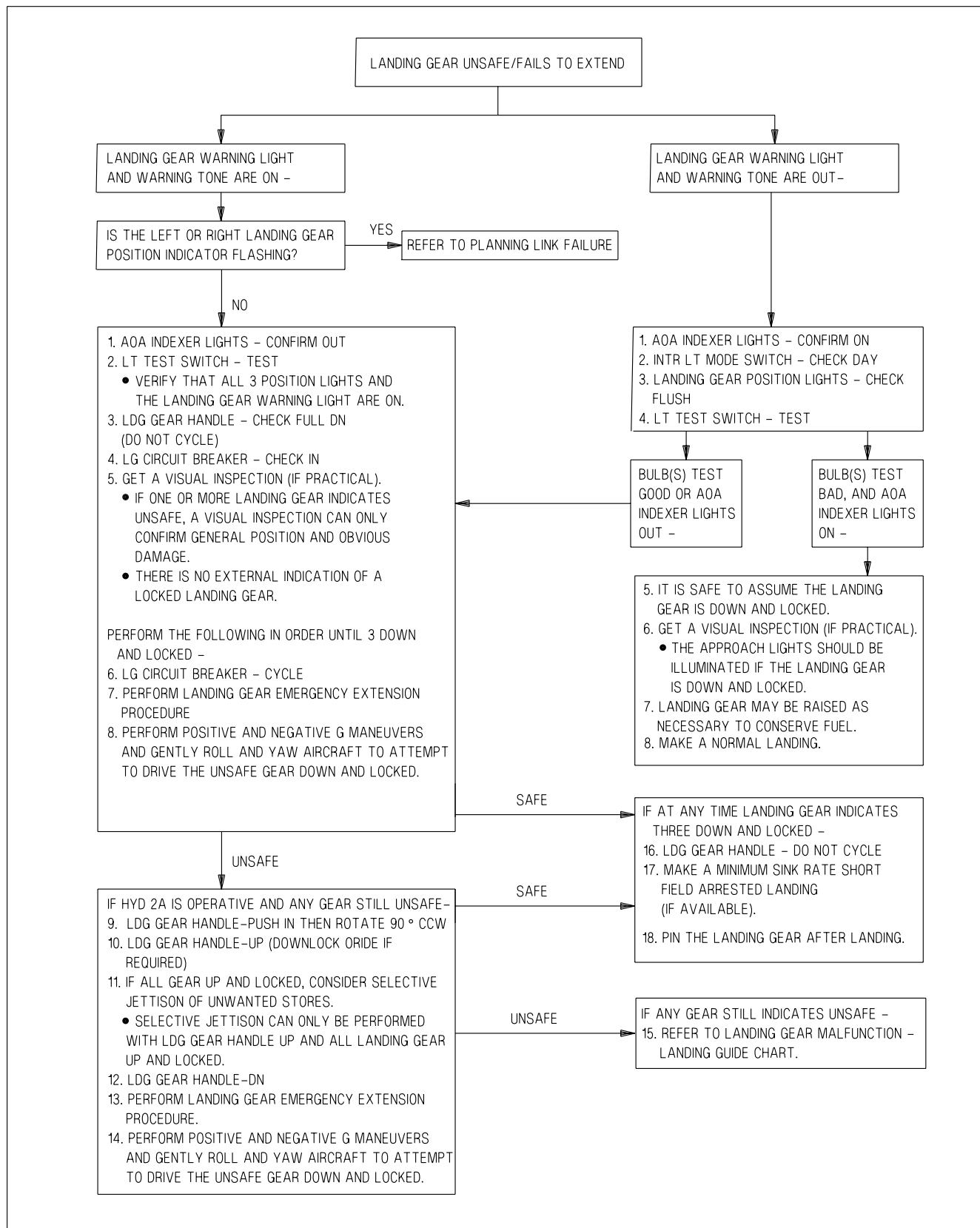

Figure 16-3. Landing Gear Emergency Flow Chart

EFN520-416-1-015

CARRIER LANDING

- ANY GEAR NOT LOCKED DOWN SHALL BE TREATED AS THOUGH IT WERE UP.
- IF ALL GEAR UNLOCKED, RETRACT GEAR AND REFER TO ALL GEAR UP.

- WITH PLANING LINK FAILURE, DO NOT CYCLE GEAR.
- OBTAIN VISUAL INSPECTION FOR ALL LANDING GEAR EMERGENCIES IF POSSIBLE.

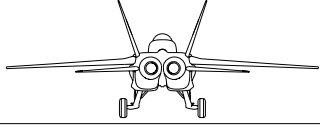
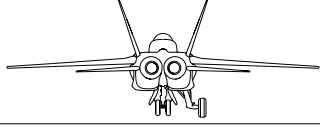
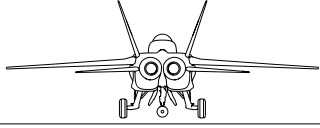
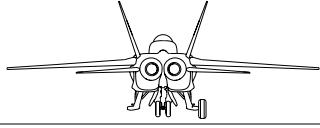
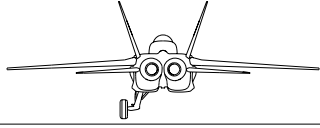
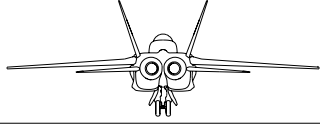
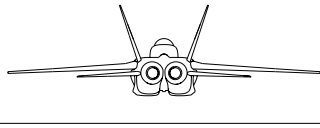
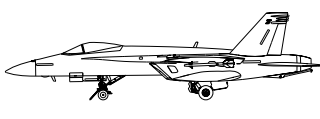
LANDING GEAR CONFIGURATION		ACTION	NOTES
	NOSE GEAR RETRACTED STUB OR TRAILING	DIVERT OR BARRICADE	1,2,3
	ONE MAIN GEAR RETRACTED OR TRAILING	DIVERT OR BARRICADE	1,2,4
	COCKED NOSE GEAR AND/OR ONE OR BOTH COCKED MAIN GEAR	NORMAL LANDING	2
	ONE OR BOTH MAIN GEAR STUB	DIVERT OR BARRICADE	1,2,3
	NOSE GEAR AND ONE MAIN GEAR RETRACTED OR TRAILING	RETRACT ALL GEAR. IF UNABLE TO RETRACT, EJECT.	
	BOTH MAIN GEAR RETRACTED OR TRAILING	DIVERT OR BARRICADE	1,2,4
	ALL GEAR UP	DIVERT OR BARRICADE WITH TANKS INSTALLED ONLY OR EJECT.	1,2,4
	LAUNCH BAR DOWN OR RED LAUNCH BAR LIGHT ILLUMINATED	DIVERT OR REMOVE CDP'S 1 AND 4 AND MAKE NORMAL LANDING.	

NOTES

1. JETTISON ALL EXTERNAL ORDNANCE.
2. RETAIN AND DEPRESSURIZE EMPTY EXTERNAL FUEL TANKS.
3. HOOK DOWN BARRICADE ENGAGEMENT WITHOUT CROSS DECK PENDANTS.
4. HOOK DOWN BARRICADE ENGAGEMENT WITH CROSS DECK PENDANTS.

EFN520-126-1-001

Figure 16-4. Landing Gear Malfunction – Landing Guide (Sheet 1 of 2)

FIELD LANDING

- ANY GEAR NOT LOCKED DOWN SHALL BE TREATED AS THOUGH IT WERE UP.
- IF ALL GEAR UNLOCKED, RETRACT GEAR AND REFER TO ALL GEAR UP.

- WITH PLANING LINK FAILURE, DO NOT CYCLE GEAR, MAKE FLY-IN ARRESTMENT.
- OBTAIN VISUAL INSPECTION FOR ALL LANDING GEAR EMERGENCIES IF POSSIBLE.
- FOR ALL EMERGENCIES, REQUEST LSO ASSISTANCE IF AVAILABLE.

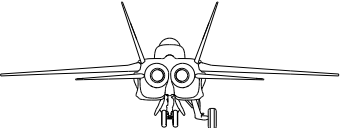
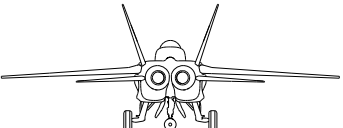
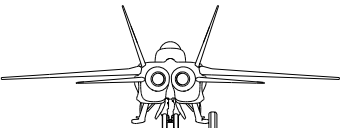
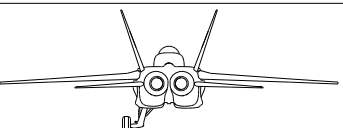
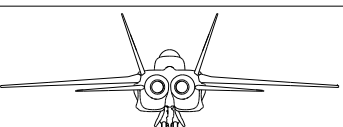
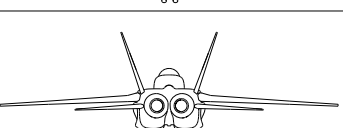
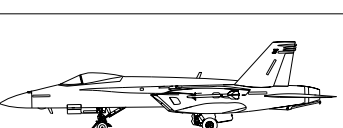
LANDING GEAR CONFIGURATION		ARRESTING GEAR		NO ARRESTING GEAR	
		ACTION	NOTES	ACTION	NOTES
	NOSE GEAR RETRACTED STUB OR TRAILING	NO ARRESTED LANDING REMOVE CDP	1,2,3, 4,5	LAND	1,2,3, 4,5
	ONE MAIN GEAR RETRACTED OR TRAILING	MAKE ARRESTED LANDING	1,2,3, 6	LAND	1,2,3, 7,8,9, 10
	COCKED NOSE GEAR AND/OR ONE OR BOTH COCKED MAIN GEAR	MAKE ARRESTED LANDING	2	LAND	2
	ONE OR BOTH MAIN GEAR STUB	NO ARRESTED LANDING REMOVE CDP	1,2,3, 7,8,9, 10	LAND	1,2,3, 7,8,9, 10
	NOSE GEAR AND ONE MAIN GEAR RETRACTED OR TRAILING	RETRACT ALL GEAR. IF UNABLE TO RETRACT, EJECT		RETRACT ALL GEAR. IF UNABLE TO RETRACT, EJECT	
	BOTH MAIN GEAR RETRACTED OR TRAILING	MAKE ARRESTED LANDING	1,2,5, 9	LAND	1,2,5, 9
	ALL GEAR UP	NO ARRESTED LANDING REMOVE CDP	1,2,5, 9	LAND	1,2,5, 9
	LAUNCH BAR DOWN OR RED LAUNCH BAR LIGHT ILLUMINATED	NO ARRESTED LANDING REMOVE CDP		LAND	

NOTES

1. JETTISON ALL EXTERNAL ORDNANCE.
2. RETAIN AND DEPRESSURIZE EMPTY EXTERNAL FUEL TANKS.
3. MINIMUM DESCENT RATE LANDING.
4. LOWER NOSE GENTLY BEFORE FALL THROUGH.
5. SECURE ENGINES IF ANY GEAR RETRACTED OR COLLAPSES ON TOUCHDOWN.
6. HOLD MISSING DAMAGED GEAR OFF DECK UNTIL ENGAGEMENT.
7. ANTI-SKID OFF.
8. LAND ON SIDE OF RUNWAY TOWARD GOOD GEAR.
9. HOLD WINGS LEVEL AS LONG AS POSSIBLE.
10. USE NOSEWHEEL STEERING AND GOOD BRAKE TO MAINTAIN TRACK.

Figure 16-4. Landing Gear Malfunction – Landing Guide (Sheet 2 of 2)

16.7 PLANING LINK FAILURE

With the landing gear down and locked, a planing link failure is indicated by a flashing LEFT or RIGHT landing gear position light, illumination of the landing gear warning light, and annunciation of the landing gear warning tone.

WARNING

- A planing link failure may cause a sudden swerve on touchdown in the direction of the failed gear.
- Planing link failure may not be annunciated until after touchdown, providing the pilot with little to no reaction time between initial annunciation and a violent yaw/swerve. If flyaway airspeed is available, pilots should be prepared to make the decision to execute the Go Around procedure immediately at initial planing link failure annunciation.

CAUTION

Planing link failure indications that are momentary or disappear after initial activation may be indicative of an actual planing link failure.

If detected after touchdown and flyaway airspeed available -

- *1. Go Around

If flyaway airspeed not available -

- *1. Select emergency brakes (if appropriate).
- *2. HOOK handle - DOWN (if required)

If detected airborne, or following go around -

1. LDG GEAR handle - DO NOT CYCLE
2. ANTI SKID switch - OFF

If arresting gear available -

3. Make a fly-in short field arrestment with LSO assistance (if available).

If arresting gear not available -

3. Make a minimum sink rate landing.
4. Consider touchdown on good gear side of runway.

5. Avoid braking until as slow as practical or until needed to prevent loss of directional control.
6. Brake using the good gear and maintain directional control with NWS.
7. Use symmetrical braking only if necessary to avoid departing the runway.

WARNING

- Use of symmetrical wheel brakes with a planing link failure may cause a sudden swerve in the direction of the failed gear.
 - The ability to maintain directional control with braking on the appropriate side, NWS, and rudder will rapidly decrease as the aircraft decelerates on rollout.
 - Lateral asymmetry on the failed side may aggravate severity of yaw/swerve in the direction of failed gear.
8. Do not taxi once stopped.

16.8 ARRESTMENT - FIELD

Maximum engaging speeds, gross weights, and off-center distances are listed in the Field Arresting Gear Data charts, figure 16-5.

16.8.1 Arresting Gear Types. Field arresting gear includes anchor chain, water squeezer, and Morest types. All types require arresting hook engagement with a crossdeck pendant cable rigged across the runway. Arresting gear location varies as follows:

- **SHORT FIELD** - Located 1,500 to 2,000 feet past the approach end of the runway. May require a request and slight delay to rig.
- **MIDFIELD** - Located near the halfway point of the runway. May require a request to rig for the desired direction.
- **LONG FIELD** or **ABORT** - Located 1,500 to 2,000 feet short of the departure end of the runway. Usually rigged for immediate use.
- **OVERRUN** - Located shortly past the departure end of runway. Usually rigged for immediate use.

A field may have none, all, or any combination of these arresting gear types. Knowing the type, location, and compatibility with the aircraft of the installed gear is mandatory. Knowing the local policy for rigging installed gear is also required.

CAUTION

Wrong direction engagement of chain-type arresting gear can severely damage the aircraft.

16.8.2 Arrestment Decision. The decision to take an arrested landing is dependent on the emergency situation. In an emergency, use all available means to determine the status of the aircraft (instruments, other aircraft, LSO, RDO, tower or other ground personnel). Typically, emergencies related to the loss of the utility hydraulic system (e.g., loss of normal brakes and NWS), or to questionable braking, or directional control (e.g., planing link failure, blown tire, or brake problem) dictate making an arrested landing. If in doubt, a precautionary arrested landing is always prudent. If fuel is streaming, a field arrested landing is not recommended due to the high probability that sparks and heat from the hook may ignite the fuel.

Once the decision to arrest has been made, determine the best available arresting gear type and location. Notify the control tower as far in advance as possible and give estimated time to landing in minutes. Unrigged gear may require 10 to 20 minutes to rig. If winds are light and the emergency situation dictates, the tower may request an arrested landing on an off-duty runway to retain the capability to launch and recover other aircraft. If unfamiliar with arresting gear location, consider making a practice pass.

Engage arresting gear on runway centerline, in the three-point attitude, as slow as practical, and with feet off the brakes until engagement. After arrestment, common sense and conditions determine whether to keep engines running or to shut down the engines and evacuate the aircraft.

16.8.3 Arrestment - Short Field. Make a short field arrested landing for anticipated directional control or brake problems or if minimum rollout is desired. If available, request LSO assistance. The LSO should have radio communications and be stationed near the touchdown point.

Inform the LSO of the intended touchdown point, if other than immediately before the gear. Lower the hook before starting the approach and, if possible, get a positive hook down check.

Determine maximum engagement speed at the expected landing gross weight (see figure 16-5). Final approach speed depends on flap setting and the specific emergency. If required, adjust gross weight to minimize approach speed. A constant glideslope approach to touchdown is allowed (mirror or fresnel lens if available). Plan the approach to touchdown on centerline at or just before the arresting wire. If the required approach speed is in excess of maximum engaging speed, land short, select IDLE power, and decelerate into the gear. Be prepared for nose gear tire failure above 195 KGS or main gear tire failure above 210 KGS. Plan for a long field arrestment, if maximum short field engaging speed cannot be met. If landing at or below maximum engaging speed, maintain approach power until arrestment is assured. After engagement, retard the throttles to IDLE. Use moderate braking, if available, during deceleration to prevent aircraft from two-blocking the arresting gear at higher engagement speeds or gross weights. Secure engines and evacuate the aircraft, if required. If the wire is missed, waveoff immediately.

16.8.4 Arrestment - Long Field. Make a long field arrestment when there is a stopping problem (e.g., aborted takeoff or loss of brakes with no loss of directional control, etc.). If possible, go around and make a short field arrestment. Lower the hook in time for it to fully extend before engagement (normally 1,000 feet prior to the arresting gear). Line up on runway centerline. If possible, inform the control tower of intention to engage the long field gear, so that aircraft landing behind can be waved off. Do not delay a decision to go around based solely on the availability of long field gear.

16.9 BARRICADE ARRESTMENT

If a barricade arrestment is required, the LSOs will give a detailed briefing of barricade procedures.

1. Burn down or dump fuel as required to obtain the lowest gross weight feasible.

2. External ordnance - JETTISON
3. External fuel tanks - JETTISON EXCEPT AS NOTED IN LANDING GEAR MALFUNCTION
- LANDING GUIDE - CARRIER LANDING

NOTE

Barricade engagement with installed AIM-7, AIM-120 and/or AIM-9 missiles is not recommended. AIM-7 and AIM-120 missiles may separate and AIM-9 missiles will probably separate from the aircraft. Inability to jettison/fire these missiles does not preclude successful barricade engagement. Barricade may be engaged with empty external tanks if tanks cannot be jettisoned. When live ordnance cannot be jettisoned, barricade engagement should only be attempted with all landing gear down.

4. Fly an on-speed, on-glideslope, on-centerline approach with zero drift all the way to touchdown.

When "Cut-Cut" called by LSOs -

5. Throttles - OFF

When aircraft motion ceases -

6. Egress.

16.10 CV RECOVERY MATRIX

See figure 16-6 for the CV recovery matrix.

TYPE OF ARRESTING GEAR	AIRCRAFT GROSS WEIGHT (x 1,000 POUNDS)								MAXIMUM OFF-CENTER ENGAGE- MENT (FEET)
	LANDING					ABORTED TAKEOFF (3)			
	31.5	35	40	45	50.6	55	60	66	
	MAXIMUM ENGAGING SPEED (Knots Groundspeed) (1)								
E-28 (2)	170	170	170	170	170	156	138	130	40
M-21	150	150	145	140	130	125	120	115	10
M-31	158	158	158	120	120	150	150	150	10
BAK-9	160	160	160	160	158	148	138	128	30
BAK-12 (4)	160	160	160	160	150	132	(4)	(4)	50
DUAL BAK-12 (5)	160	160	160	160	160	160	160	160	30
BAK-13	160	160	160	160	160	156	138	130	40

NOTE

- (1) Maximum engaging speed limited by arresting gear capacity, except where noted.
- (2) Also for the E-28 systems at Keflavik and Bermuda (standard installations or with 920 foot tapes).
- (3) Data provided in aborted takeoff column may be used for emergency high gross weight arrestment.
- (4) Standard BAK-12 limits are based on 150 foot span, 1 inch cross deck pendant, 40,000 pound weight setting, and 950 foot runout. No information available regarding applicability to other configurations. BAK-12 engaging speed limit is 96 knots at 59,000 pounds. Due to runout limitations, it is recommended this gear not be engaged at weights greater than 59,000 pounds.
- (5) Dual BAK-12 limits are based on 150 to 300 foot span, 1-1/4 inch cross deck pendant, 50,000 pound weight setting, and 1,200 foot runout. No information available regarding applicability to other configurations.



For E-28 or BAK-13 arresting gear systems, two-blocking can occur at aircraft weights above 50,000 pounds and at engaging speeds above 130 knots. Moderate braking should be utilized during deceleration, if available, to aid in stopping the forward motion of the aircraft and prevent an aircraft with idle power from slowly pulling the gear to a two-block position. If a two-block occurs and aircraft travel reverses, engine thrust should be applied judiciously to minimize aircraft walkback. Brakes, if available, should not be utilized during aircraft walkback, as they may induce the aircraft to tip back onto the exhaust nozzles.

Figure 16-5. Field Arresting Gear Data (Sheet 1 of 2)

FOR E-5 CHAIN EMERGENCY ARRESTING GEAR												
ARRESTING GEAR RATING	LANDING or ABORTED TAKEOFF UP TO 44,000 LB				LANDING or ABORTED TAKEOFF UP TO 50,600 LB				ABORTED TAKEOFF 50,700 to 66,000 LB			
	STD Chain		Heavy Chain		STD Chain		Heavy Chain		STD Chain		Heavy Chain	
	E-5 E-5-2	E-5-1 E-5-3	E-5 E-5-2	E-5-1 E-5-3	E-5 E-5-2	E-5-1 E-5-3	E-5 E-5-2	E-5-1 E-5-3	E-5 E-5-2	E-5-1 E-5-3	E-5 E-5-2	E-5-1 E-5-3
FEET of CHAIN	MAXIMUM ENGAGING SPEED (Knots Groundspeed)											
300-349	43	43	44	44	40	40	41	41	35	35	36	36
350-399	50	50	51	51	46	46	48	48	40	40	42	42
400-449	56	56	59	59	53	53	55	55	46	46	49	49
450-499	63	63	67	67	59	59	63	63	51	51	55	55
500-549	69	69	76	76	65	65	71	71	57	57	62	62
550-599	76	76	84	84	71	71	78	78	63	63	69	69
600-649	82	82	92	92	77	77	86	86	68	68	76	76
650-699	88	88	101	101	83	83	94	94	74	74	83	83
700-749	95	95	109	109	89	89	102	102	79	79	90	90
750-799	101	101	118	118	95	95	110	110	85	85	97	97
800-849	107	107	127	127	101	101	119	119	91	91	104	104
850-899	114	114	136	136	107	107	127	127	96	96	112	112
900-949	120	120	145	145	114	114	135	135	102	102	119	119
950-999	127	127	150	154	120	120	144	144	108	108	127	127
1000-1049	133	133	150	163	126	126	150	153	113	113	134	134
1050-1099	139	139	150	165	132	132	150	161	119	119	142	142
1100	146	146	150	165	138	138	150	165	125	125	149	149

NOTE

- Maximum engaging speed for E-5 chain gear is limited by arresting gear capacity.
- Off center engagement into an E-5 system must not exceed 25 % of the runway span.
- Before making an E-5 arrestment, confirm the type and chain length of installed gear (tower or FLIP IFR Supplement) to ensure the corresponding maximum engaging speed is not exceeded.

Figure 16-5. Field Arresting Gear Data (Sheet 2 of 2)

Malfunction	Pages NFM-000/-500	Divert	Pull Fwd	Next Avail	Normal	Notes
ENGINES						
Bleed Warning	V-12-3, -4/E56, E57		X			1, 2, 5
Engine Fire	V-12-4/E58		X			1, 2, 5
Single Engine	V-16-1/E30			X		2, 5, 9
Engine Stall	V-12-32/E101			X		2, 5, 9
AMAD PR Caution	V-12-7/E63			X		2,5
ATS Caution	V-12-9/E67			X		
Dual BLD OFF Cautions (both BLEED Warn Lights Out)	V-12-12/E70			X		11
BOOST LO Caution	V-12-13/E71			X		6
ENG Caution	V-12-17/E78			X		2, 5, 9
OIL PR Caution	V-12-29/E97			X		2, 5, 9
FUEL						
Fuselage Fuel Leak	V-15-4/E6		X			3
DUMP OPEN Caution	V-12-16/E76		X			3, 7
FUEL INLT Caution	V-12-20/E84		X			2, 5, 9
FUEL LO Caution	V-12-20/E84		X			3
FUEL HOT Caution	V-12-20/E83			X		
FUEL XFER Caution	V-12-21/E85			X		
THERMAL Caution	V-12-33/E102			X		2, 5, 9
HYDRAULIC						
Triple HYD Circuit Cautions	V-12-56/E140	X				2, 5
HYD 1A/2B Circuit Cautions	V-12-52/E134	X				2
All Other Dual HYD Circuit Cautions	V-12-50, -55/E132 - E139			X		2, 5, 9
Single HYD Circuit Caution	V-12-48,-49/E129 - E131			X		2, 5, 9
APU ACCUM Caution	V-12-8/E65			X		2
BRK ACCUM Caution	V-12-13/E72			X		2
HYD HOT Caution	V-12-63/E148			X		2, 5, 9
ELECTRICAL						
AV AIR HOT Caution	V-12-10/E68		X			
Dual GEN Cautions	V-12-22/V-15-11/E11, E86		X			2, 4, 5, 8, 11
Single GEN Caution	V-12-22/V-15-13, -14/E14, E15, E86			X		
Dual T/R Failure	V-15-12/E8			X		2, 5, 8, 11
DC FAIL Caution	V-12-15/E75			X		
CAUT DEGD Caution	V-12-14/E73			X		
FCS						
AHRS Four Channel Failure	V-12-37/E107	X				
FCS HOT Caution	V-12-42/E115		X			
AHRS 1/2 Channel Failure	V-12-36/E106			X		
FC AIR DAT Caution	V-12-41/E113			X		9
FCES Caution	V-12-35/E105			X		9
FLAPS OFF (LEF Fail) Caution	V-12-43/E116			X		9
FLAPS OFF (TEF Fail) Caution	V-12-44/E118			X		10
FLAP SCHED Caution	V-12-45/E120			X		9
Loss Of Any Control Surface	V-12-35/E105			X		9
MISCELLANEOUS						
BAY FIRE Caution	V-12-11/E69		X			
BAY DISCH Caution	V-12-10/E69			X		
Blown Tire	V-14-4/E19			X		2
L BAR Warning	V-12-6/E60			X		Remove CDP 1 and 4
Landing Gear Failure	V-16-9/E26			X		2, Refer to Figure 16-2. Landing Gear Malfunction - Landing Guide
Planing Link Failure	V-16-12/E16			X		2
OBOGS DEGD Caution	V-12-28/E96			X		
SDC Failure	I-2-22, I-2-171			X		
Birdstrike						12

NOTES:

- Aircraft will be flying a half flap straight-in. Approach speed will be higher, therefore wind over deck requirements will increase. Consult applicable ARB for details. Possibility of malfunction affecting other engine. Make sure all possible effort is made to recover aircraft immediately.
- Aircraft may require a tow out of the landing area.
- Immediate tanking required if any delay in recovery exists.
- Pilot will be unable to fold wings upon landing.
- For HYD 2A or Dual T/R failure, landing gear will be emergency extended and aircraft will be committed to a dirty bingo if unable to recover. Consider bingo options before extending landing gear.
- Problem could be symptomatic of a fuel leak. If so, immediate recovery is required.
- Approximately 4,400 pounds of fuel will be available in the engine feed tanks.
- If battery gauge reads 24 volts (LOT 22 and up), or BATT SW caution light on (LOT 21), the essential bus is being powered by the aircraft battery and 5 to 10 minutes of flight remains.
- Aircraft will be flying straight-in approach. If half-flap approach required, approach speed will be higher. Consult applicable ARB for WOD requirements.
- Aircraft will be flying 10° AOA full or half flap straight-in approach. Approach speed will be higher; therefore, wind over deck requirements will increase. Recovery WOD should be kept as close as possible to ARB recommendations.
- Unable to transfer external fuel. Consider divert or jettison of external tanks.
- Decision for Pull Fwd or Next Avail recovery determined by nature of damage sustained during birdstrike. Refer to appropriate emergency on recovery matrix.

Figure 16-6. CV Recovery Matrix

CHAPTER 17

Ejection

17.1 EJECTION

The ejection seat must be used to escape from the aircraft in flight. If the canopy fails to jettison during the ejection sequence, the seat will eject through the canopy.

17.1.1 Ejection Seat Restrictions. During ejection seat development and testing, the SJU-17(V) 1/A, 2/A, and 9/A NACES seats were qualified for use by aviators with nude weights from 136 to 213 pounds, while the SJU-17A (V)1/A, 2/A, and 9/A NACES seats were qualified for use by aviators with nude body weights from 136 to 245 pounds. The minimum and maximum nude body weights allowed by OPNAVINST 3710.7 Series for those on aviation duty are 100 pounds and 235 pounds, respectively. Therefore, a gap exists between the ejection seat certified weight range and the weights of the current aviator population.

WARNING

- Operation of the ejection seat by personnel weighing less than the qualified minimum nude weight, or more than the maximum qualified weight (noted above), subjects the occupant to increased risk of injury.
- An increased risk of severe injury or death during parachute landing fall (PLF) exists with surface winds exceeding 25 knots. High surface winds contribute directly to total landing velocity. When time permits, select parachute steering and turn into the wind to reduce landing velocity.
- Pilots should be trained in additional ejection risks associated with JHMCS. Ejection with JHMCS may cause severe or fatal injury.

The ejection seat catapult was designed for the qualified weight range only. Ejection seat stability is directly related to occupant restraint. All occupants should be properly restrained in the seat by the torso harness for optimum performance and minimum injury risk. Inertial reel performance may be degraded for occupants outside of the certified weight range

17.1.1.1 Injury Risks - Nude Weight Less than 136 Pounds. Lighter weight occupants are subject to a higher risk of injury due to the following factors:

1. Excessive pull back during inertial reel retraction.
2. Poor positioning during ejection.
3. Greater acceleration during catapult firing.
4. Higher parachute opening shock during ejections near the upper end of Mode 1 (approaching 300 KCAS).

5. Seat instability during drogue deployment during ejections above 300 KCAS.

WARNING

Lighter weight aircrew have greater risk of neck injury during ejection while using the JHMCS configuration. Minimum nude aircrew weights authorized to fly with the JHMCS helmet system is 136 pounds. Aircrew weighing less than the authorized minimum nude weight are restricted from flying with the JHMCS helmet system.

17.1.1.2 Injury Risks - Nude Weight Greater than 213 Pounds (245 Pounds for SJU-17A). Heavier weight occupants are subject to a higher risk of injury due to the following factors:

1. Poor positioning during ejection due to insufficient pull back during inertial reel retraction.
2. Insufficient altitude to clear the aircraft tail structure.
3. Insufficient altitude for full parachute inflation in zero/zero cases or at extremely low altitude/airspeed.
4. Higher descent rates during parachute landing.

17.1.1.3 Airspeed during Ejection. Ejection analysis shows:

1. Optimum speed for ejection is 250 KCAS and below.
2. Between 250 and 600 KCAS, appreciable forces are exerted on the body, making ejection more hazardous.
3. Above 600 KCAS, excessive forces are exerted on the body making ejection extremely hazardous.

When possible, slow the aircraft before ejection to reduce the forces on the body.

Never actuate the manual override handle in flight, as ejection would then be impossible and the aircrew would be unrestrained during landing. When the manual override handle is actuated, the ejection seat SAFE/ARMED handle is rotated to the SAFE position, the aircrew is released from the seat, and the harness cannot be reconnected.

WARNING

If the seat becomes unlocked and slides partially up the rails, ejection and/or parachute deployment is still possible but the ejection handle must be pulled, followed by activation of the manual override handle. Under these circumstances, low altitude ejection capabilities are compromised.

Whenever possible, ejection airspeed should be limited to a maximum of 400 KCAS when flying with the JHMCS helmet system.

WARNING

The JHMCS configuration can contribute to increased neck loads during ejection, particularly at moderate to high speeds. Generally, neck loads increase as ejection airspeed increases and may cause severe or fatal injury. Aircrews should eject at the lowest possible airspeed to minimize neck and injury loads.

NOTE

Aircrew will brief system peculiarities and potential injury from out of position and high speed ejections prior to each flight when using A/A24A-56 JHMCS lightweight HGU-55 A/P helmet.

17.1.2 Low Altitude Ejection. The minimum altitude required for a successful ejection is dependent on sink rate, airspeed and bank angle, and airspeed and dive angle. The effects of sink rate are shown in figure 17-1. The effects of airspeed and bank angle are shown in figure 17-2. The effects of airspeed and dive angle are shown in figure 17-3.

The decision to eject at low altitude must be based on these factors to ensure a successful ejection. Additionally, ejection seat trajectory is improved if the aircraft is zoomed to a higher altitude prior to ejection initiation. The additional altitude increases time available for seat separation and parachute deployment. However, do not delay the decision to eject if the aircraft is nose down and cannot be leveled.

With wings level and no sink rate, ejection is feasible within the following parameters:

1. Ground level - zero airspeed.
2. Surface to 50,000 feet MSL - 600 KCAS maximum.

Ejection at low altitude allows only a matter of seconds to prepare for landing. Over water, inflation of the LPU is the most important step to be accomplished. Release of the parachute quick-release fittings as the feet contact the water is the second most important step to prevent entanglement in the parachute shroud lines.

When ejection is in the immediate vicinity of the carrier, parachute entanglement combined with wake and associated turbulence can rapidly pull a survivor under. The deployed seat survival kit may contribute to shroud line entanglement. Be prepared to cut shroud lines if the parachute is dragging the survivor.

The crashed aircraft may release large quantities of jet fuel and fumes which could hamper breathing and/or create a fire hazard. If jet fuel is present, do not use a flare marker. The emergency oxygen

system may be invaluable in this case. If emergency oxygen is required, do not discard the survival kit, as this terminates the availability of emergency oxygen. However, totally discarding the survival kit may be appropriate after considering weather, sea conditions, and rescue potential.

WARNING

Low altitude ejection may result in parachute canopy disintegration due to the aircraft impact fireball.

The variety and complexity of conditions encountered during the “time critical” actions following a low altitude, overwater ejection make it impossible to formulate procedures to cover every contingency.

17.1.3 High Altitude Ejection. The basic low altitude procedure is applicable to high altitude ejection. The zoom is useful to slow the aircraft to a safer ejection speed or to provide more time and glide distance if immediate ejection is not necessary. If the aircraft is descending out of control, eject by 6,000 feet AGL. Even if under control, do not delay ejection below 2,000 feet AGL. Head the aircraft toward an unpopulated area, if possible.

17.1.4 Ejection Procedures. See figure 17-4.

17.2 DITCHING

In the event ejection has failed and the aircraft must be ditched, see figure 17-5.

17.3 SEAWATER ENTRY

If downed in seawater, SEAWARS releases the parachute canopy within 2 seconds. However, if able, manually unlock each canopy release immediately on seawater entry. The SEAWARS does not operate in freshwater.

SJU-17 (F/A-18E)

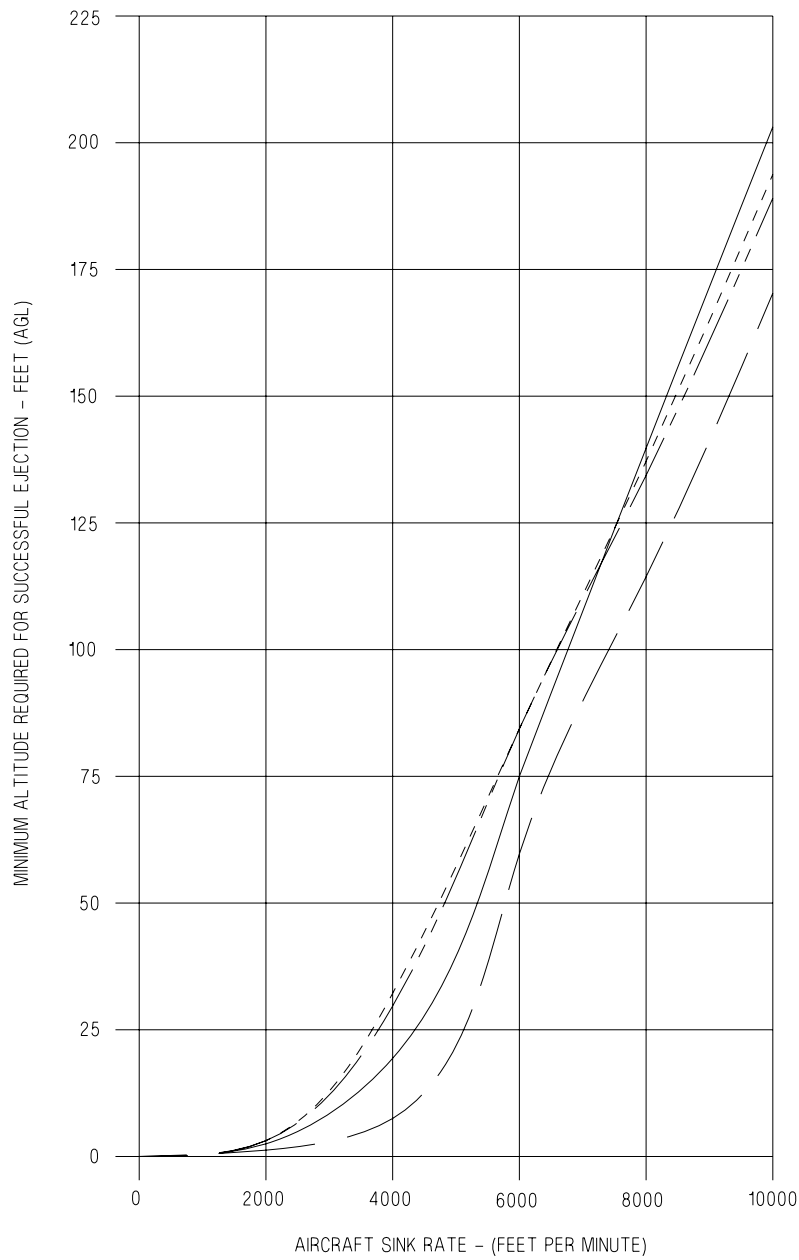

NOTES

- Minimum ejection heights are based on initiation of the escape system.
- Pilot reaction time is not included.
- Ejection altitude is below 5000 feet MSL.

LEGEND

- 130 KNOTS
- - - 250 KNOTS
- · - · 400 KNOTS
- · - · - 600 KNOTS

EFN520-216-1-001

Figure 17-1. Sink Rate Effects on Minimum Ejection Altitude (Sheet 1 of 2)

SJU-17 (F/A-18F)

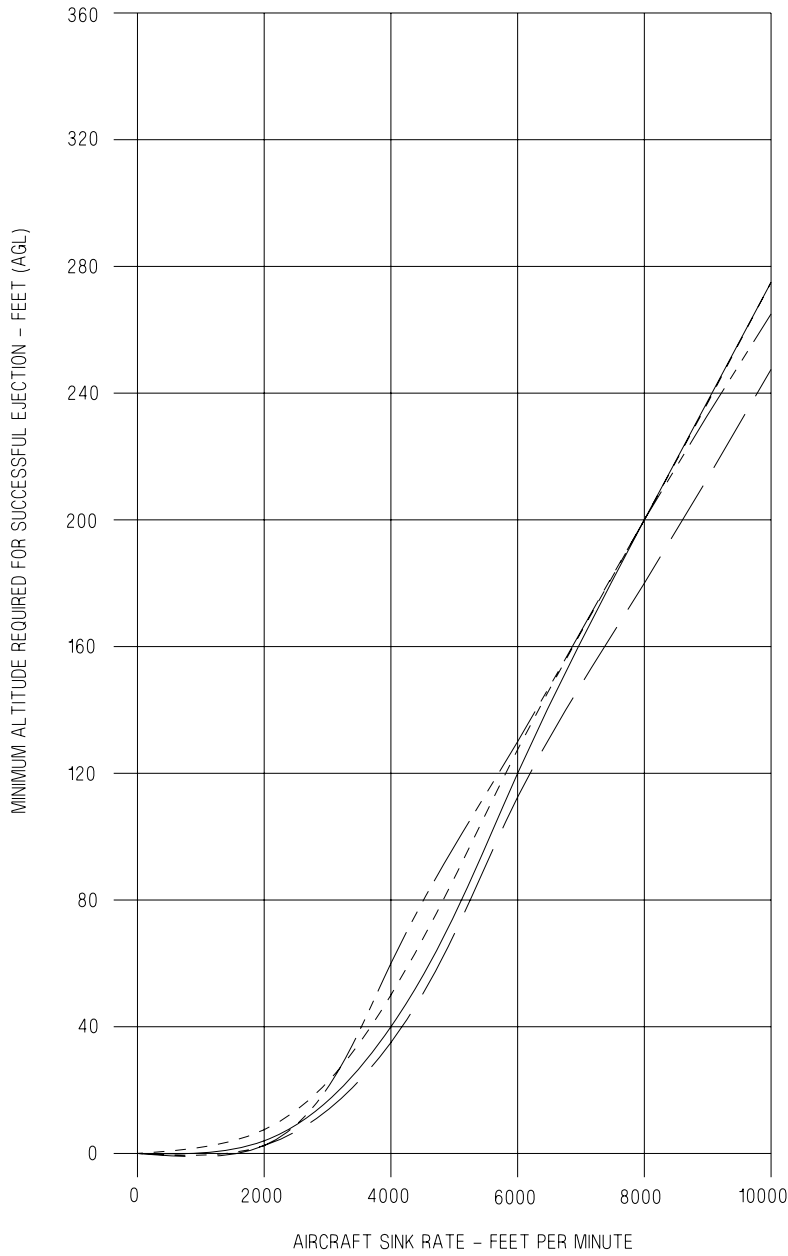

NOTES

- Minimum ejection heights are based on initiation of the escape system, and the time required for a complete dual sequenced ejection is included.
- Pilot reaction time is not included.
- Ejection altitude is below 5000 feet MSL.

LEGEND

- 130 KNOTS
- - - - - 250 KNOTS
- · - · - 400 KNOTS
- · - · - 600 KNOTS

EFN520-216-2-001

Figure 17-1. Sink Rate Effects on Minimum Ejection Altitude (Sheet 2 of 2)

SJU-17 AIRSPEED AND BANK ANGLE EFFECTS (F/A-18E)

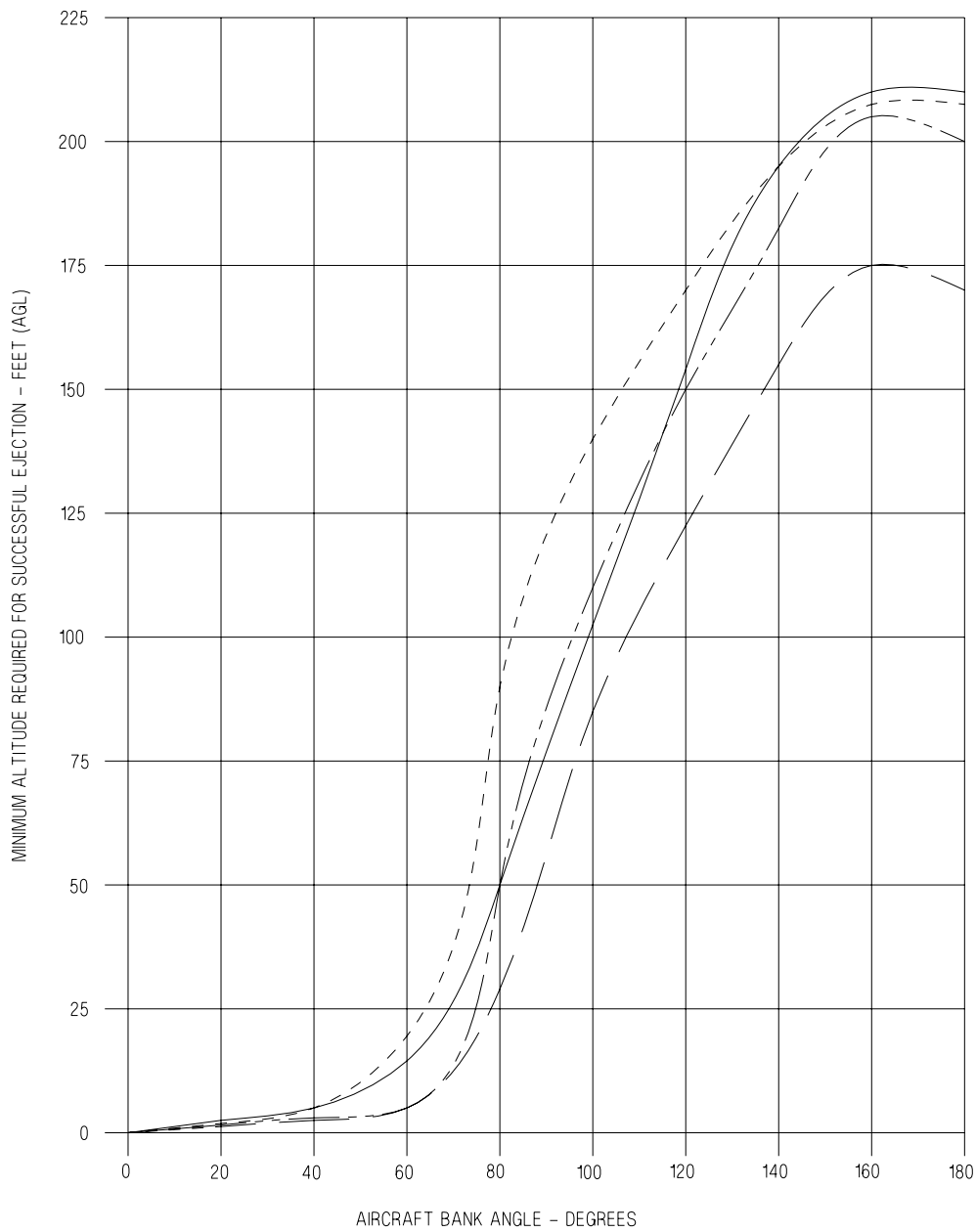

NOTES

- Minimum ejection heights are based on initiation of the escape system.
- Bank angle data is for coordinated flight. Yaw or slip will increase the height required for recovery.
- Pilot reaction time is not included.
- Ejection altitude is below 5000 feet MSL.

LEGEND

- 130 KNOTS
- 250 KNOTS
- 400 KNOTS
- 600 KNOTS

EFN520-215-1-001

Figure 17-2. Airspeed and Bank Angle Effects on Minimum Ejection Altitude (Sheet 1 of 2)

SJU-17 AIRSPEED AND BANK ANGLE EFFECTS (F/A-18F)

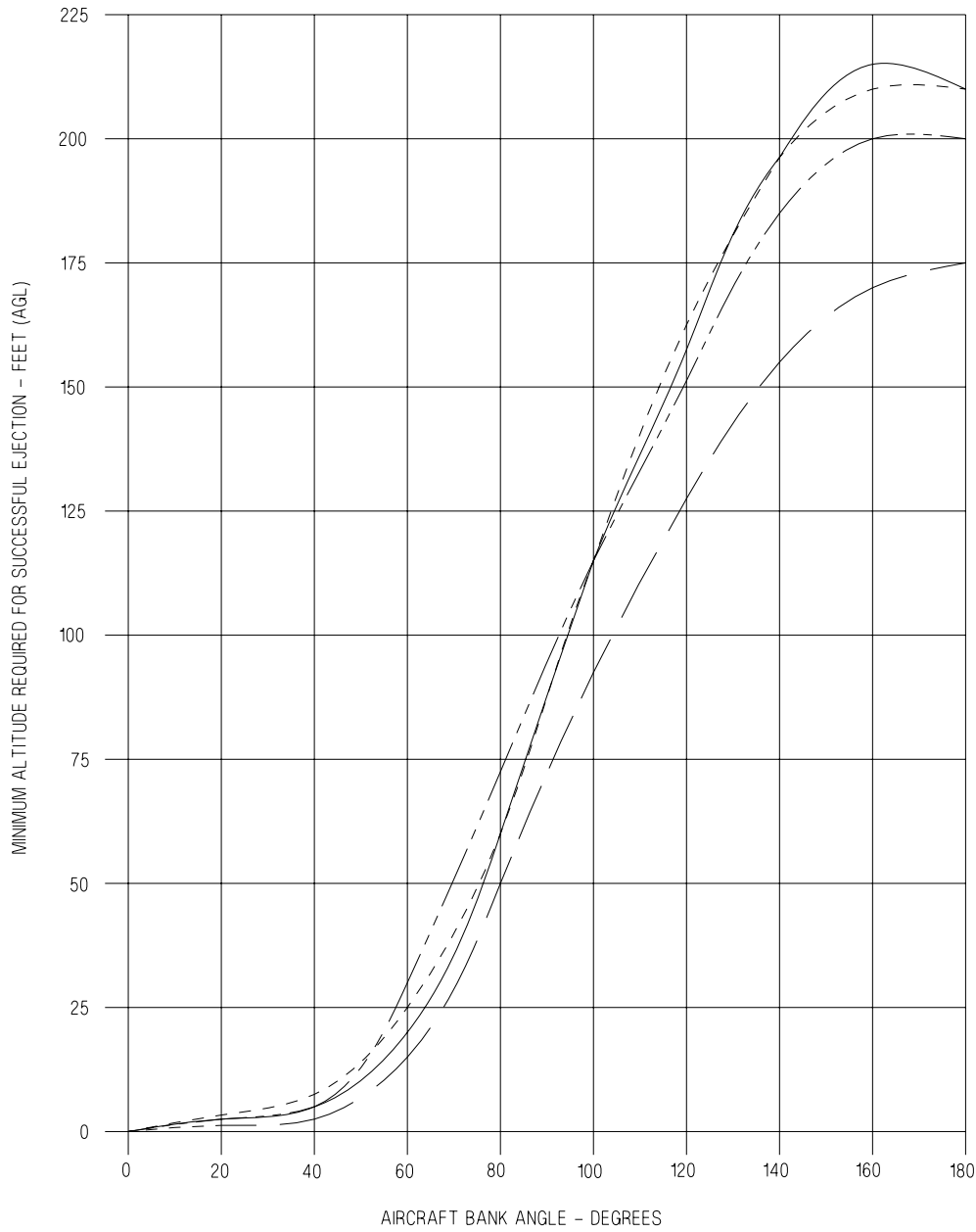

NOTES

- Minimum ejection heights are based on initiation of the escape system, and the time required for a complete dual sequenced ejection is included.
- Bank angle data is for coordinated flight. Yaw or slip will increase the height required for recovery.
- Aircrew reaction time is not included.
- Ejection altitude is below 5000 feet MSL.

LEGEND

- 130 KNOTS
- - - - - 250 KNOTS
- 400 KNOTS
- 600 KNOTS

EFN520-215-3-001

Figure 17-2. Airspeed and Bank Angle Effects on Minimum Ejection Altitude (Sheet 2 of 2)

SJU-17 AIRSPEED AND DIVE ANGLE EFFECTS (F/A-18E)

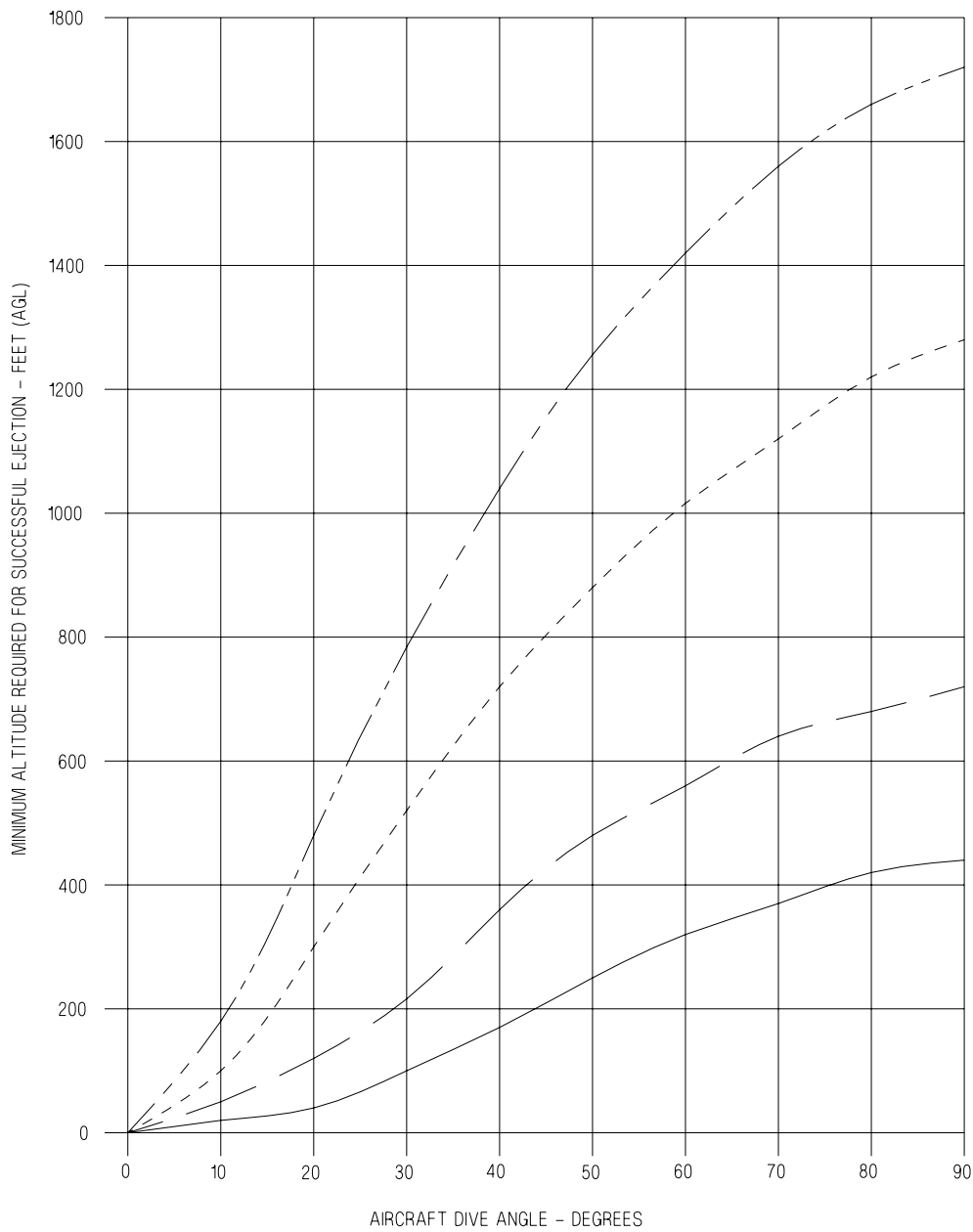

NOTES

- Minimum ejection heights are based on initiation of the escape system.
- Pilot reaction time is not included.
- Ejection altitude is below 5000 feet MSL.

LEGEND

- 130 KNOTS
- 250 KNOTS
- 400 KNOTS
- 600 KNOTS

EFN520-215-2-001

Figure 17-3. Airspeed and Dive Angle Effects on Minimum Ejection Altitude (Sheet 1 of 2)

SJU-17 AIRSPEED AND DIVE ANGLE EFFECTS (F/A-18F)

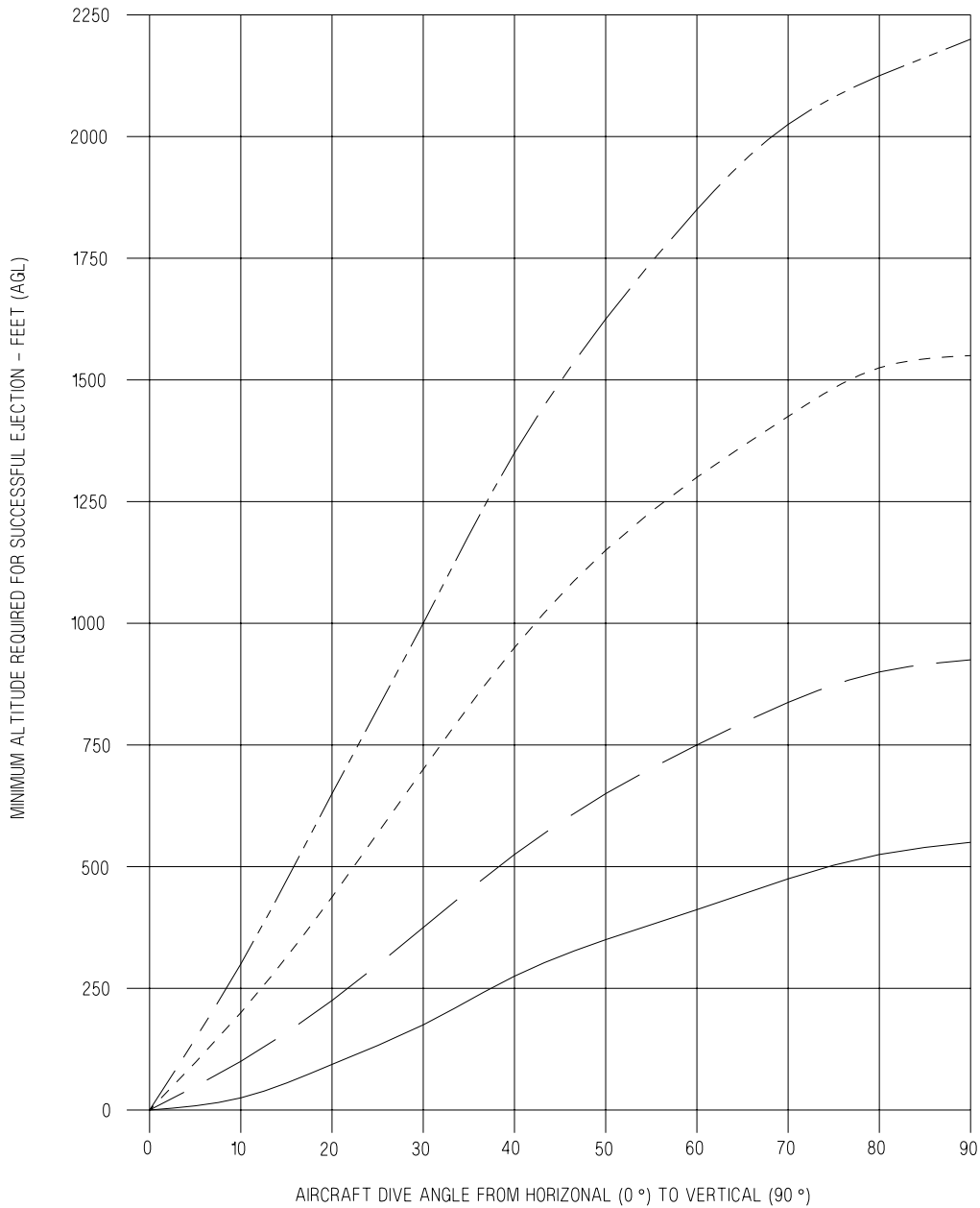

NOTES

- Minimum ejection heights are based on initiation of the escape system, and the time required for a complete dual sequenced ejection is included.
- Aircrew reaction time is not included.
- Ejection altitude is below 5000 feet MSL.

LEGEND

- 130 KNOTS
- 250 KNOTS
- 400 KNOTS
- 600 KNOTS

EFN520-215-4-001

Figure 17-3. Airspeed and Dive Angle Effects on Minimum Ejection Altitude (Sheet 2 of 2)

SJU-17 SEAT SYSTEMS

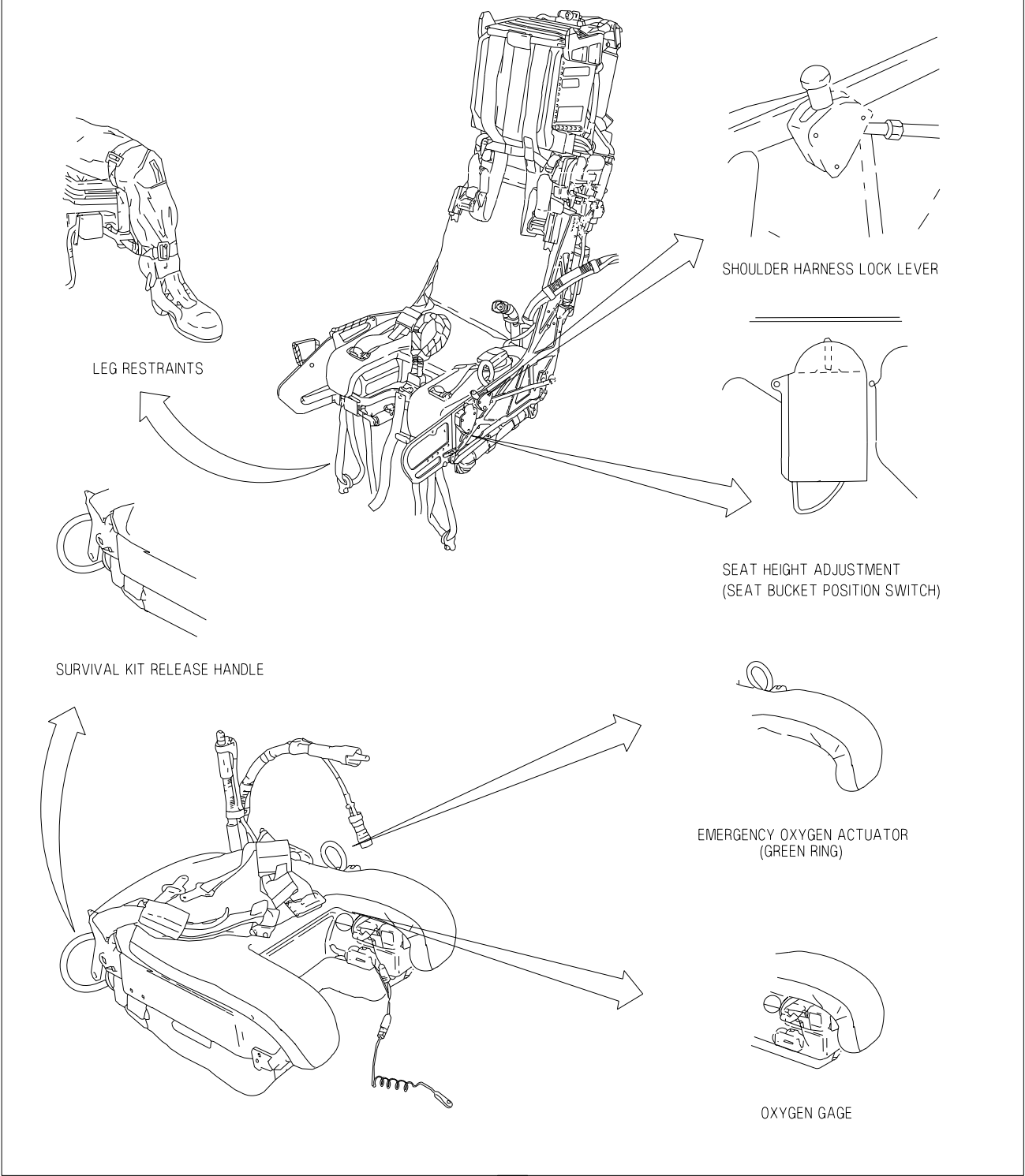

EFN520-98-1-001

Figure 17-4. Ejection Procedures (Sheet 1 of 13)

SJU-17 SEAT SYSTEMS (CONTINUED)

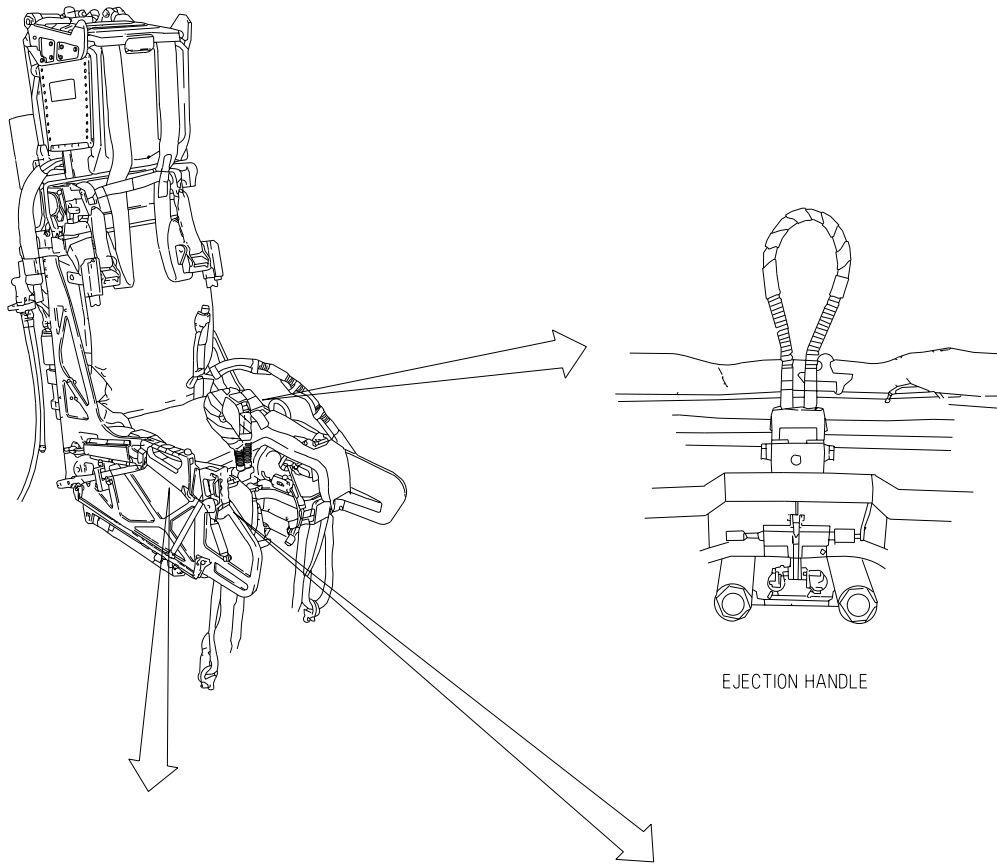

EJECTION HANDLE

EMERGENCY RESTRAINT RELEASE HANDLE
(MANUAL OVERRIDE HANDLE)

SAFE/ARMED HANDLE

Figure 17-4. Ejection Procedures (Sheet 2 of 13)

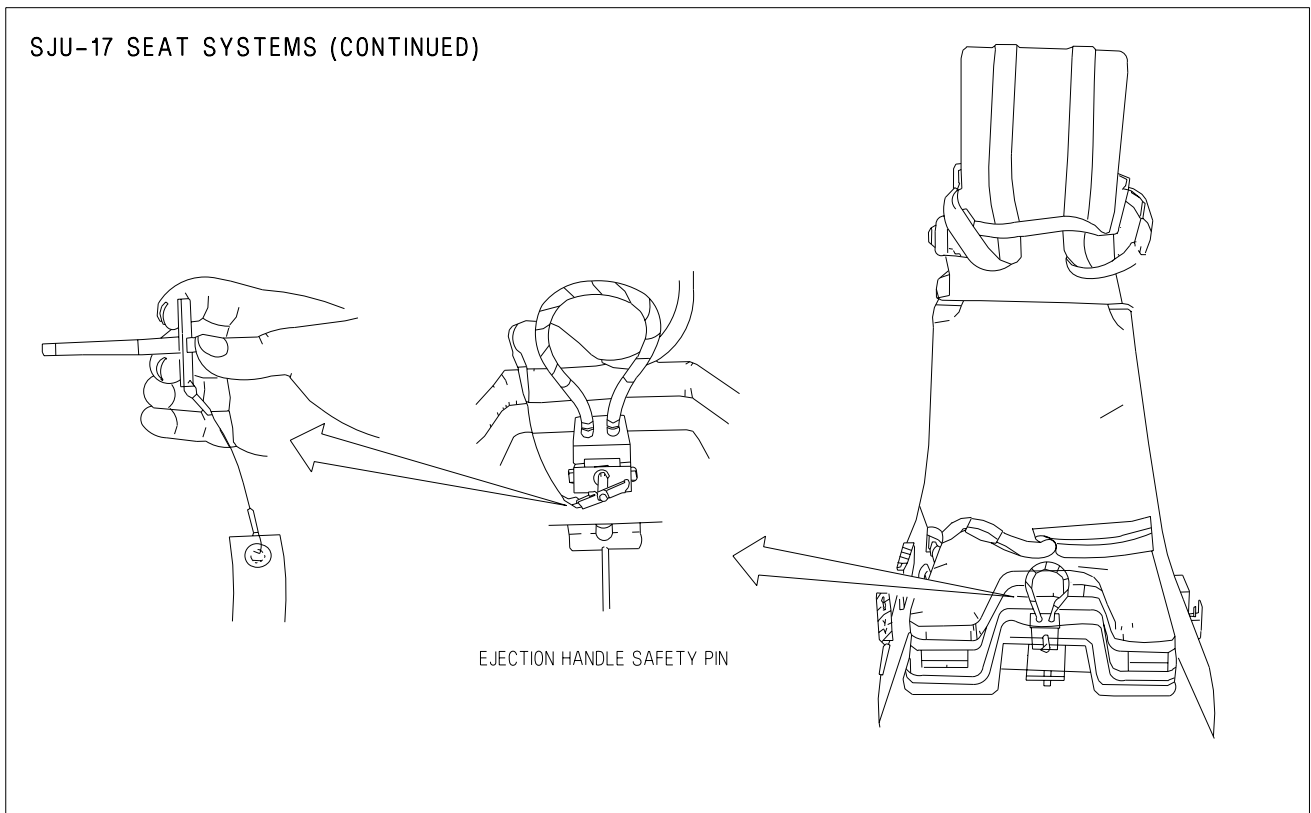

Figure 17-4. Ejection Procedures (Sheet 3 of 13)

**SJU-17 SEAT SYSTEMS (CONTINUED)
EJECTION PREPARATION**

IMMEDIATE EJECTION

For extreme emergency situations; pilot shall immediately initiate ejection.

CONTROLLED EJECTION

If time and conditions permit -

1. Alert crewmember (F/A-18F only).
2. Command selector valve-Rear crewmember check for appropriate position (F/A-18F only).

WARNING

- SOLO mode shall NOT be selected when both seats are occupied. If SOLO mode is selected when both seats are occupied, simultaneous ejection initiation may result in a collision between seats.
 - Ejection system component failure can disable the command ejection function in an F/A-18F. With either AFT INITIATE or NORM selected, each crewmember should initiate ejection independently.
3. Trade airspeed for altitude (zoom).
 4. Level wings and minimize rate of descent.
 5. IFF - Squawk EMERGENCY.
 6. Follow radio distress procedures.
 7. Stow loose equipment.
 8. Cabin pressure switch - RAM/DUMP.
 9. Shoulder harness lock lever - LOCKED.
 10. Lap belt and shoulder harness tight, visor down, helmet secured, oxygen mask tight.
 11. Altimeter - CHECK.

WARNING

Minimum altitudes are dependent upon dive angle, airspeed, and angle of bank. Recommended minimums are 6,000 feet AGL if out-of-control or 2000 feet AGL if in controlled flight.

12. Slow aircraft as much as possible.

WARNING

Do not secure engines. Unsuccessful seat activation may require continued flight to allow alternate ejection method or ditching.

13. Throttles-Idle (airspeed 250 KCAS or less).

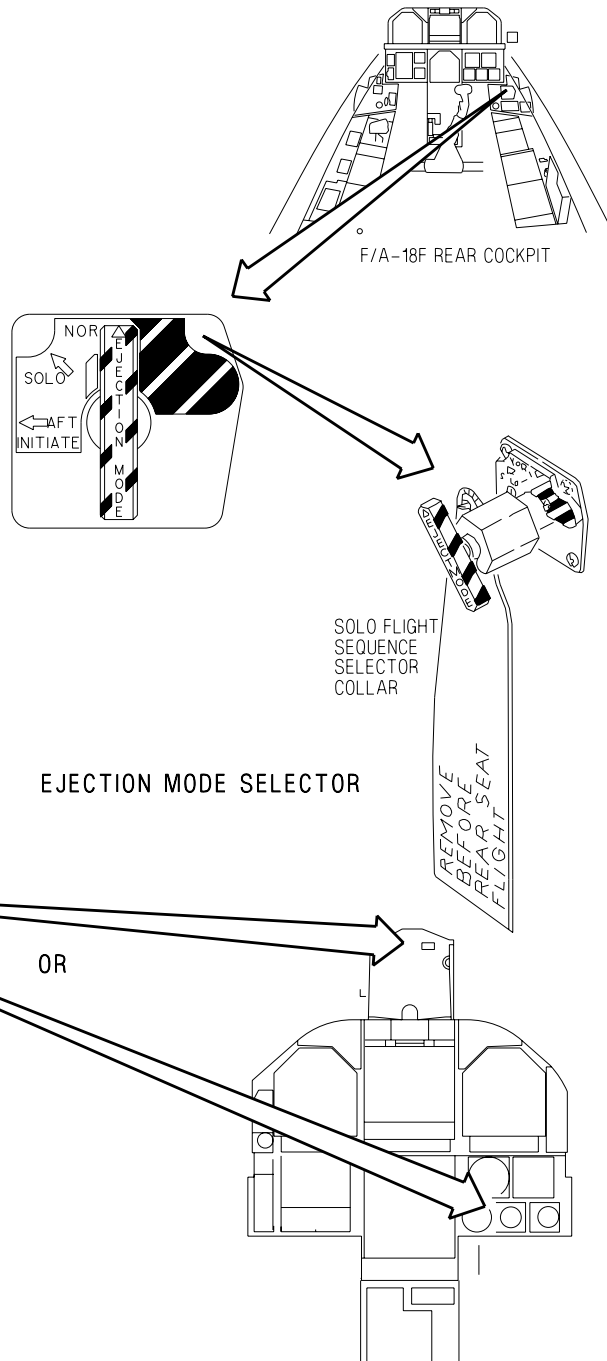

EJECTION MODE SELECTOR

SOLO FLIGHT SEQUENCE SELECTOR COLLAR

OR

NOTE

Over 14,000 feet, calculate free-fall time to automatic parachute opening altitude.

Figure 17-4. Ejection Procedures (Sheet 4 of 13)

SJU-17**Ejection Preparations****EJECTION INJURIES AND BODY POSITIONING****THESE PROPER BODY POSITIONS
MUST BE TAKEN TO PREVENT INJURIES**

1. Press head firmly against headrest.
2. Elevate chin slightly (10°).
3. Press shoulders and back firmly against seat.
4. Hold elbows and arms firmly towards sides.
5. Press buttocks firmly against the seat back.
6. Place thighs flat against seat.
7. Press outside of thighs against side of seat.
8. Place heels firmly on deck, toes on rudder pedals.

WARNING

If ejection occurs without QDC properly stowed in QMB, death will probably result from neck injury.

EJECTION INITIATION

There are two acceptable methods for ejection initiation; the two-hand grip and the single-hand grip.

Two-hand method -

1. Grip the ejection handle with the thumb and at least two fingers of each hand, palms toward body.
Keep elbows close to body.

Single-hand method -

1. Grip handle with the strong hand, palm toward body. Grip wrist of strong hand with other hand, palm toward body. Keep elbows close to body.

Both methods -

2. Pull handle sharply up and toward abdomen, keeping elbows in. Ensure handle pulled to end of travel. Continue holding handle until seat/man separation.

NOTE

In low altitude situations, a one-handed method, using one hand to initiate ejection and the other to maintain the aircraft in the safe operating envelope of the ejection seat, may be required. If firing the seat by this method, particular attention must be paid to maintaining proper body position.

Figure 17-4. Ejection Procedures (Sheet 5 of 13)

SJU-17 SEAT SYSTEMS (CONTINUED)
 AUTOMATIC SEAT/MAN SEPARATION

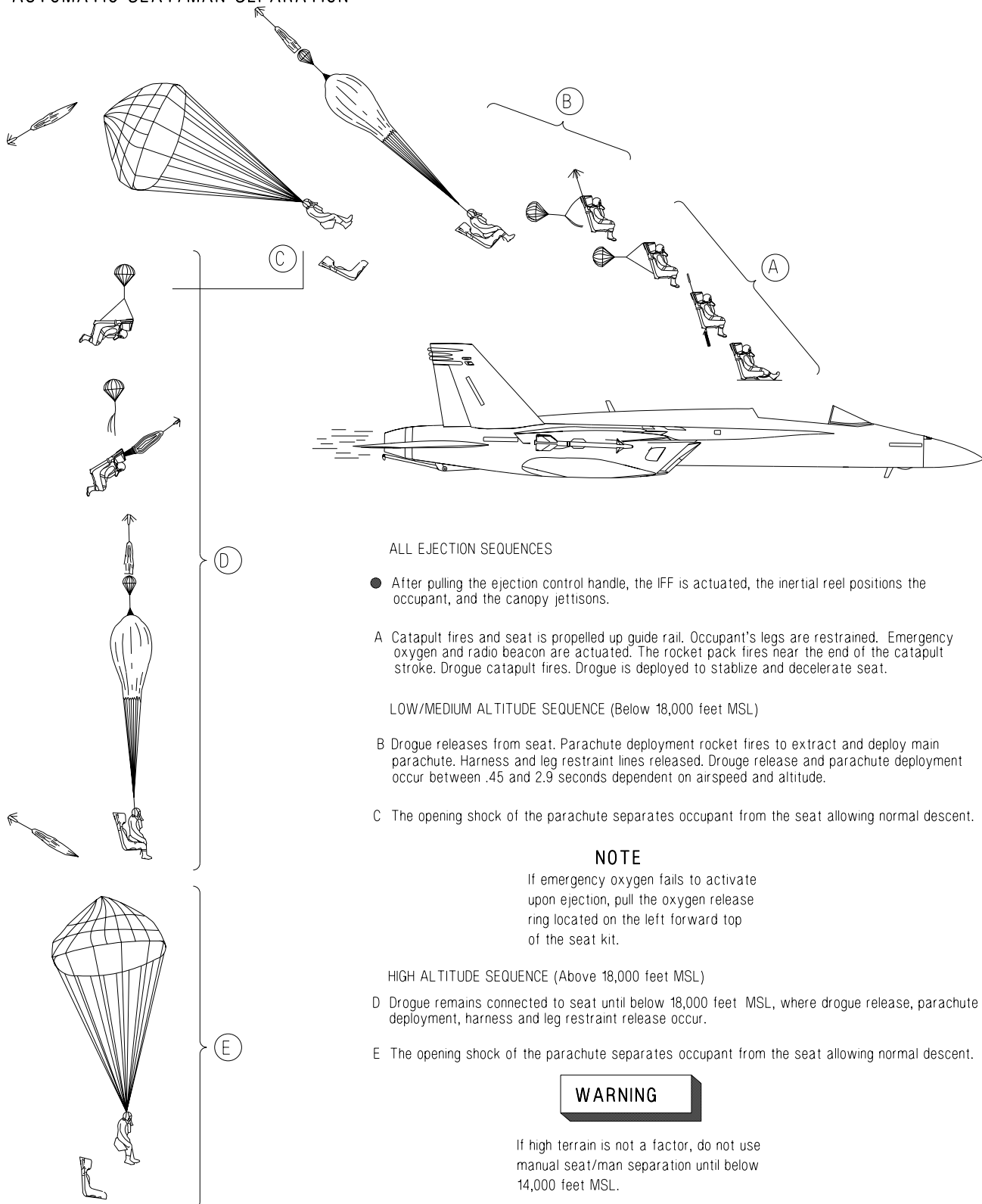

EFN520-98-5-001

Figure 17-4. Ejection Procedures (Sheet 6 of 13)

**SJU-17 SEAT SYSTEM (CONTINUED)
MANUAL SEAT/MAN SEPARATION**

If below 14,000 feet MSL and automatic seat/man separation fails to occur:

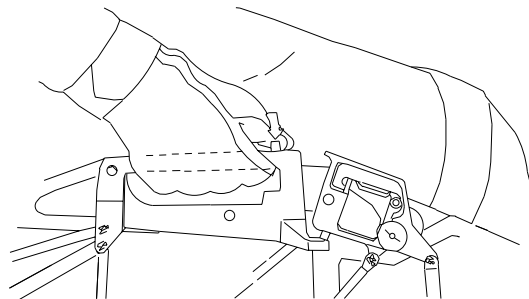

1. Locate manual override handle on right side of ejection seat. Depress handle release button and . . .

The following occurs when the handle is actuated:

- Manual override initiator cartridge fires to activate the parachute deployment rocket motor.
- All occupant-to-seat restraints are released.

WARNING

The barostat mechanism operates as a function of altitude above mean sea level. If ejecting over high altitude terrain, manual seat/man separation may be required to provide adequate altitude for the main parachute to open.

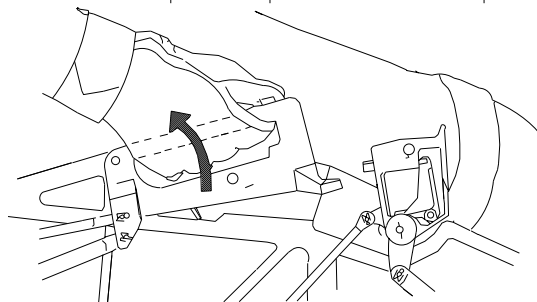

2. Rotate handle up and aft.

- The opening shock of the parachute separates occupant from the seat allowing normal descent.

BAILOUT

There are no provisions for manual bailout.

POST EJECTION PROCEDURES

LPU INFLATION

WARNING

Although an automatic inflation device is designed to inflate the LPU automatically upon water contact, manual inflation of the LPU remains the primary mode of actuation. Automatic actuation is intended for disable or unconscious survivors or if there is insufficient time to manually activate the LPU.

NOTE

The procedures outlined apply to overland or overwater ejections.

1. Immediately following parachute opening shock, check the condition of the parachute canopy. If no damage/malfunction has occurred...
2. Locate beaded handles on LPU.
3. Pull beaded handles down and straight out to inflate.
4. Squeeze LPU waist lobes together to help release velcro on collar lobe or manually release velcro on collar, if necessary, to achieve complete collar lobe inflation.
5. Snap waist lobes together. (optional procedure)

WARNING

Failure to snap waist lobes before water entry may result in face down flotation.

Figure 17-4. Ejection Procedures (Sheet 7 of 13)

**SJU-17 SEAT SYSTEM (CONTINUED)
SEAT KIT DEPLOYMENT**

CAUTION

- Deployment of the seat kit/releasing the raft may create a snag hazard when over trees, power lines, building or "other such objects, and thus may be undesirable in these situations".
- Conducting parachute landings with the seat kit attached may cause injury during landing falls.



1. After inflating the LPU, prepare to deploy the seat kit.

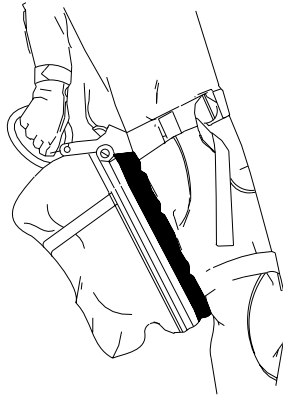

2. Locate either survival kit release handle on the underside of the seat kit.

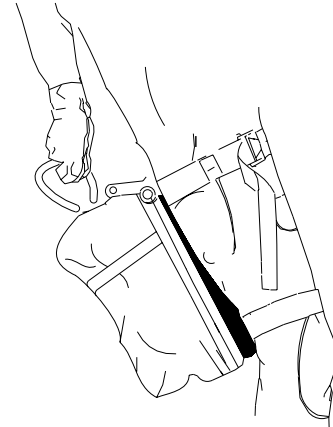

3. Firmly pull up on the survival kit release handle until handle is free of kit and the lower half of seat fall away.

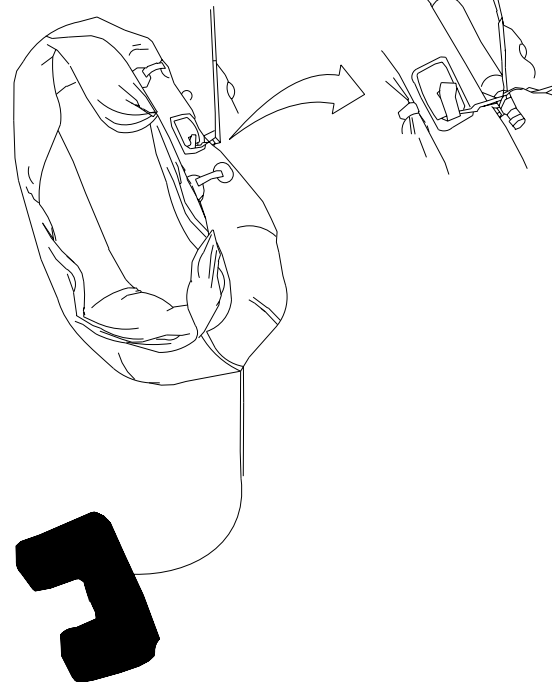

Seat kit deployed with the life-raft fully inflated approximately 17 feet below the upper half of the seat kit container.

NOTE

- Pulling the survival kit release handle unlocks the container deploying the life-raft and survival kit contents bag which remains attached by a drop line. At full extension of the dropline, the life-raft is automatically inflated with CO₂.

If the survival kit must be deployed after water entry, a snatch pull on the red manual activation handle, near the CO₂ bottle, is required to inflate the life-raft.

Figure 17-4. Ejection Procedures (Sheet 8 of 13)

PARACHUTE STEERING

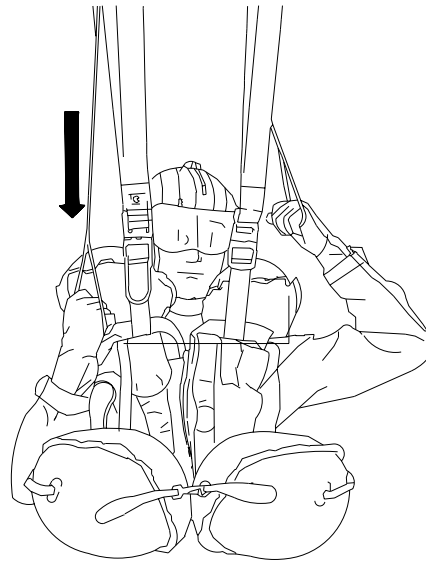

Pull down on left or right lanyard to steer in desired direction.

LANDING PREPARATION OVER WATER

Try to determine the wind direction at the surface using white caps, smoke from the wreckage, or known surface winds in the vicinity. Note that the winds at the surface may be quite different from those encountered at altitude.

When nearing the surface, maneuver the parachute so that you are facing into the wind. Then assume the proper body position for landing:

- Feet together.
- Knees slightly bent.
- Toes pointed slightly downward.
- Eyes on the Horizon.
- Firmly grasp canopy release fittings.
- Tuck elbows in prior to water entry.

LANDING PREPARATION OVER LAND

Perform the same procedures as for over water, but with the following exceptions:

1. Visor – down.
2. Gloves – on
3. Do NOT deploy seat kit.

WARNING

- If a parachute landing is made into the water or a high wind prevents normal spilling of the parachute canopy, disconnect both quick-release fittings that attach risers to the torso-harness suit, thus jettisoning the parachute canopy.
- Do not disconnect the quick-release fittings until after contact with ground or water.

EFN520-98-9-001

Figure 17-4. Ejection Procedures (Sheet 9 of 13)

SJU-17 SEAT SYSTEMS (CONTINUED) PARACHUTE LANDING FALL (PLF) PROCEDURES

Upon toes touching ground surface:

1. Arch side of body in direction of fall.
2. Contact ground at five points of body contact:
 - a. Balls of feet.
 - b. Calf.
 - c. Thigh.
 - d. Buttocks.
 - e. Upper back.
3. Release parachute fittings.

RAFT BOARDING

When clear of the parachute canopy, retrieve the LRU-23/P life raft locating the dropline and pulling the raft to you.

1. Locate and remove the raft retaining lanyard from its pocket just above the CO₂ cylinder.



NOTE

Ensure that raft retaining lanyard is securely attached and oxygen hose has been disconnected from seat kit (if not previously accomplished) before releasing seat lid.

2. Attach the snaphook to gated helo-hoist lift ring.
3. Locate the quick-release fitting and release seat lid.
4. Bring raft around for entry into smaller end (stern).
5. Grasp stern and forcibly push under LPU waist lobes.
6. Using boarding handles, pull into raft and turn toward a seated position.
7. Locate the sea anchor and deploy it.
8. Retrieve survival kit.

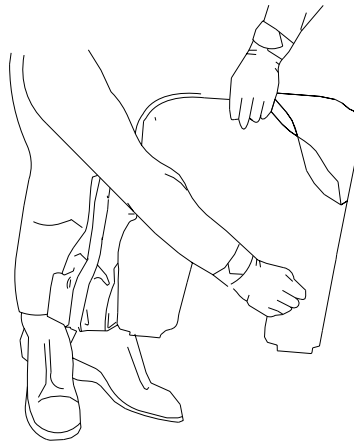

NOTE

- The AN/URT-33A is not secured and once removed from the seat lid, care must be taken to prevent its loss.
- The AN/URT-33A has a retrieval lanyard secured to it with rubber bands. Attach the lanyard to a suitable place on survival equipment. Then remove the AN/URT-33A from its bracket.

9. Retrieve seat lid.
10. Remove seat cushion front lid.
11. Locate and retrieve the AN/URT-33A from under the cushion on the left side of the kit lid.
12. Immediately secure survival package to gated helo-hoist lift ring.

RESCUE

If survivor pickup is to be effected by rescue helicopter, the following procedures should be followed: (Unassisted rescue – no swimmer deployed)

1. Stow or discard loose gear, roll out of raft on right side (side with CO₂ cylinder).
2. Swim away from raft. Ensure that helmet visor has been lowered.
3. Remove raft retention lanyard after rescue device has been lowered.

WARNING

- To allow discharge of static electricity and prevent electrical shock, avoid touching rescue device until it has made contact with water/ground.
- To avoid severe injury, keep hands clear of hook and ring assemblies during hoisting.
- Under no circumstances should survivors attempt to assist their entrance into helicopter or move from the rescue device until helicopter aircrewman assists them to a seat in the aircraft.

PROCEDURES FOR USE OF THE RESCUE HOOK

1. Attach large hook to gated helo–hoist lift ring.
2. Cross arms in front of chest and place head down and to the left. Give thumbs–up signal to helo–hoist operator.

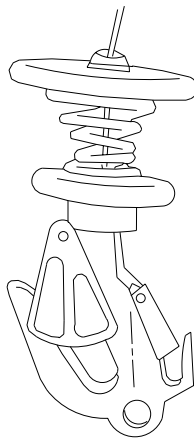

NOTE

The helo rescue hook has a small and large hook. The large hook is the primary hook for hoisting personnel.

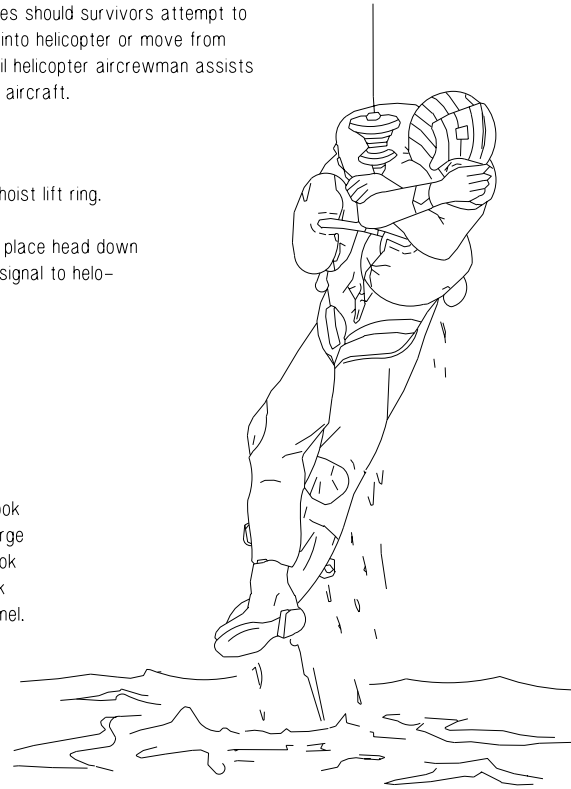

3. Position of aircrewman during helo–hoist. Upon clearing ground/water, cross feet.

EFN520-98-10-001

Figure 17-4. Ejection Procedures (Sheet 11 of 13)

PROCEDURES FOR USE OF THE RESCUE STRAP (HORSECOLLAR)

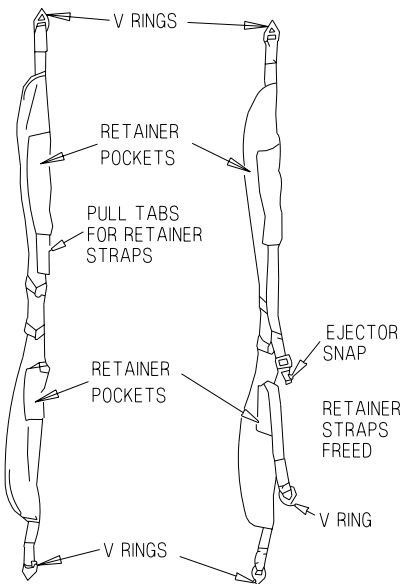

1. Grasp free end of rescue strap.
2. Swim in a circle toward rescue hook completely encircling body with rescue strap.

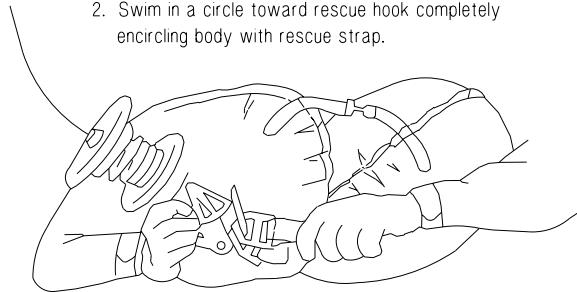

3. Attach free end of strap to large hook.

4. Pull both retainer straps free and connect ejector snap to V-ring of other retainer strap. Pull tight.
5. Ensure rescue strap is above PRU waist lobes and high on back. Wrap arms around strap and place hands in armpits. Keep head down, and give thumbs up signal to helo-hoist operator.

6. Position of aircrewman during hoist. Upon clearing water, cross feet.

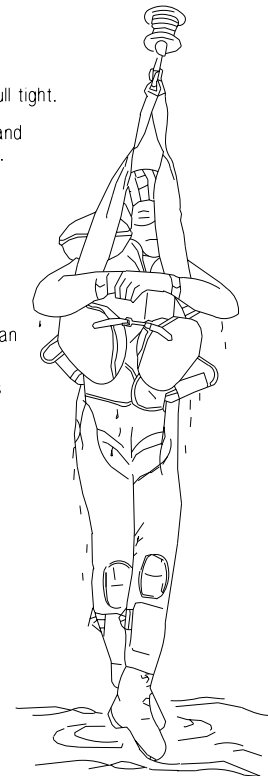
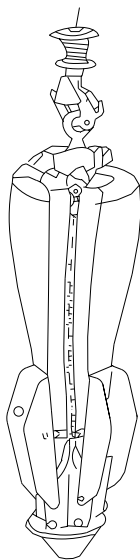
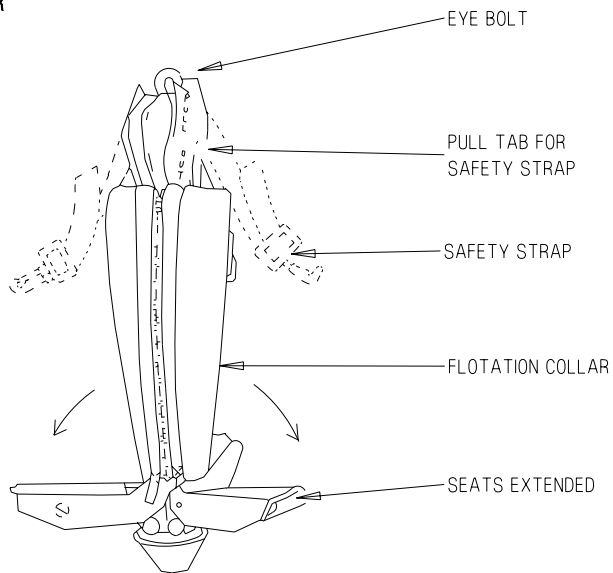

Figure 17-4. Ejection Procedures (Sheet 12 of 13)

PROCEDURES FOR USE OF THE FOREST PENETRATOR



Forest penetrator with flotation collar and seats retracted (safety straps omitted to show connection of rescue hook to eye-bolt).



Forest penetrator with flotation collar and seats extended.

1. Unsnap LPU waist lobes.
2. Extend only one seat on forest penetrator.
3. Sit on seat facing flotation collar. Using elbows, separate LPU waist lobes and pull shaft of penetrator close to chest.
4. Pass safety strap under arm around back, and under other arm. Connect safety strap and tighten.
5. Turn head down and to the left. Give thumbs up signal to helo-hoist operator.



6. Upon clearing water, cross feet.

EFN520-98-12-001

Figure 17-4. Ejection Procedures (Sheet 13 of 13)

WARNING

The aircraft should be ditched only when ejection has failed.

DUTIES BEFORE IMPACT

- | | |
|-------------------------------|---|
| 1. Make radio distress call. | 8. Oxygen mask - TIGHTEN |
| 2. IFF - EMERGENCY | 9. Lower seat, assume position for ditching
(feet on rudder pedals, knees flexed). |
| 3. External stores - JETTISON | 10. Shoulder harness - LOCK |
| 4. Landing gear - UP | 11. Canopy - JETTISON |
| 5. Flaps - DOWN | 12. Fly parallel to swell pattern. |
| 6. Arresting Hook - DOWN | 13. Attempt to touch down along wave crest. |
| 7. Visor - DOWN | 14. Throttles - OFF BEFORE IMPACT |

DUTIES AFTER IMPACT

1. Manual override handle - PRESS BUTTON AND ROTATE AFT AND UP
2. Shoulder harness - RELEASE
3. Emergency oxygen - ACTIVATE

NOTE

In the event of under water egress, it is possible to survive underwater with oxygen equipment until escape can be made.

4. Stand straight up without twisting to release survival kit sticker clips from the seat.

WARNING

If the cockpit has flooded, the LPU may have inflated due to the FLU-8 water activated automatic inflation device. If so, care must be taken during exit to avoid catching the lobes causing entanglement or LPU damage.

5. Abandon aircraft.
6. If the LPU has not automatically inflated - INFLATE
7. Deploy survival kit and inflate life raft.

WARNING

Should aircraft be abandoned under water, exhale while ascending to the surface to prevent bursting of lungs due to pressure differential between lungs and outside of body.

Figure 17-5. Ditching Procedures

CHAPTER 18

Immediate Action

18.1 GENERAL

This chapter contains only immediate action items. It is intended for review only and does not contain any steps which are not immediate action nor does it contain notes, cautions, warnings, or explanatory matter associated with particular procedures.

18.2 APU FIRE LIGHT

IN FLIGHT or on GROUND

- *1. APU FIRE light - PUSH
- *2. FIRE EXTGH READY light - PUSH

GROUND

- *3. Throttles - OFF

18.3 DUAL L BLEED and R BLEED WARNING LIGHTS//L/R ATS CAUTION

- *1. Throttles - Minimum practical
- *2. Emergency oxygen green ring(s) - PULL
- *3. BLEED AIR knob - OFF (DO NOT CYCLE)
- *4. Initiate rapid descent to below 10,000 feet cabin altitude.

18.4 SINGLE L BLEED or R BLEED WARNING LIGHT

- *1. Throttle affected engine - IDLE
- *2. BLEED AIR knob - L OFF or R OFF (DO NOT CYCLE)

If light still on, do the following in order until the light goes out -

- *3. Throttle affected engine - OFF
- *4. Emergency oxygen green ring(s) - PULL
- *5. BLEED AIR knob - OFF (DO NOT CYCLE)
- *6. Initiate rapid descent to below 10,000 feet cabin altitude.

18.5 FIRE LIGHT**GROUND**

- *1. Throttles - OFF
- *2. FIRE light affected engine - PUSH
- *3. FIRE EXTGH READY light - PUSH AND HOLD UNTIL DISCH LIGHT COMES ON (5 seconds maximum.)

IN FLIGHT**Dual FIRE lights -**

- *1. Throttles - Minimum practical

Single FIRE light or Dual when side confirmed -

- *2. Throttle affected engine - OFF
- *3. FIRE light affected engine - PUSH
- *4. FIRE EXTGH READY light - PUSH AND HOLD UNTIL DISCH LIGHT COMES ON (5 seconds maximum.)
- *5. HOOK handle - DOWN

18.6 ENGINE CAUTIONS

L/R EGT HIGH, L/R ENG, L/R ENG VIB, L/R FLAMEOUT, L/R OIL HOT,
L/R OIL PR, L/R OVRSPD, and L/R STALL

- *1. Throttle affected engine - IDLE

18.7 L/R FUEL INLT CAUTION

- *1. Throttle affected engine - OFF
- *2. FIRE light affected engine - PUSH

18.8 HYD1 (2) HOT CAUTION

- *1. Throttle affected engine - OFF

18.9 OBOGS DEGD CAUTION//HYPOXIA/LOW MASK FLOW/NO MASK FLOW//LOSS OF CABIN PRESSURIZATION/CABIN CAUTION LIGHT BELOW 47,000 FEET

- *1. Emergency oxygen green ring(s) - PULL
- *2. OXY FLOW knob(s) - OFF
- *3. Initiate rapid descent to below 10,000 feet cabin altitude.

18.10 HOT START

If EGT climbs rapidly through 750°C -

- *1. Throttle affected engine - OFF

18.11 BRAKE FAILURE/EMERGENCY BRAKES

If detected after touchdown and flyaway airspeed available -

- *1. Go Around.

If brake failure occurs at slow speed or flyaway airspeed not available -

- *2. Brakes - RELEASE
- *3. EMERG BRK handle - PULL TO DETENT
- *4. Brakes - APPLY gradually

18.12 EMERGENCY CATAPULT FLYAWAY

If flyaway airspeed available -

- *1. Throttles - MAX
- *2. Rudder pedal - FULL AGAINST YAW/ROLL
- *3. EMERG JETT button - PUSH
- *4. Maintain 10° to 12° pitch attitude with \overline{W} symbol.
 - Do not exceed 14° AOA (AOA tone).

If unable to arrest yaw/roll or stop settle -

- *5. Eject

18.13 ABORT

- *1. Throttles - IDLE
- *2. Speedbrake - AS DESIRED
- *3. Brakes - APPLY
- *4. Stick - AFT below 100 knots (if required)
- *5. HOOK handle - DOWN (if required)

18.14 LOSS OF DIRECTIONAL CONTROL DURING TAKEOFF OR LANDING/ PLANING LINK FAILURE

If detected after touchdown and flyaway airspeed available -

- *1. Go Around

If flyaway airspeed not available -

- *1. Select emergency brakes (if appropriate)
- *2. HOOK handle - DOWN (if required)

18.15 COCKPIT SMOKE, FUMES, OR FIRE

- *1. Emergency oxygen green ring(s) - PULL
- *2. OXY FLOW knob(s) - OFF
- *3. Initiate rapid descent to below 10,000 feet cabin altitude.
- *4. CABIN PRESS switch - RAM/DUMP

18.16 OCF RECOVERY

- *1. Controls - RELEASE, FEET OFF RUDDERS, SPEEDBRAKE IN

If still out of control -

- *2. Throttles - IDLE
- *3. Altitude, AOA, airspeed, and yaw rate - CHECK

If command arrow present -

- *4. Lateral stick - FULL WITH ARROW

When command arrow removed -

- *5. Lateral stick - SMOOTHLY NEUTRAL

When recovery indicated by AOA and yaw rate tones removed, side forces subsided, and airspeed accelerating above 180 KCAS -

- *6. Recover

Passing 6,000 feet AGL, dive recovery not initiated -

- *7. Eject

18.17 SINGLE ENGINE FAILURE IN LANDING CONFIGURATION

- *1. Throttles - MIL or MAX
- *2. FLAP switch - HALF
- *3. Maintain on-speed AOA and balanced flight.

PART VI

ALL WEATHER PROCEDURES

Chapter 19 - Instrument Flight

Chapter 20 - Extreme Weather Procedures

Chapter 21 - Hot Weather Procedures

Chapter 22 - Cold Weather Procedures

CHAPTER 19

Instrument Flight

19.1 INSTRUMENT FLIGHT

19.1.1 Before Takeoff. If instrument flight is expected immediately following takeoff or flight in RVSM airspace is planned, thoroughly check navigation equipment and crosscheck the HUD and standby flight instruments. Check to ensure the HUD altitude is within 30 feet of parking spot elevation, and the standby altimeter is within 60 feet of parking spot elevation. If flight in icing conditions is anticipated, perform an engine anti-ice detector test (ENG ANTI ICE switch to TEST). If icing conditions are anticipated immediately after takeoff, place the ENG and PITOT ANTI ICE switches to ON just prior to takeoff roll.

19.1.2 Inflight. In RVSM controlled airspace, BALT autopilot mode must be engaged when level at an assigned altitude on the HUD below Mach 0.90. This is required in order to fully comply with RVSM requirements. After engagement, the Mach limit is Mach 0.92.

During instrument flight, particularly in icing conditions, and for flight in RVSM airspace, frequently crosscheck standby flight instruments to verify that the primary systems are functioning normally. A slowly flashing velocity vector indicates that the INS is providing valid attitude information but the FCC air data functions are the source for the velocity vector.

The HUD altitude and standby altimeter readings will differ as a function of Mach number. In RVSM controlled airspace, when at assigned altitude on HUD, periodically add standby altimeter error (Standby Altimeter Error table below) to standby altimeter and compare to HUD altitude. If altitudes differ by more than 250 feet, notify ATC that the aircraft is no longer RVSM compliant. With MC OFP H5E AND UP, use the HSI/DATA/(A/C) page STBY CHK value to compare directly with the standby altimeter. Both are uncorrected altitudes.

NOTE

The barometric setting is assumed to be 29.92 for all RVSM related activities. Do not use the standby altimeter for RVSM altitude holding requirements.

Standby Altimeter Error	
Mach Number	Standby Altimeter Error (Feet)
0.50	120
0.60	150
0.65	175
0.70	200
0.75	220
0.80	280
0.85	260
0.90	330
0.92	380

In RVSM controlled airspace, compare left and right AOA values immediately after establishing assigned altitude on HUD. If L and R AOA values on the FCS page differ by more than 2 degrees, notify ATC that the aircraft is no longer RVSM compliant. Allow time for the probes to settle if in turbulent air.

19.1.3 Approaches.

19.1.3.1 Descent. If fuel conservation is of concern, an enroute descent should be flown at 250 KCAS and IDLE power. Advancing the throttles slightly to “pucker” the nozzles reduces drag and results in a slightly more efficient descent.

19.1.3.2 Holding. Fly the holding pattern as directed/depicted. For maximum endurance, maintain approximately 225 to 250 KCAS between 15,000 and 25,000 feet MSL. Total fuel flow should be approximately 4,000 pph.

19.1.3.3 AN/APG-79 AESA Considerations. Aircrew operating AN/APG-79 AESA equipped aircraft shall be aware that directing AN/APG-79 AESA transmissions toward airfields may cause strong electromagnetic interference (EMI) affecting the safety of aircraft on approach. Unless specifically authorized for operational necessity or required for safety of flight, aircrew shall cease AN/APG-79 AESA radar transmissions whenever operating within 10 nm of civilian airfields. Reference Chapter 4.4 for AN/APG-79 AESA radar limitations.

19.1.3.4 Non-Precision. The navigation aids available provide excellent position keeping capability with multiple redundancy and steering cues. INS offset data can be used to provide accurate steering to a TACAN IAF and the CRS select option can be used to obtain a visual reference on the MPCD and to provide steering cues on the HUD.

Penetration should be flown at 250 KCAS and approximately 75 % N_2 rpm with the speedbrake as required to control descent rate. Dirty up at 10 nm from touchdown.

19.1.3.5 Precision Approaches. The downwind leg should be flown at 230 to 250 KCAS with gear UP and flaps AUTO. Transition to the landing configuration when directed or no later than 6 nmi from touchdown. To begin descent, lower the velocity vector to approximately -3° and maintain onspeed AOA. Small changes in velocity vector placement can be used to control glideslope. Set the RALT at decision height and be prepared for missed approach.

19.2 DEGRADED SYSTEMS

If the INS fails, the ATT switch should be placed to STBY.

CHAPTER 20

Extreme Weather Procedures

20.1 ICE AND RAIN

Before flight, check with the weather service for the location of the freezing level and probable icing conditions. Flight through known or suspected icing conditions should be avoided, if possible, to prevent engine FOD from ice ingestion.

Prolonged flight in icing conditions is an emergency situation. Flight duration which allows a noticeable accumulation of ice (more than 3/8 inch) on the LEFs constitutes prolonged flight. Ice forms rapidly on the inlet lip and, if allowed to accumulate, can be drawn into the engine causing compressor stalls and/or major FOD. Severe icing conditions can result in rapid ice accumulation in a very short time. An INLET ICE caution should serve as a warning to take action to avoid further ice accumulation.

If icing is anticipated or encountered -

1. Perform an engine anti-ice detector test (ENG ANTI ICE - TEST) to verify proper detector operation.

20.1.1 Ground Operation.

If ambient temperature between 0 and 7°C -

1. Minimize engine operation above IDLE to reduce the potential for ice accumulation on the engine inlet lips. Inlet lip icing can occur at these conditions without the INLET ICE caution.

If visible moisture exists (rain, fog) and the temperature is 45°F (7°C) or less -

1. ENG ANTI ICE switch - ON (after engine start)
2. PITOT ANTI ICE switch - ON (after taxi but prior to takeoff)

If an INLET ICE caution appears prior to takeoff -

1. Do not takeoff. Return to the line and have the engines inspected for possible FOD.

20.1.2 In Flight.

If icing is anticipated or encountered -

1. Enter the clouds at the last possible moment. If on top, descend rapidly.
2. ENG ANTI ICE switch - ON
3. PITOT ANTI ICE switch - ON

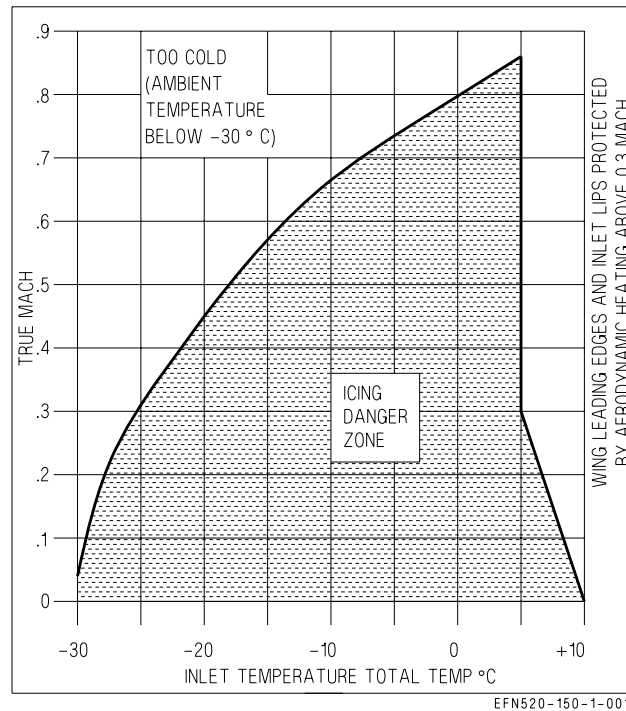

Figure 20-1. Icing Danger Zone

If no ice is visible on the LEFs -

4. Airspeed - Increase until INLET TEMP is at least +5°C (+10°C preferred) on ENG format (if possible).
5. Climb or descend out of icing danger zone (figure 20-1).
Monitor INLET TEMP and Mach. If time and fuel permit, climb to a safe altitude. Altitudes above about 25,000 feet or ambient temperatures below -30°C generally prevent ice formation since the water droplets are frozen and do not adhere. Descend only if sure that ambient temperature is well above freezing at a safe altitude below.

When clear of icing conditions -

6. ENG ANTI ICE switch - OFF

If ice is visible on the LEFs -

4. Throttles - Reduce below 80 % N₂ rpm (if possible). Avoid throttle transients above 90 % N₂ rpm.
5. Airspeed - Maintain above 250 KCAS.
6. AOA - Maintain less than 6° (if possible) to prevent ice accumulation on underside of LEX.
7. Avoid abrupt maneuvers and bank angles over 20°.
8. Descend rapidly below the freezing level.

For landing -

9. WINDSHIELD switch - ANTI ICE or RAIN (as required)
The ANTI-ICE position should be used as required to clear the windshield of ice and/or visible moisture.



Do not operate the windshield anti-ice/rain removal system on a dry windshield. If a WDSHLD HOT caution appears, place the WINDSHIELD switch to OFF immediately to prevent heat damage to the windshield.

10. Reduce airspeed and lower the landing gear at the last possible moment (minimizes ice accumulation on the gear).

If a missed approach is necessary -

11. Slowly advance throttles to the minimum power required for a safe waveoff.
12. Raise landing gear and flaps as soon as possible.

Post-flight -

13. Report all icing encounters (INLET ICE caution) on VID MAF to ensure the engine is inspected for FOD before the next flight.

20.1.3 Landing in Heavy Rain. Refer to the Wet Runway Landings section in chapter 7.**If landing in heavy rain -**

1. WINDSHIELD switch - RAIN



Do not operate the windshield anti-ice/rain removal system on a dry windshield. If a WDSHLD HOT caution appears, place the WINDSHIELD switch to OFF immediately after landing to prevent heat damage to the windshield.

For wet (standing water) runway conditions -

2. Reduce gross weight to minimum practical.
3. ANTI-SKID switch - VERIFY ON (shore based)
4. Land onspeed or slightly slow with the power reduced to IDLE as soon as possible.

If directional control is comfortable after touchdown -

5. Use maximum anti-skid braking to minimize landing distance.

If directional control problems occur -

6. Do not hesitate to add power and go around.
7. Make arrested landing, if possible.

20.2 TURBULENT AIR AND THUNDERSTORM OPERATION

Avoid flight through thunderstorms and microbursts. If penetration is unavoidable, fly at optimum cruise airspeed but not less than 250 KCAS if above 35,000 feet MSL.

The radar MAP mode can be used to detect storm cells.

1. SURF MAP mode - SELECT (NAV or A/G)
2. RANGE SCALE - SELECT (AS DESIRED)
3. ANTENNA ELEVATION - Raise to horizon. Make sure the radar antenna is raised sufficiently to preclude radar returns from the ground. The RDR ATTK format should display areas of precipitation. If possible, deviate flightpath to avoid these areas.

CHAPTER 21

Hot Weather Procedures

21.1 GENERAL

On the ground, the avionics ground cooling fan should provide adequate avionics cooling up to an ambient temperature of approximately 103°F. Inflight, the ECS controller should provide adequate avionics cooling at all conditions.

With outside air temperature greater than 103°F, fuel recirculation through the heat exchangers during ground operations may be insufficient at IDLE RPM to keep engine and AMAD oil temperature within limits. Increasing the affected engine rpm increases circulation and should clear an OIL HOT caution within 20 seconds (normal operating system).

Under adverse conditions (i.e. hot, heavy, and forward CG), takeoff speeds may be significantly higher than those seen at nominal conditions. Knowing the aircraft predicted takeoff performance should prevent a high speed abort in what is a normally functioning aircraft.

21.2 GROUND OPERATIONS

If OAT is approaching or is above 103°F -

1. Non-essential avionics equipment (radar, TCN, IFF, etc.) ON and BIT then OFF (if required)
2. Consider increasing one engine at or above 74 % N₂ rpm (if possible)
3. ENG format - Monitor ENG OIL TEMP (149°C) and AMAD OIL TEMP (88°C)
4. Avionics equipment - ON JUST PRIOR TO TAKEOFF

If AV AIR HOT or L or R OIL HOT cautions appear -

5. Perform the appropriate caution corrective action procedures.

The AV AIR HOT caution corrective action procedures should remove the caution if the ECS system is operating normally. If the caution cannot be cleared with the ECS MODE switch in AUTO, maintenance action is required.

21.3 IN FLIGHT

At nominal ambient conditions, the aircraft fuel system should provide adequate cooling for the FADECs and subsystem accessories. With extremely hot ambient conditions, feed tank fuel temperatures can approach the 59°C inflight limit. During low altitude flight in hot conditions, particularly with a low fuel state, an L or R FUEL HOT caution may appear. If sufficient cooling is unavailable, the L or R OIL HOT cautions may also appear.

If OAT is approaching or is above 103°F -

1. Monitor feed tank fuel temperatures.

If the L or R FUEL HOT, FADEC HOT, or OIL HOT cautions appear -

2. Perform the appropriate corrective action procedures.
3. Land as soon as practical.

21.4 DESCENT/RECOVERY

The windshield may fog rapidly under conditions of very high aircraft descent rates and high humidity. In such conditions, consider preheating the windshield by placing the DEFOG handle to HIGH. If possible, the maximum comfortable cockpit temperature should be maintained to aid in windshield defog.

If OAT is approaching or is above 103°F -

1. Consider turning off non-essential avionics equipment before entering the landing pattern.

21.5 AFTER LANDING

During ground operations with fuel temperatures above 40°C, the LCS pump and ground cooling fan are commanded on regardless of RADAR knob position to provide ram air cooling for the fuel system. Placing the RADAR knob to OFF postflight removes the radar as a heat source, aids LCS/fuel cooling, and should extend ground operating time.

Once clear of the runway -

1. Avionics equipment - OFF
2. RADAR knob - OFF

If line shutdown -

3. Canopy - LEAVE OPEN

If hotpits -

3. Monitor feed tank fuel temperatures.

NOTE

The ground L or R FUEL HOT caution thresholds are 79°C with less than 5,000 pounds of fuel and 59°C with more than 5,000 pounds of fuel.

If feed tank fuel temperatures are approaching limits -

4. Consider shutting down the left engine (significantly reduces the heat load).

If a L or R FUEL HOT caution appears -

5. Perform the corrective action items.

CHAPTER 22

Cold Weather Procedures

22.1 EXTERIOR INSPECTION

If the aircraft has not flown within 4 hr -

1. Pay particular attention to the nosewheel oleo, and APU and brake accumulator pressures.

22.2 BEFORE ENTERING COCKPIT

If a battery/APU start is anticipated -

1. Consider using external power to raise the canopy to conserve battery power.

22.3 INTERIOR CHECK

1. Canopy - Consider leaving open until the right engine has been started to (1) conserve battery power and (2) permit rapid egress.

If the aircraft has been cold soaked below -18°C (0°F) -

1. Rudder pedal adjustment may be difficult or impossible and the inertia reel may not retract automatically until the cockpit warms up (typically 5 to 10 minutes).

22.4 ENGINE START

1. Perform normal engine starts (windmilling is not required).

APU starts should be successful if the battery and the APU accumulator are fully charged. The FADEC modulates fuel flow as required to prevent a hung start. Successful engine starts have been demonstrated at ambient temperatures down to -40°F without start anomalies; however, expect engine starts to be slower than at nominal temperatures.

2. Avoid activating any hydraulic actuated system for 2 minutes after both engines are online.

This allows hydraulic fluid to warm both systems and prevents hydraulic seal damage and potential hydraulic leaks.

3. Oil pressure on the EFD may appear as invalid if 200 psi is exceeded. Maximum oil pressure 2.5 minutes after engine start is 180 psi.

22.5 BEFORE TAXI

If ambient temperature between 0 and 7°C -

1. Minimize engine operation above IDLE to reduce the potential for ice accumulation on the engine inlet lips. Inlet lip icing can occur at these conditions without the INLET ICE caution.

If visible moisture exists (rain, fog) and the temperature is 7°C (45°F) or less -

1. ENG ANTI ICE switch - ON (after engine start)
2. PITOT ANTI ICE switch - ON (after taxi but prior to takeoff)

If the aircraft has not flown within 4 hr with ambient temperature below -18°C (0°F) -

1. Up to three selections of the FCS exerciser mode may be required in order to obtain a successful FCS RESET after the initial 2 minute warm-up.

For cold weather operations below -18°C (0°F) -

1. Three arresting hook cycles should be performed to bring extension time within specification (2 seconds is nominal).
2. Proper operation of the OBOGS monitor may not occur until 2 minutes of warm up.

22.6 TAKEOFF

If snow or slush has accumulated on the landing gear -

1. Leave the gear down for 1 minute after takeoff to clear snow or slush.
2. The landing gear may be slow to retract (up to 30 seconds) following cold soak below -18°C (0°F). Gear retraction times in excess of 15 seconds annunciate the landing gear warning tone.
3. Carefully monitor gear uplock signals (all three landing gear position lights out, landing gear warning light out).

PART VII

COMM-NAV EQUIPMENT AND PROCEDURES

Chapter 23 - Communications-Identification Equipment

Chapter 24 - Navigation Equipment

Chapter 25 - Backup/Degraded Operations

Chapter 26 - Visual Communications

Chapter 27 - Deck/Ground Handling Signals

CHAPTER 23

Communication-Identification Equipment

23.1 MULTIFUNCTION INFORMATION DISTRIBUTION SYSTEM (MIDS)

MIDS is an advanced, high capacity, jam resistant, digital communication link. MIDS is an omnidirectional radio that uses frequency-hopping techniques similar to HAVEQUICK, and encryption for security. It is like a Local Area Network (LAN) in that multiple users can access information simultaneously. MIDS is used to exchange near real-time information among air, ground and sea elements engaged in tactical operations. LINK 16 equipped platforms can transfer voice and data. Refer to TACMAN Vol 3 for Tactical information. Refer to Chapter 24 for navigation information.

23.2 ICS - INTERCOM SYSTEM

The ICS provides amplification and distribution of intercockpit voice communications, aircrew-to-ground crew voice communications, ICS voice alerts and tones, as well as advisory tones originating external to the ICS.

Volume controls are provided to control headset volume for:

1. Voice Activated Intercom (VOX)
2. Transmit sidetone/aircrew intercom audio/ground crew intercom audio
3. MIDS A audio
4. MIDS B audio
5. RWR audio
6. WPN delivery audio
7. TACAN ident
8. Auxiliary audio (available for other uses).

The ICS is also used to control the following COMM/IFF related functions:

1. Selection of PLAIN voice or CIPHER relay modes (RLY switch).
2. Selection of guard transmit (G XMT) for COMM 1 and 2 (G XMIT switch).
3. Hold or zeroize of IFF crypto code (CRYPTO switch).
4. Selection of IFF Mode 4 cautions, advisories, and voice alerts (MODE 4 switch).
5. Selection of IFF NORM or EMERG operating modes (IFF MASTER switch).

23.2.1 ICS Function Selector Switch (F/A-18F). The ICS function selector switch is located in each cockpit and is used to select the operating mode for ICS voice communications.

23.2.1.1 ICS Function Selector Switch Front Cockpit (F/A-18F). The switch is located on the ANT SEL panel on the outboard left console in the front cockpit. In order for a crewmember to communicate on the ICS, the ICS function switch in that cockpit must be in HOT MIC and the ICS VOL knob must be set (as desired) above the LO position.

RADIO ORIDE Selects HOT MIC in both cockpits and ensures ICS volume is louder than COMM volume.

HOT MIC Enables the front (rear) cockpit microphone for ICS transmissions.

COLD MIC Disables front (rear) cockpit microphone.

23.2.1.2 ICS Function Selector Switch Aft Cockpit (F/A-18F). The switch is located on the VOL control panel on the left console in the aft cockpit. In order for a crewmember to communicate on the ICS, the ICS function switch in that cockpit must be in NORM and the ICS VOL knob must be set (as desired) above the LO position.

RADIO ORIDE Selects HOT MIC in both cockpits and ensures ICS volume is louder than COMM volume.

NORM Enables aft cockpit microphone for ICS transmissions.

23.2.1.3 ICS Aft Cockpit Kick Switches (F/A-18F Lot 26 and up). Two ICS kick switches are located on the inboard side of each rudder pedal. These switches are in addition to COMM transmit switches on the rudder pedals. Either switch will activate the ICS for intercockpit communication.

23.3 VHF/UHF COMMUNICATION SYSTEM

The aircraft has two ARC-210 voice communication radios. The VHF/UHF radios, COMM 1 and COMM 2, provide air-to-air/air-to-ground voice communications; and, in conjunction with automatic direction finding (ADF), equipment (If installed), provide a DF function. The radios can be operated in plain mode, anti-jam (Have Quick 1 or 2) mode, secure mode (KY-58), or relay mode; in either normal or secure voice. An additional function is generation by either COMM 1 or COMM 2 of a 1,020 hz tone (AM) or a 15 hz tone (FM) which serve as audio cues to the pilot. The COMM 1 and COMM 2 radios operate in the frequency bands listed below. When enabled, integral guard receivers continuously monitor the emergency guard channels for each frequency band.

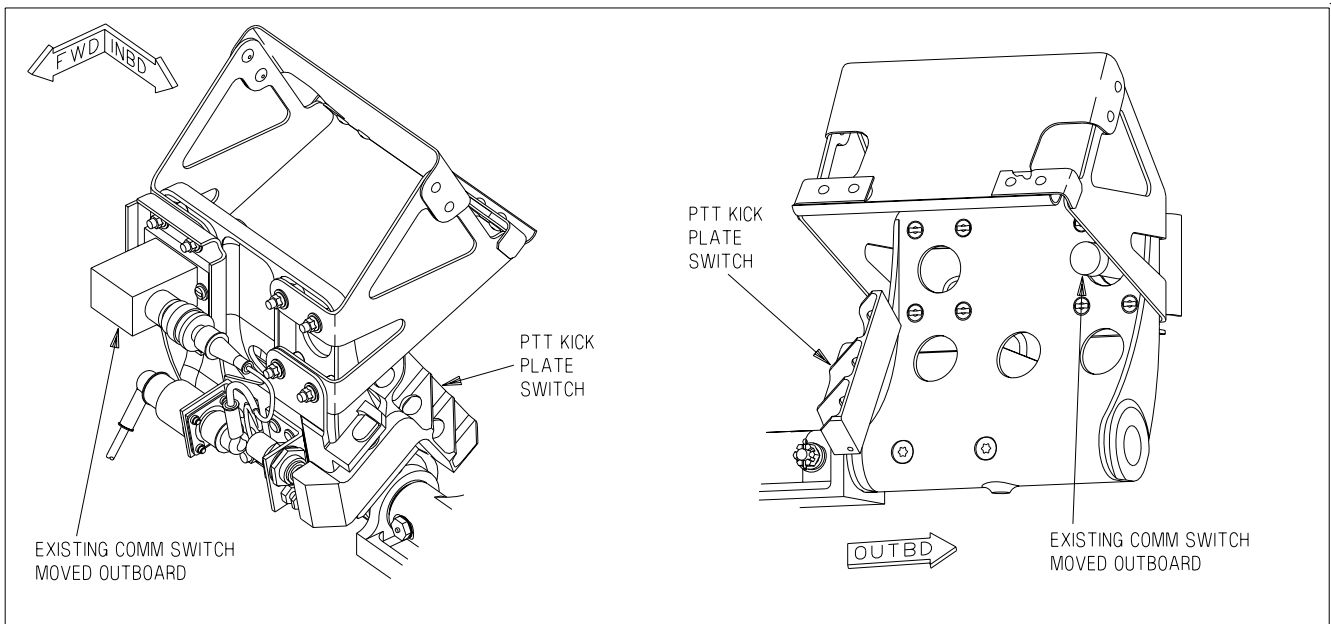

EFN520-414-1-011

Figure 23-1. Aft Cockpit Rudder Pedal Switches - Lot 26 and up

Frequency Band (MHz)	Modulation	Guard Channel (MHz)
30 to 87.995	FM	121.5
*108 to 135.995	AM	—
136 to 155.995	AM/FM	—
156 to 173.995	FM	—
225 to 399.975	AM/FM	243.0 (AM)

*Cannot transmit on 108 thru 117.995 MHz

Transmission and reception of amplitude and frequency modulated signals (AM and FM) occur in the respective frequency bands on spaced channels of 5 kHz. Twenty channels in the 30 to 400 MHz band may be pre-set to assigned frequencies.

23.3.1 VHF/UHF Controls and Indicators. The COMM 1 and COMM 2 are operated by

1. Controls on the UFCD,
2. Controls on the ICS,
3. COMM 1 and 2, MIDS A and B transmit switches on the right (inboard) throttle grip,
4. In the F/A-18F, COMM 1 and 2 transmit switches on the left and right rear cockpit rudder pedals respectively. The PTT panel controls the rudder pedal selection of COMM 1 or MIDS A, and COMM 2 or MIDS B. The PTT panel is located on the left hand console LOTs 21-25, and on the left hand outside bulkhead for LOTs 26 and up.

23.3.1.1 UFCD - Up Front Control Display. The UFCD is on the main instrument panel above the MPCD. The rear cockpit UFCD is on the main instrument panel above or below the MPCD. See figure 23-2 for top level CNI format. Controls on the UFCD for COMM 1 and 2 are:

1. VOL (volume) 1 and 2 COMM control knobs,
2. COMM 1 and 2 channel select knobs,
3. keypad options and scratchpad display,
4. touch options/displays,
5. ID (identification) button,
6. OFF/BRT (brightness) control knob,
7. CONT (contrast) control knob,
8. SYM (symbology) brightness control knob,
9. EM CON (emission control) pushbutton switch.
10. MIDS - turned on/off by pressing either the TACAN or LINK 16 options, then ON/OFF.

23.3.1.1.1 COMM 1 and 2 VOL (Volume) Control Knobs. Operation of the VOL control knobs is not dependent on the operation of the MPCD or the UFCD. Each VOL control knob controls power (on/off) and audio level to the associated COMM 1 and 2 radio. Tick marks on the VOL control knobs and the face of the UFCD are used to indicate OFF for the associated COMM 1 or 2 radio. Clockwise rotation from OFF applies power to the associated radio and continued rotation increases the audio level. On F/A-18F aircraft, the cockpit and rear cockpit VOL control knobs must both be OFF to remove power from the associated radio. When a radio is powered (on), the associated COMM radio (unlabeled) touch option/display is corner highlighted (upper left corner).

23.3.1.1.2 COMM 1 and COMM 2 Channel Select Knobs. Operation of the COMM 1 or COMM 2 select knobs is not dependent on the operation of the MPCD or UFCD. Clockwise rotation of either COMM channel select knob changes the associated COMM 1 or COMM 2 preset channel selections in the order:

1. CH (1 thru 20) one of twenty preset channels,
2. CH G (guard channel),
3. CH M (manual frequency selection mode),
4. CH C (cue channel/frequency for Single Channel Ground and Airborne Radio System) (SINC-GARS),
5. CH S (ship maritime).

Continued clockwise rotation repeats the change sequence. Counterclockwise rotation reverses the change sequence. Rotating either COMM select knob to CH G tunes the associated radio to 243.0 MHz UHF. To communicate on a guard frequency other than 243.0 MHz UHF, a different guard frequency

must be manually entered. Rotating either knob with any AJ MENU sublevel selected returns the UFCD to the COMM sublevel.

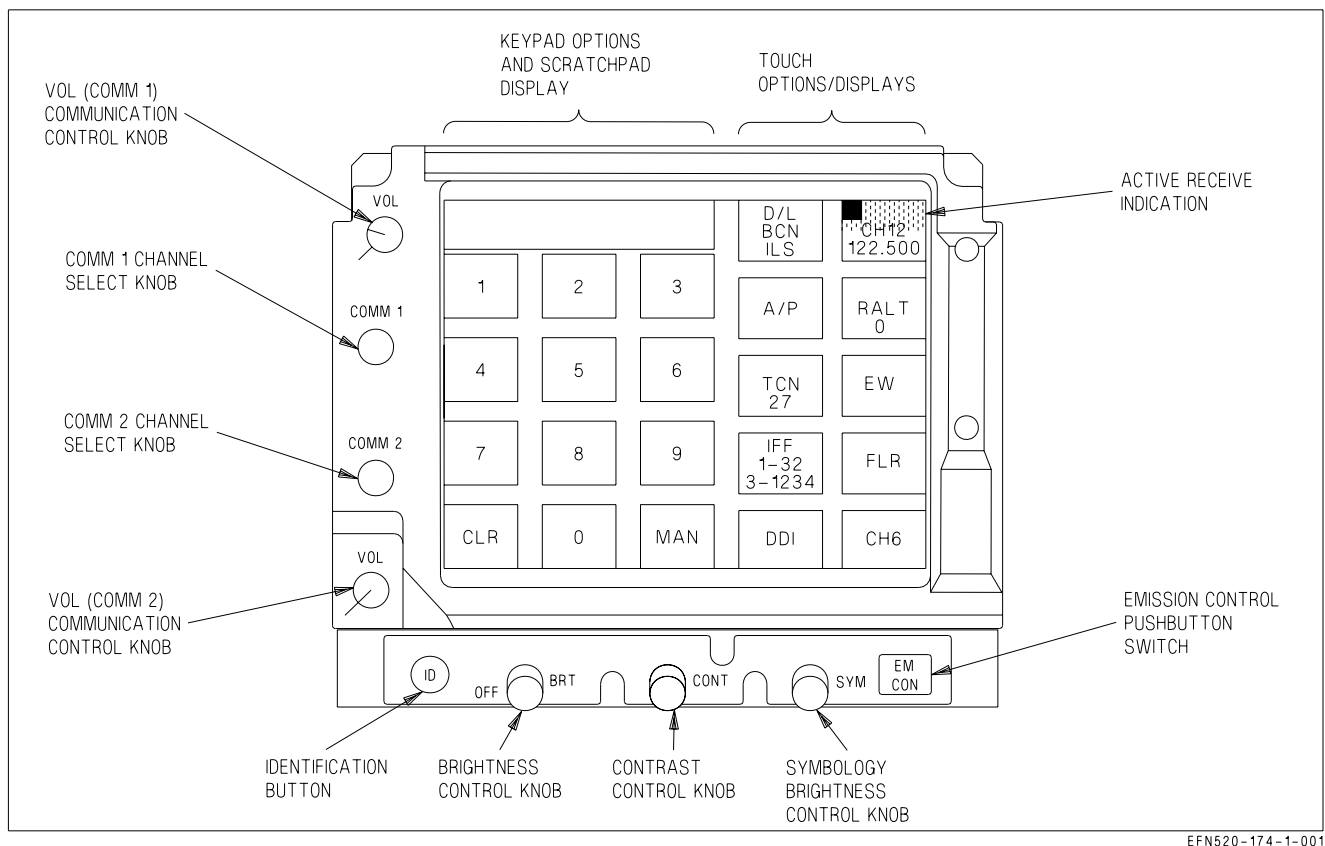

EFN520-174-1-001

Figure 23-2. Top Level CNI Format on Up Front Control Display (UFCD)

23.3.1.1.3 COMM Keypad Options and Scratchpad Display. In the top level CNI format twelve keypad options and a scratchpad display may be used to change the CH 1 thru 20 preset channel numbers, CH G (guard) frequency, CH M (manual frequencies), CH C (cue channel/frequency) or CH S (ship maritime frequencies). The keypad options are 0 thru 9, CLR (clear) and MAN (manual).

23.3.1.1.4 COMM Touch Option/Displays. On the top level CNI format ten touch option/displays may be used to select COMM 1, COMM 2, or other sublevel formats. The upper right and lower right touch option/displays are dedicated to the COMM 1 and COMM 2 radios respectively. Selecting other sublevel formats does not remove the COMM 1 and 2 touch option/displays.

The COMM 1 and COMM 2 channel displays are also utilized to visually identify which audio sources are currently active. When an active radio transmission is occurring, the upper half of the COMM 1/2 option is background shaded. When an active MIDS transmission is occurring, the lower half of the COMM 1/2 option is background shaded.

On Lot 26 and up aircraft with the 8 x 10 display installed, both UFCDs indicate an active transmission in progress when either cockpit initiates the communication. The active transmission indication is a rectangular border around the source (upper for COMM, lower for MIDS). When the active transmit cue is illuminated, the frequency of the related radio is partially covered on the aft UFCD.

The remaining eight touch option/displays are:

1. D/L, BCN, ILS (data link, beacon and instrument landing system),
2. A/P (autopilot),
3. TCN (TACAN with channel number),
4. IFF (identification friend or foe with mode numbers),
5. DDI (digital display indicator),
6. RALT (radar altimeter with altitude reading),

WARNING

Channels 10 and 20 are valid entries for Low Altitude Warning settings. Due to the close proximity of the COMM 1 and RALT touch options/displays, it is possible to inadvertently change the low altitude warning setting for the radar altimeter when using COMM 1 fast data entry.

7. EW (electronic warfare),
8. FLR (forward looking infrared radar).

23.3.1.1.5 UFCD OFF/BRT (Brightness) Control Knob. The OFF/BRT control knob adjusts the overall brightness of the UFCD for both symbology and video. Clockwise rotation from OFF applies power to the UFCD and progressively increases brightness. Counterclockwise rotation to OFF removes power from the UFCD. The UFCD does not need to be powered for COMM 1 or 2 to function.

23.3.1.1.6 UFCD CONT (Contrast) Control Knob. Clockwise rotation of the CONT control knob increases video contrast. Counterclockwise rotation decreases video contrast.

23.3.1.1.7 UFCD SYM (Symbology) Control Knob. Clockwise rotation of the SYM brightness control knob increases the brightness of the UFCD symbology only. Video brightness is not affected by this knob.

23.3.1.1.8 EMCON - Emission Control Pushbutton. The EMCON pushbutton switch may be used to terminate all onboard emitters except COMM transmitters and ALQ-165. If emergency is selected on the ACI panel, the IFF and D/L respond with emergency, if interrogated. When EMCON is selected with the EM CON pushbutton switch, emission can be restored only with this switch. When EMCON is selected with the sensor control switch, emission can be restored with the sensor control switch or the EM CON pushbutton switch. During EMCON operations, EMCON is displayed in the scratchpad for top level CNI display or vertically in the left options for DDI displays on the UFCD.

23.3.1.2 COMM Control Panel. The COMM control panel is on the left console. The switches which are used for VHF/UHF operation are the COMM relay switch and the COMM G XMT select switch.

23.3.1.2.1 RLY (Relay) Switch. The RLY switch, located on the COMM control panel, is used to enable relay communications by allowing information received through one radio to be routed to the other radio for transmission. The switch must be placed in the OFF position prior to the initial

application of power to the aircraft.

CIPHER	Enables CIPHER relay mode.
OFF	Relay mode disabled.
PLAIN	Enables PLAIN voice relay mode.

23.3.1.2.2 G XMIT (Guard Transmit) Switch. The G XMIT switch, located on the COMM control panel, is used to manually tune the COMM 1 or COMM 2 receiver-transmitter to the guard frequency of 243.0 MHz (AM). This function is provided in case the normal (UFCD) and primary backup modes (UFC BU format) of frequency selection are lost.

COMM 1	Selects COMM 1 transmit.
OFF	Normal COMM operation selected.
COMM 2	Guard frequency manually selected on COMM 2.

23.3.1.3 COMM 1 ANT SEL (Antenna Select) Switch. The COMM 1 ANT SEL switch, located on the ANT SEL panel on the outboard left console, is used to manually select the upper or lower blade antenna for COMM 1 reception/transmission.

UPPER	Manually selects the upper blade antenna.
AUTO	COMM 1 automatically selects the antenna receiving a usable signal.
LOWER	Manually selects the lower blade antenna.

COMM 1 receiver-transmitter automatically selects the antenna receiving a usable signal.

23.3.1.4 COMM Throttle Switch. The COMM throttle switch, located on the inboard side of the right throttle, is used to enable radio transmission on COMM 1, MIDS A, COMM 2, or MIDS B. The switch is spring-loaded to the center position.

Top	Selects COMM 1 transmit.
Bottom	Selects COMM 2 transmit.
Forward	Selects MIDS A transmit.
Aft	Selects MIDS B transmit.

23.3.1.5 COMM Foot Pedal Switches (F/A-18F). In the missionized configuration the COMM switches, located on the fixed foot pedals of the rear cockpit, are used to enable radio transmission on COMM 1 and COMM 2, or MIDS A and MIDS B depending on the position of the PTT panel switches. Each switch is spring-loaded to the up position.

Left Down (Unmarked)	Selects COMM 1 or MIDS A transmit.
Both Up (Unmarked)	Both COMMs in receive.
Right Down (Unmarked)	Selects COMM 2 or MIDS B transmit.

23.3.2 COMM 1 and 2 Operation. The operation of COMM 1 and 2 is identical. The following description addresses only COMM 1; however, it should be understood that the description is applicable to COMM 2. Power to COMM 1 is applied by rotating the VOL 1 COMM control knob clockwise. Power application is identified by a corner highlight in the upper left corner of the COMM 1 touch option/display. The channels and preset frequencies (CH 1 thru 20), CH G, CH M, CH C and CH S may be selected by rotating the COMM 1 channel select knob until the desired CH sub level and fixed frequency are displayed in the COMM 1 touch option/display. In the anti-jam mode, the fixed frequency is replaced with H1, H2 or SG. When COMM 1 is actively receiving, the upper half of the touch option/display is half intensity highlighted. The active receive indication is available only if the radio is powered.

23.3.2.1 Top Level CNI Format Channel or Manual Frequency Change. In the top level CNI format, the preset channel number is changed by touching the desired channel number on the keypad and then touching the COMM 1 touch option/display (fast data entry). If an invalid channel entry is made, ERROR is displayed in the scratchpad.

The manual frequency can be changed using the fast data entry mechanization. The manual frequency is entered by entering the desired frequency on the keypad display and touching the COMM 1 or COMM 2 touch option display. Trailing zeroes need not be selected. If an invalid manual frequency entry is made, ERROR is displayed in the scratchpad and the radio does not go to the CH M (manual) channel. With non-AMCD aircraft, highlighting the MAN option and subsequently touching the desired radio, changes that radio to the programmed MAN frequency. With AMCD aircraft, selecting 0 and subsequently touching the desired radio, changes that radio to the programmed MAN radio frequency.

23.3.2.2 COMM Sublevel Selection. Touching the COMM 1 touch option/display while on CH 1 thru 20, CH G, CH M, CH C, or CH S selects that sublevel mode. When applicable, the sublevel mode is used to:

1. Change a fixed frequency,
2. Change ship maritime preset,
3. Change the guard or cue frequency,
4. Enable or disable cipher mode,
5. Adjust squelch,
6. Enable or disable guard receive,
7. Non-AMCD aircraft - Enable or disable ADF,
8. Select modulation type (AM or FM),

9. Enter anti-jam mode (AJ or AJ MENU),
10. Access Have Quick, Have Quick time, SINCGARS coldstart, Have Quick manual data fill, or SINCGARS zeroize.

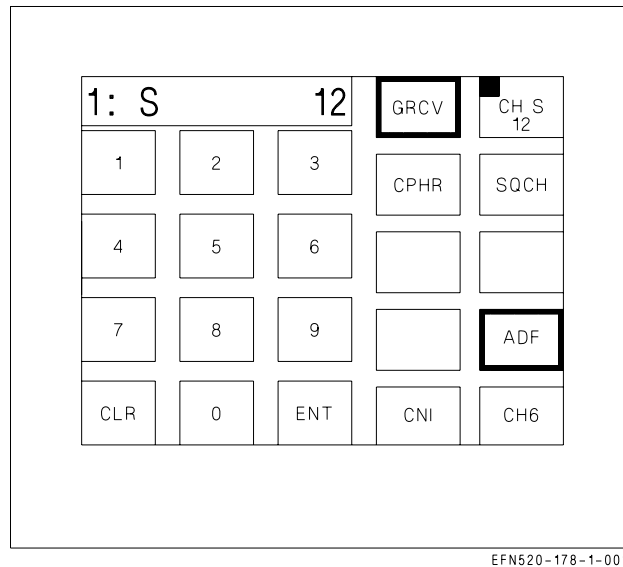

Figure 23-3. COMM Sublevel - Ship Maritime Preset

23.3.2.3 COMM Sublevel - Ship Maritime Preset. The Ship Maritime Preset COMM Sublevel is selected by touching the COMM 1 touch option/display with CH S previously selected (see figure 23-3). This sublevel is used to enable or disable squelch, cipher mode, guard receive, or ADF operation (Non-AMCD aircraft). Selecting this sublevel displays a 1: (selected radio) followed by an S and the current ship maritime preset number. The ship maritime preset number is changed by touching the desired number(s) on the keypad options (numbers 1 thru 28 or 60 thru 88), verifying the new number in the scratchpad, and touching ENT. If an invalid number is entered, ERROR is displayed in the scratchpad. CPHR (cipher), SQCH (squelch), GRCV (guard receive), and ADF (If installed) are enabled or disabled by touching the respective touch options/displays. An enabled option has a highlighted border. CPHR or ADF operation is available for only one radio at a time. Enabling CPHR or ADF on COMM 1 automatically disables CPHR or ADF on COMM 2 if previously enabled.

Enabling ADF automatically disables SQCH. SQCH may be enabled after selecting ADF by touching the SQCH option; however, if SQCH was not enabled after selecting ADF it is automatically enabled when ADF is disabled.

The modulation type (AM or FM), AJ, or AJ MENU options are not available on this sublevel.

23.3.2.4 COMM Sublevel - Guard and Cue Presets. The Guard or Cue Preset COMM Sublevel is selected by touching the COMM 1 touch option/display with CH G or CH C previously selected (see figure 23-4). This sublevel is used to change the G (guard) or C (cue) frequency, to enable or disable squelch, cipher mode, guard receive, ADF operation (If installed), or to select modulation type (AM or FM). Selecting this sublevel displays a 1: (selected radio) followed by a G or C and the current fixed frequency. The fixed frequency is changed by touching the desired numbers on the keypad options, verifying the new number in the scratchpad, and touching ENT. Valid frequencies are:

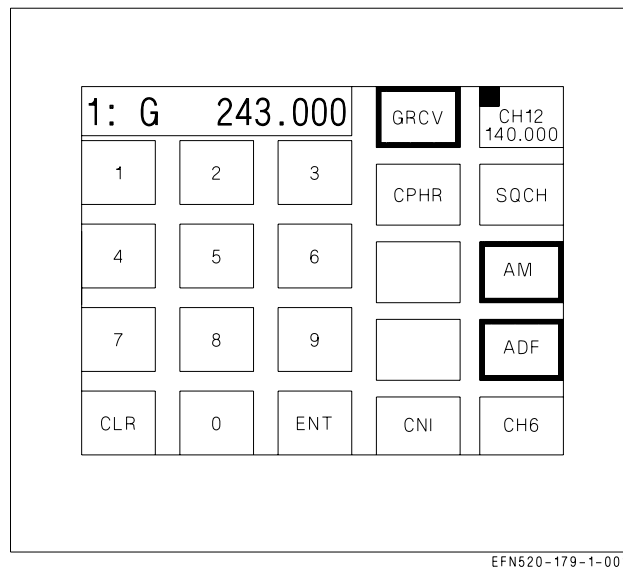

Figure 23-4. COMM Sublevel - Guard and Cue Presets

1. 30 thru 87.995 MHz (FM) - at increments of 0.005, 0.025 MHz for C
2. 108 thru 135.995 MHz (AM) - at increments of 0.005, 0.025 MHz for C
3. 136 thru 155.995 MHz (AM/FM) - at increments of 0.005, 0.025 MHz for C
4. 156 thru 173.995 MHz (FM) - at increments of 0.005, 0.025 MHz for C
5. 225 thru 399.975 MHz (AM/FM) - at increments of 0.025 MHz.

If an invalid number is entered, ERROR is displayed in the scratchpad.

SQCH (squelch), GRCV (guard receive), AM/FM, and ADF (If installed) are enabled or disabled by touching the respective touch options/displays. An enabled option has a highlighted border. The AM/FM option is always border highlighted and toggles between AM and FM. If the current frequency is available only in AM or FM, the AM/FM option is not displayed. While in the UHF AM mode, the cipher option cycles as follows: CPHR (no highlighted border-cipher disabled), CPHR (border highlighted-cipher baseband enabled), CPDP (border highlighted-cipher diphase enabled). The CPHR and CPDP options are mutually exclusive. Continued selection of this option repeats the above cycle. CPHR (both diphase and baseband) or ADF operation (If installed) is available for only one radio at a time. Enabling CPHR or ADF on COMM 1 automatically disables CPHR or ADF on COMM 2 if previously enabled.

Enabling ADF automatically disables SQCH. SQCH may be enabled after selecting ADF by touching the SQCH option; however, if SQCH was not enabled after selecting ADF it is automatically enabled when ADF is disabled.

The AJ and AJ MENU options are not available on this sublevel.

23.3.2.5 COMM Sublevel - Manual Preset. The Manual Preset COMM Sublevel is selected by touching the COMM 1 touch option/display with CH M previously selected (see figure 23-5). This sublevel is used to change the M (manual) frequency, to enable or disable squelch, cipher mode, guard

receive, ADF operation (If installed), select modulation type (AM or FM) or to access Have Quick, Have Quick time, SINCGARS coldstart, Have Quick manual data fill, and SINCGARS zeroize. Selecting this sublevel displays a 1: (selected radio) followed by an M and the current fixed frequency. The fixed frequency is changed by touching the desired numbers on the keypad options, verifying the new number in the scratchpad, and touching ENT.

Valid frequencies are:

1. 30 thru 87.995 MHz (FM) - at increments of 0.005 MHz,
2. 108 thru 135.995 MHz (AM) - at increments of 0.005 MHz,
3. 136 thru 155.995 MHz (AM/FM) - at increments of 0.005 MHz,
4. 156 thru 173.995 MHz (FM) - at increments of 0.005 MHz,
5. 225 thru 399.975 MHz (AM/FM) - at increments of 0.025 MHz.

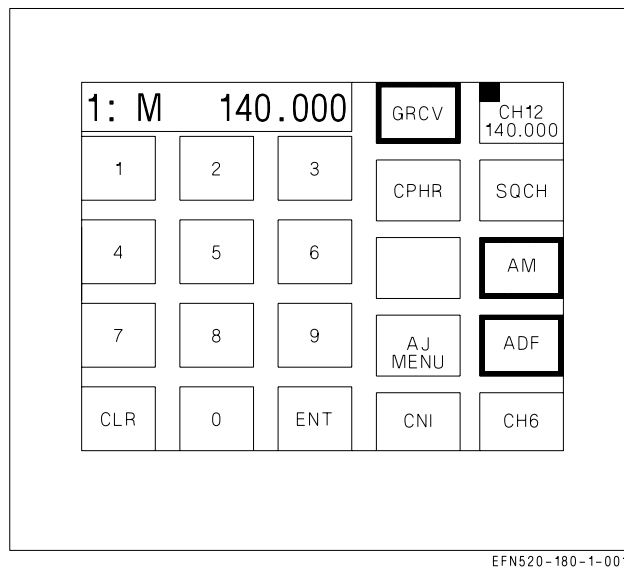

Figure 23-5. COMM Sublevel - Manual Preset

If an invalid number is entered, ERROR is displayed in the scratchpad.

SQCH (squelch), GRCV (guard receive), and ADF are enabled or disabled by touching the respective touch options/displays. An enabled option has a highlighted border. The AM/FM option is always border highlighted and toggles between AM and FM. If the current frequency is available only in AM or FM, the AM/FM option is not displayed. While in the UHF AM mode, the cipher option cycles as follows: CPHR (no highlighted border-cipher disabled), CPHR (border highlighted-cipher baseband enabled), CPDP (border highlighted-cipher diphase enabled). The CPHR and CPDP options are mutually exclusive. Continued selection of this option repeats the above cycle. CPHR (both diphase and baseband) or ADF operation (If installed) is available for only one radio at a time. Enabling CPHR or ADF on COMM 1 automatically disables CPHR or ADF on COMM 2 if previously enabled.

Enabling ADF automatically disables SQCH. SQCH may be enabled after selecting ADF by touching the SQCH option. However, if SQCH was not enabled after selecting ADF it is automatically enabled when ADF is disabled.

The AJ option is not available on this sublevel.

23.3.2.6 COMM Sublevel - Presets 1 Thru 20 (Fixed Frequency). The Preset 1 Thru 20 COMM Sublevel is selected by touching the COMM 1 touch option/display with CH (1 thru 20) previously selected (see figure 23-6). This sublevel is used to change the frequency, to enable or disable squelch, cipher mode, guard receive, ADF operation, to select modulation type (AM or FM), to enter anti-jam mode or to access Have Quick, Have Quick time, SINCGARS coldstart, Have Quick manual data fill, or SINCGARS zeroize. Selecting this sublevel displays a 1: (selected radio) followed by the current channel number and fixed frequency. The fixed frequency for any channel number (1 thru 20) is changed by touching the desired numbers on the keypad options, verifying the new frequency number in the scratchpad, and touching ENT.

1. 30 thru 87.995 MHz (FM) - at increments of 0.005 MHz,
2. 108 thru 135.995 MHz (AM) - at increments of 0.005 MHz,
3. 136 thru 155.995 MHz (AM/FM) - at increments of 0.005 MHz,
4. 156 thru 173.995 MHz (FM) - at increments of 0.005 MHz,
5. 225 thru 399.975 MHz (AM/FM) - at increments of 0.025 MHz.

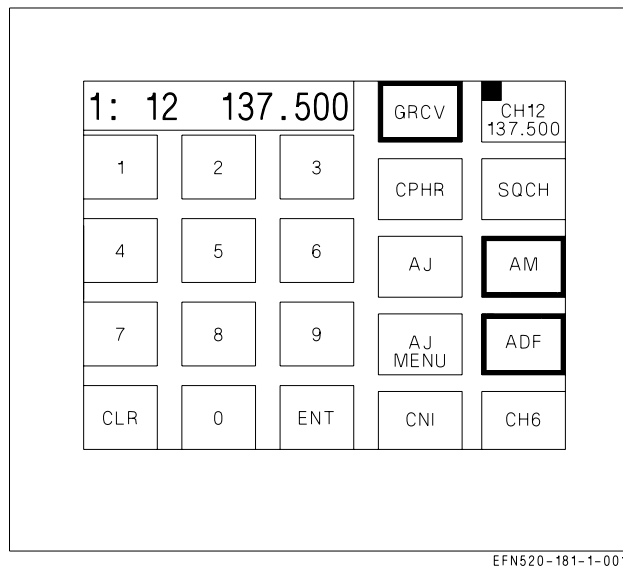

Figure 23-6. COMM Sublevel - Presets 1 Thru 20 (Fixed Frequency)

If an invalid number is entered, ERROR is displayed in the scratchpad. SQCH (squelch), GRCV (guard receive), and ADF are enabled or disabled by touching the respective touch options/displays. An enabled option has a highlighted border. While in the UHF AM mode, the cipher option cycles as follows: CPHR (no highlighted border-cipher disabled), CPHR (border highlighted-cipher baseband enabled), CPDP (border highlighted-cipher diphase enabled). The CPHR and CPDP options are mutually exclusive. Continued selection of this option repeats the above cycle. CPHR (both

diphase and baseband) or ADF operation is available for only one radio at a time. Enabling CPHR or ADF on COMM 1 automatically disables CPHR or ADF on COMM 2 if it was previously enabled.

Enabling ADF automatically disables SQCH. SQCH may be enabled after selecting ADF by touching the SQCH option; however, if SQCH was not enabled after selecting ADF it is automatically enabled when ADF is disabled.

Selecting the AJ option on this sublevel selects COMM 1 anti-jam mode. If Have Quick is pre-defined for the current preset, the radio enters Have Quick mode. If SINCGARS is pre-defined for the current preset, the radio enters SINCGARS. If no data/waveform or time is stored in the radio for the current preset, NO FILL is displayed in the scratchpad and the radio is in neither Have Quick or SINCGARS. For Have Quick or SINCGARS data entry, see Have Quick or SINCGARS System paragraphs, this chapter. Once the radio is in the anti-jam mode it remains in the anti-jam mode, even if the preset channel is changed using the COMM channel select knob or the Top Level CNI Format Channel Change paragraph procedure (fast data entry). The anti-jam mode is disabled by touching the border highlighted AJ touch option/display.

23.3.3 Anti-Jam Operation. There is no AJ or AJ MENU option on the Ship Maritime Preset, Guard Preset, or Cue Preset Sublevels. The Manual Preset Sublevel has an AJ MENU option but does not have an AJ option. Anti-Jam operation is described in the Have Quick and SINCGARS System paragraphs, this chapter.

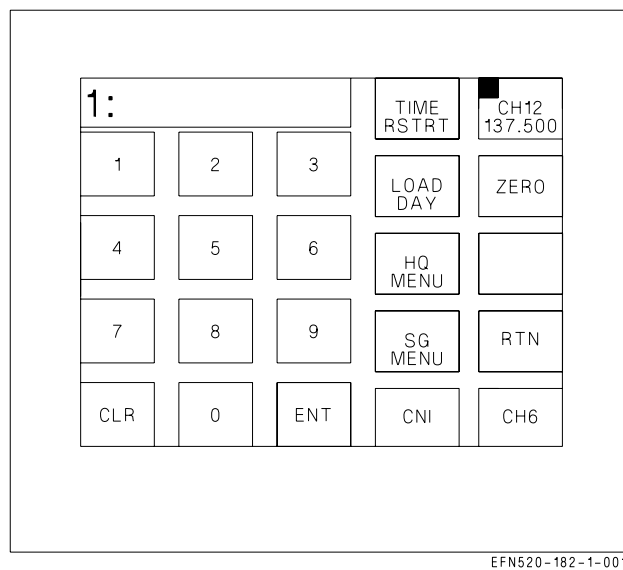

Figure 23-7. AJ MENU From Fixed Frequency COMM Sublevel

23.3.3.1 AJ MENU From Fixed Frequency COMM Sublevel. Touching the AJ MENU touch option/display while on the COMM sublevel with a fixed frequency selects the AJ MENU From Fixed Frequency COMM Sublevel (see figure 23-7). This sublevel initializes with no options selected and displays a 1: (selected radio) in the scratchpad but does not display the fixed frequency. The AJ fixed frequency sublevel is used to control Have Quick time, to control SINCGARS coldstart, to manually load Have Quick fill, and to control Have Quick and SINCGARS zeroize.

The TIME RSTRT option is used to restart the radio clock. To prevent inadvertent selection, this option requires a double selection to start the radio clock. Touching TIME RSTRT option changes the touch option/display to RSTRT ENABLE. Touching the RSTRT ENABLE option starts the radio clock and returns the display to TIME RSTRT. If any option other than RSTRT ENABLE is touched after touching TIME RSTRT the radio clock is not started and the display returns to TIME RSTRT.

The LOAD DAY option is used to load the Have Quick calendar day. Touching the LOAD DAY touch option/display border highlights the option and enables calendar day entry by touching the desired numbers on the keypad options (01 thru 31), verifying the new calendar day in the scratchpad, and touching ENT. When the calendar day is entered into the radio a tone sounds in the head set. Touching any other touch option/display removes the border highlight from the LOAD DAY option and data entry is no longer available.

The ZERO option is used to erase the stored Have Quick word-of-day (WOD) and SINGARS transec data. To prevent inadvertent selection, this option requires a double selection to zero radio data. Touching ZERO option changes the touch option/display to ZERO ENABLE. Touching the ZERO ENABLE option zeroizes both (COMM 1 and 2) radios. The ZERO ENABLE option is border highlighted for 2 seconds and the display returns to ZERO. If any option other than ZERO ENABLE is touched after touching ZERO the radios are not zeroized and the display returns to ZERO.

The RTN option is used to return to the fixed frequency COMM sublevel.

23.4 HAVE QUICK SYSTEM

Have Quick is a slow hopping, UHF, AM line-of-sight jam-resistant voice communication system. The operation involves coordinating and establishing communications nets. These nets have multiple users that have the same ECCM information and are time synchronized. The nets are established and operate with information for a specific word-of-day. The WOD is used to define the frequency hopping pattern for that day. In conjunction with the WOD, a precise time-of-day (TOD), which is effectively the net time synchronizer, is also required. The net number and type can be entered using the keypad options. The three digits to the left of the decimal point are the net number and range from 000 to 999. The three digits to the right of the decimal point represent type: .025 = HQII (NATO), and .050 = HQII (non-NATO).

NOTE

The radios do not contain a clock. Time must be set during aircraft preflight.

The principle functions available for Have Quick control are:

1. Anti-jam (AJ) mode and net selection,
2. Time synchronization including either the reception or the transmission of the TOD,
3. WOD verification and manual entry,
4. Zeroing WOD,
5. Training net control and manual entry.

23.4.1 Have Quick Menu From AJ Menu Fixed Frequency COMM Sublevel. Touching the HQ MENU touch option/display while on the AJ COMM sublevel with a fixed frequency selects the Have

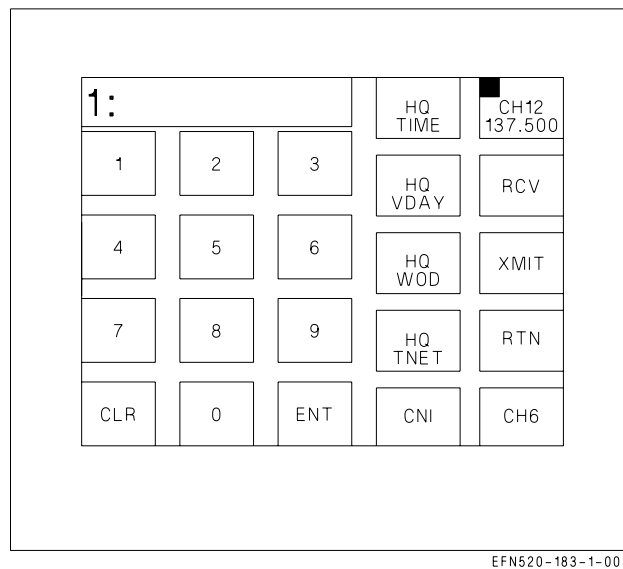

Figure 23-8. Have Quick Fixed Frequency Sublevel

Quick fixed frequency sublevel (see figure 23-8). This sublevel initializes with no options selected and displays a 1: (selected radio) in the scratchpad. This sublevel is used for manual fill operation.

The HQ TIME option is used to transmit or receive Have Quick time. Touching the HQ TIME touch option/display border highlights the option and enables the use of the RCV and XMIT options. With HQ TIME selected, touching the RCV touch option/display border highlights the RCV option until time is received, or until 60 seconds has elapsed. With HQ TIME selected, touching the XMIT touch option/display border highlights the XMIT option for 2 seconds and time is transmitted. The XMIT option is not displayed if ADF is enabled (for the selected radio). The HQ TIME option remains border highlighted until HQ VDAY, HQ WOD or HQ TNET is selected.

The HQ VDAY option is used to verify that a Have Quick word-of-day is loaded for a particular day (see figure 23-9). Touching the HQ VDAY touch option/display border highlights the option and enables calendar day data entry by touching the desired numbers on the keypad options (01 thru 31), verifying the new calendar day data entry and then touching ENT. If there is a stored word of day for the entered calendar day a tone sounds in the head set. The HQ VDAY option remains border highlighted until HQ TIME, HQ WOD or HQ TNET is selected.

The HQ WOD option is used to manually enter the Have Quick word of day. Touching the HQ WOD touch option/display border highlights this option and enables Have Quick word-of-day entry by touching the desired numbers on the keypad options (WOD segments 200.000 thru 399.975 in increments of 0.025), verifying the word of day in the scratchpad, and touching ENT. Each word-of-day is six-segments that look like frequencies. When the HQ WOD is first selected, 20 is displayed in the scratchpad followed by the first six-segments of data. There are six individual word-of-day segments identified by the numbers 20 thru 15. As each six-segment data is entered, the number decrements thru 15. Trailing zeros need not be entered.

- 1st Segment - 20 000.000 ENT
- 2nd Segment - 19 000.000 ENT
- 3rd Segment - 18 000.000 ENT
- 4th Segment - 17 000.000 ENT

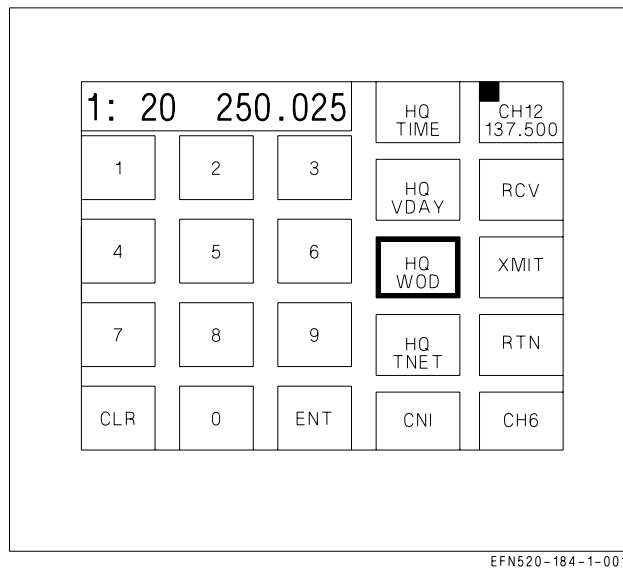

Figure 23-9. Have Quick WOD Loading

- 5th Segment - 16 000.000 ENT
- 6th Segment - 15 000.000 ENT

The last segment (7th) is calendar day and is only two numbers (01 thru 31). After the calendar day is entered, the HQ WOD option changes to an unhighlighted border WOD LOAD. No data entry is available with WOD LOAD displayed. Touching the WOD LOAD option sends the word-of-day to the radio, the option changes back to an unhighlighted border HQ WOD touch option/display, and a tone sounds in the head set.

At any time during the data entry of the word- of-day, the border highlighted HQ WOD option may be used to cycle to the next segment without changing the current segment. If on the calendar day segment, touching HQ WOD cycles to WOD LOAD without changing the calendar day segment. The HQ WOD option remains border highlighted until WOD LOAD, HQ TIME, HQ VDAY or HQ TNET is selected. If HQ WOD data entry is exited before completion, the previously entered segments are maintained and are displayed in the scratchpad when HQ WOD entry is continued.

Selecting the RTN option returns the Have Quick MENU format to the Fixed Frequency Anti-Jam Menu format.

The HQ TNET option is used to manually enter the Have Quick 2 training nets (see figure 23-10). Touching the HQ TNET touch option/display border highlights this option and enables Have Quick 2 training net data entry by touching the desired numbers on the keypad options, verifying the frequency in the scratchpad, and then touching ENT. When the HQ TNET is first selected, 20 is displayed in the scratchpad followed by the first training net frequency. There are 16 training net frequencies identified by the numbers 20 thru 5. As each frequency is entered the number decrements thru 5. Trailing zeros need not be entered.

- 1st Segment - 20 000.000 ENT
 - 2nd Segment - 19 000.000 ENT
 - 3rd Segment - 18 000.000 ENT
-

- 14th Segment - 7 000.000 ENT
- 15th Segment - 6 000.000 ENT
- 16th Segment - 5 000.000 ENT

The valid training net frequencies are:

1. 30.000 thru 87.995 MHz (FM) - at increments of 0.025 MHz,
2. 108.000 thru 173.975 MHz (AM) - at increments of 0.025 MHz,
3. 225.000 thru 399.975 MHz (AM/FM) - at increments of 0.025 MHz.

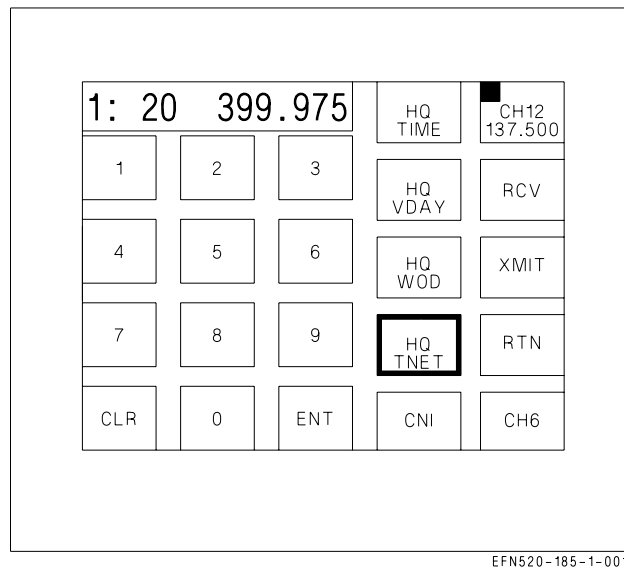

Figure 23-10. Have Quick TNET Loading

After the last training net frequency is entered, the HQ TNET option changes to an unhighlighted border TNET LOAD. No data entry is available with TNET LOAD displayed. Touching the TNET LOAD option sends the training net to the radio, the option changes back to an unhighlighted border HQ TNET touch option/display and a tone sounds in the head set.

At any time during the data entry of the training net, the border highlighted HQ TNET option may be used to cycle to the next frequency without changing the current frequency. If on the last training net frequency, touching HQ TNET cycles to TNET LOAD without changing the last training net frequency. The HQ TNET option remains border highlighted until TNET LOAD, HQ TIME, HQ VDAY or HQ WOD is selected. If HQ TNET data entry is exited before completion, the previously entered frequencies are maintained and are displayed in the scratchpad when HQ TNET entry is continued.

Selecting the RTN option returns the Have Quick MENU format to the Fixed Frequency Anti-Jam Menu format.

23.4.2 SINCGARS Menu From AJ Menu Fixed Frequency COMM Sublevel. Touching the SG MENU touch option/display while on the AJ COMM sublevel with a fixed frequency selects the Single Channel Ground and Airborne Radio System (SINCGARS) MENU fixed frequency sublevel (see figure 23-11). This sublevel initializes with no options selected and displays a 1: (selected radio) in the

scratchpad. This sublevel is used for SINGGARS coldstart operation. The SINGGARS coldstart operation is used for receiving or transmitting SINGGARS hopsets and locksets so a user can be added to the net. There is a 30 second time-out during option selections. The XMIT option is not displayed if ADF is enabled for the current radio.

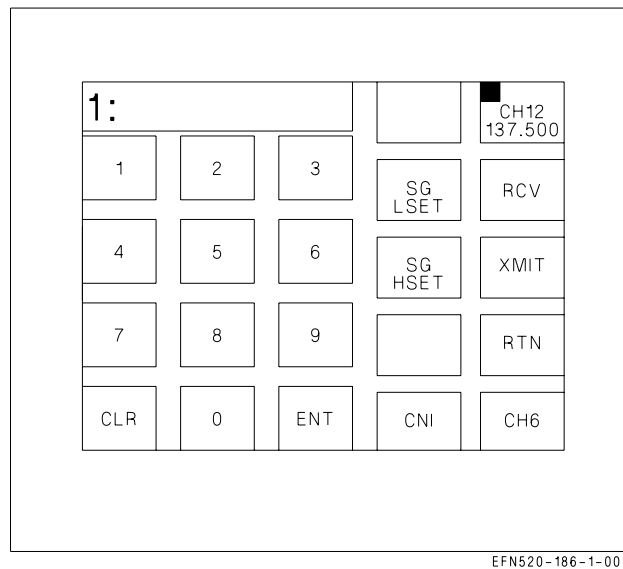

Figure 23-11. Single Channel Ground and Airborne Radio System (SINGGARS) MENU Fixed Frequency Sublevel

The SG LSET is used to enter the SINGGARS lockset for transmission or reception. Touching the SG LSET touch option/display border highlights the option and the last lockset is displayed in the scratchpad. The lockset may be changed by touching the desired number on the keypad options (1 thru 8), verifying the new lockset in the scratchpad, and touching ENT. With the desired lockset displayed in the scratchpad, the lockset is transmitted or received by touching the XMIT or RCV option. Touching the XMIT option transmits the new radio lockset and the option is border highlighted for 2 seconds. Touching the RCV option enables the radio to receive the lockset and the option remains border highlighted until the lockset is received.

Touching the SG HSET touch option/display border highlights the option and the last hopset is displayed in the scratchpad. The hopset may be changed by touching the desired number on the keypad options (1 thru 20), verifying the new hopset in the scratchpad, and touching ENT. With the desired hopset displayed in the scratchpad, the hopset is transmitted or received by touching the XMIT or RCV option. Touching the XMIT option transmits the new radio hopset and the option is border highlighted for 2 seconds. Touching the RCV option enables the radio to receive the hopset and the option remains border highlighted until the hopset is received. The XMIT and RCV options can not be selected at the same time.

Selecting the RTN option returns the SINGGARS MENU format to the Fixed Frequency Anti-Jam Menu format.

23.4.3 COMM Sublevel - Presets 1 Thru 20 (Anti-Jam). The Preset 1 thru 20 COMM Sublevel (Anti-Jam) is selected by touching the COMM 1 or 2 touch option/display while on preset channel 1 thru 20 and in Have Quick or SINGGARS anti-jam mode (see figure 23-12).

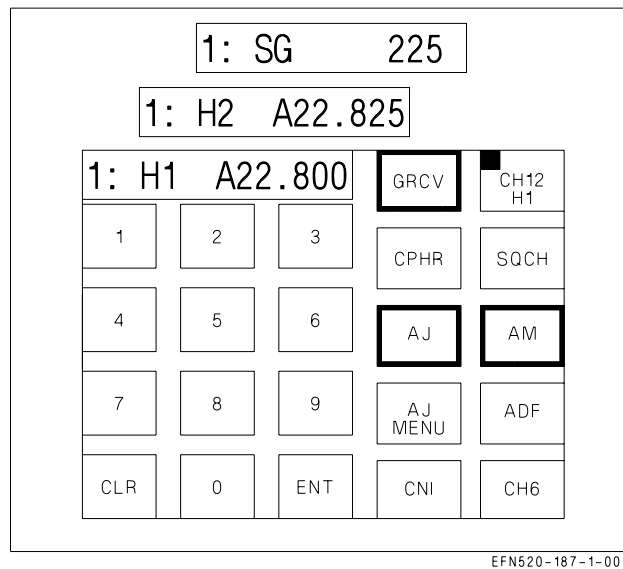

Figure 23-12. COMM Sublevel - Presets 1 to 20 (Anti-Jam)

In the Have Quick mode, this sublevel is used to change the net number, to enable or disable squelch, cipher mode, guard receive, or ADF operation; to select modulation type (AM or FM); or to access time receive and time transmit.

In the SINCGARS mode, this sublevel is used to enable or disable squelch, cipher mode, guard receive, or ADF operation; to access master selection; to enter late net selection; to enter time; and to transmit and receive hopsets and locksets. This sublevel, displays a 1: (selected radio) followed by H1 (Have Quick 1), H2 (Have Quick 2, or SG (SINCGARS)) and the net number. In Have Quick mode, the net number (00.000 thru 99.950) is changed by touching the desired numbers on the keypad options, verifying the new net number in the scratchpad, and touching ENT. The last two digits of the net number must be 00, 25 or 50. Trailing zeros need not be entered. If invalid data is entered, an error indication is displayed in the scratchpad. The SINCGARS net number cannot be changed at this sublevel.

SQCH (squelch), GRCV (guard receive), and ADF are enabled or disabled by touching the respective touch options/displays. An enabled option has a highlighted border. The AM/FM option is always border highlighted and toggles between AM and FM. If the current frequency is available only in AM or in FM, the AM/FM option is not displayed. While in the UHF AM mode, the cipher option cycles as follows: CPHR (no highlighted border-cipher disabled), CPHR (border highlighted-cipher baseband enabled), CPDP (border highlighted-cipher diphase enabled). The CPHR and CPDP options are mutually exclusive. Continued selection of this option repeats the above cycle. CPHR (both diphase and baseband) or ADF operation is available for only one radio at a time. Enabling CPHR or ADF on COMM 1 automatically disables CPHR or ADF on COMM 2 if it was previously enabled.

Enabling ADF automatically disables SQCH. SQCH may be enabled after selecting ADF by touching the SQCH option. However, if SQCH was not enabled after selecting ADF it is automatically enabled when ADF is disabled.

Touching the AJ option returns the selected radio to the COMM fixed frequency sublevel. This selection applies to all presets and all preset channels which now become fixed frequency.

Touching the AJ MENU option selects the Have Quick or SINGGARS menu sublevel depending on whether the current preset is defined as Have Quick or SINGGARS.

If the radio is in anti-jam mode but there is no valid data/waveform or time stored in the current radio for the current preset channel, the AJ option changes to AJ NO FILL (see figure 23-13). The AM/FM and AJ MENU options are not displayed when a NO FILL condition exists on the current preset channel. In this condition, an A is displayed in the scratchpad and a Have Quick net number may be entered.

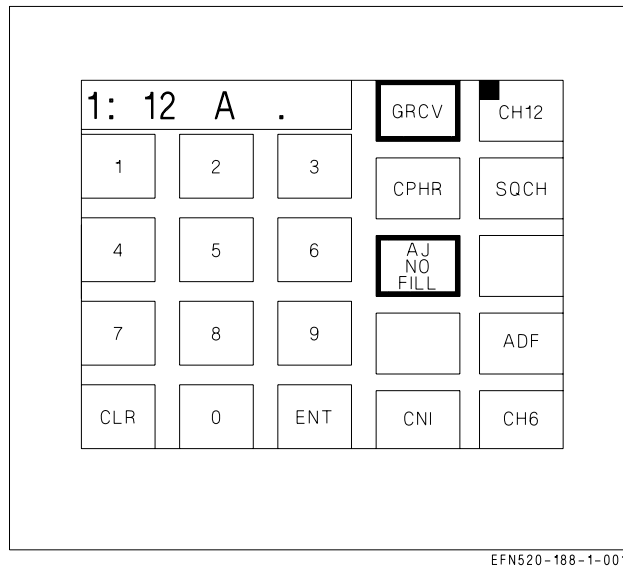

Figure 23-13. AJ MENU From Have Quick COMM Sublevel

23.4.4 AJ MENU From Have Quick COMM Sublevel. Touching the AJ MENU touch option/display while on the COMM sublevel with a Have Quick anti-jam mode selects the AJ Have Quick menu sublevel initialized with the HQ TIME option selected and border highlighted (see figure 23-14). This sublevel is used to transmit and receive Have Quick time. The scratchpad information is the same as scratchpad information on the Have Quick COMM sublevel.

The HQ TIME option is used to transmit or receive Have Quick time while the radio is operating on a Have Quick net. With the HQ TIME touch option/display border highlighted the option enables the use of the RCV and XMIT options. Touching the RCV touch option/display border highlights the RCV option until time is received or until 60 seconds have elapsed. Touching the XMIT touch option/display border highlights the XMIT option for 2 seconds and time is transmitted. The XMIT option is not displayed if ADF is enabled (for selected radio). Data entry is not available on this sublevel and the ENT option is Xed out.

Selecting the RTN option returns the format to the AJ COMM sublevel.

23.5 SINGGARS SYSTEM

The radio can be operated with SINGGARS, which provides jam resistant line-of-sight (LOS) voice communications in the VHF band employing frequency hopping. Established communication nets require a TOD that is coordinated and used by all net users. The system also contains encoded locksets

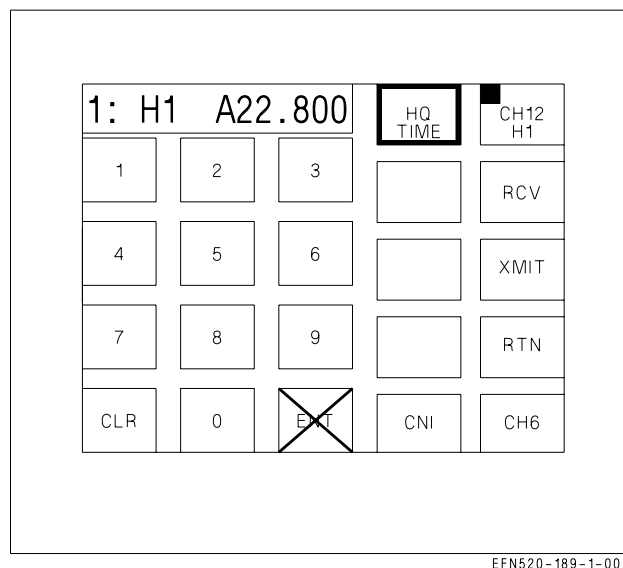

Figure 23-14. AJ Have Quick Menu Sublevel

and hopsets that define the set of frequencies that will be hopped on and will not be hopped on. The system can store multiple nets correlating to hopsets and locksets. The principle functions available for SINCGARS control are:

- a. SINCGARS mode (AJ) selection,
- b. time reception and transmission,
- c. late net entry,
- d. electronic remote fill (ERF),
- e. cue operation,
- f. coldstart.

23.5.1 AJ MENU From SINCGARS COMM Sublevel. Touching the AJ MENU touch option/display while on the COMM sublevel with a SINCGARS anti-jam mode selects the AJ SINCGARS menu sublevel (see figure 23-15) and may initialize with the MSTR option or LATE ENTRY option selected, or no options selected. This sublevel is used to select MSTR (master operation), to select LATE ENTRY (late entry operation), to enter time, and to transmit and receive hopsets and locksets.

The MSTR option is used to select master control of the net. Automatic time synchronization is achieved by each of the net radios every time a transmission is received from the master. If the MSTR option is border highlighted, master control of the net is enabled. If MSTR is not border highlighted, master control of the net is disabled. The MSTR option toggles between control and no control.

The TIME option is used to enter time. Each user can enter the SINCGARS time. The time can be used by the master to synchronize the rest of the net or to get on the net using late entry. Touching the TIME option/display border highlights this option, a D, H, and M is displayed in the scratchpad, and time data entry is enabled. The time may be entered in D (day), H (hour) and M (month) format by

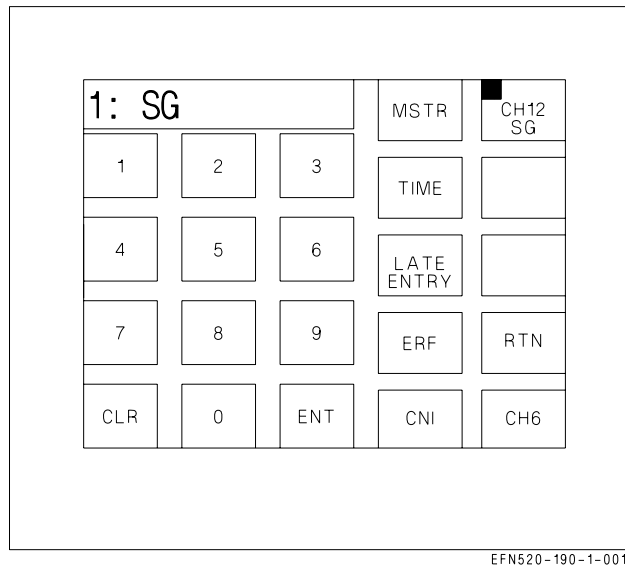

Figure 23-15. AJ MENU From SINGARS COMM Sublevel

touching the desired number on the keypad options, verifying the new time in the scratchpad and touching ENT. Trailing zeros need not be entered. If invalid data is entered, ERROR is displayed in the scratchpad.

The LATE ENTRY is used to gain late entry into the net. Touching the LATE ENTRY option/display border highlights the option and enables late entry into the SINGARS net. This option remains border highlighted until time synchronization into the net is achieved.

Touching the ERF (Electronic Remote Fill) option selects the AJ SINGARS ERF sublevel (see figure 23-16). ERF allows the system to be filled electronically over the air by another net user who has the required net data (hopsets/locksets). The net user can either provide or receive the net data. The

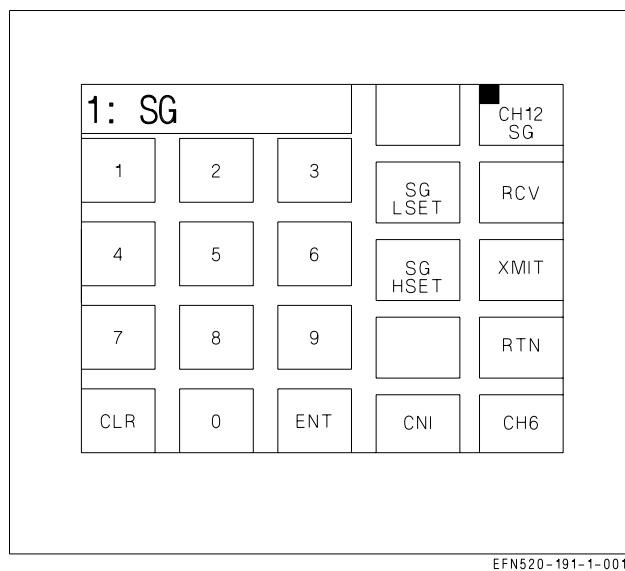

Figure 23-16. AJ SINGARS ERF Sublevel

desired hopset/lockset can be selected one at a time for either transmission or reception. The process is repeated until all desired sets are transmitted/received. This sublevel initializes with no options selected and displays a 1: (selected radio) in the scratchpad. This sublevel is used for SINGGARS coldstart operation. The SINGGARS coldstart operation is used for receiving or transmitting SINGGARS hopsets and locksets so a user can be added to the net. There is no 30 second time-out during option selections. The XMIT option is not displayed if ADF is enabled for the current radio.

The SG LSET is used to enter the SINGGARS lockset for transmission or reception. Touching the SG LSET touch option/display border highlights the option and the last lockset is displayed in the scratchpad. The lockset may be changed by touching the desired number on the keypad options (1 thru 8), verifying the new lockset in the scratchpad, and touching ENT. With the desired lockset displayed in the scratchpad, the lockset is transmitted or received by touching the XMIT or RCV option. Touching the XMIT option transmits the new radio lockset and the option is border highlighted for 2 seconds. Touching the RCV option enables the radio to receive the lockset and the option remains border highlighted until the lockset is received.

Touching the SG HSET touch option/display border highlights the option and the last hopset is displayed in the scratchpad. The hopset may be changed by touching the desired number on the keypad options (1 thru 20), verifying the new hopset in the scratchpad, and touching ENT. With the desired hopset displayed in the scratchpad, the hopset is transmitted or received by touching the XMIT or RCV option. Touching the XMIT option transmits the new radio hopset and the option is border highlighted for 2 seconds. Touching the RCV option enables the radio to receive the hopset and the option remains border highlighted until the hopset is received. The XMIT and RCV options can not be selected at the same time.

Selecting the RTN option returns the AJ SINGGARS ERF format to the AJ SINGGARS menu sublevel. Selecting the RTN option again returns the AJ SINGGARS menu sublevel to the COMM sublevel that is in the SINGGARS AJ mode.

23.5.2 Guard Transmit on Top Level CNI Format. On the top level CNI format, placing the COMM G XMT switch on the ACI panel to 1 or 2 selects guard transmit for that radio and GXMT replaces the COMM touch option/display (see figure 23-17). The COMM sublevel also displays GXMT in the scratchpad (see figure 23-18).

23.6 KY-58 - SECURE SPEECH SYSTEM

The secure speech system is used for ciphering (coding) or deciphering (decoding) audio routed through the COMM 1 and COMM 2 receiver-transmitters. The system consists primarily of the KY-58 control panel assembly on the right console. Controls and indicators are on the KY-58 control panel assembly and on the COMM control panel on the left console.

23.6.1 KY-58 Control Panel Assembly. The control panel assembly functions as a ciphering or deciphering device for secure speech operation.

23.6.1.1 Ciphred Transmission. During ciphred transmissions, audio from the microphone is routed through the COMM control panel to the KY-58 control panel assembly where it is enciphered. The enciphered audio is routed back to the COMM control panel, then to COMM 1 or COMM 2 receiver-transmitter for transmission.

23.6.1.2 Ciphred Reception. During reception of ciphred information, the ciphred audio is routed from the COMM 1 or COMM 2 receiver-transmitter to the COMM control panel, then to the

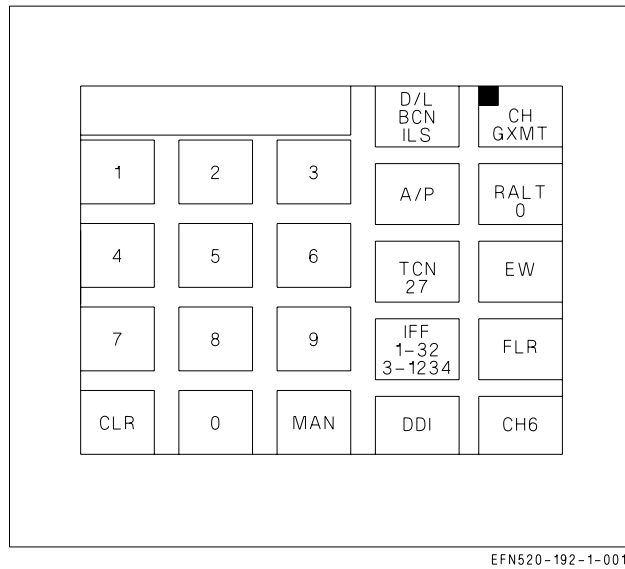

Figure 23-17. Guard Transmit on Top Level CNI Format

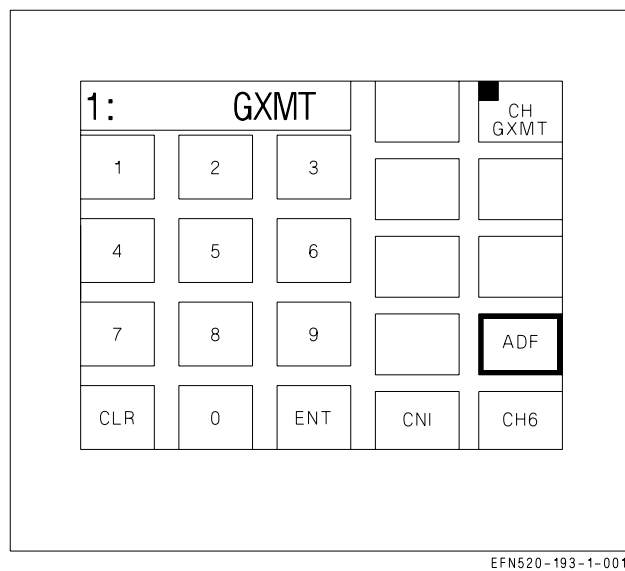

Figure 23-18. Guard Transmit on COMM Sublevel

control panel assembly for deciphering. Deciphered audio is routed to the COMM control panel and the headset.

23.6.1.3 Ciphred Relay Mode. During ciphred relay mode of operation, ciphred information received on one radio is routed from the radio, through the COMM control panel to the second radio for transmission. Ciphred information received on the first radio is also routed through the COMM control panel to the KY-58 control panel assembly for deciphering. Deciphered audio is routed through the COMM control panel to the headset. This enables the crewmember to hear deciphered relayed audio in the ciphred relay mode. When cipher is selected on the COMM control panel immediately after operating in relay plain, COMM 1 plain, or COMM 2 plain mode of operation, the crewmember must press the transmit key for either COMM 1 or COMM 2 two times to enable ciphred relay

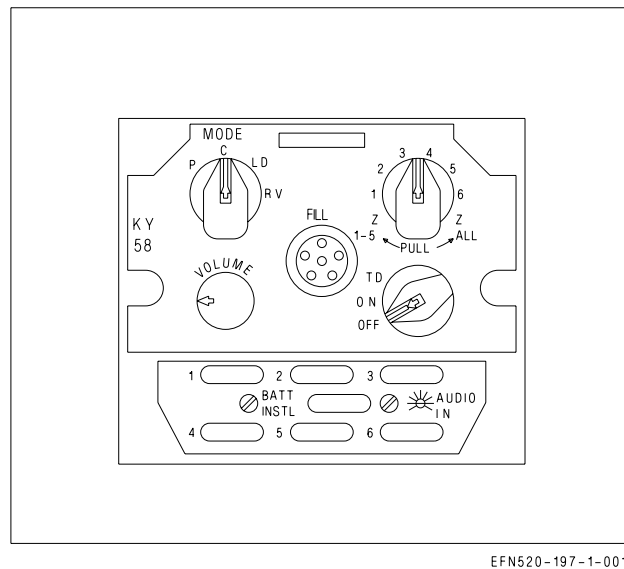

Figure 23-19. KY-58 Control Panel Assembly

operations. When the relay aircraft is operating both radios within the same bandwidth, the two frequency selections must be separated by a minimum of 10 MHz.

23.6.2 KY-58 Controls and Indicators. The only cipher control on the COMM control panel is the RLY CIPHER/PLAIN switch (relay switch). The controls on the KY-58 control panel assembly are the MODE select knob, unlabeled fill select knob, VOLUME control knob, and the unlabeled power select knob (see figure 23-19).

23.6.2.1 KY-58 Mode Select Knob. The mode select knob has positions of P, C, LD, and RV. Placing the knob to P enables plain mode of operation. Placing the knob to C enables the cipher mode of operation. With the knob set to LD the load mode of operation is enabled. This mode is used for loading data into the KY-58 control panel assembly. Information pertaining to the RV knob position (receiver variable) will be supplied later.

23.6.2.2 KY-58 Fill Select Knob. The fill select knob has positions of 1 thru 6, a Z 1-5 position, and a Z ALL position. Setting the knob to one of the six positions selects the position to be loaded with data. Placing the knob to Z 1-5 zeroizes data in positions 1 thru 5. Placing the knob to Z ALL zeroizes all data in positions 1 thru 6.

23.6.2.3 KY-58 Volume Control Knob. The volume control knob adjusts the volume of the KY-58 control panel assembly audio. The volume control knob should be set to full volume position during secure voice transmission and reception.

23.6.2.4 KY-58 Power Knob. This knob has positions of ON, OFF, and TD. Placing the knob to ON turns on power to the KY-58 control panel assembly if cipher mode has been selected. Placing the knob to OFF removes power to the system. With the knob in TD, power is turned on for the system if cipher mode has been selected and a time delay is selected for data processing. The knob must be in the TD position for ciphered relay operations.

23.6.3 KY-58 Operation. Other stations or aircraft involved in cipher or cipher relay communication must be in either the baseband or diphas mode.

1. COMM 1 and COMM 2 radios - ON
COMM 1 and COMM 2 radios are turned on and volume adjusted with the VOL 1 and 2 COMM control knobs on the UFCD.
2. COMM 1 and COMM 2 channels - AS DESIRED
 - a. COMM 1 and COMM 2 channel select knobs - ROTATE (to select desired channel).
Selected channel is displayed in COMM 1 and 2 touch option/display on the UFCD.
3. COMM 1 and COMM 2 channel frequency - SET
 - a. COMM 1 and COMM 2 touch option/display - TOUCH
Channel number and frequency displayed in scratchpad GRCV, SQCH, and CPHR options appear on the option/display.
 - b. Channel frequency - AS DESIRED
Enter new frequency with keypad. Press the ENT key to enter the new frequency.
4. CPHR touch option/display - TOUCH
The CPHR touch option/display is border highlighted and a series of tones are heard for 3 seconds indicating cipher is enabled with baseband operation. Touching the CPHR touch option/display again changes the display to CPDP with the border highlighted and enables cipher diphas mode.

23.6.3.1 KY-58 Cipher Mode. Other stations or aircraft involved in cipher communication must have the KY-58 fill select knob in the same position.

1. KY-58 power knob - ON
2. KY-58 MODE knob - C
3. KY-58 VOLUME knob - ADJUST TO MAX VOLUME
4. COMM switch on inboard throttle - ACTUATE
UP for COMM 1, DOWN for COMM 2. A short tone is heard in the headset.

23.6.3.2 KY-58 Relay Mode. Relay mode can operate in Plain, Cipher and ECCM mode. Other stations or aircraft involved in cipher relay communication must have the KY-58 fill select knob in the same position.

1. KY-58 power knob - TD
Other stations or aircraft involved in cipher relay communication must have the KY-58 power knob in the TD position.
2. KY-58 MODE knob - C
3. KY-58 VOLUME knob - ADJUST TO MAX VOLUME
4. COMM 1 antenna select switch - AUTO

5. Relay switch select - CIPHER
6. COMM switch on inboard throttle - ACTUATE
UP for COMM 1, DOWN for COMM 2. A short tone is heard in the headset.

NOTE

When entering the cipher relay mode from any plain mode, the COMM 1/COMM 2 transmit switch must be keyed twice; once to initialize the KY-58 and a second time to transmit.

23.7 DIGITAL COMMUNICATION SYSTEM (DCS)

DCS provides all of the standard voice communication capabilities of earlier ARC-210 radios, plus a digital data mode that greatly reduces pilot workload during Close Air Support (CAS) missions. It enables the pilot to receive 9 line briefs, communicates target and mission data digitally from the Forward Air Controller (FAC), and provides the capability to feed this information to weapon targeting and navigation systems. Currently, this mission is handled via verbal communication and manual data entry. A new communication control panel, incorporated with the Multifunctional Information Distribution System (MIDS), is needed to interface with the DCS.

In the frequency range of 118.000 through 136.975 MHz, the DCS can be tuned to 8.3 KHz channels to facilitate air traffic control communications in European air space. Tuning the radio to these frequencies is performed via the UFCD as in any other band. In this band, however, the entered frequency is not the actual tuned RF frequency. Refer to figure 23-20 for the convention adopted by the International Civil Aviation Organization (ICAO).

Actual RF Frequency (MHz)	UFCD Frequency (MHz)	Channel BW (KHz)
118.0000	118.000	25
118.0000	118.005	8.3
118.0083	118.010	8.3
118.0166	118.015	8.3
118.0250	118.020	25
118.0250	118.025	25
118.2500	118.030	8.3
118.0333	118.035	8.3
118.0416	118.040	8.3
118.0450	118.045	25
118.0500	118.050	25
118.0500 thru 136.9750	118.55 thru 136.975	8.3 or 25

Figure 23-20. DCS Frequencies Conversions

23.7.1 VHF/UHF Communication System - DCS. The aircraft voice communications system consists of an ARC-210 radio (COMM 1), a ARC-210/DCS radio (COMM 2), and KY-58 Secure Speech

Equipment. DCS provides its own integrated secure speech encoder/decoder which allows COMM 1 and COMM 2 radios to simultaneously operate in cipher mode.

NOTE

The aircraft COMM 2 radio can also be installed with an ARC-210. In this configuration, the KY-58 is shared between COMM 1 and COMM 2 as in earlier aircraft.

When operating the COMM 2 radio (either ARC-210 or DCS) in a band that allows selecting AM or FM, make sure the modulation is selected before the frequency is entered. Failure to do this may not allow the selected modulation to be accepted into memory.

23.7.1.1 ARC-210/DCS. DCS has additional capabilities which do not exist in the ARC-210. One such capability is two-way digital data communications using Variable Message Format (VMF) for the CAS mission. Another is storage of the cryptographic keys COMSEC communications. Finally, 8.3 KHz channel spacing is provided in the 118.00 through 136.975 MHz for Air Traffic Control (ATC) communications required in European airspace.

23.7.1.1.1 COMM 1 and COMM 2 Volume Controls. The volume of the COMM 1 and COMM 2 radios is controlled by volume controls on the UFC.

23.7.2 DCS COMSEC (Communications Security).

23.7.2.1 Operation. During ciphered transmissions, audio from the aircrew's microphone is routed through the ACI panel to the DCS where it is encrypted. During reception of ciphered information, the ciphered audio is deciphered by the DCS. The deciphered audio is routed back through the ACI panel to the aircrew's headset.

23.7.2.2 DDI Controls. Control of the internal DCS cryptographic functions is performed via the DCS KEY display from the UFC. The DCS KEY display is accessed by selecting DCS on the SUPT menu, then selecting DCSKY on the NETS (network) display. See figure 23-21. The functions displayed are crypto keys (KEY1 thru KEY6) and TD (time delay). In F/A-18F aircraft, if one cockpit has the DCS KEY display accessed, the other cockpit can access it by selecting only DCS on the SUPT menu.

23.7.2.2.1 TD Control. The time delay mode is enabled by selecting/boxing TD on the DCS KEY display. A subsequent selection disables time delay and removes the box. The effect of enabling time delay mode does not take place until CPHR or CPDP has been selected via the UFC.

23.7.2.2.2 Crypto Key Options. There are six available crypto keys. For example, if KEY1 is loaded with crypto key data, the option KEY1 appears on the display. If a crypto key has not been loaded with data, that key option is not displayed. A selected crypto key is indicated with a box around the corresponding option. Only one crypto key may be selected at a time.

The DCS KEY display initializes to the previously selected crypto key. If the last crypto key selected has been zeroed, the system selects the next available loaded crypto key. The DCS KEY display defaults with KEY1 selected.

If CPHR or CPDP is selected and the normal default crypto key has been zeroized, NO FILL is displayed on the UFC scratchpad. When the DCS KEY display is selected, NO FILL is removed from

the scratchpad. If no crypto keys are loaded, no crypto key options are displayed and a NO KEYS status appears.

If CPHR or CPDP is selected prior to entering the DCS KEY display, an additional DCS COMSEC status check is performed upon selection of a crypto key. This check takes approximately 1.5 to 2 seconds. If the DCS COMSEC function is operational there is no change on the DCS KEY display. The boxed option with the CIPHER ON status indicator means the selected key is valid for use and DCS COMSEC is operational.

If the status check determines there is a problem with the COMSEC function, the selected/boxed crypto key option is Xd and a DCSCS advisory appears. However, it is possible the DCS COMSEC function may be operational with other loaded crypto key options. Each crypto key option would have to be selected (in CPHR or CPDP mode) to determine if the DCS COMSEC function is inoperable.

An Xd crypto key option may still be selected. If it is selected and the COMSEC error is no longer indicated, the X is removed. All Xd status indications are cleared upon MC power-up.

If there is a problem with the DCS/COMSEC function, the boxed crypto key variable is covered by an X. This indicates that DCS COMSEC function is inoperable with the selected crypto key. This does not rule out the possibility the DCS COMSEC function may be operational with the other loaded crypto keys. Each of the other crypto keys would have to be selected while in cipher or cipher diphas modes before it could be determined the DCS COMSEC function is completely inoperable.

When a crypto key is unavailable and the applicable COMM switch is activated, a continuous audio tone is heard in the headset.

23.7.3 UFCD - DCS. For normal UFCD operations, refer to Part 1, Chapter 2, or Part 7, Chapter 23.

23.7.3.1 ZEROIZE Function. Zeroization of DCS and KY-58 COMSEC KEYS, as well as TRANSEC KEYS including HQ WODs (HAVE QUICK word of day) and SINCGARS EP (electronic protection), is accomplished using the UFCD. The selection of the ZERO option causes the display to change to ZERO ALL ENABLE, and clears the COMSEC and TRANSEC KEYS in the radios and KY-58. Both COMSEC and TRANSEC KEYS are also zeroized upon pilot ejection. The ZERO ALL ENABLE option is border highlighted for two seconds, and then the option returns to displaying ZERO. While the ZERO ALL ENABLE option is displayed, selecting any option other than ZERO ALL ENABLE causes the option to return to ZERO.

NOTE

The ACI panel IFF emergency switch no longer zeroizes the radios.

The DCS has an internal battery which is used to maintain the COMSEC KEYS in radio memory during aircraft power transients and when aircraft power is removed. It also provides the energy to zeroize the radio when the pilot ejects or if the radio is removed from the aircraft.

23.7.4 Relay Mode Of Operation. During cipher relay mode of operation using a DCS and an ARC-210, encrypted information received on one radio is routed through the ACI panel to the second radio for transmission. The encrypted information received on the first radio is also routed through the ACI panel to the KY-58 for deciphering. The decrypted audio is routed back to the ACI panel, then to the aircrew's headset.

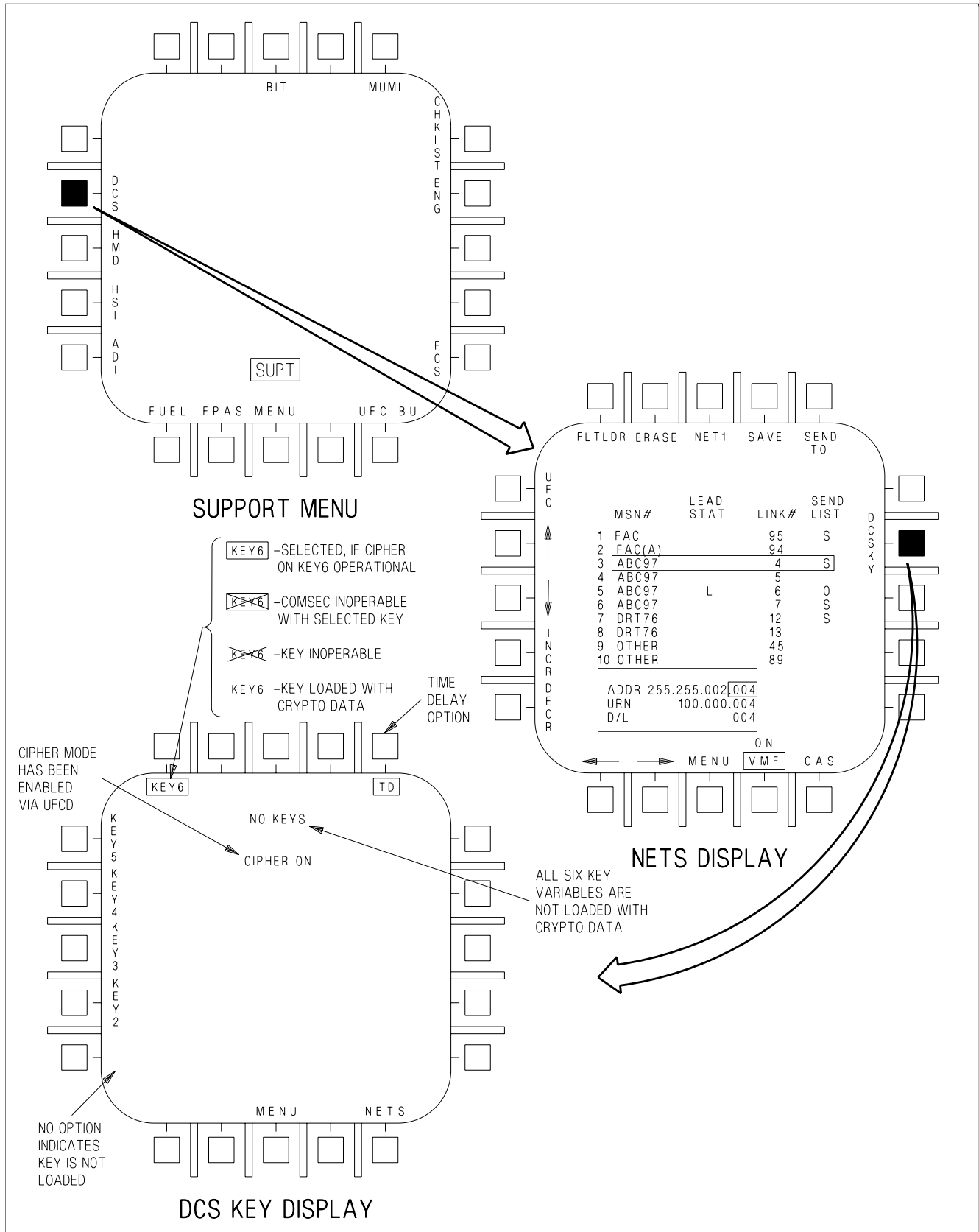

Figure 23-21. DCS KEY Display

EFN520-348-1-003

The DCS COMSEC functions are not utilized during the cipher relay mode. In this mode the DCS is always commanded to the plain voice mode, and all crypto relay transmissions are encrypted/decrypted by the KY-58.

Certain constraints apply if cipher relay is selected and ADF bearing is needed. Cipher relay mode may not be selected if ADF is already selected on COMM 2 (DCS). If ADF is selected on COMM 2 after cipher relay mode has been enabled, COMM 2 ADF and cipher relay mode must be disabled before control of DCS plain/CPHR/CHDP modes can be returned to COMM 2. If COMM 2 is an ARC-210, the above constraints do not apply.

Cipher relay operation must be performed within the COMM 1 and COMM 2 relay band limitations outlined in figure 23-22.

NOTE

With CPHR or CPDP enabled, selection of PLAIN on the RLY selector switch (ACI panel) does not activate plain relay mode.

REMOTE	RELAY AIRCRAFT		REMOTE
STATION 1 OR 2	COMM 1	COMM 2	STATION 2 OR 1
A	*A	*A	A
B	*B	*B	B
C	*C	*C	C
D	*D	*D	D
E	*E	*E	E
A	A	C	C
C	C	A	A
A	A	D	D
D	D	A	A
C	C	D	D
D	D	C	C
B	B	E	E
E	E	B	B

- A - 30.000 MHz to 87.975 MHz
- B - 118.000 MHz to 155.975 MHz
- C - 156.000 MHz to 173.975 MHz
- D - 225.000 MHz to 399.975 MHz
- E - 225.000 MHz to 399.975 MHz

* - When the relay aircraft is operating both radios within the same band, the two frequency selections must be separated by a minimum of 10 MHz.

NOTE: Both remote stations and the relay aircraft must have the KY-58 power knob in the TD positions.

Figure 23-22. Relay Bandwidth Limitations

23.7.5 DCS - Avionics Subsystem.

23.7.5.1 Mission Computer System. Channels 2 and 4 link the mission computer to DCS.

23.7.5.1.1 Mission Initialization. The AMU provides the capability to load the following mission initialization files: COMM, DCS CAS, DCS NETS, and WYPT S/S. The COMM file contains the radio presets, HAVE QUICK and SINGGARS data. The DCS CAS file contains pre-planned VMF FTXT (free text) messages, pre-planned VMF 9-line brief messages, and an empty data file reserved for inflight received CAS and/or FTXT messages. The DCS NETS file contains a set of network parameters to be used for a unique network environment used in VMF message communications. The WYPT S/S file contains a list of waypoint names for the IP (initial point) and control points that are either entered or received in CAS 9-line briefs. See figure 23-23.

23.7.5.2 Status Monitoring.

23.7.5.2.1 Cautions and Advisories. DCS has the ability to trigger eight advisory messages; COM1H(2H), COM1S(2S), COM1L(2L), BIT and DCSCS. COM1H(2H) is triggered when HAVE QUICK time is not loaded. COM1S(2S) is triggered when SINGGARS time is not loaded. COM1L(2L) advisory is triggered by an error in the MC to radio data loading process. BIT is triggered when a failure is detected by BIT. DCSCS is triggered when a COMSEC failure is detected.

23.7.5.2.2 BIT Top Level Display. The top level BIT display for DCS is the same as the COM2 format. Status is indicated for DCS as COMM2. See figure 23-24.

23.7.5.2.3 COMM BIT Sub-Level Display. The COMM sub-level BIT display appears when the COMM option on the top level BIT display is selected. The COMM BIT display for DCS is the same as the ARC-210 with the DCS being represented as COM2.

a. DCS Option. Initiated BIT is run by selecting the COM2 option. DCS status is displayed in the center of the page represented as COM2.

23.7.5.2.4 Software Configuration. The software configuration for the DCS is checked by selecting CONFIG on the top level BIT display.

23.8 IDENTIFICATION FRIEND OR FOE (IFF)/COMBINED INTERROGATOR TRANSPONDER (CIT)

The AN/APX-111 CIT is a dual purpose Identification Friend or Foe (IFF) system with transponder and interrogator capabilities. The transponder provides automatic identification of the aircraft in which it is installed when challenged by a surface or airborne interrogator set and provides momentary identification of position (I/P) upon request. The interrogator provides airborne target identification capabilities.

23.8.1 IFF Transponder. The transponder system operates in Modes 1, 2, 3, 4A, 4B, C and S. Modes 1, 2, and 3 are selective identification feature (SIF) modes. Modes 4A and 4B are the crypto modes. Mode C is the altitude reporting mode. Mode S is used in conjunction with the Civil Air Traffic Control Surveillance System and is only available with MC OFP H4E AND UP.

With the IFF Programming (IFF PROG) page: A) Mode 1, 2, and 3 codes can be automatically programmed to change at specified times or on a time interval, B) Mode 1, 2, 3, 4, C, and S can be automatically programmed to enable/disable when the aircraft crosses a designated waypoint in a specified direction, and C) Mode 4 can be automatically updated on Zulu day transition. The IFF can also be programmed during mission planning.

The IFF emergency mode automatically becomes active upon ejection or can be manually selected with the IFF MASTER switch.

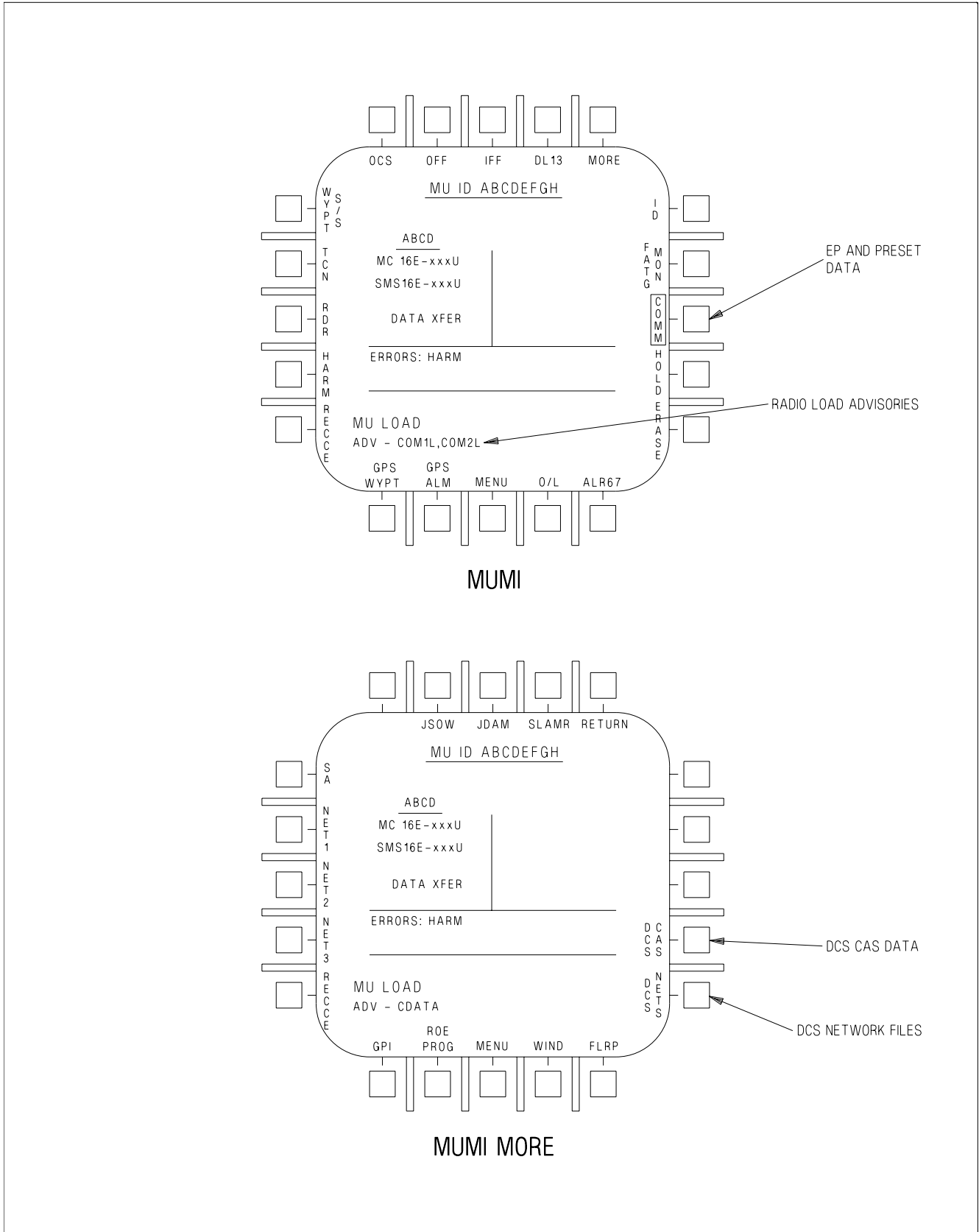
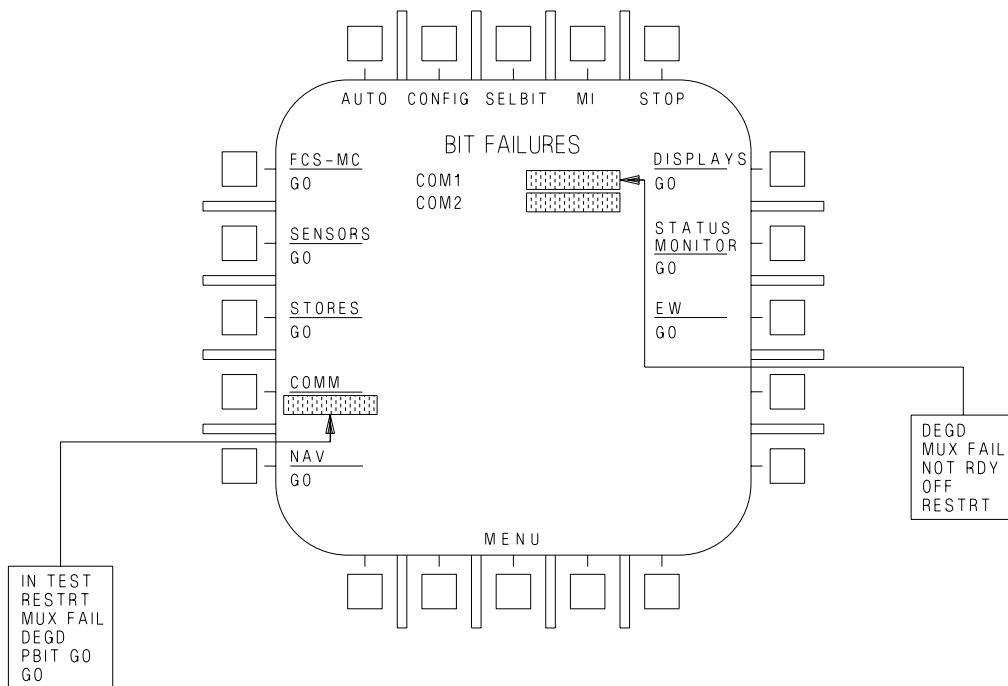

Figure 23-23. MUMI Displays

EFN520-360-1-003



TOP LEVEL BIT DISPLAY

INITIATES BIT ON THE FOLLOWING EQUIPMENT:
 CSC, COM1, DCS, D/L, ICS, IFF
 (CSC IBIT IS NOT INITIATED INFLIGHT)

CSC IS ONLY DISPLAYED
 IF A WEIGHT-ON-WHEELS
 CONDITION EXISTS

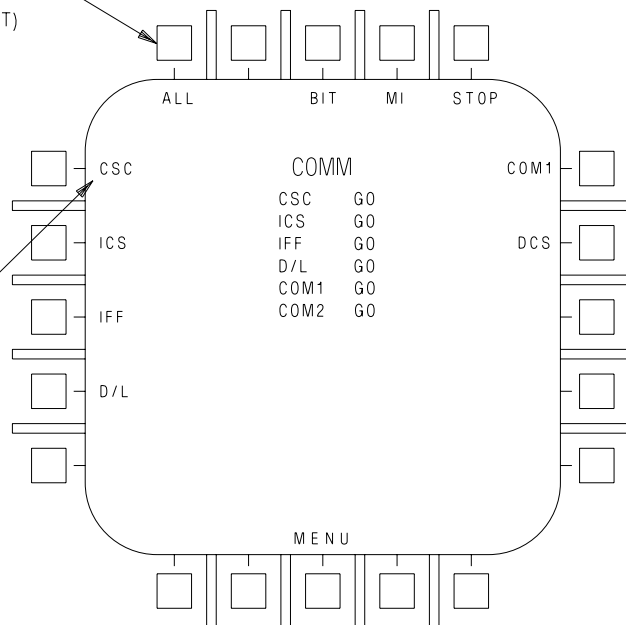

COMM BIT SUB-LEVEL DISPLAY

Figure 23-24. BIT Displays

EFN520-355-1-003

23.8.1.1 IFF on Top Level CNI UFCD Format. On the top level CNI UFCD format, IFF power application is identified by a corner highlight in the upper left corner of the IFF option. The option displays the current Mode 1 and Mode 3 codes regardless of whether the IFF is powered or whether the mode is enabled. The Mode 1 code may be changed by selecting two valid numbers (first digit equal to 0–7, second digit equal to 0–3) and selecting the IFF option. Mode 2 and Mode 3 codes may be changed by selecting four valid numbers (each digit equal to 0–7) and selecting the IFF option.

23.8.1.2 IFF Transponder UFCD Sublevel. The IFF Transponder (XPOND) UFCD sublevel is displayed by selecting the IFF option before entering any data in the scratchpad (figure 23–25). This sublevel is used to control power to the IFF system, to enable the transponder modes, to set Mode 1, 2, and 3 codes, to select Mode 4A or 4B, to view Mode S status, to set the temporary Mode S address, and to select the Mode S sublevel. (See 23.8.1.2.1 for Mode S operation.)

The IFF is on when the ON/OFF option is corner highlighted and displays ON. The IFF system is off when the option is not corner highlighted and displays OFF.

The Mode 1, 2, 3, C, 4A/4B options are border highlighted when selected for enable. A mode option without a border highlighted is not selected for enable. Modes 1, 2, 3 and C may be selected for enable or disable when the IFF system is either on or off. The IFF must be on to select Modes 4A or 4B. Any mode that is border highlighted with the IFF system on is immediately enabled; any mode that is border highlighted with the IFF system off is automatically enabled when the IFF system is turned on.

Modes 1, 2, and 3 are enabled and disabled by selecting the respective option. Mode C can not be enabled without Mode 3 enabled, so enabling Mode C automatically enables Mode 3 and disabling Mode 3 automatically disables Mode C. With MC OFP H4E AND UP, Mode 3 and Mode C are combined as one option, so when neither Mode 3 nor Mode C is enabled, selecting the Mode 3/C option results in the following sequence: both Mode 3 and Mode C enabled – Mode 3 enabled and Mode C disabled – both Mode 3 and Mode C disabled (figure 23–26). The altitude encoding mode uses 29.92 inches Hg as a reference. When the KIV–6 is installed and the IFF is on, Mode 4A or Mode 4B can be enabled. Selecting the Mode 4A option results in the following sequence: Mode 4A enabled – Mode 4A disabled and legend changes to 4B – Mode 4B enabled – Mode 4B disabled and legend changes to 4A. If the KIV–6 is not installed or the IFF is off, the Mode 4A/4B option is not displayed.

The Mode 1 code may be changed by selecting two valid numbers (first digit equal to 0–7, second digit equal to 0–3) and selecting the Mode 1 option. The Mode 2 and 3 codes may be changed by selecting four valid numbers (each digit equal to 0–7) and selecting the respective Mode option.

23.8.1.2.1 Mode S (MC OFP H4E AND UP). Mode S is a Civil Air Traffic Control Surveillance System that can respond to selective interrogations and provide air-to-air and air-to-ground data of aircraft ID, state, and intent information. The carriage and operation of Mode S Elementary Surveillance functionality applies to aircraft that fly Instrument Flight Rules (IFR) and Visual Flight Rules (VFR) flights in Mode S designated airspace.

The integration of Mode S Level 2 into Navy aircraft is divided into two surveillance levels, Elementary (EL) and Enhanced (EN). It is beneficial to air traffic control to incorporate Enhanced Surveillance to the extent practical on all Navy aircraft and to populate Enhanced Surveillance data parameters to the extent permitted by existing aircraft sensors. As a result of the requirements, Elementary Mode S is incorporated via a software modification to the CIT system. The system provides most of the functionality of Enhanced Mode S, but for flight planning purposes only Elementary Mode S is supported.

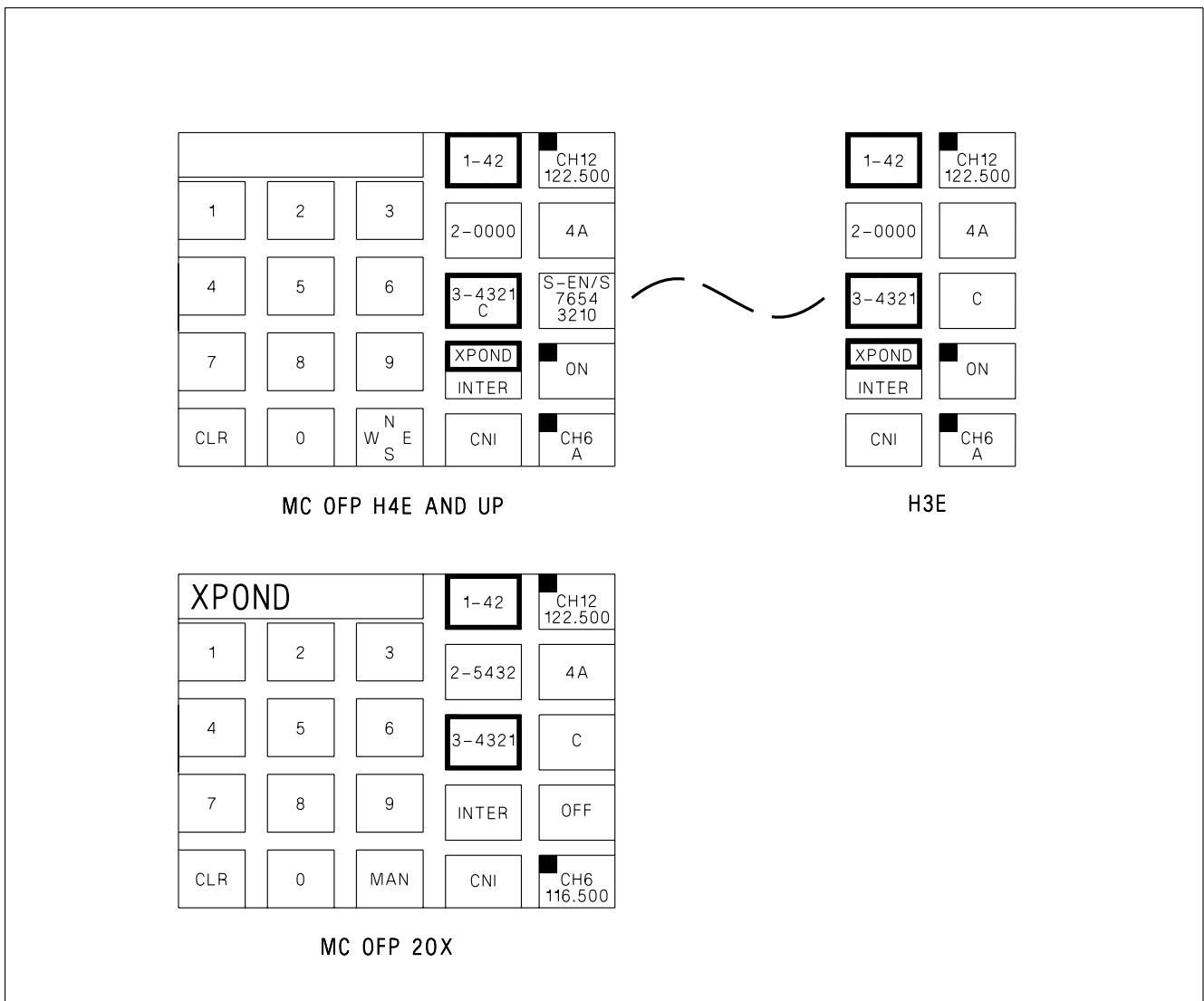

EFN520-194-1-018

Figure 23-25. IFF Transponder UFCD Sublevel

When Elementary Surveillance is selected, the aircraft transmits the following data:

1. 24 bit aircraft address
2. Secondary Surveillance Radar (SSR) Mode 3/A
3. Aircraft Identification (call sign used in flight)
4. Transponder Capability Report
5. Altitude reporting in 100 ft intervals
6. Flight Status (airborne/on ground)

When Enhanced Surveillance is selected, the aircraft transmits the following data:

1. Elementary Surveillance data
2. Magnetic Heading
3. Indicated Airspeed

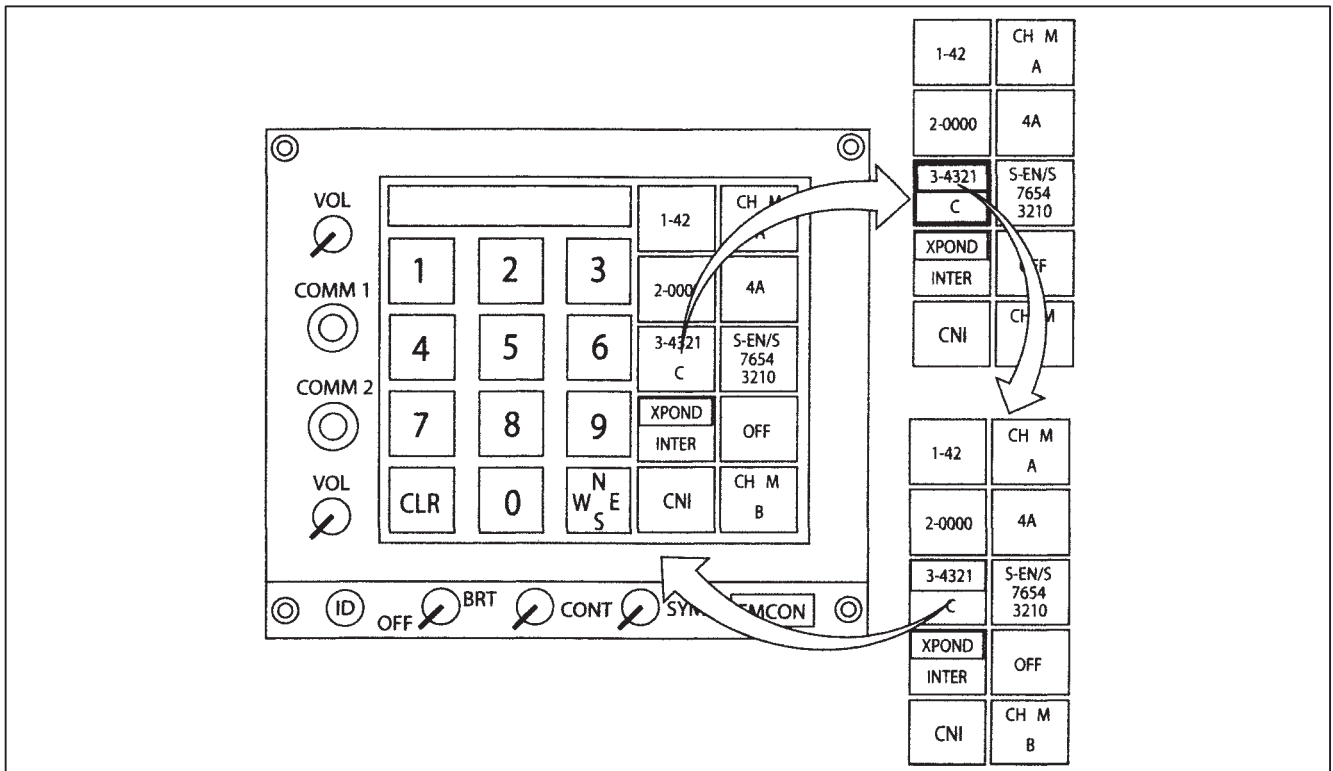

EFN520-428-1-01E

Figure 23-26. Mode 3 and Mode C Selection

4. Mach No.
5. Vertical Rate
6. Roll Angle
7. Track Angle Rate
8. True Track Angle
9. Ground Speed

All Mode S equipped aircraft have a permanent Mode S address which is assigned to the aircraft BuNo. The permanent address is stored in DFIRS. A temporary Mode S address may also be used. When available, the temporary address overrides the permanent address. Once a temporary Mode S address has been entered, to revert back to the permanent Mode S address, it is necessary to enter the permanent address as a temporary address.

WARNING

The use of the same Mode S address in any two airborne aircraft presents a safety of flight risk as air traffic computers cannot differentiate between the two aircraft.

The MC requests the permanent Mode S address from DFIRS when Mode S is enabled and a temporary Mode S address is not available. The permanent address is displayed on the Electronic Boresight Constant (EBC) Entry sublevel when available with WonW. This is where the aircraft BuNo

and permanent address can be entered by maintainers prior to flight. Figure 23–27 demonstrates the path to the EBC to verify the BuNo and permanent address.

NOTE

If ERROR flashing persists with attempts to enter a valid address, this indicates a DFIRS malfunction.

The Mode S transponder transmits acquisition squitters (unsolicited transponder replies) to permit passive acquisition by interrogators. The acquisition squitter function is disabled if Mode S is turned off.

Prior to takeoff, the aircrew can check the availability/status of Mode S, Mode S acquisition squitter, permanent Mode S address, temporary Mode S address, and aircraft call sign. The aircrew can enter an A/C call sign if desired or if mission planning does not provide one. The default A/C call sign contains VV followed by the aircraft's BuNo.

Mode S and the acquisition squitter function in the same manner during dual and single MC operation. In the event that power is removed from both MC1 and MC2, Mode S data ages out. The CIT continues to provide Mode S transmissions in Level 1 mode, providing the Mode S address at a minimum.

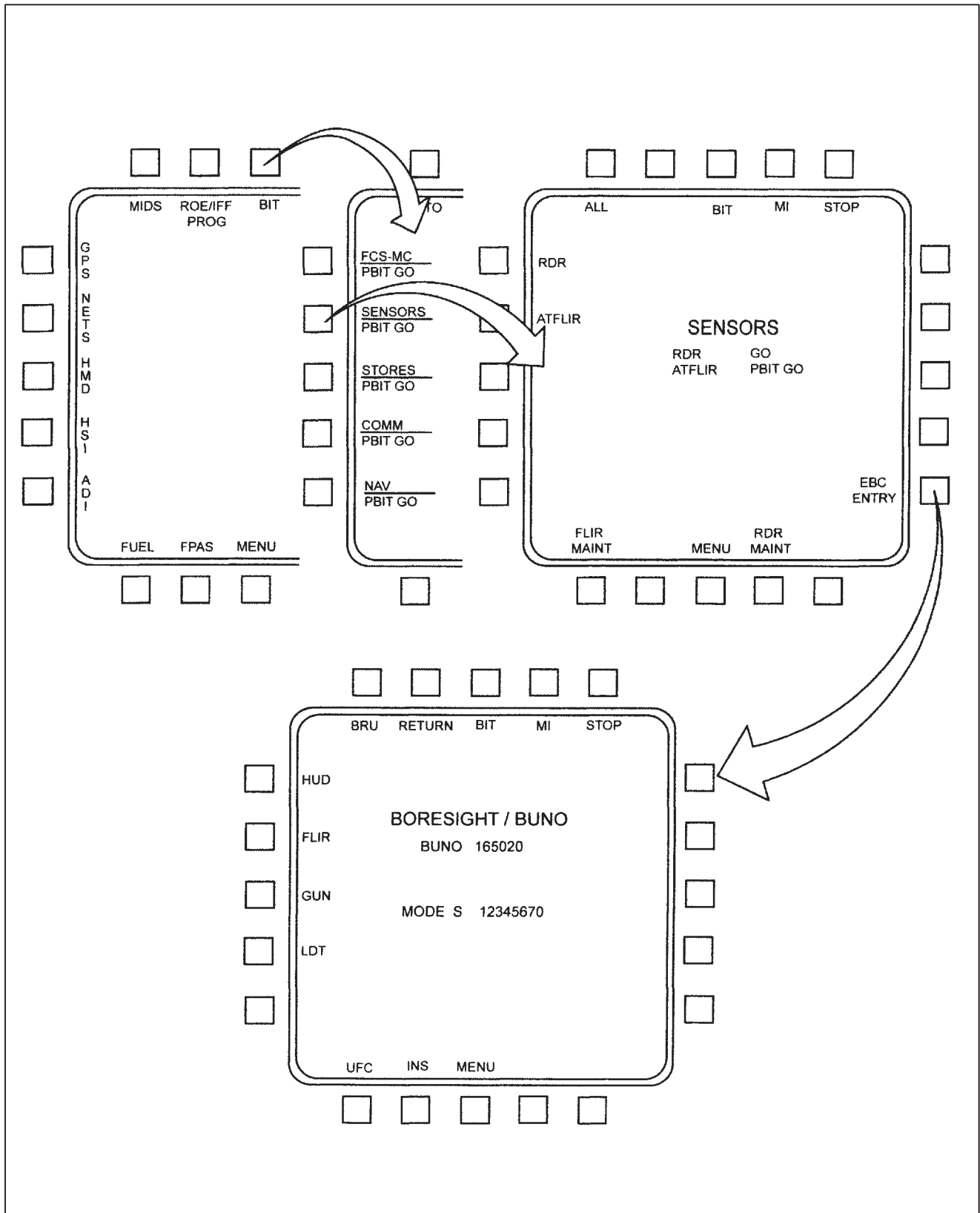
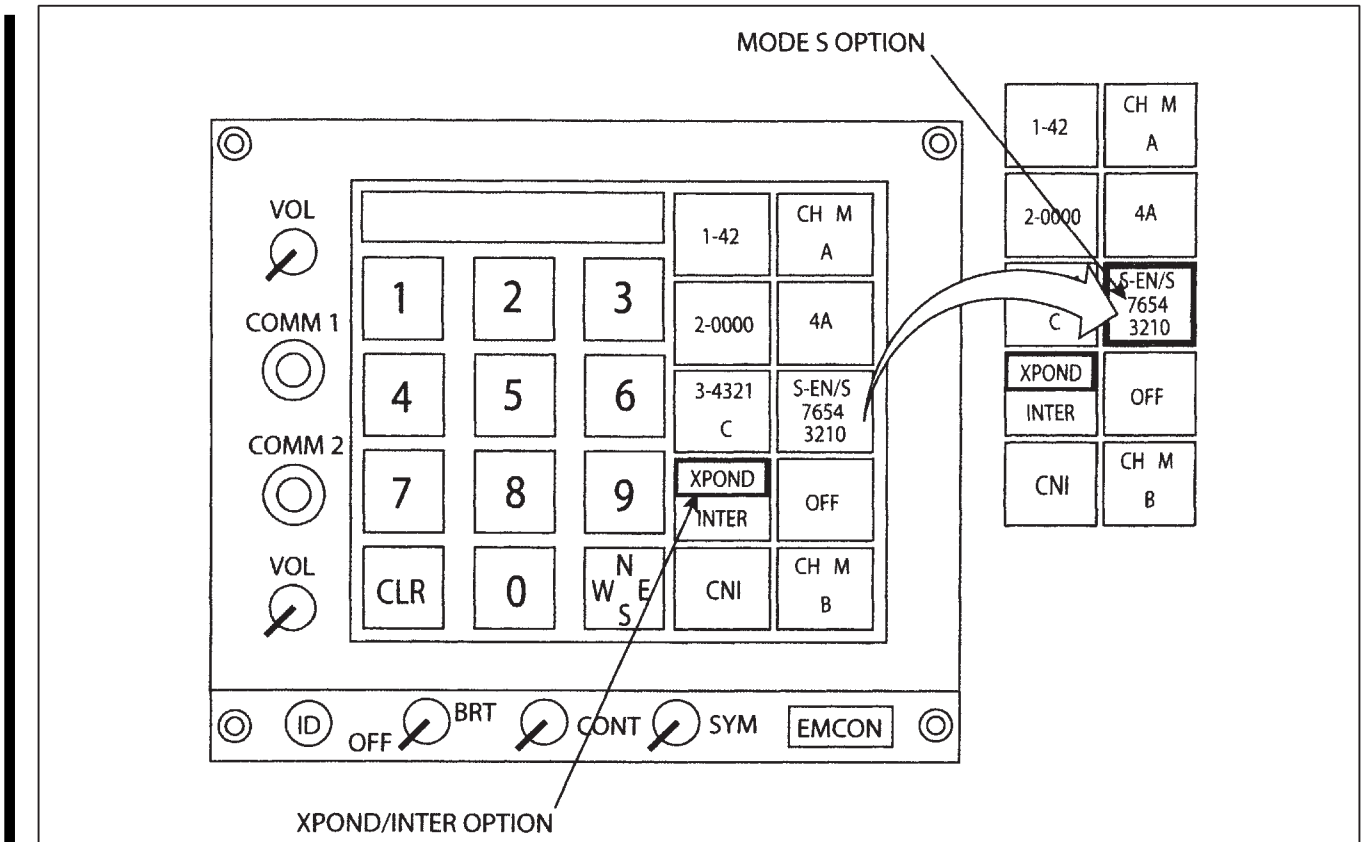

Figure 23-27. Electronic Boresight Constant (EBC) Display with W on W

EFN520-420-1-018



EFN520-424-1-016

Figure 23-28. XPOND Format Selection to Enable Mode S Enhanced and Squitter

1. **Mode S Option on Transponder UFCD Sublevel.** With the IFF system on, the Mode S option on the UFCD Transponder (XPOND) sublevel indicates the current status of the Mode S transponder (figure 23-28). The first line of the Mode S option indicates the selected Mode S surveillance and acquisition squitter options. Enhanced surveillance is indicated by "EN" and Elementary surveillance by "EL". An "S" after the slash indicates the squitter is enabled (e.g., S-EN/S) and a dash indicates the squitter is disabled (e.g., S-EN/-) (figure 23-29). The second and third lines indicate the temporary Mode S address. When a mission planning input is available, those Mode S surveillance and acquisition squitter options and the temporary address are displayed. Otherwise, the system defaults to Enhanced surveillance and squitter enabled (S-EN/S). Regardless of the Mode S options selected, Mode S is disabled at power up.

The first selection of the Mode S option boxes the option and enables the displayed Mode S functions. The second selection of the Mode S option displays the Mode S UFCD sublevel (figure 23-30).

If neither the permanent nor temporary Mode S address is available, Mode S is disabled, the Mode S option is Xd out, and the first line displays "S-". If no temporary address has been provided by mission planning or aircrew entry, all zeroes (00000000) are displayed (figure 23-31). A new temporary address can be entered by selecting eight valid numbers (all digits equal to 0-7 and can not contain all 7's or all 0's) and selecting the Mode S option.

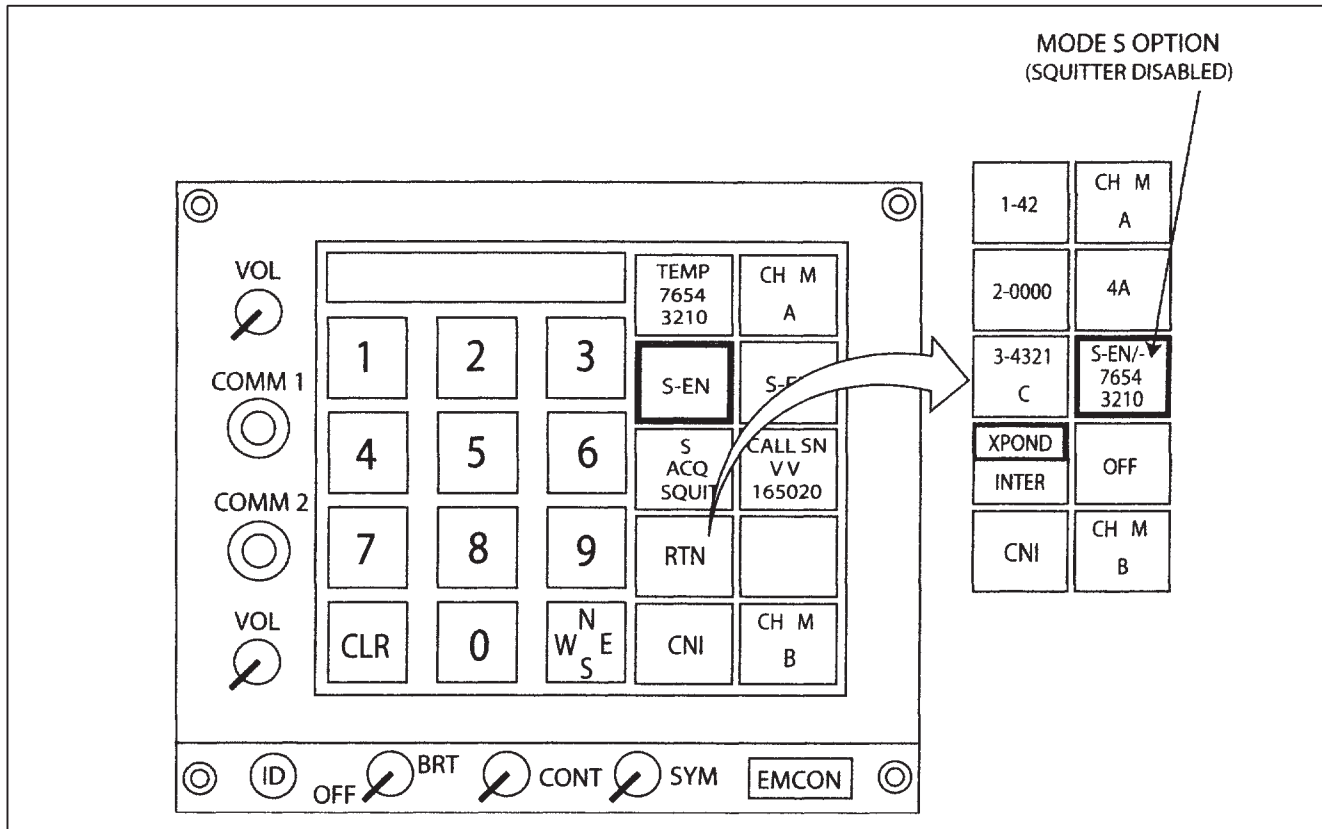

EFN520-430-1-018

Figure 23-29. Return to XPOND Format with Squitter Disabled

2. **Mode S UFCD Sublevel.** The Mode S sublevel is used to enable/disable the acquisition squitter, select Enhanced or Elementary surveillance, and enter the aircraft call sign and temporary address (figure 23-30). If the aircrew changes Mode S selections and disables Mode S, the aircrew's selections return when Mode S is re-enabled.

a. **Temporary Mode S Address.** The temporary Mode S address is displayed on the TEMP S option. The temporary address can be provided via mission planning or aircrew entry. If a temporary address is not available, all zeros (00000000) are displayed. A new temporary address can be entered by selecting eight valid numbers (all digits equal to 0-7 and can not contain all 7's or all 0's) and selecting the TEMP S option.

b. **Mode S Surveillance Level.** The Mode S Enhanced (S-EN) and Elementary (S-EL) Surveillance level options are mutually exclusive. Selection of either option enables that option and disables the other option. If neither option is enabled, enabling one option also enables the acquisition squitter (S ACQ SQUIT). If both options are disabled, Mode S and the acquisition squitter are disabled.

c. **Mode S Acquisition Squitter.** Selecting the Mode S acquisition squitter (S ACQ SQUIT) option toggles the squitter between enabled and disabled. When the squitter is disabled by selecting the option, it remains disabled until enabled again by aircrew. The squitter is also disabled when Mode S is not selected (S-EN and S-EL are deselected at the same time). Whether the squitter was disabled by the S ACQ SQUIT option or S-EN and S-EL deselect, selecting S ACQ SQUIT enables S ACQ SQUIT and the previous Mode S surveillance level (S-EN or S-EL). Squitter status is also displayed

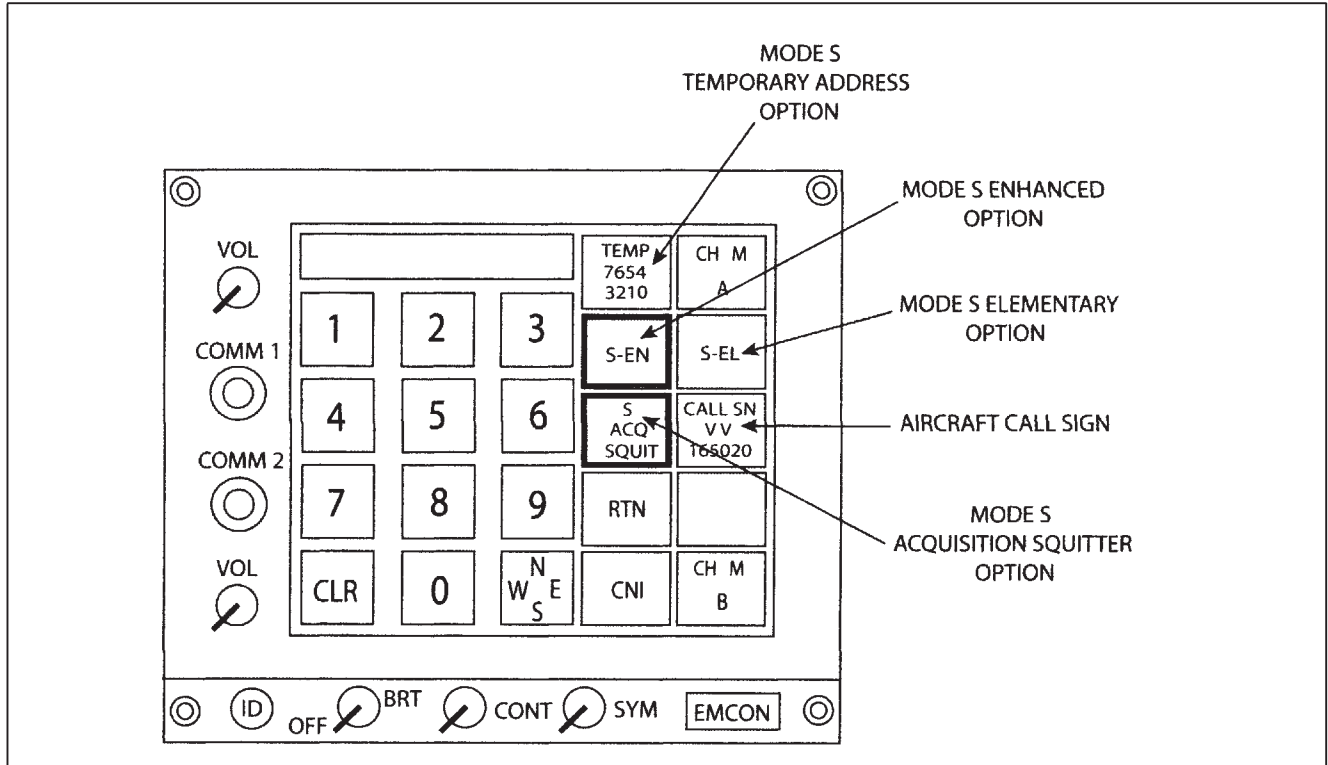

EFN520-429-1-018

Figure 23-30. Mode S UFCD Sublevel

on the XPOND sublevel Mode S option. An "S" after the slash indicates enabled (e.g., S-EN/S) and a dash indicates disabled (e.g., S-EN/-) (figure 23-29). The SQTTR advisory is also displayed anytime Mode S is enabled while the acquisition squitter is disabled. The SQTTR advisory is cleared when either Mode S is disabled or the acquisition squitter is enabled.

WARNING

Keep Mode S acquisition squitter enabled (boxed) when Mode S is enabled. Disabling Mode S acquisition squitter with Mode S enabled does not allow TCAS in nearby aircraft to acquire track.

d. Mode S Aircraft Call Sign. The Mode S aircraft (A/C) call sign is displayed on the CALL SN option. If the A/C call sign has not been made available from the aircrew or mission planning, the default A/C call sign is VV plus the BuNo (e.g., VV166855). The A/C call sign may be changed by selecting the CALL SN option which displays the A/C call sign UFCD sublevel and alphanumeric keypad (figure 23-32). Valid A/C call signs are limited to no more than eight letters and numbers. Leading or embedded spaces between characters in the A/C call sign are not accepted. Selecting the CALL SN option after entering the new A/C call sign changes the call sign.

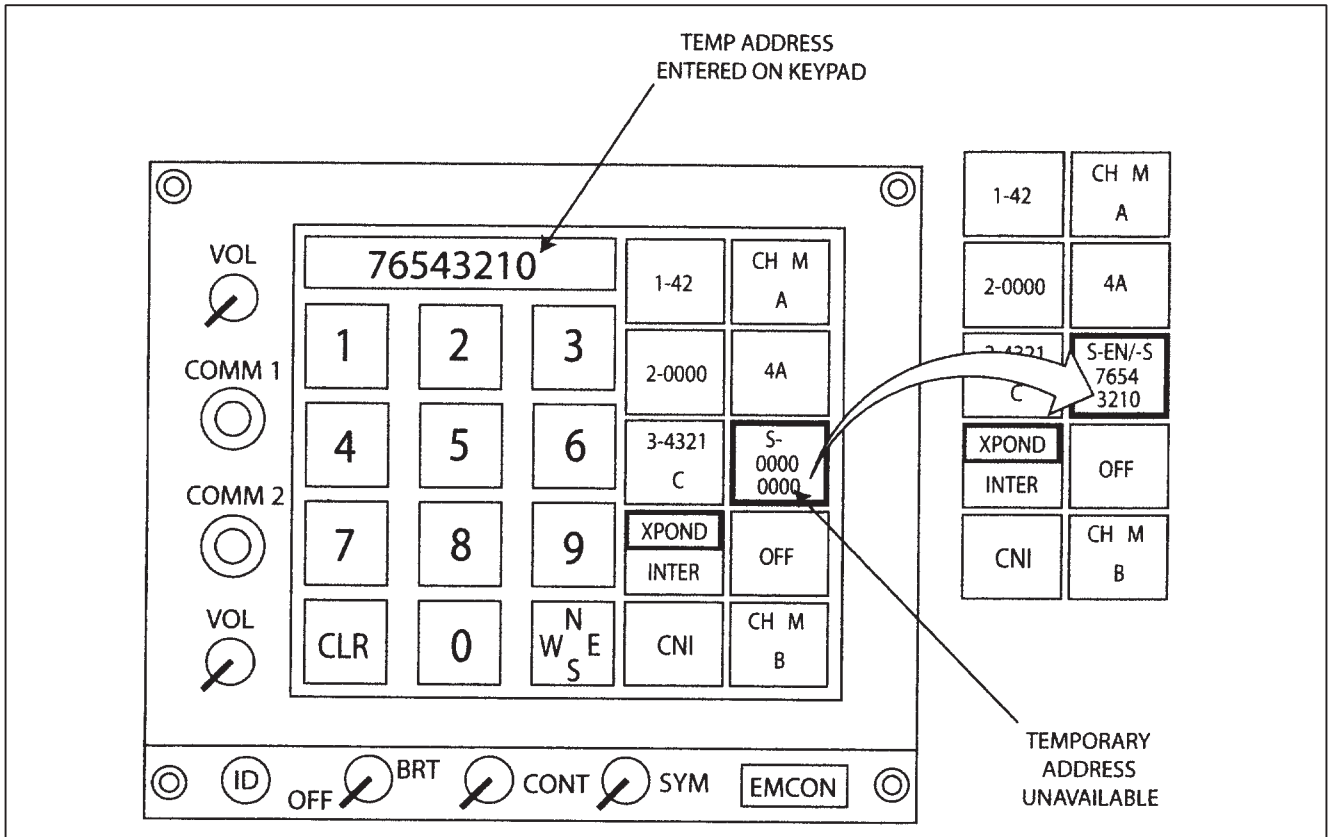

Figure 23-31. Mode S Address Not Available on XPOND Sublevel

EFN520-425-1-016

23.8.2 IFF Interrogator. Interrogator operation is described in A1-F18EA-TAC-100 Tactical Manual.

NOTE

All CIT equipped F/A-18s shall limit interrogator usage in non-tactical flight regimes. Specifically, Auto Mode Interrogations should not be selected during enroute transits to and from training areas or during cross country ferry flight. This operational limitation is intended for continental US flight operations only and is not intended to impact tactical doctrine or safety of flight requirements whatsoever.

23.8.3 IFF BIT. IFF BIT status is displayed on the BIT page (figure 23-24). Initiated IFF BIT can be performed by selecting the IFF option on the COMM sublevel of the BIT page.

23.8.4 IFF Programming (IFF PROG) Page. The IFF Programming (IFF PROG) page (figure 23-33) allows the aircrew to program the MC to automatically change the IFF codes at specified times or on a time interval, enable/disable IFF modes when the aircraft crosses a designated waypoint in a specified direction, and update the Mode 4 transponder and interrogator on Zulu day transition. The IFF PROG page is displayed by selecting the IFF/ROE PROG option on the SUPT page and then the IFF PROG option. The IFF can also be programmed during mission planning. There is no MC backup of this functionality. If either MC fails, this functionality is not usable.

IFF programs are always set as classified when edited on the IFF PROG page. When IFF programs are downloaded as an initialization file, the classification is set the same as the file, whether classified or unclassified.

23.8.4.1 Top Level IFF PROG Page. The IFF PROG page is divided into two sections. The top section contains the time based (TIME) code information while the bottom section contains the position (POS) group information. There are 15 distinct times and 2 positions which can be entered.

With the TIME option boxed, the MC automatically updates the selected IFF codes at the specified time. For each specified time, transponder codes may be set for Modes 1, 2, and 3. The times are referenced to aircraft Zulu time of day (ZTOD) in the format of hours:minutes. The first column of a TIME data line contains the ZTOD at which the codes are updated followed by the Mode 1, 2, and 3 code columns.

With the POS option boxed, the MC automatically enables/disables the selected Modes 1, 2, 3, C, and S transponder functions and can enable the Mode 4 transponder and interrogator functions at the designated waypoint. Mode 4 transponder and interrogator functions can not be automatically disabled. A POS group data line consists of the group number, the list of the modes to be affected in this group, whether the modes are enabled/disabled, and the cardinal direction and waypoint combination to specify the location where the modes are enabled/disabled.

With the AUTO M4 option boxed, Mode 4 for both the transponder and the interrogator switches from "A" to "B" when the aircraft clock passes through 00:00 Zulu time. If Mode 4 is already "B", this feature has no effect.

The MC automatically disables the TIME and POS updates when Automatic Carrier Landing (ACL) is selected. Once disabled, the desired automatic update state may be manually reselected. The AUTO M4 feature is never automatically disabled.

When the EDIT option is selected, the IFF PROG EDIT sublevel is displayed.

23.8.4.2 IFF PROG EDIT Sublevel. The IFF PROG EDIT sublevel is used to select the time, mode codes, position data and modes to be enabled/disabled and is displayed when the EDIT option on the IFF PROG page is selected. The selection box indicates the currently selected data line. Selection arrows are used to change the current selected data line. The CLEAR option clears the currently selected data. The RETURN option returns to the IFF PROG page.

23.8.4.2.1 TIME Data. When editing a TIME data line, M1, M2, M3 and INTVL options are displayed. When M1, M2, or M3 is selected, a UFCD format is displayed which allows aircrew to enter the Zulu time for the currently selected data line as well as input the exact code to be used in the selected mode. The mode code is selected by entering a valid code and selecting the UFCD CODE option. The selected mode code is displayed in the appropriate mode column on the IFF PROG page and in the CODE option. If no mode code has been selected, the column on the IFF PROG page is blank and the CODE option displays zeros. Time is selected by entering a valid four digit Zulu time and selecting the UFCD TIME option. The selected time is displayed in the TIME column on the IFF PROG page and in the TIME option. The selection arrows on the UFCD allow the aircrew to scroll sequentially through the times entered on the IFF PROG page.

When a new time is entered, the TIME data lines are sorted in increasing time order based on current aircraft time. The earliest later time is displayed first, followed by the remaining times in sequential order. The selection box is moved automatically when the data line is edited. Times that are

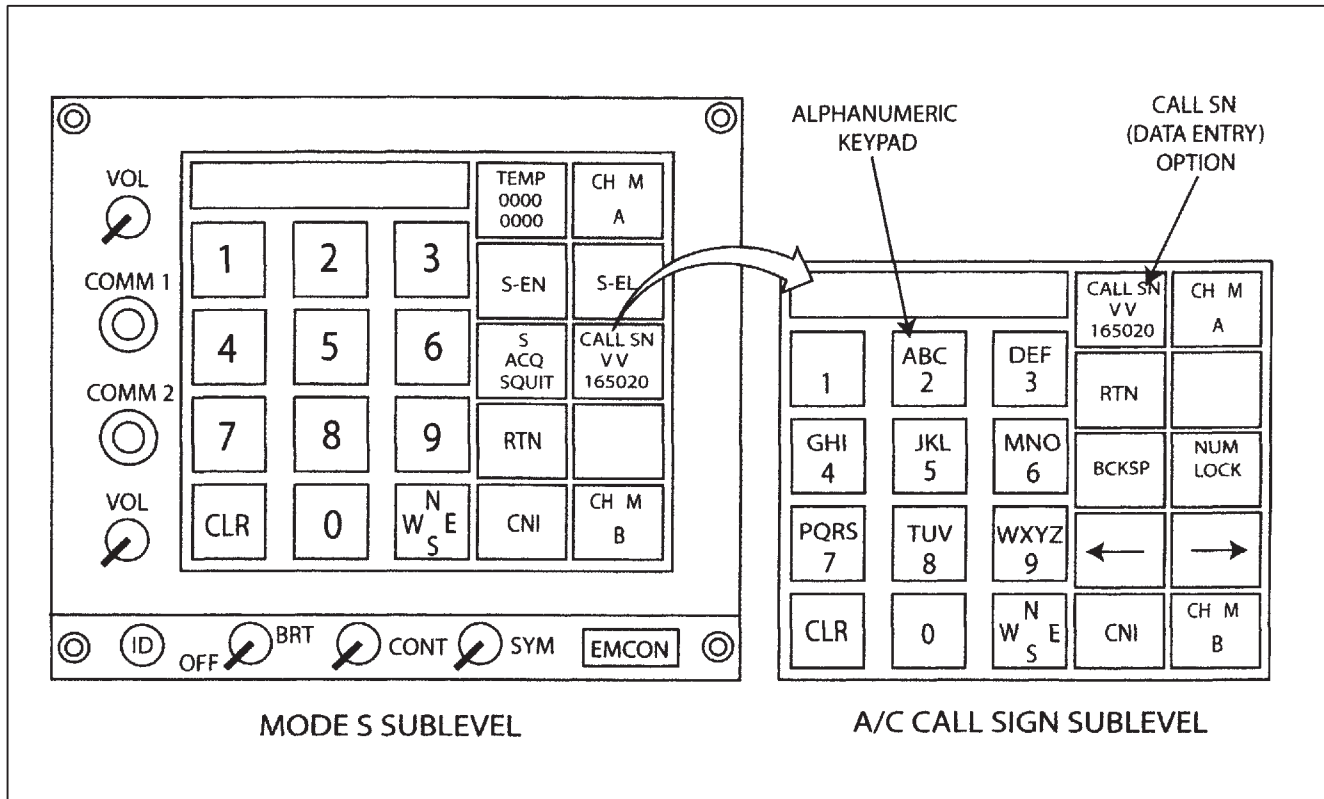

Figure 23-32. Mode S A/C Call Sign Sublevel

EFN520-427-1-018

earlier than the current aircraft time are assumed to be specified for the next Zulu day. When a TIME data line is CLEAR'ed, the data lines are re-sorted, moving the data selection box and the newly cleared data line to the bottom of the display.

A TIME data line is considered invalid if it contains valid code entries but does not contain a valid time. Invalid data lines are displayed at the bottom of the display and are not used by the IFF.

When INTVL is selected, a UFCD format is displayed which allows aircrew to enter a start time and single time interval for changing the IFF codes automatically. Start time is selected by entering a valid four digit Zulu time and selecting the UFCD START TIME option. The selected start time is displayed in the START TIME option. The time interval is selected by entering a valid time interval (1-99 minutes) and selecting the UFCD LNGTH option. The selected time interval is displayed in the LNGTH option.

When a start time and time interval are entered, all existing times are recomputed. The start time is displayed in the first TIME data line with subsequent times equal to the previous time plus the time interval. The codes currently specified for each data line are not changed.

23.8.4.2.2 POS Data When editing a POS group data line, M1, M2, M3, M4, MC, MS mode options, ENBL/DSBL and cardinal direction options are displayed (figure 23-33). In order for group data line to be valid, the following must occur: 1) At least one mode must be selected, 2) a direction must be selected, 3) and a waypoint must be entered.

The mode options toggle the modes to be enabled or disabled into and out of the selected group. The ENBL/DSBL option toggles between enabling and disabling the currently selected modes in the group. The option affects all of the modes presently selected in the group. When the DSBL option is selected,

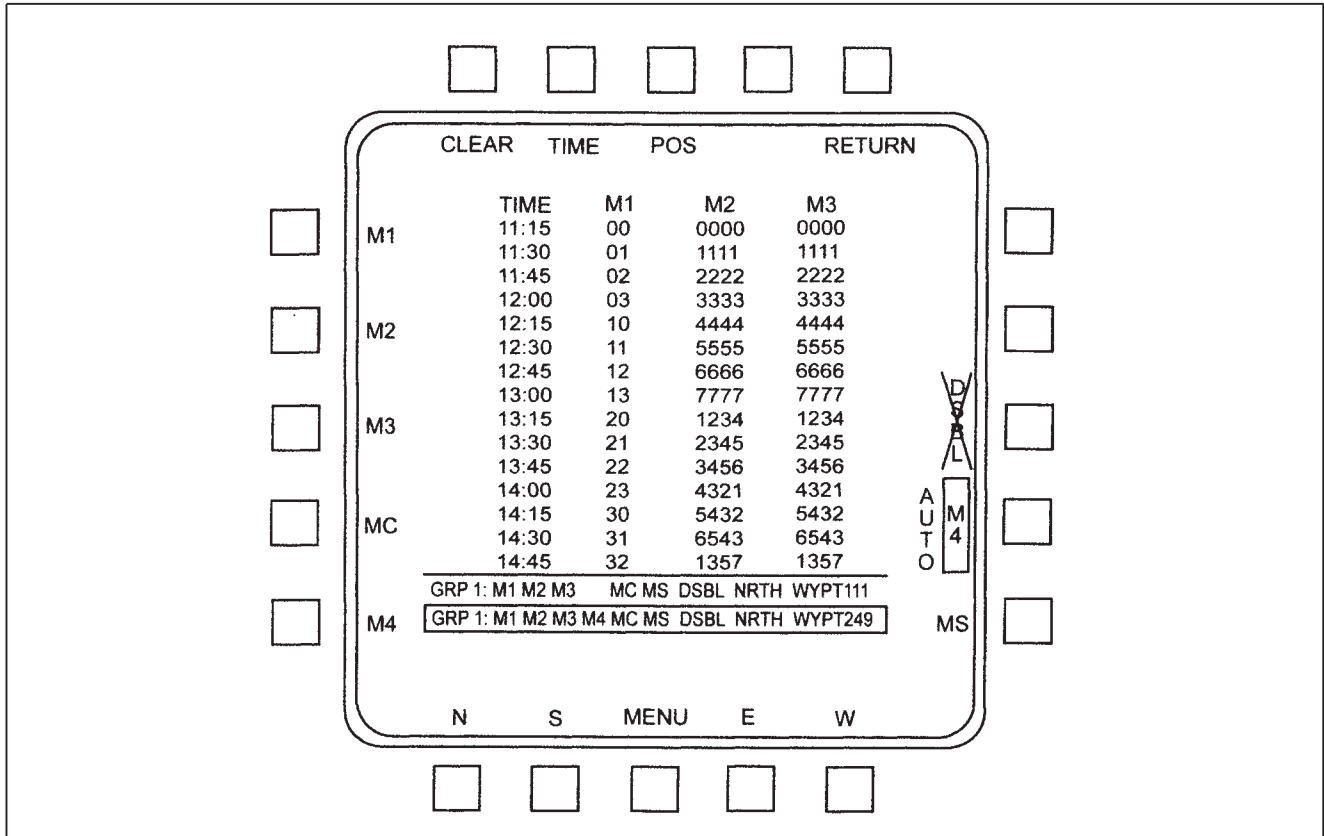

EFN520-421-1-018

Figure 23-33. IFF PROG EDIT Sublevel - POS Data

DSBL is displayed in the selected group and all modes listed are disabled when the aircraft reaches the designated waypoint. When the ENBL option is selected, ENBL is displayed in the selected group and all modes listed are enabled when the aircraft reaches the designated waypoint. Since Mode 4 can not be automatically disabled, whenever the selected POS group data line displays DSBL, the M4 option is Xd out. Also, if M4 is displayed in the selected POS group data line, the DSBL option is Xd out.

To designate the waypoint, one of the cardinal direction (N, S, E, W) options must be selected. The selected cardinal direction is the direction the aircraft must pass the designated waypoint in order to cause the selected modes to be enabled or disabled automatically. When a cardinal direction option is selected, a UFCF format is displayed which allows aircrew to enter the designated waypoint. The waypoint is selected by entering a valid waypoint number (0-99) and selecting the UFCF WYPT option. The selected waypoint number is displayed in the WYPT option. The selected waypoint number and cardinal direction are displayed in the group data line.

23.8.5 IFF Controls.

23.8.5.1 IDENT (ID) Button. The ID button is located on left side of the UFCF and is used to manually squawk ident. Pressing the ID button enables the IFF system to transmit identification of position for approximately 18 seconds.

23.8.5.2 Emission Control Button. The emission control button is located on the right side of the UFCF and is labeled EMCON. Pressing the EMCON button changes the IFF, if ON, to a standby

mode so that it cannot transmit. At the same time, EMCON is displayed in the scratchpad for top level displays or vertically in the left options for DDI displays on the UFC. When EMCON is turned off by pressing the button again, the IFF returns to the previous operating mode.

23.8.5.3 IFF Control Panel. The IFF control panel is located on the left hand console and contains the MASTER switch, the MODE 4 switch, and the CRYPTO switch. The MODE 4 and CRYPTO switches are used for Mode 4 on aircraft which have the KIV-6 installed.

23.8.5.3.1 MASTER Switch. This switch has positions of NORM and EMERG.

NORM	IFF replies to interrogations with selected codes.
EMERG	IFF replies to interrogations with emergency replies. The IFF transponder turns on if off. This selection also zeroes the ARC-210 radios.

23.8.5.3.2 MODE 4 Switch. This switch has positions of DIS/AUD, DIS, and OFF.

DIS/AUD	Enables IFF 4 caution and "MODE 4 REPLY" voice alert, M4 OK and IFFAI advisories, and the Mode 4 audio tone.
DIS	Disables the Mode 4 audio tone. The IFF 4 caution and "MODE 4 REPLY" voice alert, and M4 OK and IFFAI advisories are enabled.
OFF	Disables IFF 4 caution and "MODE 4 REPLY" voice alert, M4 OK and IFFAI advisories, and the Mode 4 audio tone.

23.8.5.3.3 CRYPTO Switch. This switch has positions of HOLD, NORM, and ZERO. The switch is spring-loaded to the NORM position.

NOTE

Ensure the MIDS terminal is on, by ensuring L16 or TACAN is ON, prior to any attempt to zeroize IFF Mode 4 Crypto Keys via the CRYPTO switch."

HOLD	Mode 4 codes are retained after power has been turned off if HOLD has been selected after the landing gear handle has been raised and lowered.
NORM	Mode 4 codes are available until power is turned off after the landing gear handle has been raised and lowered.
ZERO	Mode 4 codes are zeroized (erased).

23.8.5.4 IFF Antenna Select Switch. The IFF antenna select switch is located on the ANT SEL panel on the left console. When the switch is moved from BOTH to either UPPER or LOWER, the selection remains in effect for only 60 seconds, at which time the IFF automatically switches to BOTH. If the IFF switch remains in either UPPER or LOWER, a false indication of the antenna exists after the 60 second time limit. With WonW, the time limit is not in effect and the IFF operates in accordance with the position of the IFF antenna select switch.

UPPER	Selects upper antenna.
BOTH	Provides automatic antenna selection.
LOWER	Selects lower antenna.

23.8.6 IFF Related Cautions and Advisories. The following IFF related cautions and advisories are described in the Warning/Caution/Advisory Displays in Part V:

- IFF 4 caution
- IFF OVRHT caution
- MODE 4 REPLY voice alert
- EBC advisory
- IFFAI advisory
- M4 OK advisory
- SQTTR advisory

23.9 COMMUNICATION-NAVIGATION-IDENTIFICATION INTERFACE

The radios, ADF, TCN, ILS, data link, radar beacon, and IFF interface with the aircrew through the UFCD. The UFCD power and symbology are provided by the MPCD. As commands are entered into the UFCD, the MPCD transmits those commands to the mission computer. The MC accepts those commands and transmits them either directly to the CNI equipment if it is MUX compatible or to the CSC if it is not. For non-MUX CNI equipment, the CSC converts the commands to analog or discrete information and directly interfaces with the equipment. The CSC also converts standby attitude signals used in the electronic attitude display indicator (EADI) and if the CSC fails the EADI is not available.

CHAPTER 24

Navigation Equipment

Navigation equipment consists of the following: Inertial Navigation System (INS, AN/ASN-139) and Global Positioning System (GPS AN/ASN-163), or Accurate Navigation System (ANAV, AN/ASN-181), which includes the INS and GPS, TACAN (RT 1159A/ARN-118, if installed), Instrument Carrier Landing System (ICLS, AN/ARA-63), Data Link (D/L, RT/1379A/ASW), and Automatic Direction Finder (ADF, OA-8697/ADR, if installed). When installed, the Multifunctional Information Distribution System (MIDS) also serves as a navigation aid by providing TACAN and precise relative navigation position keeping functions.

24.1 NAVIGATION CONTROLS AND INDICATORS

Navigation controls and indicators consist of the UFCD, MPCD, DDIs, HUD, INS mode switch, course set switch, and COMM control panel. These controls and indicators are integrated in the navigation system. MPCD and HUD symbology, and UFCD functions are described in Chapter 2.

24.1.1 UFCD Navigation Controls. The UFCD allows: ON/OFF operation of the ILS, TACAN, D/L, and ADF; data entry for the TACAN and INS; and mode selection for the D/L.

24.1.2 Moving Map - Digital Map Set (DMS). (LOTs 21-24) The DMS utilizes the MPCD to provide the pilot/WSO with a high resolution color map display for day/night navigation. The DMS display can be selected on the front or rear MPCD or any DDI; however, a DDI only displays a monochrome image.

(LOTs 25 and up) The DMS is displayed in color and can be displayed on any AMPD, and the front and rear MPCD.

24.1.2.1 MAP Option (HSI Option). The MAP option provides on/off control of the DMS map when selected from an MPCD (MAP option is boxed when the map is ON). When MAP is selected from a DDI, the HSI format source alternates between stroke (DDI symbol generator) and raster (DMS mono-map) on all DDIs displaying the HSI format. The DMS map is commanded ON for the LDDI and the MPCD when the raster HSI is selected on the DDI.

When map update is selected from the front cockpit MPCD, the TDC is assigned to the map slew function. When map update is selected from the rear cockpit MPCD, the LDC is assigned to the map slew function (if the LDDI is not communicating on the AVMUX, the RDC is assigned). When map update is selected from the right or left DDI, the RDC or LDC, respectively, is assigned to the map slew function. When map update is selected, MAP is automatically boxed. When map update is selected on a DDI, all DDIs displaying the HSI format are driven by the DMS mono-map.

24.1.2.1.1 Moving Map Range Scales. For HSI in T UP (track up) or N UP (true north up), valid range scale/map type combinations are as follows: 40/1:2M, 20/1:2M-ZOOM, 10/1:500K, 5/1:250K.

For HSI in DCTR (decenter), valid range scale/map type combinations are as follows: 80/1:2M, 40/1:2M-ZOOM, 20/1:500K, 10/1:250K.

Map compatible range scales are:

1. Centered (5, 10, 20, & 40 nm)

2. Decentered (10, 20, 40, & 80 nm)

24.1.3 HSI Format. The MPCD displays TACAN, INS (also INS alignment data), D/L, ILS, and ADF navigation symbology. The MPCD also allows selection of various TACAN, ILS, INS, and D/L functions using the MPCD option pushbuttons. See figure 24-1.

The HSI format displayed on the MPCD is driven by the MPCD symbology overlaying the DMS color map. The HSI format displayed on the DDI is driven by either a mono-map output from the DMS or a DDI symbol generator. The DMS mono-map output contains the same information as the DMS color output except for color, including cautions if they are provided with the color output. If the DMS fails, the color map is unavailable; however, all stroke formats are available for display.

Navigation symbols and digital readouts are normally displayed on the MPCD. One of three TDC assignment symbols can be displayed in the upper right corner of a TDC compatible display, to indicate a TDC is assigned to the display in the front cockpit only, rear cockpit only, or both cockpits. When a TDC is assigned to the map slew function, SLEW is displayed in the upper right corner of the HSI display along with one of three arrows to indicate TDC assignment to the display in the front cockpit only, rear cockpit only, or both cockpits.

24.1.3.1 HSI Option. This option returns the operator to the Top Level HSI format after the DMS has been configured for operation. The HSI option coincides with the other HSI options found on similar HSI formats to ensure consistency between formats. See figure 24-2.

24.1.3.2 MODE Option (HSI Format). The HSI display MODE option is located adjacent to the center left push button of the DDI or MPCD. Selecting the MODE option enables T UP, N UP, DCTR, MAP, and slew options to be displayed on the left side of the HSI display. At aircraft power-up/WonW, the system initializes to map boxed (on), centered, T UP, and 40 nm scale.

24.1.3.2.1 MAP Operating Mode Option. This multifunction option combines the Chart (CHRT), digital terrain elevation data (DTED), and controlled image base (CIB) map operating modes into a single option. See figure 24-2.

24.1.3.3 MODE Backup. If aircraft magnetic heading or aircraft horizontal velocities become invalid, the HSI format is limited to a centered north-up mode and the T UP and DCTR legends are removed and selection inhibited from the HSI Mode sublevel. The N UP legend on the HSI Mode sublevel is boxed under this condition. When aircraft magnetic heading and aircraft horizontal velocities become valid, the HSI format is driven to the currently selected mode and the T UP, N UP and DCTR legends are provided and processed on the HSI Mode sublevel.

NOTE

The currently selected HSI format mode option remains unchanged when the aircraft magnetic heading or aircraft horizontal velocities become invalid.

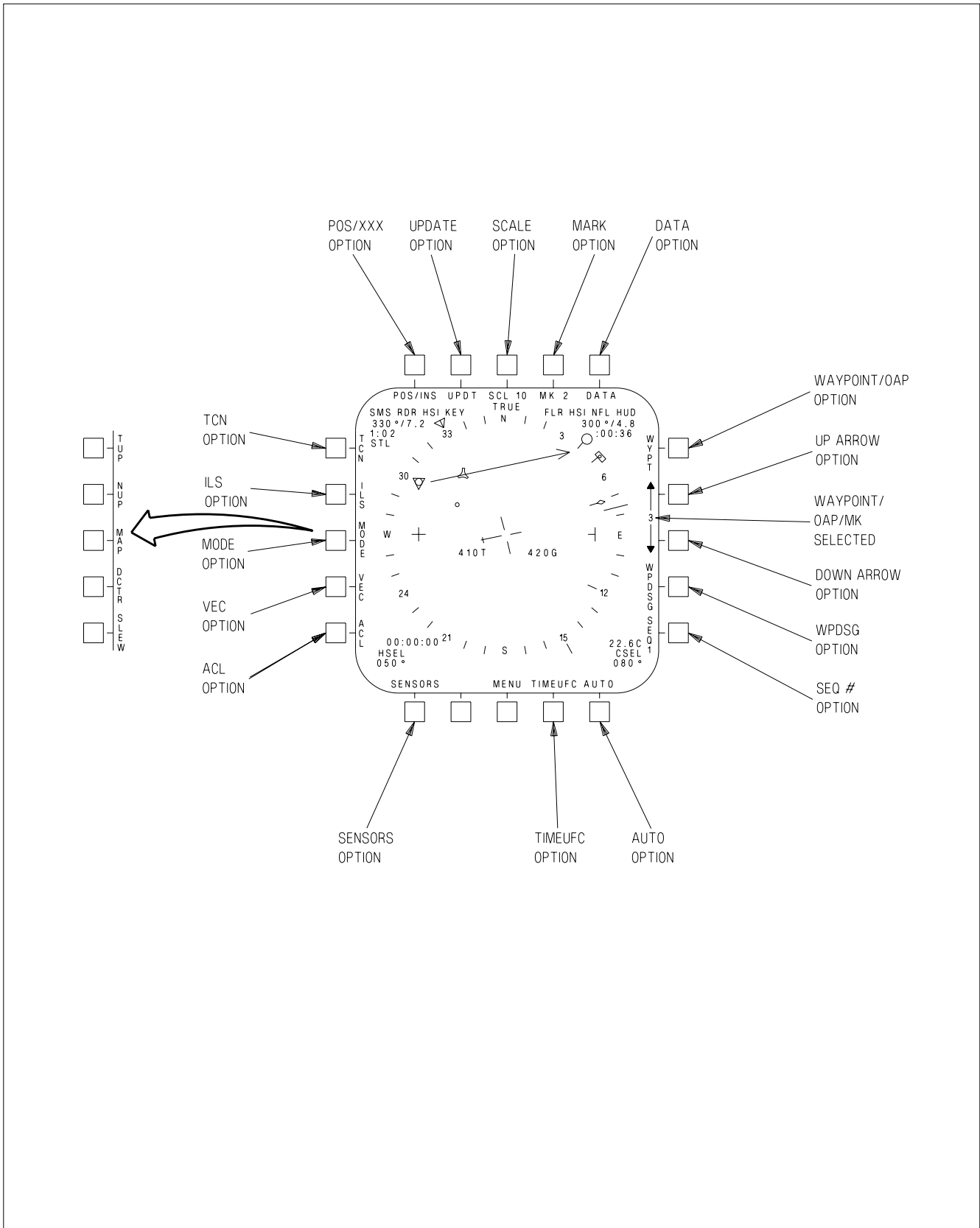

EFN520-165-1-010

Figure 24-1. Navigation Controls and Indicators (Sheet 1 of 2)

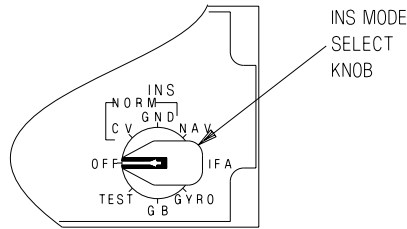

SENSOR CONTROL PANEL

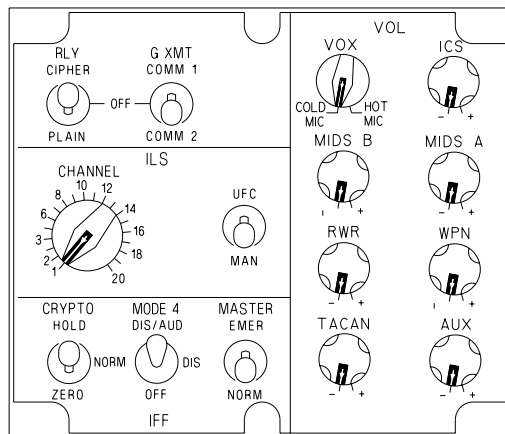
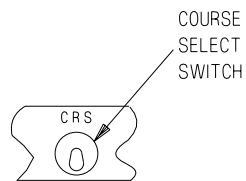

COMMUNICATION CONTROL PANEL

Figure 24-1. Navigation Controls and Indicators (Sheet 2 of 2)

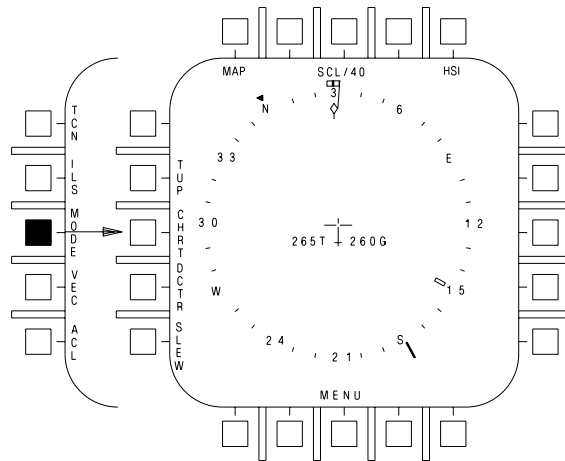

1. HSI MODE SUBLEVEL FORMAT

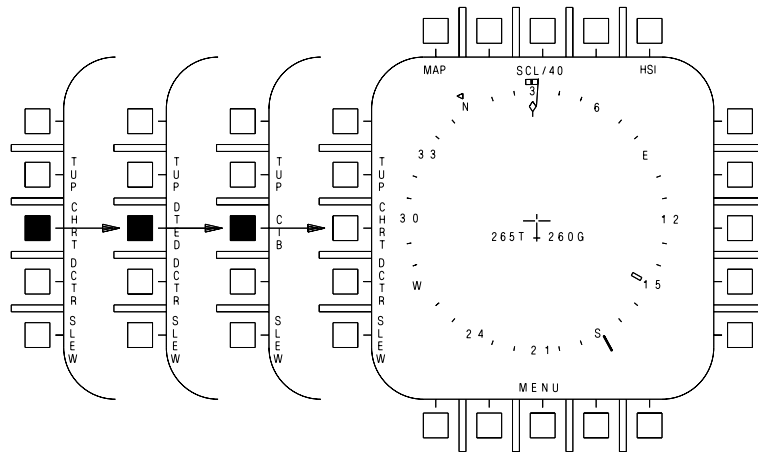

2. MAP MODE SEQUENCING

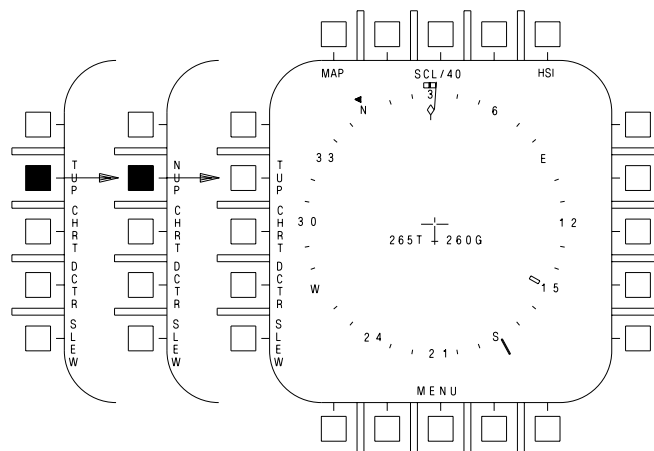

3. MAP ORIENTATION SEQUENCING

EFN520-375-1-004

Figure 24-2. TAMMAC Mode Selections

24.1.3.3.1 MAP Modes/Data Products. Each of the map modes (CHRT, DTED, and CIB) provides a different plan-view map/image. The actual presentation and availability of the different maps/images are independent and mutually exclusive. Only one map mode can be selected at any one time. The detailed images and associated area coverage for each mode are dependent on the map (theater) data loaded in the DMS or installed on the mission card. Each plan-view map, regardless of mode, presents an image that can support moving map capability and/or slew mode functions. When toggling through the different modes, different map images are available providing the mode specific data is loaded/available for that particular geographic position and scale. The map modes and their associated data products are:

1. Chart (CHRT) mode provides a plan-view color map derived from Compressed ARC Digitized Raster Graphics (CADRG). This chart product replaces the Compressed Aeronautical Chart (CAC) map data currently used in the existing map (AN/ASQ-196).
2. Digital Terrain Elevation Data (DTED) mode provides a plan-view, panchromatic (gray scale), terrain plot with slope shading.
3. Controlled Image Base (CIB) mode provides a plan-view panchromatic image derived from a variety of mission planning, command, control, communications, and intelligence systems.

24.1.3.4 Map Data. The MDATA option is provided on the HSI/DATA sublevel format. MDATA is boxed when selected and remains boxed until A/C, WYPT, TCN, HSI, or INS CK is selected. When MDATA is selected, the DATA option is provided on the UFCDD. When MDATA is selected on the HSI, all DDI/MPCD/UFCDD with the HSI format are driven by the DMS mono-map and the data frames written in raster. The number of data frames is limited to 100.

24.1.3.4.1 Map Orientation Option. This option is a multifunction option that combines the Track Up (T UP) and North Up (N UP) map orientation functions into a single option. Successive selections of the orientation option toggles the map between these two orientations as they are mutually exclusive. The T UP orientation is the default orientation. The DMS mono-map output contains the same information as the DMS color output (except for color), including cautions if they are provided with the color output. See figure 24-2.

24.1.3.5 SLEW Option (HSI Format). When map update is selected from the cockpit, the TDC is assigned to the slew function. When map update is selected from the rear MPCD, the LDC is assigned to the slew function (if the left DDI has malfunctioned the right designator control (RDC) is assigned). When map update is selected from the right or left DDI the RDC or LDC, respectively, is assigned to the map slew function. When map update is selected, MAP is automatically boxed and when selected on a DDI, all DDIs and MPCDs displaying the HSI display are commanded to be driven by the DMS monochromatic map.

When WYPT slew is selected from the cockpit, the TDC is assigned to the MAP Slew function for waypoint update. When WYPT Slew is selected from the aft MPCD, the LDC is assigned to the MAP slew function for waypoint update (if the LDDI is not communicating on the AVMUX, the RDC is assigned). When WYPT Slew is selected from the right or left DDI, the RDC or LDC, respectively, is assigned to the map slew function for waypoint update. When WYPT Slew is selected, MAP is automatically boxed. When WYPT slew is selected on a DDI, all DDIs and UFCDDs displaying the HSI format are commanded to be driven by the DMS mono-map.

24.1.3.6 POS/XXX Option (HSI Format). This option is located along the top row of the HSI display and when selected provides the POS/XXX sublevel display. This sublevel display allows the selection

of AINS, INS, GPS, MIDS (if installed), ADC, or TCN as the position keeping source. When one of these options is selected the top level HSI display is returned, with the appropriate selection denoted (Ex. POS/ADC). POS/INS is automatically selected during ground operations when INS data is valid. Without MIDS, should the INS fail, the MC automatically begins position keeping with FCS air data function (ADC) from the last valid INS position. If MIDS is installed and operating, MIDS is automatically selected as the aircraft position keeping source if GPS and INS fail or become degraded. Because MIDS position keeping is unreliable and inflight alignment is not possible when in POS/MIDS, air data position keeping (POS/ADC) should be manually selected if POS/MIDS is displayed.

24.1.3.7 UPDT Option (HSI Format). The UPDT option is located along the top row of the HSI display and when selected provides the UPDT sublevel display. This sublevel display allows the selection of VEL (velocity), TCN, DSG (designation), AUTO, or MAP as the update source. Following the selection of one of the update options, an ACPT/REJ (accept/reject) display is presented in which the update can either be accepted or rejected. After selection of ACPT or REJ, the top level HSI display is returned. There is no ACPT/REJ display presented when the AUTO option is selected. Velocity update is described in the A1-F18EA-TAC-000. If a previous update has been accepted, a CANCEL option is also displayed on the UPDT sublevel to allow the aircrew to cancel the last accepted update.

24.1.3.8 MK Option (HSI Format). This option is located along the top row of the HSI display. The mark option is initialized to MK1 upon power up with WonW, regardless of the previous selection. A maximum of nine mark points may be entered. If all mark points have been used and another mark point is entered, MK1 is replaced with the new mark data.

If a waypoint/OAP is not designated and the MK option is selected, the lat/long of the current overfly point is stored with the elevation set to zero. If a location is designated, the lat/long of the designated location is stored. In this situation, the aircraft altitude minus the altitude above the designated target is stored as the elevation.

24.1.3.9 DATA Option (HSI Format). The data option is located along the top row of the HSI display. Selecting this option provides the DATA sublevel display. This display is used to enter waypoint/OAP data, aircraft data, TACAN data, waypoint/OAP sequence data, radar and barometric altitude warning, groundspeed data, and TOT data; and to select the INS check display. After selection of either the WYPT, A/C, or TCN option, the UFC or SEQUFC option is used to initialize the UFC for data entry. The HSI option is used to return the HSI display to the top level format.

24.1.3.10 WYPT, OAP Option (HSI Format). The WYPT, OAP option is located along the right side of the HSI. WYPT is displayed when steering is to a waypoint. OAP is displayed when steering is to an OAP. If either the WYPT or OAP option is selected (boxed), direct great circle steering is provided to that waypoint/OAP. TGT is displayed at this location when a target is designated.

24.1.3.10.1 Waypoint, OAP, Mark Point Selection. Along the right side of the HSI display just below the WYPT/OAP/TGT options, there are two arrows pointing in opposite directions with a number in between. This number indicates the current steer to waypoint/OAP/mark. The waypoint/OAP being steered to can be incremented/decremented by selecting the appropriate arrow option, changing the steer to number. After all of the waypoints/OAPs have cycled through (0 through 59), the mark points can be selected for display. Marks are displayed with an M preceding the number.

24.1.3.11 WPDSG, O/S Option (HSI Format). This option is located along the right side of the HSI display. Selecting this option designates a waypoint/OAP for weapon computations, sensor slaving,

steering, or position updating. Selecting the WPDSG option designates the waypoint/OAP. After designating a waypoint, the WPDSG option is removed and TGT replaces WYPT. After designating an OAP, OAP remains boxed and O/S replaces WPDSG. When O/S is selected, the offset point is designated, TGT replaces OAP, and O/S is removed.

24.1.3.12 SEQ # Option (HSI Format). The SEQ # option is located along the right side of the HSI display. At power up with WonW, this option initializes to SEQ1 (unboxed). Successive actuations of the option toggles through a display sequence in the following order: SEQ1 (boxed), SEQ2 (unboxed), SEQ2 (boxed), SEQ3, (unboxed), SEQ3, (boxed), SEQL, (unboxed), SEQL, (boxed), and back to SEQ1 (unboxed). With the SEQ # option boxed, dashed lines are displayed connecting the waypoints of that sequence. The dashed lines connecting the waypoints (SEQ # boxed) are displayed for all HSI range scales and all HSI modes. The dashed lines are removed when magnetic heading is invalid, aircraft position is invalid, or map slew is selected.

24.1.3.13 AUTO Option (HSI Format). The AUTO option is located along the bottom of the HSI display. Selecting the AUTO option provides auto sequential steering to the first waypoint in the selected sequence; boxing the AUTO and WYPT or OAP option (if not already boxed). Selecting the AUTO option while boxed deselects auto sequential steering and unboxes the AUTO option. The AUTO option is removed when:

1. The INS is in an alignment mode
2. INS heading failure occurs
3. Magnetic is invalid
4. Aircraft present position is invalid
5. Aircraft ground track is invalid
6. Selected sequence contains less than two waypoints
7. Aircraft is in auto or velocity update
8. FCS is coupled to the D/L
9. A ground point is designated

24.1.3.14 TIMEUFC Option (HSI Format). The TIMEUFC option is located along the bottom row of the HSI display. The TIMEUFC option is removed from the HSI format during a GND or IFA GPS alignment until the qual number is 6.2 or better, and is never displayed during a CV alignment. Selecting this option boxes TIMEUFC and initializes the UFCO option display windows with the clock options: DATE, ET counter, CD timer, ZTOD, and LTOD. Border highlights indicate that an option is enabled for data entry. If an option is displayed on the HUD, the option has *HUD displayed below it in addition to being border highlighted. The DATE, ET, ZTOD, LTOD, and CD options are mutually exclusive; selecting one option deselects another option.

Data entry can be made for current date, current zulu or local time, or initial countdown time. No data entry is available for the elapsed time option.

If DATE is highlighted, an M, D, and Y appear in the scratch pad and the month, day and year can be entered on the keypad. If LTOD or ZTOD are highlighted two colons appear in the scratchpad and

the hour, minutes and seconds can be entered on the keypad. If CD is highlighted one colon appears in the scratchpad and minutes and seconds can be entered. Leading zeroes must be entered for the date and time entries. Digits not entered are assumed to be zeroes, i.e., trailing zeroes need not be entered. The time is displayed on the scratchpad as it is entered and displayed as ##:##:##. When the time has been updated in the SDC it appears on the HUD and *HUD appears on the UFCD highlighted option. The time display can be changed from local or zulu by selecting the appropriate option on the UFCD and entering the appropriate time as before.

Countdown (CD) or elapsed (ET) time is selected and displayed in the same manner as local or zulu time with the addition of START or STOP options. While CD START is displayed, the countdown timer is counting down. The countdown timer defaults to 6 minutes on power up. If an invalid countdown time is entered the timer sets to 59:59 and freezes. While ET START is displayed, the elapsed timer is counting up to a maximum of 59:59.

24.1.3.15 MENU Option (HSI Format). When MENU is selected on the top level HSI display, the TAC Menu is displayed. The Tactical (TAC) option provides access to weapons, sensors and HUD formats. The TAC Menu is displayed when the MENU option on any format is pressed. The Support (SUPT) menu is accessed by pressing the MENU option when the Tactical (TAC) menu is displayed. When the SUPT menu is displayed, it provides access to the ADI, HSI, BIT, Checklists, Engines, Flight Controls, UFC Backup and Fuel formats.

24.1.3.16 ACL Option (HSI Format). The ACL option is located on the left side of the HSI display. When selected, ACL is boxed and the link 4 display appears on the left DDI.

24.1.3.17 SENSORS Option (HSI Format). Refer to A1-F18EA-TAC-100.

24.1.3.18 VEC Option (HSI Format). Refer to A1-F18EA-TAC-100.

24.1.3.19 D/L Option (HSI Format). Refer to A1-F18EA-TAC-100.

24.1.3.20 ILS Option (HSI Format). The ILS option is located on the left side of the HSI display. When selected, ILS is boxed and ILS steering appears on the HUD.

24.1.3.21 TCN Option (HSI Format). The TCN option is located on the left side of the HSI display. When selected, TCN is boxed and TACAN great circle steering appears on the HUD.

24.1.4 HSI Format on a DDI. The DDIs are capable of displaying HSI display and D/L information by selecting the HSI or SA option on the applicable menu.

24.1.5 HUD - Navigation Information. The HUD displays basic flight symbology and steering information for the TACAN, ILS, ACL, and INS.

24.1.6 CRS Select Switch. The CRS select switch is used to set a course to the selected waypoint, OAP, or TACAN station. When the switch is actuated with waypoint/OAP or TACAN direct great circle steering already selected, a course line appears through the waypoint/OAP or TACAN symbol on the HSI display and steering information appears on the HUD. The course line rotates clockwise when the switch is held to the right and counterclockwise when the switch is held to the left. When a course is selected, a digital readout appears on the lower right corner of the HSI display.

24.1.7 IFF Control Panel. This panel contains two ILS controls: ILS UFC/MAN switch and the ILS channel thumbwheels.

24.1.7.1 ILS UFC/MAN Switch. When the switch is in the UFC position, ILS power and channelization is controlled by the UFC/D. With the switch in the MAN position, ILS power is enabled and ILS channel changes are controlled by the ILS channel thumbwheels.

24.1.7.2 ILS Channel Thumbwheels. These thumbwheels are used to select ILS channels when the ILS UFC/MAN switch is set to MAN.

24.2 INERTIAL NAVIGATION SYSTEM (INS)/GLOBAL POSITIONING SYSTEM (GPS)

There are two navigation system configurations. In one configuration, navigation data is provided by two separate systems: INS (CAINS II) and GPS (MAGR or MAGR2K). In the other configuration, navigation data is provided by a single system called Accurate Navigation (ANAV) which integrates the INS and GPS together. Both configurations provide data to the MC for navigation, targeting, and weapon delivery.

Additionally, ANAV integrates the Deflection of Vertical (DoV) database (also known as the Gravity Map database). The DoV database is downloaded onto the mission card during mission planning. The continual use of DoV data along the flight path assists in an improved navigation solution. If GPS data is unavailable, the additional DoV data assists the ANAV system in maintaining unaided navigation performance.

24.2.1 Inertial Navigation System (INS). The INS is a self-contained, fully automatic dead reckoning navigation system. The INS detects aircraft motion and provides acceleration, velocity, present position, pitch, roll, and true heading.

Without good GPS satellite data, unaided INS (POS/INS) is the primary position keeping mode. In POS/INS, the navigation system provides data by using the INS's sensor data alone. In this mode, the navigation data drifts in error over time. With ANAV installed, the error drift is minimized with the use of the DoV data. POS/INS is selected by turning the INS knob to NAV after GND or CV alignment or is automatically defaulted to when GPS data is lost while in aided INS (POS/AINS).



If the INS is turned off with the INS knob or shuts down abnormally (power loss), the INS knob must be set to OFF for a minimum of 20 seconds.

NOTE

While it is acceptable to taxi with the INS off, the INS should be on, whenever possible, to reduce accelerometer wear. It is preferable to switch to the GYRO mode and wait for course level complete (NO ATT clears) before taxiing.

24.2.2 Global Positioning System (GPS). The GPS provides position, velocity, and time (PVT) data that can be used to aid the INS or as an independent navigation sensor. The GPS receives modulated signals through the GPS antenna from 32 high orbit satellites. Satellite data is used to determine GPS position and velocity. GPS can be initialized with crypto keys, enabling encrypted Y-code (precise/encrypted) navigation signals to be received.

With good GPS satellite data, aided INS (POS/AINS) is the primary position keeping mode. In POS/AINS, the navigation system provides data by blending the INS sensor data with GPS data. POS/AINS is selected by turning the INS knob to IFA after a GND or CV alignment. The position keeping mode remains POS/AINS unless GPS data is lost, an INS or GPS failure occurs, or the pilot manually chooses a different position keeping source.

GPS has four modes of operation which are displayed on the GPS page (see figure 24-3). In NAV mode, the GPS tracks all available satellite constellations possible to provide the most accurate PVT solution. In Initialize (INIT) mode, the power supply is turned on, satellite tracking is not performed, and almanac and waypoint data are loaded from the mission card into the GPS when initiated by the MC. In Not Ready (NOT RDY) mode, the GPS is off or not communicating on the MUX. TEST mode is provided for ground BIT testing.

Crypto key loading may be performed with an approved crypto loading device such as KYK-13, CYZ-10, or Simple Key Loader (SKL) in any mode of operation.

It is important to set Zulu Time of Day (ZTOD) to aid in satellite acquisition. Local time, if desired, should be set after takeoff. GPS is loaded with GPS precise times only once per cold start. Changing the aircraft time or date with WonW re-initializes the GPS. An overall GPS Position Accuracy Figure Of Merit (FOM) and Satellite (SAT) status is displayed on the GPS page to enhance the pilot's awareness of the overall GPS status.

24.2.3 Inertial Alignment Modes. INS alignment modes which can be selected using the INS knob are CV (carrier alignment), GND (ground alignment), IFA (in-flight alignment), and GYRO

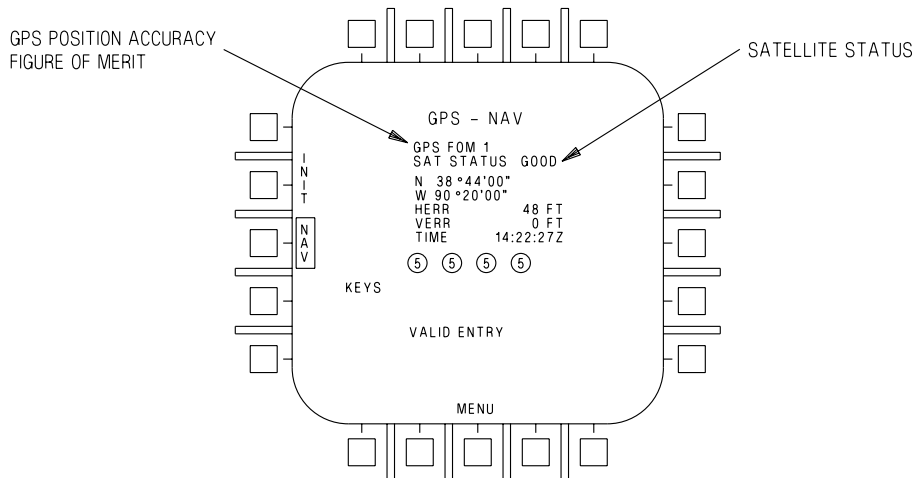

EFN520-431-1-016

Figure 24-3. GPS Page

(AHRS attitude only). A Stored Heading alignment may also be selected to reduce CV/GND alignment time if certain conditions are met.

During the first 30 seconds to 2 minutes of all alignments, NO ATT is displayed to the right of QUAL on the HSI alignment display and the INS ATT caution is set. After the platform has leveled, NO ATT is replaced with a quality (QUAL) number and the INS begins to determine true north. The QUAL number is an estimate of present position accuracy in nm/hr 95 % (CAINS) or nm/hr CEP (ANAV). The INS ATT caution clears when the QUAL number becomes less than 5. Also during the alignment, the GPS is initialized with WYPT 0, ZTOD, DATE, almanac and GPS waypoints if the aircraft is WonW. After initialization, the GPS is commanded to search and acquire GPS satellites. OK is displayed next to the QUAL number when a satisfactory alignment is achieved and the INS can be switched to IFA (POS/AINS) or NAV (POS/INS). Also during the alignment, the TIME increments. The TIME stops incrementing and flashes when the INS suspends alignment due to premature parking brake release (GND or CV), parking brake release and motion detected (GND, ANAV only), GPS data unavailable (IFA), ship INS (SINS) data unavailable (CV), POS ERROR caution set (ANAV only), or waiting for carrier data entry or carrier heading and/or carrier velocity changes during CV Manual alignment.

NOTE

With ANAV installed, changing the INS boresight values during alignment causes the INS to re-initialize the alignment.

24.2.3.1 CV Alignment Modes. Turning the INS knob to CV provides CV alignment options of RF (radio frequency), CBL (cable), and MAN (manual). During a RF or CBL alignment, the aircraft is

data linked to the ship's INS (SINS). The MAN option has no data link capability and alignment data must be entered manually. Before selecting CV, WYPT 0, ZTOD and DATE should be entered and the parking brake set. The parking brake must remain set until a satisfactory alignment is achieved (OK displayed). If the parking brake is released before OK is displayed and the QUAL number is greater than 5, the INS switches to GYRO mode (AHRS attitude only). A complete re-initialization is required to achieve a satisfactory alignment (OK displayed). This can be accomplished by turning the INS knob to OFF for 20 seconds and then selecting either IFA or CV. If the parking brake is released before OK is displayed and the QUAL number is less than or equal to 5, the INS switches to POS/INS with limited performance. This partial alignment can be completed by selecting IFA.

24.2.3.1.1 RF/CBL SINS Alignment. During the CV RF/CBL SINS alignment, the INS automatically compensates for the difference between the aircraft deck position and SINS position. To perform this alignment, the parking brake must be set and the INS knob turned to CV. The navigation system and data link are turned on and CV alignment data is displayed on the HSI (figure 24-4). For an RF alignment, information is received by radio frequency and CV RF is displayed. The alignment frequency is displayed on the UFCF scratchpad for 30 seconds after selecting CV and may be changed using the UFCF keypad. When a cable is connected to the aircraft, information is received on the cable and CV CBL is displayed. RF/CBL and the TIME flashes until the SINS data becomes valid. If the SINS data becomes invalid during the alignment, the TIME flashes and the INS suspends the alignment until the SINS data becomes valid again. If the SINS data remains invalid for 30 seconds, the INS automatically switches to CV Manual alignment using the last valid SINS data the INS received. If the SINS data becomes valid during CV Manual alignment, the INS automatically switches back to CV SINS alignment. CV SINS alignment time is normally less than 10 minutes.

While the platform is being leveled, a total of 10 waypoints can be received. When 10 waypoints have been received, WYPTS is displayed below the TIME. If all waypoint data is not received, NO WYPTS is displayed below the TIME. Reception of waypoint data is not required for the alignment to proceed.

24.2.3.1.2 CV MAN (Manual) Alignment. A CV Manual alignment can be performed if the data link signal is not available or not desired, or occurs automatically if the CV SINS data is invalid for more than 30 seconds. CV Manual alignment requires entering CV data on the UFCF. To perform this alignment, the parking brake must be set and the INS knob turned to CV. The navigation system and data link are turned on and CV alignment data is displayed on the HSI. Selecting the MAN option on the HSI enables the CV Manual alignment display on the HSI and UFCF (figure 24-4). MAN is boxed when selected and the STD HDG option is removed. Carrier latitude/longitude data (POSN), heading (CHDG), and speed (CVEL) are entered through the UFCF. The INS uses this data to update present position during the alignment. If the carrier heading changes more than 10° or carrier speed changes more than 1 knot, the aircrew must re-enter carrier data to reinitialize the alignment. In the case where the CV SINS data was invalid for more than 30 seconds, the INS uses the last valid SINS data to complete a CV Manual alignment. If this occurs, no carrier data entry is required. CV Manual alignment time is approximately 15 minutes.

CV MANUAL ALIGNMENT

1. Parking brake - SET

The parking brake must remain set until a satisfactory alignment is achieved (OK displayed). If the parking brake is released before OK is displayed and QUAL > 5, the alignment must be restarted. If the parking brake is released before OK is displayed and QUAL < 5, the partial alignment may be completed by selecting IFA.

2. ATT switch - AUTO or INS

3. Enter WYPT 0, ZTOD, and DATE
4. INS knob - CV
5. HSI MAN option - SELECT

On the UFCD -

6. Enter Latitude (POSN) (leading zeroes must be entered)
7. Enter Longitude (POSN) (leading zeroes must be entered)
8. Enter Carrier Heading (CHDG) (0 to 360)
9. Enter Carrier Speed (CVEL) (0 to 63)

After a satisfactory alignment is achieved (OK displayed) -

10. INS knob - IFA (POS/AINS). If GPS not available, then INS knob - NAV (POS/INS)

24.2.3.2 Ground (GND) Alignment. To perform a ground alignment, the parking brake must be set, WYPT 0, ZTOD and DATE entered, and the INS knob turned to GND. The navigation system is turned on and GRND alignment data is displayed on the HSI (figure 24-5). If the aircraft is taxied during the alignment, the INS suspends the alignment as indicated by the TIME flashing. With ANAV installed, the aircraft may be taxied without restarting the alignment if the QUAL number is less than or equal to 5.

NOTE

The most accurate alignment of the INS is achieved by changing aircraft heading at least 70° (180° optimum) after OK is displayed next to the QUAL number and allowing the alignment to continue. An alignment with TIME greater than 12 minutes has little to no benefit.

The MC automatically transfers WYPT 0 to the INS to be used as aircraft present position. This information appears on the GRND alignment display. WYPT 0 position can be updated prior to selecting GND but if an error is noticed after the alignment has begun, aircraft present position must be corrected because WYPT 0 is transferred to the INS only once. If aircraft present position is incorrect, it must be corrected or the INS will align improperly. Refer to Aircraft (A/C) Programming (this chapter) to enter new aircraft position data.

CAINS Only: The INS restarts the alignment if more than one position update is performed. If the parking brake is released at any time during the alignment, the alignment suspends. If the parking brake is set, the alignment continues within 20 seconds if the QUAL number is less than or equal to 5 or restarts if the QUAL number is greater than 5.

ANAV Only: The INS does not restart the alignment if the position is updated with TIME less than 30 seconds and if the update is no more than 0.4 nm from the original position. After 30 seconds, any position update restarts the alignment. The parking brake may be released with TIME greater than 30 seconds; however, if the INS detects aircraft motion with the parking brake released, the INS suspends the alignment until no motion is detected for 20 seconds, at which point the alignment continues if the QUAL number is less than or equal to 5 or restarts if the QUAL number is greater than 5.

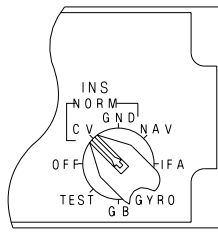

INS MODE SELECT KNOB

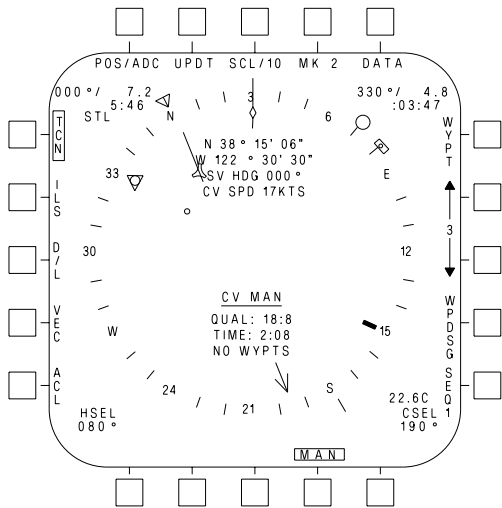

MANUAL CARRIER ALIGN DISPLAY

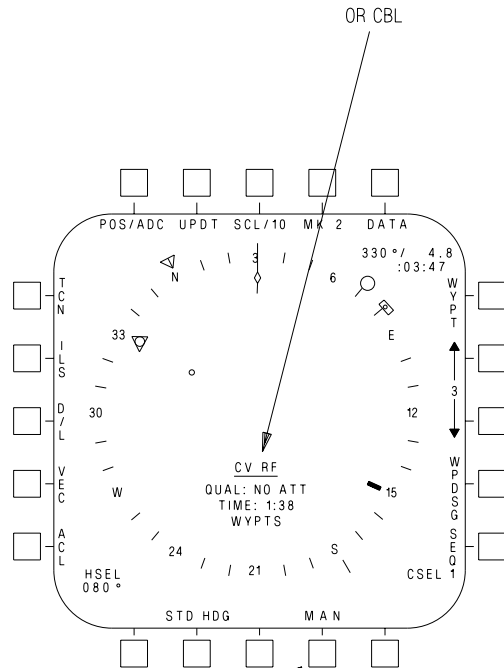

RF OR CABLE CARRIER ALIGN DISPLAY

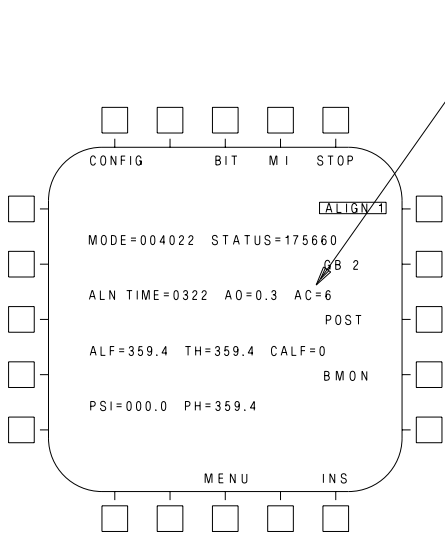

INS MAINTENANCE ALIGN 1 DISPLAY

0	'	"	POSN	CH12 122.500
	N		CHDG	
W		E	CVEL	
	S			
CLR		ENT	CNI	CH 6 116.500

MANUAL CARRIER ALIGN OPTIONS

Figure 24-4. INS CV Align

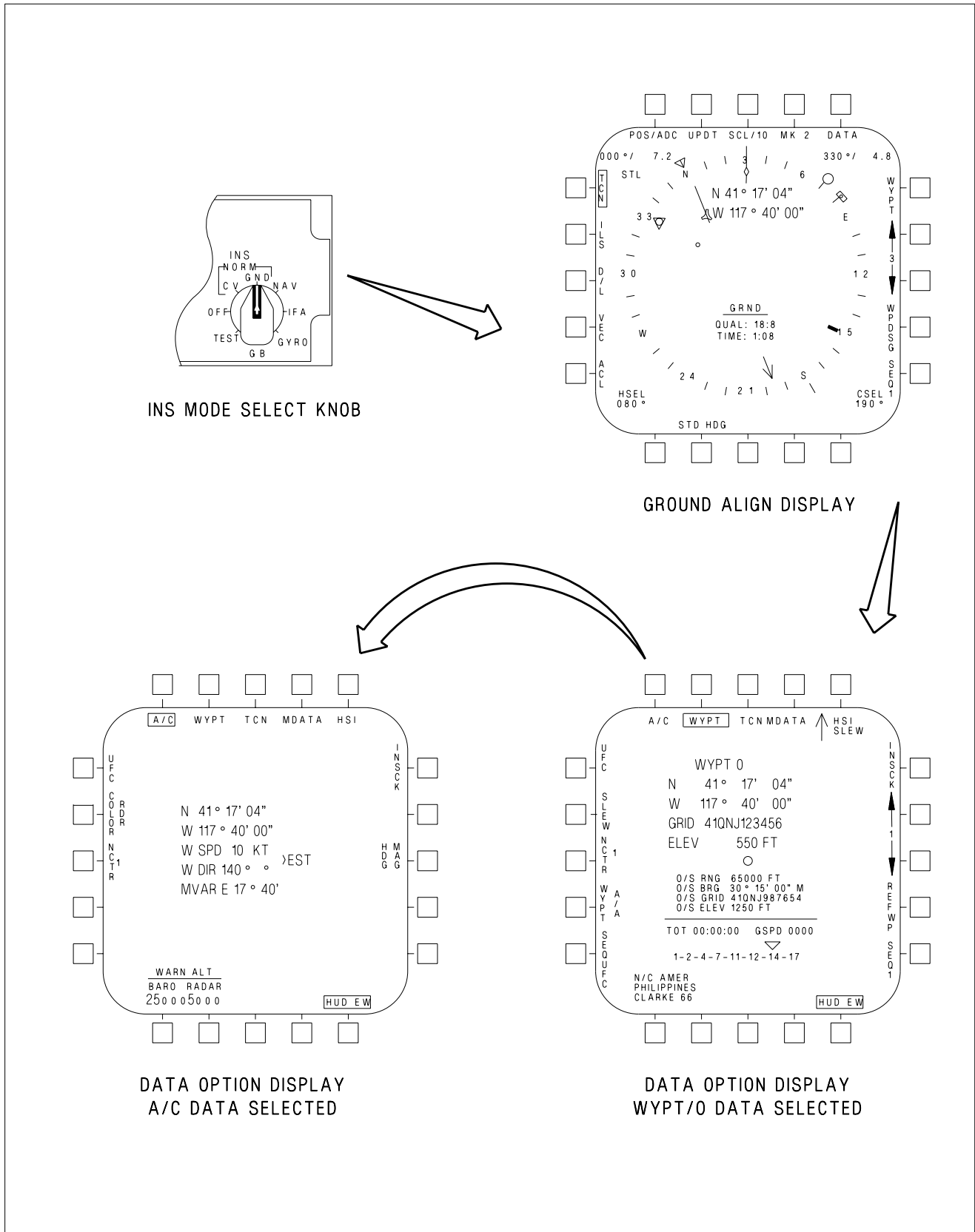

Figure 24-5. INS Ground Align

EFN520-108-1-010

If the aircraft takes off in GND mode before OK is displayed and the QUAL number is greater than 5, the INS switches to GYRO mode (AHRS attitude only). If the aircraft takes off in GND mode before OK is displayed and the QUAL number is less than or equal to 5, the INS switches to POS/INS mode with limited performance. These partial alignments can be completed by selecting IFA.

24.2.3.3 Stored Heading (STD HDG) Alignment. A Stored Heading alignment may be performed to reduce alignment time if the INS was turned off after a good alignment, the parking brake was set at shutdown, and no other INS mode was selected prior to turning the INS knob to OFF. The STD HDG option is provided on the HSI CV/GND alignment display if available (figure 24-5). The STD HDG option is removed when a GND or CV SINS alignment has progressed to the point where selecting the STD HDG option would not reduce alignment time; or, during a CV alignment, when the MAN option is selected.

Selecting the STD HDG option results in an alignment based on the stored heading when the INS was turned off. To perform a Stored Heading alignment, the parking brake must be set, WYPT 0, ZTOD, and DATE entered, the INS knob turned to CV or GND, and the STD HDG option selected. During a Stored Heading alignment, the INS checks if the current heading is the same as the previous alignment's heading. If so, OK is displayed next to the QUAL number for CAINS, within 3 minutes for a GND alignment and within 4 minutes for a CV SINS alignment; for ANAV, within 30 seconds for a GND alignment and within 60 seconds for a CV SINS alignment. After OK is displayed, the INS knob can be turned to IFA (POS/AINS) or NAV (POS/INS). If the aircrew allows the alignment to continue, the QUAL number may decrease as the alignment continues normally.

If the aircrew believes that the aircraft has been moved or its shutdown heading has changed either on the ground or with respect to the carrier deck, a Stored Heading alignment should not be attempted even if the STD HDG option is available. If the aircraft has moved, poor performance may result if a Stored Heading alignment is achieved.

24.2.3.4 In-Flight Alignment (IFA). An IFA may be used with WonW (IFA GPS only) or in-flight to perform a complete alignment (e.g., INS failure) or complete a partial CV/GND alignment. With the APG-73 Radar installed, an IFA can be performed with either magnetic heading and radar precision velocity update (PVU) data (IFA RDR), or with GPS satellite data (IFA GPS). With the APG-79 Radar installed, an IFA can only be performed with GPS satellite data (IFA GPS). An IFA should be considered a backup alignment mode to GND and CV alignments.

NOTE

The APG-79 Radar does not perform PVUs; therefore, radar IFA is not possible. However, IFA RDR is displayed until good GPS satellite data is acquired.

Present position can be provided but is not required for the alignment by performing a position update using the UPDT option or by entering the aircraft data on the UFCF using the DATA option. Another very good technique is to select TACAN position keeping if a stationary TACAN is available. Velocity updates cannot be performed during an IFA. The VEL update option is displayed but is not functional.

24.2.3.4.1 IFA (APG-73). Select STBY with the ATT switch to verify the accuracy of HUD attitude data by crosschecking the standby instruments. If POS/MIDS is the current position keeping mode, select POS/ADC.

NOTE

If POS/MIDS is the current position keeping mode, select POS/ADC before commencing IFA procedures.

Select NAV master mode and radar altitude to the HUD. Then turn the INS knob to OFF for 20 seconds. On the SUPT/HSI/DATA/(A/C) page, check magnetic variation, present position, and winds aloft. To check the magnetic variation, observe the magnetic variation value on the SUPT/HSI/DATA/(A/C) page or observe the difference between true heading and magnetic heading and compare this to the known local magnetic variation. If aircraft data is incorrect, refer to Aircraft (A/C) Programming (this chapter) to update.

NOTE

- Checking and correcting magnetic variation is critical. Excessive drift error in magnetic variation causes insidious errors in aircraft heading. This induces navigation deviations that are especially significant during instrument departures and approaches.
- Since the magnetic variation changes as a function of the aircraft position (latitude/longitude), the correct local magnetic variation must be manually re-entered periodically to maintain an error-free magnetic heading. Updating the magnetic variation every 100 NM is sufficient as long as the aircraft does not fly near or greater than 60° North or South latitude. In these Polar Regions, magnetic variation (as well as magnetic heading) changes significantly as a function of aircraft position change. Flying True Heading is advisable in these regions.

If the IFA is being performed with WonW, enter WYPT 0, ZTOD and Date. If in flight, maintain straight and level, unaccelerated flight for 20 seconds, then turn the INS knob to IFA. The navigation system is turned on and IFA alignment data is displayed on the HSI (figure 24-6). IFA RDR is displayed but may immediately switch to IFA GPS with good satellite data. If IFA GPS is displayed, complete the alignment with the IFA GPS Indicated steps. Maintain straight and level flight for at least 30 seconds after selecting IFA. When IFA is selected, the radar may enter the PVU mode. In the PVU mode, CONT PVU and SEA options are boxed (default selection). Verify that the proper radar PVU mode is selected (LAND or SEA) and observe that the TIME begins to increment. During the first 10 to 15 seconds of the alignment while the INS platform is being leveled, NO ATT is displayed to the right of QUAL. Wait until after NO ATT clears and is replaced with the QUAL number. Then select AUTO or INS with the ATT switch and the INS ATT caution clears when the QUAL number becomes less than 5.0. Selecting AUTO or INS replaces standby attitude reference indicator data on the HUD with INS attitude data. The waterline symbol is replaced with the velocity vector which may be slowly flashing if vertical velocity is degraded. The velocity vector continues to slowly flash until vertical velocity becomes valid (when the QUAL number is approximately 5.0). When horizontal position becomes valid, the POS/ADC caution clears.

IFA RDR Indicated -

Maintain straight and level flight for as much as practical during the alignment. If a turn must be executed, rapidly exceed 30° AOB and return to straight and level flight as soon as possible. This prevents the INS from aligning to a false reference by placing the alignment on hold until straight and level flight is regained. During an IFA, air data dead reckoning is used for navigation to maintain a current present position. When a satisfactory alignment is achieved (OK displayed), turn the INS knob to NAV. For landing, crosscheck HUD information with the standby instruments.

WARNING

Following an IFA RDR, make every attempt to maintain VMC with a discernible horizon. Residual attitude errors may be subtle and difficult to discern without reference to a visible horizon or the standby instruments. If velocity vector information is suspect, select STBY to the HUD.

PVU mode may be overridden by deselecting the CONT PVU option but IFA quality will be affected. Deselecting CONT PVU alternates PVU mode with the last selected radar mode. In PVU mode, the radar provides Doppler velocities for INS alignment. The radar look-down angles are optimized for land or sea return by selection of the LAND or SEA option. PVU is inhibited for IFA if the aircraft is not in the NAV master mode. If the radar is not operating or is inhibited from operating in PVU, the TIME flashes and the CONT PVU option is not displayed.

IFA GPS Indicated -

Perform one gentle 90° S-turn (less than 20° AOB and ± 10° pitch) to facilitate the alignment. Then maintain straight and level flight as much as practical. When a satisfactory alignment is achieved, the IFA alignment data is removed from the HSI and the MC automatical transitions to POS/AINS position keeping mode. GPS IFA takes approximately 10 minutes.

If good GPS satellite data is lost prior to achieving a satisfactory alignment (OK not displayed) during a GPS IFA, the INS suspends the alignment. If good satellite data is re-acquired within 65 seconds, the INS continues to align using GPS data. If good satellite data is not re-acquired within 65 seconds, the MC attempts to complete the alignment with a radar IFA as described in IFA RDR Indicated. If WonW, wait until good GPS satellite data is available (SAT STATUS = GOOD on the GPS page) or turn the INS knob to OFF for 20 seconds and perform the appropriate alignment (GND or CV). If good GPS satellite data is lost after achieving a satisfactory alignment using GPS data, the position keeping mode defaults to POS/INS and a P/INS advisory is displayed until good GPS satellite data is available (SAT STATUS = GOOD on the GPS page) and then the position keeping mode automatically returns to POS/AINS and the P/INS advisory clears.

IN-FLIGHT ALIGNMENT (APG-73)

1. ATT switch - STBY
2. If POS/MIDS is the current aircraft position keeping mode, select POS/ADC.
3. NAV master mode - SELECT
4. ALT switch - RDR
5. INS knob - OFF (20 seconds minimum)

6. HSI/DATA/(A/C) page - Update MVAR, position, and winds aloft (if required).
7. If WonW, enter WYPT 0, ZTOD and DATE.
8. If in flight, maintain straight and level, unaccelerated flight for 20 seconds prior to selecting IFA.
9. INS knob - IFA
10. Maintain straight and level, unaccelerated flight for at least 30 seconds after selecting IFA.
11. HSI page - SELECT SEA or LAND (IFA RDR only)

After NO ATT is cleared from the HSI -

12. ATT switch - AUTO or INS (VV position is degraded if flashing slowly)

IFA RDR indicated -

13. Maintain straight and level flight as much as practical during alignment. If a turn must be executed, rapidly exceed 30° AOB and return to straight and level flight as soon as possible.

When QUAL indicates OK (approximately 20 minutes) -

14. INS knob - NAV

WARNING

Following an IFA RDR, make every attempt to maintain VMC with a discernible horizon. Residual attitude errors may be subtle and difficult to discern without reference to a visible horizon or the standby instruments. If velocity vector information is suspect, select STBY to the HUD.

For landing -

15. Crosscheck HUD information with standby instruments.

IFA GPS indicated -

13. Perform one gentle 90° S-turn (less than 20° AOB and $\pm 10^\circ$ pitch), then maintain straight and level flight as much as practical.

Within approximately 10 minutes -

14. HSI page -Verify transition to POS/AINS.

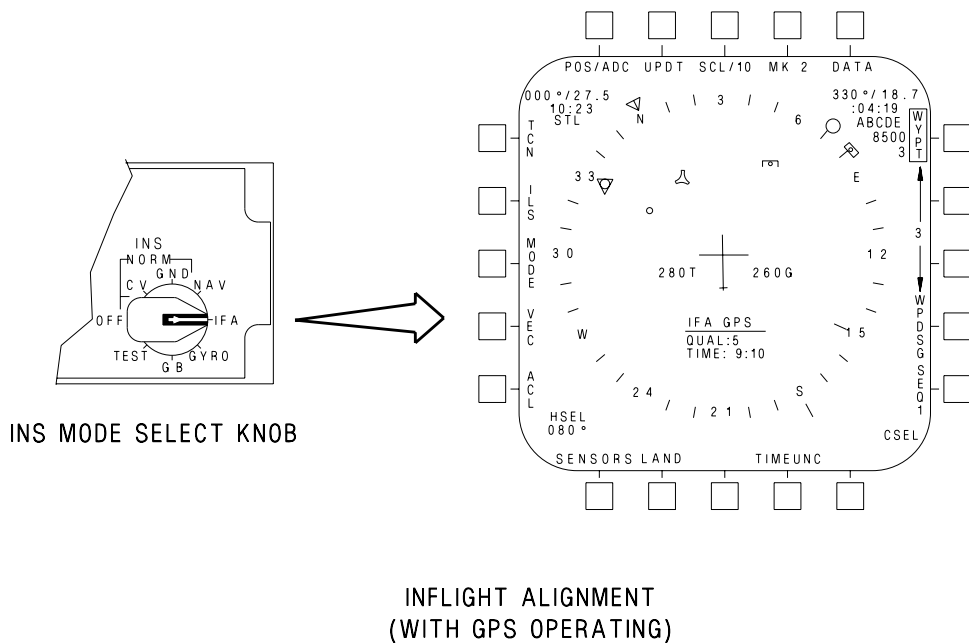
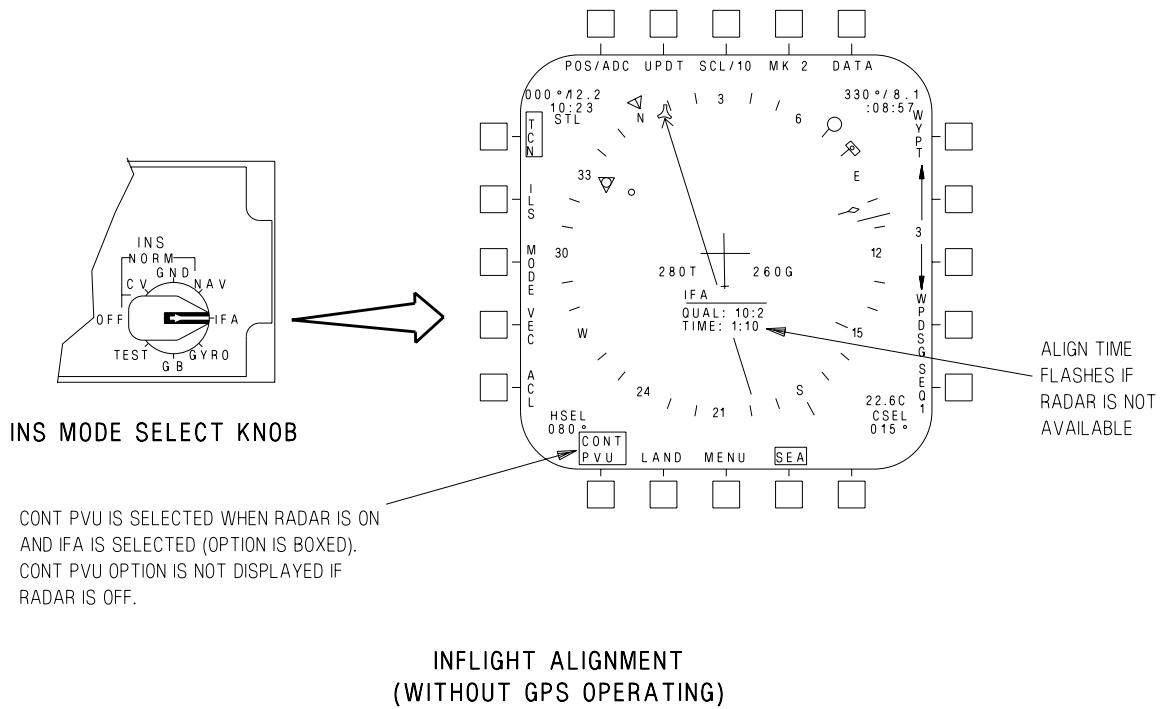

EFN520-329-1-010

Figure 24-6. INS In-Flight Align

24.2.3.4.2 IFA (APG-79). Select STBY with the ATT switch to verify the accuracy of HUD attitude data by crosschecking the standby instruments. If POS/MIDS is the current position keeping mode, select POS/ADC.

NOTE

If POS/MIDS is the current position keeping mode, select POS/ADC before commencing IFA procedures.

Select NAV master mode and radar altitude to the HUD. Then turn the INS knob to OFF for 20 seconds. If the IFA is being performed with WonW, enter WYPT 0, ZTOD, and DATE. Turn the INS knob to IFA and the navigation system is turned on and IFA alignment data is displayed on the HSI (figure 24-6). While waiting for the GPS to acquire good GPS satellite data, IFA RDR is displayed, the TIME flashes, and the INS suspends the alignment. Once good GPS satellite data is acquired, IFA GPS is displayed and the alignment begins. During the first 10 to 15 seconds of the alignment while the INS platform is being leveled, NO ATT is displayed to the right of QUAL. Maintain straight and level, unaccelerated flight to level the INS and clear the NO ATT indication. NO ATT is replaced with the QUAL number. Then select AUTO or INS with the ATT switch and the INS ATT caution clears when the QUAL number becomes less than 5.0. Selecting AUTO or INS replaces standby attitude reference indicator data on the HUD with INS attitude data. The waterline symbol is replaced with the velocity vector which may be slowly flashing if vertical velocity is degraded. The velocity vector continues to slowly flash until vertical velocity becomes valid. When the GPS horizontal position becomes valid, the POS/ADC caution clears. Perform one gentle 90° S-turn (less than 20° AOB and ±10° pitch) to facilitate the alignment. Then maintain straight and level flight as much as practical. When a satisfactory alignment is achieved, the IFA alignment data is removed from the HSI and the MC automatically transitions to POS/AINS position keeping mode. IFA takes approximately 10 minutes. This time can be greatly reduced by performing the S-turn.

An IFA may be used to complete a partial CV/GND alignment. At takeoff with a partial alignment, the INS platform should already be leveled (NO ATT replaced with a QUAL number). Select IFA and the position keeping mode automatically transitions to POS/AINS once a satisfactory alignment has been achieved. Completing a partial alignment with an IFA may occur very quickly.

If good GPS satellite data is lost prior to achieving a satisfactory alignment (OK not displayed), the INS suspends the alignment. If good satellite data is not re-acquired within 65 seconds, the TIME flashes. Wait until good GPS satellite data is available (SAT STATUS = GOOD on the GPS page) or if WonW, turn the INS knob to OFF for 20 seconds and perform the appropriate alignment (GND or CV). If good GPS satellite data is lost after achieving a satisfactory alignment, the position keeping mode defaults to POS/INS and a P/INS advisory is displayed until good GPS satellite data is available and then the position keeping mode automatically returns to POS/AINS and the P/INS advisory clears.

IN-FLIGHT ALIGNMENT (APG-79)

1. ATT switch - STBY
2. If POS/MIDS is the current position keeping mode, select POS/ADC.
3. NAV master mode - SELECT
4. ALT switch - RDR

5. INS knob - OFF (20 seconds minimum)
6. If WonW, enter WYPT 0, ZTOD, and DATE.
7. INS knob - IFA
8. Maintain straight and level, unaccelerated flight until NO ATT is cleared from the HSI.
9. ATT switch - AUTO or INS (VV position is degraded if flashing slowly)
10. Perform one gentle, 90° S-turn (less than 20° AOB and $\pm 10^\circ$ pitch), then maintain straight and level flight as much as practical.

Within approximately 10 minutes -

11. HSI page - Verify transition to POS/AINS

24.2.3.5 Gyro Recovery. A gyro recovery is actually an AHRS attitude only INS in which reliable INS attitude data is recovered. With CAINS installed, the GPS may already be operating. With ANAV installed, if the GPS is functional, the GPS initializes and acquires satellites. Select AUTO or INS with the ATT switch and maintain straight and level, unaccelerated flight. Turn the INS knob to OFF for 20 seconds prior to selecting GYRO. The INS ATT caution does not clear and standby attitude reference indicator data on the HUD remains until GPS velocity data is valid if operational. If takeoff occurs with a partial alignment, GYRO mode is available.

24.2.4 Navigation System BIT.

24.2.4.1 CAINS and GPS. The INS and GPS uses start-up, periodic and initiated built-in test (BIT). Start-up BIT is performed when power is applied to the INS or GPS. Periodic BIT monitors essential parameters within the system and provides in-flight, shipboard, and ground failure detection and isolation. Initiated BIT is performed on the ground and accomplishes that portion of the failure detection and isolation capability which periodic BIT is unable to do. Initiated BIT can be performed by selecting the INS (with the INS knob in TEST) or the GPS option on the NAV sublevel of the BIT page. BIT status is displayed on the BIT page next to the INS and GPS legends.

24.2.4.2 ANAV. The ANAV (INS and GPS) uses start-up, periodic and initiated built-in test (BIT). Start-up BIT is performed when power is applied to the ANAV. Periodic BIT monitors essential parameters within the system and provides in-flight, shipboard, and ground failure detection and isolation. Initiated BIT is performed on the ground and accomplishes that portion of the failure detection and isolation capability which periodic BIT is unable to do. Initiated ANAV BIT can be performed by turning the INS knob to TEST and selecting the INS/GPS option on the NAV sublevel of the BIT page. If Initiated BIT is performed prior to the completion of Start-up BIT and the INS and GPS are functioning properly, the GPS reports PBIT GO. If Initiated BIT is performed after the completion of Start-up BIT and the INS and GPS are functioning properly, the GPS reports GO. BIT status is displayed on the BIT page next to the INS and GPS legends.

24.2.5 NAVCK Display. The NAVCK page allows analysis of INS/GPS/FCC air data function reliability (figure 24-7). The page is displayed by selecting the NAV CK option on the HSI A/C DATA page. The velocity check more readily indicates vertical or horizontal velocity discrepancy problems. INS, GPS and FCC air data function velocities are periodically compared and when an excessive disagreement is sensed, the NAV VVEL, NAV HVEL cautions or VVEL advisory (CAINS only) are set.

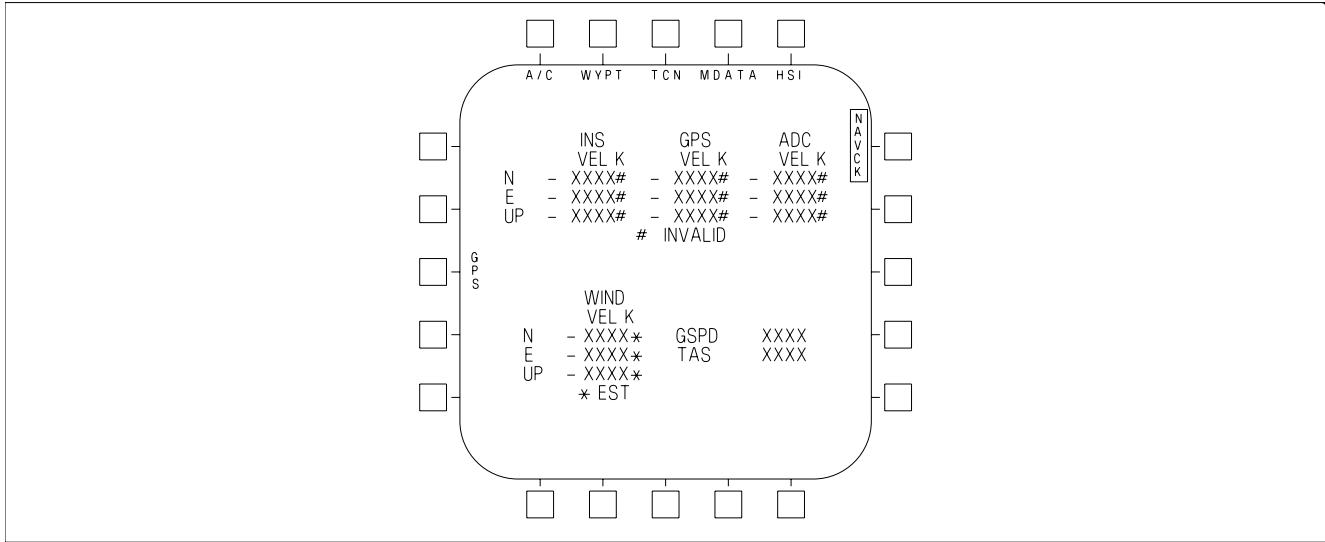

EFN520-114-1-004

Figure 24-7. NAVCK Display

The top portion of the page consists of INS, GPS and FCC air data function (ADC) velocities. The bottom portion consists of wind velocities, best available MC groundspeed (if valid) and best available MC true airspeed (if not zero). INS, GPS and ADC velocity components are displayed even if invalid. If INS, GPS or ADC data is invalid, a # is displayed to the right of the invalid data along with # INVALID at the bottom of the page. If wind velocity is estimated, an * (asterisk) is displayed to the right of the wind velocity components along with *EST at the bottom of the page.

24.2.6 GPS Page. The GPS page displays current GPS status (figure 24-3). The page is displayed by selecting the GPS option on the SUPT MENU.

The GPS operating mode is displayed at the top of the page (GPS – XXXX) with possible modes of NAV, INIT, NOT RDY, or TEST (see 24.2.2 for a description of operating modes). When the GPS is not in TEST, the NAV and INIT options are available. The use of these two options is not recommended.

The GPS Figure of Merit (FOM) is an indication of the estimated GPS position accuracy with a value from 1 to 9, with 1 being the best and 9 the worst. The following table shows the corresponding estimated accuracy.

FOM Value	Expected Position Error* (Meters)
1	Less than or equal to 25
2	Greater than 25 up to 50
3	Greater than 50 up to 75
4	Greater than 75 up to 100
5	Greater than 100 up to 200
6	Greater than 200 up to 500
7	Greater than 500 up to 1000
8	Greater than 1000 up to 5000
9	Greater than 5000

* 3-dimensional, 1-sigma

The SAT STATUS is an indication of satellite signal integrity. Possible indications are GOOD, MARGINAL, and JAMMED. An overall State 5 indicates GOOD, State 3 indicates MARGINAL, and if not in State 5 and not in State 3, JAMMED is indicated.

The GPS current position is displayed along with the GPS's Horizontal and Vertical Estimated Errors (HERR and VERR) in feet and GPS TIME.

Up to 4 individual satellite channel states are displayed. If the number of satellites in State 5 are greater than or equal to 4, all 4 positions indicate State 5. If less than 4 satellites are indicating State 5, the corresponding number of positions indicate State 5 and the remaining positions indicate State 3 or are blank.

The bottom of the page displays the crypto key status. Up to seven crypto key status messages can be displayed. Three of the status messages are mutually exclusive: VERIFIED, UNVERIFIED, and INCORRECT. The other six messages are displayed when reported by the GPS: GUV USER (group unique variables), KEY FAIL (key failed parity), INSUFF KEY (insufficient keys), ERASE FAIL (erase failure), 2 HR ALERT (2 hour alert), and VALID ENTRY (receiver contains keys).

24.2.7 INS Knob. The INS knob is located on the right hand console SNSR panel and has positions of OFF, CV, GND, NAV, IFA, GYRO, GB, and TEST.

OFF	Removes power from INS. With ANAV installed, removes power from the INS and GPS.
CV	Commands the INS carrier alignment mode. With ANAV installed, GPS initializes and acquires satellites.
GND	Commands the INS ground alignment mode. With ANAV installed, GPS initializes and acquires satellites.
NAV	Commands the INS to unaided navigation mode (POS/INS) which enables the MC to use unaided INS or GPS data to provide navigation steering.
IFA	Commands the INS in-flight alignment mode. Also commands the INS into aided navigation mode (POS/AINS) after a satisfactory alignment is achieved.
GYRO	Commands the AHRS mode. With ANAV, GPS initializes and acquires satellites.
GB	Commands the INS to CV or GND alignment mode indefinitely. With ANAV installed, GPS initializes and acquires satellites.
TEST	Enables the INS to perform an initiated BIT upon command from the MC. With ANAV installed, enables the INS and GPS to perform an initiated BIT upon command from the MC.

24.2.8 INS/GPS Related Cautions and Advisories. The following INS/GPS related cautions and advisories are described in the Warning/Caution/Advisory Displays in Part V:

- GPS DEGD caution
- INS ATT caution
- INS DEGD caution
- NAV FAIL caution
- NAV HVEL caution
- NAV VVEL caution
- POS/ADC caution
- POS ERROR caution
- ALGN (x'd out) advisory
- GPS advisory

- GPSMP advisory (ANAV only)
- NODOV advisory (ANAV only)
- NOSEC advisory
- P/INS advisory
- PCODE advisory
- VVEL advisory (CAINS only)
- YCODE advisory

24.2.9 Waypoints, Offset Aimpoints (OAP), and Offsets. A waypoint is a geographical point for which latitude, longitude, and elevation are stored in the MC. An OAP is a waypoint which has an offset associated with it. An offset is a point defined by bearing and range from the OAP along with elevation of the point (offset).

Mission data such as waypoints and offsets may be entered using the Data Transfer Equipment (DTE) and the mission initialization display or manually.

24.2.9.1 Waypoint/Offset Aimpoint Programming. Waypoint/OAP data is entered by selecting the DATA option on the waypoint data top level display. The waypoint data display is automatically initialized with WYPT boxed. This display shows the current waypoint/OAP data: waypoint lat/long position, UTM Grid coordinates, and elevation; offset range, GRID, bearing, and elevation (if applicable). Waypoint/OAP data is entered by selecting an up/down arrow to select the desired waypoint/OAP and the UFC option to initialize the UFCD for waypoint/OAP data entry. On the UFCD the following selections complete the selection: POSN option to enter lat/long data, ELEV option to enter elevation data, and O/S option to enter offset data (offset range, bearing, UTM grid coordinates and elevation). Offset data is in relation to the offset aimpoint. Waypoint/OAP data is entered through the UFCD keypad, with a maximum of 60 waypoints (0 to 59) available for programming. See figure 24-9, sheets 1 and 2.

Waypoint data can also be entered using the map slew method by selecting WYPT on the DATA option display, and actuating the SLEW button. Pressing the TDC and slewing the map to the desired lat/long position under the waypoint symbol locates the point.

NOTE

Lat/long and elevation data on the MPCD reflect the current map position under the waypoint symbol as the map is being slewed.

Upon release of the TDC the current waypoint data is entered for the map position under the waypoint symbol. Selecting the next waypoint number as required (using the waypoint increment/decrement option buttons) allows further waypoint data entry.

Another map slew method is to select WYPT on the DATA option display, actuating the SLEW button, and pressing and holding the TDC to slew the map to the desired lat/long position under the waypoint symbol. This position is entered by selecting another waypoint (using the waypoint increment/decrement option buttons). Continuing to hold the TDC, the map is slewed as required, and the next waypoint is selected for further waypoint data entry.

Offset aimpoints may also be entered using the map slew method; however, the associated offset must be entered through the UFCD.

24.2.9.1.1 GPS Waypoint Programming. Aircraft with GPS can utilize the GPS to store up to 200 waypoints. GPS points are loaded into the GPS from the memory unit. GPS points can be displayed

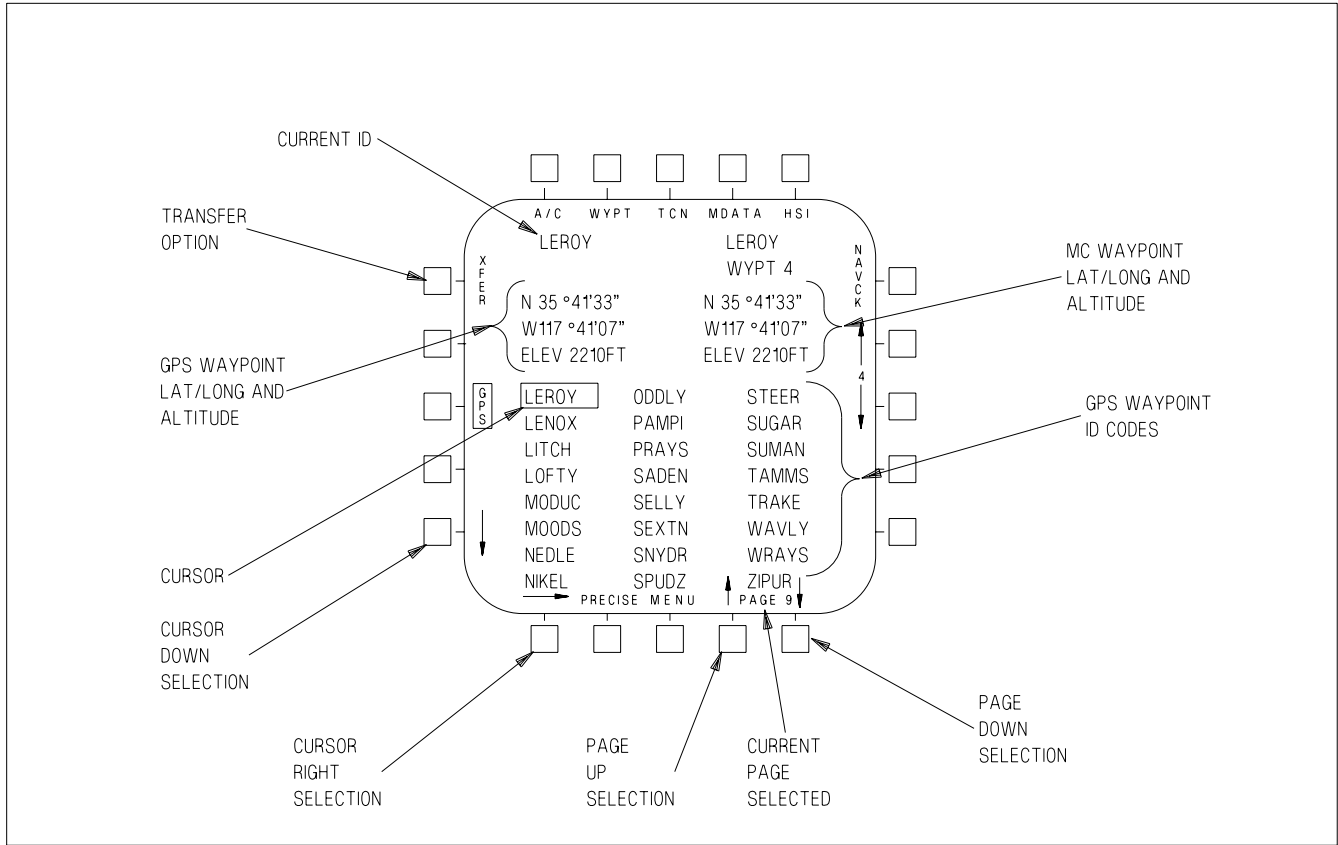

EFN520-330-1-001

Figure 24-8. GPS Waypoint Display

and/or transferred into the MC waypoint data base using the HSI/DATA/GPS display. A GPS point can be transferred into any MC waypoint by pressing the XFER option on the GPS display. When GPS option is selected the first 24 GPS points are displayed in alphanumeric order. Selection of points to load is accomplished by the right and down arrows and page selection arrows. Repeated selection of these arrows causes the cursor to wrap around. It may take as long as 3 seconds to retrieve selected position data and display it on the GPS display. See figure 24-8. GPS waypoints are transferred to the MC by selecting the desired waypoint number with the up/down arrows on the HSI/DATA/GPS sublevel, moving the cursor down/right and/or page up/down to the desired waypoint ID code, and pressing XFER. The GPS LAT/LONG, GPS altitude, and current ID code displays are blanked and the XFER option is removed. The selected ID code is displayed in the “Current ID” position indicating that waypoint is requested. After approximately 3 seconds, the requested GPS LAT/LONG and GPS altitude is displayed and the XFER option is returned for transfer selection. If a GPS ID code is requested and is not available, the selected ID code is displayed with a line through it. Once a GPS waypoint has been transferred from the GPS to the MC it becomes an MC waypoint. The waypoint ID code is retained and is displayed on the top level HSI and HSI/DATA/WYPT formats when the waypoint is selected as the current waypoint.

24.2.9.1.2 UTM Data Entry. Data for all waypoints and OAPs may be entered as universal transverse mercator (UTM) coordinates. See figure 24-9. UTM grid coordinates are defined by a spheroid, grid zone designation, square identification, and easting/northing. Grid zone designation divides the world area between N84° and S80° into 100 km squares. At power up with WonW the MC initializes

waypoint elevation, O/S range and elevation, and TACAN elevation in FEET, and O/S bearing to TRUE. UTM data for waypoints are entered by performing the following:

1. Select DATA/WYPT on the HSI top level display.
2. Select the desired spheroid by selecting the spheroid option.
3. Select UFC on the HSI. The first cockpit to select UFC has control of grid data entry and has the GRID display on the RDDI.
4. Select GRID on the UFCD. The MC determines the grid zone designation and 100 km square ID of the reference position and constructs a five by five Square Identification Grid (SIG) centered about the reference position and displayed on the RDDI. Reference position is either the A/C present position or the referenced waypoint position (REF WP Boxed).
5. Slew the acquisition cursor into the desired square, depress and release the TDC.
6. On the UFCD enter the six digit easting/northing and press ENT. Leading zeros must be input for easting/northing. The UTM coordinates are displayed on the HSI under the lat/long provided the latitude is within the N84° to S80° limits.

UTM data for O/S are entered by performing the following:

7. Select DATA/WYPT on the HSI top level display.
8. Select UFC on the HSI.
9. Select O/S on the UFCD.
10. Select Grid on the UFCD.
11. Slew the HOTAS cursor into the desired square, depress and release the TDC.
12. Enter O/S easting/northing in the UFCD.

The MC converts the UTM Grid coordinates to latitude/ longitude and then to range and bearing. O/S coordinates more than 400,000 feet from the OAP cause the UTM coordinates to flash in the O/S grid field on the HSI. The UTM coordinate is displayed in the O/S field on the HSI.

SIG square blanking must be checked any time the SIG is built. If the latitude is out of UTM range (above N84° or below S80°) the entire row is blanked. At certain latitudes, due to the convergence of the earth, individual squares are blank.

Grid shift options are provided to view and select grid squares in the eight adjacent grid squares whenever the A/C or Waypoint symbol is in the center square of the SIG and the adjacent SIGs exist. See figure 24-9. N, S, E, W, SE, SW, NE, or NW can be selected by pressing the grid shift options on the HSI, or by pressing and releasing the TDC when the HOTAS cursor is over a grid shift push button legend. The MC determines a new center position about which to construct a new SIG. Selecting the A/C or waypoint symbol returns the SIG to the original position.

Units can be input as FEET or MTRS for elevation; FEET, MTRS, NM, or YARD for range. The MC tests that all bearing, range and elevation data input through the UFCD are in the valid range.

Unit	Valid Range
Easting/Northing	000000 - 999999
Bearing	0 - 359° 59' 59"
Offset	0 - 400,000 FT 0 - 122,000 MTRS 0 - 66 NM 0 - 133,000 YDS

When data is outside the valid range, the MC causes the word ERROR to flash in the UFCD scratchpad and requires the data to be reinput.

24.2.9.2 TGT (Target) Programming. A target must be entered in a waypoint/OAP sequence so the MC can calculate the groundspeed required to arrive on target at the appropriate time. Only one waypoint/OAP can be designated as a target for all three sequences. A waypoint/OAP is identified as a target on the waypoint data sublevel display by an inverted triangle above the waypoint/OAP number in the waypoint/OAP sequence. At power up with WonW the previous target waypoint/OAP is cleared.

A waypoint/OAP as a target in a waypoint/OAP sequence is designated the DATA option on the MPCD top level display, the SEQUFC option on the waypoint data sublevel display to initialize the UFCD, and the TGT option on the UFCD. Waypoint/OAP number is entered on the UFCD keypad and the ENT option selected. The target waypoint/OAP is undesignated by either entering the target waypoint/OAP a second time or entering an invalid waypoint/OAP. See figure 24-9.

24.2.9.3 TOT (Time On Target) Programming. TOT pertains to the programmed target waypoint/OAP, and is relative to the programmed ZTOD (zulu time of day). ZTOD must be programmed before TOT can be entered. TOT is programmed from 00:00:00 to 23:59:59 and is displayed on the waypoint data sublevel display.

TOT is entered by selecting the DATA option on the MPCD top level display, selecting the SEQUFC option on the waypoint data sublevel display to initialize the UFCD, selecting the TOT option on the UFCD, entering the desired TOT value on the UFCD keypad, and selecting the ENT option. See figure 24-9.

24.2.9.4 Groundspeed Programming. Groundspeed pertains to the desired groundspeed for the final leg to the target waypoint in the sequence. Groundspeed values up to 999 knots may be entered.

Groundspeed is entered by selecting the DATA option on the HSI top level display, selecting the SEQUFC option on the waypoint data sublevel display to initialize the UFCD, selecting the GSPD option on the UFCD, entering the desired GSPD value on the UFCD keypad, and selecting the ENT option. See figure 24-9.

24.2.9.5 Waypoint/OAP Sequence Programming. A total of three waypoint/OAP sequences are available for waypoint/OAP sequence programming and a maximum of eight waypoint/OAPs may be programmed in each sequence. These sequences are used for AUTO sequential steering and time on target groundspeed cuing.

The waypoint data sublevel display on the HSI display must be used with the UFCD to allow the pilot to program a waypoint/OAP sequence. The SEQ # option on the lower right corner of the display indicates the waypoint/OAP sequence in use and initializes to the sequence selected on the HSI top level display. This option selects the sequence to be programmed (SEQ1, SEQ2, SEQ3, or SEQ4). Selecting the SEQUFC option, on the lower left corner of the display, initializes the UFCD for waypoint sequence programming. A waypoint/OAP cannot appear more than once in sequence but a waypoint/OAP may be entered in more than one sequence. Mark points cannot be programmed in a sequence. Each waypoint/OAP entered is placed to the right of the last waypoint/OAP in the sequence. If 15 waypoints/OAPs are programmed, the first waypoint in that sequence is deleted and the remaining waypoints/OAPs move to the left one space. Data for the current waypoint/OAP inserted/deleted in the sequence is provided on the waypoint data level display.

A new waypoint/OAP sequence is programmed by selecting:

1. The waypoint data sublevel display using the DATA option
2. The desired sequence route number using the SEQ # option
3. The SEQUFC option to initialize the UFCD for sequence programming
4. The INSERT option on the UFCD
5. The desired waypoint/OAP number via the UFCD keypad
6. The ENT option on the UFCD keypad.

Repeat steps 4 through 6 for each waypoint/OAP in the sequence. See figure 24-9.

Waypoints/OAP are inserted into an existing sequence by selecting:

1. The waypoint data sublevel display using the DATA option
2. The desired sequence route number using the SEQ # option
3. The SEQUFC option to initialize the UFCD for programming
4. The INSERT option on the UFCD
5. The number of the waypoint/OAP to the left of the desired insertion point via UFCD keypad
6. The ENT option on the UFCD keypad
7. Number of the waypoint/OAP to be inserted via the UFCD keypad
8. The ENT option via the UFCD keypad

Waypoints are deleted from a sequence by selecting:

1. The waypoint data sublevel display using the DATA option, the desired sequence route number using the SEQ # option
2. The SEQUFC option to initialize the UFCD for programming
3. The DELETE option on the UFCD

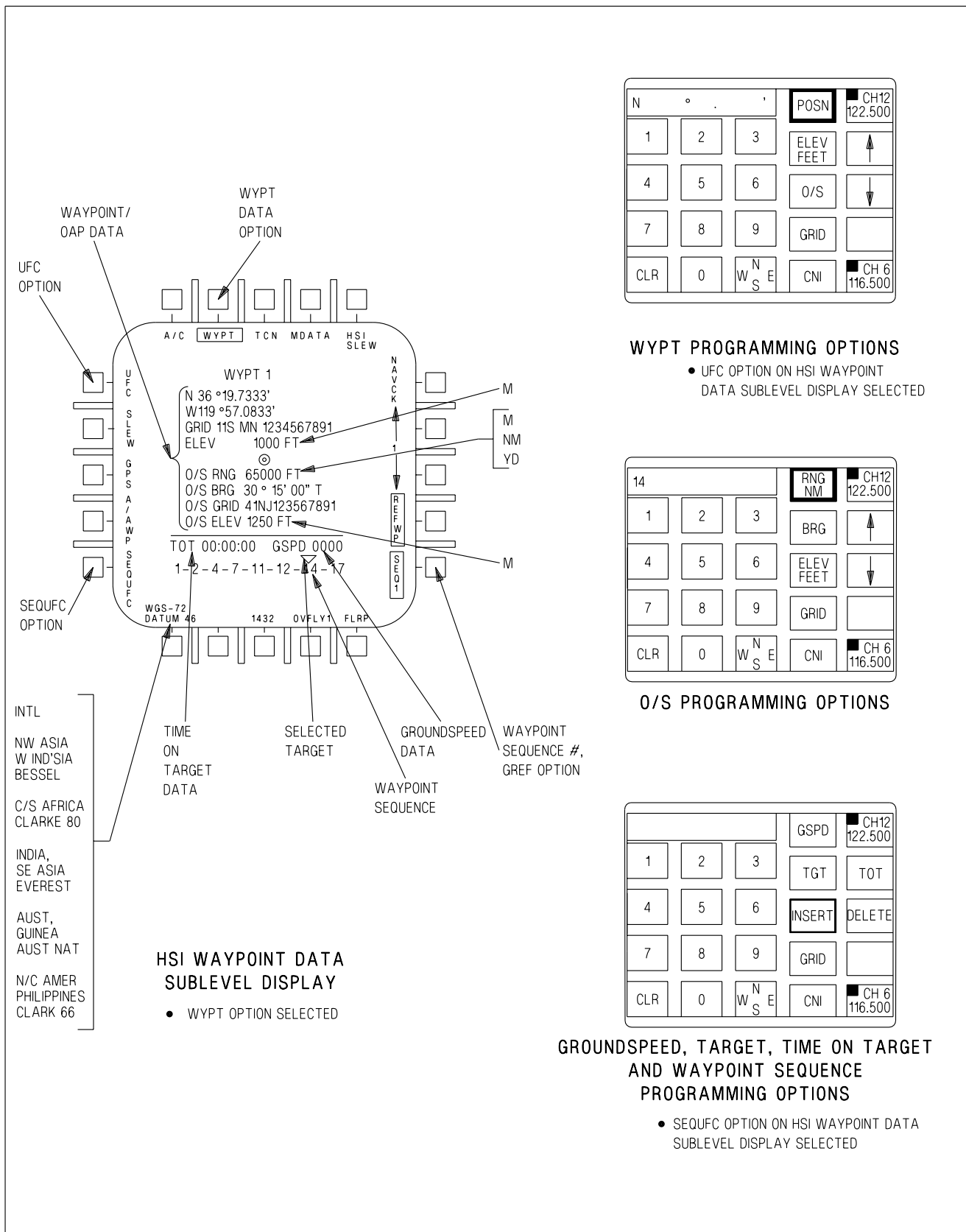

Figure 24-9. INS Programming (Sheet 1 of 4)

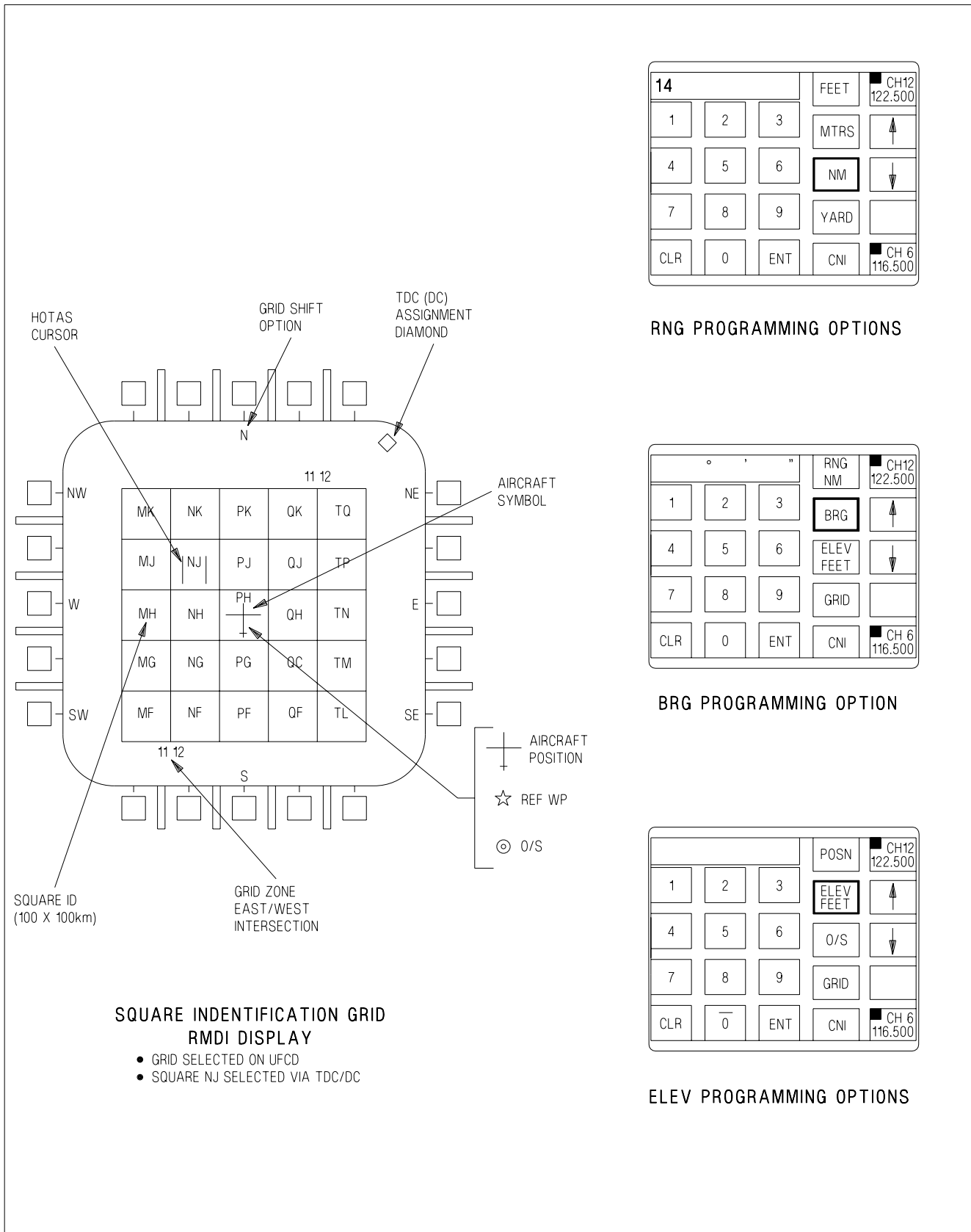
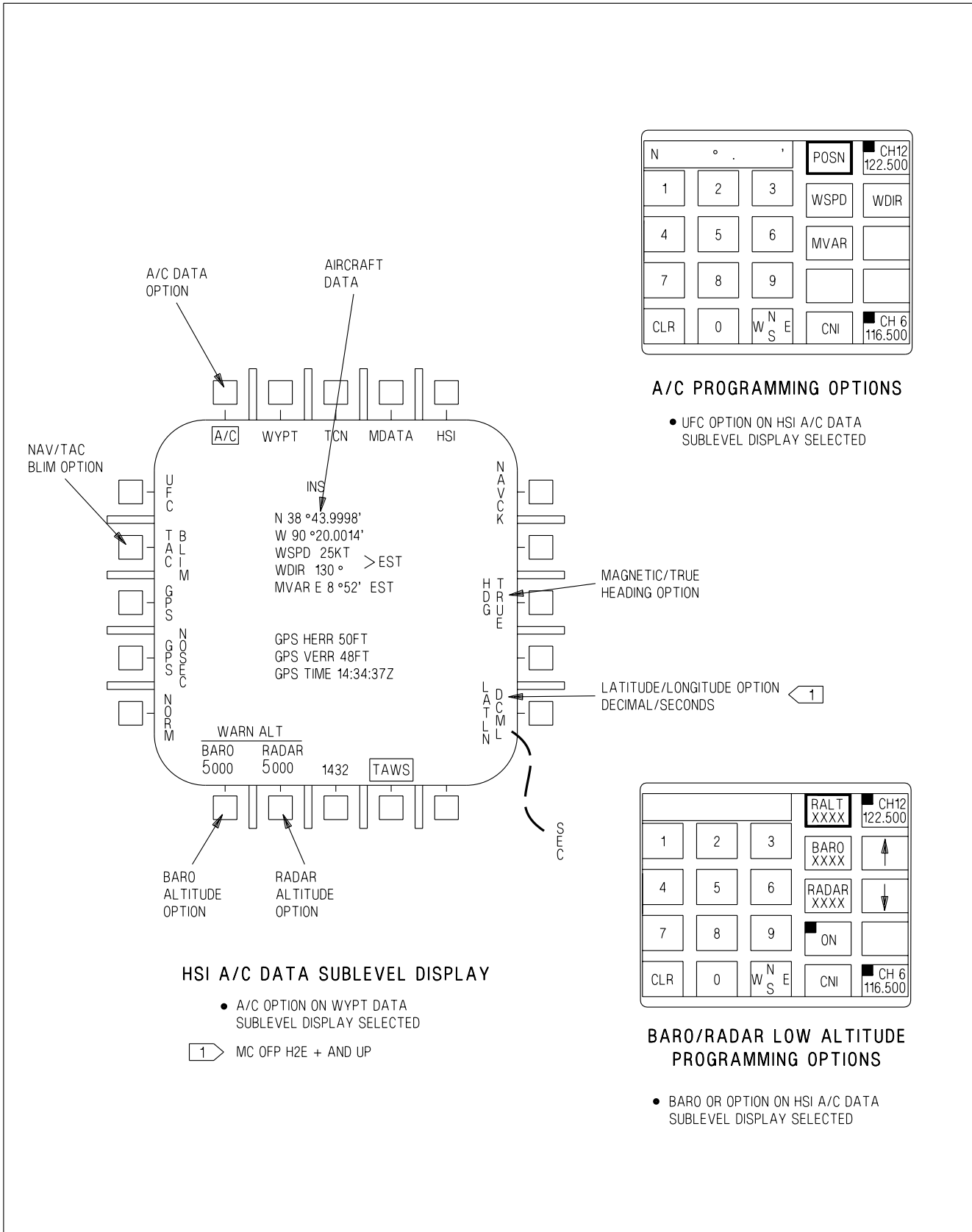

Figure 24-9. INS Programming (Sheet 2 of 4)



N	°	'	POSN	CH12 122.500
1	2	3	WSPD	WDIR
4	5	6	MVAR	
7	8	9		
CLR	0	W S	E N	CNI
				CH 6 116.500

A/C PROGRAMMING OPTIONS

- UFC OPTION ON HSI A/C DATA SUBLEVEL DISPLAY SELECTED

			RALT XXXX	CH12 122.500
1	2	3	BARO XXXX	↑
4	5	6	RADAR XXXX	↓
7	8	9	ON	
CLR	0	W S	E N	CNI
				CH 6 116.500

BARO/RADAR LOW ALTITUDE PROGRAMMING OPTIONS

- BARO OR OPTION ON HSI A/C DATA SUBLEVEL DISPLAY SELECTED

Figure 24-9. INS Programming (Sheet 3 of 4)

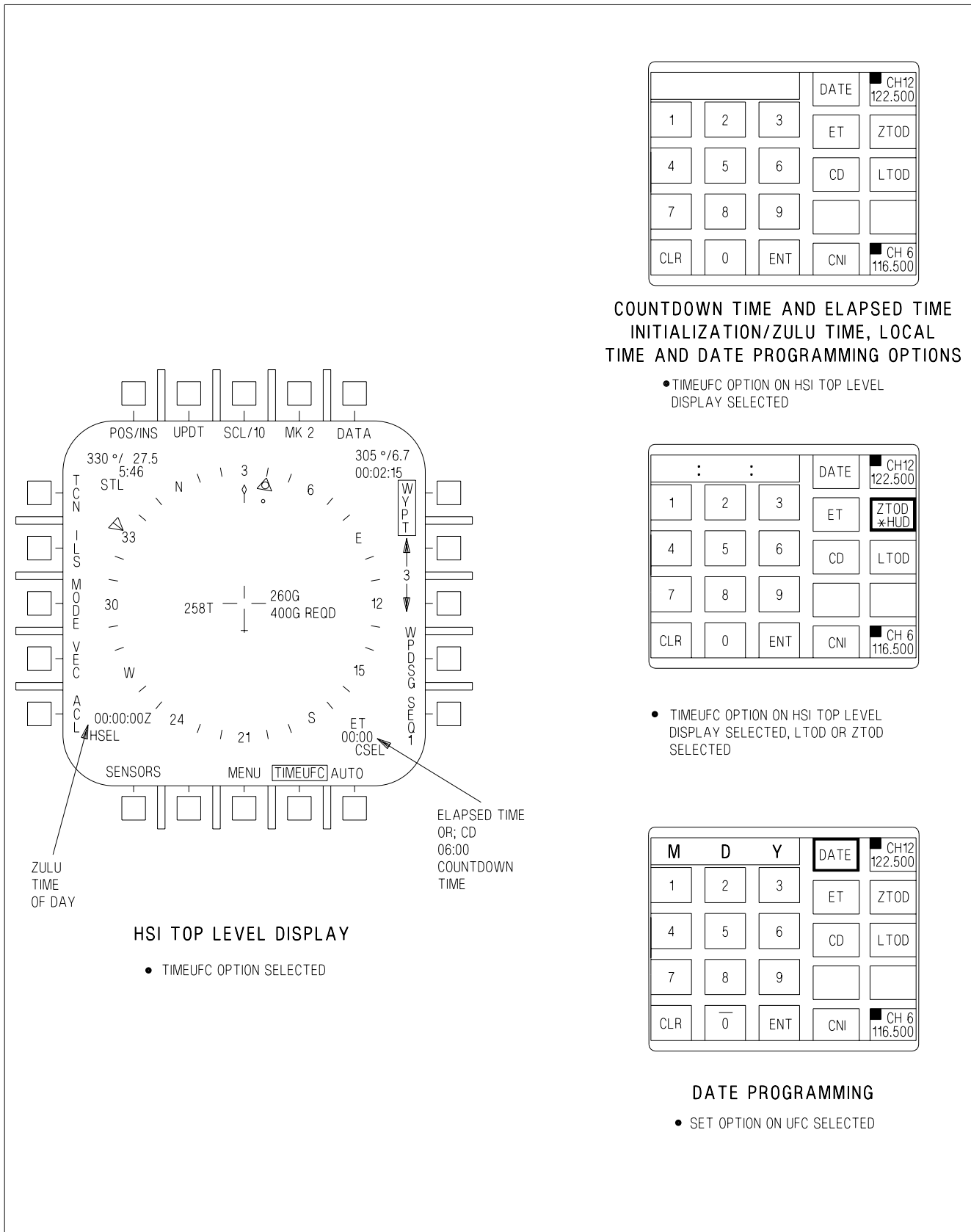

HSI TOP LEVEL DISPLAY

- TIMEUFC OPTION SELECTED

COUNTDOWN TIME AND ELAPSED TIME INITIALIZATION/ZULU TIME, LOCAL TIME AND DATE PROGRAMMING OPTIONS

- TIMEUFC OPTION ON HSI TOP LEVEL DISPLAY SELECTED

			DATE	CH12 122.500
1	2	3	ET	ZTOD
4	5	6	CD	LTOD
7	8	9		
CLR	0	ENT	CNI	CH 6 116.500

: :			DATE	CH12 122.500
1	2	3	ET	ZTOD *HUD
4	5	6	CD	LTOD
7	8	9		
CLR	0	ENT	CNI	CH 6 116.500

- TIMEUFC OPTION ON HSI TOP LEVEL DISPLAY SELECTED, LTOD OR ZTOD SELECTED

M	D	Y	DATE	CH12 122.500
1	2	3	ET	ZTOD
4	5	6	CD	LTOD
7	8	9		
CLR	0	ENT	CNI	CH 6 116.500

DATE PROGRAMMING

- SET OPTION ON UFC SELECTED

Figure 24-9. INS Programming (Sheet 4 of 4)

4. The number of the waypoint/OAP to be deleted via the UFCD keypad
5. The ENT option via the UFCD keypad

When a waypoint/OAP is deleted from a sequence all waypoints/OAPs to the right of the deleted waypoint/OAP shift left one space.

24.2.10 Aircraft (A/C) Programming. Aircraft data is entered by selecting the DATA option on the HSI top level display and the A/C option on the waypoint data sublevel display to bring up the A/C data sublevel display. This display shows the current aircraft data: latitude/longitude position, wind speed, wind direction, magnetic variation, and magnetic/true heading selection. Aircraft data is entered by selecting the UFC option to initialize the UFCD keypad for aircraft data entry, selecting the LATLN DCML or SEC option and then POSN option to enter lat/long data, the WSPD option to enter wind speed data, the WDIR option to enter wind direction, and MVAR to enter magnetic variation (degrees/minutes beginning with E or W).

NOTE

Entering a MVAR value without selecting the MVAR option will result in changing the aircraft position and may result in large INS position keeping errors.

24.2.10.1 Latitude/Longitude Display/Entry. With MC OFP H2E+ AND UP, latitude and longitude are displayed either as Degrees/ Minutes/ Ten Thousandths of minutes (LATLN DCML) or Degrees/Minutes/Seconds/Hundredths of seconds (LATLN SEC). Actuating the LATLN XXXX option toggles between the selection of LATLN DCML and LATLN SEC. The selected LATLN format is reflected on all displays and UFCD formats throughout the cockpit. DCML is the cold start default.

24.2.10.1A True/Magnetic Heading Selection. Heading indications that appear on the HUD and HSI display can be referenced to either true north or magnetic north. The capability to select a true north heading is useful in extreme northern operations. With true north heading selected, the HSI display, A/A and A/G radar displays, Link 4 display, and the HUD all are referenced to true north. The true north indication on the HUD is a T displayed below the current heading. True north indications on the HSI display consist of TRUE displayed below the current heading readout and a T displayed below the lubber line. The true heading indications on the HSI display also appear on the Link 4 display. No indications of true north selection appear on the A/A or A/G radar display. Since aircraft magnetic variation is used as the best available magnetic variation source, the heading reference should not be changed when navigating a selected course.

With true heading selected, TACAN symbology is also referenced to true north if the TACAN station is in the TACAN data table. If the TACAN station is not in the TACAN data table, magnetic heading is used. There is no indication when magnetic heading is selected. When INS true heading becomes invalid, magnetic heading is used. If MC1 fails, heading selection is not available. At power up with WonW the system initializes with magnetic heading selected. The reference heading is selected by selecting DATA on the HSI display and the A/C option to access the A/C data sublevel display. Actuating the HDG XXX option toggles between the selection of HDG TRUE and HDG MAG.

24.2.10.2 Barometric (BARO)/Radar Low Altitude Warning Programming. The BARO/RADAR altitude warning can be set up to a maximum of 25,000 feet for BARO and 5,000 feet for RADAR. Setting the RADAR at a value greater than 5,000 feet results in 5,000 feet being used. Passing through the BARO/RADAR programmed altitude from above results in the ALTITUDE voice alert. Setting

the BARO/RADAR altitude warning to 0 feet disables this function. At power up with WonW, RADAR altitude warning initializes to 0 feet and BARO altitude warning initializes to 5,000 feet. With MC OFP H3E AND UP, at power up with WonW, RADAR altitude warning initializes to 5,000 feet and BARO altitude warning initializes to 10,000 feet.

Set the BARO/RADAR low altitude warning function by selecting the DATA option on the HSI top level MPCD display selecting the A/C option to bring up the A/C data sublevel display. The BARO/RADAR altitude functions are located on the lower left corner of the display. Selecting BARO or RADAR initializes the UFCD for altitude entry. Selecting the desired option on the UFCD and entering the desired altitude through the UFCD keypad and pressing ENT. The entered altitude appears on the A/C data sublevel display below BARO/ RADAR as appropriate. See figure 24-9, sheet 3.

24.2.10.3 Zulu Time of Day (ZTOD). The FIRAMS Real Time Clock (RTC) is used to keep ZTOD. The only time ZTOD needs to be set is if the FIRAMS RTC failed power up BIT. In this case the MC internal counter would be used and requires the MC internal clock to be set. ZTOD is displayed on the HUD and HSI display and is needed to calculate MC required groundspeed and TOT.

Enter ZTOD by selecting the TIMEUFC option on the HSI top level display to initialize the UFCD for ZTOD programming. Then select the ZTOD option on the UFCD, enter ZTOD on the UFCD keypad, and select the ENT option. At first selection of ZTOD, it is displayed on the HUD and HSI display. ZTOD is displayed on the lower left corner of the HUD and HSI display. If time is displayed on the HUD, the respective option has “*HUD” displayed below it. ZTOD is not displayed on the HUD when either the ET or CD is selected for display. See figure 24-9, sheet 4.

24.2.10.4 Elapsed Time (ET). ET starts incrementing in minutes and seconds from 00:00 to 59:59. When 59:59 is reached ET resets and begins incrementing again from 00:00. ET is displayed on the lower left corner of the HUD and on the lower right corner of the HSI display. ET is not displayed on the HUD or HSI display when either ZTOD, LTOD or CD is selected.

Activate ET by selecting the TIMEUFC option on the HSI top level display initializes the UFCD for ET selection. Selecting the ET option on the UFCD displays ET 00:00 on the HUD and HSI display. See figure 24-9, sheet 4.

24.2.10.5 Countdown Time (CD). CD starts decrementing in minutes and seconds from a default value of 06:00. When 00:00 is reached, the CD timer is removed from the HUD and HSI displays. CD is displayed on the lower left corner of the HUD and on the lower right corner of the MPCD. CD is not displayed on the HUD or HSI when either ZTOD, LTOD or ET selected. The CD timer initializes to the default value at power up with WonW.

Activate CD by selecting the TIMEUFC option on the MPCD top level display to initialize the UFCD for CD selection. Selecting the CD option on the UFCD displays CD 06:00 on the HUD and HSI display. See figure 24-9, sheet 4.

The CD default value can also be reset by entering in a value between 00:00 and 59:59 by selecting the TIMEUFC option on the HSI top level display to initialize the UFCD for CD programming, entering in the reset value through the UFCD keypad, and pressing the ENT option. The reset value must be less than or equal to 59:59 so that when the ENT option is pressed the CD timer begins to decrement. If the reset value is greater than 59:59, selection of the ENT option sets the reset value to 59:59 and freezes the CD timer.

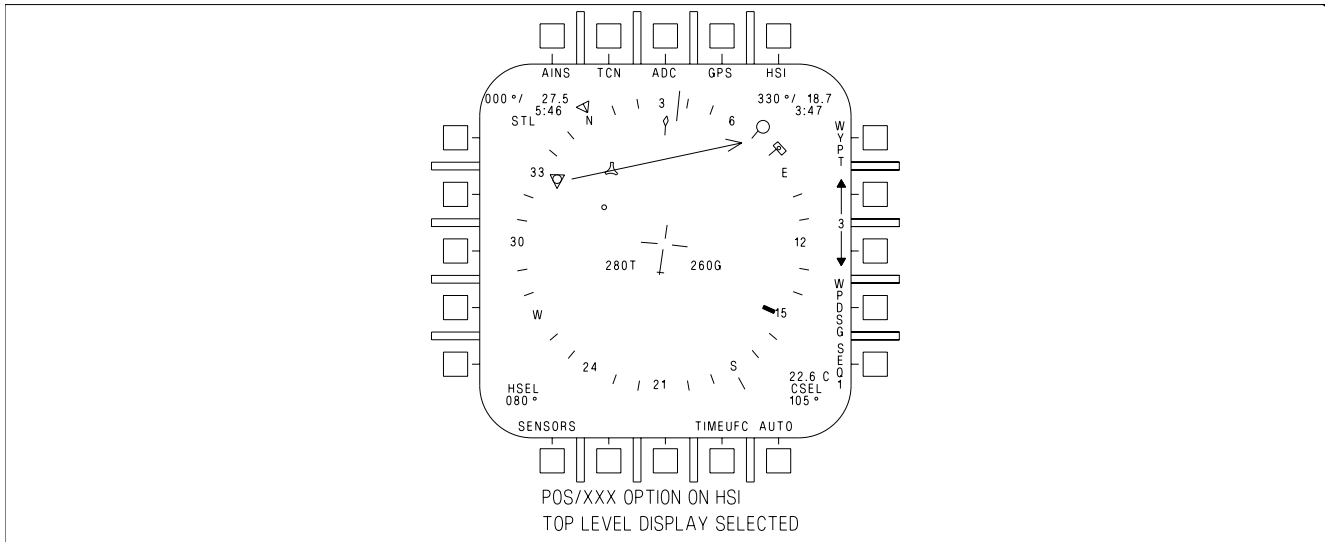

EFN520-145-1-010

Figure 24-10. Position Keeping

24.2.10.6 Local Time Of Day Programming (LTOD). LTOD is displayed on the HUD and HSI display. Set LTOD by selecting the TIMEUFC option on the MPCD top level display initializes the UFCD for LTOD programming. Selecting the LTOD option on the UFCD, entering LTOD on the UFCD keypad, and selecting the ENT option. The LTOD option is displayed if the FIRAMS passes power up BIT. See figure 24-9, sheet 4.

24.2.10.7 Date (DATE). Set the date by selecting the TIMEUFC option on the MPCD top level display initializes the UFCD for date programming. Selecting the DATE option on the UFCD allows “M”, “D” and “Y” to appear on the scratchpad. Enter the date on the UFCD keypad, and select the ENT option. The date must be entered as two digit values in the following order: month, day and year. See figure 24-9.

24.2.10.8 Time Zone. The time zone is set by first entering ZTOD followed by LTOD. The MC uses the difference between these values as the current time zone. Any future changes to ZTOD automatically changes LTOD based on the current time zone. Any future changes to LTOD resets the time zone.

24.2.11 Position Keeping. Selection of the POS/XXX option on the MPCD top display provides the position keeping option display, see figure 24-10. This display allows in-flight selection of POS/AINS, POS/ADC, POS/GPS, POS/INS, POS/MIDS (if installed), or POS/TCN as the position keeping source. Selecting one of these options returns the MPCD top level display with the appropriate position keeping source selected. INS position keeping is automatically selected during ground operations when INS data is valid. Should the INS fail, the mission computer automatically begins FCC air data position keeping from the last valid INS position; however, it is unreliable.

AINS and GPS position keeping are not available unless good GPS data is available. GPS data is good when the GPS vertical error (GPS VERR) and GPS estimated horizontal error (GPS HERR), as shown on the aircraft data format, are each less than 100 feet. AINS position keeping is selected by placing the INS mode switch in the IFA position. Automatic position keeping reversion with a hierarchy of AINS, INS, GPS, MIDS (if installed) and FCC air data is provided in case of an INS and/or GPS failure. TACAN position keeping provides distance data from one of the previously stored

TACAN stations. The desired TACAN station is selected on the UFCD. See TACAN position keeping this section.

WARNING

MIDS Precise Participant Location and Identification (PPLI) altitude shall not be used as an altitude reference for determining safe separation of aircraft or terrain avoidance.

CAUTION

MIDS position keeping is the default position keeping mode if GPS and INS are not available. Because MIDS alone is unreliable as a position keeping source, POS/ADC should be selected if INS and GPS fail or become unreliable as position keeping sources. Aircrew is unable to enter data parameters required for an INS or radar IFA if POS/MIDS is the position keeping source.

24.2.12 Position Updating. Selecting the UPDT (update) option on the MPCD top level display provides the update sublevel display, see figure 24-11. This display allows in-flight selection of VEL (velocity), TCN (TACAN), GPS, DSG (designate), AUTO (automatic), and MAP as the update options. These options provide position/velocity updating to the INS/ADC during NAV or IFA modes. All updates must be performed while in the NAV or A/G master modes, unless noted otherwise. TCN position updating is described in the TACAN section, and VEL updating is described in A1-F18EA-TAC-Series.

NOTE

The update option is not available in AINS position keeping.

After an update is performed, the CANCEL option is displayed on the HSI UPDATE option display. Pressing the CANCEL option cancels the previous update and removes the CANCEL option. The INS updates the aircraft position using the last accepted position update. The CANCEL option is also removed on touchdown or when present position is changed using the UFCD.

24.2.12.1 Designation (DSG) Update. A designation update is performed by pressing the UPDT option on the MPCD top level display. Selecting the DSG option on the UPDT sublevel display. Designating a waypoint/OAP with a sensor (radar, FLIR, NFLR or LDT), a HUD designation, or an overfly designation. The DSG option may be selected before or after waypoint designation. When the designation has been performed and DSG option selected, sensor ranging components to the target are added to the previously entered waypoint position to give an aircraft computed position. The difference between the computed aircraft position and the onboard aircraft position produces the position error readout in bearing and range on the ACPT/REJ display. Selecting the ACPT option accepts the position update and returns the MPCD top level display. Selecting the REJ option rejects the update and returns the MPCD top display. A DSG update may be performed in the A/A master mode if the designation was performed in A/G prior to entering A/A. The selection of UPDT/DSG suspends auto sequential steering and disengages coupled steering.

24.2.12.2 Post-flight Update. The INS post-flight update collects terminal INS maintenance data. The post flight update is performed using the overfly designation update method. The INS determines the overfly designation update is a post flight update using the WonW transition. The aircraft must be completely stopped and the parking brake engaged to prevent erroneous terminal velocity data. The post flight update is not performed onboard ship.

The INS post flight update may be performed when the parking brake is set and the aircraft is within 600 feet of the appropriate waypoint entered in the system (the update waypoint need not be waypoint 0). If the waypoint position is known but not programmed in the system, the position may be entered and used for the update. If no waypoints are available, no update should be attempted.

24.2.12.3 MAP Update. A MAP update is performed by selecting the UPDT option on the MPCD top level display, designating a waypoint/OAP with a sensor (radar, FLIR or LDT), a HUD designation or an overfly designation and selecting the MAP option on the update sublevel display. When this is done the word SLEW appears in the upper right corner of the MPCD and the TDC is automatically assigned to the MPCD (for map slewing). The map can now be slewed so the target on the map is under the designation symbol (diamond). The difference between the target position and the designated position produces the position error readout in bearing and range on the ACPT/REJ display. Selecting the ACPT option accepts the position update and returns the MPCD top level display. Selecting the REJ option rejects the position update and returns the MPCD top level display. The MAP option is not available if a map is not installed.

24.2.12.4 AUTO Update. An AUTO update is performed by selecting the UPDT option on the MPCD top level display and selecting the AUTO option on the UPDT sublevel display. When this is done the AUTO option is boxed and the VEL, TCN, DSG and MAP options are removed. The pilot must assign the TDC to the MPCD, overfly the waypoint/OAP and press the TDC while over the waypoint/OAP. The MC enters the waypoint/OAP as the aircraft present position and the MPCD top level display is returned. The next waypoint in succession becomes designated or, in the case of an OAP, the offset becomes designated. There is no ACPT/REJ display in the AUTO update mode.

24.2.13 NAV/TAC Bank Limit Options. Bank angle control 1 (BAC1) is engaged when any coupled steering mode is engaged. BAC1 provides aircraft steering commands and limits; and maintains the aircraft on course to the selected waypoint(s), offset aim point(s), or TACAN station. BAC1 also provides steering to capture and hold a course line through the current WYPT, OAP, or TACAN station. The maximum bank limit (BLIM) is selectable on the A/C data display. TAC BLIM is used for tactical missions and limits the bank angle between $\pm 30^\circ$ and $\pm 60^\circ$ with a bank rate between 10° and 30° per second based on airspeed. NAV BLIM is used for general navigation and sets bank angle to a fixed $\pm 30^\circ$ limit with a maximum bank angle rate of 10° per second.

24.2.14 Steering. Types of waypoint/OAP steering described include direct great circle, course line, auto sequential, and target.

24.2.14.1 Waypoint/OAP Direct Great Circle Steering. Direct great circle steering is available in all master modes and is selected/deselected by actuating the WYPT/OAP option on the MPCD. Selecting waypoint/OAP steering deselects ILS, D/L, and TACAN steering. When steering is selected, the option is boxed and direct great circle steering is provided on the HUD as shown in figure 24-12. To follow a direct great circle path to the waypoint/OAP, the aircraft is turned so that the command heading steering pointer under the heading scale is centered in the heading caret. The steering provided by the steering pointer is corrected for wind drift. When the steering pointer is within $\pm 5^\circ$ of the caret as measured on the heading scale, it provides a direct indication of steering error. Between $\pm 5^\circ$ and the ends of the heading scale ($\pm 15^\circ$), the steering pointer moves nonlinearly so that it is at the end of the

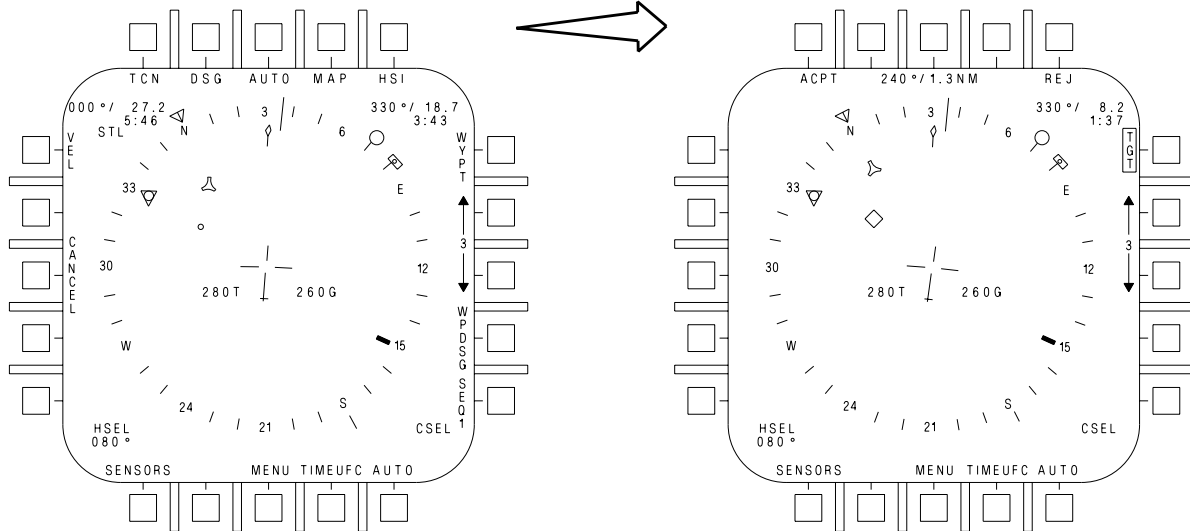

- UPDT OPTION ON THE HSI TOP LEVEL DISPLAY SELECTED

ACPT/REJ DISPLAY

- DSG OR MAP OPTION ON THE UPDATE SUBLEVEL DISPLAY SELECTED

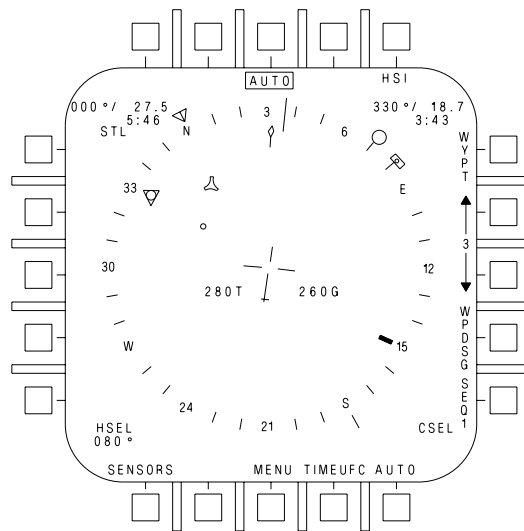

AUTO UPDATE DISPLAY

- AUTO OPTION ON THE UPDATE SUBLEVEL DISPLAY SELECTED

Figure 24-11. Position Updating Displays

heading scale when the steering error is 30° . The steering pointer is displayed at the end of the heading scale when the steering error is greater than 30° , the steering pointer begins to move to provide anticipation for rolling out of the turn, and the actual steering error is indicated when within 5° . Waypoint/OAP range, identification, and number are displayed on the lower right side of the HUD.

On the MPCD, the position of the waypoint/OAP is indicated by the waypoint/OAP symbol as shown on figure 24-12. If the selected steer to point is an OAP, the position of the offset is indicated by the offset symbol. Bearing to the waypoint/OAP is indicated by the pointer inside the compass rose. The waypoint/OAP symbol and pointer are displayed whether or not direct great circle steering is selected. They provide a navigation situation display only. Steering (corrected for drift) is provided only on the HUD. A digital readout of bearing and range to the waypoint/OAP is provided on the upper right corner of the MPCD. Time to go to the waypoint/OAP in minutes and seconds, based on range and groundspeed, is provided under the bearing and range readout.

24.2.14.2 Waypoint/OAP Course Line Steering. Course line steering is used when it is desired to fly a selected course to the waypoint/OAP. Course line steering is selected by selecting direct great circle steering and actuating the course select switch. When the course select switch is actuated, the course line appears through the waypoint/OAP symbol as shown in figure 24-13, sheet 1. The course line rotates clockwise while the course select switch is held to the right and counterclockwise while it is held to the left. A digital readout of the selected course is provided in the lower right corner of the MPCD. When the waypoint/OAP symbol is beyond the range of the selected MPCD scale, the waypoint/OAP symbol is limited at the inside of the compass rose coincident with the head of the pointer and the course line rotates about the head of the pointer. It does not then overfly its correct position on the map; but, does correctly indicate to which side of the aircraft the course lies, and the intercept angle is correctly represented.

When a course line is selected, steering on the HUD is displayed. The arrow provides a horizontal situation indication relative to the velocity vector. As shown, the aircraft is to the right of the selected course, but is converging toward it. Two dots are displayed on the side of the velocity vector toward the steering arrow and in a line perpendicular to it. The outermost dot represents full scale deflection of the arrow (8°) and the innermost dot indicates half scale deflection (4°). If the arrow moves to the other side of the velocity vector, the dots appear on that side. The dots are not displayed when within approximately 1.25° of being on course. Figure 24-13, sheet 2 shows an example of the HUD steering arrow display as the aircraft crosses a course line. The HUD situation arrow display is available only in NAV master mode, although waypoint/OAP steering can be selected and the course arrow can be displayed and used on the MPCD in any master mode. Only waypoint/OAP direct great circle steering is available on the HUD when designated. Course line steering can be deselected either by deselecting waypoint/OAP direct great circle steering or by selecting a new waypoint/OAP, initializing direct great circle steering.

24.2.14.3 Coupled Waypoint / OAP Steering. When waypoint steering is coupled, CPL WYPT is displayed on the HUD and HSI display, and a CPLD advisory appears on the DDI. The aircraft steers to intercept the desired course line, or flies to the point if no course line is selected. Bank angle is limited by NAV or TAC bank limit option as selected on the A/C sublevel display and described in chapter 2. As the aircraft gets close to the desired course, the bank angle is reduced to maintain the aircraft on the desired course. If course line steering is not selected, when the aircraft reaches the waypoint or offset aim point (OAP) WYPT steering uncouples and reverts to HDG hold. If course line steering is selected, the aircraft remains coupled and flies an outbound radial. RALT or BALT, whichever is selected, remains engaged when the aircraft passes the waypoint. If a ground point is designated, WYPT steering does not couple, or uncouples if previously coupled. If waypoint steering

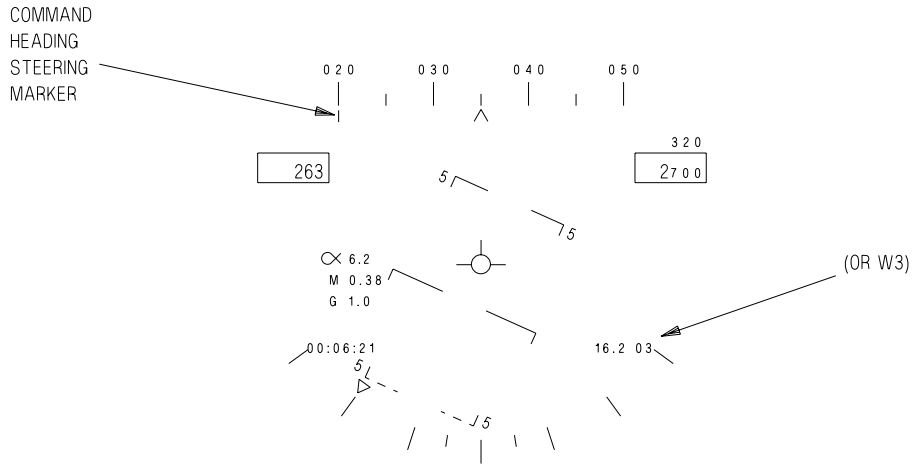

HUD STEERING DISPLAY

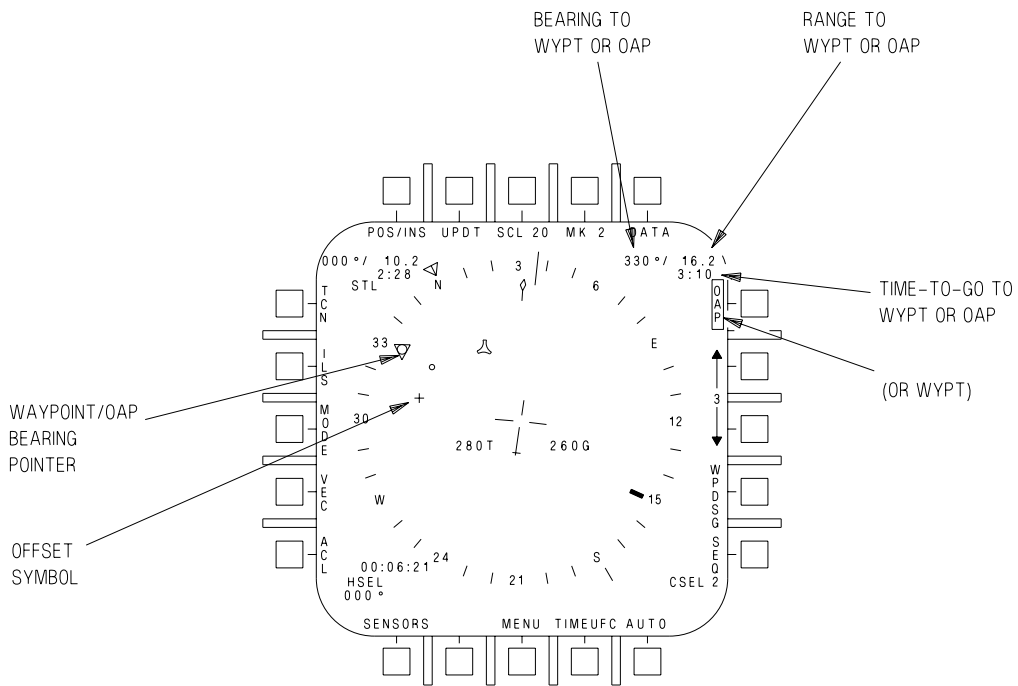

HSI STEERING DISPLAY

Figure 24-12. Waypoint/OAP Direct Great Circle Steering

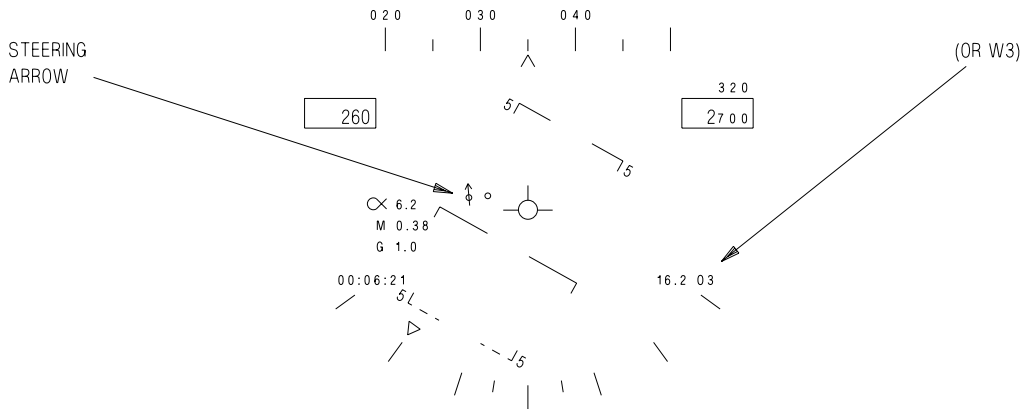

HUD STEERING DISPLAY

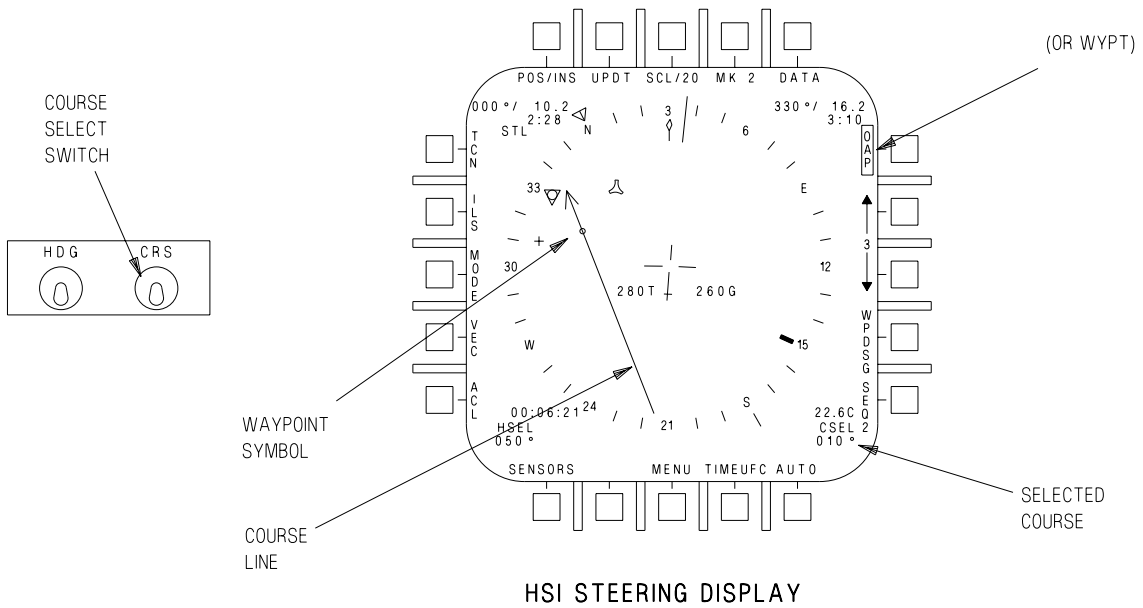

HSI STEERING DISPLAY

Figure 24-13. Waypoint/OAP Course Line Steering (Sheet 1 of 2)

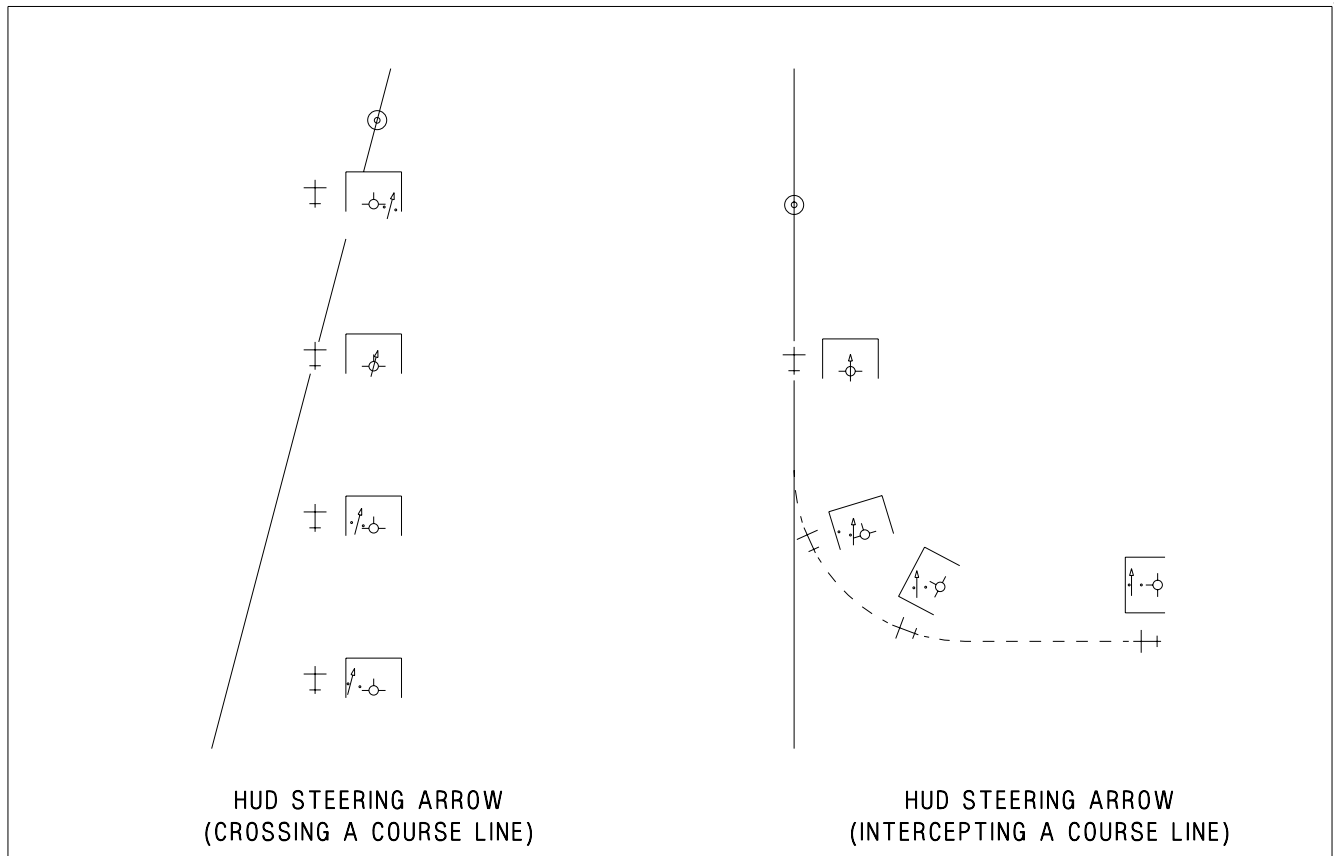

EFN520-154-1-001

Figure 24-13. Waypoint/OAP Course Line Steering (Sheet 2 of 2)

does not engage or disengages without being commanded, an AUTOPILOT caution is displayed on the DDI, and CPL WYPT flashes for 10 seconds on the HUD and HSI displays. The caution can be cleared with the paddle switch.

24.2.14.4 AUTO Sequential Steering. Before AUTO sequential steering can be selected a waypoint/OAP sequence must be programmed.

AUTO sequential steering is selected by actuating the AUTO option (AUTO boxed) on the MPCD. When selected, other steering modes not compatible with AUTO sequential are deselected.

With AUTO sequential steering engaged, great circle steering is provided to the first waypoint/OAP in the selected sequence, see figure 24-14. When range to the steer to waypoint/OAP is less than 5 NM and bearing is greater than 90° , the next waypoint/OAP in the sequence is automatically selected. Great circle steering is automatically provided for each new steer to waypoint/OAP in the sequence. During AUTO sequential steering course line steering is available but course line is deselected when the steer to waypoint/OAP is within the range and bearing mentioned above. The waypoint/OAP up/down arrows provide manual selection for steering to the desired waypoint/OAP in the sequence.

With AUTO sequential steering engaged, selecting the SEQ # option provides dashed lines on the MPCD connecting the waypoint/OAPs of the chosen sequence.

AUTO sequential steering is deactivated when any of the following occur: the AUTO option deselected (unboxed), the last waypoint/OAP in the sequence is within the parameters mentioned above, selection of another steering mode, the FCS is coupled to the D/L, AUTO update is selected, a

ground point is designated, magnetic heading is invalid, aircraft present position is invalid, aircraft ground track is invalid, or steering waypoint/OAP range/bearing is invalid.

Auto sequential steering is suspended if UPDT/DSG is selected to perform an overfly designation. The automatic transition to the next waypoint does not take place until the update is either accepted or rejected and the sequence criteria is satisfied.

24.2.14.5 Coupled Auto Sequential Steering. When auto sequential steering is coupled CPL SEQ # () (current sequence number: 1, 2, 3, or L replaces the parenthesis) is displayed on the HUD and HSI display and a CPLD advisory appears on the DDI. The aircraft steers to intercept the desired course of the current WYPT/OAP in the sequence. Bank angle is limited by NAV or TAC mode as described in chapter 2. As the aircraft gets close to the desired course, the bank angle is reduced to maintain the aircraft on the desired course. An OVFLY () option is available on the WYPT data option display. When this option is selected (boxed), the aircraft overflies the current WYPT/OAP in the sequence before intercepting the course of the next one. When OVFLY () is not selected, the aircraft performs a lead turn to intercept the course of the next WYPT/OAP just prior to reaching the current point. Once the aircraft reaches the last point in the sequence, auto sequential steering uncouples, reverting to HDG hold in the roll axis. RALT or BALT, whichever is selected, remains engaged when the aircraft passes the final point. If auto sequential steering does not engage or disengages without being commanded, an AUTOPILOT caution is displayed on the DDI, and CPL SEQ () flashes for 10 seconds on the HUD and HSI displays. The caution can be cleared with the paddle switch.

Coupled AUTO sequential steering is selected and deactivated as described above in the Auto Sequential Steering paragraph.

Coupled auto sequential steering is disengaged if UPDT/DSG is selected to perform an overfly designation. The automatic transition to the next waypoint does not take place. When auto disengage from coupled steering occurs, autopilot cautions occur. Coupled steering is not automatically reengaged after the update is complete.

24.2.14.6 Groundspeed Cuing. Before groundspeed cuing is available for display, certain criteria must be met: a waypoint/OAP sequence must be entered, a target waypoint/OAP in the sequence must be selected, time of day must be entered (ZTOD or LTOD), and TOT must be entered. With waypoint/OAP great circle steering engaged to the target waypoint/OAP, the MC calculates the groundspeed required to arrive at the target based on a direct path to the target and the entered TOT. With AUTO sequential engaged, the MC calculates the groundspeed required to arrive at target waypoint/OAP taking the sequential path to the target. The MC calculates the necessary groundspeed based on the pilot entered groundspeed, providing there is enough time to travel the final leg at the entered groundspeed and arrive at the target at the TOT. If there is not enough time to travel the final leg at the pilot entered groundspeed, the MC ignores the pilot entered groundspeed and calculates a groundspeed to arrive at the target on time.

NOTE

- Programming a required groundspeed is not necessary for ground-speed cuing calculations.
- The designated target waypoint/OAP must be in the waypoint/OAP sequence in order for the required groundspeed cueing function to operate.

If the target is an OAP the groundspeed required calculation includes the distance from the OAP to the offset. If the target is NAV designated the MC uses the NAV designation location in the calculation of groundspeed required for TOT. When the target waypoint/OAP is NAV designated, any other designation means may be used to adjust the designation and the groundspeed calculation is calculated to the adjusted designation.

HUD cuing of required groundspeed consists of a tick mark and arrow head located under the airspeed box. The arrow head is referenced to the tick mark and indicates if the aircraft is traveling too fast or too slow to reach the target on time. The arrow head is displayed to the left of the tick mark when the aircraft is traveling too slow and to the right of the tick mark when the aircraft is traveling too fast. Full displacement of the arrow head left or right of the tick mark indicates a difference of 30 knots between actual and required groundspeed. The aircraft is traveling the correct speed when the arrow head is centered on the tick mark. The required groundspeed readout is displayed on the MPCD under the present ground speed readout. See figure 24-14 for an example of HUD and MPCD groundspeed cuing.

24.2.15 Designation. Designation of a waypoint/OAP is the action by which the pilot identifies a waypoint/OAP position to the MC so that position can be used for sensor slaving, steering, or position updating. Navigation and overfly designations are discussed here but sensor designations are described in A1-F18EA-TAC-Series. Designating a waypoint/OAP initiates the following changes on the MPCD: the WPDSG option is removed/replaced with the O/S option, WYPT/OAP is replaced with a boxed TGT/OAP legend, the waypoint symbol is replaced with the target diamond, the waypoint symbol inside the waypoint steering pointer is also replaced with the target diamond and the steering information in the upper right corner now relates to the target. Designating a waypoint/OAP also provides the following changes on the HUD: a target diamond appears below the heading scale to provide target heading information, another target diamond also appears indicating the target line of sight (LOS) and the WYPT data (range) on the lower right corner is replaced with TGT data. HUD target steering operates the same as described for waypoint/OAP great circle steering.

24.2.15.1 WPDSG (Navigation) Designation. Selecting the WPDSG option designates the waypoint as a target. The changes mentioned above appear at designation, see figure 24-15.

To WPDSG an OAP the procedure is slightly different. When the WPDSG option is selected, the OAP is designated and all data for the designated target on the MPCD and HUD operate the same as described above, except that the WPDSG legend is replaced with the O/S option and the OAP option is boxed. The O/S option must now be selected to add the offset data to the OAP position and complete the designation. Another method of adding the offset data to the OAP position (completing the designation) is to assign the TDC to the MPCD and actuate the TDC. When this occurs, the O/S legend is removed, the boxed OAP legend is replaced with a boxed TGT legend, the offset symbol is replaced with the target diamond and the designated aimpoint reverts to the aimpoint symbol. A WPDSG cannot be performed if a waypoint/OAP is already designated.

24.2.15.2 Overfly Designation. An overfly designation is performed on a waypoint/OAP by pressing the TDC while it is assigned to the MPCD and the aircraft is overflying the waypoint/OAP. When this happens, the MC assumes that the aircraft is over the waypoint/OAP and the aircraft position at that time is designated as the waypoint/OAP position. In the case of an OAP the offset data is automatically added to the aircraft present position to complete the designation. When an overfly designation is performed the changes mentioned above occur, see figure 24-16.

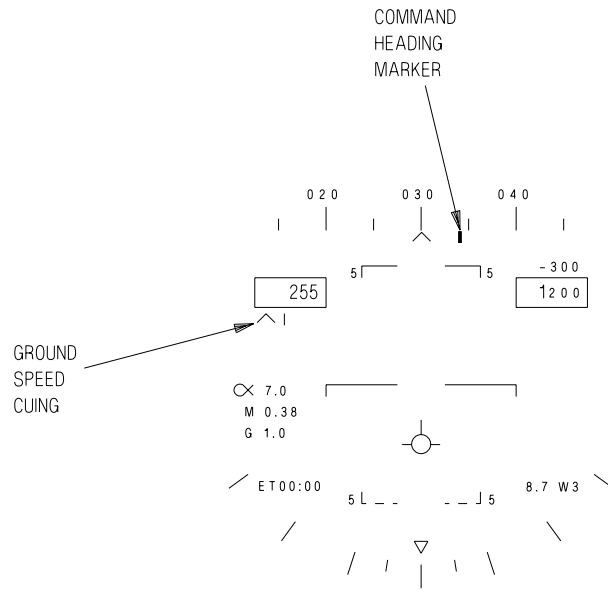

HUD STEERING DISPLAY

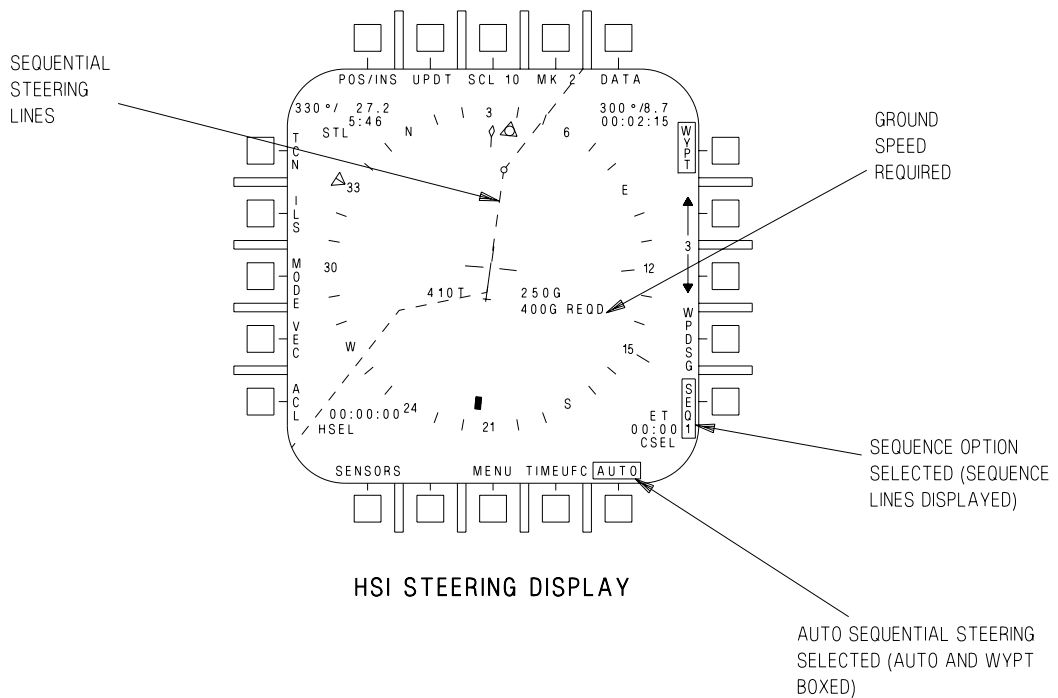

HSI STEERING DISPLAY

EFN520-169-1-010

Figure 24-15. Navigation Designation (WYPT DSG)

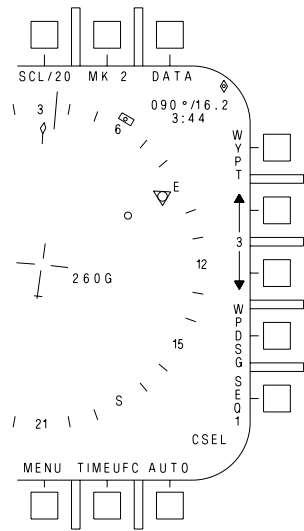

BEFORE

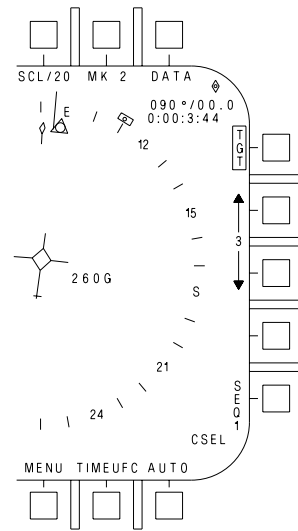

AFTER
(TDC PRESSED)

HSI WAYPOINT OVERFLY DESIGNATION DISPLAY

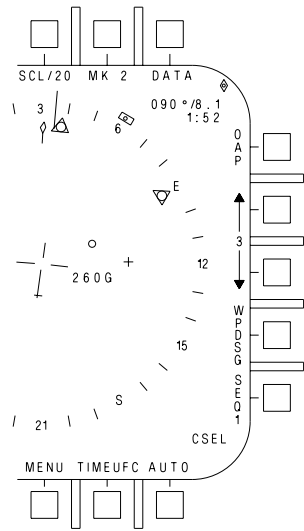

BEFORE

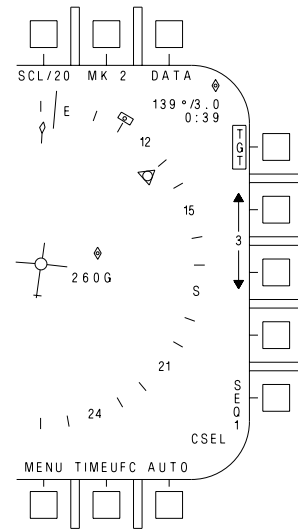

AFTER
(TDC PRESSED)

HSI OAP OVERFLY DESIGNATION DISPLAY

NOTE

HUD SYMBOLRY FOR AN OVERFLY DESIGNATION IS IDENTICAL TO A NAVDSG.

Figure 24-16. Overfly Designation

24.2.16 INS Updates (not available in AINS).**Radar -**

1. Master mode - NAV (RADAR SURF) or A/G
2. Radar mode - EXP 1, EXP 2, EXP 3, or MAP
3. WYPT - SELECT
4. WYPT DSG - PRESS
5. TDC/DC - ASSIGN TO RADAR
6. UPDT - PRESS
7. DSG - PRESS
8. Slew cursor over waypoint and release TDC/DC.
9. Accept or reject.

HUD -

1. WYPT - SELECT
2. WYPT DSG - SELECT
3. TDC - ASSIGN TO HUD
4. UPDT - PRESS
5. DSG - PRESS
6. Slew HUD diamond over waypoint and release TDC/DC.
7. Accept or reject.

Overfly -

1. WYPT - SELECT
2. TDC/DC - ASSIGN TO MPCD
3. UPDT - PRESS
4. DSG - PRESS
5. Actuate TDC/DC when aircraft is over waypoint.
6. Accept or reject.

AUTO -

1. WYPT - SELECT
2. TDC/DC - ASSIGN TO MPCD
3. UPDT - PRESS
4. AUTO - PRESS
5. Actuate TDC/DC when aircraft is over waypoint.

Map -

1. WYPT - SELECT
2. UPDT - PRESS
3. MAP - PRESS (automatically assigns TDC/DC to MPCD)
4. Overfly desired geographical reference and actuate TDC/DC.
5. Select slew and slew map reference under aircraft symbol, release TDC/DC.
6. Accept or reject.

TACAN -

(1 of 10 available TACAN stations must be in reception range)

1. UPDT - PRESS
2. TCN - PRESS
3. Accept or reject.

Velocity -

1. UPDT - PRESS
2. VEL - PRESS
3. Accept or reject.

24.3 ADF (AUTOMATIC DIRECTION FINDER)

The OA-8697/ARD ADF is a VHF/UHF direction finder operating in the 100 to 400 MHz frequency range. The system has an antenna section which receives and modulates rf signals and an audio processing section which resolves bearing in the ADF audio received from the VHF/UHF receiver-transmitter. Bearing information received by the ADF is sent to the MC where the data is processed to position the ADF bearing pointer on the HSI display. The channel to the station to which ADF bearing is required is selected on the COMM 1 or COMM 2 radio. The ADF system is turned on by

selecting the ADF option on the UFCDD COMM sublevel for the selected radio. Squelch is disabled for the selected radio when ADF is turned on. Squelch can be reenabled by reselecting the SQCH option. Selecting the COMM 2 radio indicates ADF bearing to the station selected on the COMM 2 radio.

ADF audio is adjusted by either the COMM 1 or COMM 2 volume control knob. ADF symbology appears as a small circle on the HSI display.

Aircraft after ECP 6061 may not have ADF installed. When ADF is enabled on the COMM sub-level without an ADF installed the following will occur:

- The EADI bearing indicator will jump erratically as if no ADF signal is present.
- Squelch will be disabled on the selected radio.
- The radio selected for ADF will not receive (no antenna), but will still transmit.

24.4 TACAN (TACTICAL AIR NAVIGATION)

The RT-1159A/ARN-118 TACAN system or the Multifunctional Information Distribution System (MIDS) when installed gives precise relative bearing and/or slant range distance to a TACAN ground station or range to a suitably equipped aircraft. The TACAN system operates in the L-band frequency range, limiting the operating range to line of sight, which depends upon aircraft altitude. The maximum operating range is 390 nm when the selected TACAN station is a surface beacon and 200 nm when the selected TACAN station is an airborne beacon. The aircraft receives a three letter Morse code signal to identify the beacon being received. When operating in conjunction with aircraft having air-to-air capability, the A/A mode provides line of sight distance between two aircraft operating TACAN sets 63 channels apart. Up to five aircraft can determine line of sight distance from a sixth, lead aircraft in the A/A mode.

In MIDS equipped aircraft, TACAN functionality is embedded in the MIDS terminal, replacing the AN/ARN-118 in door 13R. To preclude MIDS interference with the IFF system, notch frequency filters were placed in the MIDS TACAN antenna lines. The upper filter is fixed, while the lower filter is switched in for Link-16 transmissions, and out for TACAN transmissions and all reception. Because the upper antenna is fixed, it filters A/A TACAN frequencies on channels 1 - 36 and 64 - 99 (X and Y). A/A TACAN channels should be chosen outside of these ranges. Because the upper antenna filter is fixed, it filters A/A TACAN frequencies on channels 1-36 and 64-99 (X AND Y). A/A TACAN channels should be chosen outside of these ranges. The upper filter makes the top antenna unusable for T/R (AIR TO GROUND) TACAN channels 1-29 X and Y, 47X to 63X and 64Y to 92Y. For TACAN channels in these ranges, the bottom antenna is the only antenna for TACAN. With a centerline tank installed, the antenna is blocked approximately $180 \pm 15^\circ$ relative to the aircraft nose. This shadowing of the bottom antenna, combined with the lower transmitter power of the MIDS (200W versus 1000W for AN/ARN-118), causes reduced ranges for DME at channels within the range of the filter when flying directly away from the TACAN station. Flight test data at afloat stations shows that maximum tail-aspect DME ranges of approximately 22 nm at 6,000 feet and 26 nm at 15,000 feet can be expected making DME unreliable when headed outbound in the marshal stack. At shore stations, flight tests have shown substantially better tail-aspect DME ranges (e.g. 52 nm at 15,000 feet). DME ranges in the forward and side quadrants of the aircraft, and bearing performance in all quadrants, are not impacted. Therefore, approach performance on the affected channels is nominal. There is also attenuation on A/G TACAN channels 1 to 36 (X and Y), 40X to 63X, and 64Y to 99Y on the upper antenna, but is less of a problem due to A/G TACAN using primarily lower antenna.

NOTE

MIDS equipped aircraft may experience TACAN bearing and DME dropouts. MIDS equipped aircraft with a centerline tank may experience loss of DME during outbound legs from TACAN stations 1 to 29X and Y, 47X to 63X and 64Y to 92Y.

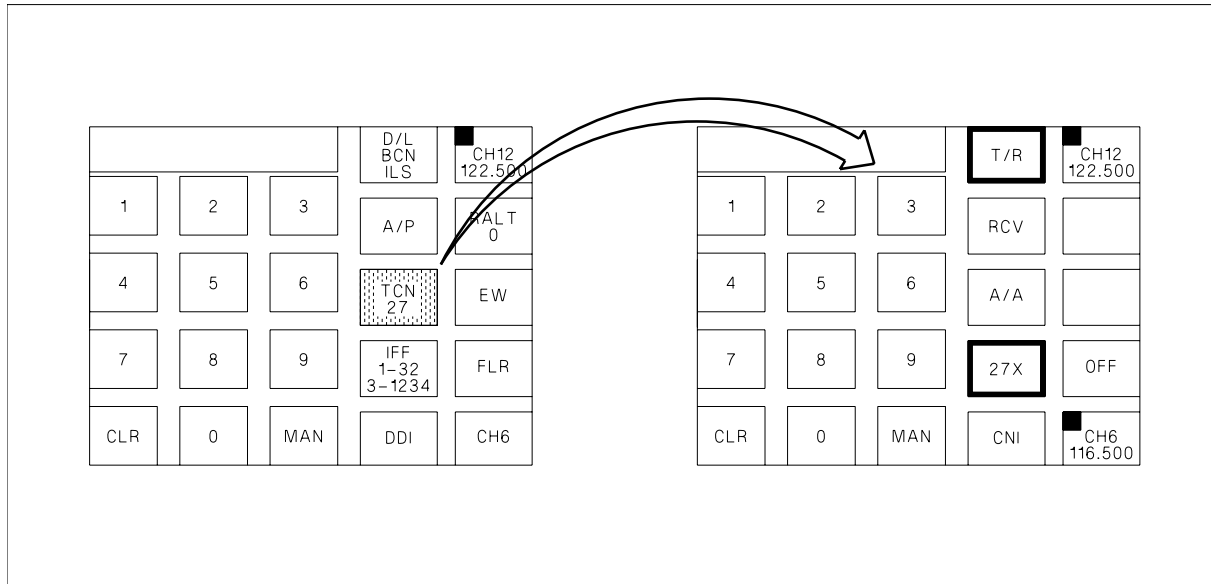

EFN620-343-1-004

Figure 24-17. TACAN Mode Selection

24.4.1 TACAN BIT. A TACAN BIT check is manually initiated by ensuring the TACAN is turned on and pressing the TCN/IFF option on the BIT sublevel display. If the TACAN is good, the DDI shows the BIT status as GO. If the TACAN does not pass the BIT check, BIT status is DEGD. The TACAN system also has an automatically initiated BIT. If the automatic BIT check detects a wrong signal or a failure, TACAN DEGD is displayed on the BIT display and the BIT line on the left DDI. If no fault is detected, nothing is displayed next to TCN. In MIDS equipped aircraft, the only way to execute a TACAN BIT is by initiating a MIDS BIT. To run a MIDS BIT, MIDS must be selected in the COMM submenu of the BIT display.

24.4.2 TACAN Mode Selection. To enable the TACAN system, select the TCN option on the UFCDD top level CNI display. The TACAN channel number is displayed on the TCN option. If the TACAN is powered the TCN option is corner highlighted. If TCN is selected with no data entered in the scratchpad the TACAN sublevel is displayed, see figure 24-17. TACAN operation is controlled from the TACAN sublevel. The TACAN system is turned on by pressing the ON/OFF option on the TACAN sublevel.

When the TACAN sublevel is selected, the following TACAN mode options appear: T/R (transmit/receive), RCV (receive), A/A (air-to-air), and X and Y channel. Border highlights indicate which TACAN mode is operating. In the T/R mode the TACAN computes bearing and measures slant range from the selected TACAN station. In the RCV mode only bearing from the selected TACAN station is computed. In the A/A mode, interrogations and replies are single pulse from one aircraft to another. The TACAN channel mode is indicated in the X/Y option which is always border highlighted in the TACAN sublevel and toggles between X and Y mode with each selection.

24.4.3 TACAN Programming. TACAN station data is entered by selecting the DATA option on the MPCDD top level display. Selecting the TCN option on the data sublevel display provides the TACAN data sublevel display. This display shows the TACAN station lat/long position, elevation, and magnetic variation. TACAN station data is entered by selecting the desired TACAN station number on the UFCDD keypad. Pressing the X or Y option to select the TACAN channel, the POSN option enters lat/long data, the ELEV option to enter elevation data, and the MVAR option to enter magnetic variation. TACAN data is entered on the UFCDD keypad for up to 252 TACAN stations (126 on X channel, 126 on Y channel). See figure 24-18.

24.4.4 TACAN Position Keeping. The TACAN system may be used for position keeping purposes. To do this the TACAN system must be in the T/R mode with the proper channel (X or Y) and channel number selected. The TACAN station selected must be one of the prestored stations. Selecting the POS/XXX option on the MPCD top level display provides the position keeping option display. Selecting the TCN option as the position keeping source causes the MPCD top level display to be returned and POS/TCN to be displayed as the position keeping source.

24.4.5 TACAN Position Updating. The TACAN system may also be used for position updating purposes. To do this the TACAN system must be in the T/R mode with the proper channel (X or Y) and channel number selected. The TACAN station selected must be one of the prestored stations. Selecting the UPDT option on the MPCD top level display provides the UPDT option display. Selecting the TCN option causes the MC to use position data from the selected TACAN station to compute aircraft present position. The difference between the TACAN computed present position and the on board determination of aircraft present position produces the position error readout in bearing and range on the ACPT/REJ display. Selecting the ACPT option accepts the position update and returns the MPCD top level display. Selecting the REJ option rejects the update and returns the MPCD top level display.

24.4.5.1 TACAN Steering. Types of TACAN steering available for selection are direct great circle, and course line steering. These TACAN steering options are mechanized identical to waypoint/OAP direct great circle and course line steering, with steering being referenced to the TACAN. Selecting the TCN option on the MPCD top level display provides TACAN direct great circle steering, see figure 24-19. Activating the CSEL switch with TACAN direct great circle steering selected provides TACAN course line steering, see figure 24-20.

24.4.5.2 Coupled TACAN Steering. When TACAN steering is coupled, CPL TCN is displayed on the HUD and HSI display and a CPLD advisory appears on the DDI. The aircraft steers to intercept the desired course line, or flies to the TACAN station if no course line is selected. Bank angle is limited by NAV or TAC mode as described in chapter 2. As the aircraft gets close to the desired course, the bank angle is reduced to maintain the aircraft on the desired course. If a course line is selected, the aircraft continues past the TACAN station on the outbound radial until the mode is decoupled. If no course line is selected, TACAN steering uncouples when the aircraft reaches the TACAN station, reverting to HDG hold. RALT or BALT, whichever is selected, remains engaged when the aircraft passes the TACAN station. If TACAN steering does not engage or disengages without being commanded, an AUTOPILOT caution is displayed on the DDI, and CPL TCN flashes for 10 seconds on the HUD and HSI displays. The caution can be cleared with the paddle switch.

24.5 INSTRUMENT CARRIER LANDING SYSTEM (ICLS)

The AN/ARA-63A ICLS is an all weather approach guidance system which operates with an aircraft carrier installed transmitting set AN/SPN-41. The ICLS decodes transmitted azimuth and elevation signals during an approach and provides steering information for display on the HUD, standby attitude reference indicator, and EADI. The major components of the AN/ARA-63A system are a receiver and a decoder.

24.5.1 ICLS Receiver. The ICLS receiver receives coded transmissions of azimuth and elevation guidance data from surface transmitters. The receiver transforms these signals into coded pulses

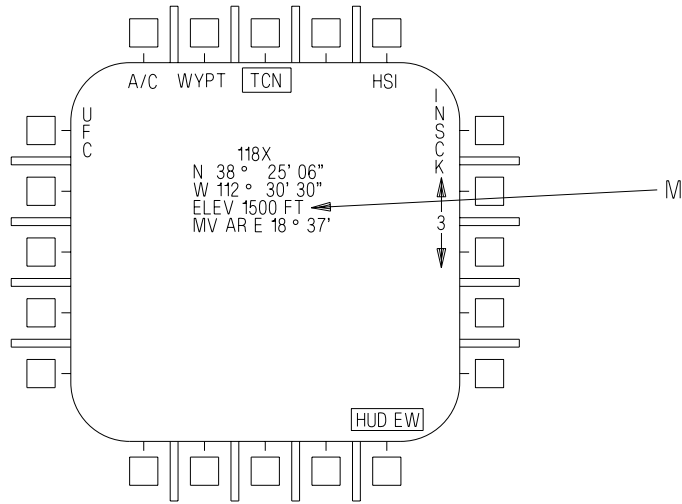

HSI TCN DATA SUBLEVEL DISPLAY

- TCN OPTION SELECTED

			X	CH12 122.500
1	2	3	POSN	ELEV FEET
4	5	6	MVAR	
7	8	9		
CLR	0	ENT	CNI	CH 6 116.500

TCN PROGRAMMING OPTIONS

- WHEN UFC OPTION ON HSI TCN SUBLEVEL DISPLAY SELECTED

Figure 24-18. TACAN Programming

COMMAND HEADING
STEERING POINTER

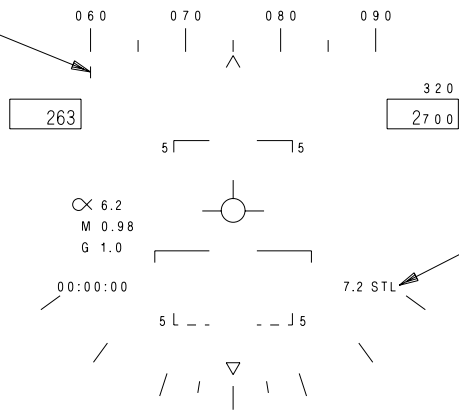

SLANT RANGE
TO TACAN STATION

HUD STEERING DISPLAY

TACAN
BEARING

TACAN
RANGE

TACAN
BEARING
POINTER

TACAN
LOCATION
SYMBOL

TACAN STATION
TIME-TO-GO

TACAN
PUSHBUTTON

TACAN
STATION
IDENTIFIER

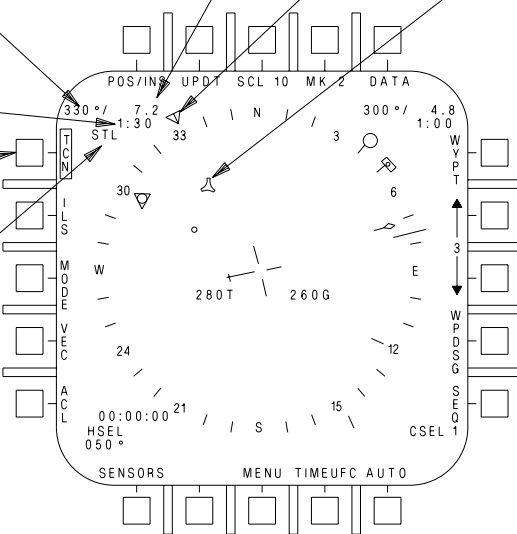

HSI STEERING DISPLAY

Figure 24-19. TACAN Direct Great Circle Steering

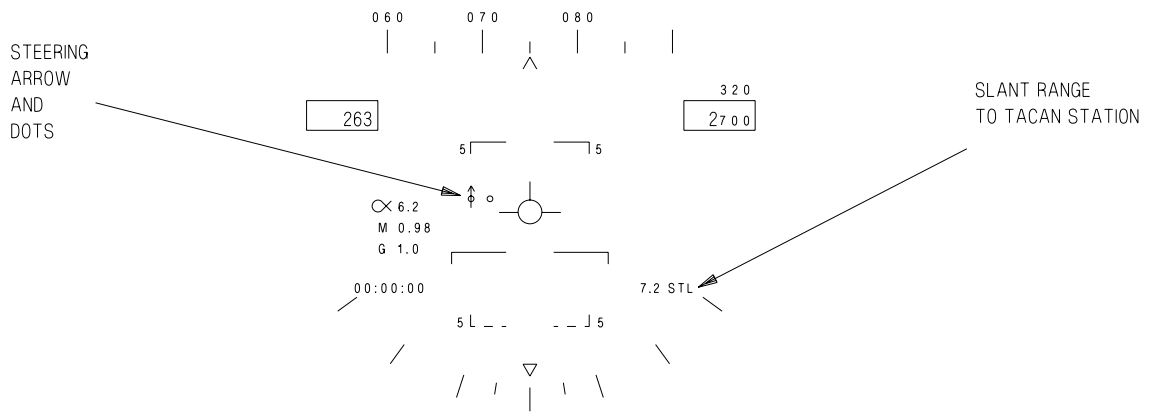

HUD STEERING DISPLAY

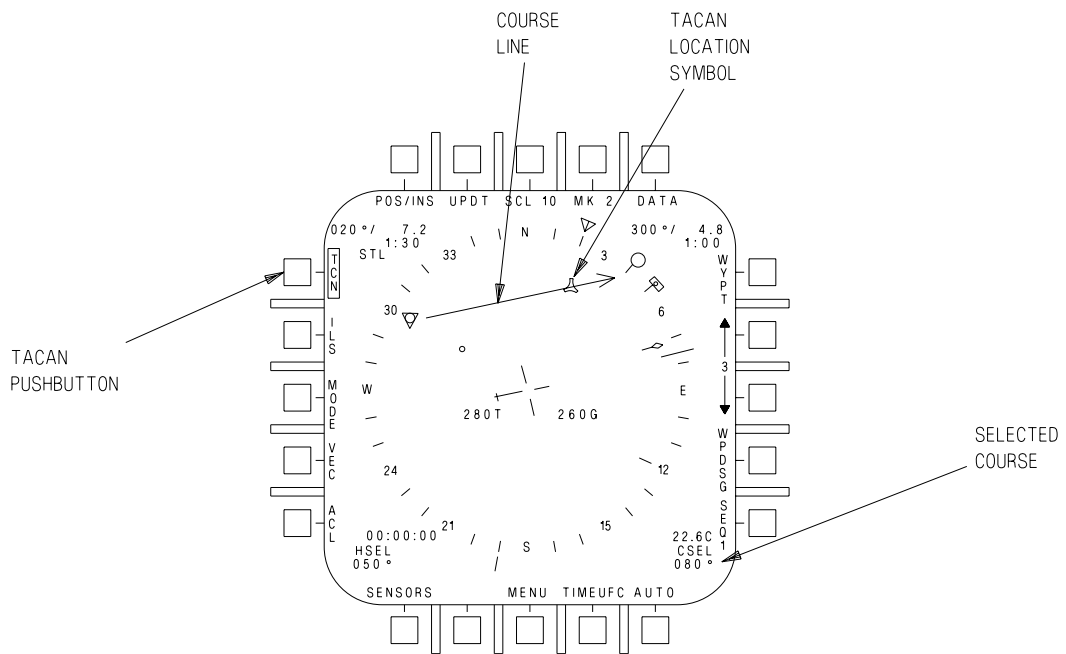

HSI STEERING DISPLAY

Figure 24-20. TACAN Course Line Steering

EFN520-172-1-010

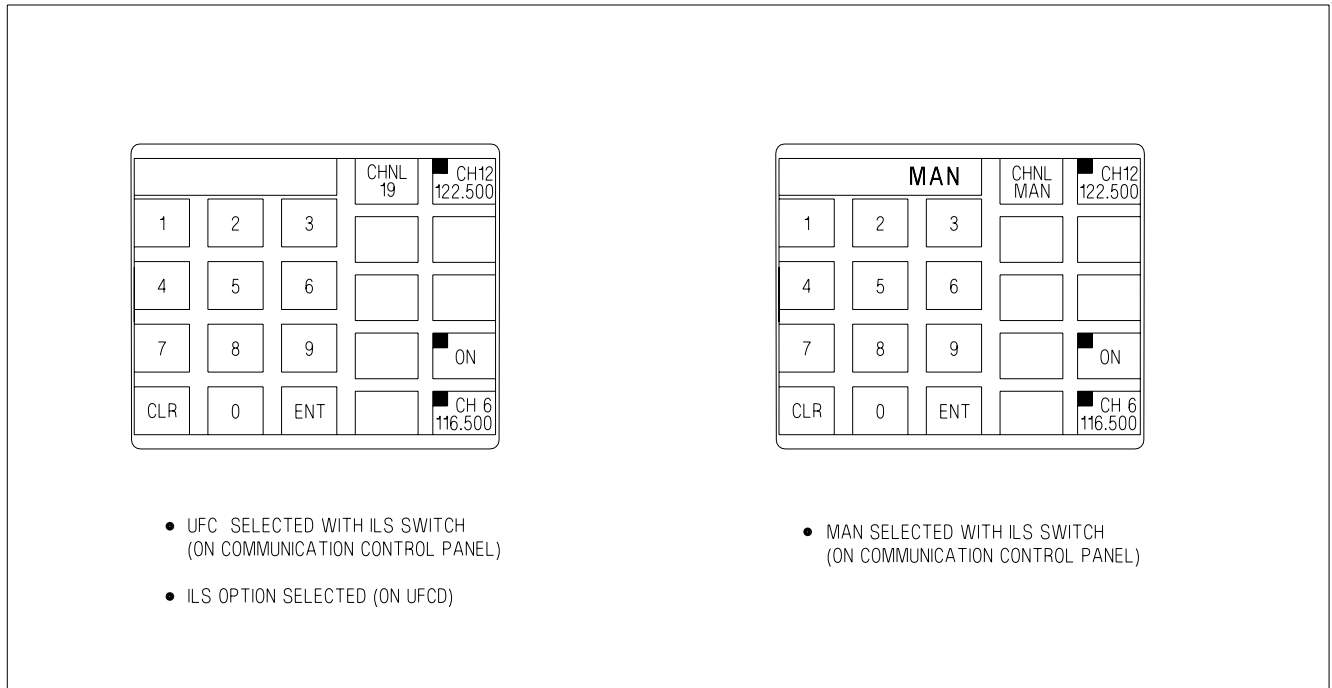

EFN520-168-1-001

Figure 24-21. ICLS Initialization

suitable for processing in the decoder. A BIT module for system BIT check is contained within the receiver.

24.5.2 ICLS Decoder. The ICLS decoder receives and decodes azimuth and elevation pulses from the receiver and converts them to azimuth and elevation command signals for the HUD and standby attitude reference indicator.

24.5.3 ICLS BIT. An ICLS BIT check is manually initiated by ensuring the ICLS is on and selecting the ILS/AUG/BCN/D/L option on the BIT sublevel display. If any of the BIT monitored outputs fail, a BIT status message of DEGD (degraded) appears on the BIT sublevel display. If the BIT checks are good, a BIT status message of GO appears on the BIT sublevel display.

24.5.4 ICLS Initialization. The ICLS is enabled by placing the ILS UFC/MAN switch on the COMM control panel to the UFC position, pressing the D/L BCN ILS option, and pressing the ILS option, on the UFCD. This allows the ICLS channel number and ON/OFF status to be displayed on the UFCD and CHNL # to appear on the CHNL option, see figure 24-21. Pressing the ON/OFF option turns the ICLS on. The ICLS channel may be changed (1 to 20) using the UFCD keypad. The ICLS is automatically selected when the ACL data link mode is selected.

Another method of enabling the ICLS is to place the ILS UFCD/MAN switch on the COMM control panel to the MAN position. When this is done the ICLS is turned on and the ILS channel push buttons on the COMM control panel are used for channel selection. The letters MAN appear on the scratchpad and below the CHNL option.

24.5.5 ICLS Steering. When the ICLS is on and the ILS option on the MPCD top level display is selected (boxed), ICLS steering is provided on the HUD, the standby attitude reference indicator, and the EADI, see figure 24-22. The azimuth and elevation deviation bars are referenced to the velocity vector. When the waterline symbol is displayed, the deviation bars are referenced to it. As shown, the deviation bars are deflected full scale and the aircraft is below glide slope and to the left of course. The azimuth bar is deflected full scale for azimuth deviations of $\pm 6^\circ$ to $\pm 20^\circ$. The elevation bar is deflected full-scale down for elevation deviations of 1.4° to 20° , and full-scale up for deviations of -1.4° to -3° . If a valid azimuth or elevation signal is not received by the ICLS, the corresponding bar is not displayed.

ICLS steering is automatically provided when the ACL mode is selected and valid ICLS steering signals are received.

24.6 DATA LINK SYSTEM

All information on the data link system, except for the automatic carrier landing mode, is contained in A1-F18EA-TAC-100. For typical Automatic Carrier Landing procedures, refer to Chapter 8.

24.6.1 Automatic Carrier Landing Mode. The system for automatic landing of aircraft onto the aircraft carrier deck is comprised of the AN/SPN-42 or AN/SPN-46 installed aboard the carrier and Automatic Carrier Landing (ACL) equipment installed in the aircraft. The aircraft data link system is the ACL component over which steering commands are received from the carrier for guidance of the aircraft.

The data link automatic carrier landing (ACL) mode is available only when the NAV master mode is selected. The ACL steering commands may be coupled to the flight control computer for fully automatic approaches to touchdown, or the pilot may elect to use the steering displays for a manually controlled landing. The traffic control (T/C) mode is a submode of ACL. The T/C mode provides data link heading commands to aid the pilot in reaching the marshal point and/or it may be used for azimuth alignment from marshal until ACL acquisition. These heading commands can be coupled to the flight control computer for automatic lateral axis control or can be used for manual steering aids.

Two uplinked control messages (label 5 and label 6) are uniquely addressed to a specific aircraft and received by the data link for ACL mode (and T/C submode) control and display. The label 5 message is used only for T/C mode, while both label 5 and label 6 are required for ACL Modes 1, 1A, and 2 control and display. The contents of the uplinked label 5 and label 6 messages follows:

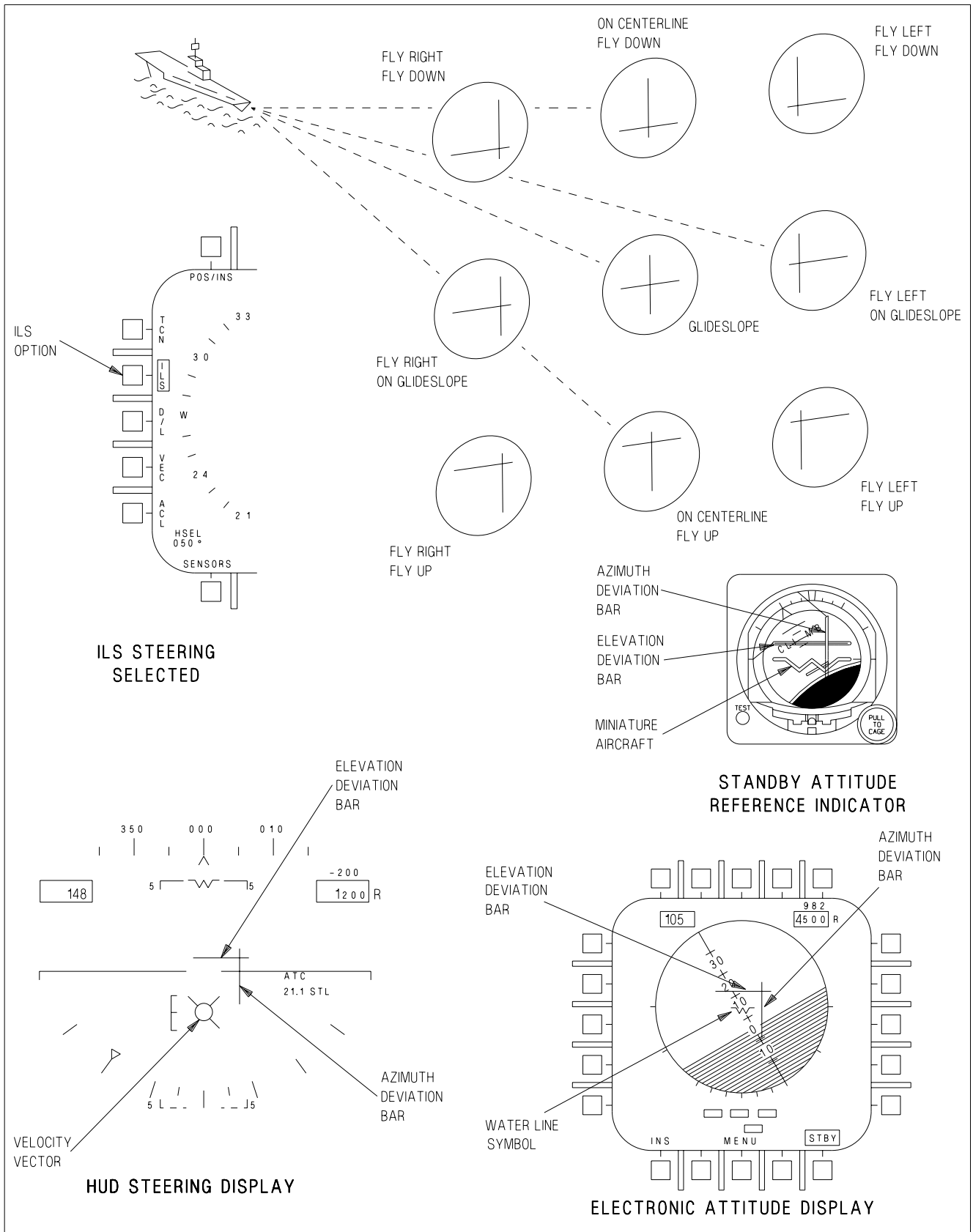

EFN520-156-1-001

Figure 24-22. ICLS Steering

Label 5 Message

Command Altitude (feet)	Displayed on SA display.
Command Airspeed (knots)	Displayed on SA display.
Command Rate of Descent (feet per minute)	Displayed on SA display.
Command Heading	Displayed on SA and HUD.
Group 1 Discretes	ACL RDY, CMD CNT, LND CHK, NOT CMD, W/O, and CHG CHNL.
Group 2a Discretes	Monitor Altitude and Altitude Change
Warning	Receipt of either discrete causes the Command Altitude and Command Rate of Descent to be underlined on the SA display.
Group 2b Discretes	Monitor Speed and Speed Change Warning. Receipt of either discrete causes the Command Airspeed to be underlined on the SA display.
Group 2c Discretes	ADJ A/C, VOICE and 10 SEC.

Label 6 Message

Vertical Glide Slope Error	Used for data link HUD situation display.
Lateral Glide Slope Error	Used for data link HUD situation display.
Mode Status Discrete	Indicates that uplinked longitudinal and lateral axes commands may be used for Mode 1 ap- proach.
Longitudinal Axis Command (altitude rate in feet/second)	Used by FCS for longitudinal axis control.
Lateral Axis Command (roll angle in degrees)	Used by FCS for lateral axis control.

The ground station also periodically uplinks two universal test messages (UTM-3A and UTM-3B). These two messages have a canned constant content and carry a universal address, rather than being addressed uniquely to a controlled aircraft, as are the label 5 and label 6 messages. During ACL mode test, the data link is commanded to accept these two UTM as part of the determination of onboard ACL capability.

24.6.1.1 ACL Mode Displays. The ACL mode displays consist of the SA display on the DDI and the data link situation display on the HUD. The following paragraphs contain a general description of the

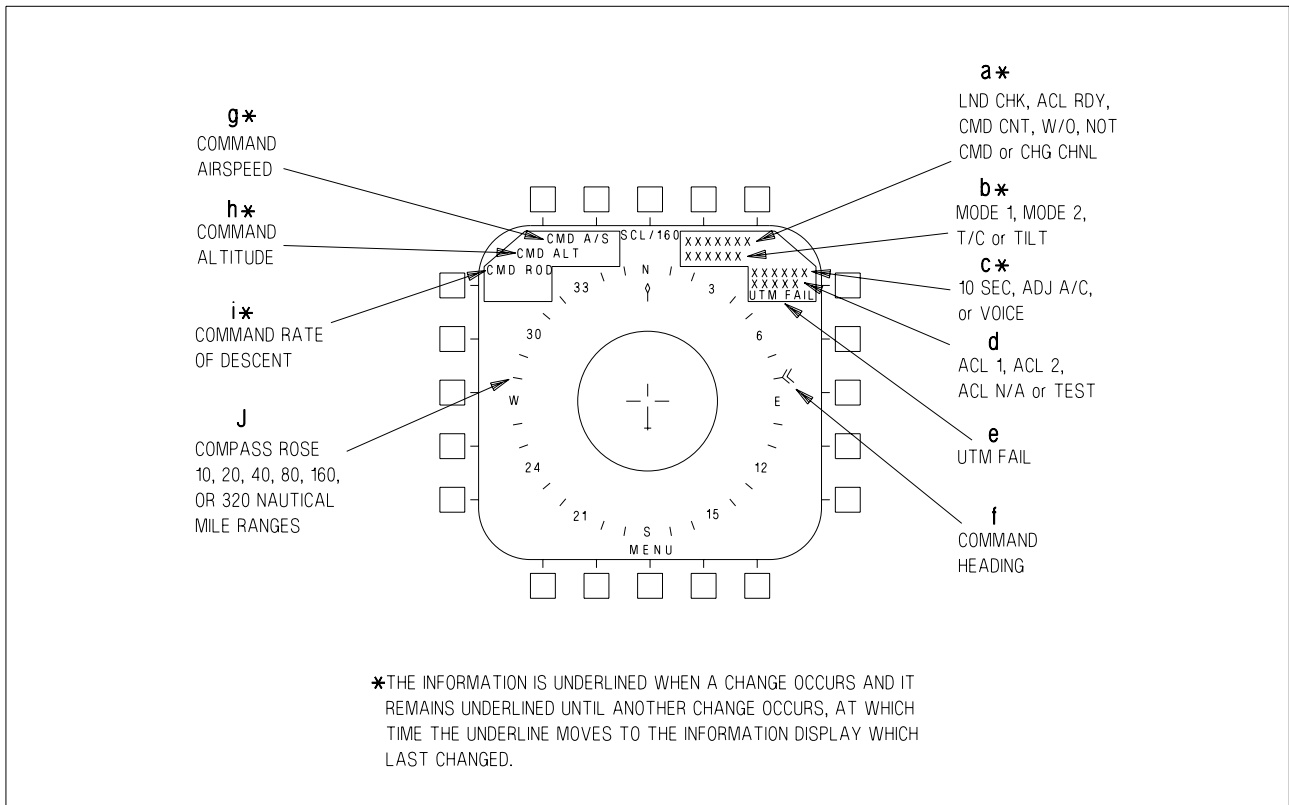

EFN520-157-1-001

Figure 24-23. DDI SA ACL Display

displays related to the ACL mode. A more explicit definition of the utilization of these displays is presented in ACL Mode Operation, this chapter.

24.6.1.1.1 SA Display. Figure 24-23 shows the ACL and T/C information which may be displayed on the link SA display. The lettered symbols and cues on the display are described after the corresponding letter in the following paragraphs.

a. The following uplinked group 1 discretes may be displayed in this slot:

- LND CHK** Landing check indicates that SPN-42/SPN-46 control radar communication has been established. It also cues the pilot to be in the landing configuration with ATC engaged.
- ACL RDY** ACL ready indicates that SPN-42/SPN-46 acquisition has occurred and uplinked longitudinal axis (altitude rate) and lateral axis (roll rate) commands are being received equal to zero. The ACL RDY indication is also displayed on the HUD. Receipt of the ACL RDY discrete is one of the onboard prerequisites for ACL couple.
- CMD CNT** Command control discrete indicates that the carrier has received a verbal confirmation from the pilot that FCS is coupled to the ACL longitudinal and lateral commands, and further indicates to the pilot that longitudinal and lateral commands are now active.
- W/O** When this discrete is received the FCS is uncoupled from the uplinked commands.

NOT CMD The not command discrete indicates that label 5 information is invalid. When this discrete is received the label 5 information is removed from the SA display and the FCS is uncoupled from the T/C heading command/ACL steering commands.

CHG The change channel discrete indicates that the data link frequency should be
CHNL changed.

b. The following ACL mode operational cues may be displayed in this slot.

MODE 1 Indicates that the entire loop is capable and ready for coupling for dual axes ACL control.

MODE 2 Indicates that the entire loop is not capable of Mode 1 coupled approach but is capable of Mode 2 manual control approach using uplinked situation steering.

T/C Traffic control cue indicates that the entire loop is capable and ready for couple to the T/C heading command.

TILT Indicates that the uplinked information is not being updated. When this condition exists all uplinked information is removed from the displays and the FCS is uncoupled from the data link commands.

c. The following uplinked group 2 C discrettes may be displayed in this slot. These cues are displayed for 30 seconds after initial receipt, then removed.

10 SEC Indicates that SPN-42/SPN-46 is now adding deck motion compensation to the longitudinal and lateral axes commands. This discrete is received approximately 12.5 seconds before touchdown.

ADJ A/C Adjacent aircraft cue indicates that another aircraft has been detected in the area of controlled aircraft.

VOICE Indicates that the pilot is to establish voice contact with control.

d. The following onboard capability cues are displayed in this slot.

ACL 1 Indicates that onboard systems are capable of an ACL or T/C couple to the FCS.

ACL 2 Indicates that onboard systems are not capable of ACL or T/C couple to FCS, but are capable of displaying uplinked information for a Mode 2 manual approach.

ACL N/A Indicates that onboard systems are not capable of using uplinked information and that a carrier controlled approach (CCA) must be made.

TEST Indicates that ACL mode is in test.

e. The UTM FAIL cue is displayed in this slot when valid uplinked UTM 3A and UTM 3B were not received during automatic test.

- f. Command heading is displayed by the double chevron symbol on the outside of the compass rose.
- g. Command airspeed is displayed in this slot.
- h. Command altitude is displayed on this slot.
- i. Command rate of descent is displayed in this slot.
- j. The compass rose is track-up oriented with selectable ranges of 10, 20, 40, 80, 160, and 320 nm.

24.6.1.1.2 HUD ACL Display. Figure 24-24 shows the HUD ACL display information. The lettered symbols and cues on the HUD are described after the corresponding letter in the following paragraphs.

- a. Uplinked command heading is indicated by the command heading steering pointer below the heading scale.
- b. The following cues may be displayed in the command heading slot:

10 SEC	Displayed for 30 seconds after receipt and then removed. Also displayed on SA display.
TILT	Displayed when communication has been lost with data link control. Also on SA display.
DATA	Displayed for 10 seconds and flashed at a rate of two times per second when new data is initially displayed on the SA display.
W/O	When this discrete is received the FCS is uncoupled from the uplinked commands.

- c. The following cues may be displayed in this slot:

ACL RDY	Displayed when received via data link and the FCS is not coupled. Also displayed on SA display.
CPL P/R	Coupled in pitch and roll is displayed when the FCS is coupled to the longitudinal and lateral commands. The cue is flashed for 10 seconds at two times per second then removed if the couple attempt is unsuccessful, or if uncouple occurs for any reason other than pilot deselection. Disengagement, other than pilot initiated, also results in an AUTOPILOT caution.
CPL HDG	Coupled to heading commands cue is displayed when FCS is coupled in the T/C mode. This cue is flashed for the same reasons as described for the CPL P/R cue.

- d. The following cues may be displayed in this slot. These cues may be displayed in any master mode:

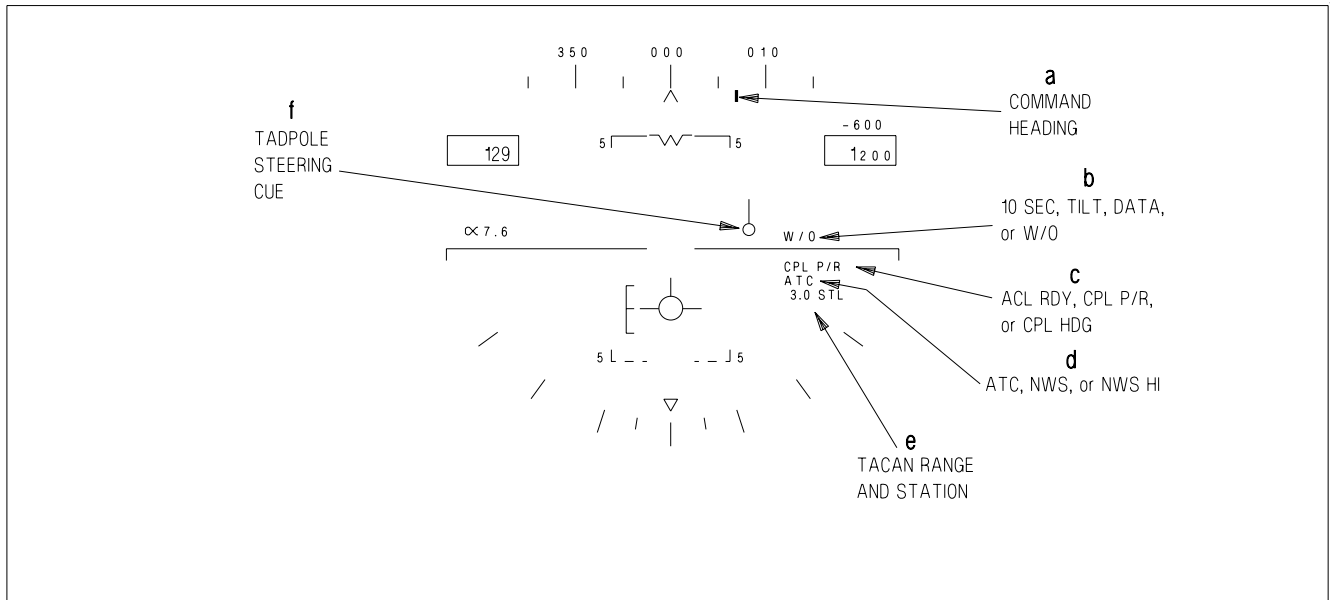

Figure 24-24. HUD ACL Display

EFN520-158-1-007

ATC Displayed when automatic throttle control is engaged. If an unsuccessful engagement attempt occurs, or if the ATC disengages for any reason other than pilot deselection, the ATC cue is flashed for 10 seconds at two times per second, then removed.

NWS Indicates low gain nosewheel steering is engaged.

NWS HI Indicates high gain nosewheel steering is engaged.

- e. When ACL mode is initially selected, waypoint steering is automatically deselected, if selected, and the system is automatically undesignated if an aimpoint is designated. If TACAN is on, TACAN range is automatically displayed regardless of TACAN steering selection unless the pilot subsequently designates an aimpoint or selects waypoint steering.
- f. The tadpole steering symbol is referenced to the velocity vector and provides uplinked flight path steering indications for the ACL glide slope and course.

24.6.1.2 ACL Mode Operation. The data link ACL mode is selected by actuating the ACL option button on the MPCD.

24.6.1.2.1 Initialization. When selected, the ACL legend on the MPCD is boxed and the SA display is automatically selected on the left DDI. The TEST cue is displayed indicating the ACL mode is in test. The ICLS, data link, and radar beacon are automatically turned on if not previously on. IBIT is run on the data link and radar beacon systems. The uplinked UTM is monitored for valid receipt. When ACL testing is complete the TEST cue is removed, the systems are placed in the correct operational mode, the stored data link ACL frequency is automatically selected, and the pilot is cued on the SA display to onboard ACL capability (ACL 1, ACL 2, or ACL N/A) as previously described. If during test, a valid uplinked UTM message was not received, the UTM FAIL cue is displayed on the SA display.

24.6.1.2.2 Traffic Control Couple. When an uplinked label 5 message is received, a determination is automatically made relative to total loop capability. If the ACL loop is ready for a T/C couple, the T/C cue appears on the SA display and autopilot options are initialized on the upfront control display with the CPL HDG option displayed (figure 24-25). The prerequisites for a CPL HDG option for T/C follows:

1. Onboard systems fully operational.
2. Valid label 5 message received.
3. Waveoff (W/O) discrete not received.
4. Uplinked information being updated (no TILT cue).
5. NOT CMD discrete not being received.
6. Label 6 message not being received.

With T/C displayed FCS couple is selected by actuating the CPL option button on the UFCD. When coupling to the T/C heading command is successful a colon is displayed in front of the CPL option on the UFCD and the CPL HDG cue is displayed on the HUD. After couple the FCS banks the aircraft to a maximum of 30° to capture and hold the uplinked heading command. Aircraft pitch attitude may be controlled by the pitch hold function of the heading hold mode or by the BALT or RALT altitude hold modes of the autopilot. A T/C couple precludes use of all other outer loop autopilot modes except BALT and RALT. The T/C couple disengages, with reversions as noted, for any of the following reasons:

1. Heading hold mode disengagement with reversion to CAS operation.
2. Roll control stick steering engagement with reversion to lateral axis heading hold mode.
3. Loss of valid uplinked heading command for more than 10 seconds (TILT) with reversion to lateral axis heading hold mode.
4. Pilot deselection of CPL option with reversion to lateral axis heading hold mode.
5. Pilot actuation of paddle switch with reversion to CAS.
6. Receipt of uplinked W/O discrete with reversion to lateral axis heading hold mode.
7. Receipt of uplinked NOT CMD discrete with reversion to lateral axis heading hold mode.

An unsuccessful T/C couple attempt, or disengagement of the T/C couple for any reason other than pilot deselection, results in an AUTOPILOT caution as well as CPL HDG on the HUD flashing for 10 seconds.

24.6.1.2.3 ACL Mode 1. When an uplinked label 6 message is received, a determination is made with respect to total loop capability relative to dual-axis (lateral and longitudinal) ACL couple. If ACL couple is determined to be available, the Mode 1 cue is displayed on the SA display and the autopilot options are initialized on the UFCD with CPL P/R option displayed as shown in figure 24-26.

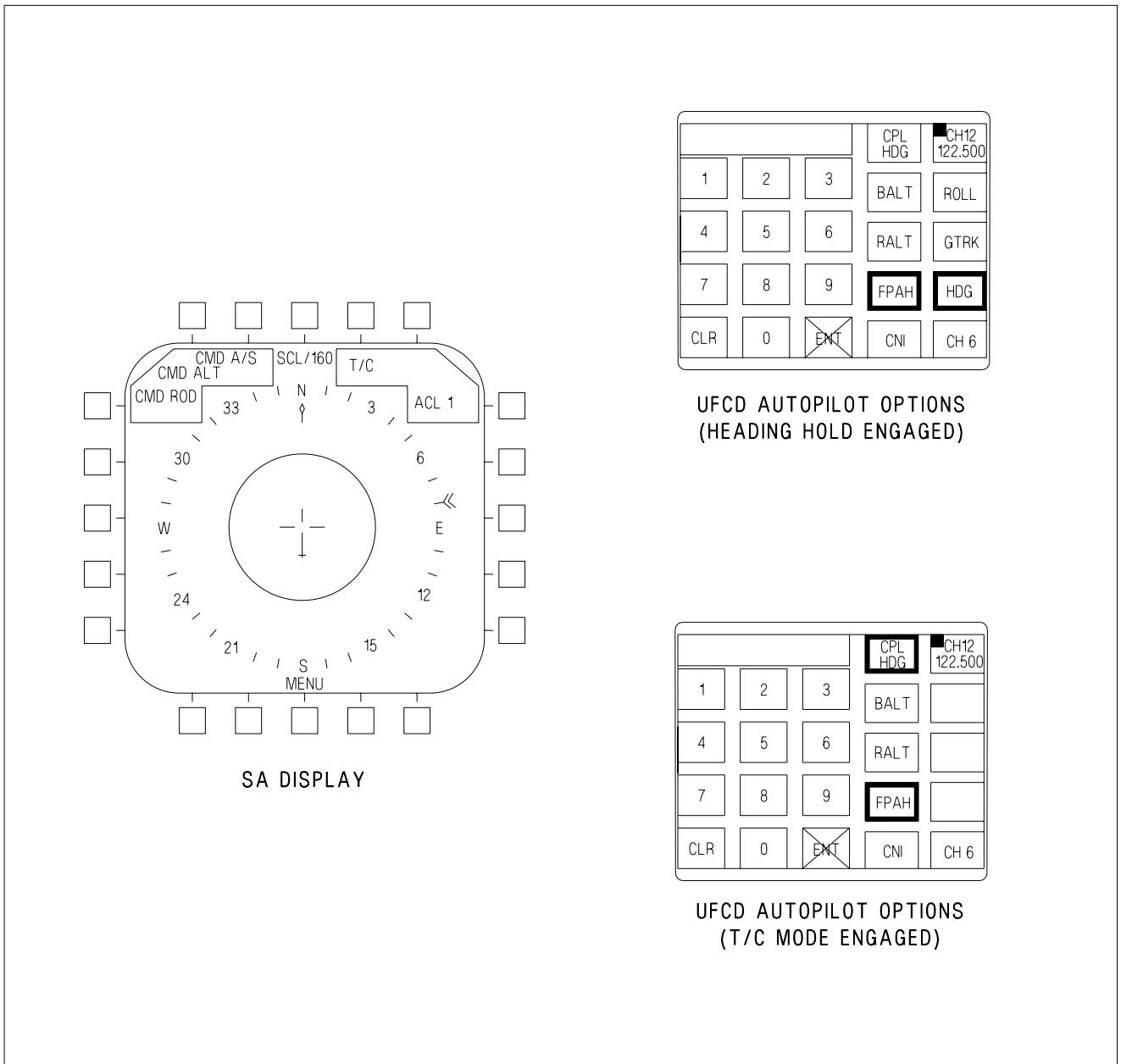

EFN520-159-1-001

Figure 24-25. Traffic Control Couple Display

When the pilot selects the CPL P/R option on the UFCD, an ACL couple to the FCS is requested if prerequisites are met.

NOTE

If FCS is already coupled to T/C command heading, actuation of the CPL HDG option disengages T/C couple and a second actuation (CPL P/R) requests ACL couple.

The MC prerequisites for initial ACL couple are:

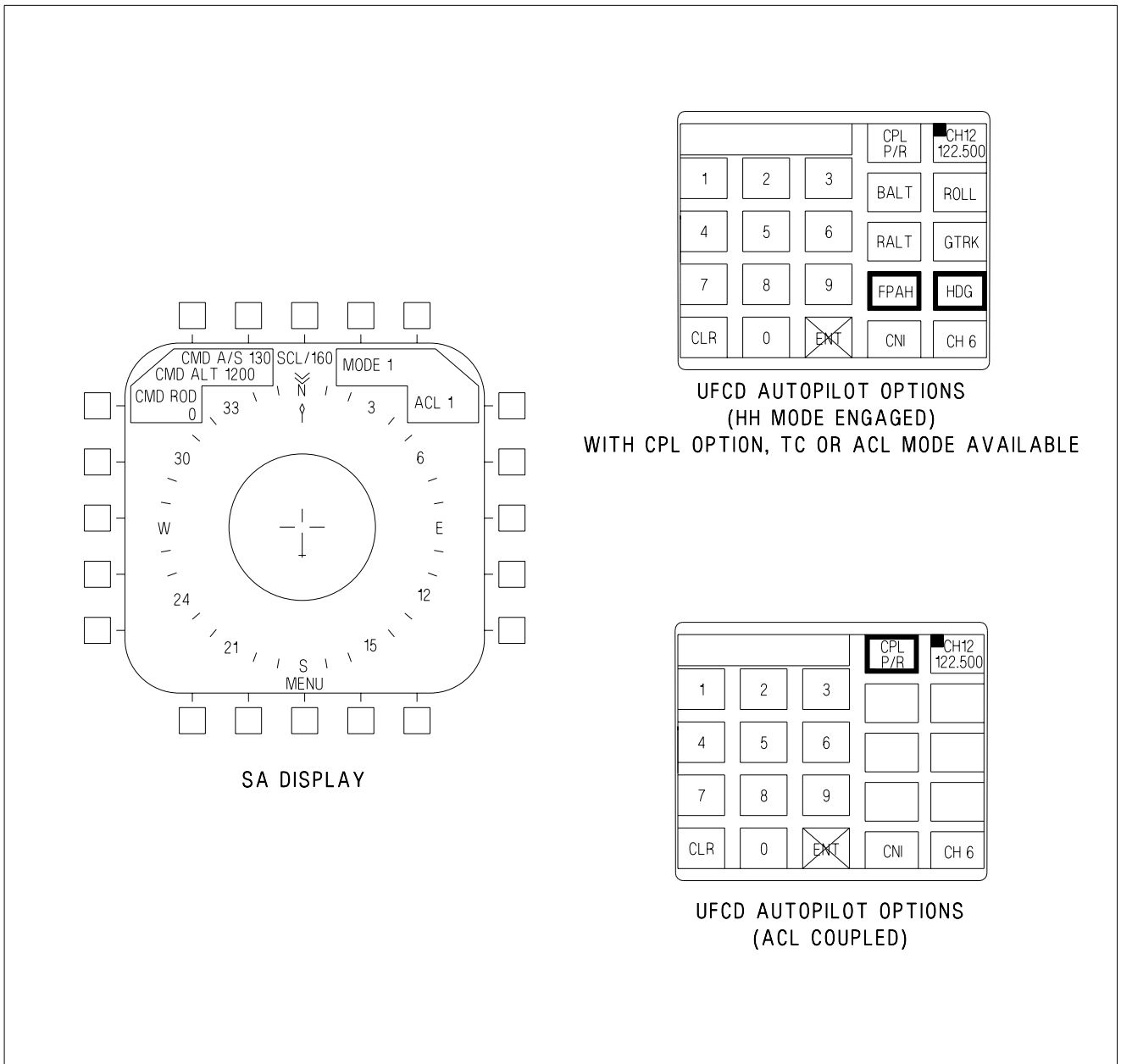

EFN520-160-1-004

Figure 24-26. ACL Mode 1 Display

1. Basic FCS outer loop (heading hold) engaged. If heading hold is not engaged when the CPL option is actuated it is automatically requested, and when FCS indicates it is engaged, ACL couple is requested.
2. Onboard test results indicate ACL 1 capability.
3. Uplinked ACL RDY discrete being received. ACL RDY is required for initial couple only. It is not required after ACL couple occurs.
4. Uplinked A/P bit set to couple state.

5. Valid uplinked longitudinal and lateral axes commands being received (no TILT).

The CPL P/R option is highlighted on the UFCDD and the CPL P/R cue is displayed on the HUD to indicate FCS is coupled. When ACL couple initially occurs, the FCS fades in the longitudinal and lateral uplinked commands to minimize engagement transients. After FCS is coupled to the dual-axis commands, the FCS limits the accepted magnitude of the uplinked commands to prevent excessive pitch or roll changes due to large and/or erroneous uplinked commands. When FCS is coupled to ACL, uncouple occurs, with reversion as noted, for any of the following reasons.

1. Heading hold mode disengagement with reversion to CAS operation.
2. Pitch or roll control stick steering engagement with reversion to CAS when CSS is no longer engaged.
3. WonW with reversion to CAS.
4. Paddle switch actuation with reversion to CAS.
5. UFCDD CPL option actuation with reversion to CAS.
6. Receipt of W/O discrete with reversion to CAS.
7. Receipt of command degrading approach to Mode 2 state with reversion to CAS.
8. Loss of valid uplinked commands for more than 2 seconds (TILT) with reversion to CAS.
9. Detection of degraded onboard capability below that required for Mode 1 with reversion to CAS.
10. Selection of FLAPS AUTO.
11. MC Failure or selected to OFF

NOTE

With H2E+ and H3E MC OFPs, MC1 failed or selected to OFF and coupled ACLS previously engaged, the option to re-couple to ACLS is not presented on the autopilot page of the UFCDD when MC1 is restored. Deselecting and then reselecting ACL on the HSI will bring the CPL P/R option back if all coupled ACL engagement conditions are satisfied after the ACL TEST sequence is complete. If MC2 is cycled with ACL selected, the CPL P/R option is available without having to deselect/reselect ACL.

During an ACL coupled approach the D/L situation steering and the ICLS situation steering may remain selected for HUD display to allow the pilot to monitor the progress of the automatic control in capturing and holding the desired glide slope and azimuth.

NOTE

The D/L situation steering may be removed from the HUD by unboxing ACL on the MPCDD, however, reselection of the ACL option reinitializes the system as described in section 24.6.1.2.1.

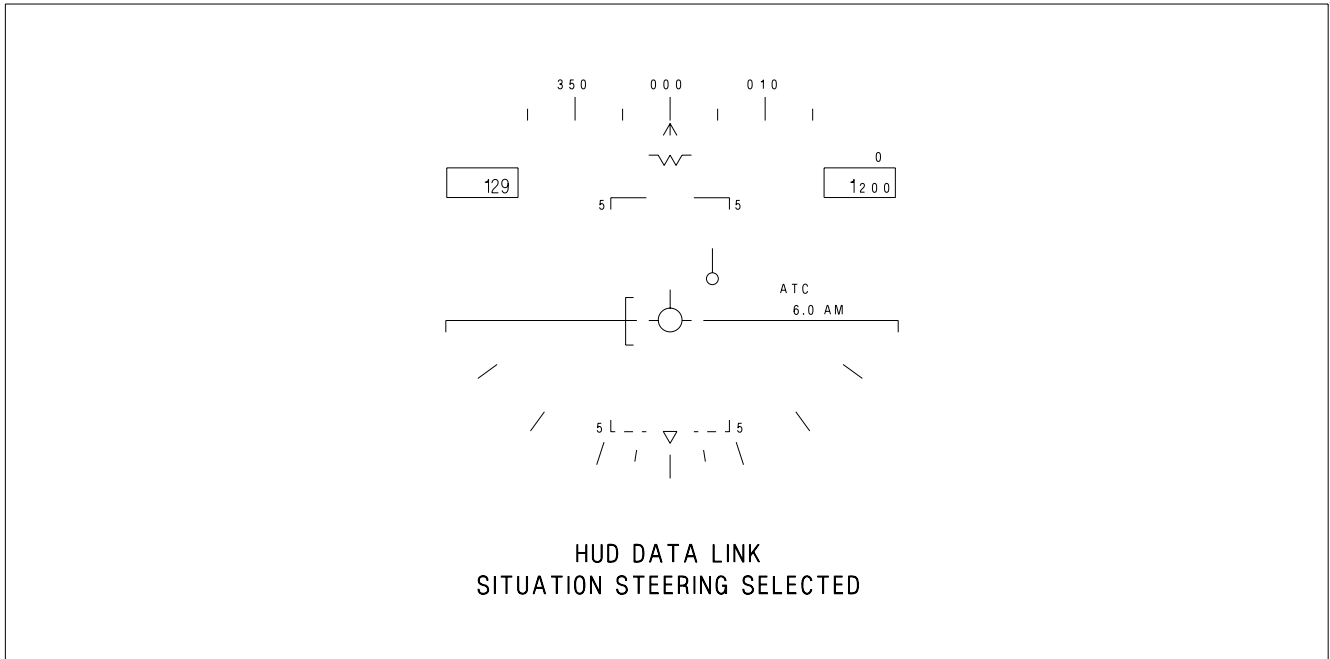

EFN520-161-1-001

Figure 24-27. ACL Mode 2 Steering Display

24.6.1.2.4 ACL Mode 1A. For an ACL Mode 1A approach, the aircraft may be coupled to data link commands as described in the Mode 1 paragraph, then uncoupled at minimums (200 feet and 0.5 mile) and manual control as described for Mode 2 used the rest of the way to touchdown.

24.6.1.2.5 ACL Mode 2. When a label 6 message is initially received and a Mode 1 or Mode 2 capability exists, a Mode 2 manual approach may be made. Data link HUD steering is automatically selected. The data link situation steering tadpole is displayed on the HUD with the tadpole referenced to the velocity vector as shown in figure 24-26. The ICLS situation display may remain selected on the HUD for crosscheck on the D/L situation display and/or either D/L or ICLS display may be deselected by actuating the option button on the MPCD. Mode 2 approaches may be made with or without ATC engaged, but ATC should be used for angle of attack/airspeed control, if it is available. If ATC is not engaged the HUD angle of attack bracket should be used to control AOA/airspeed and the glide slope maintained by flying the D/L situation steering display on the HUD.

24.6.1.3 Typical ACL Approach. Figures 24-26 and 24-27 describe the controls and displays for a “canned” Mode 1 ACL approach. The ACL mode is optimized for the described approach, but abbreviated approaches and/or deviations as required may be used, dependent upon existing operational procedures and collaboration between the pilot and carrier control. Figure 24-27 shows a plan view of the approach with controls and displays for selected points prior to marshal. Figure 24-28 shows descent from marshal to touchdown. The depicted scenario uses only D/L steering and commands complemented with ICLS steering in order to more clearly define D/L capability. It does not show TCN or WYPT steering which may be used in conjunction with, or independent of, D/L steering during the approach.

24.7 NAVIGATION DATA ENTRY

The UFCD has two data entry protocols, Standard Data Entry (SDE) and Fast Data Entry (FDE).

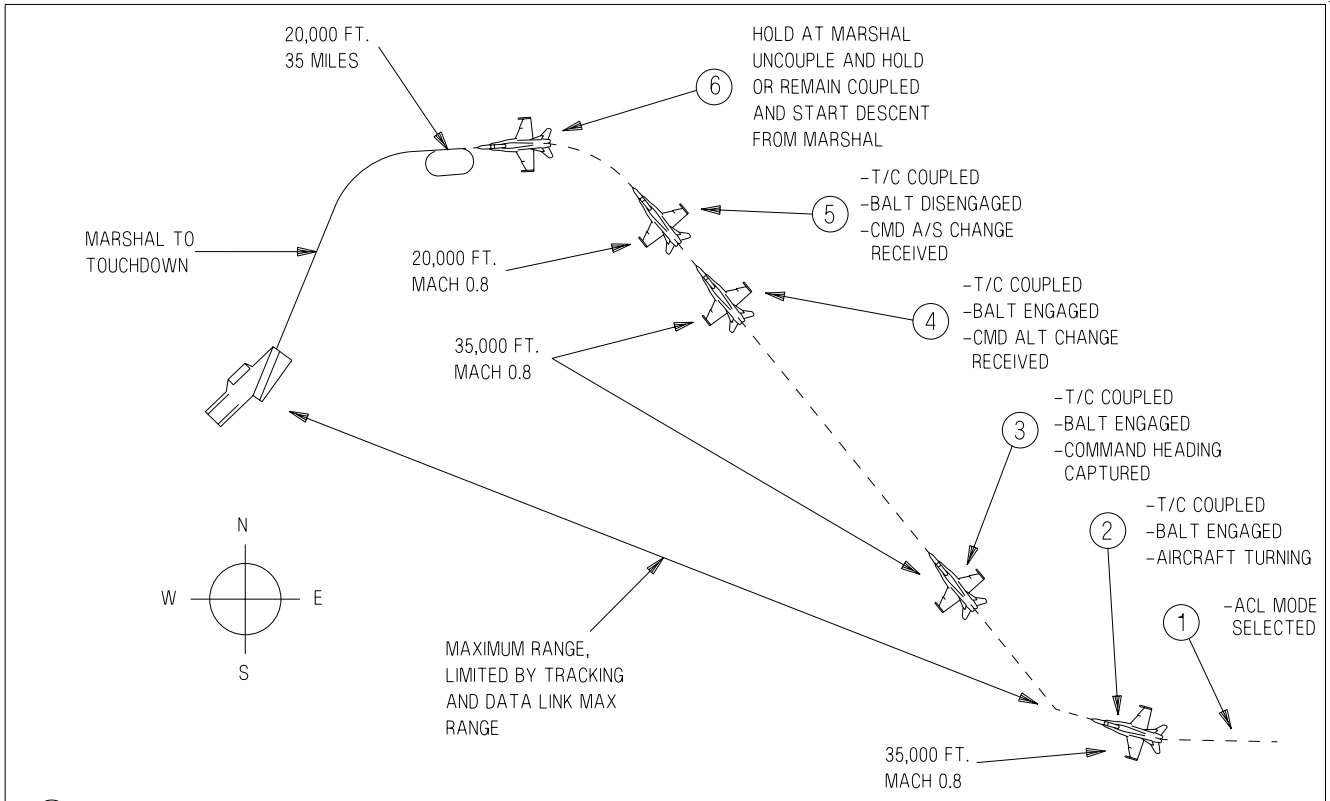

At ① the pilot has selected ACL mode on the HSI and the onboard system is in test, as noted on the link 4 display. The HH mode has been engaged as shown by the other autopilot option being displayed on the UFC. D/L command information may be shown on the link 4 display and the HUD during test.

① ACL MODE SELECTED (SYSTEM IN TEST)

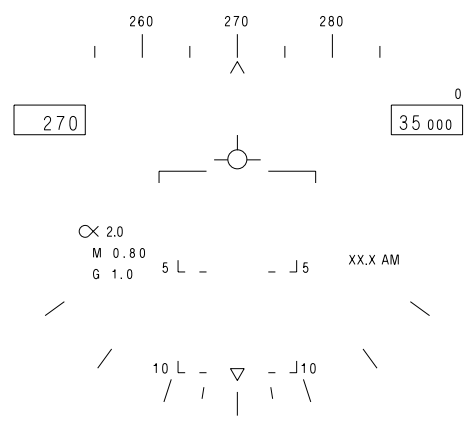
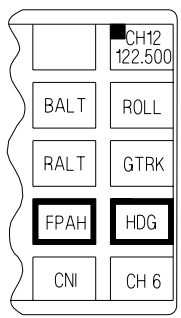
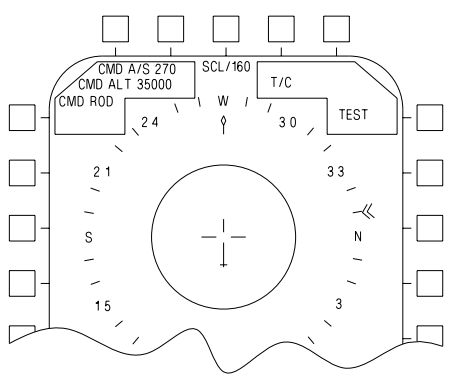
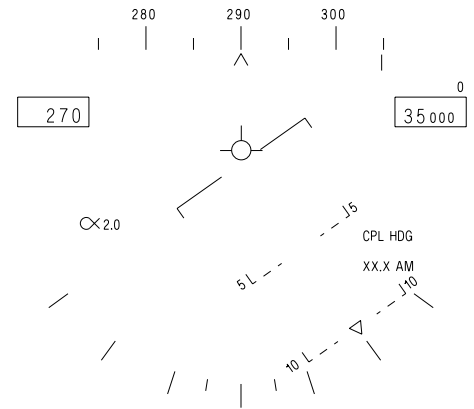
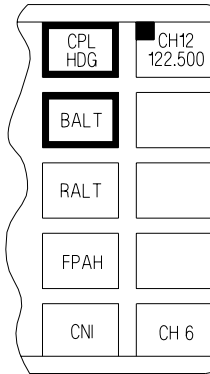
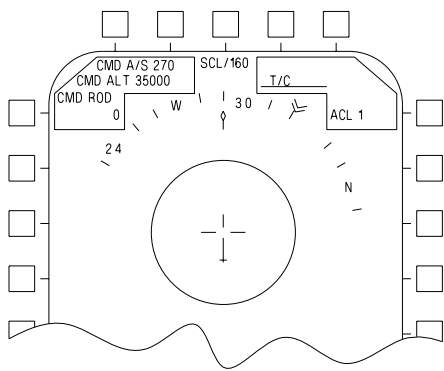

Figure 24-28. T/C Guidance to Marshal (Sheet 1 of 3)

At ② the test is complete and link 4 display shows ACL1 onboard capability as well as total loop T/C capability. The pilot has coupled to the uplinked T/C command heading and has engaged the BALT altitude hold mode. The aircraft is banking to capture the uplinked command.

② T/C COUPLED AND BALT ENGAGED (TURNING TO CAPTURE HEADING)



At ③ the aircraft has captured the desired T/C command heading and is holding an altitude of 35,000 feet.

③ T/C COUPLED AND BALT ENGAGED (COMMAND HEADING CAPTURED)

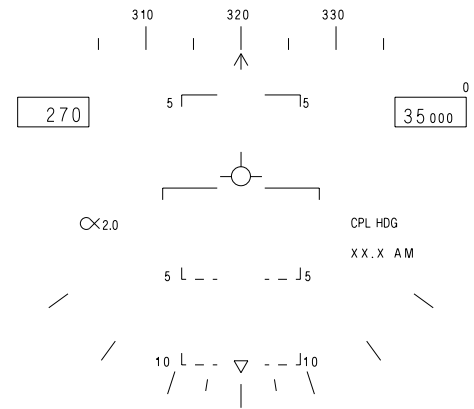
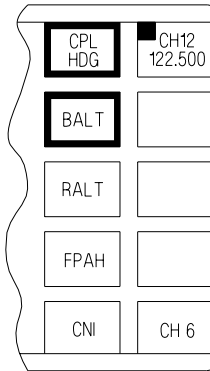
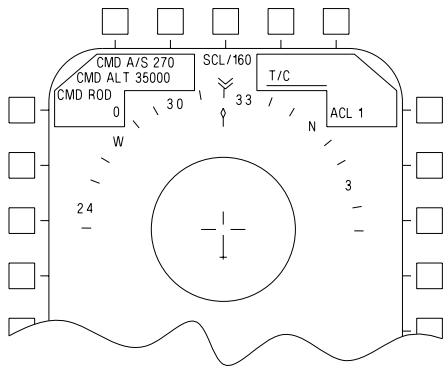

At ④ the uplinked T/C command altitude (CMD ALT) and rate of descent (CMD ROD) has just changed, as indicated by the underlines on the link 4 display. The DATA legend is flashed on the HUD for 10 seconds to inform the pilot that new information is displayed on the link 4 display. The new altitude and rate of descent commands inform the pilot to descend to 20,000 feet at a descent rate of 4,000 feet per minute.

④ T/C COUPLED AND BALT ENGAGED (CMD ALT CHANGE RECEIVED)

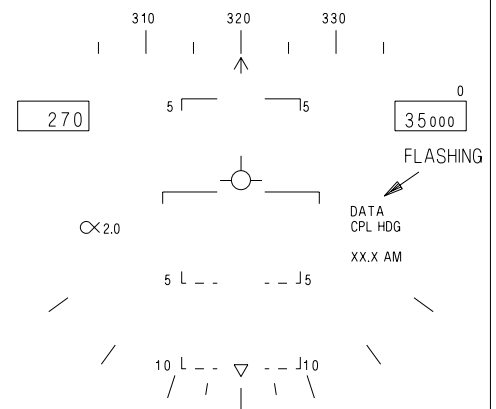
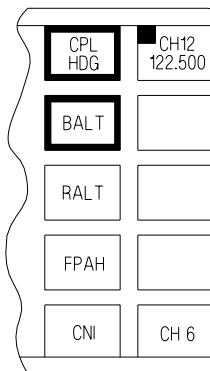
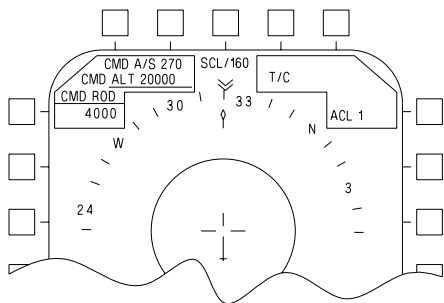
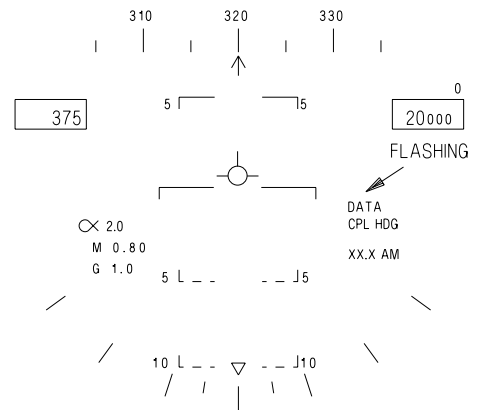
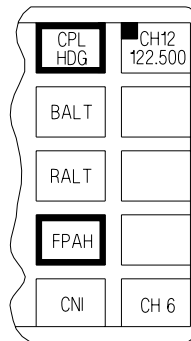
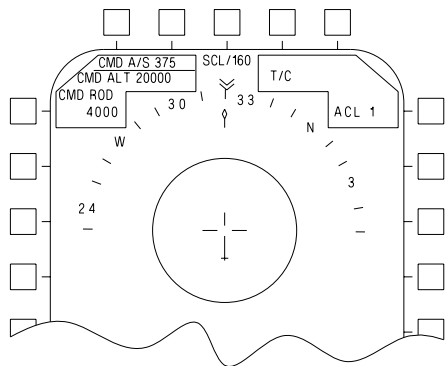

Figure 24-28. T/C Guidance to Marshal (Sheet 2)

At ⑤ the pilot has leveled off at the new altitude. A new uplinked command airspeed has also been received and the pilot has established the new airspeed which maintains 0.8 Mach at 20,000 feet as commanded. With the new altitude established, the pilot may reengage BAL T hold.

⑤ T/C COUPLED AND BAL T DISENGAGED (CMD A/S CHANGE RECEIVED)



At ⑥ the aircraft is set up to hold in the marshal pattern at 20,000 feet. The uplinked D/L commands have been removed from the displays due to receipt of the uplink NOT CMD. The carrier does not attempt to issue data link commands while the aircraft is holding in marshal since the uplinked command mechanization is not structured to provide aid during holding.

⑥ BAL T ENGAGED-T/C UNCOUPLED (HOLDING IN MARSHAL PATTERN)

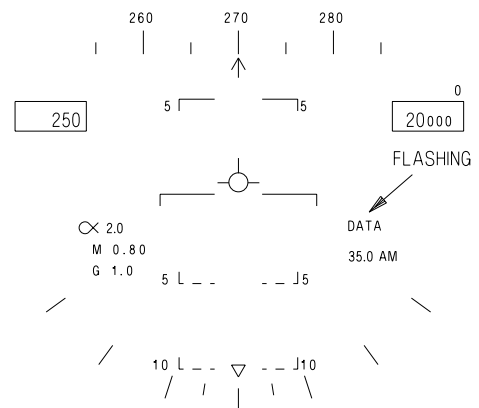
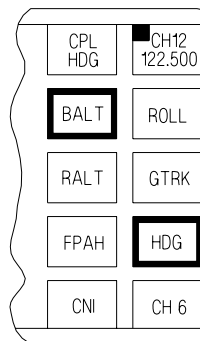
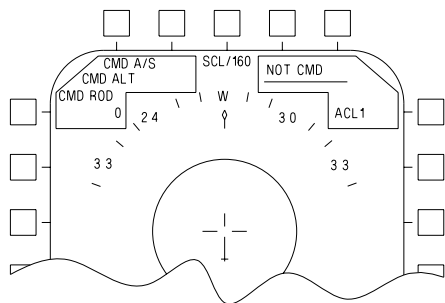

The pilot is given, via carrier control, a marshal departure time and a TACAN range and bearing window for departure at the designated time. Once on the outboard leg for marshal departures, the uplinked D/L command information (command heading, altitude, rate of descent and airspeed) may be uplinked and displayed.

Figure 24-28. T/C Guidance to Marshal (Sheet 3)

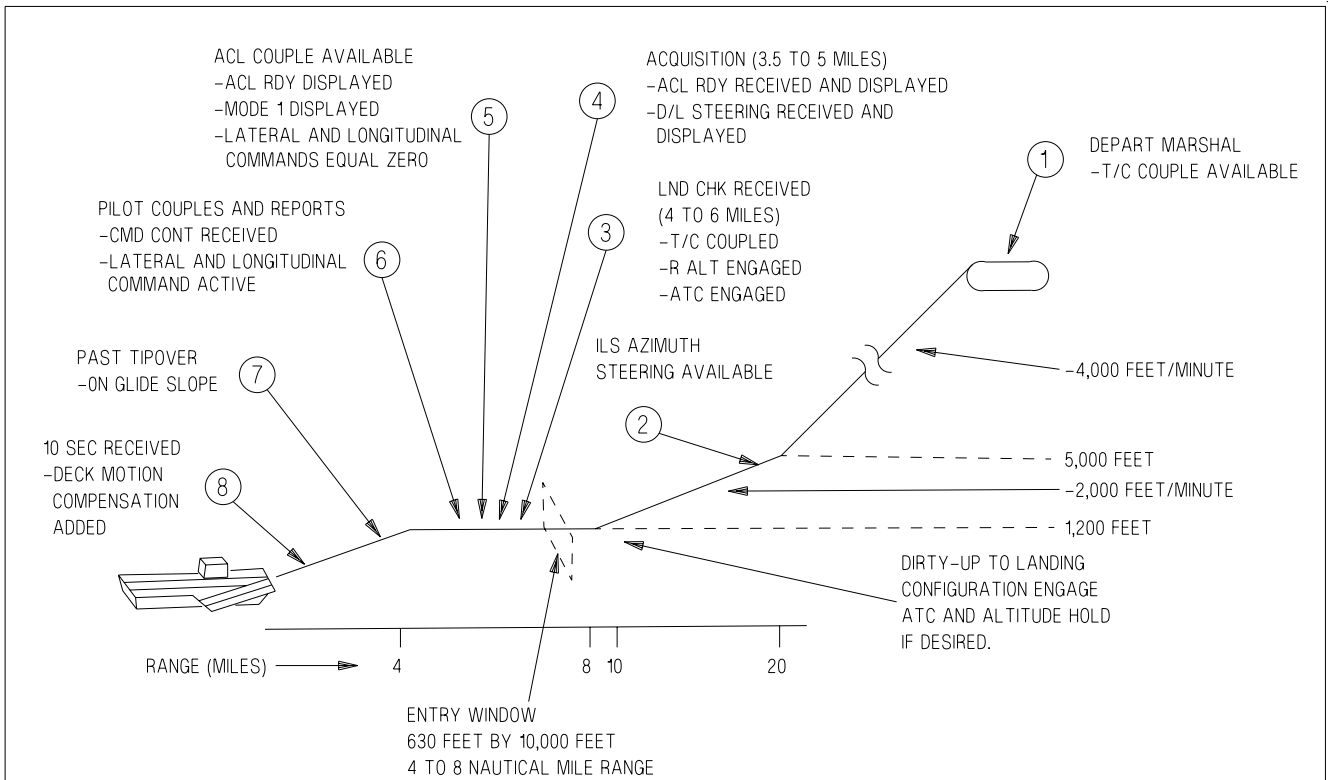

At ① the pilot started the descent to platform. The aircraft has again been coupled to uplinked T/C command heading and is banking to capture this heading. The pilot has established the desired airspeed and descent rate as commanded via uplinked commands shown on the link 4 display. The desired result of following these commands will be to arrive on platform at a 5,000 foot altitude and 20 nautical mile range, then to shallow the descent rate to 2,000 feet per minute.

① DEPARTING MARSHAL
(T/C COUPLED, BALT DISENGAGED VIA CSS OR
UFC BALT OPTION BUTTON ACTUATION)

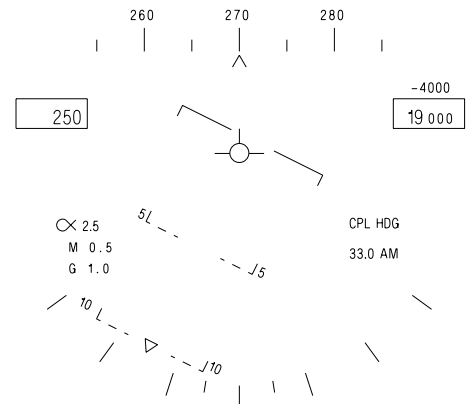
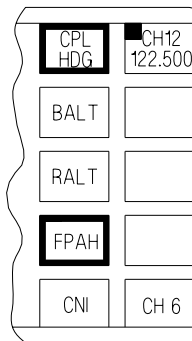
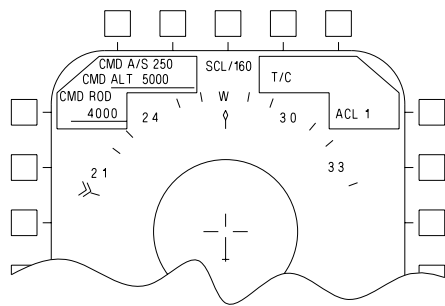
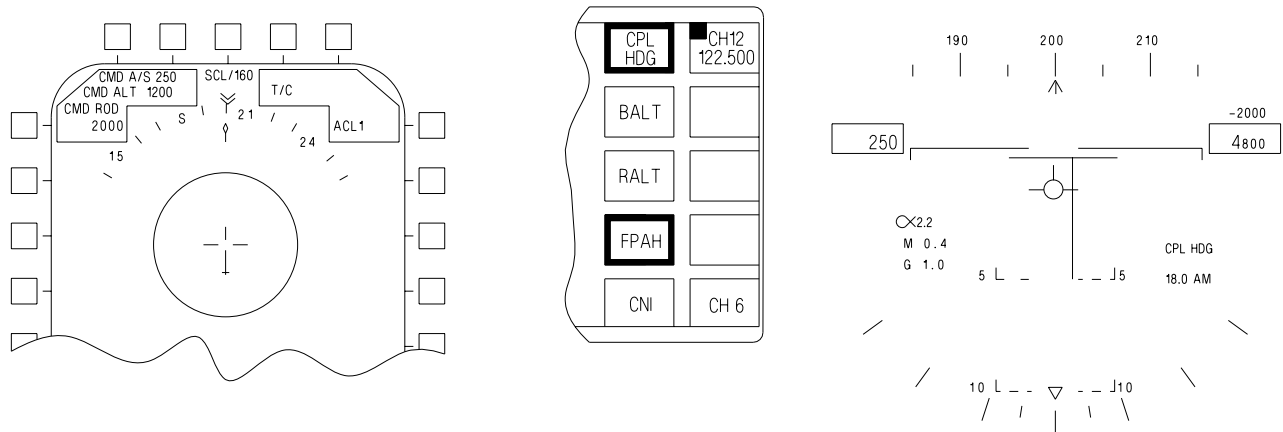

Figure 24-29. ACL Control - Marshal to Touchdown (Sheet 1 of 5)

At ② the aircraft is on platform with a descent rate of 2,000 feet per minute intended to arrive at a 1200 foot altitude at approximately 10 nautical miles. Valid ILS situation steering is available and has automatically been selected for HUD display when initially received. (The pilot may deselect the ILS steering via the HSI ILS steering select button when desired.) The pilot may utilize the ILS azimuth deviation to manually capture and/or maintain the desired azimuth alignment for approach, but the glide slope ILS deviation bar should not be used until tipover, since it will be indicating fly-up.

② ILS AZIMUTH STEERING VALID



At ③ the aircraft has leveled at 1200 feet, in the landing configuration, with auto throttle control engaged, as indicated by the ATC cue on the HUD. The underlined legend on the link 4 display shows that the uplinked LND CHK discrete has been received. This cue indicates that positive SPN-42/SPN-46 communication has been established as well as cuing the pilot that the aircraft should be in the landing configuration and at the approach speed. From this point in the approach, the HUD velocity vector should be caged to enhance and/or optimize the angle of attack bracket and situation steering display on the HUD.

③ LND CHK DISCRETE RECEIVED
(LANDING CONFIGURATION WITH T/C COUPLED,
RALT AND ATC ENGAGED)

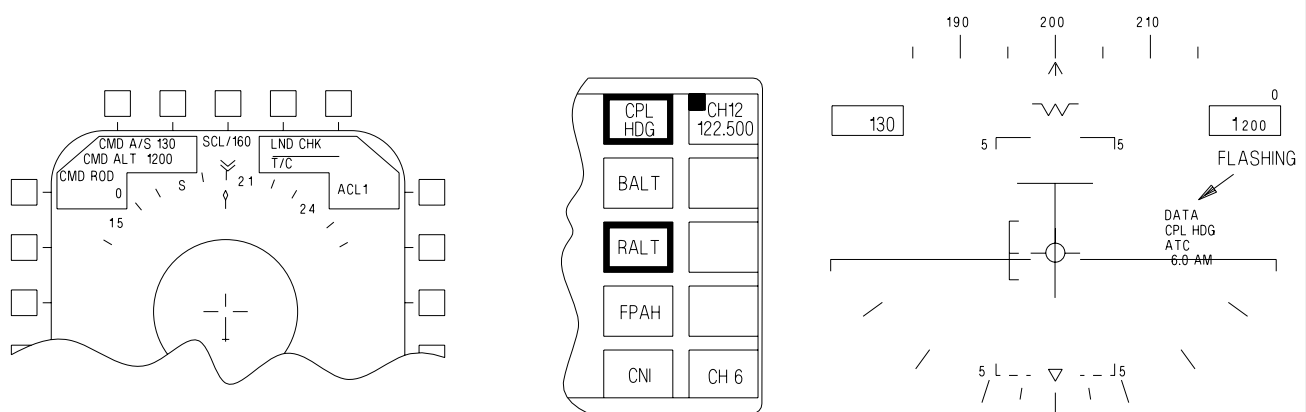

EFN520-163-2-007

Figure 24-29. ACL Control - Marshal to Touchdown (Sheet 2)

At ④ the pilot has engaged radar altitude hold (RALT) at 1,200 feet. The uplinked ACL RDY legend indicates that the SPN-42/SPN-46 has acquired the aircraft and is now uplinking longitudinal and lateral commands to the aircraft equal to 0 feet per second and 0° roll attitude. The MODE 1 legend indicates that the total loop is capable of, and/or ready for, a dual-axis couple of the uplinked commands to the FCS. The FCS is still coupled to the uplinked command heading as indicated by the CPL HDG legend displayed on the HUD. Also available is the uplinked D/L situation steering shown via the tadpole display on the HUD. The pilot has deselected the ILS steering, but may select or deselect either or both ILS and D/L situation steering to monitor coupled control progress.

④ ACQUISITION
(T/C COUPLED, ACL RDY RECEIVED, D/L STEERING AUTOMATICALLY DISPLAYED, AND PILOT HAS DESELECTED ILS STEERING)

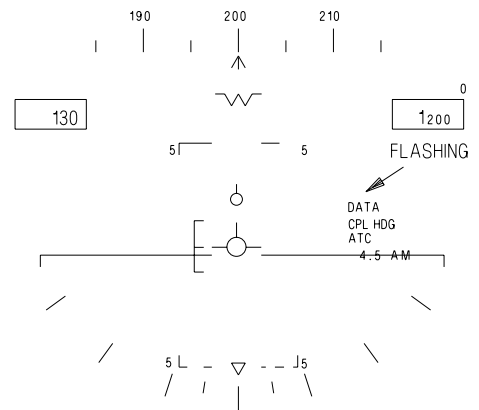
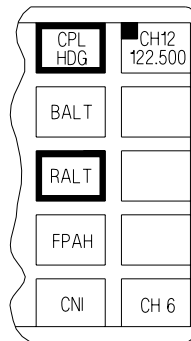
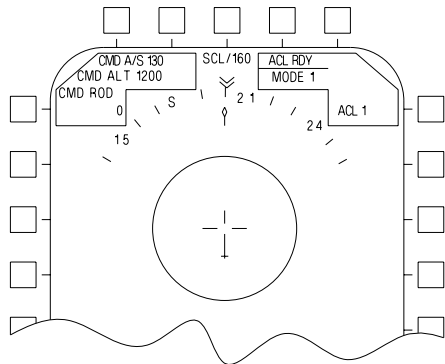

At ⑤ the pilot has uncoupled from the uplinked T/C command heading by deselection of the CPL HDG option on the UFCD. When the aircraft is not coupled, the ACL RDY legend is displayed on the HUD. To couple the aircraft to the dual-axis uplinked longitudinal and lateral commands requires that the pilot again select the CPL P/R option on the UFCD.

⑤ ACL COUPLE AVAILABLE
(T/C UNCOUPLED BY PILOT)

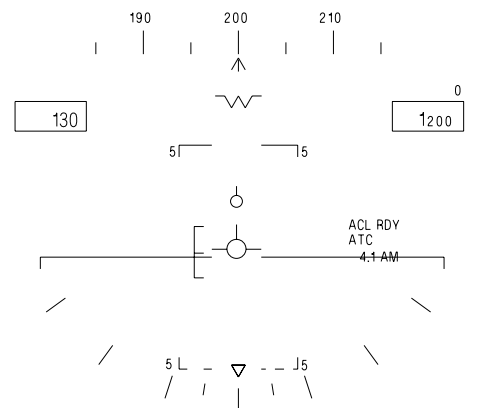
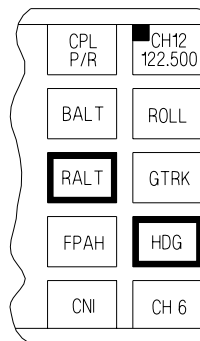
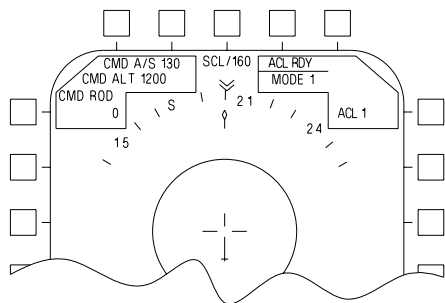
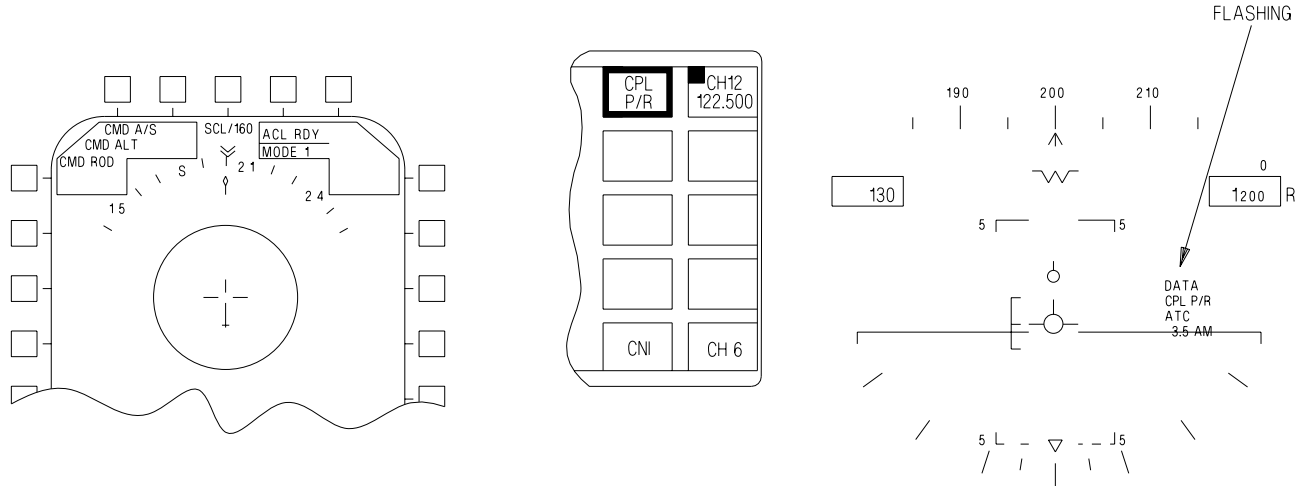

Figure 24-29. ACL Control - Marshal to Touchdown (Sheet 3)

At ⑥ the aircraft is now coupled to the uplinked dual-axis commands as indicated by the CPL P/R legend display on the HUD. The pilot has reported couple to the carrier control via voice communication and subsequently the aircraft has received the uplinked CMD CNTR discrete indicating that the uplinked longitudinal and lateral commands are active. The uplinked commands of heading, airspeed, altitude, and rate of descent are removed from the link 4 and HUD displays by the MC when the aircraft is coupled to the dual-axis commands as these commands are no longer updated by the carrier. The pilot will be advised via voice communication as he approaches tipover, but no aircraft control action is required on his part. (At least 30 seconds of coupled control is desirable prior to tipover.)

⑥ ACL MODE COUPLED BY PILOT
(CMD CNT RECEIVED)



At ⑦ the aircraft is past tipover on the desired glide slope and azimuth as indicated by the alignment of the D/L tadpole inside the velocity vector on the HUD.

⑦ PAST TIPOVER
(ACL MODE COUPLED, ON GLIDE SLOPE)

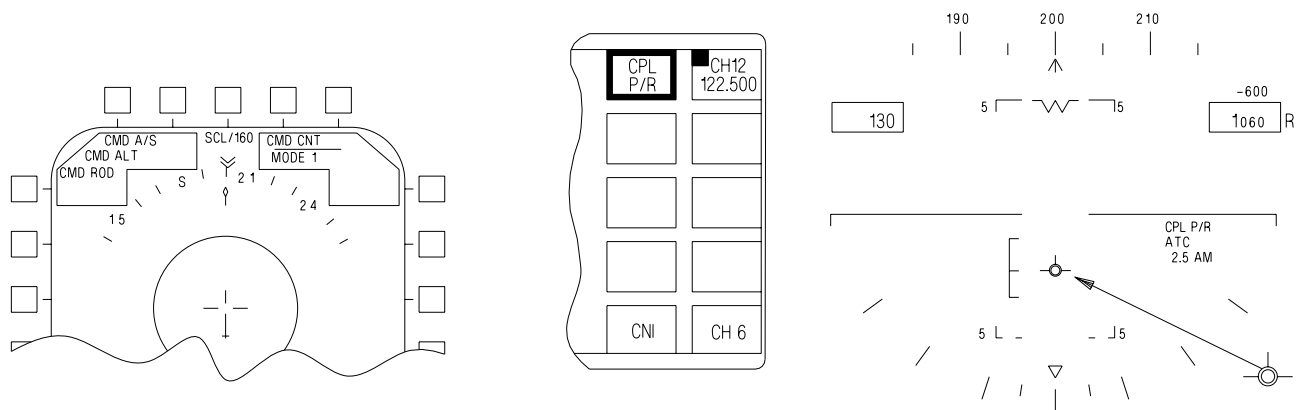

EFN520-163-4-007

Figure 24-29. ACL Control - Marshal to Touchdown (Sheet 4)

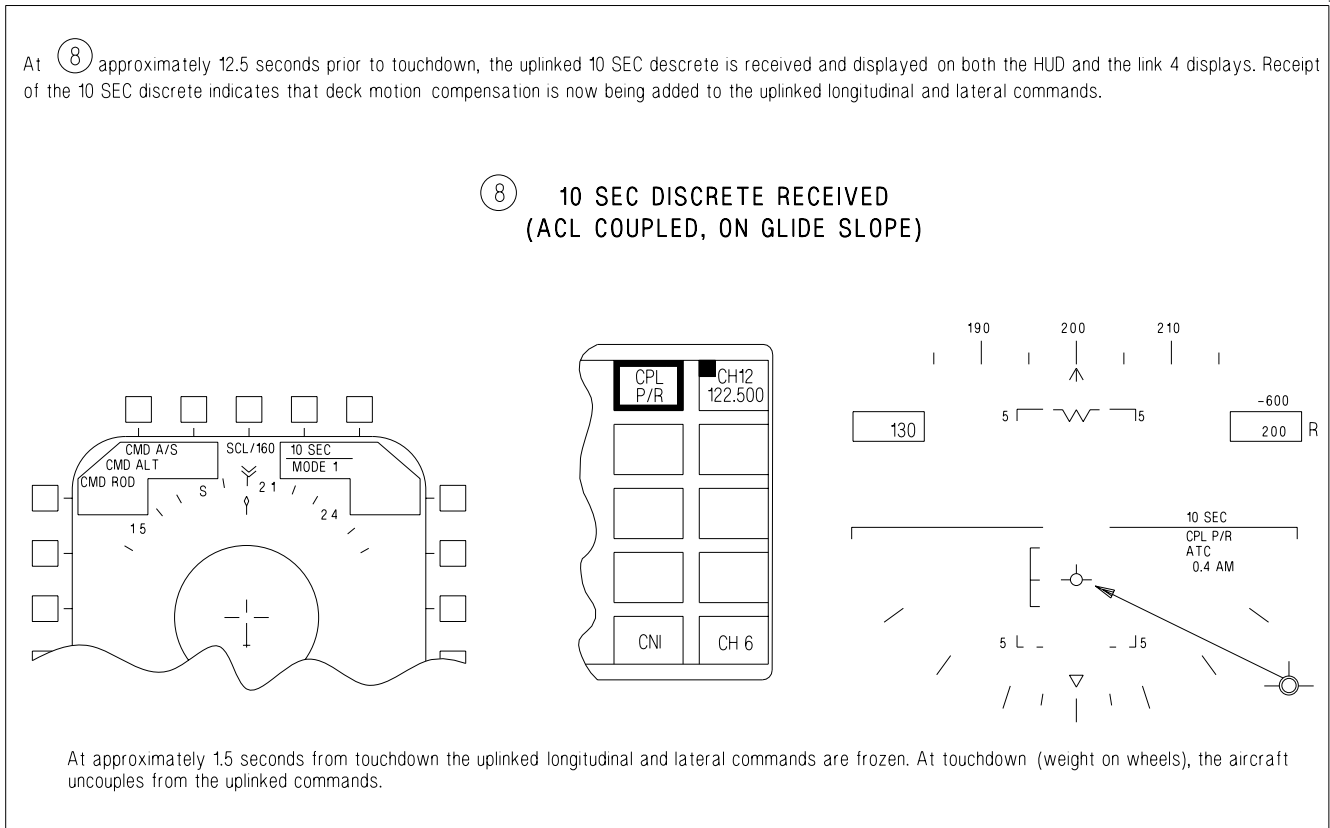

Figure 24-29. ACL Control - Marshal to Touchdown (Sheet 5)

24.7.1 Standard Data Entry. With MC OFP 18E, SDE digits are entered using the keyboard followed by the enter (ENT) key. In many cases, the option for which the data is being entered must first be selected prior to entering digits. Selection of the ENT option causes the digits in the scratchpad to flash once, confirming that the ENT has been accepted. The majority of the data entry displays use SDE protocol and are recognized by the presence of the ENT key.

24.7.2 Fast Data Entry. With MC OFP 18E some data, and with MC OFP H1E AND UP all data are entered using the keyboard followed by selecting the option directly. This protocol does not use the enter (ENT) key. With MC OFP 18E, MAN replaces ENT. With MC OFP H1E AND UP, NEWS replaces ENT.

24.7.3 Data Entry Using the Shifted Keypad. The N-E-W-S option is provided on all UFCD data entry displays with MC OFP H1E AND UP. The shifted keypad provides the ability to enter a negative sign, a decimal point, degrees, minutes, and seconds symbols, and North (N), East (E), West (W), and South (S) entries for latitude and longitude entries.

CHAPTER 25

Backup/Degraded Operations

25.1 MISSION COMPUTER FAILURE

25.1.1 Mission Computer Failure (Non-AMCD Aircraft). If there is a failure of MC 1 (navigation computer) there are certain capabilities which are lost. Some basic navigation capabilities are provided by the backup functions of MC 2. Functions not available when MC 1 is failed are the autopilot functions, G limiter and roll limiter, map and navigation situations display, and GPS and the HUD steering displays (except for data link). In addition, the HSI functions of position keeping source selection, position updating, target marking, and data entry and display are not provided when MC 1 is failed. The functions provided by MC 2 are the basic HUD flight data; backup HSI display with INS, TACAN and ADF information; mode II ACL capability; and automatic throttle control. The control of CNI equipment by the UFCDD is not affected by an MC 1 failure, and ILS steering is available on the standby attitude indicator. No backup position keeping is provided if the INS fails when MC 1 is failed. In this case the standby attitude reference indicator is used by MC 2 for attitude information and the velocity vector is not displayed on the HUD.



Failure of MC 1 causes a loss of all DDI caution displays except MC 1, HYD 1A, HYD 1B, HYD 2A, and HYD 2B.

25.1.1.1 Backup HUD Display. With MC 1 failed, the backup HUD display is identical with the primary HUD display except that the bank angle scale is not provided and the heading scale is at the same position as in the weapon delivery modes. The ghost velocity vector is provided during backup operation and the velocity vector may be caged/uncaged.

25.1.1.2 Backup HSI Display. With MC 1 failed, the backup HSI display consists of a magnetic compass rose oriented heading-up with a TACAN pointer and an ADF pointer. A digital readout of TACAN bearing and distance and the station identifier are provided in the upper left corner. The INS present position is displayed inside the compass rose at the top center. Waypoint 0 is displayed. The ACL mode option pushbutton is displayed for selection.

25.1.2 Mission Computer Failure (AMCD Aircraft)

25.1.2.1 Mission Computer Failure (AMCD Aircraft) - Single. In the event of an MC failure, backup functions are the same in either computer. Basic navigation and situational awareness functions are available, and cautions and advisories are displayed. TACAN and IFF can be turned off/on in backup mode. TACAN station ID or IFF mode code changes can be entered during backup mode operation. The radar altimeter cannot be turned on/off, but the RALT bug can be entered via the UFCDD. ACL Mode II is available in MC backup mode. Autopilot, G-limiter and roll limiter are not available in MC backup mode.

25.1.2.2 Mission Computer Failure (AMCD Aircraft) - Dual. When both MCs are offline or in initialization, the SDC acts as the backup bus controller and transmits a limited HUD display of essential flight information to the forward MPCDD and forward UFCDD. The FCC provides calibrated

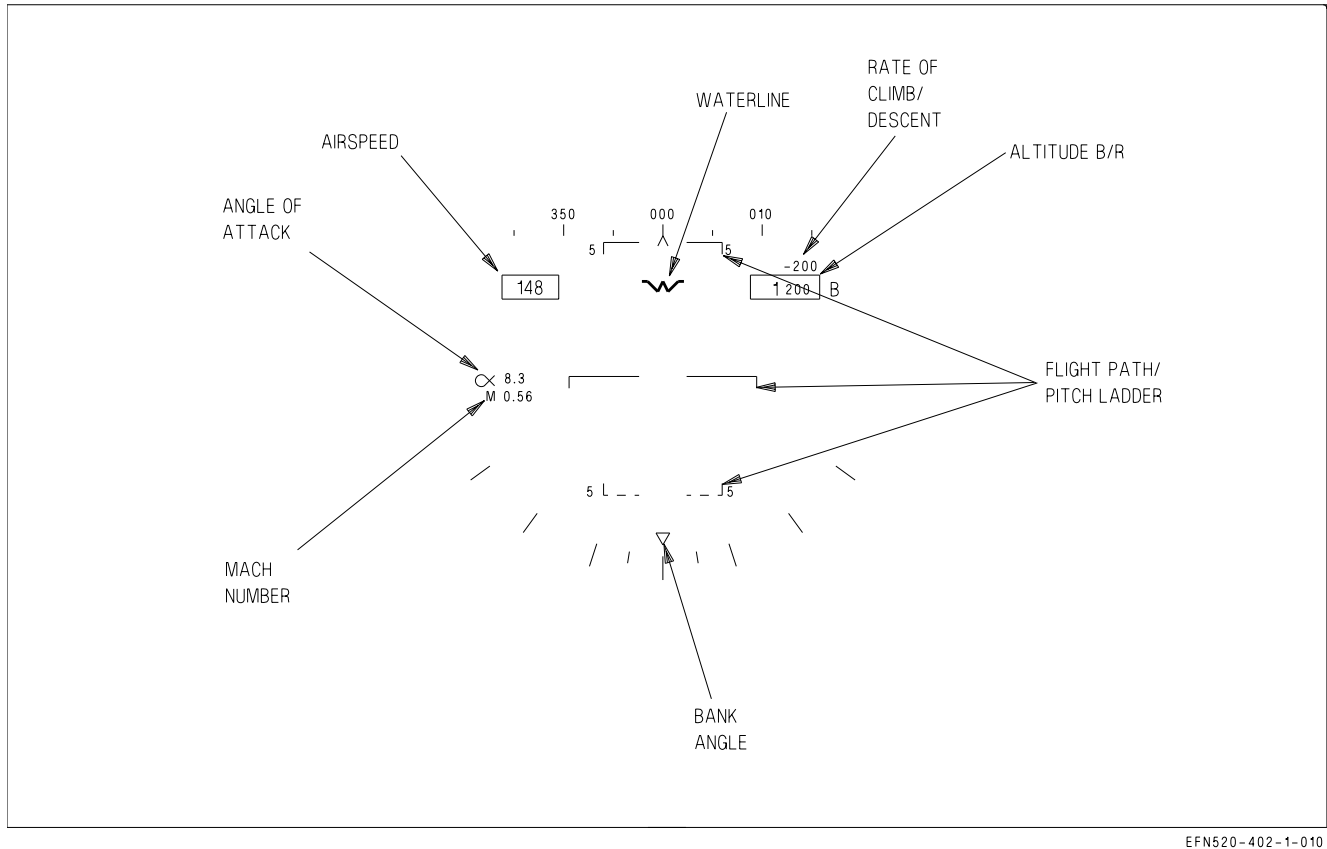

EFN520-402-1-010

Figure 25-1. SDC Backup HUD Display (AMCD Aircraft)

airspeed, AOA, Mach, vertical velocity, and baro altitude. The CSC provides pitch and bank attitude reference and radar altitude. See figure 25-1. The SDC also provides L ATS and R ATS cautions.

25.1.2.3 Backup Navigational Information on Backup HUD. The navigational information on the backup HUD is identical to the full-up HUD. Limited A/A and no A/G support is available.

25.2 BACKUP ATTITUDE AND NAVIGATION SYSTEM

If a failure occurs in the primary attitude and navigation system (INS), output signals of pitch, roll, magnetic heading, and airspeed are provided to the mission computer system for use in the backup attitude navigation computations. The backup system consists of standby attitude reference indicator, static power inverter, and magnetic azimuth detector.

25.2.1 Standby Attitude Reference Indicator. The standby attitude reference indicator (figure 25-2) is a self-contained pitch and roll instrument which is mounted on the main instrument panel. An electrically driven gyro maintains vertical orientation by use of an electronic erection system. The erection system automatically cuts off when lateral accelerations exceed approximately 0.15 g. The gyro spin speed and erection system provides a minimum of 3 minutes of attitude information with a total power loss. Pitch and roll servos provide back up pitch and roll attitude for use by other systems. The attitude presentation is 360° in roll, 92° in climb, and 78° in dive.

25.2.2 Static Power Inverter. If there is an interruption or loss of aircraft ac power, 28 volt dc power is applied to the static power inverter to produce the 115 volt ac power needed for standby attitude reference indicator operation.

NOTE

The aft cockpit standby attitude reference indicator is not powered by the essential bus. Hence, it only operates for 3 minutes after a loss of aircraft ac power.

25.2.3 Magnetic Azimuth Detector. The magnetic azimuth detector (MAD) consists of three sensing elements configured in a wye. The sensing elements are mounted so that average positions are maintained in the horizontal component of the earth magnetic field. The air data functions process the detected magnetic heading and develop the magnetic error compensation signals.

25.2.4 Backup Attitude and Navigation System Controls and Indicators. The controls and indicators for the backup system are on the MPCD (or aft cockpit 8 x 10 display for LOT 26 AND UP) and the standby attitude reference indicator.

25.2.4.1 MPCD (or 8 x 10 Display). The MPCD (or 8 x 10 display) provides horizontal situation and steering control displays.

25.2.4.2 Standby Attitude Reference Indicator Controls and Indicators. The controls and indicators on the standby attitude reference indicator (figure 25-2) are described as follows:

1. OFF flag. This flag is in view when power is removed or the pull to cage knob is pulled out.
2. Miniature aircraft. This represents the nose and wings of the aircraft and indicates pitch and roll attitude relative to the horizon. The miniature aircraft is adjustable through $\pm 5^\circ$ of pitch trim by rotating the pull to cage knob clockwise or counterclockwise when the knob is pushed in.
3. Pull to cage knob. The knob is pulled out and held to orient the gyro spin axis to the ARI case (pitch position). When the knob is pulled out and rotated clockwise to engage detent, the ARI becomes caged.



Do not lock the gyro in the caged position with the pull to cage knob if the gyro is spinning. Damage to the gyro might occur if the indicator or the aircraft is moved while the gyro is spinning and caged. If the knob is in the locked position, it must be pulled out to clear the detent before it can be turned counterclockwise.

4. Slip indicator (inclinometer). This mechanical indicator displays sideslip.
5. Rate of turn needle. This needle displays the rate of turn. One needle width of deflection indicates a 90° per minute rate of turn.
6. Test switch. The vertical and horizontal pointers and rate of turn needle are deflected when the test switch is pressed.
7. Pointer shield. This shield conceals the vertical pointer in the stowed position.

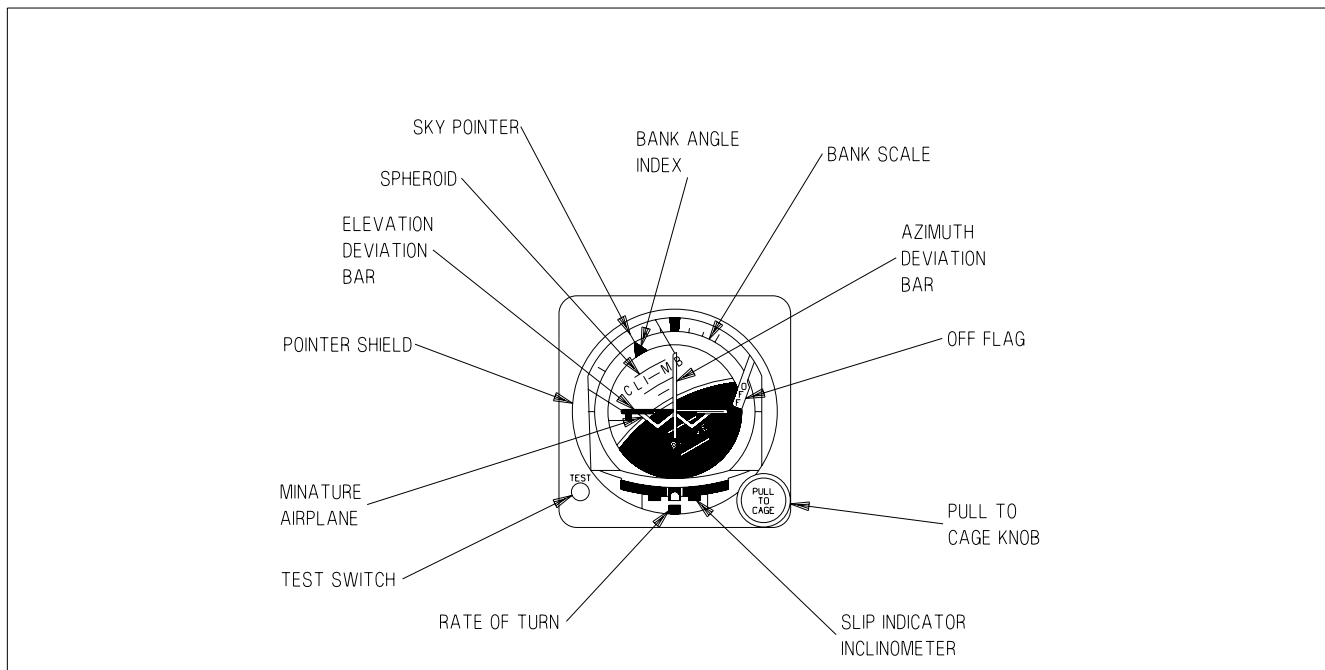

EFN520-340-1-001

Figure 25-2. Standby Attitude Reference Indicator

8. Elevation deviation bar. This bar provides direction information for pitch steering.
9. Bank scale. The scale rotates with the aircraft to provide measurement of angular displacement by the bank angle index during maneuvers.
10. Azimuth deviation bar. This bar provides direction information for azimuth steering.
11. Sky pointer. The pointer rotates with the aircraft to indicate vertical (sky) in any roll attitude.
12. Bank angle index. The index indicates vertical in any roll attitude.
13. Display sphere. The sphere is directly coupled to the gyro gimbals to provide a direct reading of pitch and roll. The sphere is marked at each 5° in pitch.

25.3 NAVIGATION BACKUP

Position keeping for aircraft navigation requires available sources of heading information, attitude information, and velocity. The INS normally provides position keeping for the aircraft. Under various failure conditions alternate sources of heading, attitude, and/or velocity information may be used for position keeping. The backup heading modes are discussed in a following paragraph. The attitude reference indicator is the alternate source of attitude information. The alternate sources of velocity information are air data (true airspeed and angle of attack) or radar doppler velocities. Air data vertical velocity is an alternate velocity source if only the vertical component of INS velocity is invalid. The flight control set is an alternate source for angle of attack information.

The system automatically reverts to alternate data sources under failure conditions. For example, air data position keeping is automatically selected in case of an INS failure. If MIDS is installed and operating, MIDS is automatically selected as the aircraft position keeping source when INS or GPS fails. Because MIDS position keeping is unreliable, POS/ADC should be manually selected if

POS/MIDS is displayed. Air data position keeping uses true airspeed, and angle of attack from the air data functions, and the last computed wind or the wind inserted by the pilot on the UFCDD. The wind can also be updated during air data position keeping by performing a velocity update. A new wind is calculated when the velocity update is accepted. The velocity vector on the HUD is flashed at a slow rate (on for 0.8 seconds and off for 0.8 seconds) during air data position keeping. A POS/ADC caution is displayed on the DDI along with a master caution light and tone when the INS reverts to ADC position keeping.

The radar doppler velocities are automatically used by the mission computer if available and no other velocity sources are available (INS, GPS and FCC air data failed). This applies whether or not TACAN position keeping is selected. Doppler velocities are available when the radar is operating in a doppler beam sharpened (DBS) mode or PVU mode. The MC automatically uses the doppler velocities under these conditions if a DBS mode is selected or if velocity update is selected without accepting or rejecting the update.

25.3.1 Navigation Controls and Indicators.

25.3.1.1 HSI Display. The symbols and digital readouts that normally appear on the HSI during backup system operation are the same as in the INS operation except for the POS option display.

25.3.1.2 POS Option Display. Pressing the POS/ADC pushbutton on the HSI display commands the mission computer to use air data function true air speed, MAD heading, and wind speed and direction to compute aircraft latitude and longitude in waypoint steering computations.

25.3.2 Backup Heading Mode Control. If the INS computer fails or if the INS switch is rotated to the GYRO position the INS reverts to the gyro mode and true heading is no longer available from the INS. The mission computer slaves the INS platform heading with the MAD to provide damped magnetic heading. The slaving of the INS platform to the MAD occurs in straight and level flight. During maneuvers, when roll is greater than $\pm 5^\circ$ or pitch is greater than $\pm 10^\circ$, the MAD output is not used. Upon reversion to the Slaved heading mode, the bottom row of option selections on the HSI are HDG/SLV, SYNC, and ERECT. The SYNC option can be used to quickly synchronize the heading with the MAD output if a heading error exists. The MC automatically synchronizes the heading with the MAD output when the heading error is greater than 11.25° during level flight. Pressing the ERECT option commands the INS to increase the gains in the INS erection loops, fast-leveling the platform. SYNC and ERECT are momentary options and should be used only in straight and level flight.

If it is desired to change the backup heading mode, the heading status option pushbutton should be pressed (HDG/SLV in this case) and the available heading options (SLV, DG, and COMP) are presented on the HSI. Selecting any of these options commands the MC to display the selected option and the necessary controls for that option. For failure conditions the next best available source is automatically selected.

Selection of the DG heading mode or failure of the MAD while in the HDG/SLV mode causes the bottom pushbuttons on the HSI to display HDG/DG, HDG (arrow left), HDG (arrow right), and ERECT. The MC computes aircraft heading using the INS platform heading as a smoothed heading source to compensate for the difference between true north, platform heading (wander angle), and earth rate. The aircrew may correct the aircraft heading by using the HDG slew option buttons. Following the initial setting of heading, the MC provides heading compensation for earth rate but changes in magnetic variation must be entered using the UFCDD because the aircraft uses the last known value of magnetic variation.

If the aircrew selects the compass heading mode, if the INS is turned off, or if the INS fails completely the mission computer uses the MAD output, damped with body rate data from the flight control system. During maneuvers, when roll is greater than $\pm 5^\circ$ or pitch is greater than $\pm 10^\circ$, the flight control system body rates are used to determine heading. In the compass heading (HDG/COMP) mode, the bottom buttons are labeled HDG/COMP and ERECT. The ERECT option is displayed when the INS is operating in the AHRS mode. The MC uses the last known magnetic variation to compute true heading.

25.4 BACKUP FREQUENCY CONTROL

Backup frequency control for the radios in case of an UFCD or MPCD malfunction is provided by the multiplex bus and a DDI display. The UFC backup (UFC BU) display can be selected from the SUPT menu. Both comm 1 and comm 2 can be controlled from the UFC BU display. When the COM1 or COM2 button is pressed, the frequency on which that radio is operating is displayed below the legend COM1 or COM2, as appropriate. A new frequency is selected by selecting OVRD and using the numerical buttons along the sides of the display and the ENT button at the bottom. Frequencies can be entered to 5 KHz of resolution. As the new frequency is entered, it is displayed in the scratchpad above the COM1 or COM2 legend. When the ENT button is pressed, the frequency displayed in the scratchpad is stored in the mission computer as the preset frequency for the radio. Pressing the CLR button clears the scratch pad if an error is made when entering a backup frequency. Selecting the OVRD option in the upper right corner of the display boxes the option and the radio operates on the preset frequency stored in the mission computer, overriding the normal frequency control from the UFCD. Frequency control reverts to the UFCD when OVRD is deselected. The frequency displayed below the COM1 or COM2 legend is always the frequency on which the radio is operating, whether or not OVRD is selected. Upon power up with WonW, the preset frequencies stored in the mission computer for COM1 and COM2 are initialized to be the same as the last valid radio operating frequencies.

CHAPTER 26

Visual Communications

Communications between aircraft are visual whenever possible. Flight leaders shall insure that all pilots in the formation receive and acknowledge signals when given. The visual communications chapters of NAVAIR 00-80T-113 should be reviewed and practiced by all pilots. Common visual signals applicable to flight operations are listed in figure 26-1.

GENERAL SIGNALS

SIGNAL		MEANING	RESPONSE
DAY	NIGHT		
Thumbs up, or nod of head.	Flashlight moved vertically up-and-down repeatedly.	Affirmative. (“Yes”, or, “I understand.”)	
Thumbs down, or turn of head from side to side.	Flashlight moved horizontally back-and-forth repeatedly.	Negative. (“No”, or, “I do not understand.”)	
Hand cupped behind ear as if listening.		Question. Used in conjunction with another signal, this gesture indicates that the signal is interrogatory.	As appropriate.
Hand held up, with palm outward.		Wait	
Hand waved back and forth in an erasing motion in front of face, with palm turned forward.	Letter N in code, given by external lights.	Ignore my last signal.	
Employ fingers held vertically to indicate desired numeral 1 through 5. With fingers horizontal, indicate number which added to 5 gives desired number from 6 to 9. A clenched fist indicates 0. (Hold hand near canopy when signaling.)		Numerals as indicated.	A nod of the head (“I understand”). To verify numerals, addressee repeats. If originator nods, interpretation is correct. If originator repeats numerals, addressee should continue to verify them until they are understood.

Figure 26-1. Visual Communications (Sheet 1 of 9)

GENERAL SIGNALS (CONT)

SIGNAL		MEANING	RESPONSE
DAY	NIGHT		
Make hand into cup shape, then make repeated pouring motions.		I am going to dump fuel.	
Slashing motion of index finger across throat.		I have stopped dumping fuel.	

MALFUNCTIONING EQUIPMENT (HEFOE CODE)

SIGNAL		MEANING	RESPONSE
DAY	NIGHT		
Weeping signal and then indicating by finger - numbers 1 to 5 the affected system.	Flashlight held close to top of canopy, pointed toward wingman, followed by 1 to 5 dashes to indicate system affected.	Number of fingers or dashes means: 1. Hydraulic/FCS 2. Electric 3. Fuel 4. Oxygen 5. Engine	Day: nod, or thumbs up. ("I understand.") Night: Vertical movement of flashlight. Pass lead to disabled plane or assume lead, if indicated.

Figure 26-1. Visual Communications (Sheet 2 of 9)

TAKEOFF, CHANGING LEAD, LEAVING FORMATION, BREAKUP, LANDING

SIGNAL		MEANING	RESPONSE
DAY	NIGHT		
<p>1. Section/Division Lead gives thumbs up.</p> <p>2. Wingman gives thumbs up.</p> <p>3. Section/Division Lead kisses off wingman.</p>	<p>1. Section/Division Lead turns formation lights off.</p> <p>2. Wingman turns formation lights off. 2a. Wingman turns formation lights on.</p> <p>3. Section/Division Lead turns formation lights on.</p>	<p>1. I am ready to take position on the runway.</p> <p>2. I am ready to take position on the runway. 2a. I am ready for takeoff roll.</p> <p>3. I am executing takeoff roll.</p>	<p>1. Standby for response from wingman.</p> <p>2. Lead calls for take-off. 2a. Section/Division Lead formation lights on.</p> <p>3. Wingman roll in order.</p>
<p>1. Leader pats self on the head, points to wingman.</p>	<p>1. Lead aircraft turns strobe lights ON.</p> <p>2. If external lights are inoperative, leader shines flashlight on hard-hat, then shines light on wingman.</p>	<p>Leader shifting lead to wingman.</p>	<p>1. Wingman pats head and assumes lead.</p> <p>2. Wingman turns strobe lights OFF and assumes lead.</p> <p>If external lights are inop-</p> <p>3. Wingman shines flashlight at leader, then on his hard hat and assumes lead.</p>
<p>Leader pats self on head and holds up two or more fingers.</p>		<p>Leader shifting lead to division designated by numerals.</p>	<p>Wingman relays signal; division leader designated assumes lead.</p>
<p>Pilot blows kiss to leader.</p>		<p>I am leaving formation.</p>	<p>Leader nods (“I understand”) or waves goodbye.</p>
<p>Leader blows kiss and points to aircraft.</p>		<p>Aircraft pointed out leave formation.</p>	<p>Wingman indicated blows kiss and executes.</p>
<p>Leader points to wingman, then points to eye, then to vessel or object.</p>		<p>Directs plane to investigate object or vessel.</p>	<p>Wingman indicated blows kiss and executes.</p>

Figure 26-1. Visual Communications (Sheet 3 of 9)

TAKEOFF, CHANGING LEAD, LEAVING FORMATION, BREAKUP, LANDING (CONT)

SIGNAL		MEANING	RESPONSE
DAY	NIGHT		
Division leader holds up and rotates two fingers in horizontal circle, preparatory to breaking off.		Section break off.	Wingman relays signal to section leader. Section leader nods (“I understand”) or waves good-by and executes.
Leader describes horizontal circle with forefinger.	Series of “I’s” in code, given by external lights.	Breakup (and rendezvous).	Wingman take lead, pass signal after leader breaks and follow.
Landing motion with open hand: 1. Followed by patting head. 2. Followed by pointing to another aircraft.		Refers to landing of aircraft, generally used in conjunction with another signal. 1. I am landing. 2. Directs indicated aircraft to land.	1. Nods. (“I understand”) or waves good-by. 2. Aircraft indicated repeats signal, blows a kiss and executes.
Open hand held vertically and moved forward or backward, palm in direction of movement.		Adjust wing position forward or aft.	Wingman moves in direction indicated.
Open hand held horizontally and moved slowly up or down, palm in direction of movement.		Adjust wing position up or down.	Wingman moves up or down as indicated.
Open hand used as if beckoning inboard or pushing outboard.		Adjust wing position laterally toward or away from leader.	Wingman moves in direction indicated.
Hand opened flat and palm down, simulating dive or climb.		I am going to dive or climb.	Prepare to execute.
Hand moved horizontally above glare shield, palm down.		Leveling off.	Prepare to execute.

Figure 26-1. Visual Communications (Sheet 4 of 9)

TAKEOFF, CHANGING LEAD, LEAVING FORMATION, BREAKUP, LANDING (CONT)

SIGNAL		MEANING	RESPONSE
DAY	NIGHT		
Two fingers pointed toward eyes (meaning IFF signals), followed by: 1. CUT 2. 3-digit numerals		1. Turn IFF to STANDBY. 2. Set mode and code indicated: first numeral-mode, second and third numerals-code.	Repeat then execute.
Head moved backward.		Slow down.	Execute.
Head moved forward.		Speed up.	Execute.
Headed nodded right or left.		I am turning right or left.	Prepare to execute.
Thumb waved backward over shoulder.	Series of 00s in code, given by external lights.	Take cruising formation or open up.	Execute.
1. Holds up right (or left) forearm vertically, with clenched fist or single wing-dip. 2. Same as above, except with pumping motion or double wing-dip.	1. Single letter R (or K) in code, given by external lights. 2. Series of RRs (or KKs) in code, given by external lights.	1. Wingman cross under to right (or left) echelon or in direction of wing-dips. 2. Section cross under to right (or left) echelon or in direction of wing-dips.	1. Execute. 2. Execute.
Triple wing-dip.	Series of VVs in code, given by external lights.	Division cross under. Form a Vee or balanced formation.	Execute. Execute.
Series of zooms.	Series of XXs in code, given by external lights.	Close up or join up; join up on me.	Execute.
Rocking of wings by leader.		Prepare to attack.	Execute preparation to attack.
Rocking of wings by any other member of flight.		We are being, or are about to be, attacked.	Stand by for and execute defensive maneuvers.
Lead plane swishes tail.		All aircraft in this formation form step-down column in tactical order behind column leader.	Execute. Leader speeds up slightly to facilitate formation of column.

Figure 26-1. Visual Communications (Sheet 5 of 9)

TAKEOFF, CHANGING LEAD, LEAVING FORMATION, BREAKUP, LANDING (CONT)

SIGNAL		MEANING	RESPONSE
DAY	NIGHT		
Shaking of ailerons. Head raised then lowered.	Long dash, given with external lights.	Execute signal; used as required in conjunction with another signal.	Execute last signal given.
Open and close four fingers and thumb.	Three dashes with external lights.	Extend or retract speed brake as appropriate.	Repeat signal. Execute upon head nod from leader or when leader's speed brake extends/retracts.
Rotary movement of clenched fist in cockpit as if cranking wheels, followed by head nod.	Two dashes with external lights.	Lower or raise landing gear and flaps, as appropriate.	Repeat signal. Execute when leader changes configuration.
Pointing index finger toward runway/ship in stabbing motion, repeatedly, followed by lead change signal.	One dash with external lights.	Landing runway or ball and ship in sight.	Ashore: Take position for landing. Carrier: Break off and land.
Raised fist with thumb extended in drinking position.		How much fuel have you?	Repeat signal, then indicate fuel in hundreds of pounds by finger-numbers.
Leader lowers hook.	Letter H in code, given by external lights.	Lower arresting hook.	Wingman lower arresting hook. Leader indicates wingman's hook is down with thumbs-up signal.
Open hand held up, fingers together, moved in fore-and-aft chopping motion (by leader).		Course to be steered is present compass heading.	Nod of head ("I understand").

ELECTRONIC COMMUNICATIONS AND NAVIGATION

SIGNAL		MEANING	RESPONSE
DAY	NIGHT		
Tap earphones, followed by patting of head, and point to other aircraft.		Take over communications.	Repeat signals, pointing to self, and assume communications lead.
Tap earphones, followed by patting of head.		I have taken over communications.	Nod ("I understand").

Figure 26-1. Visual Communications (Sheet 6 of 9)

ELECTRONIC COMMUNICATIONS AND NAVIGATION (CONT)

SIGNAL		MEANING	RESPONSE
DAY	NIGHT		
Tap earphones and indicate by finger-numerals, number of channel to which shifting.		Shift to channels indicated by numerals.	Repeat signal and execute.
Vertical hand, with fingers pointed ahead and moved in a horizontal sweeping motion with four fingers extended and separated.		What is bearing and distance to the TACAN station?	Wait signal, or give magnetic bearing and distance with finger-numerals. The first three numerals indicate magnetic and the last two or three, distance.

VISUAL EMERGENCY SIGNALS (AIR-TO-AIR)

SIGNAL		MEANING	RESPONSE
DAY	NIGHT		
Arms bent across forehead weeping.	Horizontal motion of flashlight shone at other aircraft.	General emergency signal meaning, I am in trouble.	Carry out squadron doctrine for escort of disabled aircraft.
Landing motion with open hand.	Circular motion of flashlight shone at other aircraft.	I must land immediately.	Assume lead if indicated and return to base or nearest suitable field.
Point to pilot and give series of thumbs down movements.	Flash series of dots with exterior lights.	Are you having difficulty?	Thumbs up: I am all right. Thumbs down: I am having trouble. Lights off once then on steady: I am all right. Lights flashing: I am having trouble.

Figure 26-1. Visual Communications (Sheet 7 of 9)

ARMAMENT

SIGNAL		MEANING	RESPONSE
DAY	NIGHT		
<p>1. Pistol-cocking motion with either hand.</p> <p>2. Followed by question-signal.</p> <p>3. Followed by thumbs-down signal.</p>		<p>1. Ready or safety guns.</p> <p>2. How much ammo do you have?</p> <p>3. I am unable to fire.</p>	<p>1. Repeat signal and execute.</p> <p>2. Thumbs up - "over half"; thumbs down - "less than half."</p> <p>3. Nod head ("I understand").</p>
<p>1. Shaking fist.</p> <p>2. Followed by question-signal.</p> <p>3. Followed by thumbs-down signal.</p>		<p>1. Arm or safety bombs, as applicable.</p> <p>2. How many bombs do I have?</p> <p>3. I am unable to drop.</p>	<p>1. Repeat signal and execute.</p> <p>2. Indicate with appropriate finger-numerals.</p> <p>3. Nod head ("I understand").</p>
<p>1. Shaking hand, with fingers extended downward.</p> <p>2. Followed by question-signal.</p> <p>3. Followed by thumbs-down signal.</p>		<p>1. Arm or safety missile/rockets as applicable.</p> <p>2. How many missiles/rockets do I have?</p> <p>3. I am unable to fire.</p>	<p>1. Repeat signal and execute.</p> <p>2. Indicate with appropriate finger-numerals.</p> <p>3. Nod head ("I understand").</p>
<p>Pistol cocking motion with either hand, followed by fore and aft pulling motion with a clenched fist.</p>	<p>1. Strobe light ON and OFF by lead aircraft.</p> <p>2. Strobe light turned ON for second time (allow time for setting up switches).</p>	<p>Jettison external stores.</p> <p>1. Set up your switches for jettison.</p> <p>2. You are cleared to drop.</p>	<p>Repeat signal and execute.</p> <p>1. Set up jettison/ordnance switches.</p> <p>2. Execute.</p>

Figure 26-1. Visual Communications (Sheet 8 of 9)

AIR REFUELING

SIGNAL		MEANING	RESPONSE
DAY	NIGHT		
<p>One finger turn-up signal.</p> <p>Form cone-shape with hand, all fingers extended aft (make signal close to canopy).</p> <p>1. Cone moved aft</p> <p>2. Cone moved forward</p>		<p>By receiver: start turbine.</p> <p>1. By receiver: extend drogue.</p> <p>2. By receiver: retract.</p>	<p>Tanker execute. Receiver gives thumbs-up when turbine starts.</p> <p>Tanker execute. Receiver give thumbs-up if:</p> <p>1. Drogue extends properly.</p> <p>2. Drogue retracts fully and air turbine feathers.</p>
<p>Make hand into cup-shape, then make repeated pouring motions.</p>		<p>By tanker: I am going to dump fuel.</p>	<p>By receiver: Nod. Give thumbs-up when fuel dumping commences.</p>
<p>Slashing motion of index finger across throat.</p>		<p>By tanker: I have stopped dumping fuel.</p>	<p>By receiver: Give thumbs-up if fuel dumping has ceased</p>

Figure 26-1. Visual Communications (Sheet 9 of 9)

CHAPTER 27

Deck/Ground Handling Signals

Communications between aircraft and ground personnel are visual whenever practical, operations permitting. The visual communications chapters of Aircraft Signals NATOPS Manual (NAVAIR 00-80T-113) should be reviewed and practiced by all flightcrew and ground crew personnel. For ease of reference, visual signals applicable to deck/ground handling are listed in figure 27-1. During night operations, wands shall be substituted for hand and finger movements.



ACKNOWLEDGEMENT

A CLENCHED FIST WITH THUMB POINTING STRAIGHT UP INDICATES SATISFACTORY COMPLETION OF A CHECK ITEM. A CLENCHED FIST WITH THUMB POINTING STRAIGHT DOWN INDICATES UNSATISFACTORY COMPLETION AND/OR DO NOT CONTINUE.

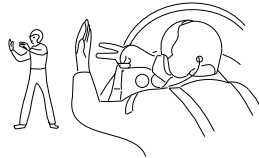

INSERT/PULL ELECTRICAL POWER

PILOT INSERTS/PULLS INDEX AND MIDDLE FINGER TO/FROM OPEN PALM. SIGNALMAN RESPONDS WITH SAME SIGNAL.

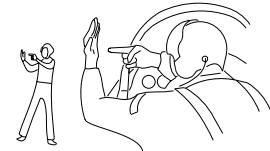

INSERT/PULL EXTERNAL AIR

PILOT INSERTS/PULLS INDEX FINGER TO/FROM OPEN PALM. SIGNALMAN RESPONDS WITH SAME SIGNAL.

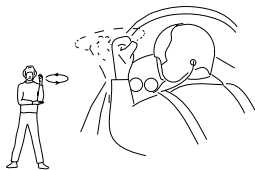

FCS IBIT/FCS EXERCISER/ FLIGHT CONTROLS WIPEOUT

PILOT MOVES CLENCHED FIST IN CIRCULAR MOTION IN VIEW OF SIGNALMAN. SIGNALMAN RESPONDS WITH SAME SIGNAL.



START APU/ENGINE

PILOT EXTENDS FINGERS TO INDICATE APU OR ENGINE IS READY FOR START. IF ALL CLEAR, SIGNALMAN RESPONDS WITH SIMILAR GESTURE POINTING AT APU EXHAUST OR PROPER ENGINE WHILE ROTATING OTHER HAND IN CLOCKWISE MOTION

- 3 FINGERS - APU
- 2 FINGERS - RIGHT ENGINE
- 1 FINGER - LEFT ENGINE



ENGINE RUN-UP

PILOT MOVES INDEX FINGER IN CIRCULAR MOTION INDICATING HE IS READY TO RUN UP ENGINE. SIGNALMAN RESPONDS WITH SIMILAR SIGNAL WHEN ALL CLEAR.



CHECK NOSE WHEELWELL DDI

PILOT MAKES T WITH HANDS AND POINTS TO NOSE.

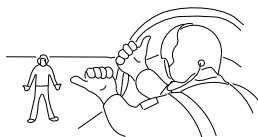

PULL CHOCKS

PILOT MAKES SWEEPING MOTION OF FISTS WITH THUMBS EXTENDED OUTWARD. SIGNALMAN SWEEPS FISTS APART AT HIP LEVEL WITH THUMBS EXTENDED OUTWARD.

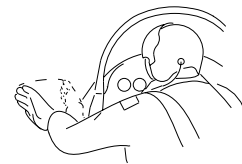

AM I CLEAR UNDERNEATH

WITH LEFT HAND OPEN, PALM OUT, PILOT MAKES SWEEPING MOTION ACROSS COCKPIT FROM RIGHT TO LEFT.



ARS RAT UNFEATHER CHECK

PILOT MAKES X WITH HANDS THEN WIGGLES THEM BACK AND FORTH.

Figure 27-1. Deck Ground Handling Signals (Sheet 1 of 4)



EFN520-332-2-005

Figure 21-1. Deck Ground Handling Signals (Sheet 2 of 4)



COME AHEAD

HANDS AT EYE LEVEL, EXECUTE MOTION: RATE OF MOTION INDICATES DESIRED SPEED OF AIRCRAFT. FOR NIGHT OPERATION, WAVE WANDS SIDE TO SIDE.



RIGHT TURN

PULL DESIRED WING AROUND WITH REGULAR "COME AHEAD". POINT AT OPPOSITE BRAKE.



LEFT TURN

PULL DESIRED WING AROUND WITH REGULAR "COME AHEAD". POINT AT OPPOSITE BRAKE.

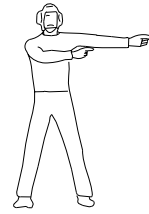

TURNOVER OF COMMAND

BOTH HANDS POINTED AT NEXT SUCCEEDING TAXI SIGNALMAN.



SLOW DOWN

DOWNWARD PATTING MOTION, HANDS OUT AT WAIST LEVEL



STOP

ARMS UPRAISED, FISTS CLENCHED AND HELD IN SIMPLE "POLICEMEN'S STOP".



EMERGENCY STOP

ARMS CROSSED ABOVE HEAD FISTS CLENCHED.



HOT BRAKES

MAKE RAPID FANNING MOTION WITH ONE HAND IN FRONT OF THE FACE. POINT TO WHEEL WITH OTHER HAND.

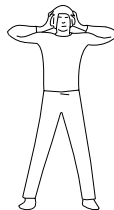

GROUND INTERCOM

CUP HANDS OVER EARS OR POINT WANDS TO EARS.



SET TAKEOFF TRIM

RAISE AND LOWER FULLY EXTENDED ARM

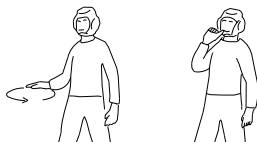

GROUND REFUELING ALL TANKS, NO EXTERNAL POWER

CIRCULAR MOTION PARALLEL TO THE HORIZON WITH ONE HAND EXTENDED FOLLOWED BY A DRINKING MOTION (THUMB TO MOUTH).



FINAL READY

TWO FINGERS IN CIRCULAR MOTION

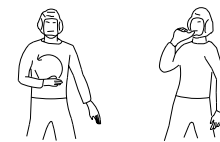

GROUND REFUELING INTERNAL TANKS NO EXTERNAL POWER

CIRCULAR MOTION WITH THE PALM OF HAND TOWARD STOMACH (AS RUBBING STOMACH) FOLLOWED BY A DRINKING MOTION (THUMB TO MOUTH).

Figure 27-1. Deck Ground Handling Signals (Sheet 3 of 4)



START APU

FROM A SQUATTING POSITION, POINTS TO APU EXHAUST WITH THREE FINGERS OF LEFT HAND. ROTATES THREE FINGERS OF RIGHT HAND IN A CLOCKWISE CIRCULAR MOTION.



START ENGINE

POINTS TO ENGINE #2 WITH LEFT HAND, ENGINE #1 WITH RIGHT HAND. EXTENDS FINGERS OF OTHER HAND TO INDICATE WHICH ENGINE TO START. ROTATES HAND IN CLOCKWISE CIRCULAR MOTION.

- 1 FINGER - LEFT ENGINE
- 2 FINGERS - RIGHT ENGINE



SECURE ENGINE/APU

EXTENDS FINGERS TO INDICATE WHICH ENGINE TO SECURE. POINTS TO ENGINE WITH LEFT HAND FOR APU OR ENGINE #2, RIGHT HAND FOR ENGINE #1. OTHER HAND MAKES THROAT CUTTING SIGNAL.

- 1 FINGER - LEFT ENGINE
- 2 FINGERS - RIGHT ENGINE
- 3 FINGERS - APU



WINDMILL ENGINE

EXTEND FINGERS TO INDICATE WHICH ENGINE IS BEING ROTATED. POINTS TO APU OR ENGINE #2 WITH LEFT HAND, ENGINE #1 WITH RIGHT HAND. OTHER HAND MAKES LARGE CIRCULAR MOTION.



ENGINE FIRE

DESCRIBE A LARGE FIGURE EIGHT WITH ONE HAND AND POINT TO THE FIRE AREA WITH THE OTHER HAND.



FLAPS FULL

HANDS FLAT TOGETHER, THEN OPENED WIDE FROM WRISTS. ARM IN CLOSE TO BODY.

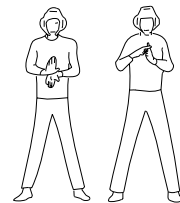

FLAPS HALF

FLAPS FULL SIGNAL FOLLOWED BY CROSSED INDEX FINGERS.



FLAPS AUTO

HANDS, OPENED, WIDE FROM WRIST, SUDDENLY CLOSED, ARMS IN CLOSE TO BODY.



AOA PROBE/PITOT PROBE HEAT CHECK

EXTEND TWO FINGERS OF LEFT HAND AND GRAB EXTENDED FINGERS WITH RIGHT HAND.

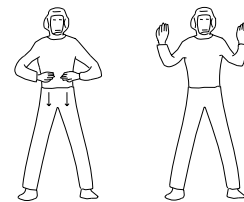

FINAL CHECK

DOWNWARD BRUSHING MOTION OF THE CHEST WITH BOTH HANDS FOLLOWED BY HANDS OUT OF COCKPIT SIGNAL

NIGHT SIGNALS

NIGHT SIGNALS ARE THE SAME AS DAY SIGNALS EXCEPT NO FINGERS ARE SHOWN WITH REGARDS TO ENGINE. FLASHLIGHTS OR WANDS ARE USED TO INDICATE HAND MOTIONS.

DECK PERSONNEL COLOR CODING

REFER TO CV NATOPS MANUAL

Figure 27-1. Deck Ground Handling Signals (Sheet 4 of 4)

EFN520-332-4-005

PART VIII

WEAPONS SYSTEMS

Refer to Tactical Manuals (A1-F18EA-TAC-series) for information on weapons systems.

PART IX

FLIGHT CREW COORDINATION

Chapter 28 - Aircrew Coordination

Chapter 29 - Crew Coordination Standards

CHAPTER 28

Aircrew Coordination

28.1 DEFINITION

Aircrew coordination is the use and integration of all available skills and resources to collectively achieve and maintain flight efficiency, situational awareness, and mission effectiveness.

28.2 CRITICAL SKILLS OF AIRCREW COORDINATION

28.2.1 Situation Awareness. The degree of accuracy by which one's perception of the current environment mirrors reality. It is the ability to identify the source and nature of problems, extract and interpret essential information, maintain an accurate perception of the external environment, and detect a situation requiring action. Mission accomplishment depends on the level of situational awareness of all members of the flight and of outside agencies.

28.2.2 Assertiveness. An individual's willingness to actively participate, state, and maintain a position until convinced by the facts that the other options are better.

28.2.3 Decision-Making. The ability to choose a course of action using logical and sound judgement based on available information. Effective decision making requires assessing the situation, verifying information, identifying solutions, anticipating the consequences of decisions, making the decision, informing others of the decisions and rationale, and evaluating the decision. Good decisions optimize risk management and minimize errors. Poor decisions can increase errors, lead to mission failure, and are a leading cause of mishaps.

28.2.4 Communication. The ability to clearly and accurately send and acknowledge information, instructions, or commands and provide useful feedback. Effective aircrew communication skills ensure timely transfer and assimilation of accurate information and provide useful feedback. Open, professional communication that avoids defensiveness and encourages accurate understanding of the intended message is critical to information flow in the flight. Aviators should be aware of the basic sociological, psychological, and environmental barriers to communications, and attempt to overcome them.

28.2.5 Leadership. The ability to direct and coordinate the activities of other crewmembers or wingmen, and to stimulate the flight to work together as a team. The ultimate responsibility for safety of flight rests with the aircraft commander/pilot in command; however, every crewmember has a responsibility for safety of flight, compliance with NATOPS and SOP, and mission accomplishment. Within the chain of command each crewmember must exercise vigilance and support the aircraft commander with timely recommendations and back up as directed.

28.2.6 Adaptability/Flexibility. The ability to alter a course of action based on new information, maintain constructive behavior pressure, and adapt to internal and external environment changes. The critical aspects are anticipating problems, recognizing and acknowledging any changes or abnormalities, taking alternative actions, providing and asking for assistance, and interacting constructively with flight members. The success of a mission depends on the ability to alter behavior and dramatically manage flight resources to meet situational demands.

28.2.7 Mission Analysis. The ability to develop short-term, long-term, and contingency plans; and to coordinate, allocate, and monitor crew and aircraft resources. Effective planning leads to flight conduct that removes uncertainty, increases mission effectiveness, and enhances safety.

28.2.8 Factors That Degrade Aircrew Coordination.

1. Fixation on one task to the detriment of others.
2. Confusion.
3. Violation of NATOPS/FLIGHT minimums.
4. Violation of SOP.
5. No one in charge.
6. No lookout doctrine.
7. Failure to meet mission/planning milestones.
8. Absence of communication.

28.3 FLIGHT MEMBER POSITIONS

28.3.1 Mission Commander. The mission commander shall be a qualified naval aviator or naval flight officer designated by appropriate authority. The mission commander shall be responsible for all phases of the assigned mission except those aspects of safety-of-flight which relate to the physical control of aircraft and within the prerogatives of the pilot in command. In accomplishing this, the mission commander may exercise command over a single naval aircraft or formations of naval aircraft. The mission commander shall direct a coordinated plan of action and be responsible for effectiveness of the mission. Mission commander responsibilities include, but are not limited to:

1. Allocation of assets.
2. Supervision and allocation of planning tasks.
3. Assessment of capabilities and limitations of the flight.
4. Establishment of go/no-go criteria.
5. Assignment of roles and responsibilities.
6. Assurance of compliance with applicable orders, directives, and ROE/ROC.

28.3.2 Pilot In Command. The pilot in command is the pilot of an individual aircraft. The pilot in command is responsible for the safe, orderly flight of the aircraft and the well-being of the crew. In the absence of direct orders from higher authority cognizant of the mission, responsibility for starting or continuing a mission with regard to weather or any other condition affecting the safety of the aircraft rests with the pilot in command. The pilot in command may also be mission commander or formation leader when so designated.

28.3.3 Formation Leader. A formation of one or more naval aircraft shall be under the direction of a formation leader who is authorized to pilot naval aircraft. The formation leader is responsible for the

safe and orderly conduct of the formation. The status of each member of the formation shall be clearly briefed and understood prior to takeoff. The formation leader may also be the mission commander when so designated.

28.3.4 Weapon Systems Operator (WSO). The WSO is directly involved in all operations and weapon systems employment of the F/A-18F aircraft except actual control of the aircraft. The WSO integrates with the pilot to collectively achieve and maintain crew efficiency, situational awareness, and mission effectiveness. When designated as mission commander, the WSO is also responsible for all phases of the assigned mission.

28.4 AIRCREW RESPONSIBILITIES BY FLIGHT PHASE

28.4.1 Mission Planning and Briefing. All members of the flight should be involved in the mission planning process and must be familiar with the mission requirements prior to the brief. The flight brief shall be conducted with all members of the flight present. Any supporting assets (such as GCI, fighter escort, EW, etc.) shall be briefed face-to-face, if possible. Flights requiring special coordination or control should also be briefed face-to-face. Each type of flight or phase of flight may require unique briefing requirements.

28.4.2 Pretakeoff. Aircraft discrepancy book (ADB) review, preflight, prestart, and poststart evolutions are conducted individually with the aid of ground maintenance crews (plane captains, trouble shooters, ordnance handlers, etc.). Timing must be considered when coordinating operations with other activities. Marshalling and taxi as a flight should be in order with special emphasis on FOD avoidance. A minimum taxi interval should be emphasized for FOD considerations. During section taxi the wingman should not focus on other tasks or get behind.

28.4.3 Takeoff/Departure. The following should be considered and briefed when conducting a formation takeoff in addition to the typical takeoff considerations such as gross weight, performance, and abort capability:

- Interval for FOD avoidance
- Staggered line-up for abort
- Crosswind handling characteristics
- Jet exhaust/turbulence patterns
- Abort criteria and configuration changes prior to IMC
- Wingman positioning
- Airspeed
- Runway length/conditions
- Abort speed/procedures

Departure procedures are dependent upon weather and mission requirements.

The following are some considerations that may require crew coordination:

- Clearance compliance
- Climb schedule and interval of multi-plane formations
- Weather avoidance or penetration
- Individual departure to join on top

28.4.4 Enroute. Enroute procedures may differ greatly depending on mission requirements.

28.4.5 Recovery. Egress, approach, and landing operations are numerous and dependent upon mission objectives, weather, and types of landing. The following elements should be considered and may require aircrew coordination:

- Navigation and communication systems management
- Course rules and re-entry procedures
- Approach and landing weather
- Landing type and capabilities (e.g., gross weight, crosswind limitations, asymmetry limitations, etc.)
- Fuel for normal and alternate recoveries
- Formation size and composition based upon maneuverability and landing area congestion
- Instrument recovery/penetration procedures (single aircraft and/or formation)
- Power and maneuvering margins for wing men
- Jet wash and turbulence avoidance
- Terminal control/LSO procedures
- Landing interval and priorities
- FOD avoidance during landing and taxi
- De-arming procedures

28.4.6 Mission Critique. Mission assessment is critical following a flight whether the mission was a multi-aircraft strike, an FCLP period, or a functional check flight. A critical and credible debrief of mission effectiveness improves future mission success and enhances aircrew and supporting agency coordination. A proper debrief should provide flight members and supporting agencies with information on strengths and weaknesses so that future training and mission planning can focus on problem areas and exploitation of strong areas.

28.5 SPECIAL CONSIDERATIONS

28.5.1 Functional Checkflights. All requirements for functional checkflights are listed in OPNAVINST 4790.2 (Series) and are to be performed using the applicable functional check flight checklist. Crew coordination shall be in accordance with standard NATOPS procedures and apply during the entire checkflight. F/A-18 NATOPS Chapter 10 outlines checks to establish acceptance standards for the systems peculiar to the F/A-18E/F aircraft. All instrument and indicator readings, warning lights, and radar and navigation displays in the rear cockpit shall be compared throughout the flight with the corresponding information available from the front cockpit. Close crew coordination ensures proper and correct utilization of all functional check flight procedures.

28.5.2 Formation Flights. Formation flights involving two or more aircraft require a high degree of crew coordination to ensure mission accomplishment and to reduce mid-air collision potential.

28.6 EMERGENCIES

Mission planning and briefing should address contingencies which may affect the flight. Proper planning minimizes the effect of deviations from the planned mission. The possibility of a mission abort, or even the loss of an aircraft or aircrew, can be significantly reduced by anticipating critical phases of flight and preparing for potential emergency situations. An example is the thorough brief of bird strike emergencies and divert fields along a low-level navigation route. Part V contains procedures to correct an abnormal or emergency condition. Modify these procedures as required in cases of multiple emergencies, adverse weather, or other peculiar factors. Use common sense and sound judgement to determine the correct course of action.

CHAPTER 29

Crew Coordination Standards

29.1 PHILOSOPHY

F/A-18F crews tactically employ the aircraft utilizing community-wide standards for task-assignment and crew coordination. The F/A-18F community's disciplined and standardized approach to crew coordination enables any combination of pilot and WSO to benefit from life-saving, individual habit patterns while implementing a time-tested system of checks and balances.

Crews must approach F/A-18F employment with an understanding that mission accomplishment depends upon effective crew coordination and that crew coordination is an obligation equally shared. The pilot is responsible for safety of flight, formation keeping, threat awareness, and weapons employment. The WSO is responsible for avionics, weapons and sensors interface, communication, and copilot duties. The most effective crews will complete their individual assignments while monitoring the progress of the mission as a whole.

What follows are the crew coordination standards for administrative phases of flight. The information contained herein is not meant to be used as a checklist, but should serve as a guide for ensuring the aircrew work together effectively as a team. For tactical crew coordination standards, refer to the Strike Fighter Squadron One Two Two Crew Coordination Standardization Manual.

29.2 MISSION PLANNING

Pilots and WSOs share mission planning responsibilities as delegated by the mission commander.

29.3 CREW BRIEFING

Individual crews shall discuss mission related coordination points and review relevant crew coordination standards before each flight.

29.4 COMMUNICATIONS

Pilot

1. Make administrative inter-flight communications to include dressing the formation, fuel and g checks, and configuration changes.

WSO

1. Change radio frequencies as required.
2. Perform all other non-administrative, inter-flight communications.

29.4.1 Intra-Cockpit Communications (ICS). Crews will strive to fly with minimal ICS communication. Following crew coordination standards and using standard F/A-18F terminology and guidelines minimizes ICS requirements and builds situational awareness.

29.4.2 Guidelines for Effective Communications.

- ICS communication regarding aircraft/aircrew survivability has priority over all other communications (ICS or radio).
- Use ICS Standard Communication Brevity Terms, delineated in paragraph 29.9, to minimize and standardize ICS communication.
- Adjust ICS volumes and VOX sensitivities throughout flight so that administrative communications and tactical communications/tone (weapon/RWR) are appropriately balanced.
- Do not communicate via ICS over incoming or outgoing radio transmissions unless a safety of flight or time-critical mission situation exists.
- Time ICS communications to allow the flight to gain/maintain SA via radio transmissions.
- Lead with directive communication and follow-up with descriptive communication.
- Limit descriptive communication during critical flight phases.
- Communicate visual acquisitions and lost sight situations ASAP.
- Communicate information pertinent to the entire flight via radio communications.
- Either aircrew may change the Master Mode, Bingo bug, or RALT setting, but must alert the other crewmember of the change via ICS. Changes to navigation system by either crewmember should also be enunciated.

29.5 PRE-FLIGHT

Pilots and WSOs shall both read the Aircraft Data Book. The pilot in command signs for the aircraft.

Whenever possible the crew will walk together to the aircraft. Both the pilot and WSO shall account for the aircraft pins and verify the VDEDP codes are correct. After the VDEDP codes are verified, the pilot and WSO will split apart to conduct individual pre-flight inspections in accordance with Chapter 7. The pilot will walk clockwise around the aircraft while the WSO will walk counter-clockwise. Notify the other crewmember, as well as maintenance personnel, of any discrepancies found during the inspection. Both the pilot and WSO shall verify all panels are closed before manning the aircraft.

29.6 FLIGHT PHASES

General

1. Both aircrew are responsible for maintaining lookout doctrine, to include terrain clearance, at all times.

29.6.1 Start/Taxi/Takeoff.

Pilot

1. Perform all checks in accordance with Chapter 7.
2. Report "rolling", "saluting", or "lights on", as appropriate during CV operations, to WSO.

WSO

1. Perform all checks in accordance with Chapter 7.
2. Monitor engine instruments, airspeed, and runway remaining.

29.6.2 Departure.**Pilot**

1. Relay engine instrument readings to the WSO.
2. Advise the WSO of any abnormal aircraft issues or events.
3. Confirm assigned headings and altitudes with the WSO, if required.
4. Maintain proper lookout doctrine.

WSO

1. Copy and acknowledge all clearances.
2. Provide a departure brief after completing takeoff checks, but before taking the runway. Departure brief will include departure and transition name, runway, departure heading, initial altitude restriction, the first turn, and navigation system setup. If the first turn is an arc, add the arc distance. After takeoff, the WSO shall update the pilot on the SID staying one step ahead so that the pilot is neither getting too much information at once nor feels the need to reference the approach plate.
3. During section takeoff, check engine instruments/aircraft status if in wing aircraft and monitor the wingman's airplane/position if in the lead aircraft.
4. Monitor airspeed and runway remaining.
5. Monitor instruments.
6. Maintain proper lookout doctrine.
7. Monitor the published or clearance departure procedures and alert the pilot to any significant deviations from the prescribed heading, airspeed, or altitude.

29.6.3 Rendezvous and Formation.**Pilot**

1. Execute rendezvous.

WSO

1. Crosscheck the pilot on rendezvous mechanics (airspeed, angle of bank, altitude, closure rate, relative bearing, and altitude separation).

29.6.4 Cruise.**Pilot**

1. Maintain situational awareness of geographical position relative to divert fields.
2. Monitor fuel status, navigation systems, and frequencies assigned.
3. If experiencing vertigo/disorientation, notify the WSO immediately.

WSO

1. Maintain proper lookout doctrine.
2. Maintain an instrument scan.
3. Maintain navigation system.
4. Maintain situational awareness of geographical position relative to divert airfields along the route of flight, winds at operating altitude, and bingo profile altitude.
5. Copy all clearances and acknowledge all heading/altitude changes.
6. Monitor fuel status.
7. If the pilot experiences vertigo/disorientation, carefully monitor instruments/HUD video and inform pilot of attitude, altitude, and airspeed as required. Be prepared to direct the pilot how to maneuver the aircraft back to a wings-level attitude.

29.6.5 Inflight Refueling.**Pilot**

1. Complete the air-refueling checklist in accordance with Chapter 9.
2. Ensure the amber light is visible before commencing approach.
3. Notify WSO of the position of the fuel switches prior to and after tanking.
4. After disengagement, stay behind the drogue until all members of the flight are sighted.
5. Complete the post-refueling checklist.

WSO

1. Acquire the tanker with aircraft sensors and visually.
2. Monitor azimuth, range, and closure during rendezvous.
3. Visually clear the immediate airspace around the tanker prior to maneuvering into pre-contact position and prior to maneuvering from behind tanker when tanking is complete.
4. Monitor closure and advise the pilot if an unsafe condition is developing.

5. Make required voice reports as briefed.
6. Count up every 1000 pounds of fuel over the ICS and report to pilot when fuel transfer is complete.
7. Advise the pilot of unusual fuel spillage or unsafe probe/drogue conditions.
8. Verify status of fuel switches with pilot.

29.6.6 Approach.

Pilot

1. Determine as a crew the type of approach desired with respect to existing weather.
2. Complete the descent/instrument penetration checklist.
3. Monitor UHF communication conducted by the WSO.
4. When executing a CCA, conform to procedures contained in this manual, CV NATOPS manual, and approach control's instructions.
5. Confirm headings and altitudes with the WSO as required.
6. Advise the WSO if the fuel dump switch has been activated/deactivated.
7. Advise the WSO if experiencing vertigo/disorientation.

WSO

1. Determine as a crew the type of approach desired with respect to existing weather.
2. Verify the descent/instrument penetration checklist complete.
3. Whenever flying to an unfamiliar field, WSOs will give the pilot a field brief. Field briefs will include field elevation, runway description, approach lighting, TACAN location, arresting gear, and minimum safe altitude.
4. Alert the pilot to significant deviations from published/assigned course or altitude.
5. Maintain situational awareness to the ship's/field position relative to bingo fuel.
6. Decrement the HSI range scales at approximately 20 and 10 nautical miles and set course line to appropriate runway heading.
7. Aid in planning holding/marshall entry and pattern timing.
8. Monitor altitude, attitude, and airspeed during holding, penetration, and approach.

9. Provide a timely approach brief as described in figure 29-1.

Approach Type	Approach Brief	Missed Approach
Precision (Prior to enroute descent)	Airfield name, runway, final approach course, and decision height.	Give the initial heading, altitude restriction, and first turn.
Non-Precision (Prior to the initial approach fix)	Airfield name, approach name, runway, initial approach fix, initial heading, and initial altitude restriction.	Update missed approach instructions staying one step ahead thereafter.
Visual (Prior to the initial point)	VFR course rules.	

Figure 29-1. Approach Briefs

10. Monitor the appropriate approach plate and advise pilot of required heading and altitude changes as prescribed by the approach.

11. Report to the pilot during penetration and/or descents through each 5000 feet of altitude above 5000 feet AGL and each 1000 feet below 5000 feet AGL, until reaching the desired altitude.

12. Monitor the fuel quantity when dumping.

13. Be prepared to talk down the pilot through distance/altitude checkpoints when executing a CCA utilizing radar, TACAN, and INS/GPS (i.e., during a self-contained emergency approach).

14. Inform the pilot when changing radio, TACAN, or IFF.

29.6.7 Landing.

Pilot

1. Perform the landing checklist in accordance with Chapter 7.

WSO

1. Monitor traffic pattern entry altitude and airspeed as prescribed by local course rules or CV NATOPS Manual, while maintaining a proper lookout doctrine and assisting the pilot in determining the interval.

2. Verify landing checklist completion in accordance with Chapter 7.

3. Calculate on-speed.

4. Make UHF transmissions.

5. Be alert for, and report traffic to the pilot.

6. On roll-out be prepared to advise of arresting gear location (field landing).
7. Report to the pilot airspeed in conjunction with runway remaining if prudent to do so.

29.6.8 Post Flight.

Pilot

1. Perform post flight checks in accordance with Chapter 7.
2. Download AMU/maintenance card.

WSO

1. Perform post flight checks in accordance with Chapter 7.
2. Advise pilot when ready for shutdown.
3. Complete NALCOMIS.

29.7 DEBRIEFING

Mission Commander

1. Conduct a thorough debrief to include specific comments on errors and techniques, and review procedures for correcting/improving them.

Formation Leader/Mission Commander

1. Conduct a thorough flight debrief.

29.8 SPECIAL CONSIDERATIONS

29.8.1 Functional Check Flights

PMCF aircraft demand closer scrutiny than normal during aircraft discrepancy book screening, preflight, flight, and postflight maintenance debriefing. During the flight brief, the PMCF aircrew should give special attention to briefing those malfunctions or emergencies that are more likely to occur as a result of a maintenance action taken.

29.8.2 Emergencies.

The primary responsibility of the aircrew during the resolution of an aircraft malfunction or emergency is to fly the aircraft safely. During an emergency, the assistance of the WSO is of the utmost value. After backing up the pilot on completion of NATOPS boldface procedures, the WSO should review the appropriate emergency checklist with the pilot while monitoring the flight performance of the aircraft. It is recommended a challenge-reply format be used for working through the checklist and it is important the WSO set a pace that ensures no steps are missed.

Pilot

1. Maintain safe control of the aircraft.
2. Perform the boldface procedures.

3. Perform emergency procedures as challenged by the WSO.
4. Ensure aircraft is properly configured for emergency landing (if applicable).

WSO

1. Monitor flight performance.
2. Initiate challenge and reply procedures utilizing PCL. (Review all boldface procedures to ensure appropriate actions are complete.)
3. Summarize Notes, Warnings, and Cautions that apply to the emergency.
4. Configure navigation system for emergency divert, as applicable.
5. Coordinate with air traffic controllers as required.

29.9 STANDARD ICS TERMS

Refer to figure 29-2 for standard ICS terms.

Terms	Action(s)
"FIRE TEST"	PILOT IS INITIATING THE FIRE TEST SWITCH. EXPECT TO SEE FIRE/APU/BLEED LIGHTS WITH VOICE, TWICE.
"GOOD WAYPOINT 0"	IMPLIES GOOD WAYPOINT 0 AND MAGVAR. USED WHEN NOT USING THE WAYPOINT 0 LOADED ON THE MU. SHORE OPS ONLY.
"CANOPY"	PILOT CALL BEFORE RAISING OR LOWERING THE CANOPY. LISTEN FOR "CLEAR" OR "STANDBY" FROM WSO.
"FOUR DOWN"	PILOT IS ACCOMPLISHING THE FOUR DOWN PORTION OF NATOPS CHECKS. HANDS ABOVE THE CANOPY RAIL IF IN F(T).
"MOVING"	PILOT INFORMATIVE CALL THAT THE AIRCRAFT IS TAXIING.
"ORDIES"	BOTH AIRCREW HANDS UP FOR WEAPON ARMING.

Figure 29-2. Standard ICS Terms (Sheet 1 of 3)

Terms	Action(s)
"FENCE COMPLETE", "FENCE COMPLETE, EXCEPT _"	INFORMATIVE THAT ALL THE AIRCREW'S SYSTEMS ARE SET ACCORDING TO STAN/BRIEF. IMPLIES READY FOR TAXI. NORMALLY WSO REPORTS FIRST AFTER DOUBLE CHECKING THE EW SUITE IF REQUIRED.
"WINGS"	PILOT CALL BEFORE SPREADING OR FOLDING WINGS. LISTEN FOR "CLEAR" OR "STANDBY" FROM WSO.
"SEATS"	CALL TO EITHER SAFE OR ARM EJECTION SEATS. FOR BOTH SAFING AND ARMING THE SEATS, WHOEVER INITIATES THE CALL, THE OTHER AIRCREW MUST REPORT SAFE OR ARMED FIRST.
"GOING FLYING"	PILOT CALL AT BRIEFED MAX ABORT SPEED ON TAKEOFF ROLL.
"CONTINUE, (CAUTION)"	TAKEOFF ROLL CAUTION. WSO CALL AND OPINION TO CONTINUE. Ex: "CONTINUE, MU LOAD"
"ABORT"	ABORT TAKEOFF, DIVE, ETC.
"CODES CHECKED"	WSO CALL THAT BOAS, BITS, MSP'S, AND FLIR CODES CHECKED.
"GOOD UPDATE"	INS IS UPDATED.
"READY FOR SHUTDOWN"	INFORMATIVE CALL FROM WSO THAT ALL ELECTRICAL EQUIPMENT IS OFF.
"SHUTTING DOWN"	INFORMATIVE CALL FROM PILOT THAT THE LAST MOTOR IS BEING SHUT DOWN.
"COUPLED (WAYPOINT, TACAN SEQUENCE)"	PILOT INFORMATIVE CALL THAT THE AIRCRAFT AUTOPILOT IS COUPLED TO WHAT IS MENTIONED. Note: Also shows on the advisories.
"UNCOUPLE(D) (WAYPOINT, TACAN, SEQUENCE)"	DIRECTIVE TO UNCOUPLE OR INFORMATIVE THAT THE AIRCRAFT IS UNCOUPLED FROM THE AUTOPILOT.

Figure 29-2. Standard ICS Terms (Sheet 2)

Terms	Action(s)
"YOUR (SENSOR, AVIONICS, MENU, ETC.)"	DIRECTIVE FOR OTHER AIRCREW TO OPERATE THE SPECIFIED DISPLAY/SENSOR. INITIATING AIRCREW IS RELINQUISHING CONTROL. Ex: "YOUR RADAR", "YOUR TDC", "YOUR HSI"
"MY (SENSOR, AVIONICS, MENU, ETC.)"	I AM OPERATING THE SPECIFIED DISPLAY/SENSOR. Ex: "MY RADAR", "MY FLIR", "MY HSI"
"CHECK (SENSOR, AVIONICS, MENU, ETC.)"	PIMP OTHER AIRCREW TO CHECK WHAT IS SPECIFIED. Ex: "CHECK AZ/EL", "CHECK ALE-47 PROGRAM", "CHECK ALTITUDE"
"SET (SENSOR, AVIONICS, MENU, ETC.) ____"	DIRECTIVE FOR OTHER AIRCREW TO SET WHAT IS SPECIFIED. Ex: "SET RADALT 450", "SET 35 ALPHA"
"(SENSOR, AVIONICS, MENU, ETC.) SET ____"	INFORMATIVE TO OTHER AIRCREW. Ex: "RADALT SET 450", "BINGO SET 3.5", "STORES SET", "ALTIMETER SET 2992", "EW SUITE SET" Note: Mandatory ICS calls when changing Bingo, Radalt, or Altimeter.
"CYCLE (WEAPON, AVIONICS, ETC.)"	DIRECTIVE TO CYCLE OFF AND ON WHAT IS REQUESTED. Ex: "CYCLE TACAN"
"GO (RADAR MODE, WEAPON, MASTER MODE, ETC.)"	DIRECTIVE FOR OTHER AIRCREW TO SELECT WHAT IS REQUESTED. Ex: "GO WINDER", "GO WACQ", "GO AIR TO GROUND"
"GOING (RADAR MODE, WEAPON, MASTER MODE, ETC.)"	INFORMATIVE THAT THE AIRCREW IS SELECTING WHAT IS STATED AFTER A SHORT PAUSE FOR OBJECTIONS. Ex: "GOING WACQ", "GOING AIR TO GROUND" Note: Mandatory ICS call before changing Master Modes

Figure 29-2. Standard ICS Terms (Sheet 3)

PART X

NATOPS EVALUATION

Chapter 30 - NATOPS Evaluation

CHAPTER 30

NATOPS Evaluation

30.1 CONCEPT

The standard operating procedures prescribed in this manual represent the optimum method of operating the F/A-18 aircraft. The NATOPS Evaluation is intended to evaluate compliance with NATOPS procedures by observing and grading individuals and units. This evaluation is tailored for compatibility with various operational commitments and missions of both Navy and Marine Corps units. The prime objective of the NATOPS Evaluation program is to assist the unit commanding officer in improving unit readiness and safety through constructive comment. Maximum benefit from the NATOPS Program is achieved only through the vigorous support of the program by commanding officers as well as flight crewmembers.

30.1.1 Implementation. The NATOPS Evaluation program shall be carried out in every unit operating naval aircraft. Pilots desiring to attain/retain qualification in the F/A-18 shall be evaluated initially in accordance with OPNAVINST 3710.7 series, and at least once during the twelve months following initial and subsequent evaluations. Individual and unit NATOPS Evaluations are conducted annually; however, instruction in and observation of adherence to NATOPS procedures must be on a daily basis within each unit to obtain maximum benefits from the program. The NATOPS Coordinators, Evaluators, and Instructors shall administer the program as outlined in OPNAVINST 3710.7 series. Evaluatees who receive a grade of Unqualified on a ground or flight evaluation shall be allowed 30 days in which to complete a reevaluation. A maximum of 60 days may elapse between the date the initial ground evaluation was commenced and the date the flight evaluation is satisfactorily completed.

30.1.2 Definitions. The following terms, used throughout this section, are defined as to their specific meaning within the NATOPS program.

30.1.2.1 NATOPS Evaluation. A periodic evaluation of individual flight crewmember standardization consisting of an open book examination, a closed book examination, an oral examination, and a flight evaluation.

30.1.2.2 NATOPS Reevaluation. A partial NATOPS Evaluation administered to a flight crewmember who has been placed in an Unqualified status by receiving an Unqualified grade for any of his ground examinations or the flight evaluations. Only those areas in which an unsatisfactory level was noted need be observed during a reevaluation.

30.1.2.3 Qualified. A qualified evaluation means that a flight crewmember is well standardized and demonstrates highly professional knowledge of and compliance with NATOPS standards and procedures. Momentary deviations from or minor omission in non-critical areas are permitted if prompt and timely remedial action is initiated by the evaluatee.

30.1.2.4 Conditionally Qualified. A conditionally qualified evaluation means that a flight crewmember is satisfactorily standardized. One or more significant deviations from NATOPS standards and procedures, but had no errors in critical areas and no errors jeopardizing mission accomplishment or flight safety.

30.1.2.5 Unqualified. An unqualified evaluation means that a flight crewmember is not acceptably standardized and fails to meet minimum standards regarding knowledge of and/or ability to apply NATOPS procedures, one or more significant deviations from NATOPS standards and procedures which could jeopardize mission accomplishment or flight safety.

30.1.2.6 Area. A performance area consisting of preflight, flight, or postflight.

30.1.2.7 Sub-area. A performance sub-division within an area, which is observed and evaluated during an evaluation flight.

30.1.2.8 Critical Area/Sub-area. Any area or sub-area which covers items of significant importance to the overall mission requirements, the marginal performance of which would jeopardize safe conduct of the flight.

30.1.2.9 Emergency. An aircraft component, system failure, or condition which requires instantaneous recognition, analysis, and proper action.

30.1.2.10 Malfunction. An aircraft component or system failure or condition which requires recognition and analysis, but which permits more deliberate action than that required for an emergency.

30.2 GROUND EVALUATION

30.2.1 General. Prior to commencing the flight evaluation, an evaluatee must achieve a minimum grade of Qualified on the open book and closed book examinations. The oral examination is also part of the ground evaluation but may be conducted as part of the flight evaluation. To assure a degree of standardization between units, the NATOPS instructors may use the bank of questions contained in this section in preparing portions of the written examinations.

30.2.1.1 Open Book Examination. The open book examination shall consist of, but not be limited to, the question bank. The purpose of the open book examination portion of the written examination is to evaluate the knowledge of appropriate publications and of the aircraft.

30.2.1.2 Closed Book Examination. The closed book examination may be taken from, but not limited to, the question bank and shall include questions concerning normal/emergency procedures and aircraft limitations. Questions designated critical shall be so marked.

30.2.1.3 Oral Examination. The questions may be taken from this manual and drawn from the experience of the Instructor/Evaluator. Questions should be direct and positive and should in no way be opinionated.

30.2.1.4 OFT/WST Procedures Evaluation. An OFT may be used to assist in measuring flight crewmember efficiency in the execution of normal operating procedures and reaction to emergencies and malfunctions. In areas not served by an OFT, this may be done by placing the flight crewmember in an aircraft and administering appropriate questions.

30.2.1.5 NAMT Systems Check. If desired by the individual squadron, Naval Air Maintenance Trainer facilities may be utilized to evaluate flight crewmember knowledge of aircraft systems and normal and emergency procedures.

30.2.1.6 Grading Instructions. Examination grades shall be computed on a 4.0 scale and converted to an adjective grade of Qualified or Unqualified.

30.2.1.6.1 Open Book Examination. To obtain a grade of Qualified, an evaluatee must obtain a minimum score of 3.5.

30.2.1.6.2 Closed Book Examination. To obtain a grade of Qualified, an evaluatee must obtain a minimum score of 3.3.

30.2.1.6.3 Oral Examination and OFT Procedure Check (If Conducted). A grade of Qualified or Unqualified shall be assigned by the Instructor/Evaluator.

30.3 FLIGHT EVALUATION

The flight evaluation should be conducted in an OFT but may be conducted on any routine syllabus flight with the exception of flights launched for FCLP/CARQUAL training. Emergencies shall not be simulated unless the flight is accomplished in an F/A-18F with a qualified IP in the rear seat.

The number of flights required to complete the flight evaluation should be kept to a minimum; normally one flight. The areas and sub-areas to be observed and graded on a flight evaluation are outlined in the grading criteria with critical areas marked by an asterisk (*). Sub-area grades shall be assigned in accordance with the grading criteria. These sub-areas shall be combined to arrive at the overall grade for the flight. Area grades, if desired, shall also be determined in this manner.

The areas and sub-areas in which flight crewmembers may be observed and graded for adherence to standardized operating procedures are outlined in the following paragraphs.

NOTE

- If desired, units with training missions may expand the flight evaluation to include evaluation of standardized training methods and techniques.
- The IFR portions of the Flight Evaluation shall be in accordance with the procedures outlined in the NATOPS Instrument Flight Manual.

30.3.1 Mission Planning/Briefing.

1. Flight Planning.
2. Briefing.
3. Personal Flying Equipment (*)

30.3.2 Preflight/Line Operations. Because preflight/line operations procedures are graded in detail during the ground evaluation, only those areas observed on the flight check shall be graded.

1. Aircraft Acceptance
2. Start
3. Before Taxiing Procedures

30.3.3 Taxi.**30.3.4 Takeoff (*).**

1. ATC (air traffic control) Clearance
2. Takeoff

30.3.5 Climb/Cruise.

1. Departure
2. Climb and Level-Off
3. Procedures Enroute

30.3.6 Approach/Landing (*).

1. Tacan, GCA, ILS/ACLS, Radar, ADF
2. Landing

30.3.7 Communications.

1. R/T Procedures
2. Visual Signals
3. IFF Procedures

30.3.8 Emergency/Malfunction Procedures (*). In this area, the flight crewmember shall be evaluated only in the case of actual emergencies, unless evaluation is conducted in the OFT/WST or F/A-18F.

30.3.9 Post Flight Procedures.

1. Taxi
2. Shutdown
3. Inspection and Records
4. Flight Debriefing

30.3.10 Mission Evaluation. This area includes missions covered in the NATOPS Flight Manual, F/A-18 Tactical Manual, and NWP NWIPs for which standardized procedures/techniques have been deployed.

30.3.11 Applicable Publications. The NATOPS Flight Manual contains the standard operations criteria for F/A-18 aircraft. Publications relating to environmental procedures peculiar to shorebased and shipboard operations and tactical missions are F/A-18 Tactical Manual, NWPs, NWIPs, ATC/CATCC Manual, Local Air Operations Manual, and Ship Air Operations Manual.

30.3.12 Flight Evaluation Grading Criteria. Only those sub-areas provided or required will be graded. The grades assigned for a sub-area shall be determined by comparing the degree of adherence to standard operating procedures with adjectival ratings listed below. Momentary deviations from standard operating procedures should not be considered as disqualifying provided such deviations do not jeopardize flight safety and the evaluatee applies prompt corrective action.

30.3.13 Flight Evaluation Grade Determination. The following procedure shall be used in determining the flight evaluation grade: A grade of Unqualified in any critical area/sub-area shall result in an overall grade of Unqualified for the flight. If not unqualified, flight evaluation (or area) grades shall be determined by assigning the following numerical equivalents to the adjective grade for each sub-area. Only the numerals 0, 2 or 4 shall be assigned in a sub-area. No interpolation is allowed.

Unqualified	0.0
Conditionally qualified	2.0
Qualified	4.0

The numerical grade is determined for each area and the overall grade for the flight, adding all the points assigned to the sub-areas and dividing this sum by the number of sub-areas graded. The adjective grade shall then be determined on the basis of the following scale.

Unqualified	0.0 to 2.19
Conditionally qualified	2.2 to 2.99
Qualified	3.0 to 4.0

EXAMPLE: (Add Sub-area numerical equivalents) $(4+2+4+2+4) \div 5 = 3.20$ Qualified

30.3.13.1 Final Grade Determination. The final NATOPS Evaluation grade shall be the same as the grade assigned to the flight evaluation. An evaluatee who receives an Unqualified on any ground examination or the flight evaluation shall be placed in an Unqualified status until achieving a grade of Conditionally Qualified or Qualified on a reevaluation.

30.3.13.2 Records and Reports. A NATOPS Evaluation Report (OPNAV Form 3510-8) shall be completed for each evaluation and forwarded to the evaluatee's commanding officer only. This report shall be permanently filed in the individual NATOPS Flight Personnel Training/Qualification jacket.

30.3.13.3 Critique. The critique is the terminal point in the NATOPS evaluation and shall be given by the Evaluator/Instructor administering the check. Preparation for the critique involves processing, reconstructing data collected, and oral presentation of the NATOPS Evaluation Report. Deviations from standard operating procedures shall be covered in detail using all collected data and worksheets as a guide. Upon completion of the critique, the flight crewmember receives the completed copy of the NATOPS Evaluation Report for certification and signature. The completed NATOPS Evaluation Report is then presented to the Unit Commanding Officer.

30.3.13.4 NATOPS Evaluation Question Bank. The following bank of questions is intended to assist the unit NATOPS Instructor/Evaluator in the preparation of ground examinations and to provide an abbreviated study guide. The questions from the bank may be combined with locally originated questions in the preparation of ground examinations. The closed book exam shall consist of no less than 50 questions. The time limit for the closed book exam is 1 hour and 30 minutes. The requirements for the open book exam are the same as those for the closed book exam, except there is no time limit.

30.4 NATOPS EVALUATION QUESTION BANK

1. What is the F/A-18E/F basic weight?
2. What is the takeoff gross weight (operating weight plus full internal fuel, ammo, 2 AIM-7s, 2 AIM-9s)?
3. What is military thrust of the F414-GE-400 engine?
4. What is afterburner thrust of the F414- GE-400 engine?
5. When will you get engine ignition?
 - a.
 - b.
 - c.
 - d.
6. True/False: Afterburner ignition is activated anytime main engine ignition is commanded.
7. How is a limited amount of fuel provided for negative G or inverted flight?
8. True/False: The F/A-18's IDLE rpm is the same on the ground as in flight.
9. Which one of the following caution and advisory displays will not activate the "engine left (right)" voice alert?
 - a. L or R OVRSPD
 - b. L or R EGT HIGH
 - c. L or R BOOST LO
 - d. L or R OIL PR
10. What are the modes of operation of the automatic throttle control (ATC)?
 - a.
 - b.
11. What conditions must be met to engage the approach mode of the automatic throttle control?
 - a.

12. What conditions must be met to engage the cruise mode of the automatic throttle control?
 - a.
 - b.
13. Which fuel tanks are transfer tanks?
 - a.
 - b.
 - c.
14. Which fuel tanks are feed tanks?
 - a.
 - b.
15. What does a TK PRES LO or TK PRES HI caution display on the DDI indicate?
 - a. On the ground -
 - b. Inflight -
16. Normal internal fuel is transferred using
17. External fuel is transferred by
18. True/False: With external tank control switch in stop transfer and hook handle down, fuel will transfer when FUEL LO caution display comes on.
19. What two fuel valves close when an engine fire light is pressed?
 - a.
 - b.
20. List four events which individually will cause fuel dump to stop.
 - a.
 - b.
 - c.
 - d.
21. True/False: The fuel low level indicating system is completely independent of the fuel quantity indicating system.

22. What fuel state illuminates the FUEL LO light, MASTER CAUTION light, and activates fuel low voice alert?
23. True/False: There is no voice alert associated with BINGO fuel.
24. Either AMAD may be driven pneumatically through an by the APU, opposite engine bleed air, or external air.
25. Each AMAD mechanically drives a,, and
26. True/False: Operation of APU is totally automatic after the APU switch is placed ON.
27. What provides electrical power for APU ignition and start control circuits?
28. What is used to start the APU?
29. True/False: If ATS caution is on when a DDI comes on, shut down the affected engine to avoid starter damage.
30. What is the cockpit warning of a single TR failure?
31. What is indicated by the BATT SW light coming on in the air with the battery switch on?
32. What seven circuit breakers are located in the cockpit?
33. True/False: The exterior lights master switch must be on for operation of the position and formation lights, but not for the strobe lights.
34. What failure(s) will illuminate the emergency instrument light and the BATT SW caution light?
35. The right or HYD system 2 provides power to.....
36. What are the primary flight controls?
37. What does pressing the T/O trim button in flight do?
38. What is the FCS reset button used for?
39. With the spin switch in NORM, when will the spin recovery mode be activated?
40. On takeoff, accelerating with the FLAP switch in HALF, at what speed will the flaps begin AUTO scheduling?
41. True/False: Once EMERG has been selected on FCS COOL switch, selection of NORM will switch FCC A and right TR cooling back to avionics air.
42. Rudder toe-in is a function of FLAP switch position and . . . with maximum toe-in being . . .
43. True/False: Stabilator position on the FCS status display on the DDI shows a (+) for trailing edge up (or nose up), and a (-) for trailing edge down (or nose down).

44. What occurs with gear handle UP, airspeed below 175 KCAS, altitude less than 7,500 feet, and rate of descent greater than 250 feet per minute?
- a.
 - b.
45. True/False: Pressing and holding the nosewheel steering button a second time will select the high mode ($\pm 75^\circ$) and NWS HI is displayed on the HUD.
46. True/False: The hook light remains on except when the hook is up and latched.
47. Normally, what kind of power is needed to fold or spread the wings?
48. Is it normal to have L PITOT HT and R PITOT HT advisories displayed on the DDI while on the ground with pitot heat switch in AUTO?
49. What will the standby attitude indicator be powered by if the right 115 volt ac bus fails?
50. The APU fire detection/extinguishing systems operates from power, provided the switch is ON.
51. The bleed air shutoff valves are closed when the fire and bleed air test switch is placed to TEST A and TEST B positions. How do you get the valves back open?
- a.
 - b.
52. True/False: The canopy can be jettisoned in the closed position only.
53. Why would you not pull the manual override handle in flight before ejection?
54. What conditions must be met to utilize the emergency jettison button?
- a.
 - b.
55. The switch must be in the position to use the selective jettison system.
56. What occurs when the unlighted MASTER CAUTION light is pressed?
57. True/False: For cautions with voice alert, the master caution tone comes on after the voice alert.
58. What two ways can you stop any BIT test in progress and return the equipment to normal operation?
- a.
 - b.

59. What two systems require additional switchology other than pressing the associated button when performing initiated BIT checks?
- a.
 - b.
60. How much has the fuel quantity in tank 1 been reduced in the F/A-18F aircraft?
61. True/False: The rear cockpit does not have an internal canopy switch or an internal manual canopy handcrank.
62. True/False: There are provisions for normal landing gear extension from the rear cockpit.
63. The leg restraint lines must be buckled at all times during flight to ensure and to enhance
64. Failure to route the restraint lines properly through the garters could cause. . . .
65. True/False: High gain nosewheel steering should be used on takeoff roll up to 50 KIAS.
66. On a section takeoff, turns into the wingman will not be made at altitudes less than feet AGL.
67. True/False: The second section may commence the takeoff roll after the first section has rolled 1,000 feet.
68. True/False: Before descent it is necessary to preheat the windshield by increasing defog airflow.
69. True/False: For optimum braking above 40 KIAS, with anti-skid, full brake pressure should be used.
70. True/False: Ensure anti-skid is OFF for all shipboard operations.
71. Nosewheel steering low mode (may/may not) be engaged while the launch bar is down (circle correct answer).
72. A carrier landing pattern starts with a level break at feet, on the bow of the ship.
73. True/False: The seat rocket thrusters may ignite spilled fuel or hydraulic fluid and may injure ground crew in the immediate vicinity.
74. True/False: If you must land with the launch bar extended, you should request that the field arresting gear cables be removed.
75. A time critical situation exists if you have directional control problems during takeoff. If you suspect nosewheel steering failure, the first thing you should do is
76. If the aircraft begins to settle after a catapult launch and the settling cannot be stopped you must
77. What are the emergency procedures if you have lost thrust on takeoff?

78. True/False: It is unlikely that a blown nose tire will FOD an engine.
79. During flight brief consideration of takeoff abort possibilities, the following items should be considered:
- Weight
 - Speed
 - Runway length remaining
 - All of the above
80. When making an arrested abort, allow time for the arresting hook to extend; as a guide, lower the hook feet before the cable.
81. If the landing gear fails to retract you should perform the following:
- Pull the landing gear control circuit breaker.
 - Cycle the gear and pull negative g's.
 - Put the landing gear handle down and do not cycle
 - Press on - it's probably a false light.
82. What two methods may be used to retain both hydraulic systems if the engine core is rotating:
- -
83. True/False: If the right engine is being rotated with crossbleed to provide normal systems operation and fuel flow on the left engine is reduced below 2,000 pph (as during landing) the right engine hydraulic pump may not provide sufficient flow for nosewheel steering and normal brakes.
84. True/False: Most engine stalls are self clearing.
85. True/False: Engine stalls may produce audible bangs.
86. True/False: If a stalled engine will not clear, you may shut down the engine and attempt a restart.
87. What airspeed may be required to maintain 12 % windmilling rpm?
88. True/False: Engine crossbleed may not be used to achieve a 12 % rpm for engine restart.
89. With one engine windmilling below 12 % , the remaining engine should be operated at or above. % rpm and PPH fuel flow to utilize the crossbleed airstart capability.
90. True/False: Hydraulic system 2A failure is the only single hydraulic system failure which requires flight crewmember action.

91. Hydraulic system 1A does not power which of the following:
 - a. Right Aileron
 - b. Right Trailing Edge Flaps
 - c. Leading Edge Flaps
 - d. Left Trailing Edge Flaps
92. True/False: With HYD 2A failure, anti-skid is available.
93. With HYD 2A failure what type of landing should be considered?
 - a. Normal landing
 - b. Formation landing
 - c. Long field arrestment
 - d. Short field arrestment if practical
94. True/False: Gravity fuel flow is sufficient to sustain minimum afterburner operation.
95. True/False: You are in the spooldown restart envelope at 450 KIAS, 23,000 feet and N_2 50 %.
96. True/False: You are in the windmill restart envelope at Mach 0.75, 25,000 feet and 14 % N_2 .
97. True/False: A crossbleed restart is recommended at Mach 0.68 and 10,000 feet.
98. True/False: As a last resort, you may attempt an APU restart at 250 KIAS and 10,000 feet.
99. True/False: An APU restart should be one of the first procedures you utilize after an engine failure.
100. True/False: One generator is insufficient to carry the total aircraft electrical load.
101. The battery will provide limited dc power for approximately . . . minutes.
102. True/False: The most probable source of visible smoke or fumes in the cockpit is from the engine bleed or residual oil in the ECS ducts.
103. True/False: With both generators inoperative and a good battery your landing gear position indicator will function normally.
104. True/False: With both generators inoperative and a good battery your hydraulic pressure indicator will be inoperative.
105. True/False: Weight must be off the main landing gear or landing gear handle must be up for the emergency jettison system to be operational.
106. True/False: Failure of FCS channels 1 and 3 will not affect the flying qualities of the aircraft.

107. True/False: With FLAPS OFF caution, a reset of the system may cause the leading edge and or trailing edge flaps to retract.
108. True/False: If the trailing edge flaps are failed in the 0° position, final approach airspeed is not significantly affected.
109. True/False: A single-engine landing is made at HALF flaps.
110. With 1,000 feet per minute sink rate, at 130 to 150 KIAS, the minimum altitude for a successful ejection is feet in the F/A-18F at 0° angle of bank.
111. The correct procedure for an APU ACCUM caution airborne is:
112. List the steps for an out-of-control (OCF).
113. Thunderstorm penetration should be made between optimum cruise and KIAS below 35,000 feet, and no less than KIAS above 35,000 feet.
114. What precautions must be observed when using the windshield rain removal?
115. The COM-NAV functions not available when MC1 has failed are:
116. True/False: The right and left DDIs are physically and functionally interchangeable.
117. The bank angle scale pointer, on the HUD, is limited at ... and ...when the limit is exceeded.
118. The velocity vector represents:
119. True/False: Do not lock the gyro in the caged position with the pull to cage knob if the gyro is spinning.
120. Using Stall Speed chart:
 Mil power
 Gross weight - 42,900 pounds
 Gear/flaps - DOWN
 Determine - Stall Speed 0° Bank=
121. Determine - Stall Speed 45° Bank=
122. Using Landing Approach Speed chart:
 Gross weight - 42,900 pounds
 Flaps - HALF
123. Determine - Recommended Approach Speed=
124. What action must the flight crewmember take in order to slew the moving map with the TDC?
- a.
- b.

125. The GYRO position on the INS mode selector switch
- Connects the gyros to the attitude heading reference system in order to complete an inflight alignment
 - Enables the mission computer to use the gyros in computations for air-to-air weapons delivery
 - Is the attitude mode where the INS operates in the gyro mode
 - All of the above
126. REJ 1 removes what from the HUD display?
127. If you see the following in the upper left corner of the HSI display or MPCD, what does it tell you?
- 237/108
18:00
NLC
- Your aircraft is 108 miles from Lemoore TACAN on the 237° radial
 - Your aircraft is 108 miles from Lemoore TACAN on the 057° radial
 - Your aircraft is 18 miles from Lemoore TACAN on the 057° radial, 108° magnetic heading
 - Your aircraft is 18 miles from Lemoore TACAN on the 108° radial, 237° magnetic heading
128. During a data link ACLS (SPN-42) approach the HUD displays:
- A TD box overlying the touchdown point
 - A fly-to tadpole symbol
 - Fly-to needles (similar to ILS)
 - A course arrow and elevation steering bar
129. True/False: During an ILS approach the standby attitude indicator displays the ILS needles.
130. What is the internal fuel capacity of the F/A-18E pounds, F/A-18F: pounds.
131. State the following limitations:
- Maximum steady state EGT -
 - Maximum start EGT -
 - Maximum transient rpm (N₂)

132. State the ranges for the following:

- a. Ground idle rpm -
- b. Flight idle rpm -
- c. Maximum oil pressure (2 minutes after start with ambient temperature below -18°C, 0°F)
Minimum oil pressure (ground idle) -
- d. Inflight oil pressure:
 - (1) Idle -
 - (2) 95 % rpm -
 - (3) Military -

133. The maximum speeds of the following are:

- a. Refueling probe -
- b. Gear retraction/extension -
- c. Gear emergency extension -
- d. Trailing edge flaps -
- e. Canopy open -

134. State the following limitations:

- a. Maximum gross weight field takeoff -
- b. Maximum landing weight (field landing - flared) -
- c. Maximum weight (touch and go) -
- d. Maximum air refueling altitude -
- e. Maximum closure on refueling drogue -
- f. Maximum time at negative g -
- g. Minimum time between negative g maneuvers -

135. If the velocity vector begins to flash slowly but is not HUD limited:
- Selected ordnance has been released.
 - The mission computer may be displaying a degraded velocity vector
 - The waterline symbol is HUD limited
 - STBY attitude indicator is providing HUD attitude information
136. The HUD landing display (elongated horizon bar, AOA bracket, waterline symbol, steering display) will be presented:
- When selected through the HUD control panel
 - When selected on the right DDI
 - When gear is down and NAV master mode is selected
 - Any time that the gear is down
137. True/False: While using NAV master mode, the flight crewmember has the option to cage or uncage the velocity vector on the HUD.
138. At what altitude will the cockpit begin to pressurize?
139. What action should be taken if FCS HOT caution light comes on in flight?
- -
140. When the G XMT switch is placed to COMM 1 or COMM 2 the:
- Selected radio will receive/transmit on 243.0 only
 - Selected radio will receive only 243.0
 - Selected radio will transmit only 243.0
141. The hydraulic pumps are located on the and maintain the hydraulic pressure at approximately psi.
142. The HYD 2 priority valves close at approximately psi.
143. Placing the HI mode selector switch to NORMAL displays compass rose aligned with the aircraft:
- Magnetic ground track
 - Magnetic heading

144. By what method are external tanks pressurized on the ground?
145. What indication does the flight crewmember have to indicate low or lost motive flow pressure?
146. Fuel is transferred from external tanks by:
- The passing of motive flow fuel through an ejector pump which utilizes the venturi principle to induce fuel flow.
 - Bleed air to pressurize each external tank.
 - Electrically powered boost pumps located inside each tank.
 - AMAD driven boost pumps that utilize the venturi principle to induce the flow from each tank.
147. True/False: In the F/A-18F there is no provision to raise the landing gear from the rear cockpit.
148. With a failure of hydraulic system 2A, what alternate method exists for extending the air refueling probe?
149. Fuel dump is accomplished by:
- Motive flow (ejector pumps)
 - Electrical pump powered by essential bus
 - AMAD driven boost pump
 - Variable displacement pumps driven by hydraulic system 2A
150. Normal brake system pressure is provided by hydraulic system
151. What optical indications of NWS failure will the flight crewmember have available besides the MASTER CAUTION light?
- -
152. Where is the manual canopy crank handle located inside the F/A-18 cockpit?
153. Depending on aircraft attitude and power setting, the fuel dump rate is about pounds/minute.
154. True/False: Mechanical linkage will allow normal retraction of the nose gear even with the launch bar extended.
155. After emergency extension of the air refueling probe, how is the probe retracted? (With loss of 2A system)
156. How many low fuel indications does the flight crewmember receive? What are they?

157. Switching to RDR position on the HUD altitude switch will:
- a. Cause radar altimeter information to be displayed at all times, until BARO is reselected.
 - b. Cause radar altimeter information to be displayed when at or below 5,000 feet AGL and valid.
 - c. Cause radar altimeter information to be displayed on the HUD while barometric altitude continues to be displayed on the DDI.
 - d. Cause radar altimeter information to be displayed just below the boxed barometric altitude display.
158. When data link information has been lost during an ACL mode 1 or 2 approach, the HUD indication will be:
- a. TILT cue
 - b. Break X
 - c. Flashing velocity vector
 - d. Both a and b
159. While using the A/A master mode the velocity vector on the HUD will be:
- a. Caged
 - b. Uncaged
160. True/False: With an air-to-ground store or tank on a wing station, maximum roll rate is automatically reduced about 33 %.

PART XI

PERFORMANCE DATA

Refer to Supplemental Flight Manual A1-F18EA-NFM-200.

APPENDIX A

SYSTEM ORGANIZATIONAL MAINTENANCE MANUALS.

System Organizational Maintenance Manuals are in the Interactive Electronic Technical Manuals (IETM).

The IETM also references System Schematic Manuals. The following list contains the publication numbers and titles of the System Schematic Manuals.

System Schematics A1-F18EA	System Title
-120-500	Seat, Canopy, Survival Equipment, and Boarding Ladder
-130-500	Landing Gear and Related Systems
-240-500	Secondary Power System
-270-500	Power Plant and Related Systems
-410-500	Environmental Control Systems
-420-500	Electrical System
-440-500	Lighting System
-450-500	Hydraulic System
-460-500	Fuel System
-510-500	Instrument Systems
-570-500	Integrated Flight Controls System
-580-500	Flight Incident Recorder and Monitoring System
-600-500	Communication, Navigation, and Identification Systems

System Schematics A1-F18EA	System Title
-630-500	Data Link, Instrument Landing, and Radar Beacon Systems
-710-500	Global Positioning System
-730-500	Inertial Navigation, Backup Altitude, and Navigation Systems
-731-500	Digital Map Set/TAMMAC Digital Map Set
-732-500	Accurate Navigation (ANAV) System
-740-500	Weapon Control System
-741-500	Mission Computer System
-742-500	Radar System
-743-500	APG-79 AESA Radar System
-744-500	Forward Looking Infrared System
-745-500	Multipurpose Display Group
-746-500	Navigation Infrared Receiving System
-750-500	Gun System
-760-500	Tactical Electronic Warfare Systems
-770-500	Video Recording and Reconnaissance Systems
-771-500	Shared Reconnaissance POD (SHARP)

APPENDIX B

Aircraft Differences (LOTs 21 - 22 Aircraft)

AIRCRAFT DIFFERENCES (LOTs 21 - 22 Aircraft)

The baseline aircraft for the NATOPS manual is aircraft 165779 and up. As a result, this chapter documents the differences from the baseline aircraft for aircraft 165533 thru 165679.

The numbering scheme for this chapter differs from that used throughout the NATOPS manual. The "B" indicates the text is from this chapter, however the remaining numbers indicate the specific paragraph in this manual affected by the difference.

B.2.1.1.1.13 ABLIM - Afterburner Limiting Function. The ABLIM function is disabled with a FCC CH 1, 2, or 4; MC1, FADEC, or INS failure.

B.2.5.3.6 Automatic Battery Cutoff (LOT 21 Aircraft). Automatic battery cutoff occurs after 1 minute.

B.2.5.3.7 Battery Gauge (LOT 21 Aircraft). There is no cockpit indication of battery voltage. Refer to figure B-FO-1.

B.2.5.3.8 BATT SW Caution and Caution Light (LOT 21 Aircraft). The BATT SW caution and caution light are set to alert the aircrew of an improperly placed BATT switch, or a battery related malfunction. After a dual GEN failure, the BATT SW caution light must be referenced to determine whether an EBB PMG or the battery is powering the essential bus. These cautions are set in only four circumstances.

1. The BATT switch is ON on the ground in the absence of ac power (i.e., first engine start). The battery is depleting and the switch should be placed to OFF unless APU start is about to be made.
2. The BATT switch is OFF inflight and should be placed to ON to provide essential bus backup capability from the PMGs and battery.
3. The battery is not being recharged inflight (BATT switch ON). The battery charger has failed or the right generator has failed with the buses isolated (R GEN and GEN TIE cautions).
4. The battery is powering the essential bus inflight. A dual generator failure **and** a dual PMG failure has occurred and at least 5 to 10 minutes of battery power remains to run the FCCs.

B.2.9.1.1 LEX Vents. This section was deleted from the NATOPS. However, although physically present on the aircraft, the LEX vents have been completely disabled in FCS logic and should be in the full up position at all times.

B.2.10.1.1 Spoilers. The spoilers are mounted on top of the fuselage near the aft end of the LEX. The spoilers are controlled by the FCCs and have three fixed positions: 0° (down), 13° TEU, or 60° TEU.

The spoilers are commanded to the 13° TEU position at greater than Mach 1.5 to open engine inlet bleed air doors. The 60° TEU position is activated by the speed brake function or when more than 15° TED stabilator is commanded (forward stick) above 22° AOA to aid in recovery from high AOA.

B.2.10.2 FCCs - Flight Control Computers (LOT 22 and up Aircraft). These aircraft do not have Attitude and Heading Reference Sets (AHRS).

B.2.10.7.4 G-Bucket (Before FCC Software 18E-004). Due to the aerodynamic phenomenon known as transonic pitchup, the g-limiter incorporates a g-bucket designed to prevent an aircraft over-g during transonic deceleration. In the g-bucket, the g-limiter reduces the positive command g-limit to a value below Nz REF. This reduction is 1.0g above 20,000 ft and 1.7g below 15,000 ft, but at no time is the symmetrical command limit reduced below +4.5g. For instance, if Nz REF is +7.5 g (at or below 42,097 lb GW), the g-limiter only allows +5.8 g to be commanded while in the g-bucket. FSR limits are also reduced in the g-bucket to 80 % of (Nz REF minus the reduction).

The Mach numbers at which the g-bucket is entered are dependent on external stores configuration. The g-bucket is entered at Mach 0.905 accelerating (with wing tanks or A/G stores) or at Mach 0.941 accelerating (clean or with A/A stores). Regardless of stores loading, the g-bucket is entered at Mach 1.045 decelerating and is exited at Mach 0.875 decelerating. So, if the pilot wants to have maximum-g available during a turning maneuver (e.g., the merge), Mach in the HUD should be 0.90 or less (with wing tanks or A/G stores) or 0.93 or less (clean or with A/A stores) to keep out of the g-bucket.

B.2.17.9.1 GPWS/TAWS Voice Warnings. Refer to figure B2-41.

CFIT Warning Condition	Voice Warning	Repetition Rate
ARR or Floor Altitude	"Power...Power" for V < 210 KCAS and AOB < 45° (gear up) or V < 175 KCAS and AOB < 45° (gear down) "Roll-Left...Roll-Left" for AOB > 45° (-1018) "Roll-Right.... Roll-Right" for AOB < 45° (-1018) "Roll-Out...Roll-Out" for AOB > 45° (-1016) "Pull-Up... Pull-Up" for AOB < 45°	2 seconds
Excessive Take-off/Wave-off Sink Rate	"Power....Power"	2 seconds
Excessive Landing Sink Rate	"Power....Power"	2 seconds
Gear Up Landing	"Check Gear" with gear handle down	8 seconds
	"Pull-Up ...Pull-Up" or "Power...Power" then "Check Gear" when handle is up	2 seconds

Figure B2-41. CFIT Conditions, Voice Warning, and Repetition Rates

B.2.17.5 8 Day Clock. This section was deleted from NATOPS. A standard 8 day clock is installed.

B.2.19.7.4.3 VTR 1 Selector Switch. The VTR 1 selector switch is used to select the video input source for recording on VTR 1.

RDDI Selects right over-the-shoulder camera video.

LDDI Selects left over-the-shoulder camera video.

B.2.19.7.4.4 VTR 2 Selector Switch. The VTR 2 selector switch is used to select the video input source for recording on VTR 2.

HUD Selects HUD camera video.

UFCD Selects direct video input to the UFCD.

MPCD Selects direct video input to the MPCD.

B.2.19.4.6.10 HUD Symbology. There is no energy caret display in the HUD landing symbology.

B.2.22.5 HUD Video Record Panel (Aircraft 165660 and 165669). See figure B2-60 for HUD video record panel applicable to aircraft 165660 and 165669.

B.7.1.3 Exterior Inspection. This section was deleted from NATOPS. Verify the LEX vents are FULL UP and their condition is satisfactory.

B.7.1.5 Interior Checks - Pilot.

Left Console -

- 17. EXT LT panel - SET
 - a. STROBE switch - BRT or DIM
 - b. FORMATION knob - AS REQUIRED
 - c. POSITION knob - AS REQUIRED

Pedestal Panel (LOT 21 Aircraft) -

- 1. ECM JETT button - NOT PUSHED IN
- 2. DISPENSER switch - OFF
- 3. ECM knob - OFF
- 4. DECOY switch - OFF
- 5. AUX REL switch - NORM
- 6. RWR switch - OFF

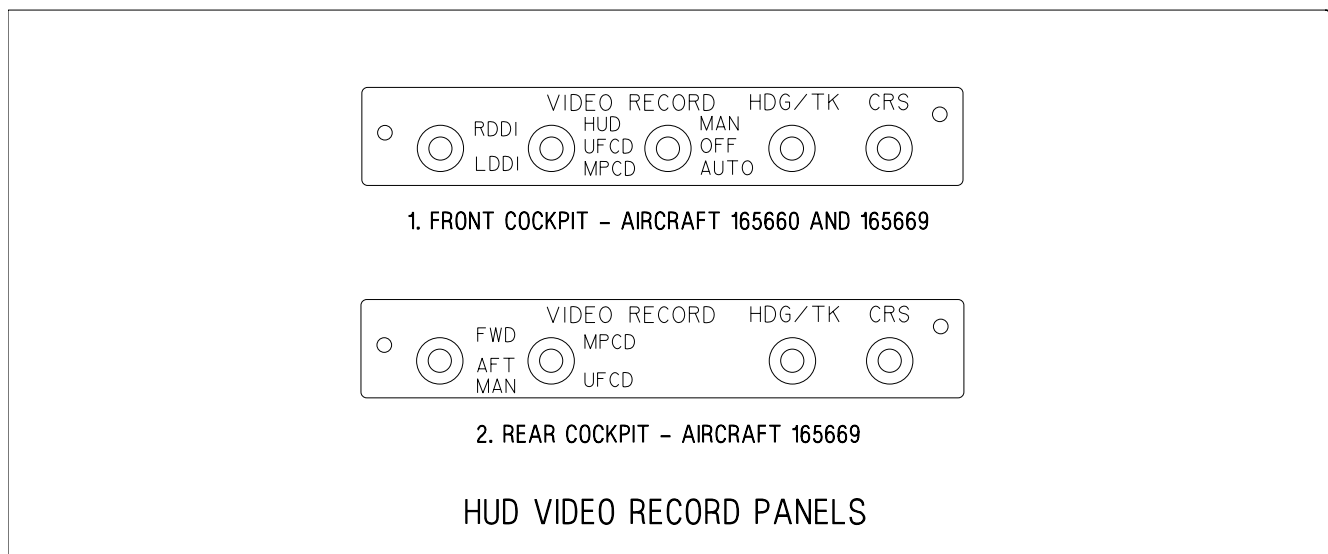

Figure B2-60. HMD Controls

EFN520-399-1-005

- 7. Clock - CHECK AND SET
- 8. RUD PED ADJ lever - ADJUST PEDAL POSITION

B.7.2.2 Engine Start Checks (LOT 21 Aircraft).

- 2. There is no battery gauge for aircraft.
- 10. MC OFP 13E commands ROLL OUT, ROLL OUT while MC OFP 18E commands ROLL LEFT, ROLL LEFT.
- 11. There is no battery gauge for aircraft.

NOTE

Slow canopy movement, EFD blanking, or uncommanded APU shutdown is indicative of a weak battery.

B.8.2.6 Takeoff Checks.

For MAX power catapult launches only -

- 2. ABLIM option - BOX

NOTE

Prior to OFP 18E, the ABLIM option may be misinterpreted as a DDI caution due to similar font size and location. There is no ABLIM caution.

B.11.1.3 Flaps AUTO Handling Qualities (Before OFP 18E-004).

Flight test showed the most sensitive area for over-g to be localized around 20,000 feet and 0.93 IMN even with a nominal CG.

B.Figure 12-1. Advisory Displays. (LOTs 21 - 22 Aircraft)

Advisory Lights

INDICATOR	• CAUSE / REMARKS	CORRECTIVE ACTION
AAA	• AAA threat detected.	1. Refer to A1-F18EA-TAC-Series.
AI	• Airborne threat detected	1. Refer to A1-F18EA-TAC-Series.
DISP	• ALE-47 dispense activated.	1. Refer to A1-F18EA-TAC-Series.

B.15.13 FCS FAILURE INDICATIONS AND EFFECTS (LOT 21 Aircraft).

Figure 15-24, Spoiler Channels 1 and 4 or 2 and 3 Failure, engine bleed air may be degraded at high Mach number with spoiler failed closed and flaps AUTO.

Figures B.15-37 thru B.15-40, and figures B.15.43 and B.15.44, are applicable to these aircraft.

B.23.2.1 ICS VOL Control Knobs (LOT 21 Aircraft). The ICS VOL control knobs are located on the VOL control panel on the left console in each cockpit. The knobs are stacked in pairs, upper and lower. Clockwise rotation increases headset volume for the controlled sub-system from the LO to the HI position. The six knobs control the indicated sub-system and are labeled as follows:

1. TACAN morse code identification (TCN knob (upper))
2. Intercockpit and aircrew/ground crew voice (ICS knob (lower))
3. ALR-67 tones (RWR knob (upper))
4. ECM equipment (when installed) (ECM knob (lower))
5. AIM-9 seeker audio (WPN knob (upper))
6. Unused (AUX knob (lower))

The ground crew headset plug in jack and ICS volume control knob are located in door 8R on the right side of the forward fuselage.

B.23.7 DCS - DIGITAL COMMUNICATION SYSTEM

LOT 21 Aircraft do not incorporate DCS.

Foldouts. Refer to figures B-FO-1 and B-FO-2 for specific cockpit component locations.

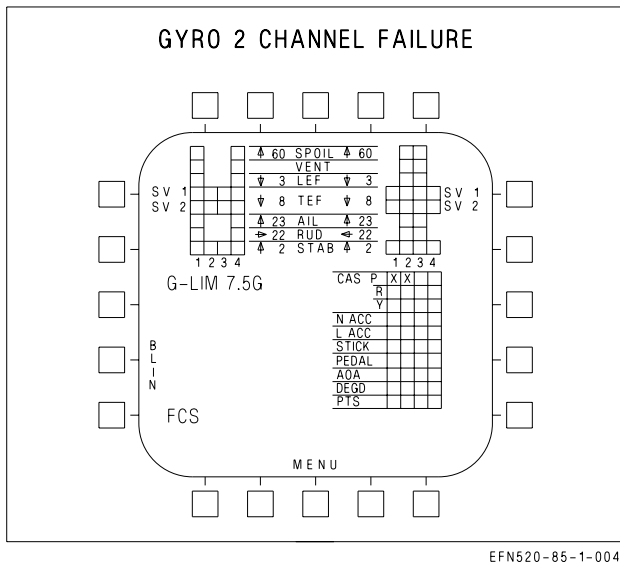

NOTE

FCS status display is shown for pitch rate gyro channels 1 and 2 failure example.

EFFECTS:

No change in flying qualities.
Autopilot inoperative.

Figure B15-37. FCS Failure Indications and Effects

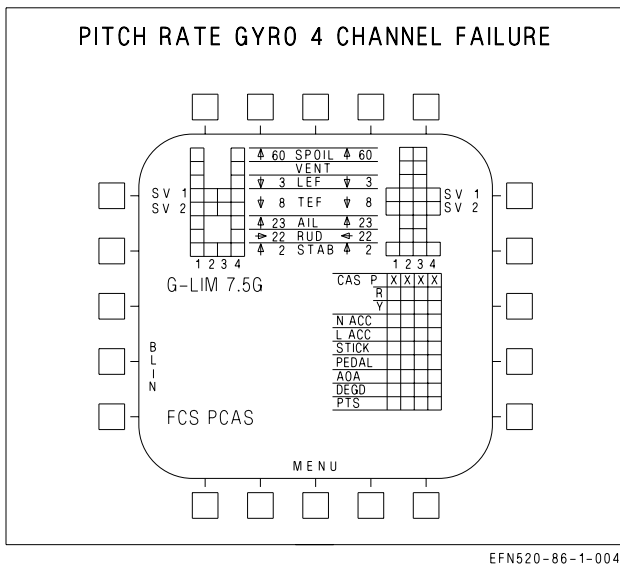

EFFECTS:

Autopilot inoperative
ATC inoperative
Sensitive dynamic pitch characteristics.
Aggressive pitch inputs may result in PIO.

Figure B15-38. FCS Failure Indications and Effects

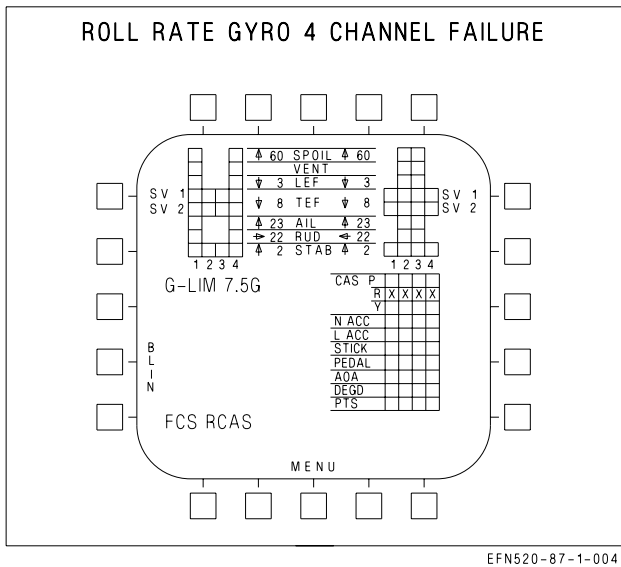

Figure B15-39. FCS Failure Indications and Effects

EFFECTS:
 Degraded roll CAS.
 Reduced roll damping.
 Autopilot inoperative.
Flaps - HALF or FULL:
 Sluggish roll response.
 Lateral PIO tendency.

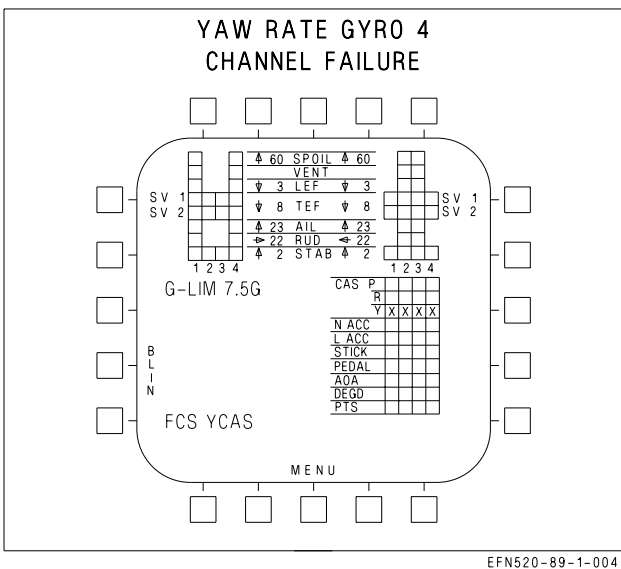
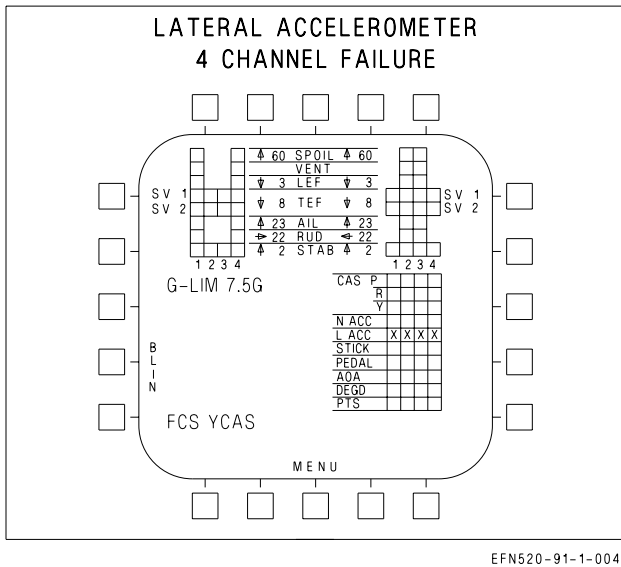

Figure B15-40. FCS Failure Indications and Effects

EFFECTS:
 Autopilot inoperative.
 ASRM inoperative.
Flaps - AUTO:
 Poor dutch roll damping.
 Large sideslip with lateral stick.
Flaps - HALF or FULL:
 Poor dutch roll damping.
 Large sideslip with full rudder pedal.
 Lateral PIO tendency.
 Directional PIO may occur during aggressive ground tracking.



EFFECTS:
 Degraded yaw CAS.
 Autopilot inoperative.
Flaps - HALF or FULL:
 Large sideslips with full rudder pedal.

Figure B15-43. FCS Failure Indications and Effects

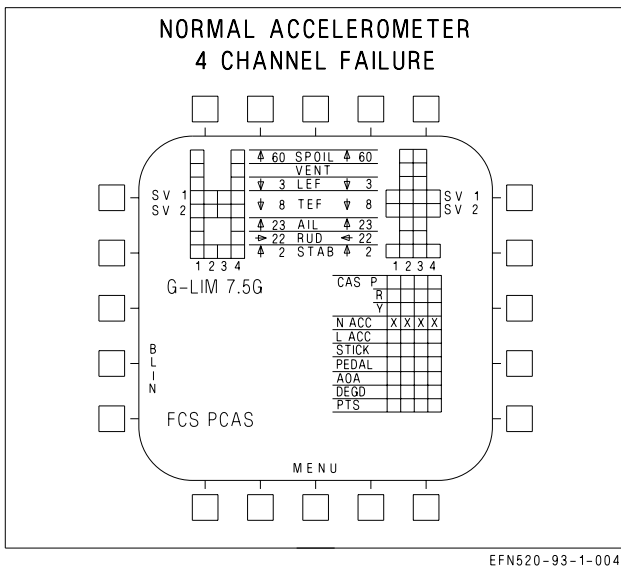

EFFECTS:
 Autopilot inoperative.
 ATC inoperative.
 Spin recovery arrow not provided, but ASRM still available.
Flaps - AUTO:
 Degraded pitch CAS.
Flaps - HALF or FULL:
 No change in flying qualities.

Figure B15-44. FCS Failure Indications and Effects

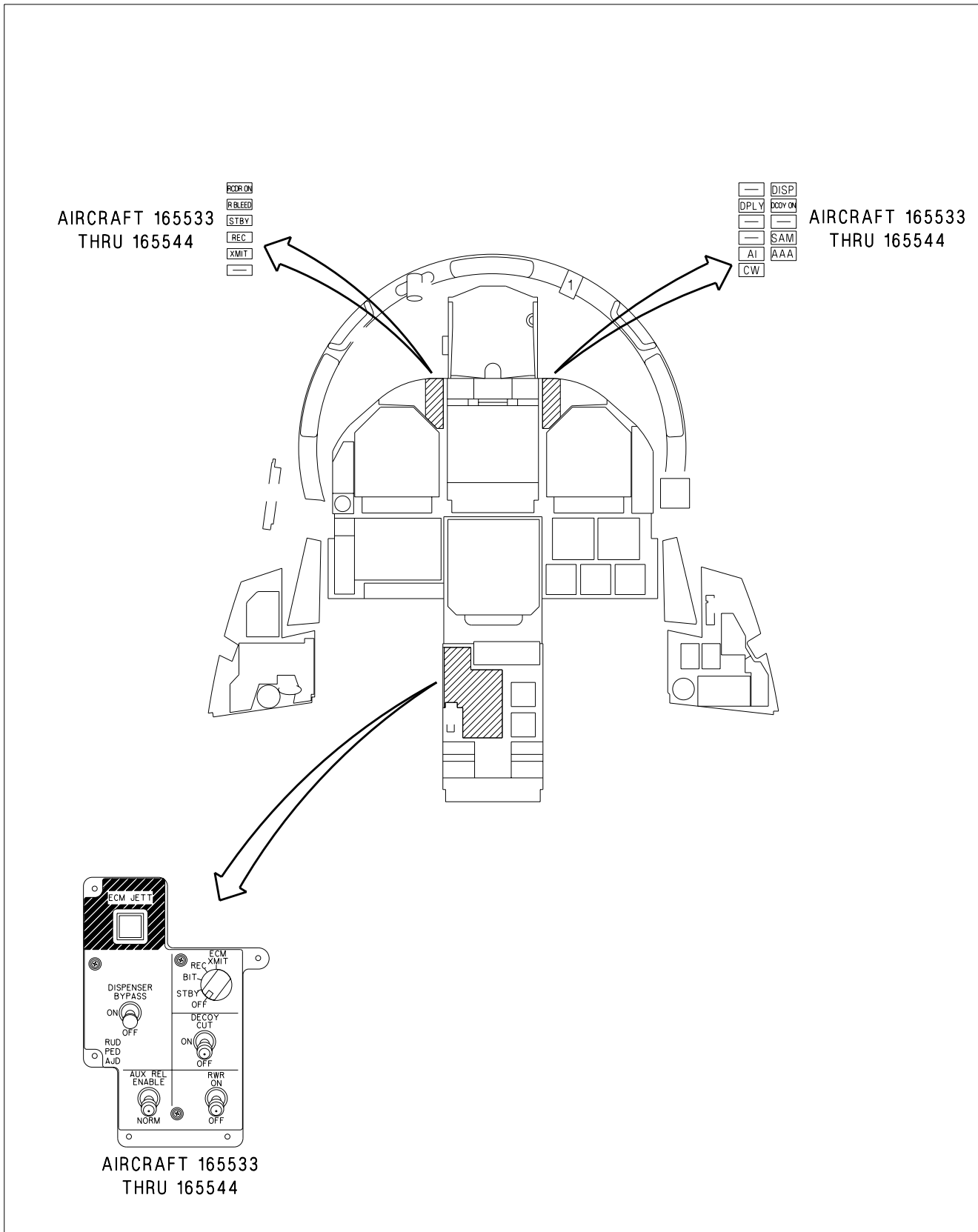

EFN520-369-1-004

Figure B-FO-1. Cockpit F/A-18E/F (Sheet 1 of 2)

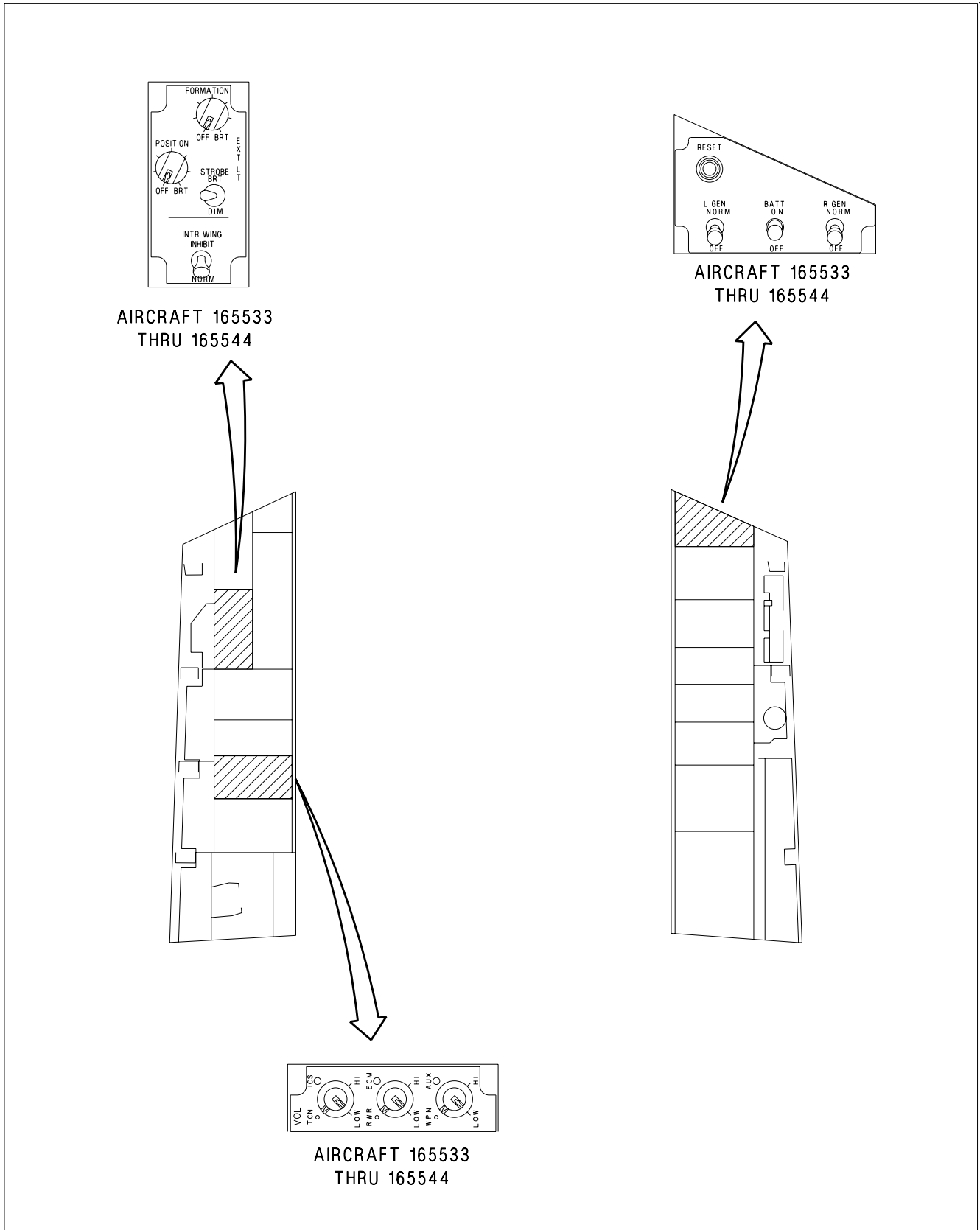

AIRCRAFT 165533
THRU 165544

AIRCRAFT 165533
THRU 165544

AIRCRAFT 165533
THRU 165544

Figure B-FO-1. Cockpit F/A-18E/F (Sheet 2 of 2)

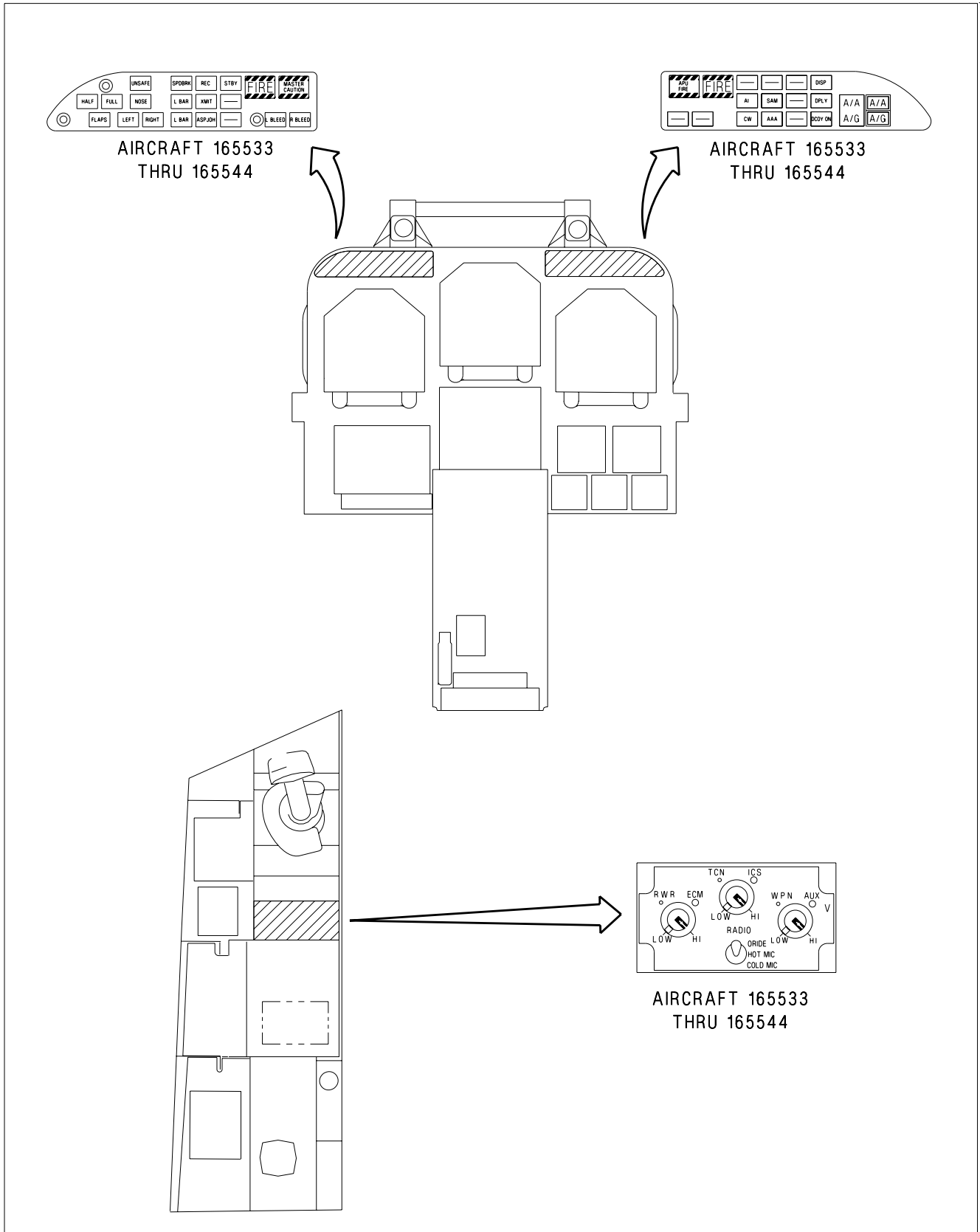

EFN520-370-1-004

Figure B-FO-2. Rear Cockpit F/A-18F

FOLDOUTS

TABLE OF CONTENTS

Cockpit F/A-18E/F (Lots 21 thru 25)	FO-3
Rear Cockpit F/A-18F (Lots 21 thru 25)	FO-7
Cockpit F/A-18E/F (Lot 26 AND UP)	FO-11
Rear Cockpit F/A-18F (Lot 26 AND UP)	FO-15
Electrical Bus Power	FO-19
Ejection Seat	FO-21
Fuel System	FO-25
Environmental Control System	FO-29

FOLDOUT SECTION

The purpose of the Foldout Section is to make these illustrations available for ready reference while reading the associated text. The illustrations are referenced from several sections of the manual and are referred to in the text as (see figure FO-, foldout section).

The System Foldouts are simplified to provide a general understanding of complicated systems. They do not contain all components, circuits, etc. For a complete diagram(s) of a system, refer to the applicable maintenance publication.

1. LOCK SHOOT LIGHTS
2. HEAD UP DISPLAY (HUD)
3. ANGLE OF ATTACK INDEXER LIGHTS
4. LEFT ENGINE FIRE WARNING/ EXTINGUISHER LIGHT
5. MASTER CAUTION LIGHT
6. LEFT WARNING/CAUTION/ADVISORY LIGHTS
7. HUD VIDEO CAMERA CONTROL
8. RIGHT WARNING/CAUTION/ADVISORY LIGHTS
9. AUXILIARY POWER UNIT FIRE WARNING/ EXTINGUISHER LIGHT
10. RIGHT ENGINE FIRE WARNING/EXTINGUISHER LIGHT
11. CANOPY INTERNAL JETTISON HANDLE
12. MASTER ARM PANEL
13. LEFT DDI
14. UP FRONT CONTROL DISPLAY
15. RIGHT DDI
16. SPIN RECOVERY PANEL
17. EMERGENCY JETTISON BUTTON
18. HUD CONTROL
19. STANDBY MAGNETIC COMPASS
20. STATION JETTISON SELECT
21. LANDING GEAR AND FLAP POSITION LIGHTS
22. ENGINE FUEL DISPLAY
23. VIDEO RECORD PANEL
24. MULTIPURPOSE COLOR DISPLAY
25. STANDBY ATTITUDE REFERENCE INDICATOR

INSTRUMENT PANEL

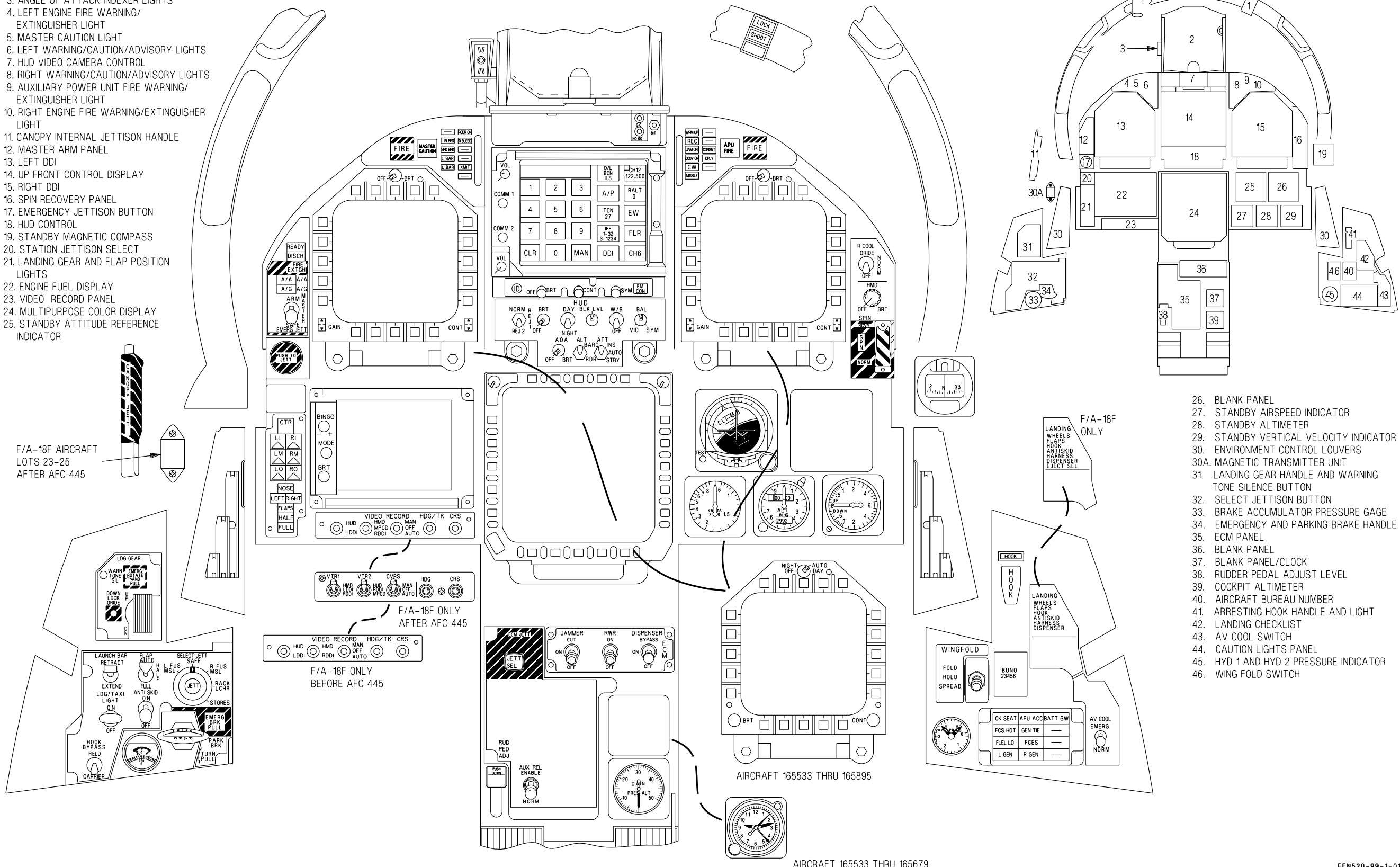

F/A-18F AIRCRAFT
LOTS 23-25
AFTER AFC 445

F/A-18F ONLY
AFTER AFC 445

F/A-18F ONLY
BEFORE AFC 445

AIRCRAFT 165533 THRU 165895

AIRCRAFT 165533 THRU 165679

26. BLANK PANEL
27. STANDBY AIRSPEED INDICATOR
28. STANDBY ALTITUDE INDICATOR
29. STANDBY VERTICAL VELOCITY INDICATOR
30. ENVIRONMENT CONTROL LOUVERS
- 30A. MAGNETIC TRANSMITTER UNIT
31. LANDING GEAR HANDLE AND WARNING TONE SILENCE BUTTON
32. SELECT JETTISON BUTTON
33. BRAKE ACCUMULATOR PRESSURE GAGE
34. EMERGENCY AND PARKING BRAKE HANDLE
35. ECM PANEL
36. BLANK PANEL
37. BLANK PANEL/CLOCK
38. RUDDER PEDAL ADJUST LEVEL
39. COCKPIT ALTIMETER
40. AIRCRAFT BUREAU NUMBER
41. ARRESTING HOOK HANDLE AND LIGHT
42. LANDING CHECKLIST
43. AV COOL SWITCH
44. CAUTION LIGHTS PANEL
45. HYD 1 AND HYD 2 PRESSURE INDICATOR
46. WING FOLD SWITCH

Figure FO-1. Cockpit F/A-18E/F (Lots 21 thru 25) (Sheet 1 of 2)

EFN520-99-1-016

1. FIRE TEST PANEL
2. GROUND POWER PANEL
3. THROTTLE QUADRANT
4. EXTERIOR LIGHTS PANEL
5. FUEL PANEL
6. FLIGHT CONTROL SYSTEM PANEL
7. VOLUME CONTROL PANEL
8. COMMUNICATION PANEL
9. OBOGS FLOW CONTROL
10. ANTI-G VALVE
11. PILOT SERVICES PANEL
 - *ANTI-G
 - *LOWER HVI CABLE ASSY
 - *OXYGEN
12. COMMUNICATION CONNECT
13. MISSION COMPUTER AND HYDRAULIC ISOLATE PANEL
14. ANTENNA SELECT PANEL

NOTE

- Radio override switch on F/A-18F aircraft only
15. AUXILIARY POWER UNIT PANEL
 16. GENERATOR TIE CONTROL SWITCH
 17. ECM DISPENSER BUTTON
 18. GROUND POWER DECAL
 19. LEFT ESSENTIAL CIRCUIT BREAKERS
 20. MANUAL CANOPY HANDLE AND DRIVE
 21. HVI STOWAGE/NUCLEAR WEAPON SWITCH
 22. VIDEO CAMERA

LEFT CONSOLE

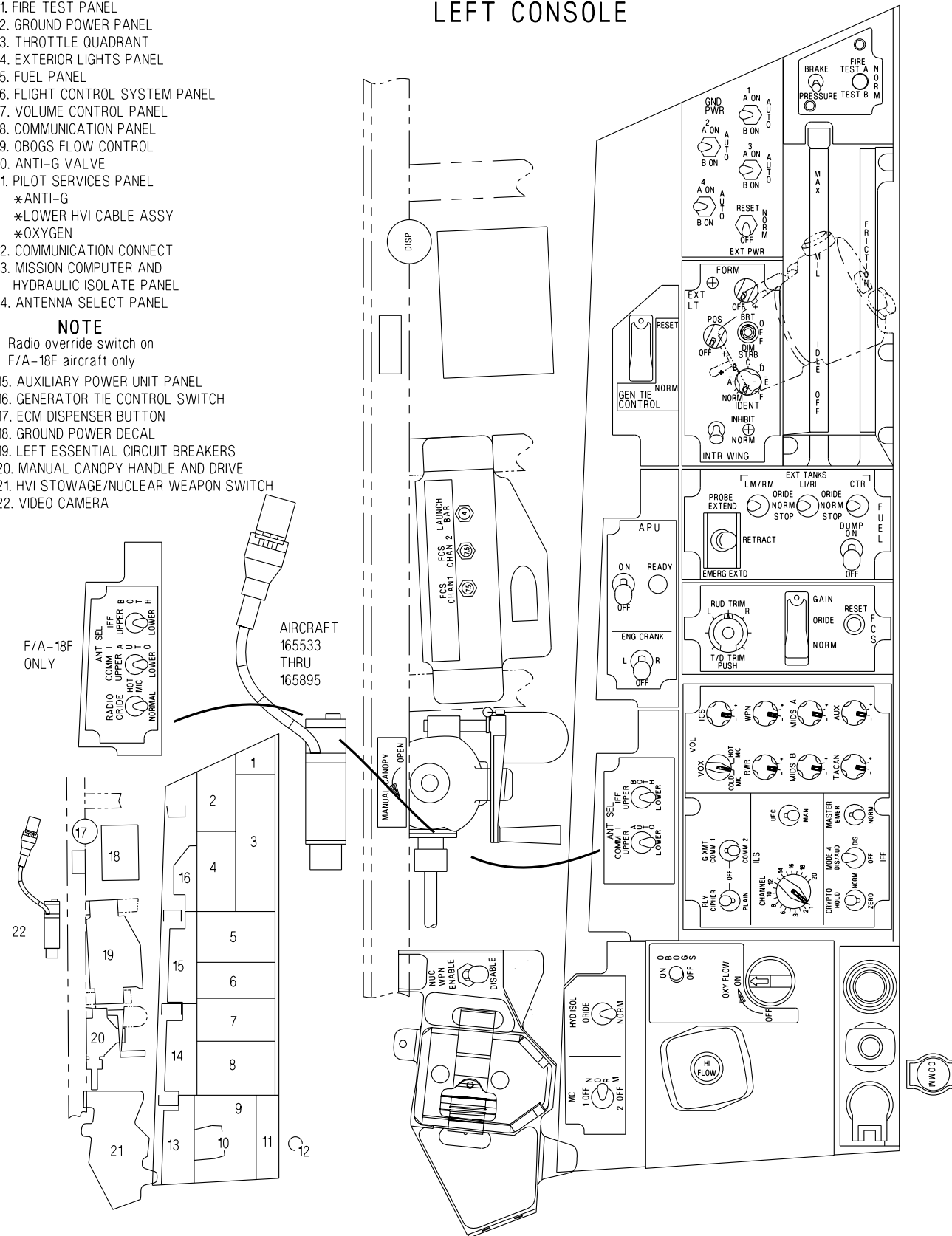

RIGHT CONSOLE

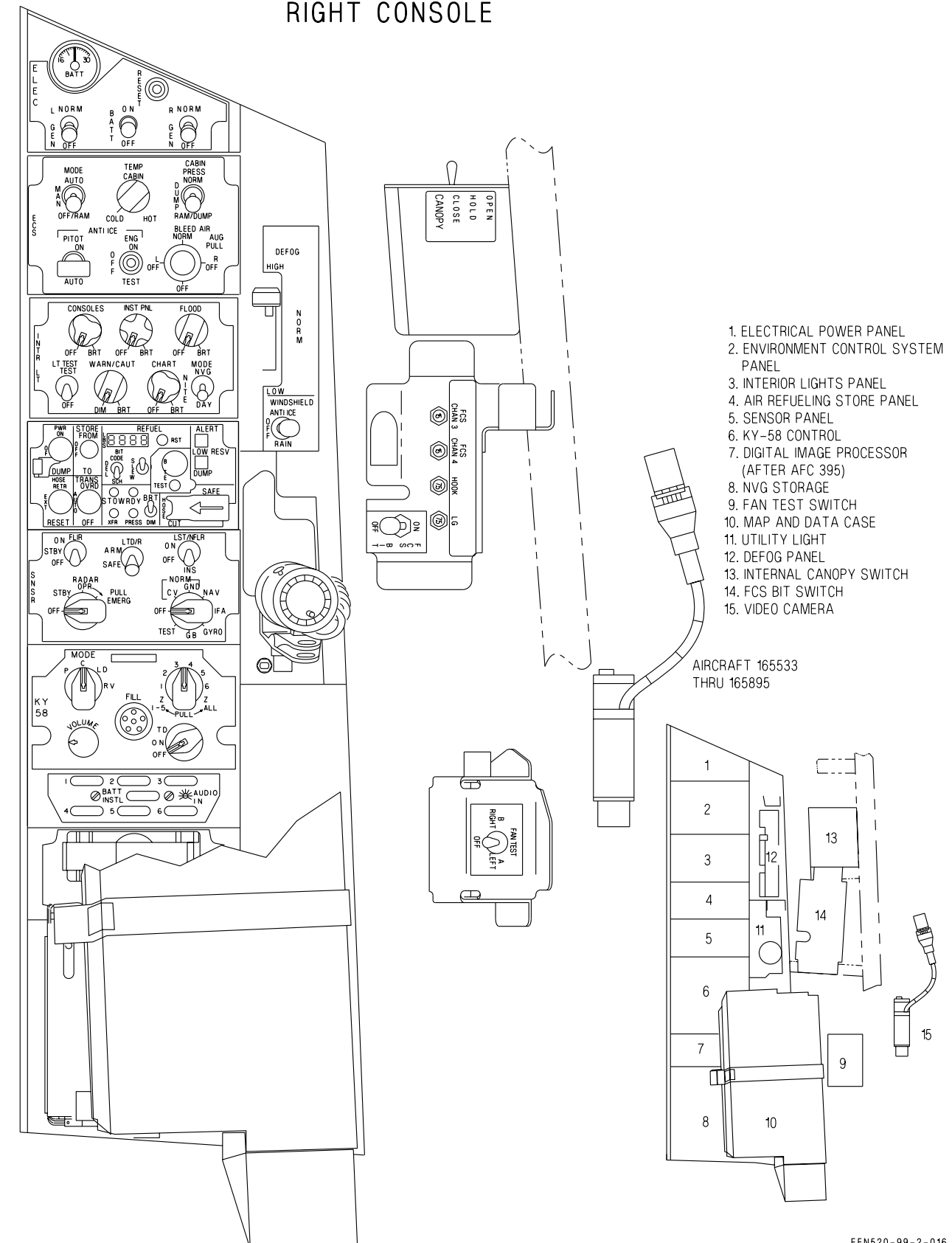
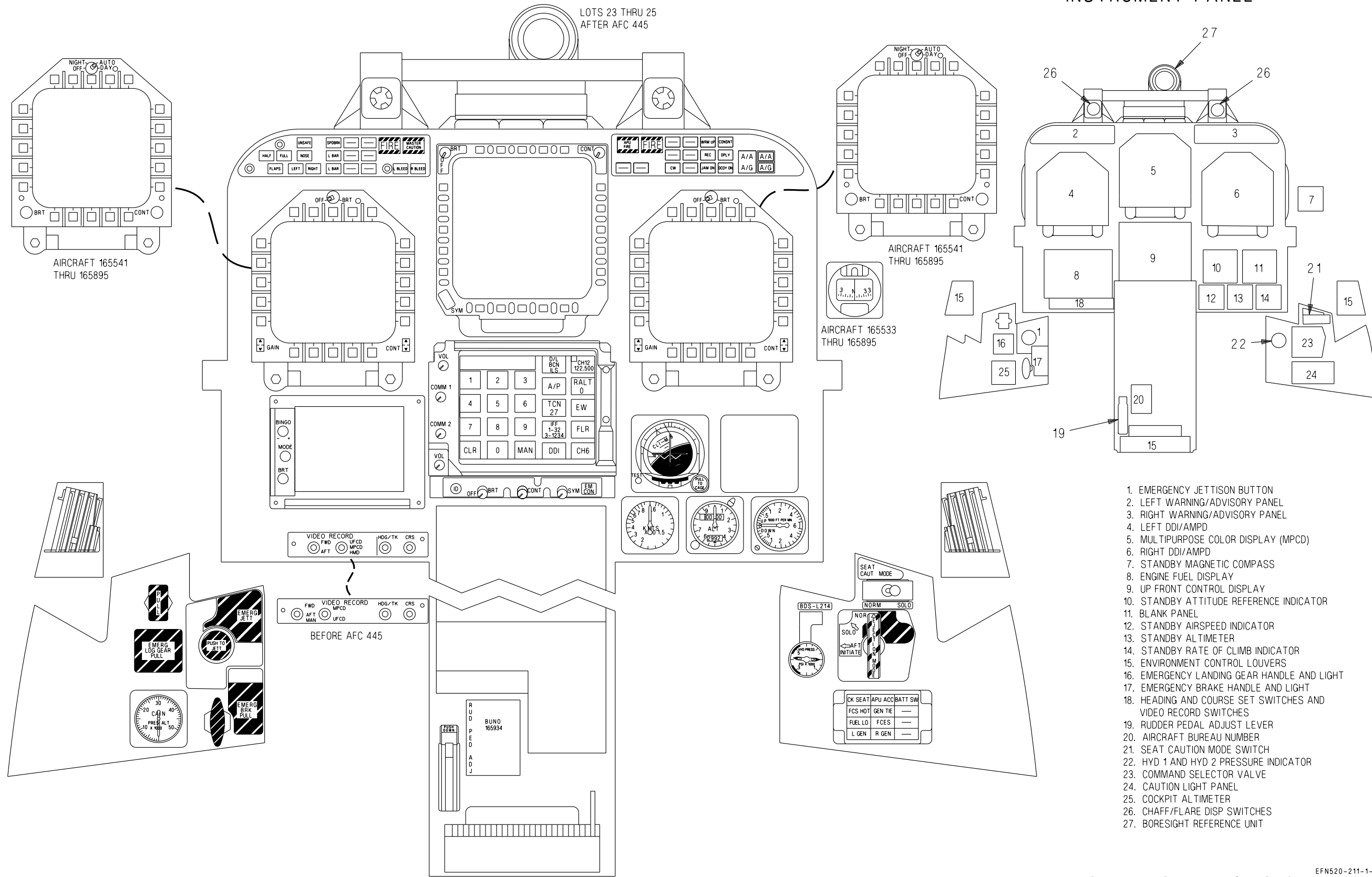

Figure FO-1. Cockpit F/A-18E/F (Lots 21 thru 25) (Sheet 2 of 2)

EFN520-99-2-016

INSTRUMENT PANEL



1. EMERGENCY JETTISON BUTTON
2. LEFT WARNING/ADVISORY PANEL
3. RIGHT WARNING/ADVISORY PANEL
4. LEFT DDI/AMP
5. MULTIPURPOSE COLOR DISPLAY (MPCD)
6. RIGHT DDI/AMP
7. STANDBY MAGNETIC COMPASS
8. ENGINE FUEL DISPLAY
9. UP FRONT CONTROL DISPLAY
10. STANDBY ATTITUDE REFERENCE INDICATOR
11. BLANK PANEL
12. STANDBY AIRSPEED INDICATOR
13. STANDBY ALTIMETER
14. STANDBY RATE OF CLIMB INDICATOR
15. ENVIRONMENT CONTROL LOUVERS
16. EMERGENCY LANDING GEAR HANDLE AND LIGHT
17. EMERGENCY BRAKE HANDLE AND LIGHT
18. HEADING AND COURSE SET SWITCHES AND VIDEO RECORD SWITCHES
19. RUDDER PEDAL ADJUST LEVER
20. AIRCRAFT BUREAU NUMBER
21. SEAT CAUTION MODE SWITCH
22. HYD 1 AND HYD 2 PRESSURE INDICATOR
23. COMMAND SELECTOR VALVE
24. CAUTION LIGHT PANEL
25. COCKPIT ALTIMETER
26. CHAFF/FLARE DISP SWITCHES
27. BORESIGHT REFERENCE UNIT

Figure FO-2. Rear Cockpit F/A-18F (Lots 21 thru 25) (Sheet 1 of 2)

1. BLANK PANEL
2. BLANK PANEL
3. HAND CONTROLLER (RECCE)
4. RECCE PANEL (LOT 21)
5. PTT PANEL (LOT 22 AND 16)
6. RSC PANEL
7. VOLUME CONTROL
8. EU/CU COVER AND HVI STOWAGE
9. PILOT SERVICE PANEL
 - * ANTI-G
 - * LOWER HVI CABLE ASSY
 - * OXYGEN
10. OBOGS FLOW CONTROL
11. ANTI-G VALVE
12. COMMUNICATION CONNECTION
13. BLANK PANEL
14. CANOPY INTERNAL JETTISON HANDLE
15. BLANK PANEL
16. ECM DISPENSE BUTTON

LEFT CONSOLE

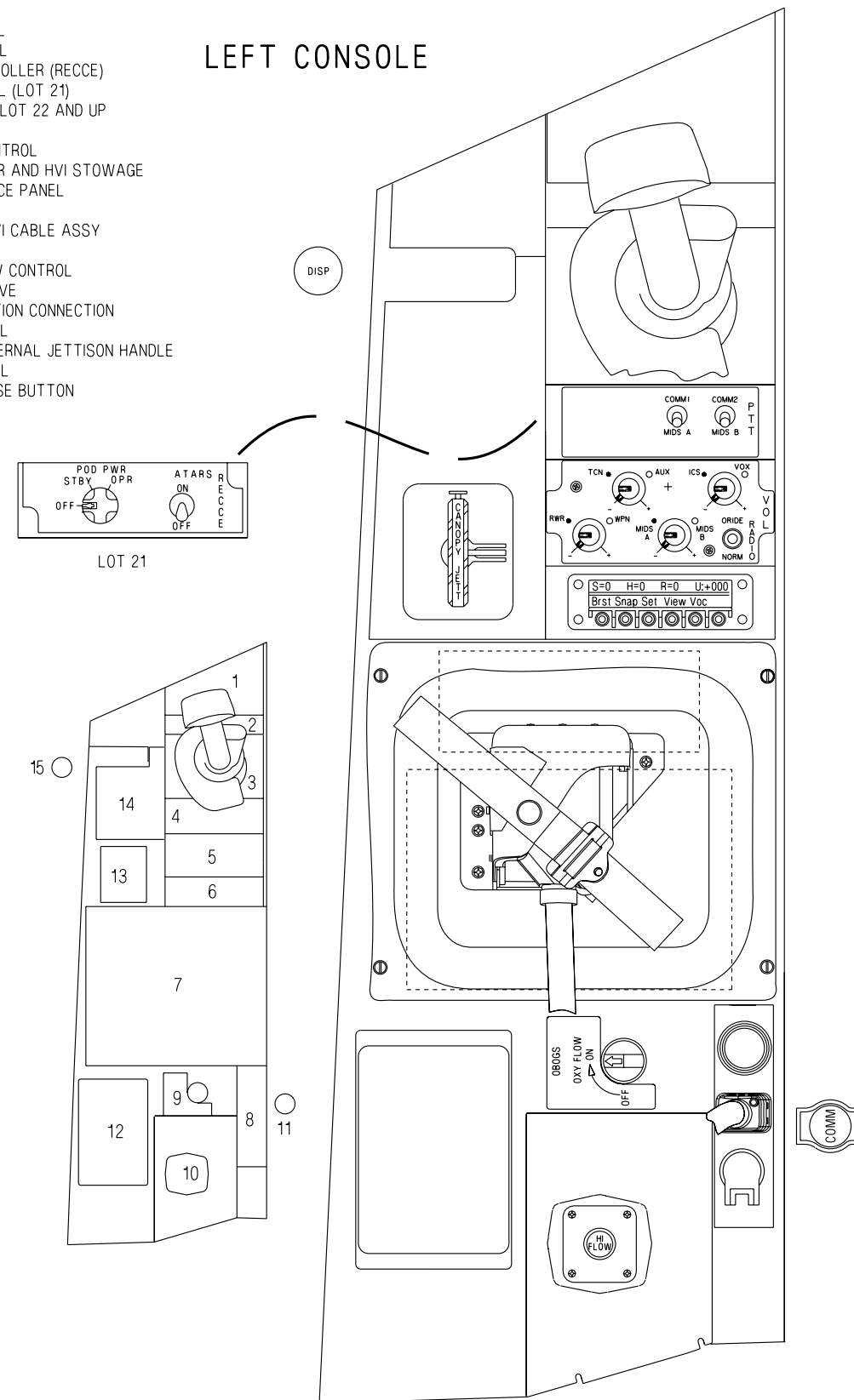

RIGHT CONSOLE

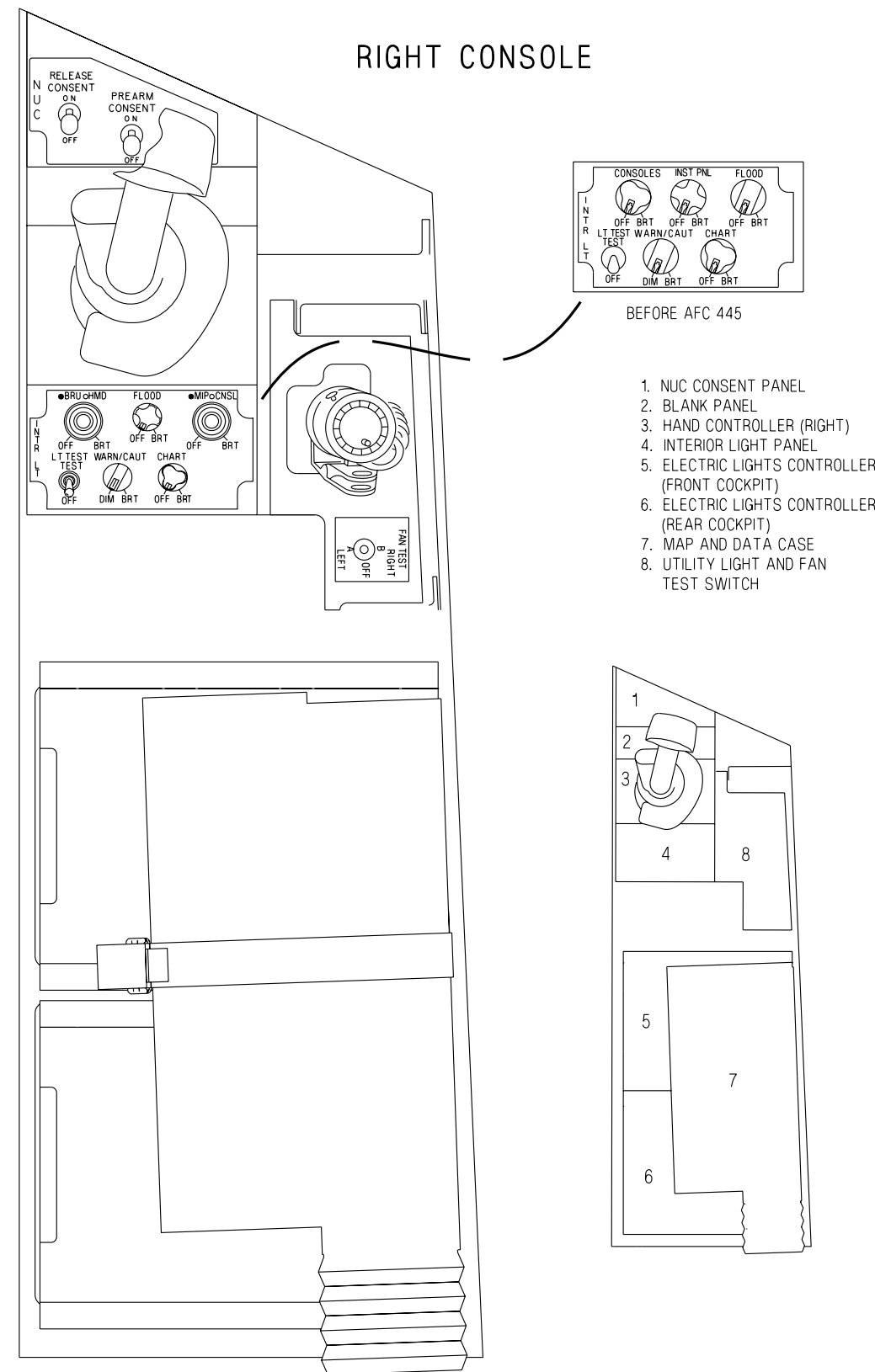
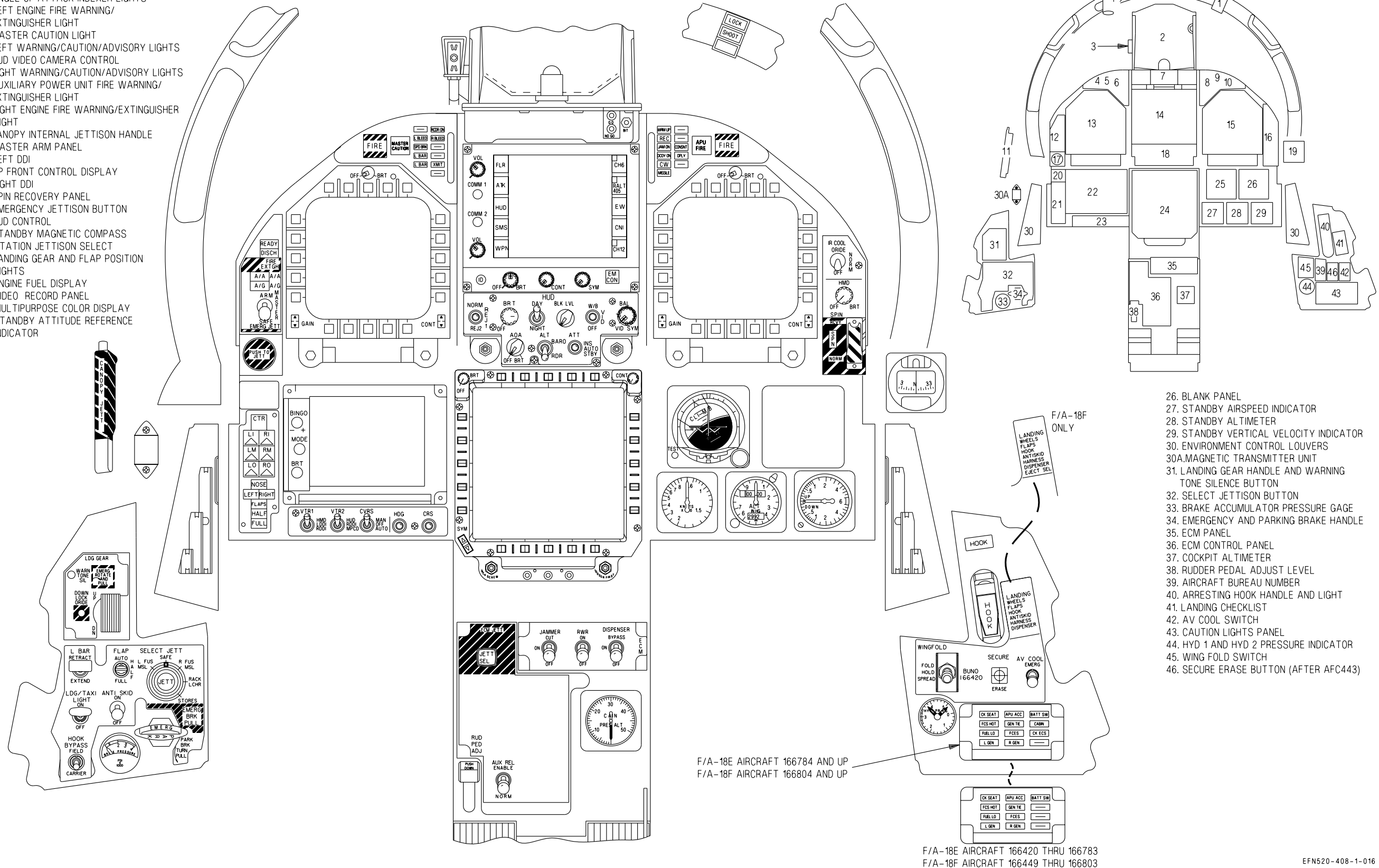

Figure FO-2. Rear Cockpit F/A-18F (Lots 21 thru 25) (Sheet 2 of 2)

EFN520-211-2-016

1. LOCK SHOOT LIGHTS
2. HEAD UP DISPLAY (HUD)
3. ANGLE OF ATTACK INDEXER LIGHTS
4. LEFT ENGINE FIRE WARNING/ EXTINGUISHER LIGHT
5. MASTER CAUTION LIGHT
6. LEFT WARNING/CAUTION/ADVISORY LIGHTS
7. HUD VIDEO CAMERA CONTROL
8. RIGHT WARNING/CAUTION/ADVISORY LIGHTS
9. AUXILIARY POWER UNIT FIRE WARNING/ EXTINGUISHER LIGHT
10. RIGHT ENGINE FIRE WARNING/EXTINGUISHER LIGHT
11. CANOPY INTERNAL JETTISON HANDLE
12. MASTER ARM PANEL
13. LEFT DDI
14. UP FRONT CONTROL DISPLAY
15. RIGHT DDI
16. SPIN RECOVERY PANEL
17. EMERGENCY JETTISON BUTTON
18. HUD CONTROL
19. STANDBY MAGNETIC COMPASS
20. STATION JETTISON SELECT
21. LANDING GEAR AND FLAP POSITION LIGHTS
22. ENGINE FUEL DISPLAY
23. VIDEO RECORD PANEL
24. MULTIPURPOSE COLOR DISPLAY
25. STANDBY ATTITUDE REFERENCE INDICATOR

INSTRUMENT PANEL



26. BLANK PANEL
27. STANDBY AIRSPEED INDICATOR
28. STANDBY ALTIMETER
29. STANDBY VERTICAL VELOCITY INDICATOR
30. ENVIRONMENT CONTROL LOUVERS
- 30A. MAGNETIC TRANSMITTER UNIT
31. LANDING GEAR HANDLE AND WARNING TONE SILENCE BUTTON
32. SELECT JETTISON BUTTON
33. BRAKE ACCUMULATOR PRESSURE GAGE
34. EMERGENCY AND PARKING BRAKE HANDLE
35. ECM PANEL
36. ECM CONTROL PANEL
37. COCKPIT ALTIMETER
38. RUDDER PEDAL ADJUST LEVEL
39. AIRCRAFT BUREAU NUMBER
40. ARRESTING HOOK HANDLE AND LIGHT
41. LANDING CHECKLIST
42. AV COOL SWITCH
43. CAUTION LIGHTS PANEL
44. HYD 1 AND HYD 2 PRESSURE INDICATOR
45. WING FOLD SWITCH
46. SECURE ERASE BUTTON (AFTER AFC443)

F/A-18E AIRCRAFT 166784 AND UP
 F/A-18F AIRCRAFT 166804 AND UP

F/A-18E AIRCRAFT 166420 THRU 166783
 F/A-18F AIRCRAFT 166449 THRU 166803

EFN520-408-1-016

Figure FO-3. Cockpit F/A-18E/F (Lot 26 AND UP) (Sheet 1 of 2)

1. FIRE TEST PANEL
2. GROUND POWER PANEL
3. THROTTLE QUADRANT
4. EXTERIOR LIGHTS PANEL
5. FUEL PANEL
6. FLIGHT CONTROL SYSTEM PANEL
7. VOLUME CONTROL PANEL/ COMMUNICATION PANEL
8. OBOGS FLOW CONTROL
9. ANTI-G VALVE
10. PILOT SERVICES PANEL
- *ANTI-G
- *LOWER HVI CABLE ASSY
- *OXYGEN
11. COMMUNICATION CONNECT
12. MISSION COMPUTER AND HYDRAULIC ISOLATE PANEL
13. ANTENNA SELECT PANEL

NOTE

Radio override switch on F/A-18F aircraft only

14. AUXILIARY POWER UNIT PANEL
15. GENERATOR TIE CONTROL SWITCH
16. ECM DISPENSER BUTTON
17. GROUND POWER DECAL
18. LEFT ESSENTIAL CIRCUIT BREAKERS
19. MANUAL CANOPY HANDLE AND DRIVE
20. HVI STOWAGE/NUCLEAR WEAPON SWITCH
21. DIGITAL MEMORY DEVICE
22. OBOGS MONITOR (CRU-99/A)

LEFT CONSOLE

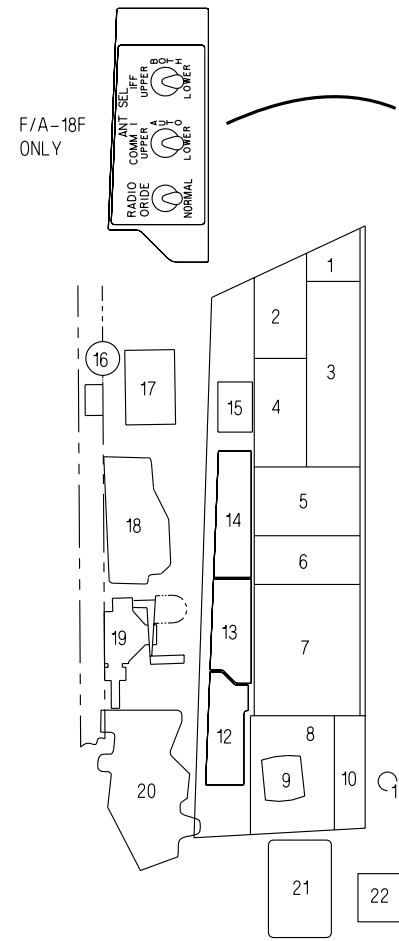
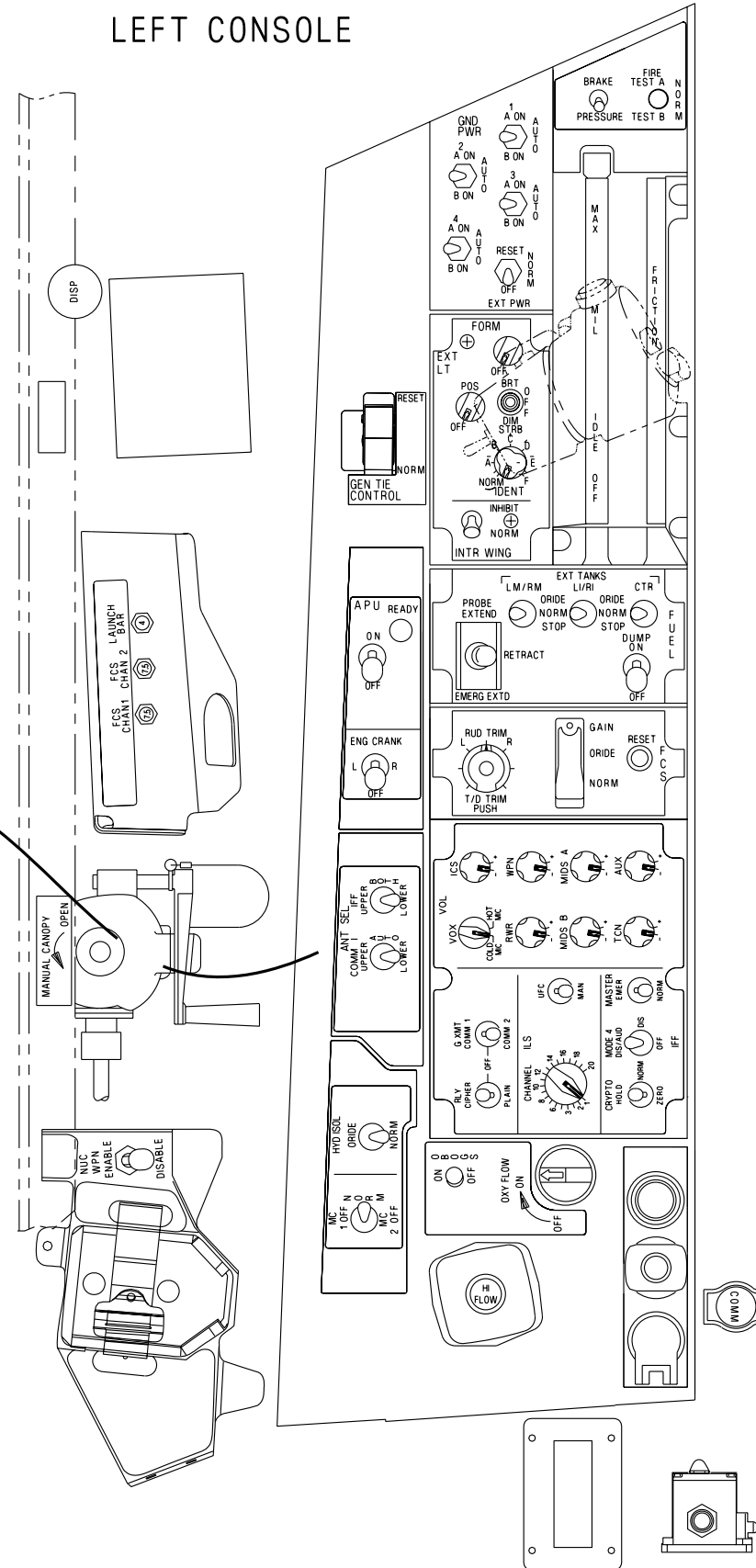

RIGHT CONSOLE

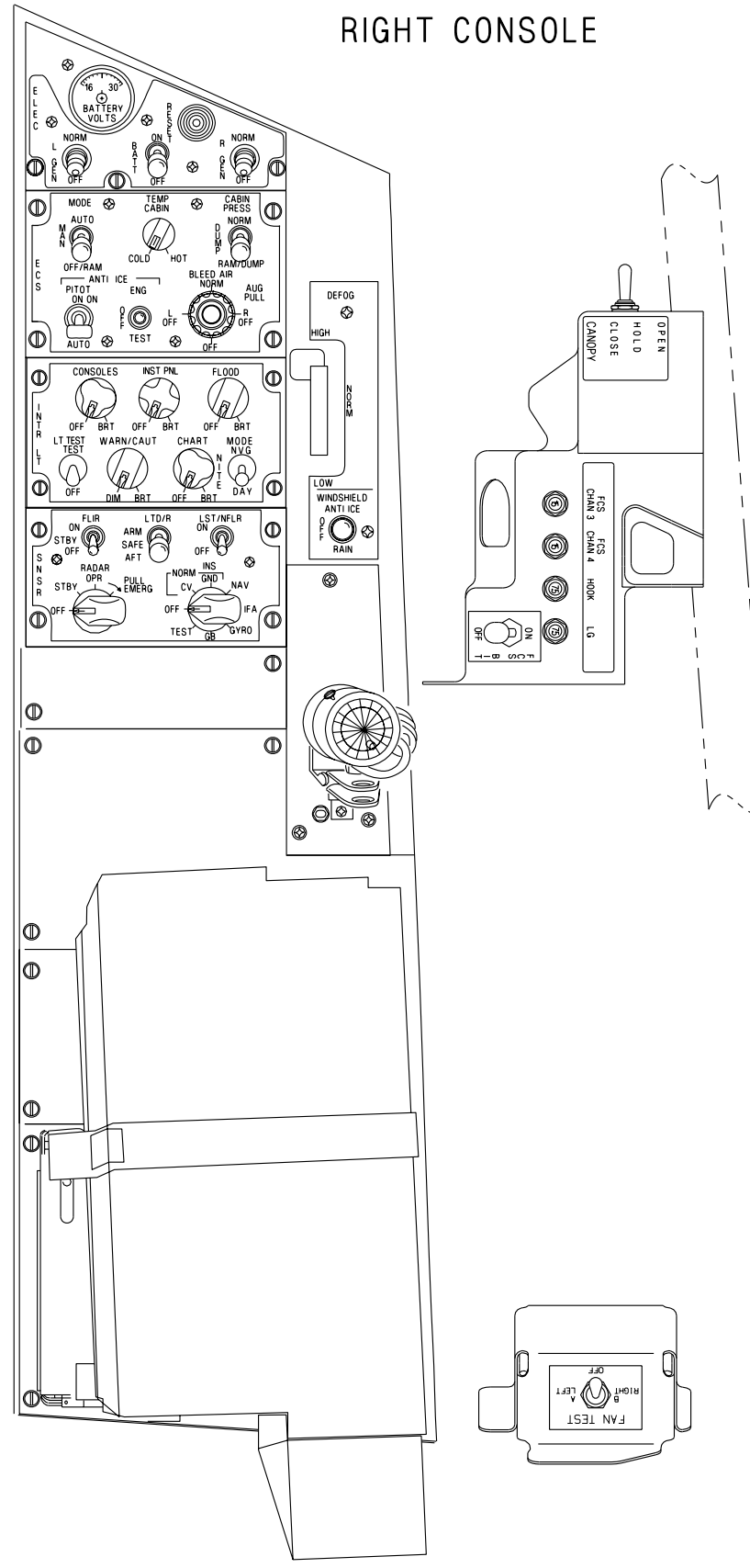

1. ELECTRICAL POWER PANEL
2. ENVIRONMENT CONTROL SYSTEM PANEL
3. INTERIOR LIGHTS PANEL
4. AIR REFUELING STORE PANEL
5. SENSOR PANEL
6. BLANK PANEL
7. KY-58 CONTROL
8. NVG STORAGE
9. FAN TEST SWITCH
10. MAP AND DATA CASE
11. UTILITY LIGHT
12. DEFOG PANEL
13. INTERNAL CANOPY SWITCH
14. FCS BIT SWITCH

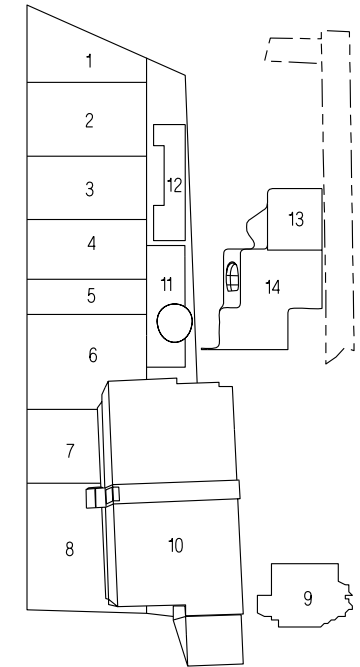

EFN520-408-2-016

Figure FO-3. Cockpit F/A-18E/F (Lot 26 AND UP) (Sheet 2 of 2)

INSTRUMENT PANEL

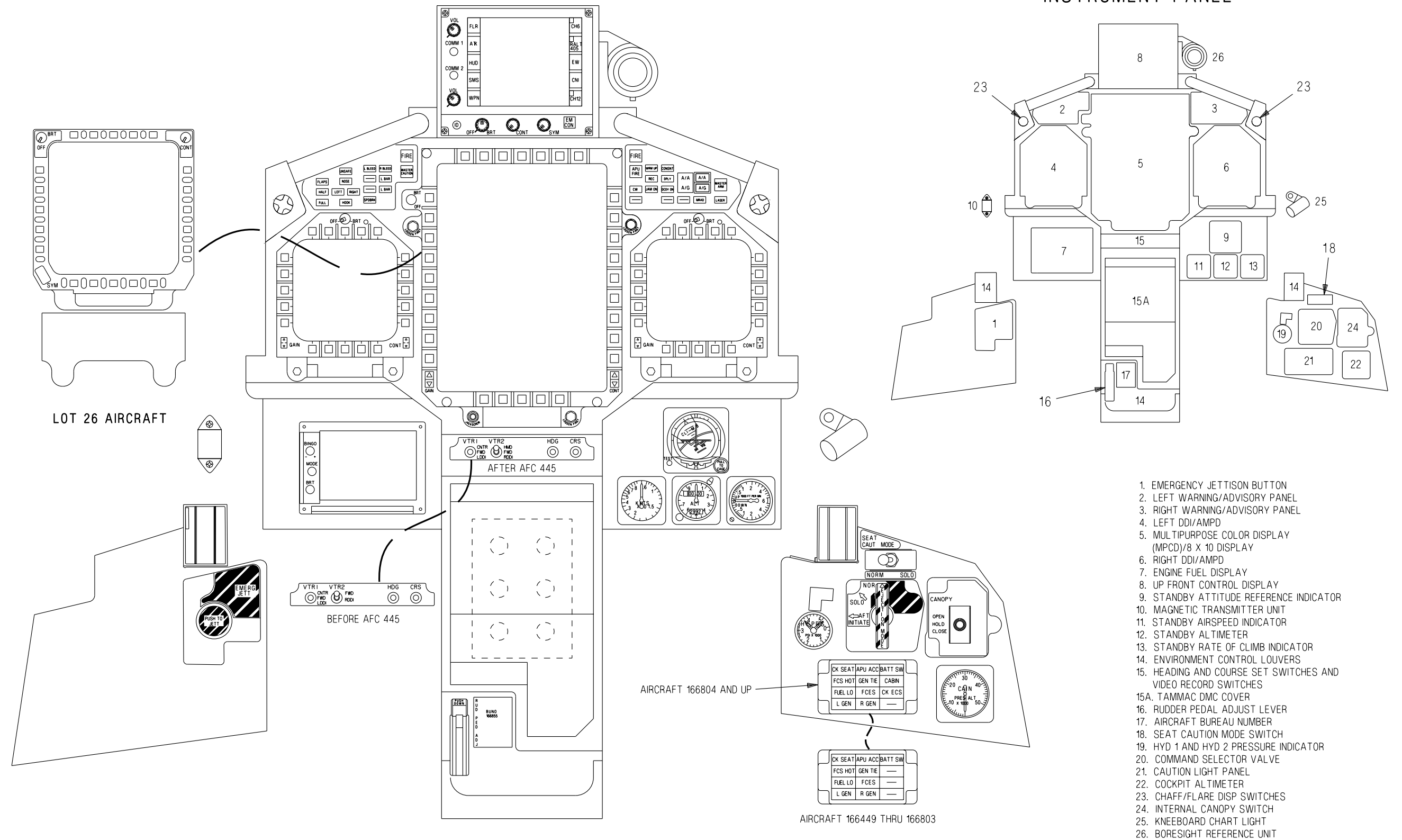

Figure FO-4. Rear Cockpit F/A-18F (Lot 26 AND UP) (Sheet 1 of 2)

EFN520-409-1-016

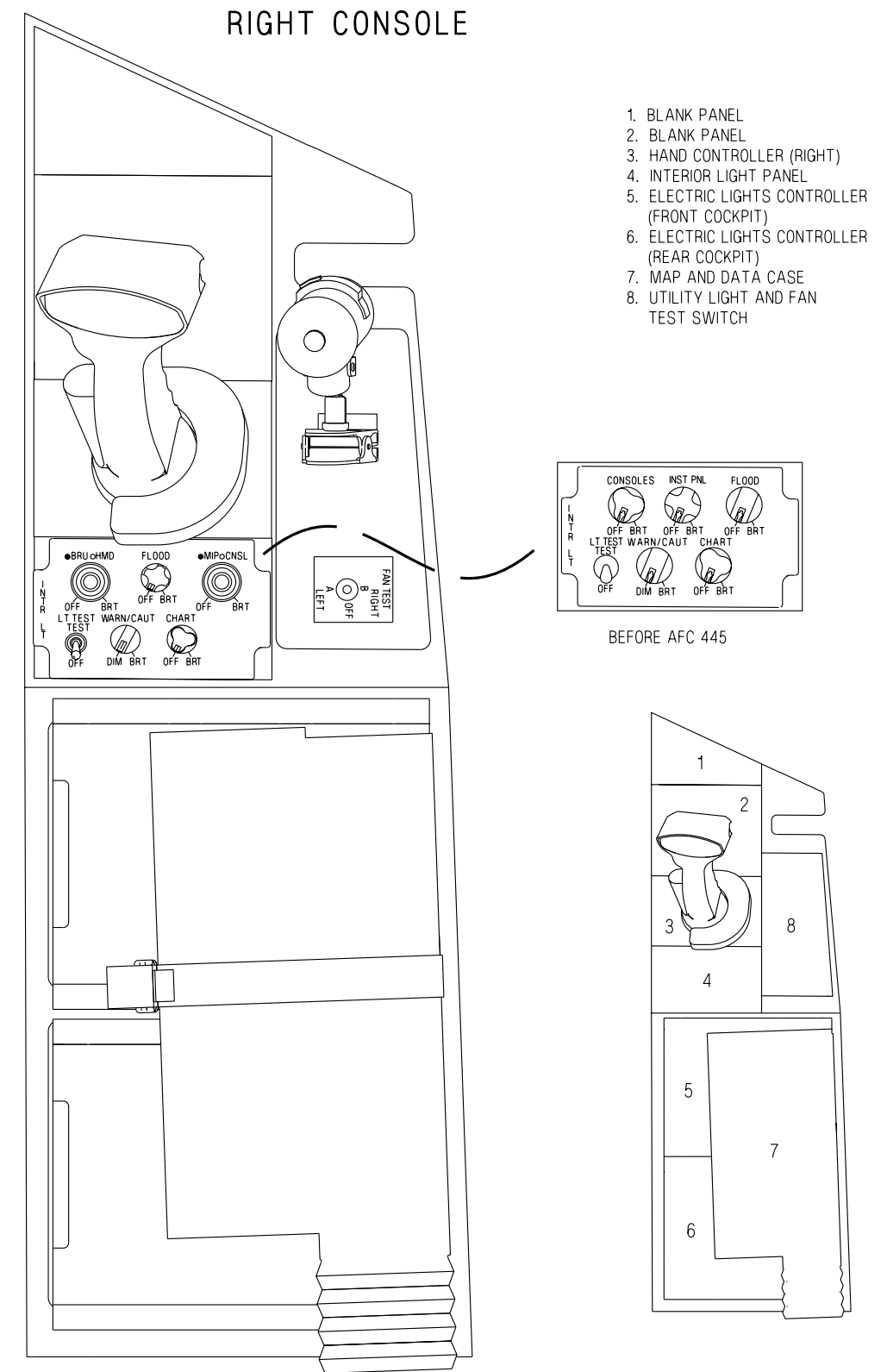
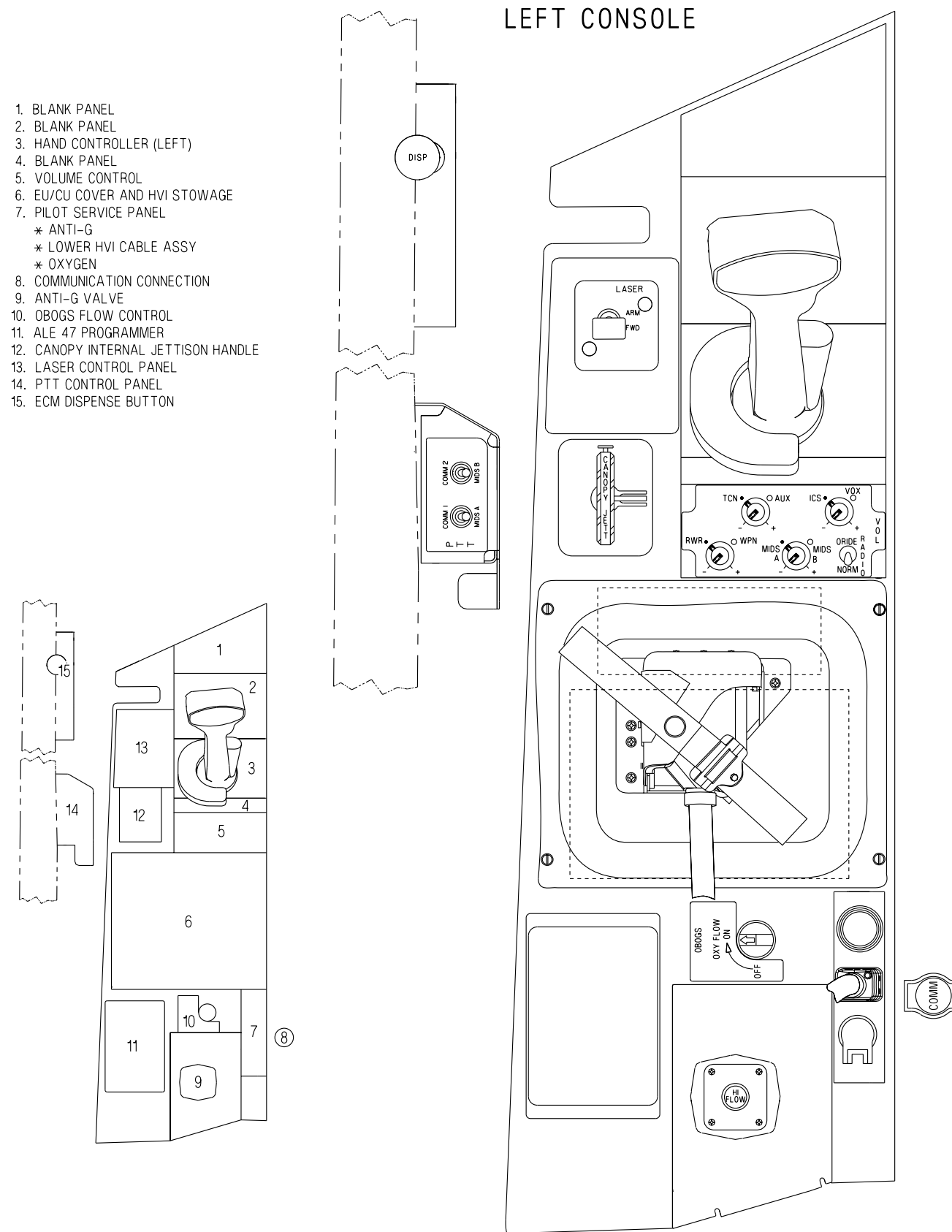
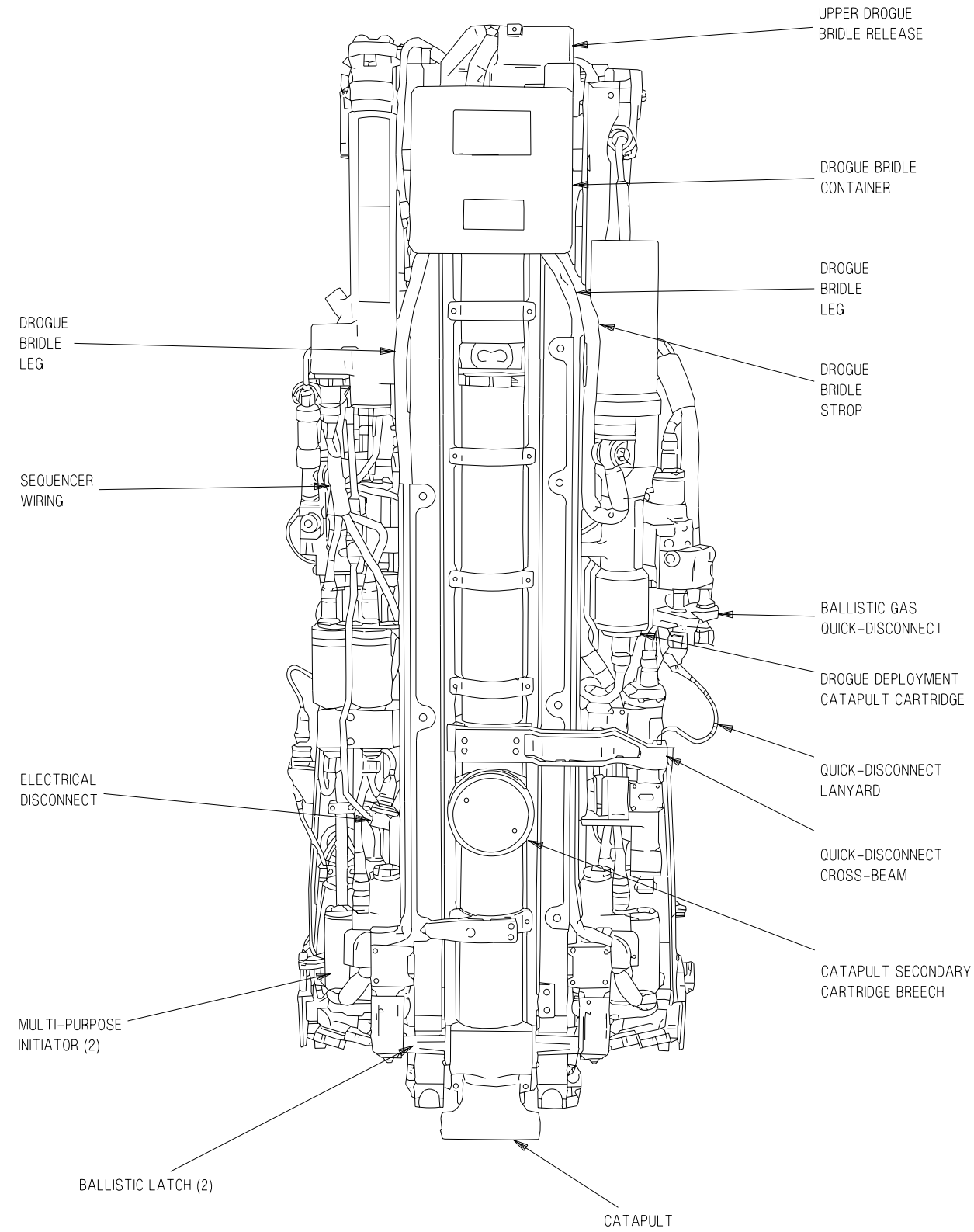

Figure FO-4. Rear Cockpit F/A-18F (Lot 26 AND UP) (Sheet 2 of 2)

RIGHT 115 VOLT AC BUS	ALE-50 CONTROLLER APPROACH LTS (AC) ARM STA 6 THRU 11 ARS POWER AVIONICS GROUND	BATT CHARGER BATT HEATER COCKPIT STROBE LIGHT COOLING FAN	CSC (AC) CVRS (AC) GPS HARM CLC (AC) HUD (AC)	ICE DETECTOR (AC) INTERFERENCE BLANKER JHMCS MC2 POSITION LTS	R AOA HEATER (AC) R ECS DUCT DOOR R PITOT HEATER R TR R WINGFOLD EDU RAD ALT	RDDI(s) RECCE WINDOW DEFOG SMS (AC) STBY ATTITUDE REFERENCE INDICATORS	TACAN TACTS (AC) TK 1 XFR PUMP 26 VAC AUTO XFMR
RIGHT 26 VOLT AC BUS	ADF MAGNETIC AZIMUTH DETECTOR (CH 2 & 4)						
RIGHT 28 VOLT DC BUS	ALE-47 CONTROLLER ALE-47 SEQUENCERS ALE-50 CONTROLLER ARM STA 6 THRU 11 CBN RAM AIR VALVE CK ECS CAUTION LT	COMM 2 CPWS PRESSURE SENSING CSC (DC) CVRS (DC) ECS CONTROLLER HARM CLC (DC)	HUD (DC) HYD 1 PRESSURE INDICATOR HYD 2 PRESSURE INDICATOR	ICE DETECTOR (DC) ICS INTERIOR LIGHTS LGSU LST/CAM	NVG FLOOD LIGHTS R AOA HEATER (DC) R ENG FADEC CH B R PRIMARY BLEED AIR SHUTOFF VALVE	R PROBE HEATER CONTROLLER R WING UNLOCK MOTOR SECONDARY BLEED AIR SHUTOFF VALVE	SMS (DC) TACTS (DC) UNDER COOL SENSOR
ESSENTIAL 28 VOLT DC BUS	APU CONTROL BK PRESS IND BL AIR LK DET ABL AIR LK DET B CABIN EMERG VENT VALVE CK ECS CAUTION LT COMM 1	CROSSFEED VALVE CROSS COOLING VALVE EMER JETT STAs (2, 3, 4, 6, 9, 10) EMER PROBE EXTEND EFD	ENG START CONTROL FCES 1 (EBB) FCES 2 (EBB) FCES 3 (EBB) FCES 4 (EBB)	FCS AV COOL ACTUATOR FEED TK SHUTOFF VALVE FIRE DET LOOP A FIRE DET LOOP B FIRE EXTINGUISHER	FUEL DUMP ICS IFF EMERG L ENG FADEC CH A L ENG OIL PRESSURE INDICATOR PITCH TRIM	R ENG FADEC CH A R ENG OIL PRESSURE INDICATOR R FUEL S/O VALVE R LG PROXIMITY SWITCH	SMS STBY ALTIMETER STBY ARI (FRONT COCKPIT ONLY) UTILITY LIGHTS WARNING/CAUTION LIGHTS
LEFT 28 VOLT DC BUS	ADF ALE-47 SEQUENCERS ALR-67 (DC) ANTI-SKID CONTROL UNIT ANTENNA SELECT ANAV BCN AUGMENTATOR	BUS TIE CK ECS CAUTION LT DATA LINK DBFSS DFIRS POWER DIG MAP SET (DC) ECM COOLING ENG IDL/A-B LKOUT	EXT FUEL TANK CONTROL EXT LTS CONTROL FCCB ASYM BRK DC FUEL LOW LEVEL WARNING FUEL TK PRESS VALVES	FUEL TRANSFER VALVES GND PWR CONTROL GUN HOOK LIGHT HOSE JETTISON HYD ISOL ORIDE ILS (DC)	L BLEED AIR CONT VALVE (PRIM) L ENG FADEC CH B L PROBE HEATER CONTROL L WINGFOLD UNLOCK MOTOR	LAUNCH BAR CONTROL VALVE LG CONTROL VALVES MEMORY UNIT (MU) MSTR ARM NWS CONTROL VALVE OBOGS CONTROL	PROBE CONTROL RADAR (DC) SEAT ADJ (FRONT & REAR) THROTTLE BACKDRIVE WSHLD ANTI-ICE REMOVAL
LEFT 115 VOLT AC BUS	ALQ-165 ASPJ ALR-67 (AC) ARM STA 1 THRU 5 DIG MAP SET (AC)	EMERG AV COOLING FAN FORMATN LTS IFF	ILS (AC) INS L AOA HTRS (AC) L ECS DUCT DOOR	L PITOT HTR L TR L WING FOLD EDU	LCS FAN LCS PUMP LDDI(s) LDG/TAXI LT	MC1 MPCD(s)/UFCD(s) OBOGS CONCENTRATOR	PROBE LT RADAR (AC) STROBE LTS
MAINTENANCE BUS	APU PRIM CANOPY FCS KEEP ALIVE CH 1 THRU 4	GEN TIE LOGIC INS KEEP ALIVE LADDER DEPLOY	SDC SMP (CODE CHECK) VENT TANK WET LIGHT				

Figure FO-5. Electrical Bus Power



EFN520-219-2-001
Figure FO-6. Ejection Seat (Sheet 1 of 2)

Ejection Seat

SJU-17 (V)1/A, 2/A AND 9/A
 SJU-17A (V)1/A, 2/A AND 9/A

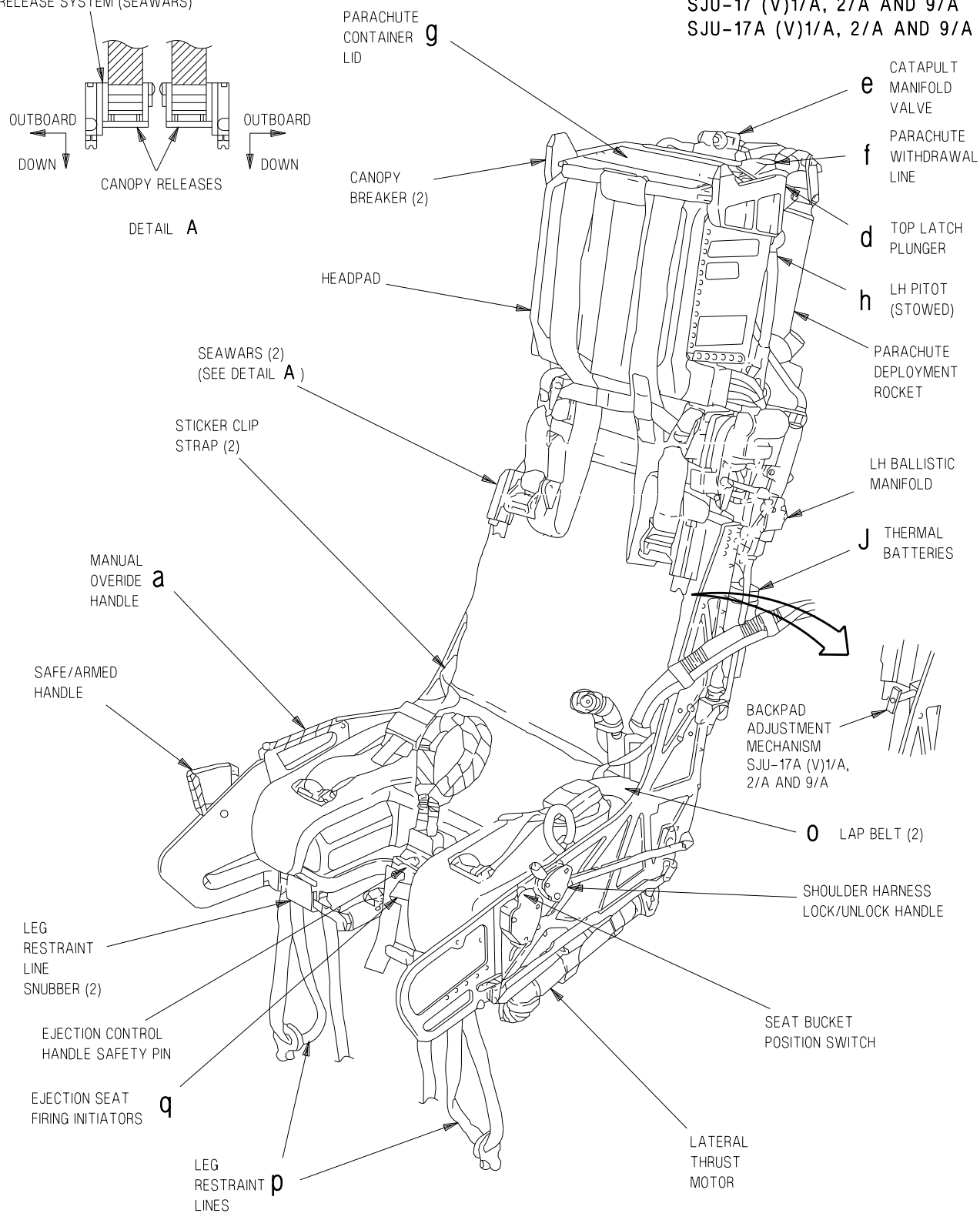
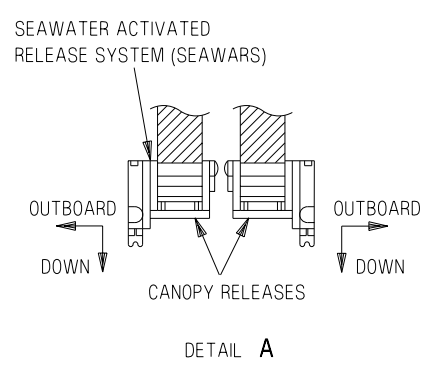
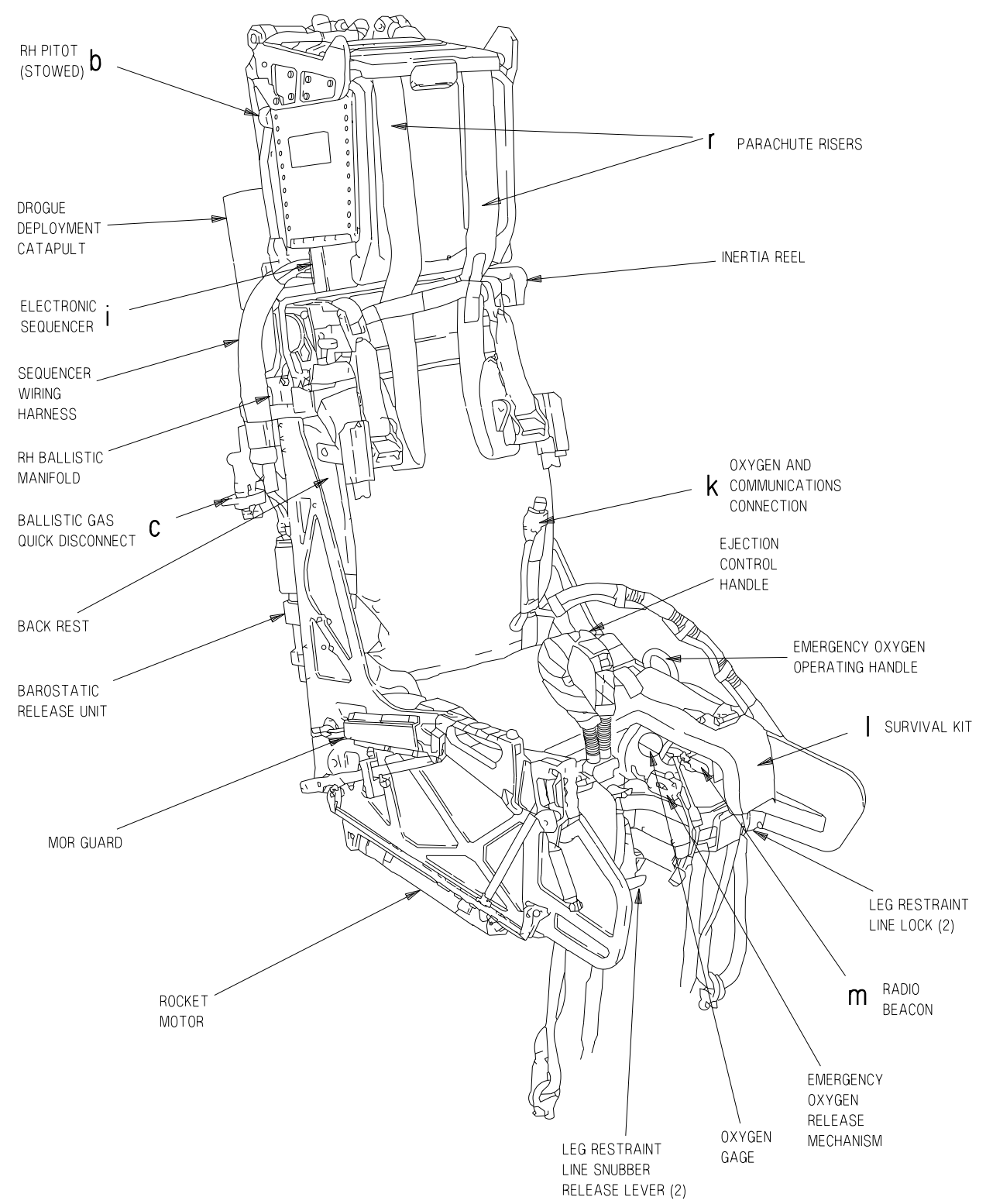

Figure FO-6. Ejection Seat (Sheet 2 of 2)

EFN520-219-1-007

FUEL SYSTEM SCHEMATIC
(FEED, TRANSFER, GRAVITY SYSTEMS)

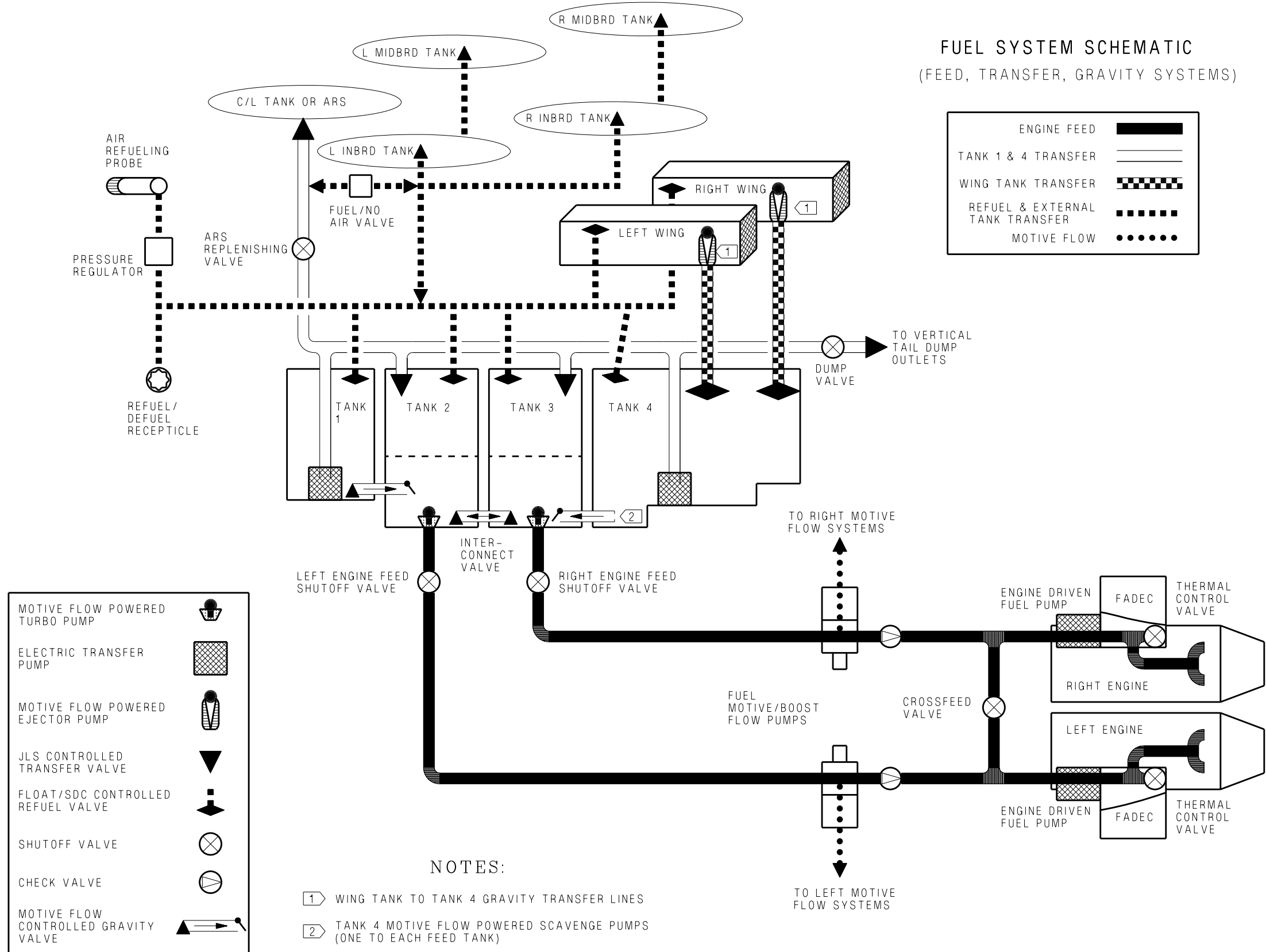
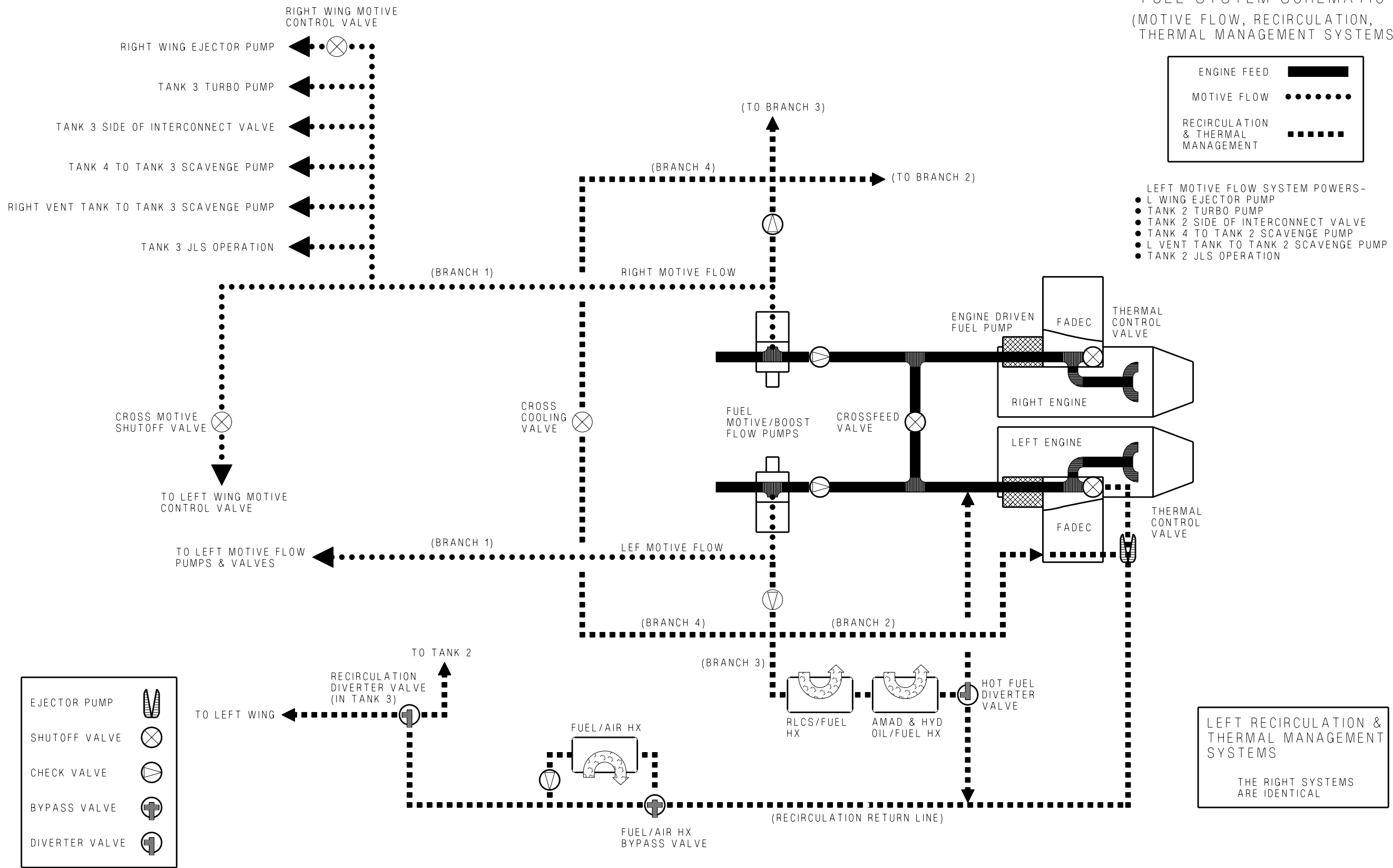

Figure FO-7. Fuel System (Sheet 1 of 2) EFN520-38-1-011

FUEL SYSTEM SCHEMATIC
(MOTIVE FLOW, RECIRCULATION,
THERMAL MANAGEMENT SYSTEMS)



EFN520-38-2-004

Figure FO-7. Fuel System (Sheet 2 of 2)
FO-27 (Reverse Blank) ORIGINAL

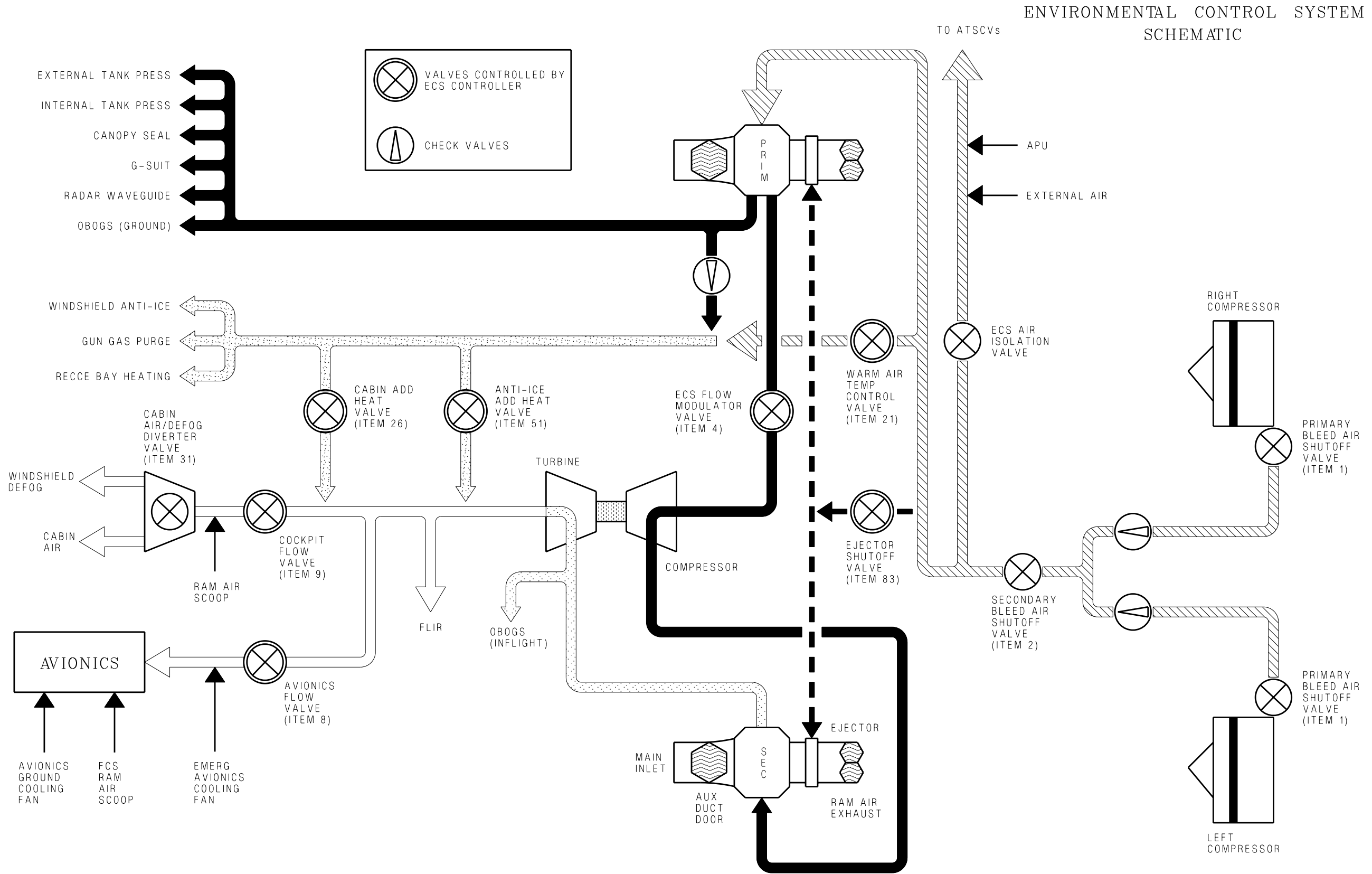

EFN520-43-1-001

Figure FO-8. Environmental Control System

ALPHABETICAL INDEX

Page
No.

1

10,000 Feet Checks.....	III-10-24, III-10-31, III-10-34
10,000 Feet to Landing.....	III-10-28
10,000 Foot Checks.	III-7-33

2

24.2.4 Navigation System BIT.	VII-24-23
------------------------------------	-----------

5

5-Wet (4-EFT and ARS) Loading Handling Qualities.	IV-11-6
5-Wet Loading with 5-Wet FCC Gains not Set.	IV-11-6

8

8 x 10 Display.....	I-2-151
8 x 10 Display Initiated BIT.	I-2-199

A

A/A Weapon Select Switch.....	I-2-88
ABLIM - Afterburner Limiting Function.....	I-2-5
ABORT	V-14-2, V-18-3
Aborted Takeoff.	III-9-1
AC Electrical Power.....	I-2-30
Acceleration Limitations.	I-4-5
ACI Configuration Check.	I-2-140
ACL Mode 1.....	VII-24-66
ACL MODE 1 AND 1A APPROACHES.....	III-8-15
ACL Mode 1A.	VII-24-70
ACL Mode 2.....	VII-24-70
ACL MODE 2 APPROACH	III-8-18
ACL Mode Displays.....	VII-24-61
ACL Mode Operation.	VII-24-65
ACL Option (HSI Format).....	VII-24-9
Adaptability/Flexibility.	IX-28-1
ADF (AUTOMATIC DIRECTION FINDER).....	VII-24-51
Aerobraking Technique.	III-7-40
AFCS - AUTOMATIC FLIGHT CONTROL SYSTEM.....	I-2-84
AFCS Mode Deselection.	I-2-86
AFCS Mode Selection.....	I-2-84
AFCS Related Caution and Advisories.	I-2-87
Aft Cooling Fan Shutoff Valve.	I-2-98
Aft UFCO MUX FAIL.....	I-2-168

	Page No.
After Landing.....	III-7-43
AFTER LANDING.....	VI-21-2
After Landing Checks.....	III-7-43, III-10-29
After Takeoff Checks.....	III-7-33, III-10-21
AFTERBURNER FAILURE.....	V-15-1
A/G Weapon Release Button.....	I-2-90
AGI (Armament Gas Ingestion) Protection.....	I-2-5
AHRS Failure Flying Qualities.....	IV-11-17
AILERON HINGE FAILURE - SUSPECTED, INBOARD.....	V-15-47
AIR COMBAT MANEUVERING.....	IV-11-7
Air Conditioning System (ACS) Pack.....	I-2-97
Air Data Function.....	I-2-72
Air Refueling Checklist.....	III-9-5
AIR REFUELING (RECEIVER).....	III-9-5
Air Refueling Store (ARS).....	III-9-9
AIR REFUELING (TANKER).....	III-9-9
AIRBORNE CHECKS.....	III-7-33
Airborne HMD Accuracy Check with CATM/AIM-9X.....	III-9-23
Airborne HMD Accuracy Check with Radar.....	III-9-23
AIRBORNE HMD ACCURACY CHECKS.....	III-9-22
Aircraft (A/C) Programming.....	VII-24-35
Aircraft Attitude Data.....	I-2-215
AIRCRAFT DESCRIPTION.....	I-1-1
Aircraft Gross Weight.....	I-1-2
AIRCREW RESPONSIBILITIES BY FLIGHT PHASE.....	IX-28-3
Airspeed during Ejection.....	V-17-2
Airspeed Limitations.....	I-4-1
Air-to-Air Gun Tracking.....	IV-11-7
AJ MENU From Fixed Frequency COMM Sublevel.....	VII-23-13
AJ MENU From Have Quick COMM Sublevel.....	VII-23-20
AJ MENU From SINCGARS COMM Sublevel.....	VII-23-21
ALE-47 Advisories.....	I-2-185
ALE-47 Countermeasures Dispensing Set.....	I-2-185
ALE-47 DISP Switch.....	I-2-95
ALE-50 BIT Anomalies.....	I-2-185
ALE-50 Decoy Dispensing Set.....	I-2-185
Alert Five Launch.....	III-9-21
ALERT Indicators.....	III-9-11
ALERT SCRAMBLE LAUNCH PROCEDURES.....	III-9-20
Alignment Exit.....	I-2-214
Alignment Verification.....	I-2-214
All Equipment.....	I-2-193
ALT Selector Switch.....	I-2-157
Altitude Required for Recovery (ARR).....	I-2-134
AMAD - Airframe Mounted Accessory Drive.....	I-2-27
AMAD Related Cautions.....	I-2-29
AMU Maintenance Format Options and Display Information.....	I-2-181
AMU/PC Cards Cautions and Advisories.....	I-2-184

	Page No.
ANAV.	VII-24-23
ANGLE OF ATTACK (AOA) FAILURE	V-15-44
Angle Of Attack Indexer.	I-2-141
ANTI SKID Switch.....	I-2-53
Anti-g System.....	I-2-104
Anti-Jam Operation.....	VII-23-13
Anti-skid BIT and the ANTISKID Caution.	I-2-53
Anti-skid System.....	I-2-51
AOA Indexer Control Knob.	I-2-157
AOA Limit Display.	I-4-5
AOA Limitations - Flaps AUTO.....	I-4-5
AOA PROBE DAMAGE OR BINDING.....	V-15-45
AOA PROBE SELECTION	V-15-46
AOA Probes.	I-2-72
AOA Warning Tone.....	I-2-76
Applicable Publications.	X-30-4
Approach.	III-9-6, III-9-19, IX-29-5
Approach Lights.	I-2-39
Approaches.	VI-19-2
Approach/Landing (*).....	X-30-4
APU - Auxiliary Power Unit.	I-2-28
APU Fire Extinguishing System.....	I-2-113
APU FIRE Light.....	I-2-112
APU FIRE LIGHT	V-18-1
APU READY Light.....	I-2-28
APU Switch.....	I-2-28
ARC-210/DCS.	VII-23-28
Area.	X-30-2
Arrested Landing.	III-9-19
ARRESTED LANDING AND EXIT FROM THE LANDING AREA.....	III-8-20
Arresting Gear Types.	V-16-13
Arresting Hook System.	I-2-58
ARRESTMENT - FIELD	V-16-13
Arrestment - Long Field.	V-16-14
Arrestment - Short Field.....	V-16-14
Arrestment and Exit From the Landing Area.....	III-8-23
Arrestment Decision.	V-16-14
ARS DROGUE Caution.....	III-9-12
ARS Hose Fails to Retract.	V-15-25
ARS Hydraulic Pressure Light.	V-15-25
ARS Interior Checks -	III-9-13
ARS Jettison.....	III-9-18
ARS Limitations.....	I-4-17
ARS Limitations.....	III-9-18
ARS MALFUNCTIONS.....	V-15-25
ARS Refueling Hose Jettison.....	V-15-25
ARS (Tanker) Procedures.....	III-9-12
Assertiveness.....	IX-28-1

	Page No.
Asymmetric Stores Landings.....	III-7-43
ATC - Automatic Throttle Control.....	I-2-10
ATC Approach Mode Technique.....	III-8-14
ATC Approaches.....	III-7-38
ATC Automatic Disengagement.....	I-2-11
ATC Disengagement.....	I-2-11
ATC Engagement.....	I-2-10
ATC Related Cautions.....	I-2-11
ATFLIR Limitations.....	I-4-19
ATS Air Sources.....	I-2-28
ATS Protection.....	I-2-29
ATT Selector Switch.....	I-2-157
AUG PULL.....	I-2-29, I-2-101
AUTO BIT.....	I-2-196
AUTO Option (HSI Format).....	VII-24-8
AUTO Sequential Steering.....	VII-24-44
AUTO Update.....	VII-24-39
Automatic Battery Cutoff.....	I-2-33
Automatic Carrier Landing Mode.....	VII-24-59
Automatic Erase.....	I-2-145
AUX REL Switch.....	I-2-129
AV COOL Switch.....	I-2-63, I-2-105
Avionics BIT.....	I-2-186
Avionics Cooling Fans.....	I-2-98
AVIONICS SUBSYSTEM.....	I-2-142

B

Backpad Adjustment Mechanism (SJU-17A (V)1/A, 2/A, and 9/A).....	I-2-126
BACKUP ATTITUDE AND NAVIGATION SYSTEM.....	VII-25-2
Backup Attitude and Navigation System Controls and Indicators.....	VII-25-3
Backup Erase Controller.....	I-2-146
BACKUP FREQUENCY CONTROL.....	VII-25-6
Backup Heading Mode Control.....	VII-25-5
Backup HSI Display.....	VII-25-1
Backup HUD Display.....	VII-25-1
Backup Navigational Information on Backup HUD.....	VII-25-2
BAL Control Knob.....	I-2-157
Balanced Cruise Formation.....	III-9-4
BALT - Barometric Altitude Hold.....	I-2-86
Barometric (BARO)/Radar Low Altitude Warning Programming.....	VII-24-35
BARRICADE ARRESTMENT.....	V-16-14
Basic Autopilot.....	I-2-86
BATT SW Caution and Caution Light.....	I-2-33
BATT Switch.....	I-2-33
Battery.....	I-2-32
Battery Gauge.....	I-2-33
Before Engine Shutdown Checks.....	III-7-45, III-10-29
Before Entering Cockpit.....	III-7-8

	Page No.
BEFORE ENTERING COCKPIT	VI-22-1
Before Landing.	III-9-17
Before Takeoff.	VI-19-1
Before Takeoff Checks.	III-7-30
Before Taxi.	III-8-21
BEFORE TAXI	VI-22-1
BEFORE TAXI CHECKS	III-7-23
Before Taxi Checks.	III-8-2, III-10-15, III-10-32
BIT Initiation.....	I-2-190
BIT Recording On The Memory Unit.	I-2-213
BIT Top Level Display.....	VII-23-32
BITE Flag Indicator.	III-9-11
BIT-STATUS MONITORING SUBSYSTEM	I-2-186
Black Level Control Knob.....	I-2-156
BLEED AIR Knob.....	I-2-96
Bleed Air Leak Detection (BALD) System.	I-2-114
Bleed Air Leak Detection System Test.	I-2-114
Bleed Air Shutoff Valves.....	I-2-95
Bleed Air Subsystem.....	I-2-96
BLIN Codes.	I-2-201
BLOCK NUMBERS.....	I-1-4
Boarding Ladder.....	I-2-118
Bolter.....	III-9-20
Boresight Reference Unit (BRU).....	I-2-208
Brake Accumulator Pressure Gauge.	I-2-45
BRAKE FAILURE/EMERGENCY BRAKES	V-13-4, V-18-3
Braking Technique.....	III-7-40
Breathing Regulator.	I-2-109
Briefing.....	III-6-1
BRIEFING/DEBRIEFING	III-6-1
Brightness and Contrast Controls.	I-2-150
Brightness Knob - AMCD Aircraft.	I-2-147
Brightness Selector Knob - Non-AMCD Aircraft.	I-2-147
BRK PRESS Switch.	I-2-45
BRT Control Knob - Non-AMCD Aircraft.	I-2-147
Built-In Test (BIT).....	I-2-211

C

CABIN Caution Light.....	I-2-103
Cabin Louvers/Foot Air Outlet.....	I-2-102
CABIN PRESS Switch.....	I-2-103
Cabin Pressure Altimeter.	I-2-103
Cabin Pressurization.	I-2-103
Cabin Pressurization Warning System (CPWS).....	I-2-103
CABIN TEMP knob.....	I-2-102
Cage/Uncage Button.	I-2-91
CAINS and GPS.....	VII-24-23
CANOPY JETT Handle.	I-2-118

	Page No.
CANOPY JETT Handle (F/A-18F).....	I-2-118
Canopy Jettison System.....	I-2-118
Canopy Operation.....	I-2-116
Canopy Switch (External).....	I-2-116
CANOPY Switch (Internal).....	I-2-116
Canopy System.	I-2-115
CAS Operating Modes.	I-2-64
Catapult Endspped Requirements.....	III-8-11
Catapult Hook-Up.	III-8-9, III-8-21
Catapult Launch.....	III-8-10, III-8-21
Catapult Launch Flyaway Characteristics.	III-8-12
Catapult Suspended.....	III-8-11, III-8-23
Catapult Trim.	III-8-3
Cautions and Advisories.....	I-2-190, VII-23-32
Cautions/Advisories.	I-2-208
Ceiling/Visibility Requirements.	II-5-3
CFIT Conditions.....	I-2-133
CFIT Protection Levels.	I-2-132
CFIT Warnings.	I-2-135
CG Limitations.	I-4-1
Chaff/Flare Dispense Switch.	I-2-94
Chaff/Flare/ALE-50 Dispense Switch.....	I-2-90
CHART Light Knob.	I-2-41
Ciphered Reception.	VII-23-23
Ciphered Relay Mode.....	VII-23-24
Ciphered Transmission.....	VII-23-23
Circuit Breakers.	I-2-36
CK ECS Caution Light.....	I-2-104
CK SEAT Caution.....	I-2-122
CK SEAT Caution (F/A-18F).....	I-2-127
Climb.....	III-7-33
Climb/Cruise.....	X-30-4
Closed Book Examination.....	X-30-2, X-30-3
Coarse Alignment.	I-2-214
Cockpit Controls and Displays.	I-2-146
Cockpit Displays Initiated BIT.....	I-2-196
COCKPIT SMOKE, FUMES, OR FIRE.....	V-15-16, V-18-4
COCKPIT TEMPERATURE HIGH.....	V-15-15
Cockpit Unit (CU).....	I-2-208
COMM 1 and 2 Channel Knobs.....	I-2-170
COMM 1 and 2 Operation.	VII-23-8
COMM 1 and 2 VOL (Volume) Control Knobs.....	VII-23-4
COMM 1 and COMM 2 Channel Select Knobs.....	VII-23-4
COMM 1 and COMM 2 Volume Controls.	VII-23-28
COMM 1 ANT SEL (Antenna Select) Switch.	VII-23-7
COMM BIT Sub-Level Display.	VII-23-32
COMM Control Panel.....	VII-23-6
COMM Foot Pedal Switches (F/A-18F).....	VII-23-7

	Page No.
COMM Keypad Options and Scratchpad Display.....	VII-23-5
COMM Sublevel - Guard and Cue Presets.	VII-23-9
COMM Sublevel - Manual Preset.	VII-23-10
COMM Sublevel - Presets 1 Thru 20 (Anti-Jam).	VII-23-18
COMM Sublevel - Presets 1 Thru 20 (Fixed Frequency).....	VII-23-12
COMM Sublevel - Ship Maritime Preset.	VII-23-9
COMM Sublevel Selection.	VII-23-8
COMM Throttle Switch.....	VII-23-7
COMM Touch Option/Displays.	VII-23-5
COMM VOL Knobs.....	I-2-170
Communication.	IX-28-1
COMMUNICATION-NAVIGATION-IDENTIFICATION INTERFACE.....	VII-23-47
COMMUNICATIONS.....	IX-29-1
Communications.	X-30-4
CONCEPT.....	X-30-1
Conditionally Qualified.....	X-30-1
CONFIG Display.....	I-2-202
CONFIG Display Country ID Code.	I-2-202
Configuration Check.	I-2-211
CONSOLES Lighting Knob.....	I-2-41
CONT Control.....	I-2-148
Contact.	III-9-7
Control Augmentation System (CAS).....	I-2-65
CONTROLLABILITY CHECK.....	V-15-22
Controlled Flight Into Terrain (CFIT) Protection Systems.	I-2-131
Countdown Time (CD).....	VII-24-36
COUNTERMEASURES DISPENSING SYSTEM.....	I-2-185
Coupled Auto Sequential Steering.....	VII-24-45
Coupled Data Link Modes.	I-2-87
Coupled TACAN Steering.....	VII-24-54
Coupled Waypoint / OAP Steering.....	VII-24-41
CPL - Coupled Steering Modes.	I-2-87
CREW BRIEFING.....	IX-29-1
Critical Area/Sub-area.	X-30-2
CRITICAL SKILLS OF AIRCREW COORDINATION.....	IX-28-1
Critique.....	X-30-5
Crossfeed Valve.....	I-2-12
Crosswind Landings.....	III-7-42
Crosswind Takeoff.	III-7-33
CRS Select Switch.	VII-24-10
CRS Set Switch.....	I-2-147, I-2-165
Cruise.....	III-7-34, IX-29-4
Cruise Check.....	III-7-34
Crypto Key Options.....	VII-23-28
CRYPTO Switch.....	I-2-144, VII-23-47
CURRENCY REQUIREMENTS.....	II-5-2
CV Alignment Modes.	VII-24-12
CV MAN (Manual) Alignment.	VII-24-13

CV RECOVERY MATRIX	V-16-15
CVRS - Cockpit Video Recording System.	I-2-171
CVRS Control Switches.....	I-2-172
CVRS Mode Switch.....	I-2-173
CVRS RDCR ON Light.....	I-2-173
CVRS Video Tape Recorders/Solid State Recorder (SSR).....	I-2-172

D

Data Entry Using the Shifted Keypad.....	I-2-167, VII-24-78
DATA LINK SYSTEM.....	VII-24-59
DATA Option (HSI Format).....	VII-24-7
Data Sources.....	I-2-132
Date (DATE).....	VII-24-37
Day ID Light.	I-2-40
Day ID Test Switch.....	I-2-40
DAY OPERATIONS	III-8-1
DBFS - Dry Bay Fire Suppression System.	I-2-115
DC Electrical Power.	I-2-32
DCS - Avionics Subsystem.	VII-23-31
DCS COMSEC (Communications Security).	VII-23-28
DDI Controls.	VII-23-28
DDI Formats on MPCD.....	I-2-151
DDI Pushbuttons.	I-2-148
DDI/HUD Initiated BIT.....	I-2-196
DDIs.....	I-2-147
Debriefing.	III-6-4
DEBRIEFING.....	IX-29-7
Decision-Making.....	IX-28-1
DEFINITION	IX-28-1
Definitions.....	X-30-1
DEFOG Handle.....	I-2-102
DEGRADED MODE HANDLING QUALITIES.....	IV-11-11
DEGRADED SYSTEMS	VI-19-2
Departure.....	IX-29-3
Departure Characteristics.	IV-11-8
Departure from Controlled Flight.	V-15-19
Departure Recovery.....	V-15-19
Departure Resistance.	IV-11-8
Departures with Lateral Weight Asymmetries.....	V-15-19
Descent.....	VI-19-2
Descent/Penetration.	III-7-35
Descent/Penetration Checks.....	III-7-35
DESCENT/RECOVERY	VI-21-2
Design Limit-g.....	I-2-69
Designation.....	VII-24-47
Designation (DSG) Update.....	VII-24-38
Designator Controller (DC).....	I-2-92
Designator Controller (DC) Assignment Switch.....	I-2-92

	Page No.
DFIRS - Deployable Flight Incident Recorder Set.....	I-2-186
DIGITAL COMMUNICATION SYSTEM (DCS)	VII-23-27
Digital Imaging Processor (DIP).....	I-2-178
Dimming and Test Functions.	I-2-130
Dimming (BRT/DIM) Switch.	III-9-11
Disengagement.....	III-9-7
DISPENSER Switch.....	I-2-185
DISPLAY MALFUNCTION - AMCD AIRCRAFT	V-15-19
DISPLAY MALFUNCTION - NON-AMCD AIRCRAFT	V-15-18
DITCHING	V-17-4
D/L Option (HSI Format).....	VII-24-9
DOUBLE TRANSFORMER-RECTIFIER FAILURE.....	V-15-10
DOWNLOCK ORIDE Button.....	I-2-47
Drogue Extension.....	III-9-15
Drogue Retraction.	III-9-17
DUAL AOA FAILURE ON TAKEOFF.	V-15-47
DUAL L BLEED and R BLEED WARNING LIGHTS//L/R ATS CAUTION	V-18-1
Dual Midboard with Outboard Stores Handling Qualities.....	IV-11-7
DUAL MISSION COMPUTER (MC) FAILURE - AMCD AIRCRAFT	V-15-19

E

ECS - ENVIRONMENTAL CONTROL SYSTEM	I-2-95
ECS AUTO Mode.....	I-2-99
ECS Auxiliary Duct Doors.	I-2-97
ECS MAN Mode.....	I-2-100
ECS MODE Switch.	I-2-101
ECS OFF/RAM Mode.	I-2-100
ECS Operating Modes.	I-2-99
ECS Related Warnings, Cautions, and Advisories.....	I-2-106
ECS RESET.....	I-2-105
ECS RESET and AV COOL Switch.....	I-2-105
EFD - Engine Fuel Display, Engine Parameters.....	I-2-7
EFD - Engine Fuel Display, Fuel Parameters.....	I-2-21
EFD Initiated BIT.....	I-2-199
Effects of Light.	III-9-18
Effects on Vision.....	III-9-18
EJECTION.....	V-17-1
Ejection Control Handle.	I-2-122
EJECTION MODE Handle (F/A-18F).	I-2-126
Ejection Procedures.....	V-17-4
Ejection Seat.....	I-2-119
Ejection Seat Restrictions.....	V-17-1
Ejection Seat SAFE/ARMED Handle.	I-2-122
Ejection Seat System (F/A-18F).....	I-2-126
Elapsed Time (ET).	VII-24-36
Electrical Fault Protection Circuitry.	I-2-30
ELECTRICAL POWER SUPPLY SYSTEM	I-2-30
Electrical RESET Button.....	I-2-30

Electrical System Cautions and Caution Lights.....	I-2-36
Electronic Attitude Display Indicator (EADI).....	I-2-149
Electronic Unit Failure.....	I-2-218
Electronics Unit (EU).....	I-2-208
EMCON - Emission Control Pushbutton.....	VII-23-6
EMCON Pushbutton.....	I-2-171
EMERG BRK Handle (Front Cockpit).....	I-2-55
EMERG BRK Handle (Rear Cockpit Lots 21 thru 25).....	I-2-55
EMERG JETT Button.....	I-2-128
EMERG LDG GEAR Handle (F/A-18F).....	I-2-48
EMERGENCIAS.....	IX-28-4
Emergencies.....	IX-29-7
Emergency.....	X-30-2
Emergency Braking.....	I-2-54
EMERGENCY CATAPULT FLYAWAY.....	V-14-1, V-18-3
EMERGENCY EGRESS.....	V-13-3
EMERGENCY EQUIPMENT.....	I-2-127
Emergency Fuel Transfer.....	III-9-16
Emergency High Gain NWS.....	I-2-50
Emergency Instrument Lights.....	I-2-41
Emergency Jettison.....	I-2-127
Emergency Landing Gear Extension.....	I-2-47
Emergency Oxygen.....	I-2-110
EMERGENCY TANKER DISENGAGEMENT.....	V-15-26
Emergency/Malfunction Procedures (*).	X-30-4
Emission Control Button.....	VII-23-46
ENG ANTI ICE Switch.....	I-2-6
ENG CRANK Switch.....	I-2-6, I-2-29
ENG Display.....	I-2-9
Engine Anti Ice.....	I-2-5
Engine Anti-Ice Advisories.....	I-2-6
Engine Anti-Ice Related Cautions and Advisories.....	I-2-6
ENGINE CAUTIONS.....	V-18-2
Engine Controls and Displays.....	I-2-6
ENGINE FAILS TO START/HUNG START.....	V-13-1
Engine Feed System.....	I-2-12
Engine Functional Checks.....	III-10-1
Engine Idle Schedules.....	I-2-3
Engine Instrument Light.....	I-2-42
Engine Operation Limitations.....	I-4-1
Engine Related Cautions and Advisories.....	I-2-5
Engine Shutdown Checks.....	III-7-46, III-10-30
ENGINE START.....	III-7-18
Engine Start.....	III-8-2
ENGINE START.....	VI-22-1
Engine Start Checks.....	III-7-19, III-10-6
Engine Status.....	I-2-2
Engine Vibration Limitations.....	I-4-1

	Page No.
Engine/AMAD Fire Extinguishing System.....	I-2-113
Engines.....	I-2-1
Enroute.....	IX-28-3
ENTRANCE/EGRESS SYSTEMS.....	I-2-115
Equipment Groups.....	I-2-193
Equipment Status Displays.....	I-2-188, I-2-201
Erase and Hold Data.....	I-2-144
Exceeding 360° Roll Limit.....	IV-11-9
Exceeding Asymmetric Loading AOA Limits.....	IV-11-9
Excessive Landing Sink Rate.....	I-2-134
Excessive Take-off Sink Rate.....	I-2-134
Excessive Wave - off Sink Rate.....	I-2-134
EXT TANKS Transfer Switches.....	I-2-16
Exterior Inspection.....	III-7-2
EXTERIOR INSPECTION.....	VI-22-1
Exterior Lighting.....	I-2-36
Exterior Lights Master Switch.....	I-2-36
External Electrical Power.....	I-2-34
External Fuel Transfer.....	I-2-15
External Power Switch.....	I-2-34
EXTERNAL STORES JETTISON.....	V-15-23
EXTERNAL STORES LIMITATIONS.....	I-4-13

F

F/A-18F.....	I-1-2
Factors That Degrade Aircrew Coordination.....	IX-28-2
FADEC - Full Authority Digital Engine Control.....	I-2-1
FADEC Power Sources.....	I-2-1
FADEC Reset.....	I-2-3
FADEC/Engine Degrades.....	I-2-2
Fan Speed Lockup.....	I-2-4
Fast Data Entry.....	I-2-167, VII-24-78
Fast Tactical Imaging Set (FTI-II).....	I-2-178
FCC Electrical Redundancy.....	I-2-33
FCC Temperature Monitoring.....	I-2-63
FCCs - Flight Control Computers.....	I-2-61
FCES Caution Light.....	I-2-79
FCF CHECKLIST - PROFILE A.....	III-10-4
FCF CHECKLIST - PROFILE C.....	III-10-31
FCF CHECKLIST - PROFILE D (REAR COCKPIT).....	III-10-32
FCF CHECKLIST - PROFILE E.....	III-10-33
FCF PROCEDURES.....	III-10-2
FCF QUALIFICATIONS.....	III-10-2
FCF REQUIREMENTS.....	III-10-2
FCS - FLIGHT CONTROL SYSTEM.....	I-2-60
FCS BIT Consent Switch.....	I-2-81
FCS Exerciser Mode.....	I-2-80, I-2-195
FCS FAILURE INDICATIONS AND EFFECTS.....	V-15-27

	Page No.
FCS Failures.....	I-2-79
FCS Initiated BIT (IBIT).....	I-2-193
FCS Redundancy and Survivability.....	I-2-63
FCS Related Cautions.....	I-2-81
FCS RESET Button.....	I-2-80
FCS Status Display.....	I-2-82
Feed Shutoff Valves.....	I-2-12
Feed Tank Balancing.....	I-2-13
Feed Tank Imbalance with One Engine at Idle.....	I-2-13
Feed Tanks.....	I-2-12
Final Approach.....	III-7-38
Final Grade Determination.....	X-30-5
Fine Alignment.....	I-2-214
FIRAMS - Flight Incident Recorder and Aircraft Monitoring Set.....	I-2-186
FIRE DETECTION, FIRE EXTINGUISHING, AND BLEED AIR LEAK DETECTION SYSTEMS	I-2-111
FIRE Detection System Test.....	I-2-113
FIRE EXTGH READY/DISCH Light.....	I-2-112
FIRE LIGHT.....	V-18-2
FIRE Lights.....	I-2-111
FIRE Test Switch.....	I-2-115
FIRE Warning Lights (F/A-18F).....	I-2-112
FIRE Warning Voice Alerts.....	I-2-112
Flap Position Lights.....	I-2-64
Flap Scheduling.....	I-2-66
FLAP Switch.....	I-2-64
Flaps AUTO.....	IV-11-11
Flaps AUTO Handling Qualities.....	IV-11-2
Flaps HALF or FULL.....	IV-11-11
Flight Codes.....	III-6-1
Flight Control Mode Effects on Handling Qualities.....	IV-11-1
Flight Control Surfaces.....	I-2-61
Flight Control System Functional Checks.....	III-10-1
Flight Controls.....	I-2-73
FLIGHT EVALUATION	X-30-3
Flight Evaluation Grade Determination.....	X-30-5
Flight Evaluation Grading Criteria.....	X-30-5
FLIGHT MEMBER POSITIONS	IX-28-2
FLIGHT PHASES	IX-29-2
Flight Preparation.....	III-9-19
FLIR, ATFLIR, NAV Pod Restrictions with 480 Gallon Centerline.....	I-4-19
FLIR Carriage Handling Qualities.....	IV-11-5
FLOOD Lights Knob.....	I-2-41
Floor Altitude.....	I-2-134
FOLLOW-ON TRAINING	II-5-1
FORCED LANDING	V-16-4
FORMATION FLIGHT	III-9-1
Formation Flights.....	IX-28-4

	Page No.
Formation Leader.....	IX-28-2
Formation Lights.....	I-2-39
FORMATION Lights Knob.....	I-2-39
Formation Taxi/Takeoff.....	III-9-1
FPAH - Flight Path Angle Hold.....	I-2-86
FPAH/ROLL - ATC Approach Technique (field only).....	III-7-39
FPAH/ROLL - ATC Approaches.....	III-7-39
FPAS - FLIGHT PERFORMANCE ADVISORY SYSTEM.....	I-2-24
FPAS CLIMB Option.....	I-2-25
FPAS CURRENT RANGE and ENDURANCE.....	I-2-24
FPAS Default Area.....	I-2-25
FPAS Display.....	I-2-24
FPAS Fuel Flow.....	I-2-25
FPAS HOME FUEL Caution.....	I-2-25
FPAS HOME Waypoint Selection.....	I-2-25
FPAS OPTIMUM RANGE and ENDURANCE.....	I-2-25
FPAS Waypoint/Tacan Steering and the HSI Display.....	I-2-24
F-QTY Advisory.....	I-2-22
FTI-II Major Components.....	I-2-178
FUEL Display.....	I-2-21
Fuel DUMP Switch.....	I-2-19
Fuel Dump System.....	I-2-18
Fuel Low Level Indicating System.....	I-2-23
Fuel Quantity Indicating System.....	I-2-19
FUEL SYSTEM.....	I-2-11
Fuel System Related Cautions.....	I-2-24
Fuel Tank Pressurization and Vent.....	I-2-16
Fuel Transfer.....	III-9-15
Fuel Transfer - Internal Wing Tanks.....	I-2-14
Fuel Transfer - Tanks 1 and 4.....	I-2-13
Fuel Transfer Schedule/CG Control.....	I-2-14
Fuel Transfer System.....	I-2-13
Fuel/Air Heat Exchanger.....	I-2-18
Fuel/Air Heat Exchanger Leak Detection.....	I-2-18
Full Stop Landings.....	III-7-39
Full-Crab-to-Touchdown Technique.....	III-7-42
Functional Check Flights.....	IX-29-7
Functional Checkflights.....	IX-28-4
FUSELAGE FUEL LEAK.....	V-15-4

G

G XMIT (Guard Transmit) Switch.....	VII-23-7
GAIN Control - AMCD Aircraft.....	I-2-147
GAIN ORIDE.....	I-2-78, IV-11-16
GAIN Switch.....	I-2-79
G-Bucket.....	I-2-70
Gear-Up Landing.....	I-2-135
GEN Switches.....	I-2-30

	Page No.
GEN TIE Caution Light.	I-2-32
GEN TIE Switch.	I-2-32
General.	III-6-1
GENERAL.	III-8-1
General.	III-8-21
GENERAL.	III-10-1
General.	X-30-2
Glideslope.	III-8-14
G-Limiter.	I-2-69
G-Limiter Considerations.	I-2-69
G-Limiter Override.	I-2-72
Global Positioning System (GPS).	VII-24-11
GO AROUND.	V-14-3
GPS Page.	VII-24-24
GPS Waypoint Programming.	VII-24-26
Grab Handle Chaff/Flare Dispense Switches (Rear Cockpit LOT 26 and up).	I-2-95
Grab Handle Chaff/Flare Dispense Switches (Rear Cockpit LOTs 21 thru 25).	I-2-95
Grading Instructions.	X-30-2
Gross Weight and Lateral Weight Asymmetry Limitations.	I-4-3
GROUND EVALUATION.	X-30-2
GROUND FIRE.	V-13-2
Ground (GND) Alignment.	VII-24-14
Ground Operation.	VI-20-1
GROUND OPERATIONS.	VI-21-1
Ground Power Switches.	I-2-35
Ground Proximity Warning System.	I-2-215
Groundspeed Cuing.	VII-24-45
Groundspeed Programming.	VII-24-29
GSEL - Ground Track Select.	I-2-87
GTRK - Ground Track Hold.	I-2-86
Guard Transmit on Top Level CNI Format.	VII-23-23
Guidelines for Effective Communications.	IX-29-2
Gyro Recovery.	VII-24-23

H

Half-Crab Kickout Technique.	III-7-42
Hand Controllers (Missionized Rear Cockpit Lots 21 thru 25).	I-2-91
Hand Controllers (Rear Cockpit LOT 26 AND UP).	I-2-95
HANDLING QUALITIES.	IV-11-1
Handling Qualities with Flaps HALF or FULL.	IV-11-1
Hangar Deck Operation.	III-8-1
Have Quick Menu From AJ Menu Fixed Frequency COMM Sublevel.	VII-23-14
HAVE QUICK SYSTEM.	VII-23-14
HDG - Heading Hold.	I-2-87
HDG/TK Set Switch.	I-2-147, I-2-165
Heavy Gross Weight Braking Technique.	III-7-41
Heavy Gross Weight Landings.	III-7-41
Helmet Display Unit (HDU).	I-2-205

Helmet Mounted Display (HMD)/Aft Helmet Mounted Display (AHMD).....	I-2-205
Helmet Not Installed.	I-2-221
Helmet Tracker Failure.	I-2-221
Helmet-Vehicle Interface (HVI) Connectors.....	I-2-205
High Altitude (above 30,000 feet).	III-10-27
High Altitude Ejection.	V-17-4
HMD Alignment.	III-9-22
HMD/AHMD OFF/BRT Knobs.....	I-2-208
HMD/AHMD Symbology.....	I-2-214
Holding.	VI-19-2
HOOK BYPASS Switch.....	I-2-40
HOOK Handle.....	I-2-58
HOOK Light.....	I-2-58
HOSE CUT/SAFE Switch.	III-9-11
HOSE Switch.	III-9-12
HOT BRAKES.....	V-13-5
HOT BRAKES/BRAKE FIRE.....	V-13-2
Hot Refueling.....	III-7-45
HOT SEAT PROCEDURE.....	III-9-20
HOT START.....	V-13-1, V-18-3
HSEL - Heading Select.	I-2-87
HSI Display.....	VII-25-5
HSI Display Symbology.....	I-2-153
HSI Format.....	VII-24-2
HSI Format on a DDI.....	VII-24-9
HSI Option.	VII-24-2
HSI-DATA-A/C Controls.	I-2-138
HUD - Head-Up Display.....	I-2-156
HUD - Navigation Information.....	VII-24-9
HUD ACL Display.....	VII-24-64
HUD Advisory Data Symbology.....	I-2-165
HUD BIT Checks.....	I-2-165
HUD Camera.	I-2-172
HUD Camera BIT Button.	I-2-172
HUD Event Marker.....	I-2-172
HUD Symbology.....	I-2-157
HUD Symbology Brightness Selector Switch.	I-2-156
HUD Symbology BRT Control Knob.....	I-2-156
HUD Symbology Degrades.	I-2-162
HUD Symbology Not Replicated on the HMD.	I-2-214
HUD Symbology Reject Switch.	I-2-156
HUD Symbology Replicated on the HMD.....	I-2-214
HUD Video Control Switch.	I-2-157
HUD Video Record Panel.....	I-2-208
HYD ISOL Switch.	I-2-46
HYD1 (2) HOT CAUTION.....	V-18-2
Hydraulic Accumulators.....	I-2-45
HYDRAULIC FAILURES.....	V-15-5

Hydraulic Isolation Valves.	I-2-45
HYDRAULIC POWER SUPPLY SYSTEM	I-2-42
Hydraulic Pressure Gauge.....	I-2-44
Hydraulic Pumps.	I-2-44
Hydraulic Reservoirs.....	I-2-44
Hydraulic System.....	I-2-42
Hydraulic System Related Cautions and Caution Light.....	I-2-46
Hydro-mechanical (HYDRO MECH) Initiated BIT.	I-2-201
HYPOXIA/LOW MASK FLOW/NO MASK FLOW	V-15-17

I

IBU (Increased Bleed Usage) Signal	I-2-5
ICE AND RAIN.....	VI-20-1
ICLS BIT.....	VII-24-58
ICLS Decoder.....	VII-24-58
ICLS Initialization.....	VII-24-58
ICLS Receiver.	VII-24-54
ICLS Steering.....	VII-24-59
ICS - INTERCOM SYSTEM.....	VII-23-1
ICS Aft Cockpit Kick Switches (F/A-18F Lot 26 and up).....	VII-23-2
ICS Function Selector Switch Aft Cockpit (F/A-18F).....	VII-23-2
ICS Function Selector Switch (F/A-18F).	VII-23-2
ICS Function Selector Switch Front Cockpit (F/A-18F).	VII-23-2
ID (IDENT) Pushbutton.....	I-2-170
IDENT (ID) Button.	VII-23-46
IDENT Knob.....	I-2-38
IDENTIFICATION FRIEND OR FOE (IFF)/COMBINED INTERROGATOR TRANSPONDER (CIT).....	VII-23-32
IFA (APG-73).....	VII-24-18
IFA (APG-79).....	VII-24-22
IFF Antenna Select Switch.....	VII-23-47
IFF BIT.	VII-23-43
IFF Control Panel.	VII-23-46, VII-24-10
IFF Controls.....	VII-23-46
IFF Interrogator.	VII-23-43
IFF on Top Level CNI UFCD Format.....	VII-23-35
IFF PROG EDIT Sublevel.	VII-23-44
IFF Programming (IFF PROG) Page.....	VII-23-43
IFF Related Cautions and Advisories.....	VII-23-47
IFF Transponder.....	VII-23-32
IFF Transponder UFCD Sublevel.	VII-23-35
Ignition System.	I-2-3
ILS Channel Thumbwheels.	VII-24-10
ILS Option (HSI Format).....	VII-24-9
ILS UFC/MAN Switch.....	VII-24-10
Immediate Action Items.....	V-12-1
Implementation.....	X-30-1
In Maintenance Control.....	III-7-1

	Page No.
Individual Units.	I-2-193
Inertial Navigation (NAV) Mode.	VII-24-11
Inertial Navigation System (INS).	VII-24-11
INERTIAL NAVIGATION SYSTEM (INS)/GLOBAL POSITIONING SYSTEM (GPS) .	VII-24-10
Inflight.	VI-19-1
INFLIGHT.	VI-21-1
In-Flight Alignment (IFA).	VII-24-17
Inflight Refueling.	IX-29-4
INITIAL QUALIFICATION.	II-5-1
Initialization.	VII-24-65
Initiated BIT (IBIT).	I-2-211
Injury Risks - Nude Weight Greater than 213 Pounds (245 Pounds for SJU-17A).	V-17-2
Injury Risks - Nude Weight Less than 136 Pounds.	V-17-1
INS Initiated BIT.	I-2-195
INS Knob.	VII-24-25
INS Mode Select Knob.	VII-24-9
INS Terminal Data.	I-2-203
INS Updates (not available in AINS).	VII-24-50
INS/GPS Related Cautions and Advisories.	VII-24-25
Inspection of RCS Reduction Features.	III-7-1
INST PNL Lighting Knob.	I-2-41
INSTRUMENT CARRIER LANDING SYSTEM (ICLS).	VII-24-54
Instrument Evaluation Flights.	II-5-2
INSTRUMENT FLIGHT	VI-19-1
Instrument Qualification.	II-5-2
INSTRUMENTS.	I-2-140
Intercockpit Communications (F/A-18F).	III-7-19
Interconnect Valve.	I-2-12
INTERIOR CHECK.	VI-22-1
Interior Checks - Pilot.	III-7-11
Interior Checks - WSO.	III-7-16
Interior Lighting.	I-2-40
Interior Lighting (F/A-18F).	I-2-42
INTR WING Control Switch.	I-2-15
Intra-Cockpit Communications (ICS).	IX-29-1

J

JAMMER Switch.	I-2-185
JETT STATION SELECT Buttons.	I-2-128
Jettison Systems.	I-2-127
JHMCS Alignment.	I-2-213
JOINT HELMET MOUNTED CUEING SYSTEM (JHMCS)	I-2-205

K

KC-10 Refueling Operations.	III-9-7
KC-135 BDA Refueling.	III-9-8
KC-135 MPRS Refueling.	III-9-9

	Page No.
KC-135 Refueling Operations.	III-9-8
KY-58 - SECURE SPEECH SYSTEM	VII-23-23
KY-58 Cipher Mode.	VII-23-26
KY-58 Control Panel Assembly.	VII-23-23
KY-58 Controls and Indicators.	VII-23-25
KY-58 Fill Select Knob.	VII-23-25
KY-58 Mode Select Knob.	VII-23-25
KY-58 Operation.	VII-23-25
KY-58 Power Knob.	VII-23-25
KY-58 Relay Mode.	VII-23-26
KY-58 Volume Control Knob.	VII-23-25

L

L BAR Warning/Advisory Lights.	I-2-57
L or R BLD OFF Cautions.	I-2-96
Ladder Remote Release Button (After AFC 366).	I-2-119
Ladder Remote Release Switch (Before AFC 366).	I-2-119
Landing.	IX-29-6
Landing Aid Symbology.	I-2-215
LANDING CHECKS.	III-7-35
Landing Checks.	III-7-36, III-10-28
Landing Gear Control Unit (LGCU).	I-2-48
LANDING GEAR EMERGENCY EXTENSION	V-16-5
LANDING GEAR FAILS TO RETRACT	V-14-5
Landing Gear Functional Checks.	III-10-2
Landing Gear Position Lights.	I-2-49
Landing Gear Position Lights (F/A-18F).	I-2-49
Landing Gear System.	I-2-46
Landing Gear UNSAFE Light (F/A-18F).	I-2-49
LANDING GEAR UNSAFE/FAILS TO EXTEND	V-16-4
Landing Gear Warning Light and Warning Tone.	I-2-48
Landing in Heavy Rain.	VI-20-3
Landing Pattern.	III-8-12, III-9-19
Landing/Taxi Light.	I-2-40
Lateral Weight Asymmetry Calculations.	I-4-3
Latitude/Longitude Display/Entry.	VII-24-35
LAUNCH BAR Switch.	I-2-57
Launch Bar System.	I-2-56
LB Circuit Breaker.	I-2-57
LCS - Liquid Cooling System.	I-2-105
LDG GEAR Handle.	I-2-47
LDG/TAXI Light Switch.	I-2-40
Leadership.	IX-28-1
Leading Edge Flap Asymmetry.	IV-11-12
LEF Failure Landing Handling Qualities (Symmetric or Asymmetric).	IV-11-12
Leg Restraint Snubber Release Tabs.	I-2-123
Leg Restraint System.	I-2-122
LIGHTING	I-2-36

	Page No.
LIMITATIONS OF THE BASIC AIRCRAFT	I-4-1
Limitations with Flaps HALF or FULL	I-4-9
Local Time Of Day Programming (LTOD)	VII-24-37
LOSS OF CABIN PRESSURIZATION	V-15-18
LOSS OF DC ESSENTIAL BUS	V-13-1
LOSS OF DIRECTIONAL CONTROL DURING TAKEOFF OR LANDING (BLOWN TIRE, NWS FAILURE)	V-14-4
LOSS OF DIRECTIONAL CONTROL DURING TAKEOFF OR LANDING/ PLANING LINK FAILURE	V-18-3
Low Altitude Ejection.....	V-17-3
Low Altitude Warning Tone	I-2-170
L/R FUEL INLT CAUTION	V-18-2
LT TEST Switch	I-2-42

M

Magnetic Azimuth Detector.....	VII-25-3
Magnetic Transmitter Unit (MTU)	I-2-208
Main Wheel Anti-Spin	I-2-56
Malfunction.....	X-30-2
Maneuvering Outside of NATOPS Limits.....	IV-11-9
Maneuvering with Flight Control System Failures.....	IV-11-10
Maneuvering within NATOPS Limits	IV-11-8
Manual Canopy Actuation Fitting (External).....	I-2-118
Manual Canopy Handcrank (Internal).....	I-2-118
Manual Erase	I-2-145
Manual Override Handle.....	I-2-125
Map Data.....	VII-24-6
Map Loading Format Options.....	I-2-181
Map Loading Format Status Information	I-2-182
Map Loading Interruptions	I-2-183
MAP Modes/Data Products.....	VII-24-6
MAP Operating Mode Option.....	VII-24-2
MAP Option (HSI Option).....	VII-24-1
Map Orientation Option	VII-24-6
Map Theater Data Loading	I-2-181
MAP Update	VII-24-39
MASTER CAUTION Light	I-2-129
MASTER CAUTION Light (F/A-18F)	I-2-130
Master Modes.....	I-2-146
MASTER Switch	VII-23-46
MC CONFIG Caution.....	I-2-202
MC Switch.....	I-2-143
Medium Altitude Checks (above 10,000 feet)	III-10-22, III-10-33
Meet The Super Hornet.....	I-1-1
MENU Formats.....	I-2-148
MENU Option (HSI Format)	VII-24-9
Minimum Flight Training Requirements	II-5-1
Minimum Ground Training Requirements.....	II-5-1

	Page No.
Missed Approach.	III-9-7
Mission Analysis.	IX-28-2
Mission Commander.	IX-28-2
Mission Computer Failure.	I-2-218
MISSION COMPUTER FAILURE.	VII-25-1
Mission Computer Failure (AMCD Aircraft)	VII-25-1
Mission Computer Failure (AMCD Aircraft) - Dual.	VII-25-1
Mission Computer Failure (AMCD Aircraft) - Single.	VII-25-1
Mission Computer Failure (Non-AMCD Aircraft).	VII-25-1
Mission Computer System.	I-2-142, VII-23-31
Mission Critique.	IX-28-4
Mission Data Entry.	I-2-143
Mission Evaluation.	X-30-4
Mission Initialization.	I-2-143, VII-23-32
MISSION PLANNING.	III-6-1
Mission Planning and Briefing.	IX-28-3
Mission Planning/Briefing.	X-30-3
MK Option (HSI Format).	VII-24-7
MODE 4 Switch.	VII-23-47
MODE Backup.	VII-24-2
MODE Option (HSI Format).	VII-24-2
Mode S.	VII-23-35
MODE Switch.	I-2-40
Motive Flow/Boost Pumps.	I-2-12
Moving Map - Digital Map Set (DMS).	VII-24-1
Moving Map Range Scales.	VII-24-1
MPCD - Multipurpose Color Display.	I-2-150
MPCD Formats.	I-2-151
MPCD Initiated BIT.	I-2-199
MPCD (or 8 x 10 Display).	VII-25-3
MULTIFUNCTION INFORMATION DISTRIBUTION SYSTEM (MIDS)	VII-23-1
Multi-Function Switch (MFS).	I-2-92
Multipurpose Display Group.	I-2-146
MUMI - Memory Unit Mission Initialization Format.	I-2-143

N

NAMT Systems Check.	X-30-2
NATOPS Admin Briefing Guide.	III-6-1
NATOPS Evaluation.	X-30-1
NATOPS Evaluation Question Bank.	X-30-5
NATOPS EVALUATION QUESTION BANK.	X-30-6
NATOPS Reevaluation.	X-30-1
NATOPS Tactical Admin Briefing Guide.	III-6-4
NAV Master Mode TDC Priority.	I-2-215
NAVCK Display.	VII-24-23
NAVIGATION BACKUP.	VII-25-4
NAVIGATION CONTROLS AND INDICATORS	VII-24-1
Navigation Controls and Indicators.	VII-25-5

	Page No.
NAVIGATION DATA ENTRY.....	VII-24-70
Navigation Master Mode.....	I-2-215
NAV/TAC Bank Limit Options.....	VII-24-39
Night Landings.....	III-8-23
NIGHT OPERATIONS.....	III-8-21
NIGHT VISION DEVICE (NVD) OPERATIONS.....	III-9-18
No RDY Light.....	V-15-26
Non-Avionic BIT.....	I-2-201
Non-BIT Status.....	I-2-202
Non-Precision.....	VI-19-2
Normal Braking.....	I-2-51
Normal Landing Gear Extension and Retraction.....	I-2-47
Normal Takeoff.....	III-7-32
Nosewheel Steering System (NWS).....	I-2-49
NWS Button.....	I-2-75
NWS Engagement/Disengagement.....	I-2-50

O

Object/Target Detection.....	III-9-19
OBOGS Control Switch.....	I-2-110
OBOGS DEGD Caution.....	I-2-108
OBOGS DEGD CAUTION//HYPOXIA/LOW MASK FLOW/NO MASK FLOW//LOSS OF CABIN PRESSURIZATION/CABIN CAUTION LIGHT BELOW 47,000 FEET.....	V-18-2
OBOGS Monitor.....	I-2-107
OCF RECOVERY.....	V-18-4
OCF Recovery Procedures.....	V-15-20
OFT/WST Procedures Evaluation.....	X-30-2
Oil Pressure Sensing System.....	I-2-3
On Board Oxygen Generating System (OBOGS).....	I-2-107
Open Book Examination.....	X-30-2, X-30-3
OPERATING LIMITATIONS (LOT 21).....	I-4-19
Operation.....	VII-23-28
Oral Examination.....	X-30-2
Oral Examination and OFT Procedure Check (If Conducted).....	X-30-3
OUT-OF-CONTROL FLIGHT (OCF).....	IV-11-8, V-15-19
Over the Shoulder Camera BIT Buttons (LOTs 21–24).....	I-2-172
Over the Shoulder Cameras (LOTs 21–24).....	I-2-172
Overfly Designation.....	VII-24-47
Overheat Condition.....	I-2-213
Over-the-Top Maneuvering.....	IV-11-8
OVRD Button.....	I-2-203
OXY FLOW Knob.....	I-2-110
OXYGEN SYSTEMS.....	I-2-107

P

Paddle Switch.....	I-2-75
Parade.....	III-9-1

	Page No.
PARK BRK Handle.	I-2-56
Parking Brake System.	I-2-56
Pattern Adjustments.	III-7-38
Pattern Strobe Lights.	I-2-38
PERSONAL FLYING EQUIPMENT.	II-5-4
PHILOSOPHY.	IX-29-1
Pilot In Command.	IX-28-2
Pitch and Roll Trim Switch.	I-2-74
Pitch CAS.	I-2-65
Pitch-Axis Pilot Relief Modes.	I-2-86
PITOT ANTI ICE Switch.	I-2-73
Pitot-Static/Total Temperature Probes.	I-2-72
Plane Captain Brief.	III-10-4
PLANING LINK FAILURE.	V-16-12
Planing Links.	I-2-46
PMG - Permanent Magnet Generator.	I-2-32
POS Data.	VII-23-46
POS Option Display.	VII-25-5
Position Keeping.	VII-24-37
Position Lights.	I-2-38
POSITION Lights Knob.	I-2-39
Position Updating.	VII-24-38
Post Departure Dive Recovery.	V-15-21
Post Flight.	IX-29-7
Post Flight Procedures.	X-30-4
POST-FLIGHT CHECKS.	III-7-43
Post-flight Update.	VII-24-39
Post-Start Checks.	III-10-7
POS/XXX Option (HSI Format).	VII-24-6
POWER PLANT SYSTEMS.	I-2-1
Power Switch (PWR).	III-9-10
Precision Approaches.	VI-19-2
Preflight.	III-8-21
PRE-FLIGHT.	IX-29-2
PREFLIGHT CHECKS.	III-7-1
Preflight Checks.	III-8-1, III-10-4, III-10-32
Preflight FCS Initiated BIT.	I-2-194
Preflight FCS Initiated BIT Operation.	I-2-194
Preflight FCS Initiated BIT PASS/FAIL.	I-2-194
Preflight/Line Operations.	X-30-3
Pre-Start Checks.	III-10-5
Pretakeoff.	IX-28-3
Primary Heat Exchanger.	I-2-97
PROBE Switch.	I-2-18
Prohibited Maneuvers.	I-4-9
Prohibited Maneuvers.	I-4-19

Q

Qualified..... X-30-1

R

Radar Altimeter Initiated BIT..... I-2-200
 Radar Cross Section (RCS) Reduction..... I-1-3
 Radar Elevation Control..... I-2-91, I-2-92
 RAID Button..... I-2-91
 RALT - Radar Altimeter Function..... I-2-168
 RALT - Radar Altitude Hold..... I-2-86
 Ram Air Exhausts..... I-2-97
 RATS - Reduced Authority Thrust System..... I-2-4
 Receiver Hook-up and Refueling..... III-9-16
 Records and Reports..... X-30-5
 Recovery..... IX-28-4
 Reference Load Factor (Nz REF)..... I-2-69
 Refuel Data Display Switch..... III-9-10
 REFUEL Display..... III-9-10
 Refuel RST Button..... III-9-10
 Refuel SLEW Switch..... III-9-11
 Refueling Limitation..... I-4-9
 Refueling System..... I-2-18
 Refueling Technique..... III-9-6
 Regaining Currency..... II-5-2
 Relay Mode Of Operation..... VII-23-29
 Remote Switching Control (RSC)..... I-2-178
 Rendezvous and Formation..... IX-29-3
 Repetition of Preflight FCS Initiated BIT..... I-2-195
 Requirements for Instrument Qualification in E/F-Series Aircraft..... II-5-3
 REQUIREMENTS FOR VARIOUS FLIGHT PHASES..... II-5-2
 Reservoir Level Sensing (RLS) System..... I-2-44
 RESTART..... V-15-1
 Reversion..... I-2-187
 RF/CBL SINS Alignment..... VII-24-13
 RLY (Relay) Switch..... VII-23-6
 ROLL - Roll Attitude Hold..... I-2-86
 Roll CAS..... I-2-65
 Roll Rate Limiting..... I-2-72
 Roll-Axis Pilot Relief Modes..... I-2-86
 RUD PED ADJ Lever..... I-2-74
 RUD TRIM Knob..... I-2-75
 Rudder Pedals..... I-2-73
 Running Preflight FCS Initiated BIT After Flight..... I-2-195
 RVSM Checks..... III-7-34

S

SA Display.....	VII-24-62
SDC - Signal Data Computer.	I-2-171
Seat Bucket Position Switch.	I-2-125
SEAT CAUT MODE Switch (F/A-18F).	I-2-127
Seat Position Sensor (SPS).....	I-2-208
Seat Survival Kit (SKU-10/A).....	I-2-123
SEAWARS - SEAWATER Activated Release System.	I-2-122
SEAWATER ENTRY	V-17-4
Secondary Heat Exchanger.....	I-2-98
SECONDARY POWER SYSTEM.....	I-2-27
Section Approaches/Landing.....	III-9-4
SECTION CCA	III-8-21
Section Landing.....	III-9-5
Section Takeoff.	III-9-1
SECURE ERASE Button.	I-2-172
SELECT JETT Knob.....	I-2-128
Selective Jettison.	I-2-128
Sensor Control Panel.....	VII-24-9
Sensor Control Switch.	I-2-89
SENSORS Option (HSI Format).....	VII-24-9
SEQ # Option (HSI Format).....	VII-24-8
SERVICING	I-3-1
SETLIM - Supersonic Engine Thrust Limiting.....	I-2-4
Setting the Alert.....	III-9-20
SEVER Caution.	I-2-186
Shaped Attitude Display Indicator.	I-2-149
Shipboard Taxi/Takeoff Checks.....	III-10-20
Shorebased Takeoff Checks.	III-10-20
SHORT AIRFIELD FOR TACTICAL SUPPORT (SATS) PROCEDURES.....	III-9-19
Shoulder Harness Inertia Reel.	I-2-122
Shoulder Harness Lock/Unlock Handle.	I-2-122
SINGGARS Menu From AJ Menu Fixed Frequency COMM Sublevel.	VII-23-17
SINGGARS SYSTEM.....	VII-23-20
SINGLE AOA FAILURE ON TAKEOFF.....	V-15-46
SINGLE ENGINE APPROACH AND LANDING.....	V-16-1
SINGLE ENGINE FAILURE IN LANDING CONFIGURATION.....	V-16-1, V-18-4
Single Engine Operation.	IV-11-11
Single Engine Waveoff.	IV-11-12
SINGLE ENGINE WAVEOFF/BOLTER	V-16-3
SINGLE L BLEED or R BLEED WARNING LIGHT.....	V-18-1
Situation Awareness.	IX-28-1
SJU-17(V) 1/A, 2/A, and 9/A, and SJU-17A (V)1/A, 2/A, and 9/A NACES Seat.	I-2-120
SLEW Option (HSI Format).....	VII-24-6
Slow Speed Maneuvering.....	IV-11-8
SMS Initiated BIT.....	I-2-195
Software Configuration.....	VII-23-32
SPD BRK Light.	I-2-69

	Page No.
SPECIAL CONSIDERATIONS	IX-28-4, IX-29-7
Speedbrake Function.....	I-2-67
Speedbrake Switch.....	I-2-68
Spin.....	V-15-20
Spin Characteristics.....	IV-11-10
Spin Recovery.....	V-15-20
Spin Recovery Displays.....	I-2-77
Spin Recovery System.....	I-2-76
SPIN Switch.....	I-2-78
Spoilers.....	I-2-61
SSR Advisories.....	I-2-172
Stabilator Failure.....	IV-11-14
Stabilator Failure Control Law Reconfiguration.....	I-2-78
Stalls with Flaps HALF or FULL.....	IV-11-1
Standard Data Entry.....	I-2-167, VII-24-78
STANDARD ICS TERMS.....	IX-29-8
Standby Airspeed Indicator.....	I-2-140
Standby Altimeter.....	I-2-140
Standby Attitude Reference Indicator.....	I-2-140, VII-25-2
Standby Attitude Reference Indicator Controls and Indicators.....	VII-25-3
Standby Indication.....	I-2-150
Standby Magnetic Compass.....	I-2-141
Standby Rate of Climb Indicator.....	I-2-141
Start/Taxi/Takeoff.....	IX-29-2
Start-up BIT (SBIT).....	I-2-211
Static Power Inverter.....	VII-25-3
Status Lights.....	III-9-11
Status Messages.....	I-2-213
Status Monitoring.....	VII-23-32
Status Monitoring Backup.....	I-2-201
Steering.....	VII-24-39
Steering Information.....	I-2-146
Stick.....	I-2-73
Stick Grip FCS Controls.....	I-2-74
Stick Grip Switches/Controls (Front Cockpit).....	I-2-88
Stick Grip Switches/Controls (Trainer Configured F/A-18F).....	I-2-90
STOP Button.....	I-2-200
Stopping Fuel Transfer.....	III-9-16
STORE Switch.....	III-9-10
Stored Heading (STD HDG) Alignment.....	VII-24-17
STROBE Switch.....	I-2-38
Sub-area.....	X-30-2
Suspected Inboard Aileron Hinge Failure Corrective Action.....	V-15-48
S/W CONFIG Caution.....	I-2-203
Switching Valve Operation.....	I-2-44
Switching Valves.....	I-2-44
Symbology Rocker Switch.....	I-2-150
System BIT Steps.....	I-2-193

System Check - Airborne.....	III-9-14
System Check - Prestart.	III-9-14
System Limitations and Constraints.....	I-2-132

T

TACAN BIT.....	VII-24-53
TACAN Mode Selection.	VII-24-53
TACAN Position Keeping.....	VII-24-54
TACAN Position Updating.....	VII-24-54
TACAN Programming.	VII-24-53
TACAN Steering.....	VII-24-54
TACAN (TACTICAL AIR NAVIGATION).....	VII-24-52
TACTICAL AIRCRAFT MOVING MAP CAPABILITY (TAMMAC).....	I-2-178
TAKEOFF	III-7-30, VI-22-2
Takeoff (*).....	X-30-4
Takeoff and Landing.....	IV-11-1
Takeoff Checks.	III-8-9
Takeoff/Departure.	IX-28-3
TAMMAC Status Monitoring.....	I-2-179
Tanker Safety Precautions.....	III-9-12
Taxi.	III-8-9, III-8-21, X-30-4
TAXI CHECKS	III-7-30
Taxi Checks.....	III-10-19, III-10-32
TCN Option (HSI Format).....	VII-24-9
TD Control.	VII-23-28
TDC - Throttle Designator Controller.....	I-2-91
TEF Failure Landing Handling Qualities.....	IV-11-13
TGT (Target) Programming.....	VII-24-29
Thermal Management System.....	I-2-17
Throttle Grip Switches/Controls (Front Cockpit).....	I-2-90
Throttle Grip Switches/Controls (Trainer Configured Rear Cockpit).....	I-2-91
Throttles.....	I-2-6
Throttles (Trainer Configured F/A-18F).....	I-2-6
TIME Data.	VII-23-45
Time Zone.	VII-24-37
TIMEUFC Option (HSI Format).....	VII-24-8
T/O TRIM Button.....	I-2-76
Top Level CNI Format Channel or Manual Frequency Change.....	VII-23-8
Top Level IFF PROG Page.	VII-23-43
TOT (Time On Target) Programming.....	VII-24-29
TR - Transformer-rectifiers.	I-2-32
Traffic Control Couple.....	VII-24-66
Trailing Edge Flap Failure.	IV-11-13
TRANS Switch.	III-9-12
Transfer Fuel from ARS to Tanker (Own Ship).....	III-9-17
Trigger.....	I-2-89
True/Magnetic Heading Selection.....	VII-24-35
TURBULENT AIR AND THUNDERSTORM OPERATION	VI-20-4

Typical ACL Approach..... VII-24-70

U

UFCD - DCS. VII-23-29
 UFCD - Up Front Control Display..... VII-23-4
 UFCD BRT Knob. I-2-171
 UFCD CNI Function..... I-2-167
 UFCD CONT (Contrast) Control Knob. VII-23-6
 UFCD CONT Knob..... I-2-171
 UFCD Controls. I-2-170
 UFCD Data Entry. I-2-167
 UFCD Initiated BIT. I-2-200
 UFCD Navigation Controls..... VII-24-1
 UFCD OFF/BRT (Brightness) Control Knob..... VII-23-6
 UFCD STANDBY Indication. I-2-168
 UFCD SYM Knob. I-2-171
 UFCD SYM (Symbology) Control Knob..... VII-23-6
 Undesignate Button..... I-2-95
 Undesignate/NWS Button. I-2-90
 Unqualified. X-30-2
 Up Front Control Display (UFCD)..... I-2-166
 UPDT Option (HSI Format)..... VII-24-7
 Utility Floodlight. I-2-41
 UTILITY HYDRAULIC FUNCTIONS..... I-2-46
 UTM Data Entry. VII-24-27

V

VEC Option (HSI Format)..... VII-24-9
 VFR Landing Pattern and Approach..... III-7-36
 VFR Landing Pattern Entry. III-7-36
 VHF/UHF COMMUNICATION SYSTEM VII-23-2
 VHF/UHF Communication System - DCS..... VII-23-27
 VHF/UHF Controls and Indicators..... VII-23-3
 Visual Warnings. I-2-137
 Voice Alert System..... I-2-130
 Voice Warnings. I-2-136
 VTR Selector Switches..... I-2-173
 VTR2 Override Function..... I-2-178

W

WAIVERS..... II-5-4
 Warm Air Subsystems. I-2-97
 WARN TONE SIL Button..... I-2-49
 WARN/CAUT Lights Knob..... I-2-42
 Warnings, Cautions, and Advisories. V-12-1
 Warnings/Cautions/Advisories..... I-2-129

	Page No.
Waveoff.....	III-8-14, III-9-19
Waypoint, OAP, Mark Point Selection.	VII-24-7
Waypoint/OAP Course Line Steering.....	VII-24-41
Waypoint/OAP Direct Great Circle Steering.....	VII-24-39
Waypoint/OAP Sequence Programming.....	VII-24-29
Waypoint/Offset Aimpoint Programming.....	VII-24-26
Waypoints, Offset Aimpoints (OAP), and Offsets.....	VII-24-26
WEAPON SYSTEMS CONTROLS	I-2-87
Weapon Systems Operator (WSO).	IX-28-3
Weather Conditions.....	III-9-18
Wet Runway Landings.....	III-7-43
Wheel Brake Assembly.....	I-2-51
Wheel Brake Operation.	I-2-51
Wheel Brake System.....	I-2-50
Windshield Anti-ice and Rain Removal.	I-2-104
Windshield Defog Outlets.....	I-2-102
WINDSHIELD Switch.....	I-2-104
WING FOLD SYSTEM	I-2-59
Wing Tank Balancing.....	I-2-14
Wing-Down-Top-Rudder Technique.....	III-7-43
Wingfold Mechanism.....	I-2-59
Wingfold Operation.	I-2-59
Wingfold Overheat Cutout Protection.....	I-2-60
WINGFOLD Switch.	I-2-60
WPDSG (Navigation) Designation.	VII-24-47
WPDSG, O/S Option (HSI Format).....	VII-24-7
WYPT, OAP Option (HSI Format).	VII-24-7

Y

Yaw CAS.	I-2-66
Yaw Rate Warning Tone.....	I-2-76

Z

ZEROIZE Function.	VII-23-29
Zulu Time of Day (ZTOD).	VII-24-36

LIST OF EFFECTIVE PAGES

Effective Pages	Page Numbers	Effective Pages	Page Numbers
ORIGINAL	1 (Reverse Blank)	ORIGINAL	V-17-1 Thru V-17-24
ORIGINAL	3 (Reverse Blank)	ORIGINAL	V-18-1 Thru V-18-4
ORIGINAL	5 Thru 33 (Reverse Blank)	ORIGINAL	69 (Reverse Blank)
ORIGINAL	35 (Reverse Blank)	ORIGINAL	VI-19-1 Thru VI-19-2
ORIGINAL	37 (Reverse Blank)	ORIGINAL	VI-20-1 Thru VI-20-4
CHANGE 3	39	ORIGINAL	VI-21-1 Thru VI-21-2
CHANGE 5	40	ORIGINAL	VI-22-1 Thru VI-22-2
ORIGINAL	41 Thru 50	ORIGINAL	71 (Reverse Blank)
ORIGINAL	51 Thru 56	ORIGINAL	VII-23-1 Thru VII-23-48
ORIGINAL	58 (Obverse Blank)	ORIGINAL	VII-24-1 Thru VII-24-78
ORIGINAL	59 (Reverse Blank)	ORIGINAL	VII-25-1 Thru VII-25-6
ORIGINAL	I-1-1 Thru I-1-5 (Reverse Blank)	ORIGINAL	VII-26-1 Thru VII-26-9 (Reverse Blank)
ORIGINAL	I-2-1 Thru I-2-221 (Reverse Blank)	ORIGINAL	VII-27-1 Thru VII-27-5 (Reverse Blank)
ORIGINAL	I-3-1 (Reverse Blank)	ORIGINAL	73 (Reverse Blank)
ORIGINAL	I-4-1 Thru I-4-19 (Reverse Blank)	ORIGINAL	75 (Reverse Blank)
ORIGINAL	61 (Reverse Blank)	ORIGINAL	IX-28-1 Thru IX-28-4
ORIGINAL	II-5-1 Thru II-5-4	ORIGINAL	IX-29-1 Thru IX-29-10
ORIGINAL	63 (Reverse Blank)	ORIGINAL	77 (Reverse Blank)
ORIGINAL	III-6-1 Thru III-6-4	ORIGINAL	X-30-1 Thru X-30-18
ORIGINAL	III-7-1 Thru III-7-48	ORIGINAL	79 (Reverse Blank)
ORIGINAL	III-8-1 Thru III-8-23 (Reverse Blank)	ORIGINAL	A-1 Thru A-2
ORIGINAL	III-9-1 Thru III-9-23 (Reverse Blank)	ORIGINAL	B-1 Thru B-12
ORIGINAL	III-10-1 Thru III-10-35 (Reverse Blank)	ORIGINAL	FO-1 (Reverse Blank)
ORIGINAL	65 (Reverse Blank)	ORIGINAL	FO-3 (Reverse Blank)
ORIGINAL	IV-11-1 Thru IV-11-18	ORIGINAL	FO-5 (Reverse Blank)
ORIGINAL	67 (Reverse Blank)	ORIGINAL	FO-7 (Reverse Blank)
ORIGINAL	Em-Index-1 Thru Em-Index-3 (Reverse Blank)	ORIGINAL	FO-9 (Reverse Blank)
ORIGINAL	V-12-1 Thru V-12-74	ORIGINAL	FO-11 (Reverse Blank)
ORIGINAL	V-13-1 Thru V-13-5 (Reverse Blank)	ORIGINAL	FO-13 (Reverse Blank)
ORIGINAL	V-14-1 Thru V-14-6	ORIGINAL	FO-15 (Reverse Blank)
ORIGINAL	V-15-1 Thru V-15-49 (Reverse Blank)	ORIGINAL	FO-17 (Reverse Blank)
ORIGINAL	V-16-1 Thru V-16-18	ORIGINAL	FO-19 (Reverse Blank)
		ORIGINAL	FO-21 (Reverse Blank)
		ORIGINAL	FO-23 (Reverse Blank)
		ORIGINAL	FO-25 (Reverse Blank)
		ORIGINAL	FO-27 (Reverse Blank)
		ORIGINAL	FO-29 (Reverse Blank)
		ORIGINAL	Index-1 Thru Index-28
		ORIGINAL	LEP-1 (Reverse Blank)

